

Cal

MUSEU TÈXTIL CONSORCI DEL CENTRE DE DOCUMENTACIÓ I BIBLIOTECA

# FABRICACION DE TEJIDOS



Devanar y poner en rastrillo.

Lam. 1.

Fig. 1.<sup>a</sup>

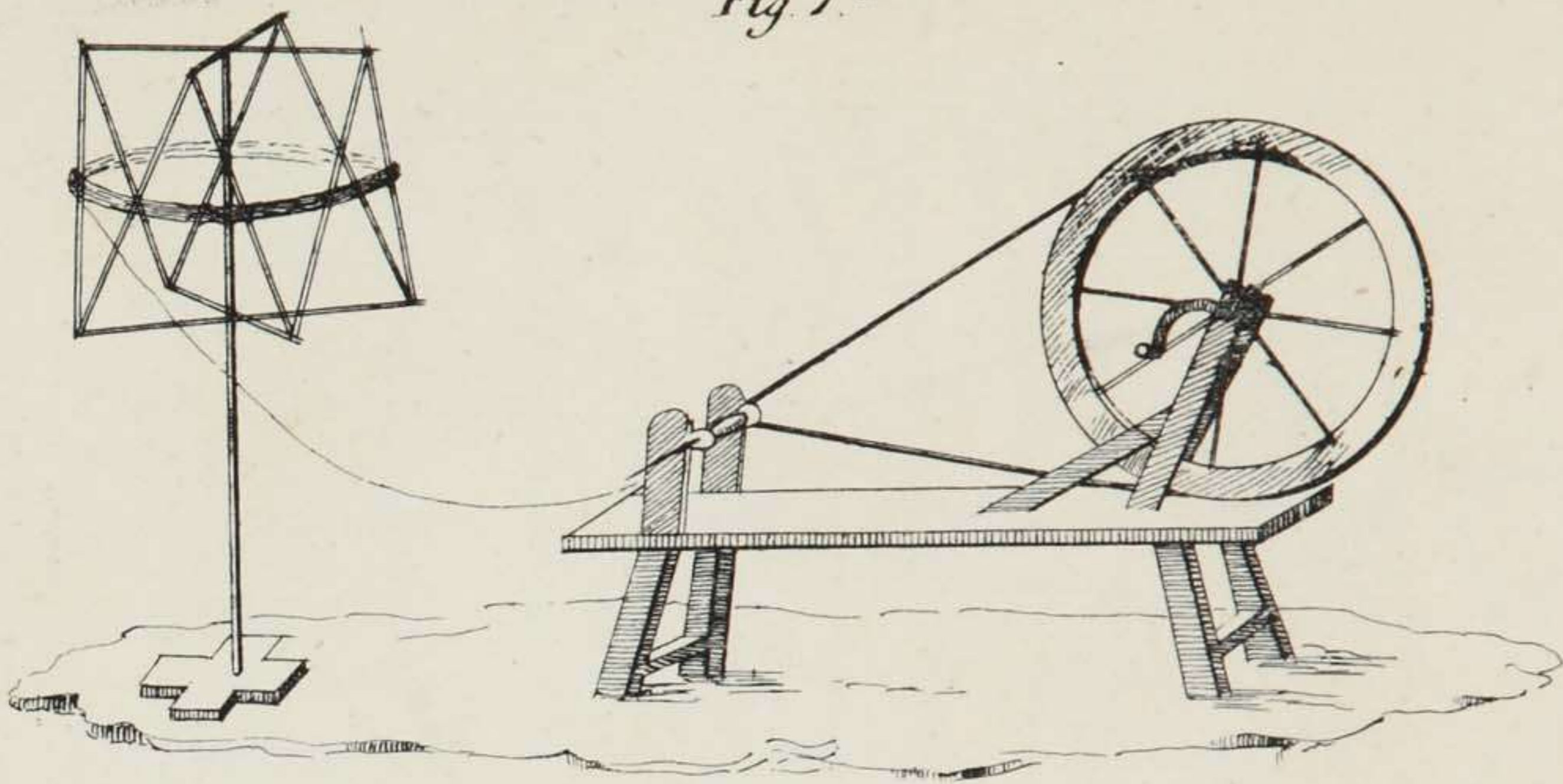
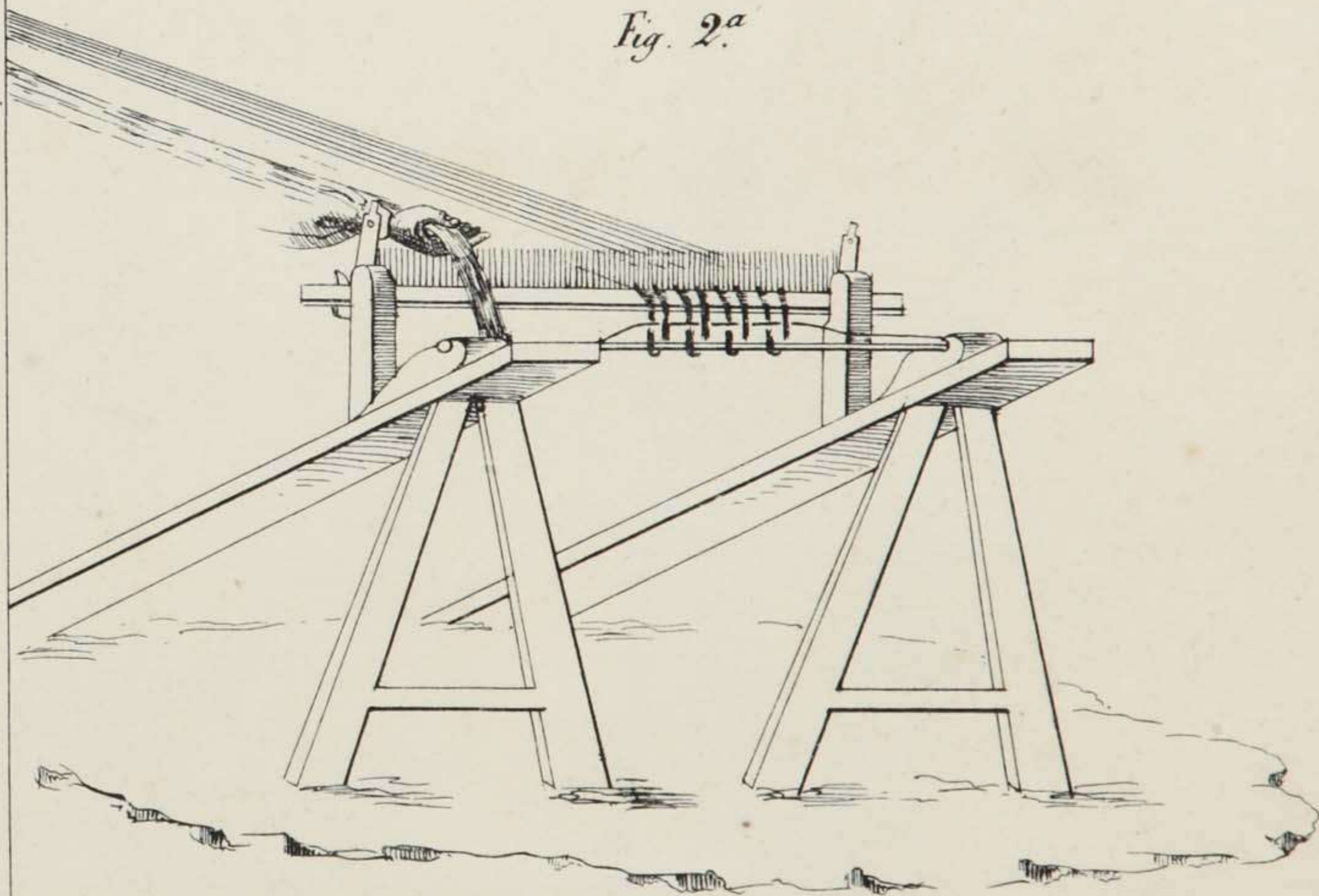


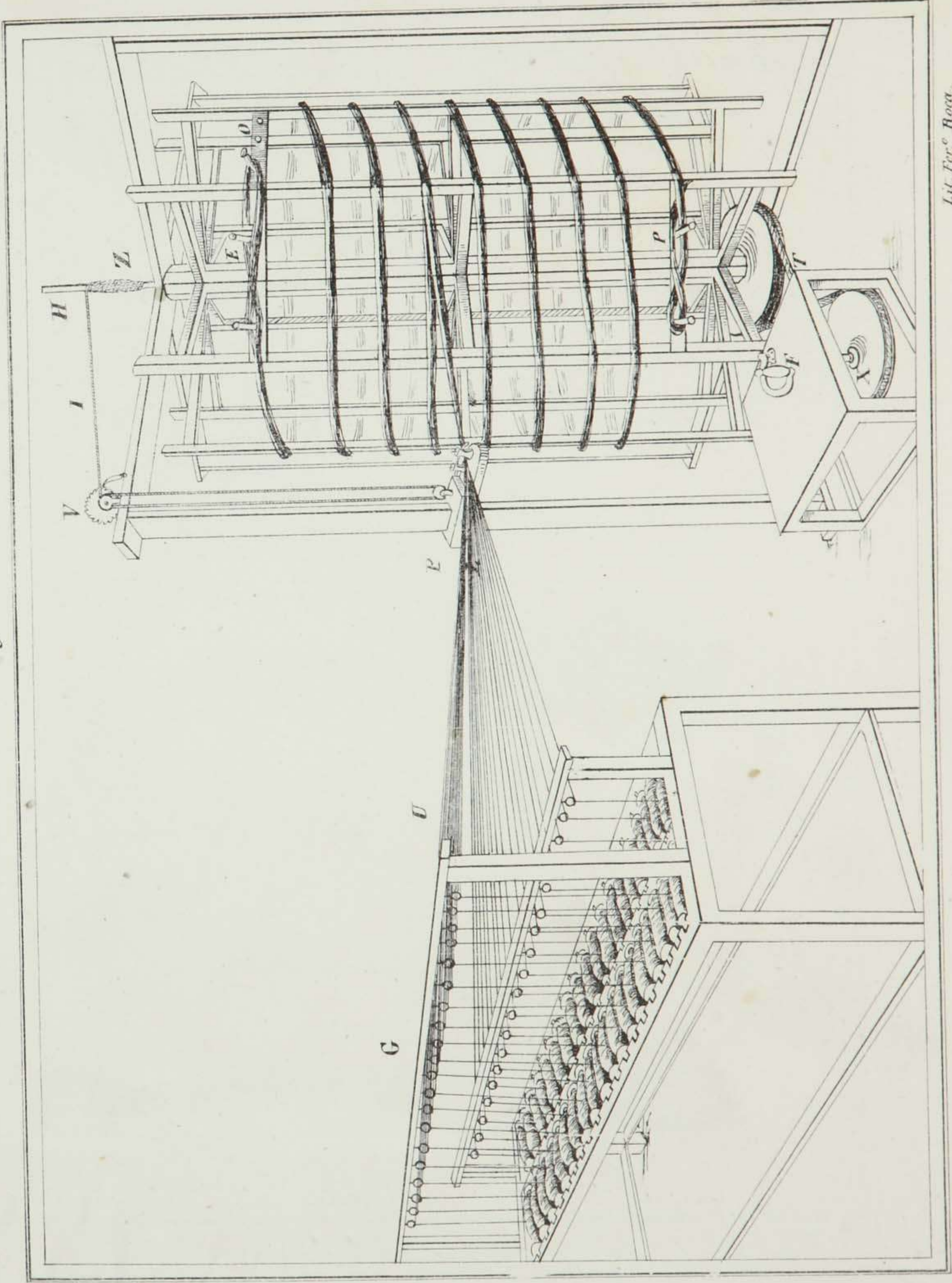
Fig. 2.<sup>a</sup>



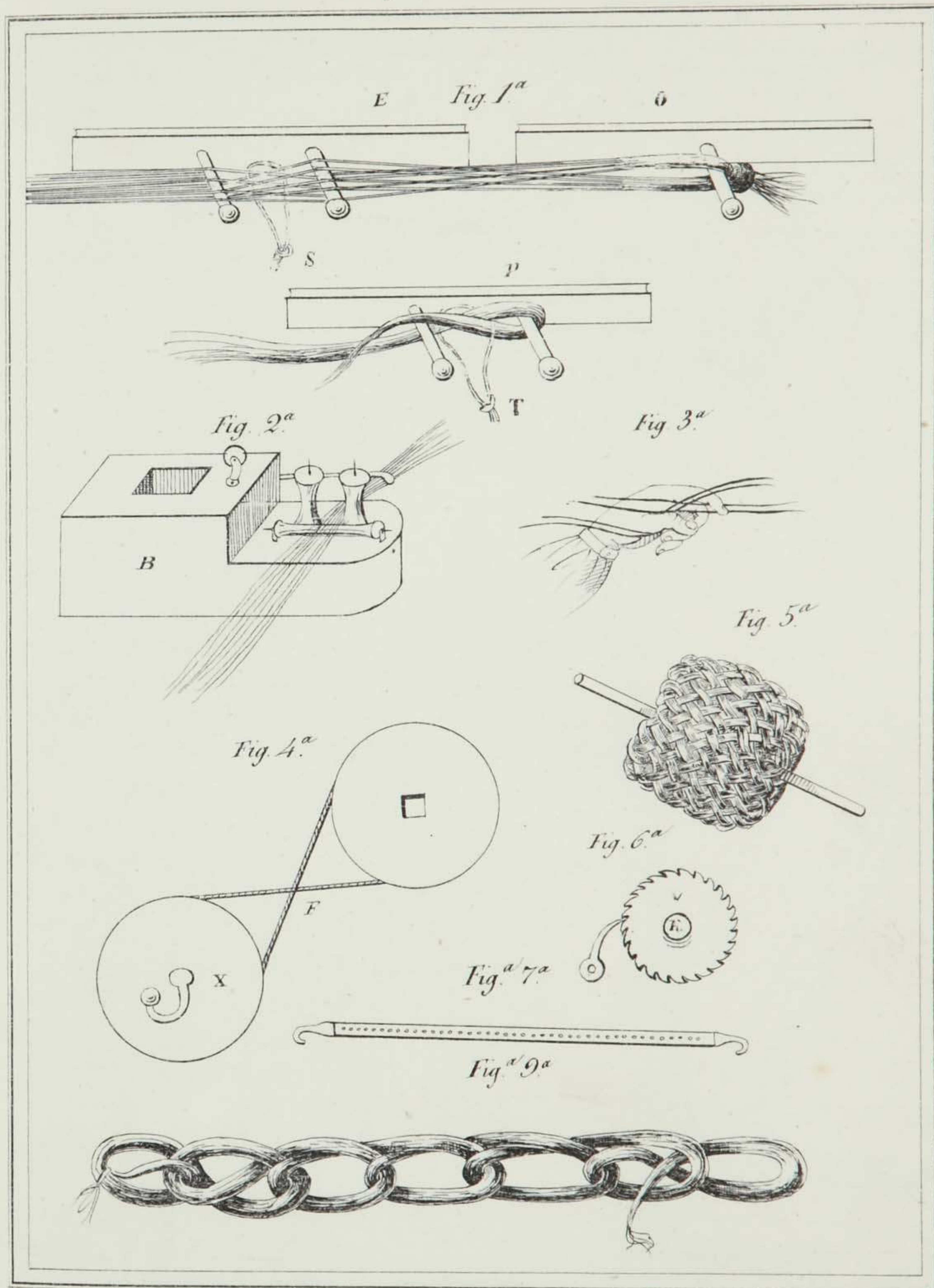
Lit. Fer.<sup>o</sup> Rocca.

Urdidera y trascalnadera.

Lam. II.

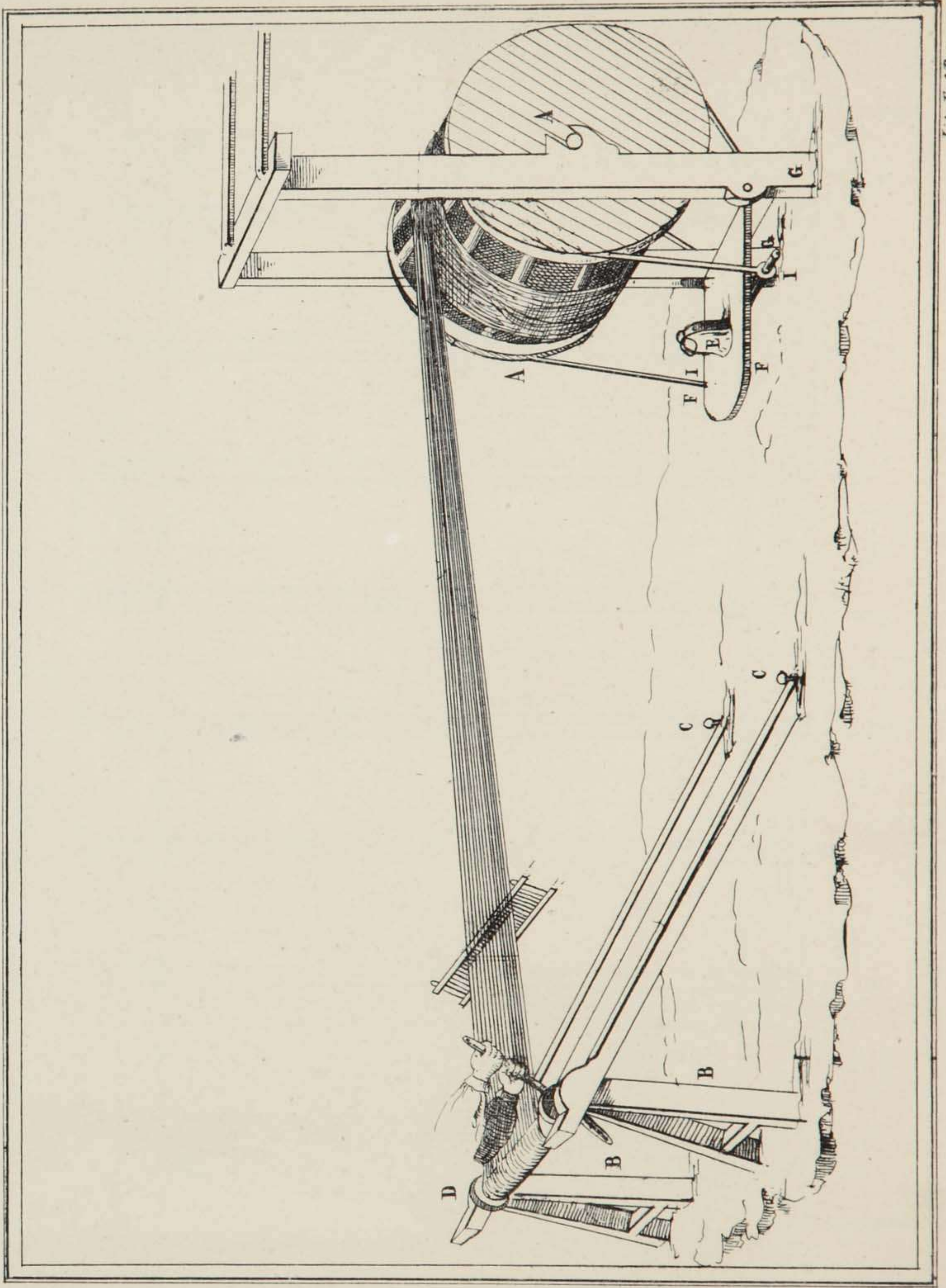


Lit. Fer<sup>e</sup> Roca.



Operacion de plegar las piezas.

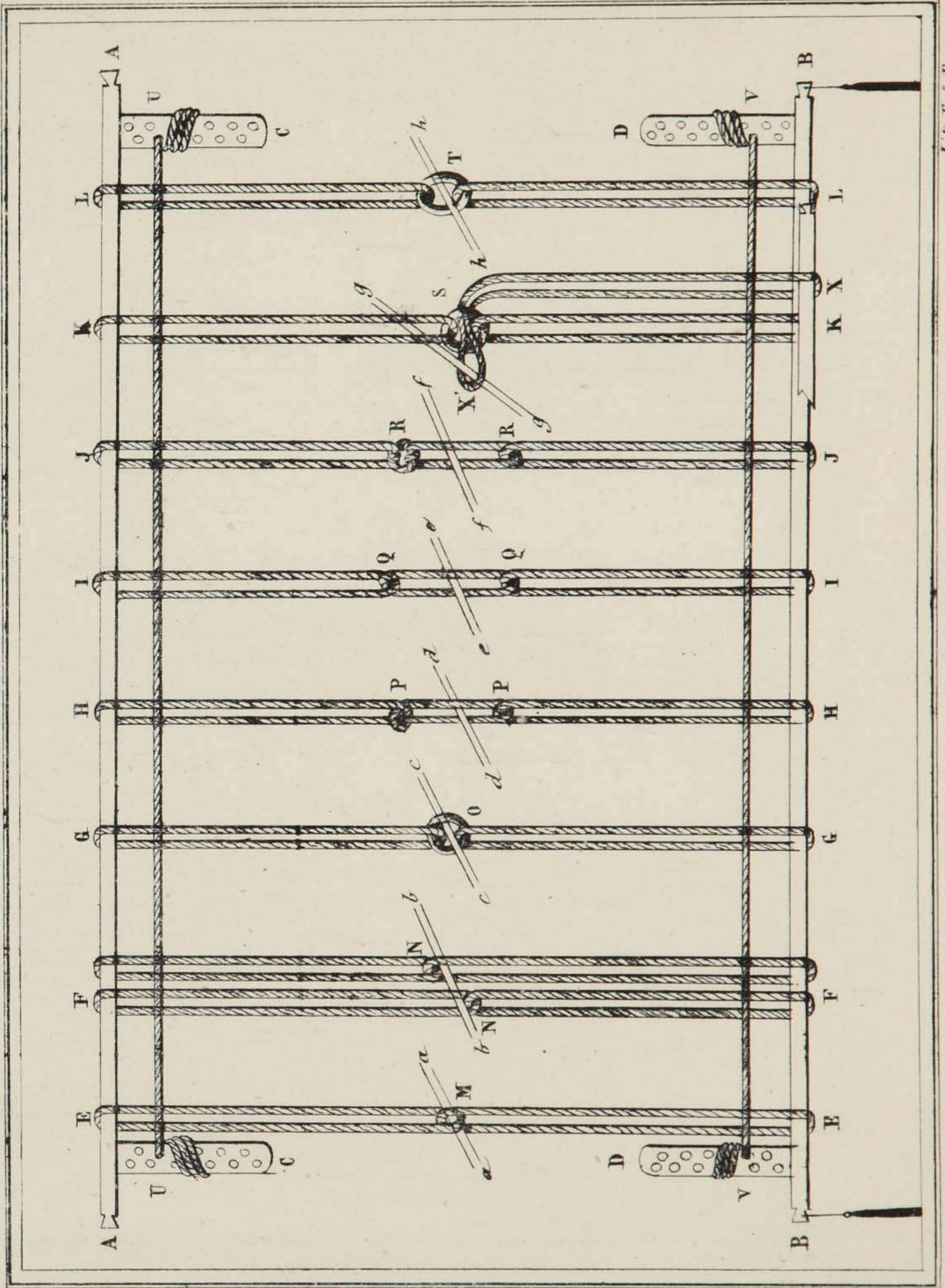
Lam. IV.



Litt. Fer. Roue.

Diferentes especies de mallas de los lizos.

Lam. V.



Lit. Fer. Recat.

Remetidos à remesa simple .

Lam. VI.

1 hilo

Fig 1<sup>a</sup>

2 3 4 5 6 7 8

Remesa

A

B

C

D

f<sup>o</sup> lizo

2

3

4

Curso 1<sup>o</sup> Curso 2<sup>o</sup>

Fig 2<sup>a</sup>

Curso 1<sup>o</sup> Curso 2<sup>o</sup>

Fig 3<sup>a</sup>

Curso 1<sup>o</sup> Curso 2<sup>o</sup>

Fig 4<sup>a</sup>

Curso 1<sup>o</sup> Curso 2<sup>o</sup>

Fig 5<sup>a</sup>

Curso 1<sup>o</sup> Curso 2<sup>o</sup>

Fig 6<sup>a</sup>

Curso 1<sup>o</sup> Curso 2<sup>o</sup>

Fig 7<sup>a</sup>

Curso 1<sup>o</sup> Curso 2<sup>o</sup>

Fig 8<sup>a</sup>

Curso 1<sup>o</sup> Curso 2<sup>o</sup>

Fig 9<sup>a</sup>

Curso unico

Fig 1<sup>a</sup>

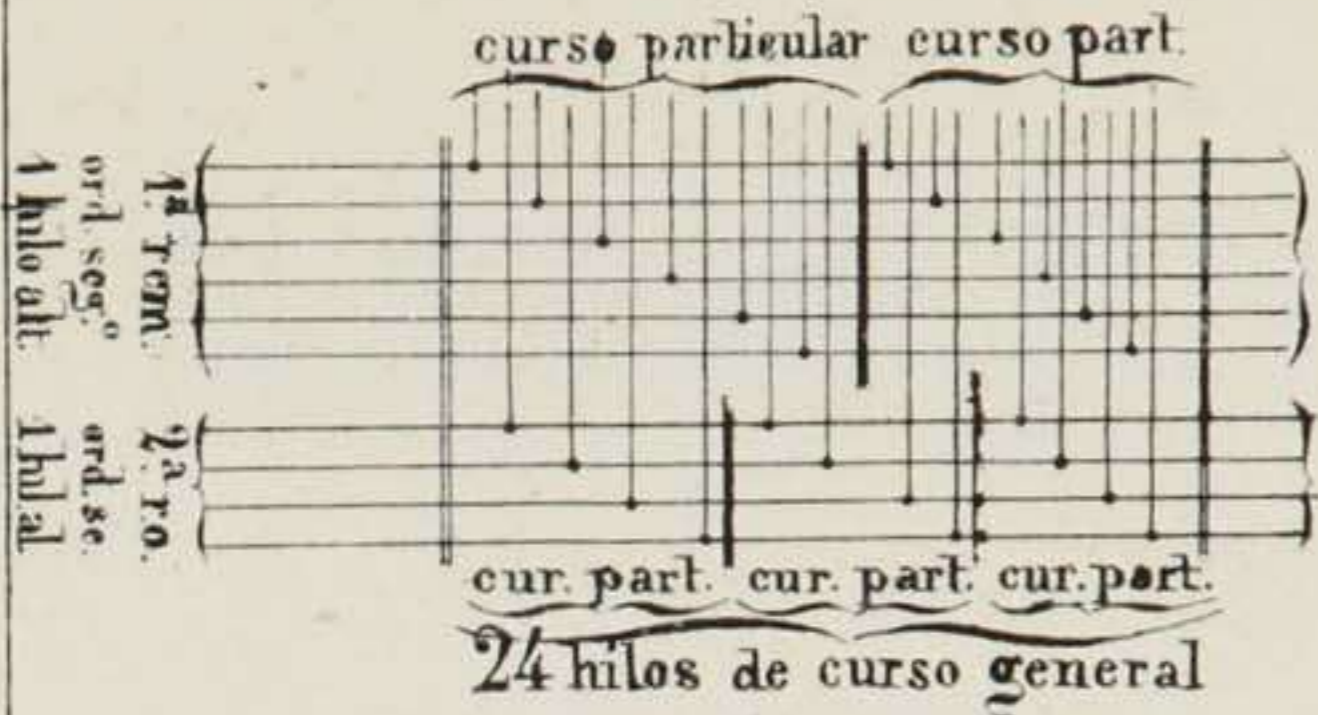


Fig 2<sup>a</sup>

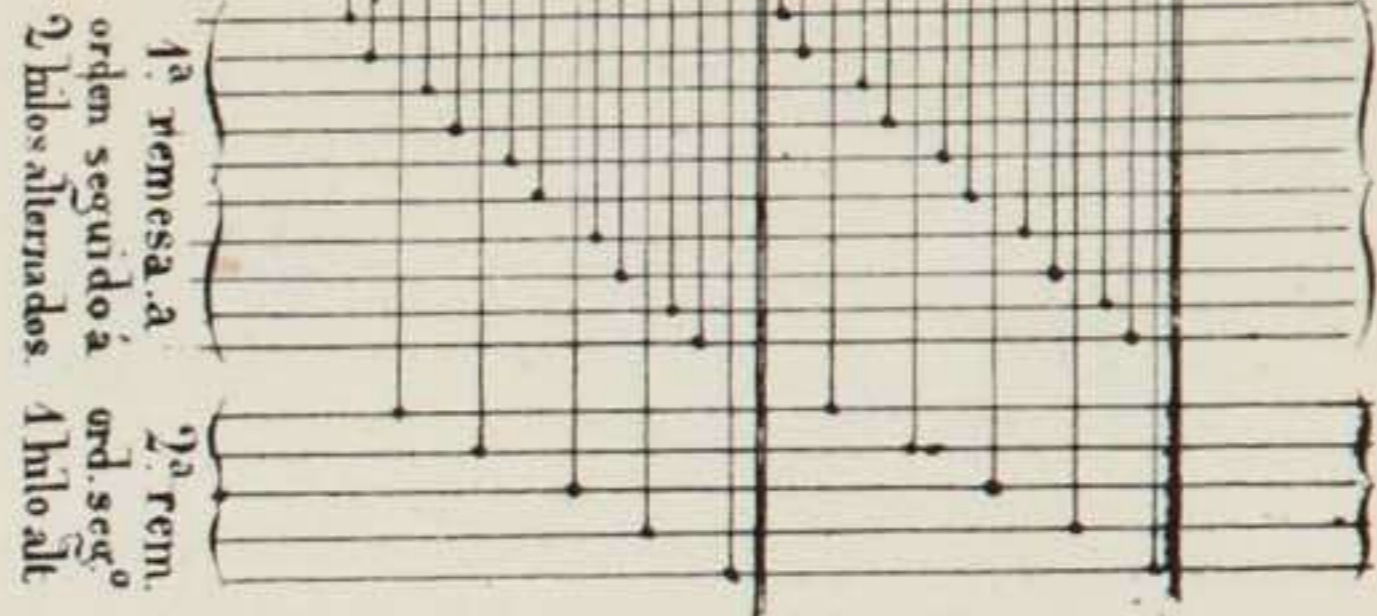


Fig 3<sup>a</sup>

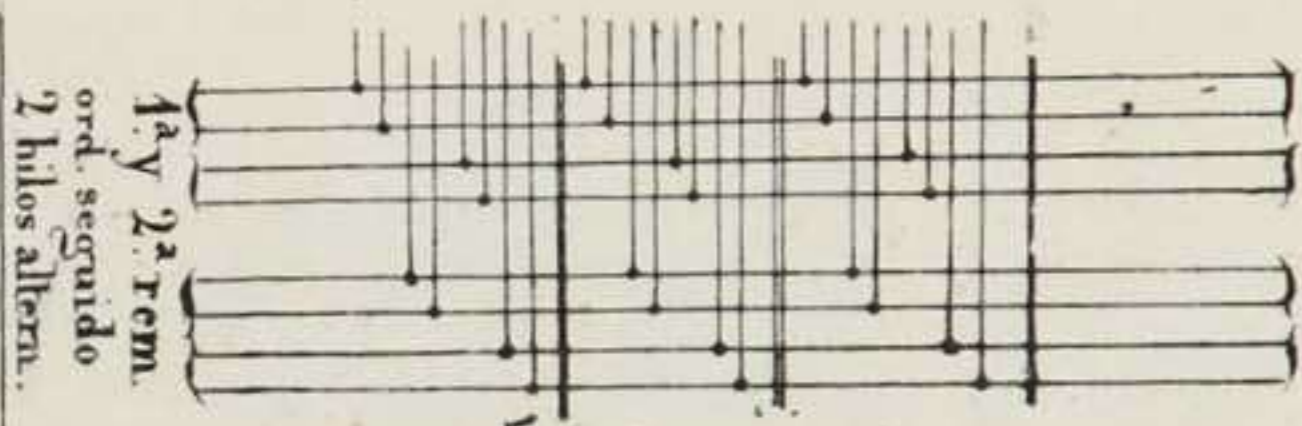


Fig 4<sup>a</sup>

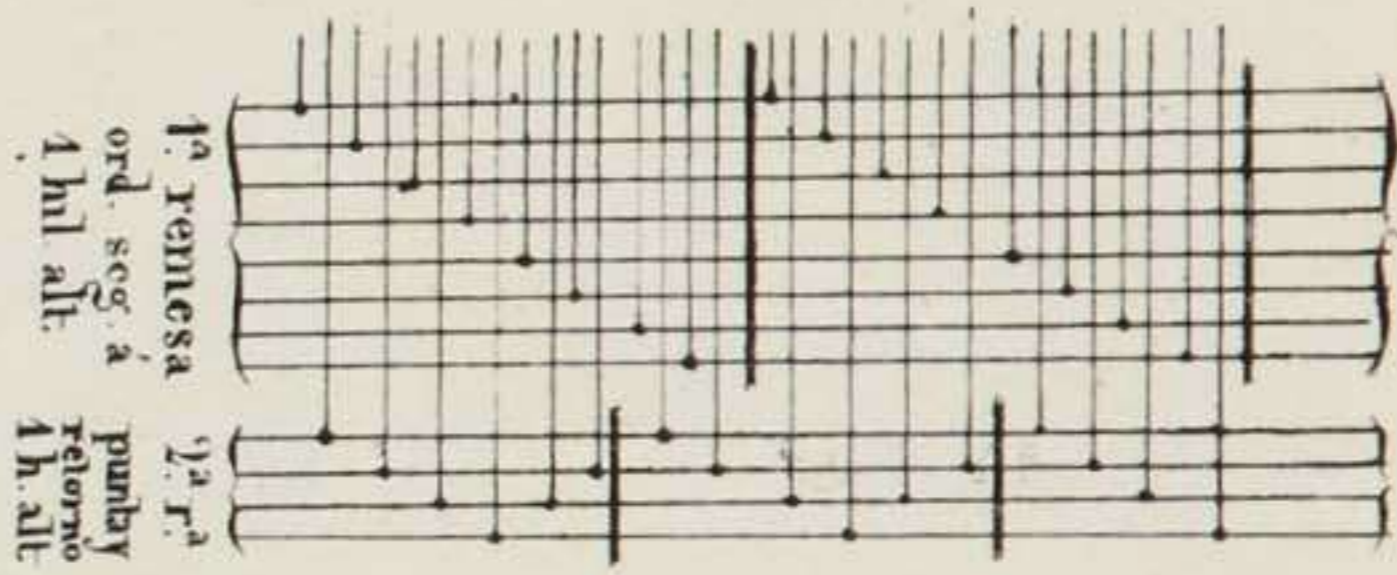


Fig 5<sup>a</sup>

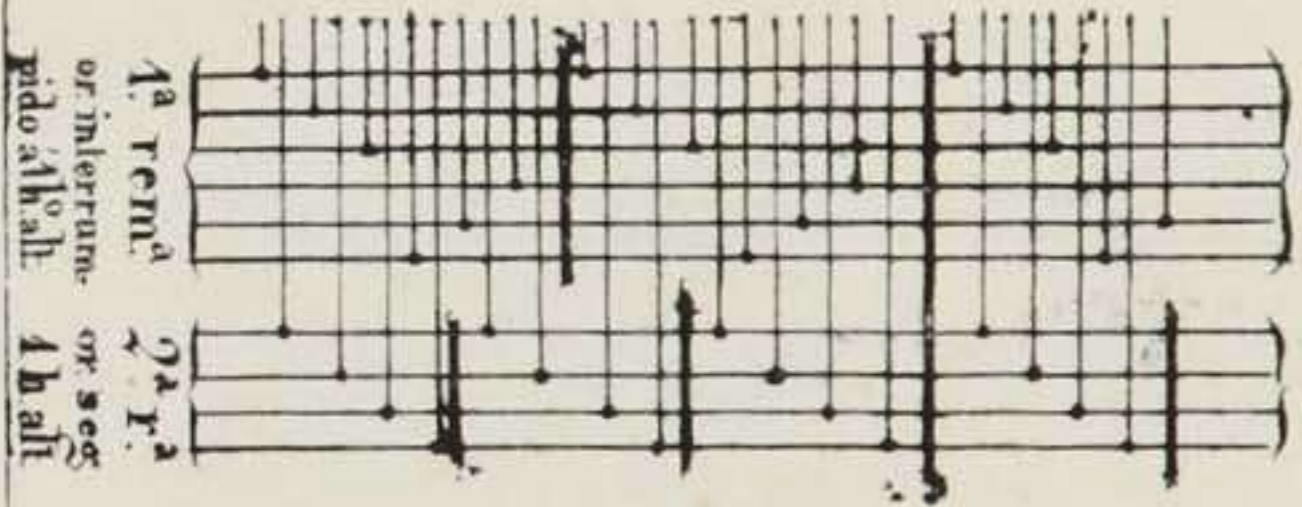


Fig 6<sup>a</sup>

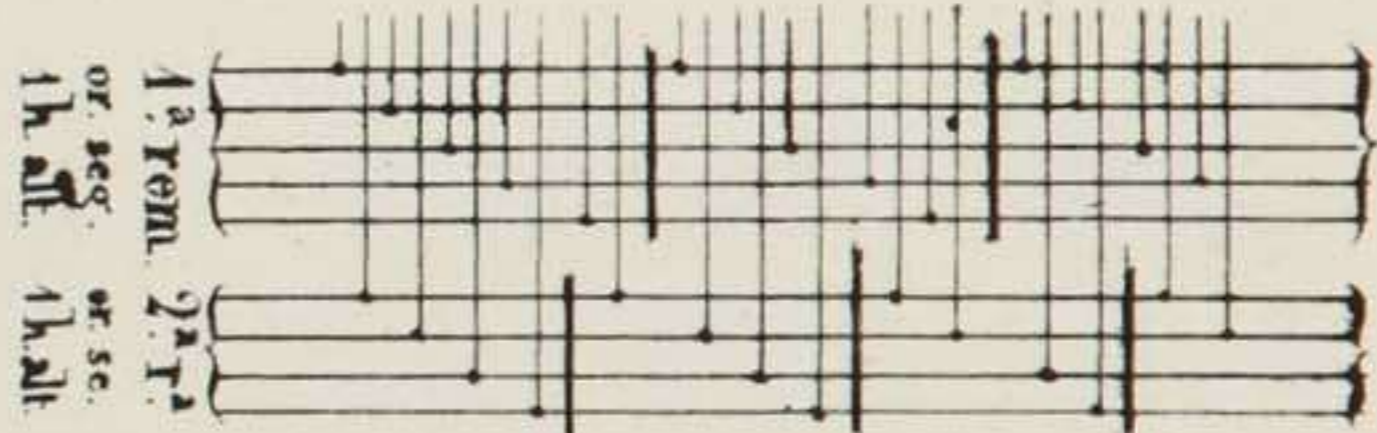


Fig 7<sup>a</sup>

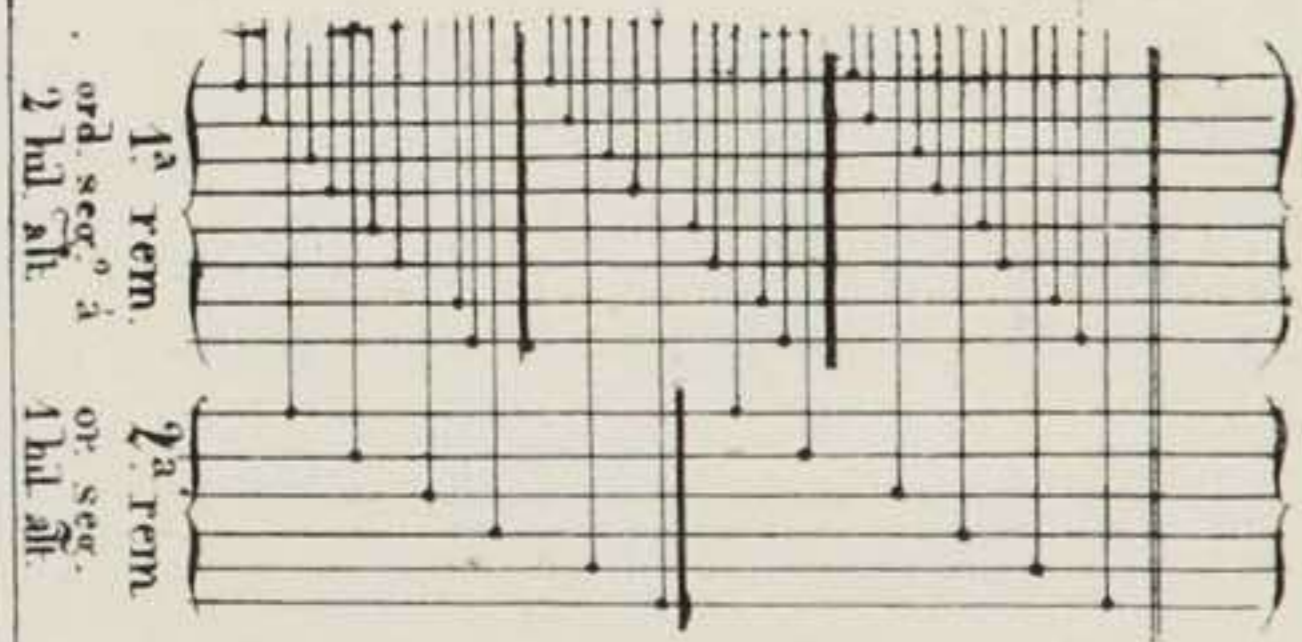


Fig 8<sup>a</sup>

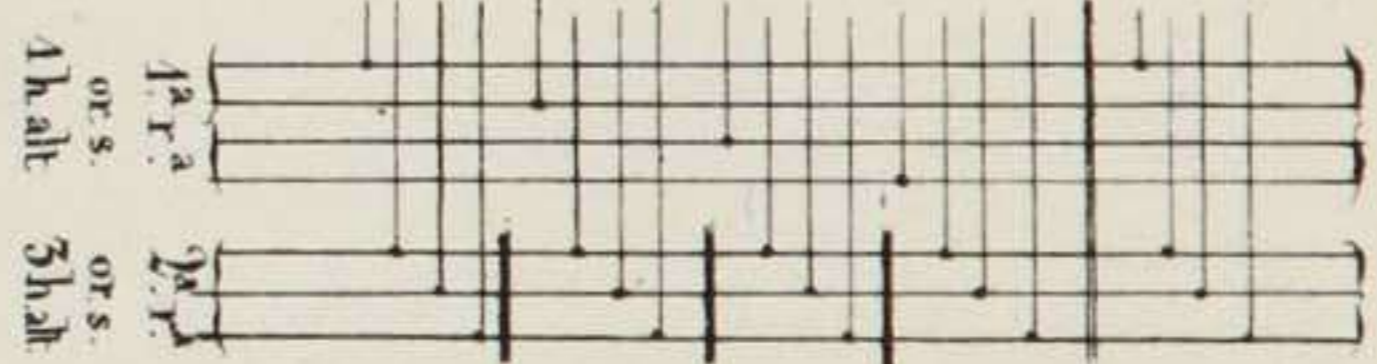


Fig 9<sup>a</sup>

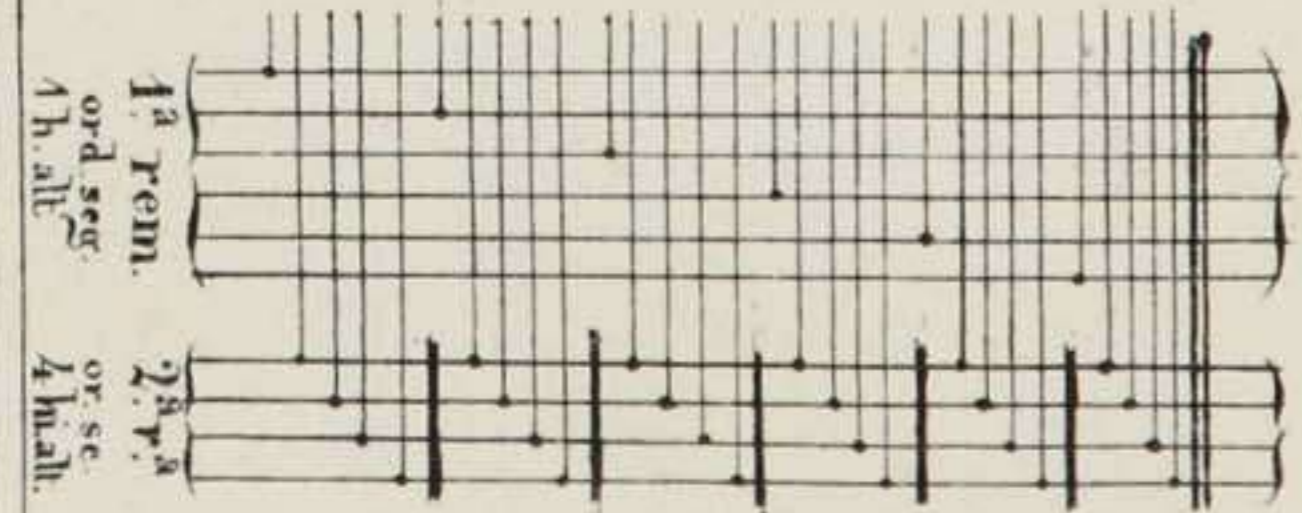
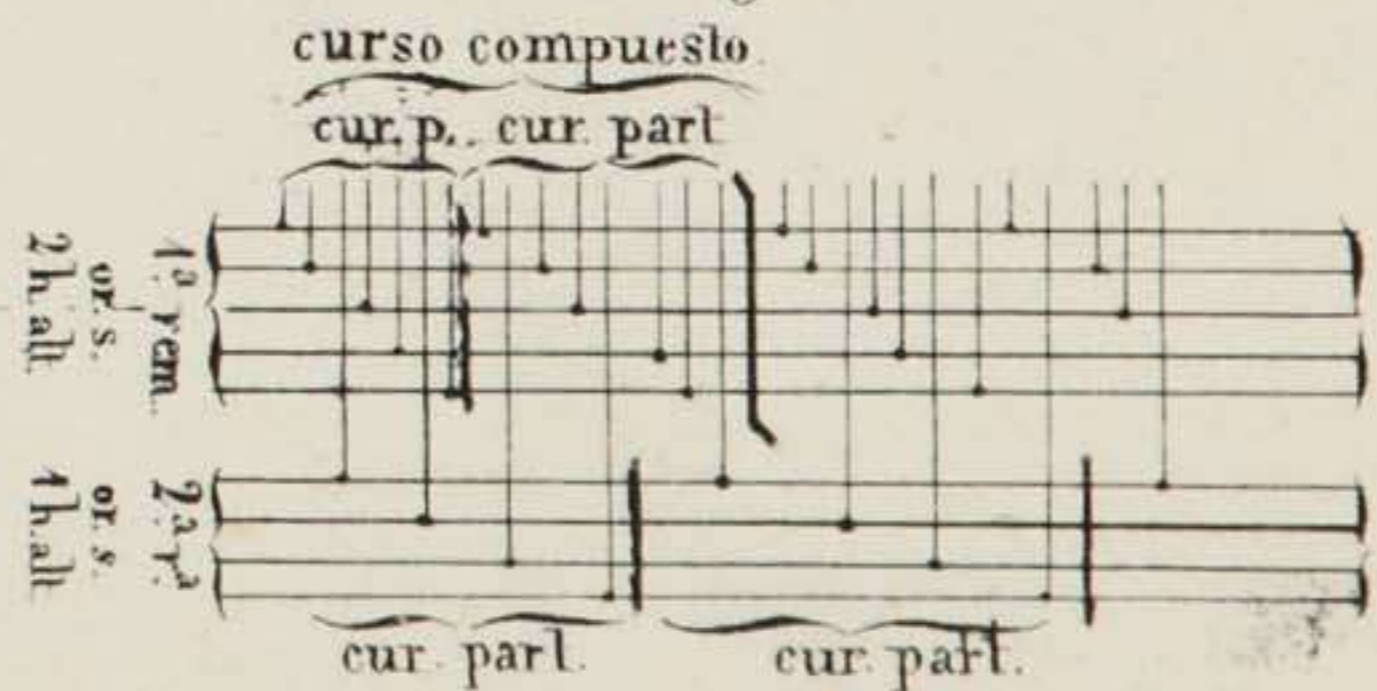


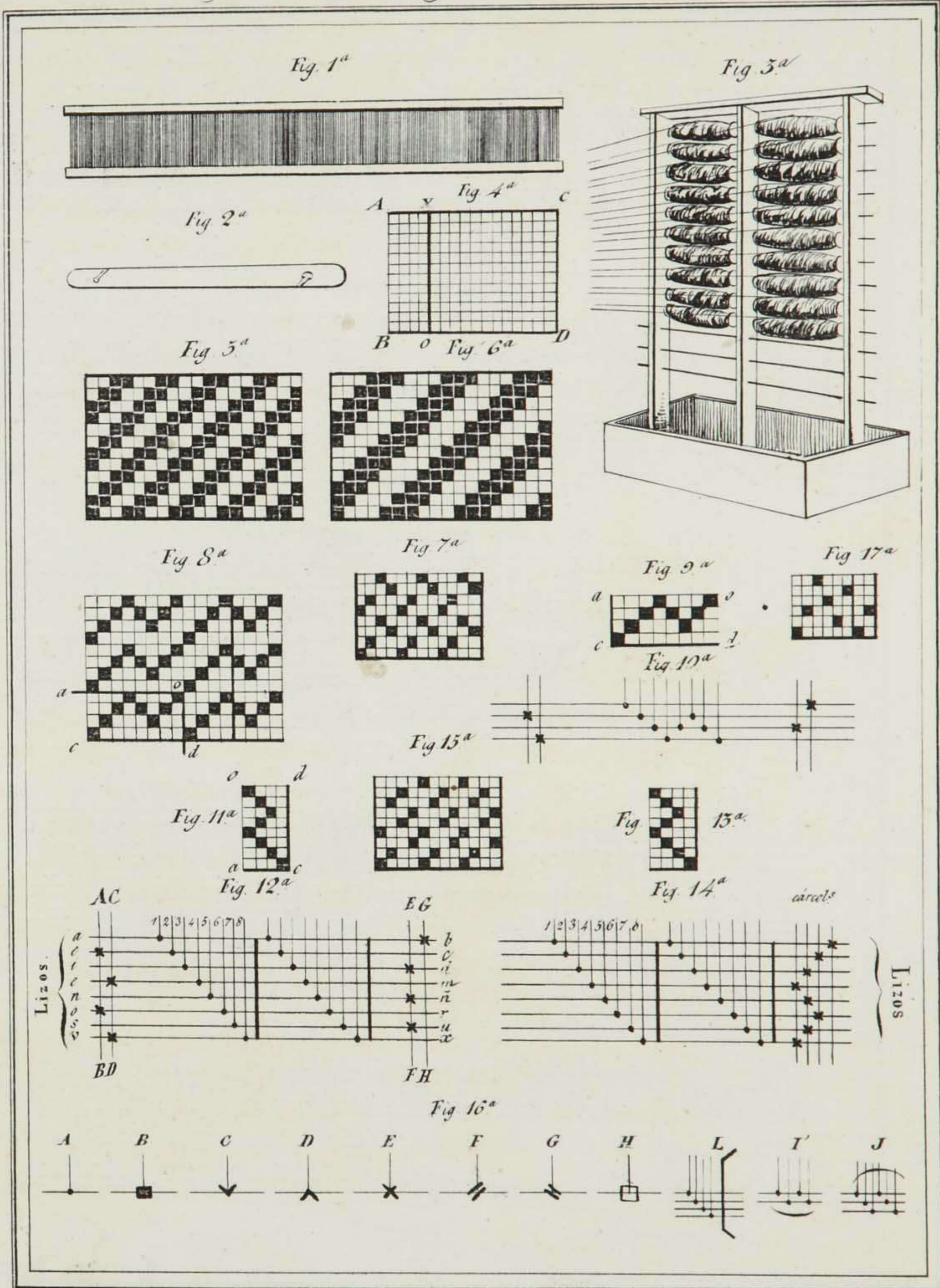
Fig 10<sup>a</sup>





# Utensilios, papel de cuadrícula, ligamientos y signos convencionales.

Lam VIII.



# Remetidos á dos y tres remesas.

Lam. IX.

Fig 1<sup>a</sup>

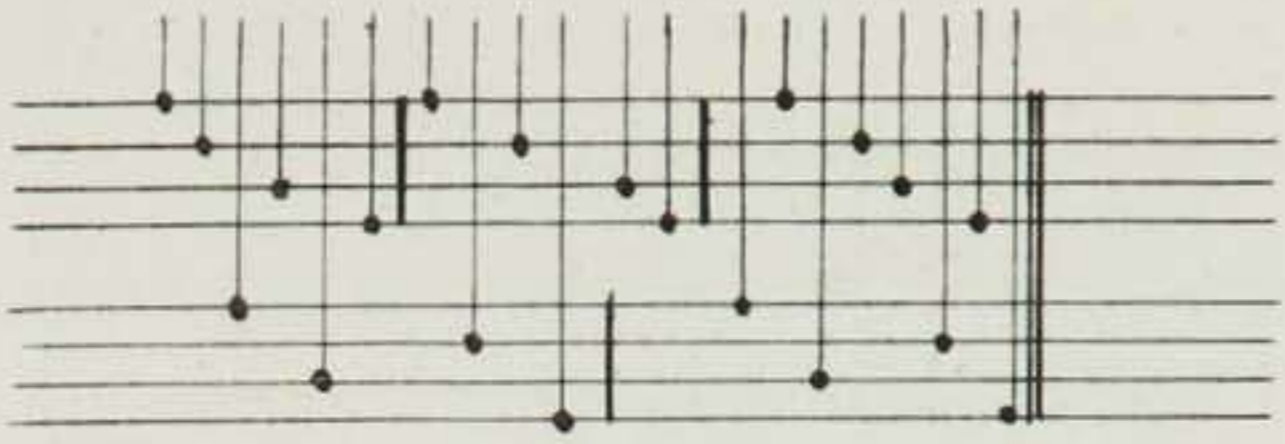


Fig 2<sup>a</sup>

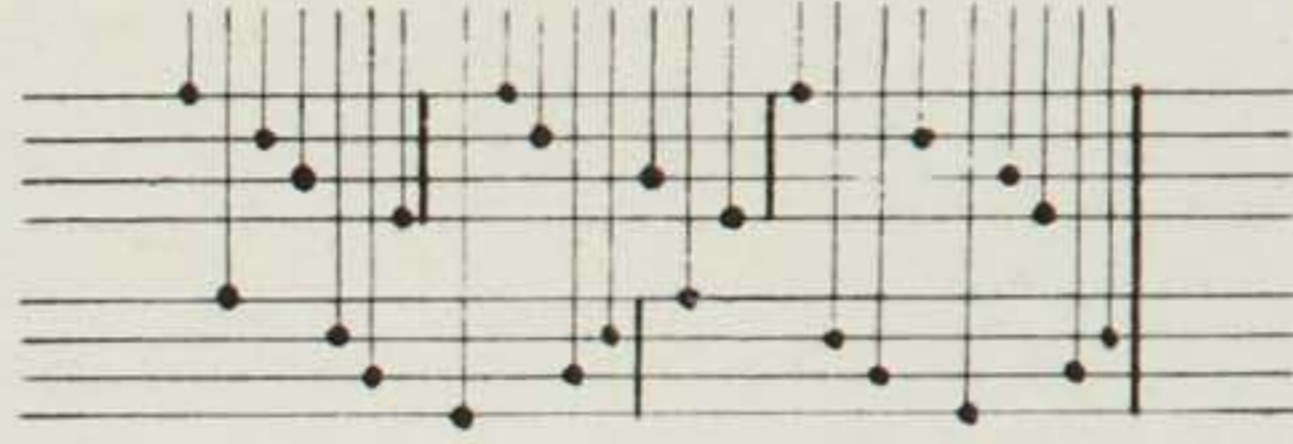


Fig 3<sup>a</sup>

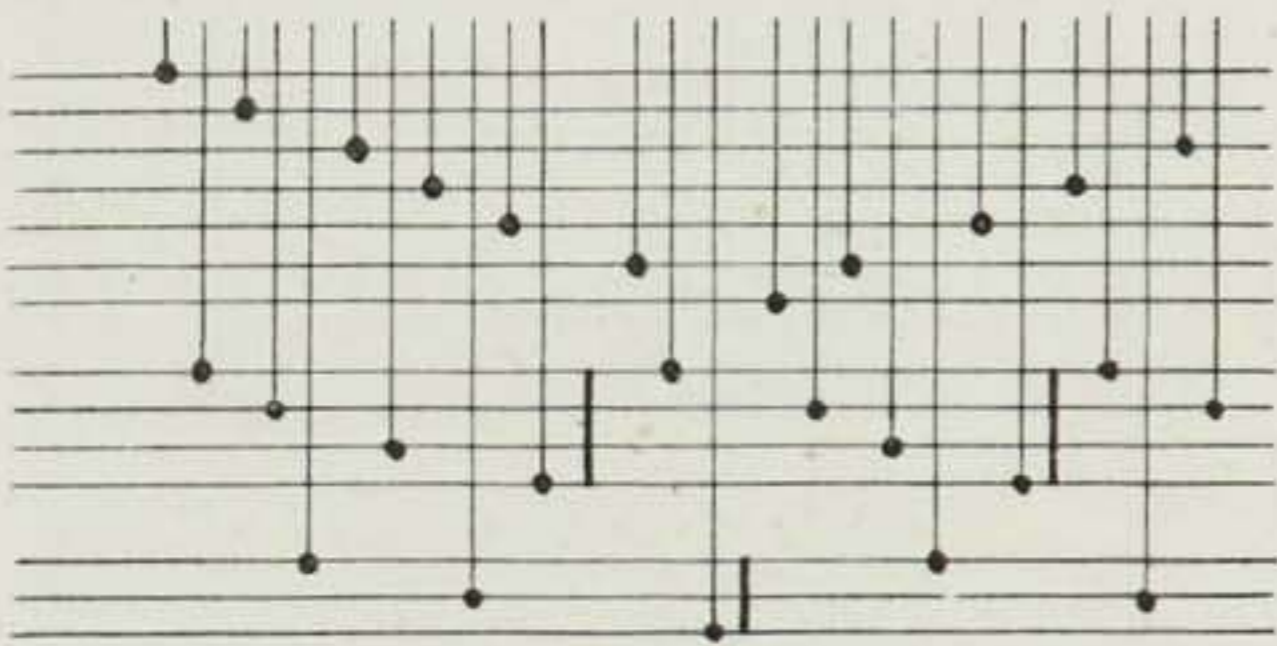


Fig 3<sup>a</sup>

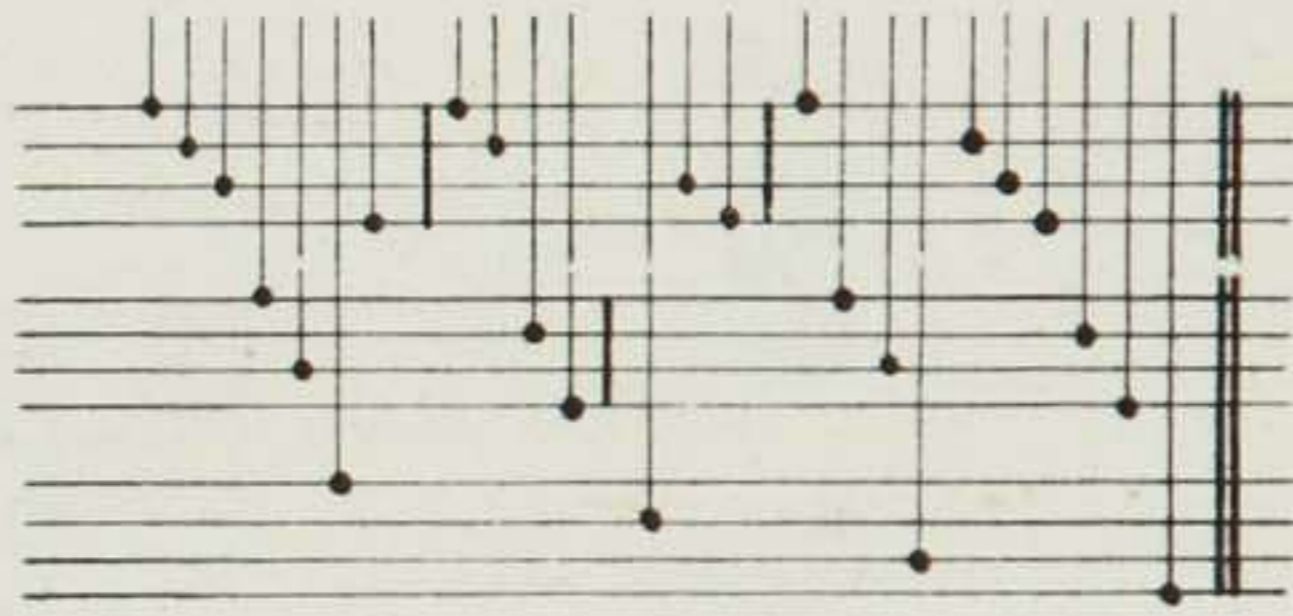
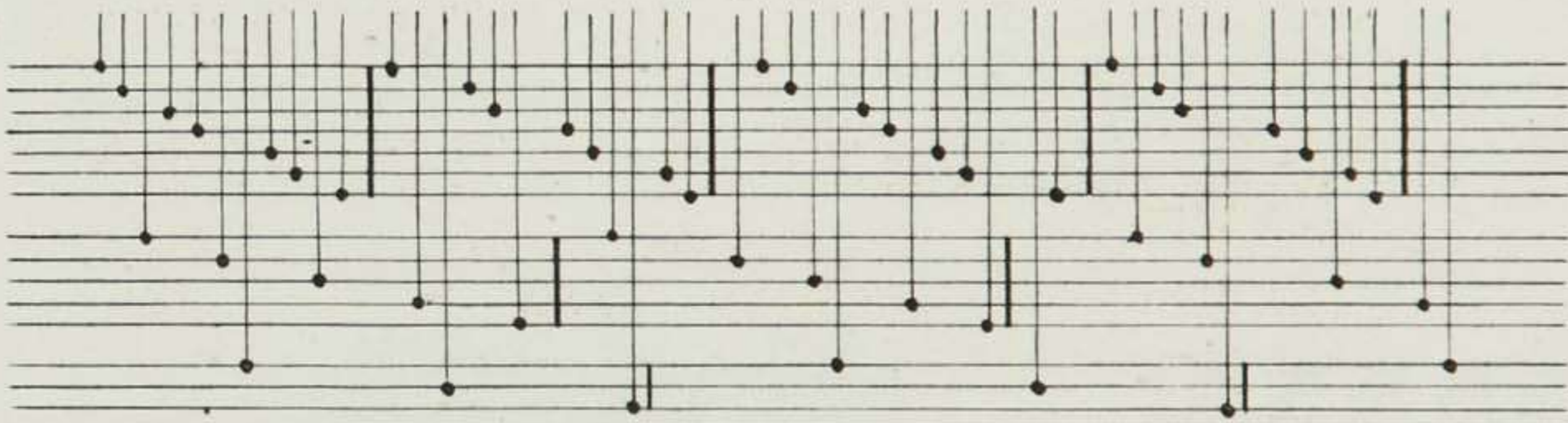
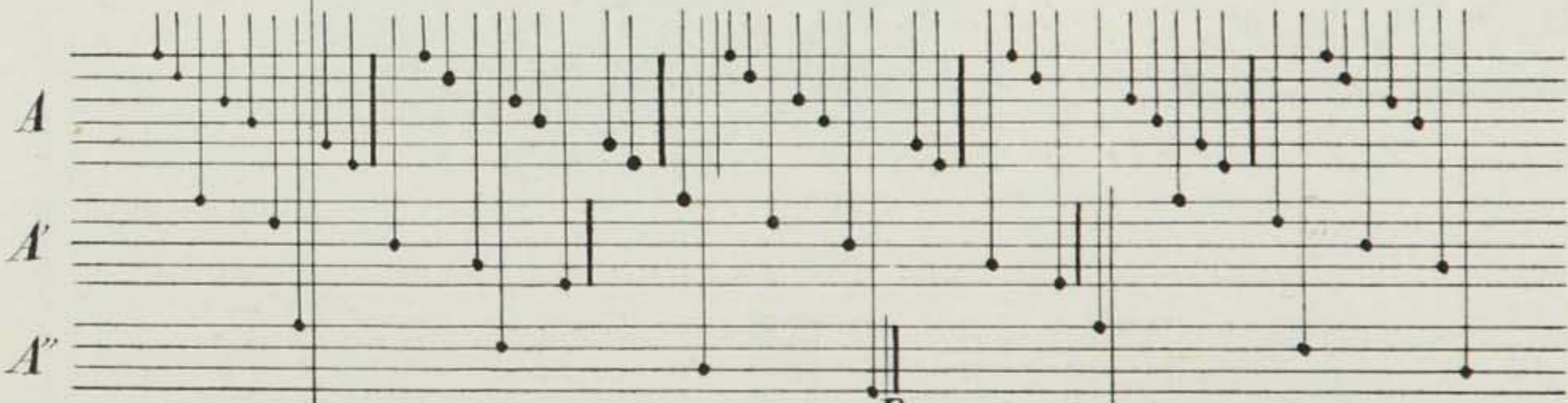


Fig 4<sup>a</sup>



E

B Fig 5<sup>a</sup>

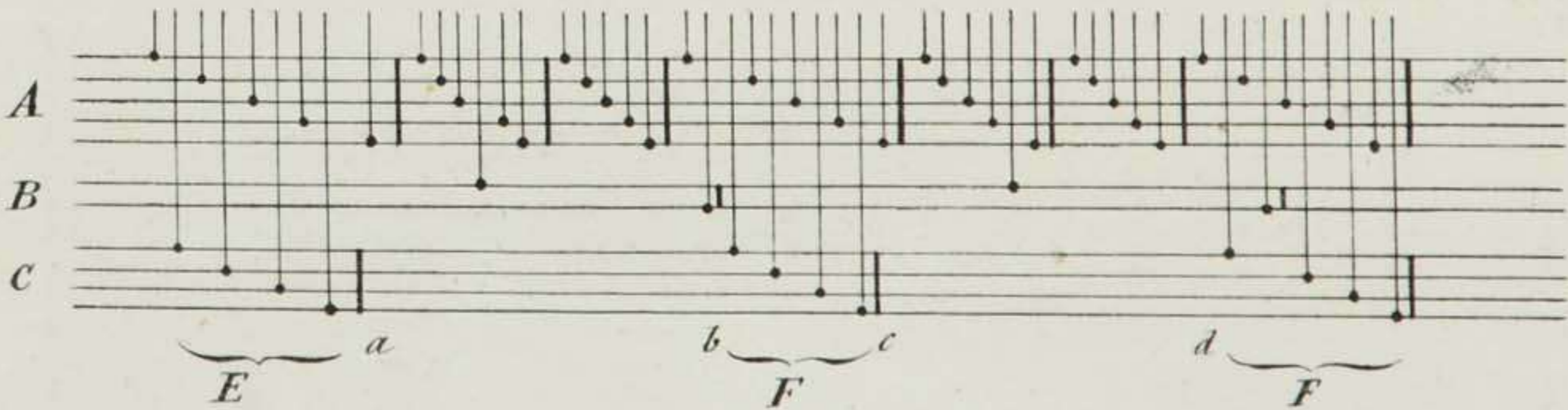


H

Fig 6<sup>a</sup>

D

C



E

a

b

F

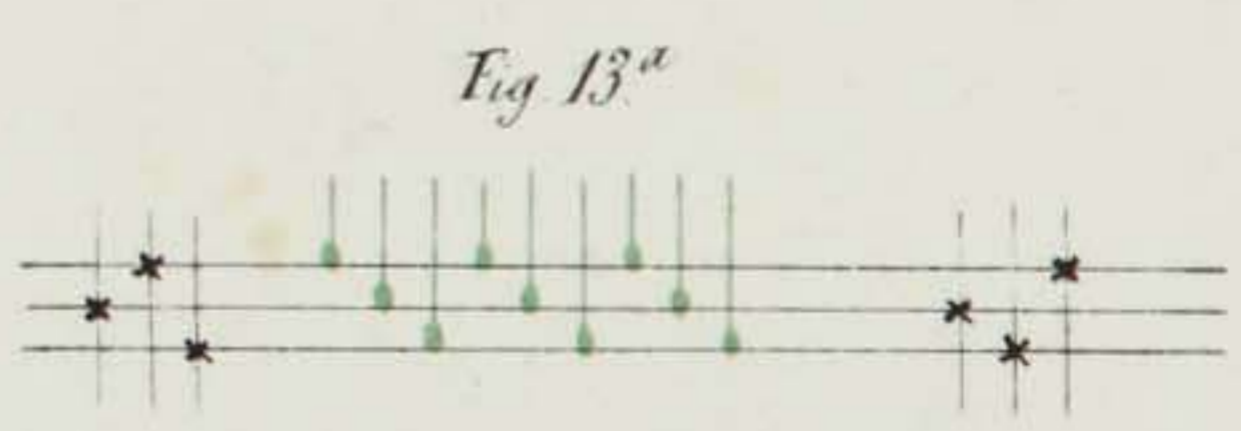
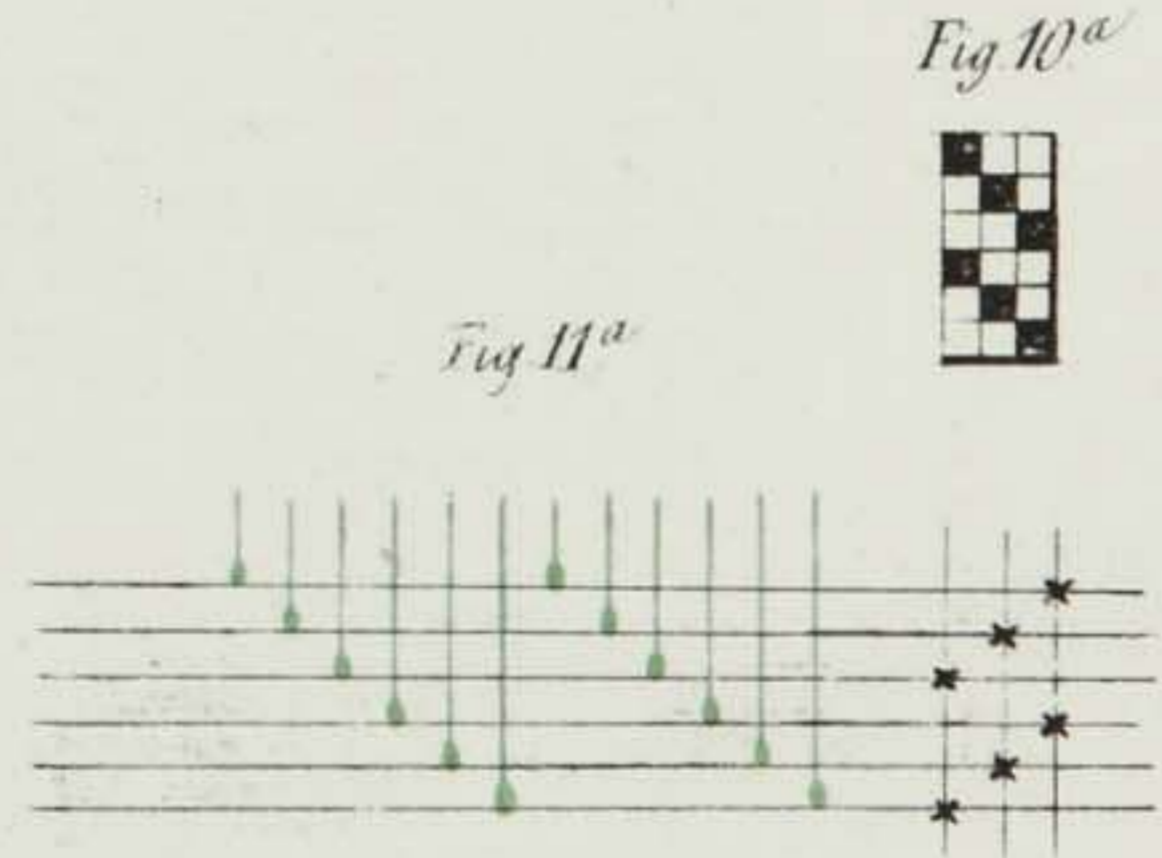
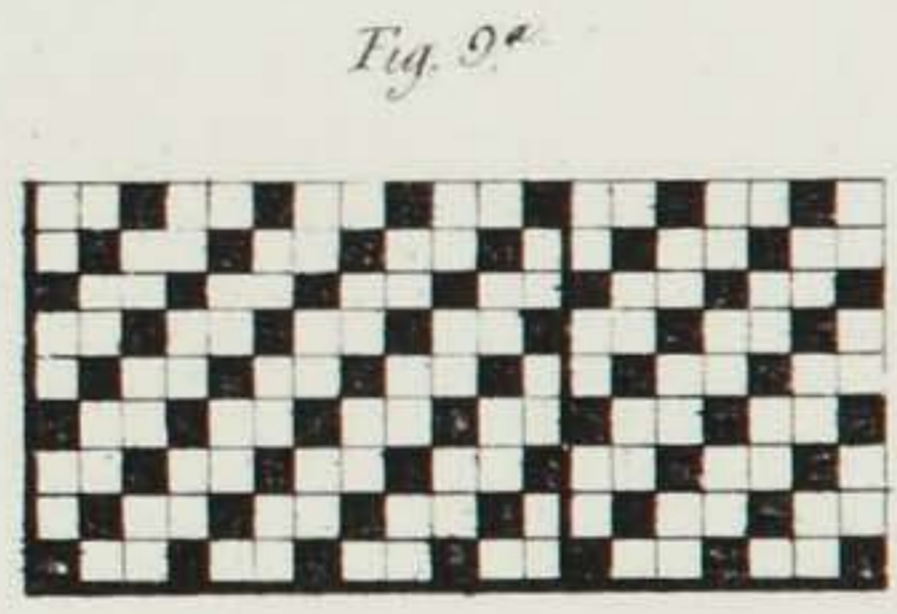
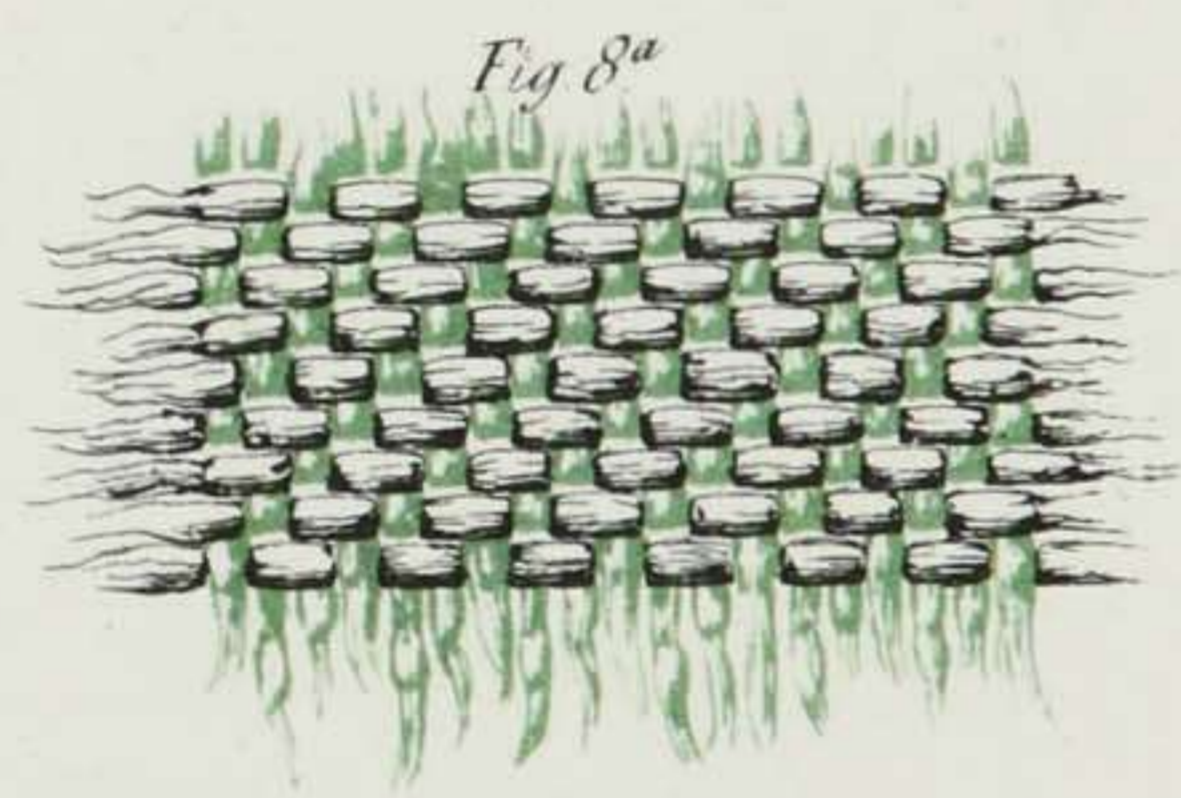
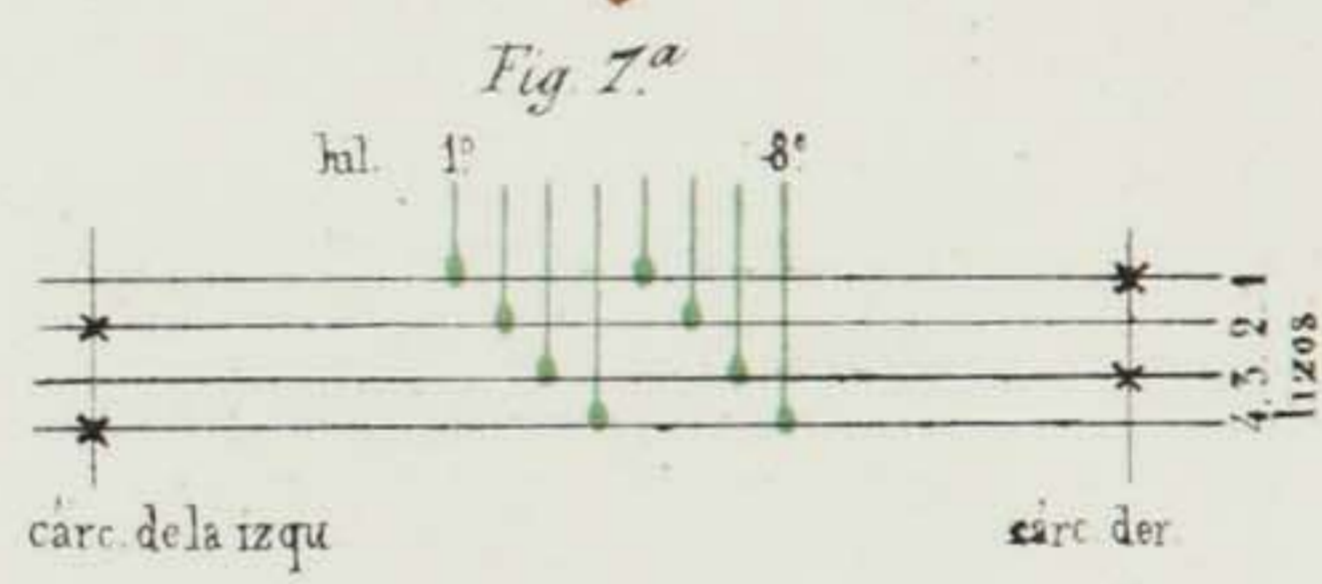
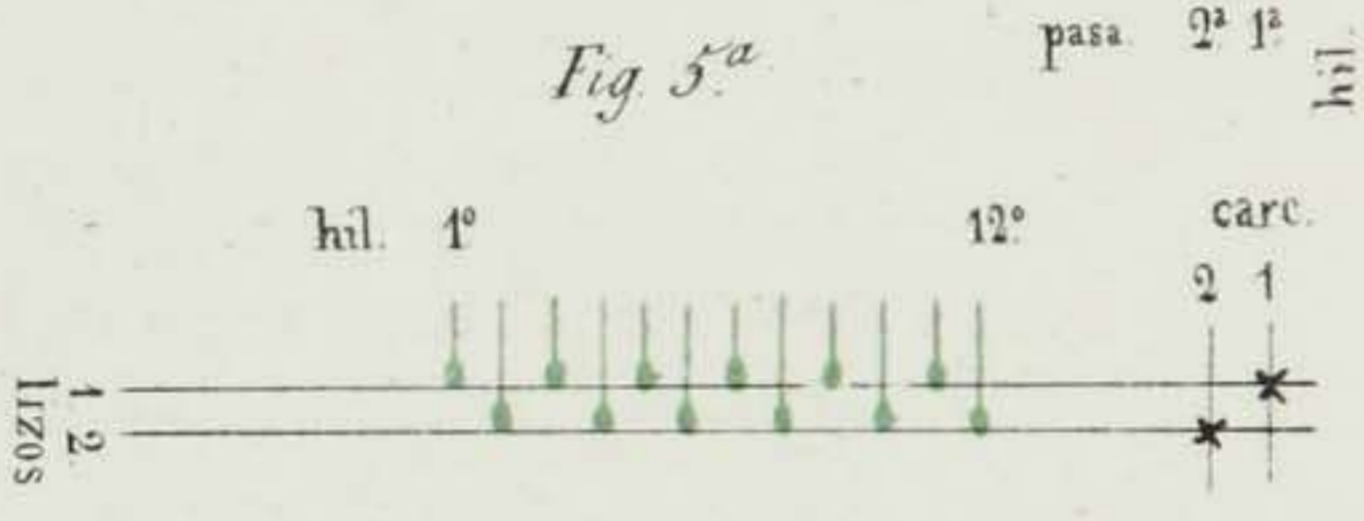
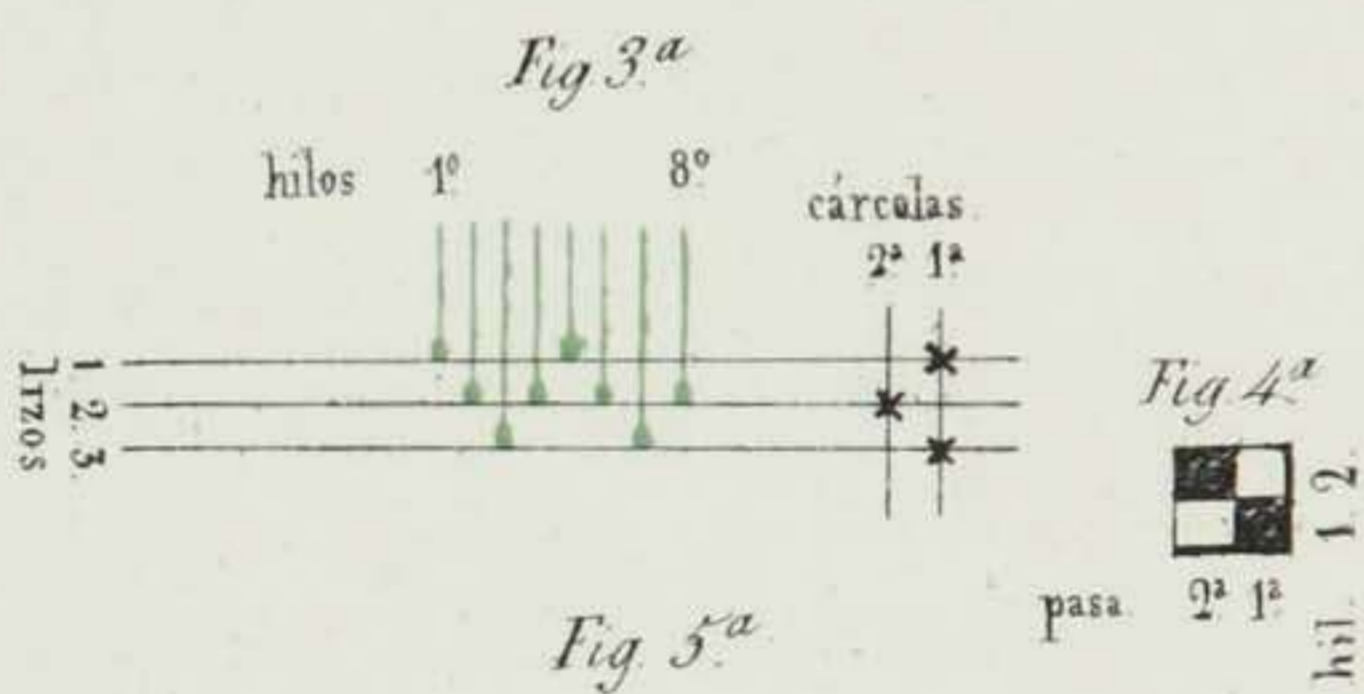
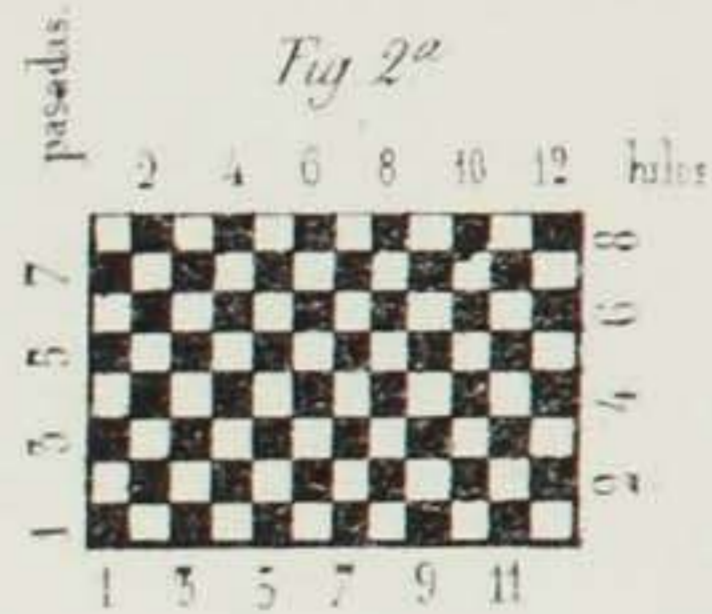
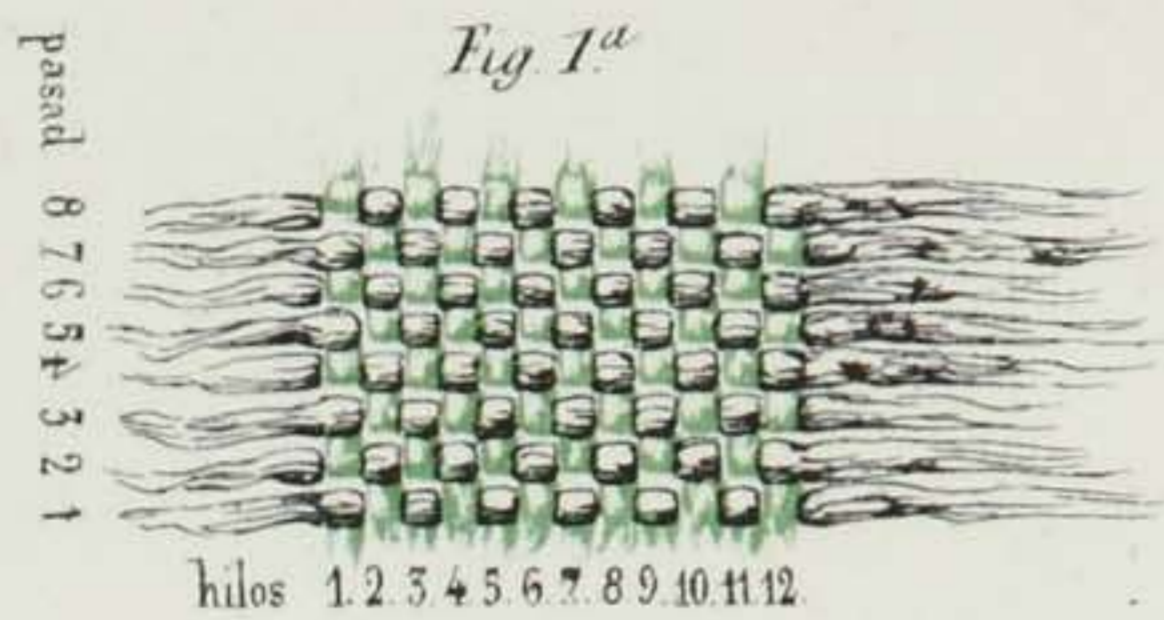
c

d

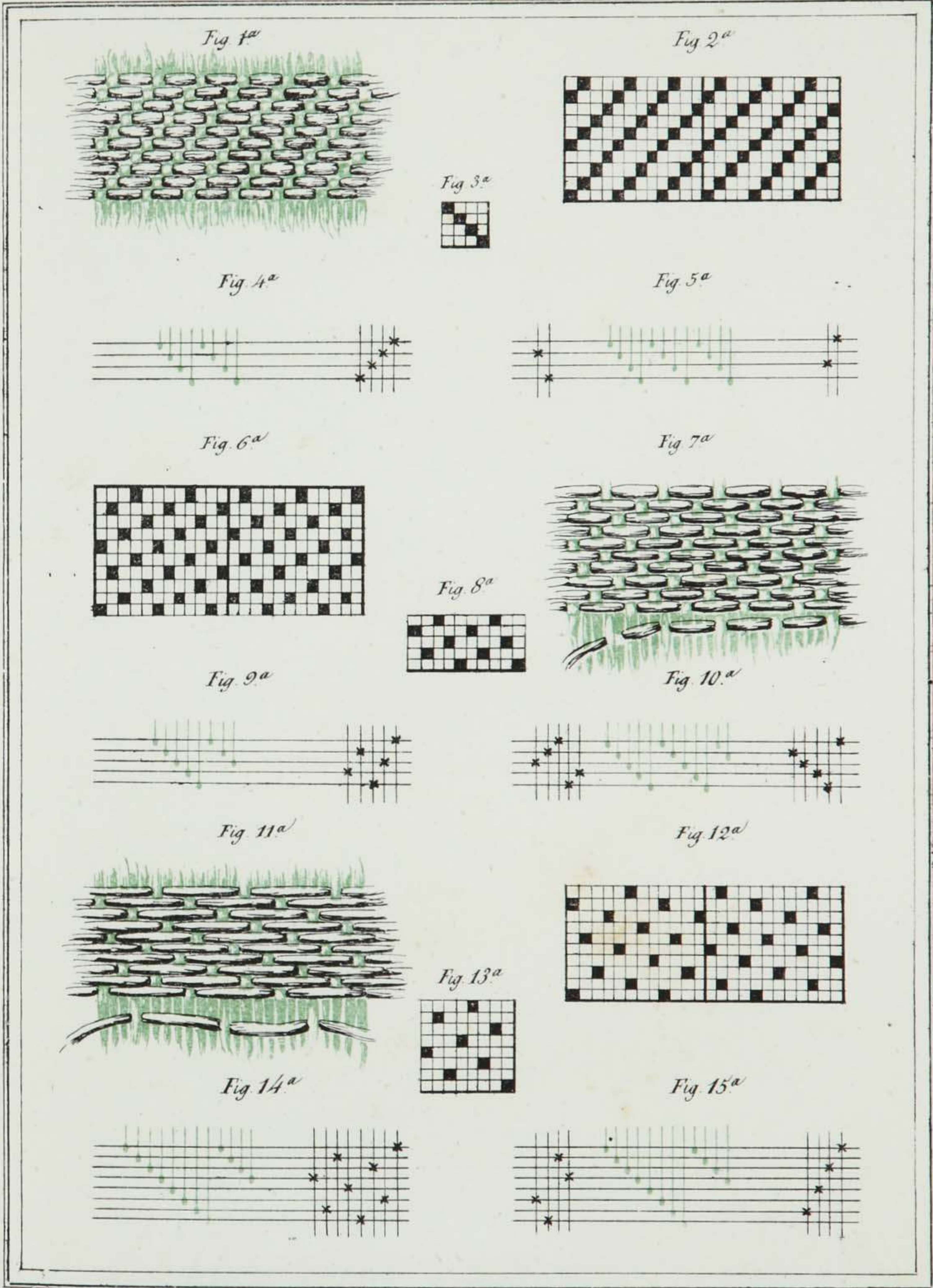
F

# Ligamientos fundamentales.

Lám. X



Ligamientos fundamentales.



# Ligamientos fundamentales.

Lam XVII.

Fig 1<sup>a</sup>

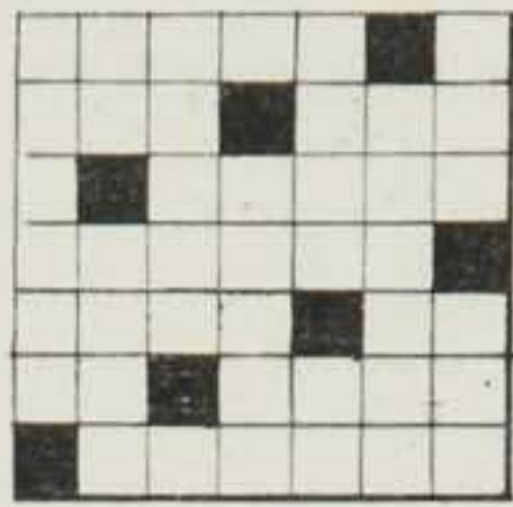


Fig 2<sup>a</sup>

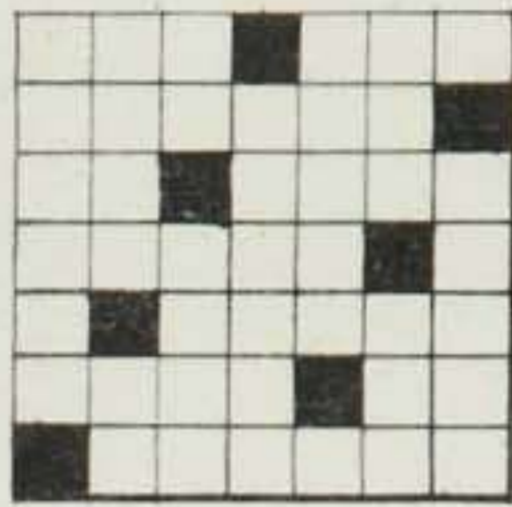


Fig 3<sup>a</sup>

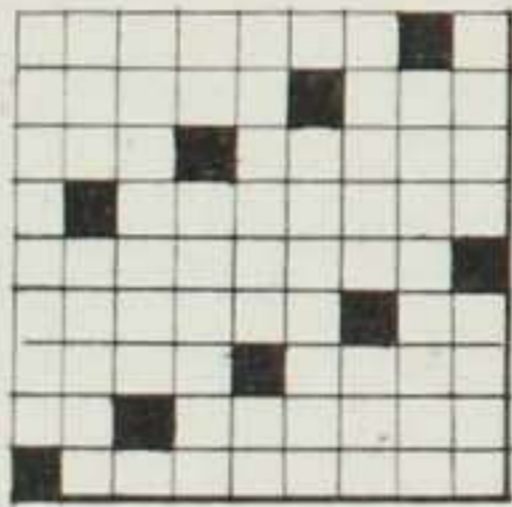


Fig 4<sup>a</sup>

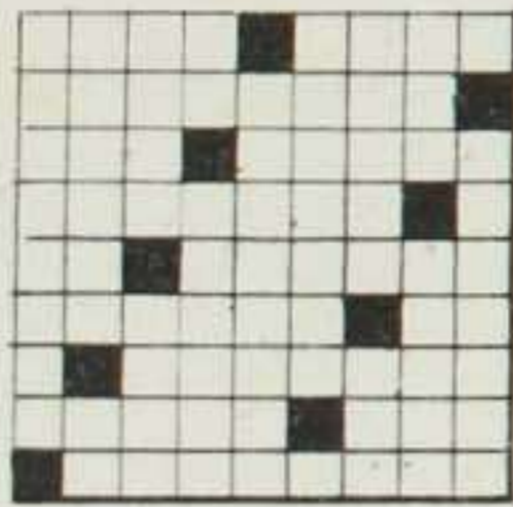


Fig 5<sup>a</sup>

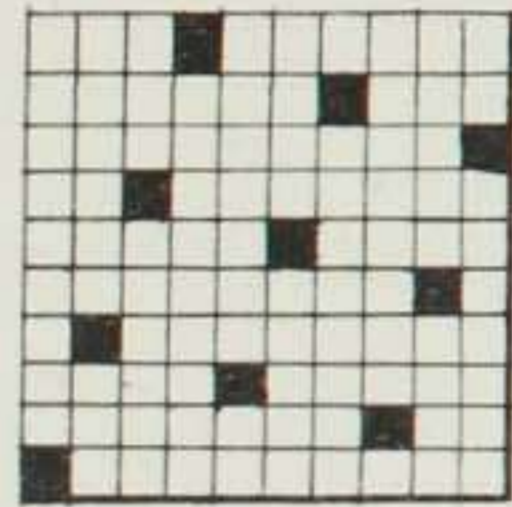


Fig 6<sup>a</sup>

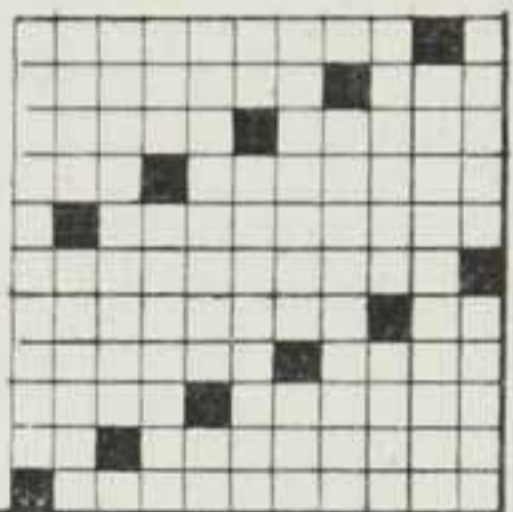


Fig 7<sup>a</sup>

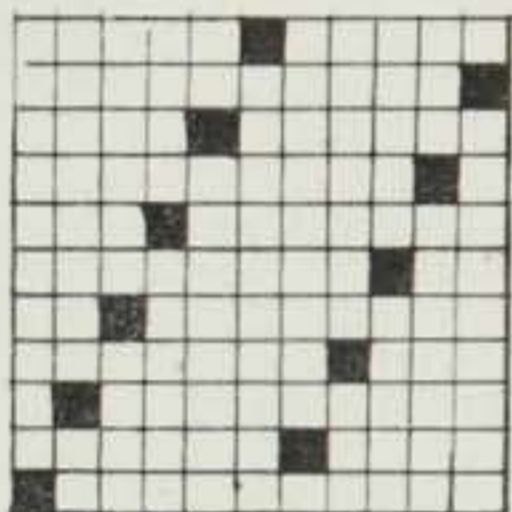


Fig 8<sup>a</sup>

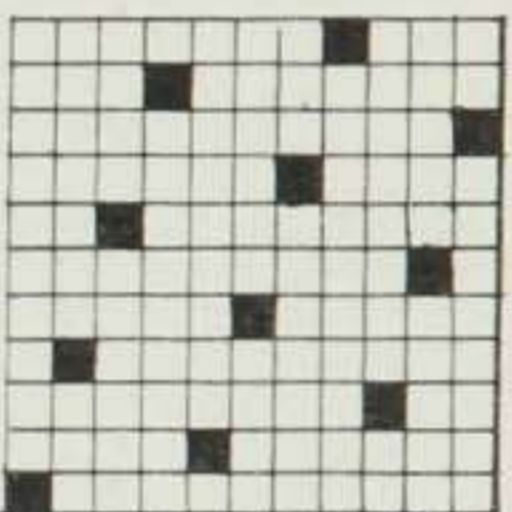


Fig 9<sup>a</sup>

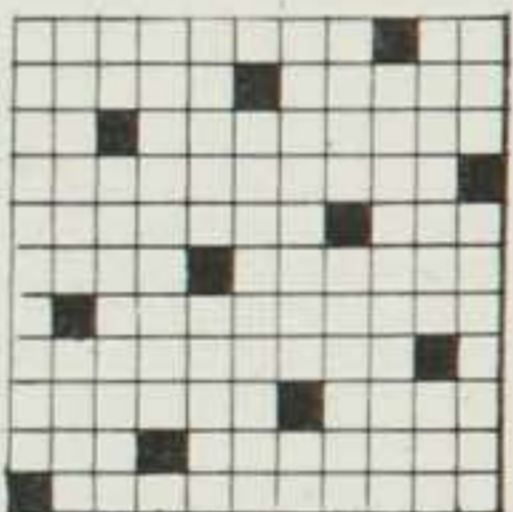


Fig 10<sup>a</sup>

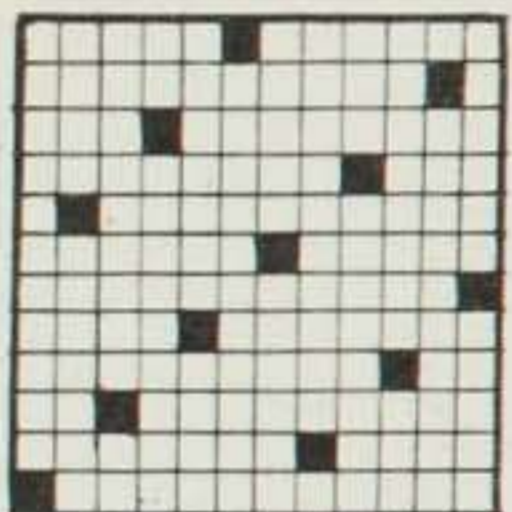


Fig 11<sup>a</sup>

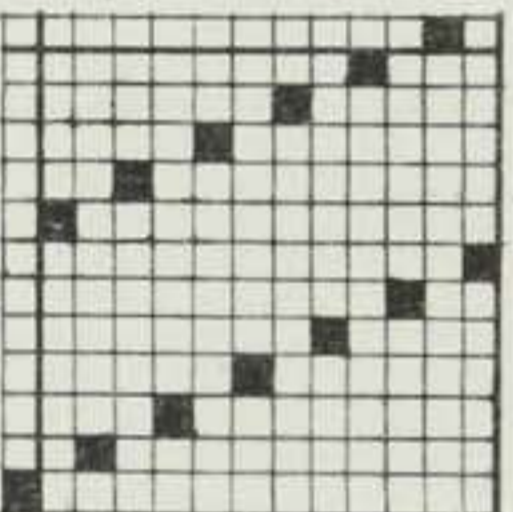


Fig 12<sup>a</sup>

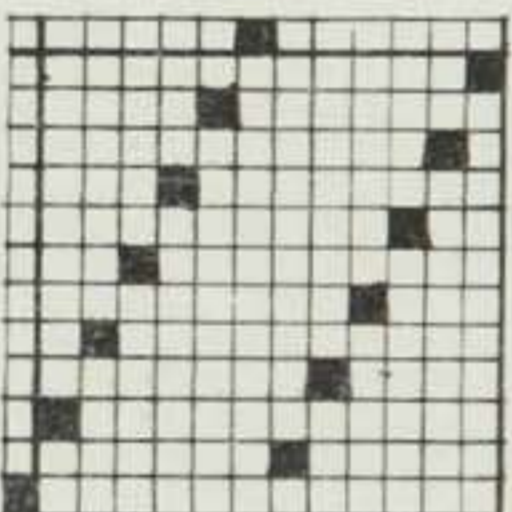


Fig 13<sup>a</sup>



Fig 14<sup>a</sup>

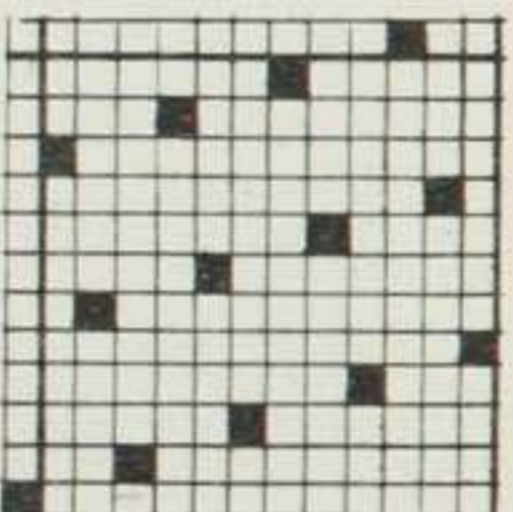


Fig 15<sup>a</sup>

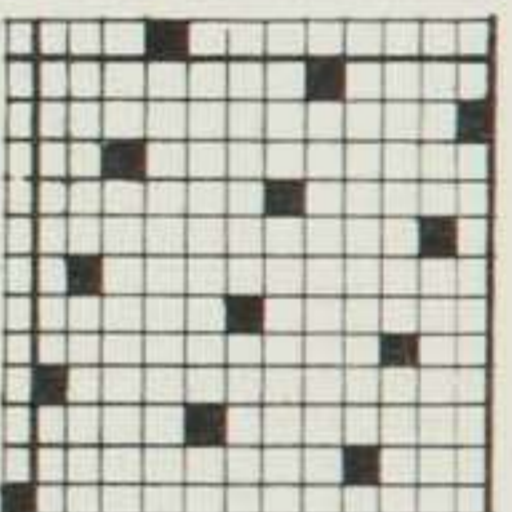


Fig 16<sup>a</sup>

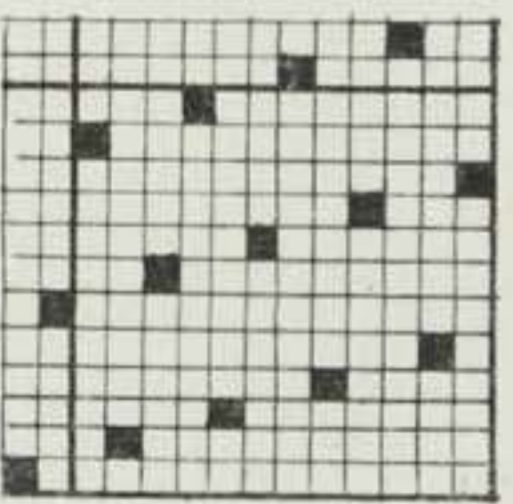


Fig 17<sup>a</sup>

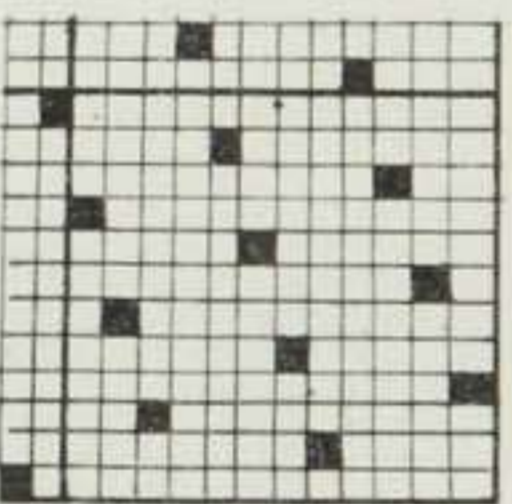


Fig 18<sup>a</sup>

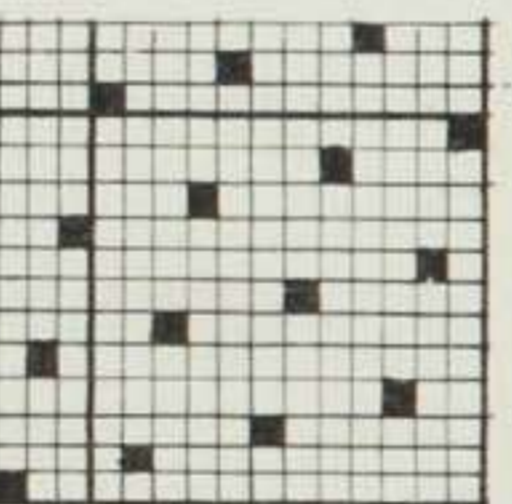


Fig 19<sup>a</sup>

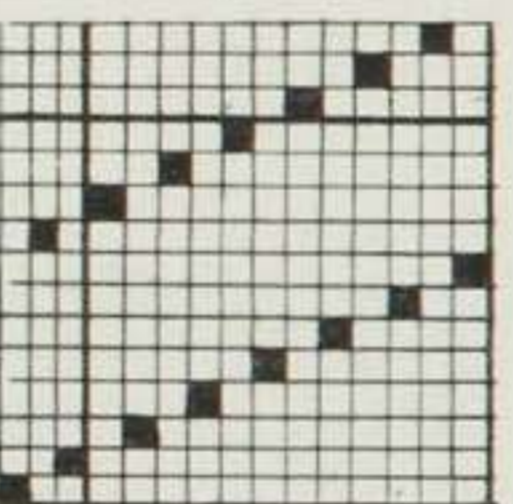


Fig 20<sup>a</sup>

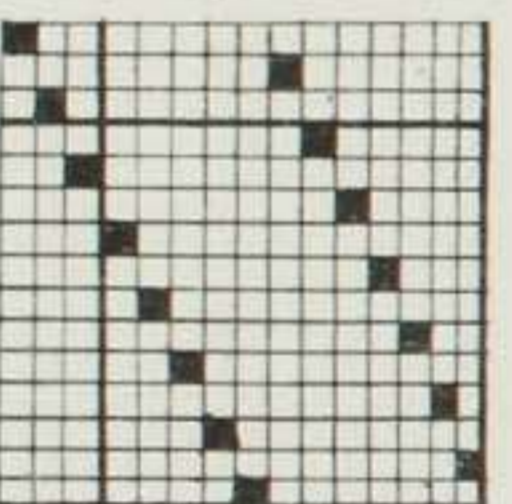


Fig 21<sup>a</sup>

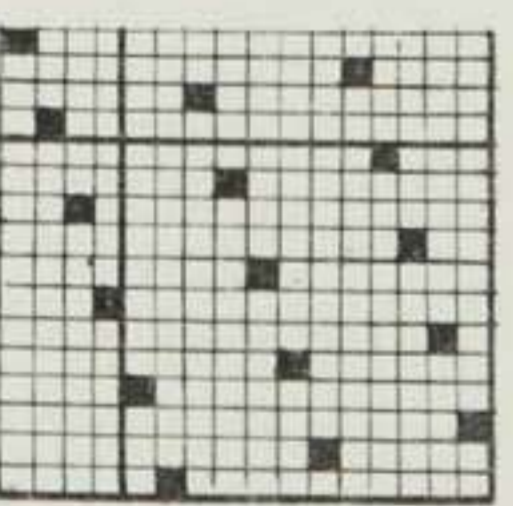


Fig 22<sup>a</sup>

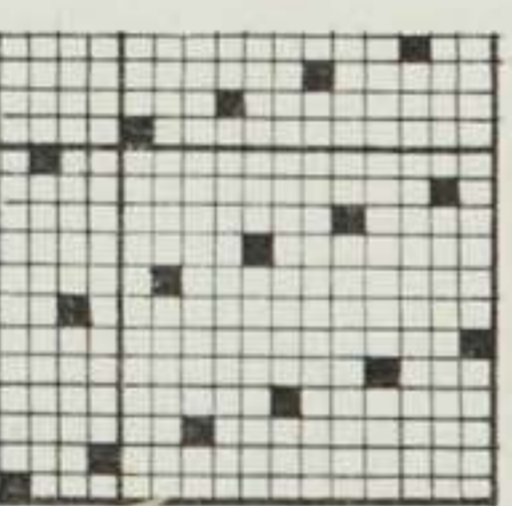


Fig 23<sup>a</sup>

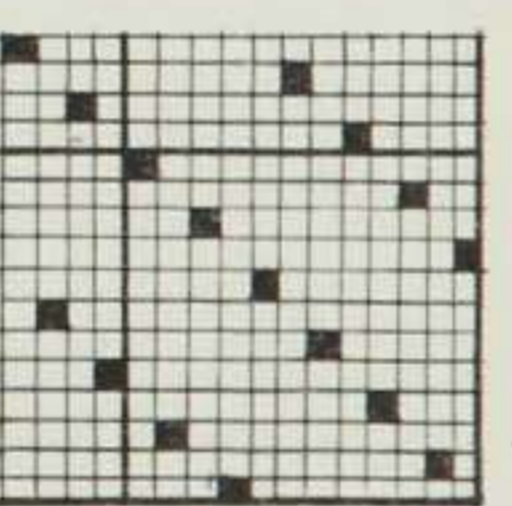


Fig 24<sup>a</sup>

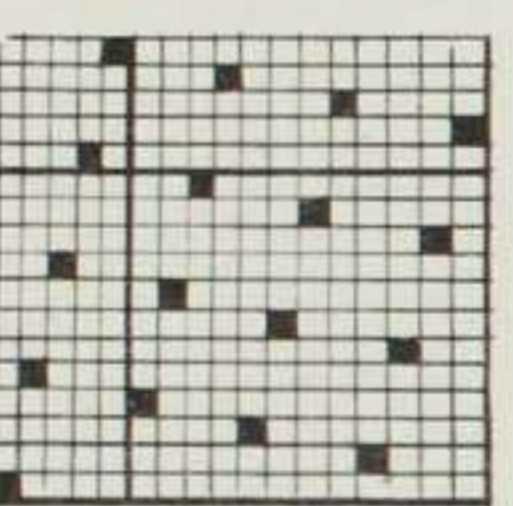
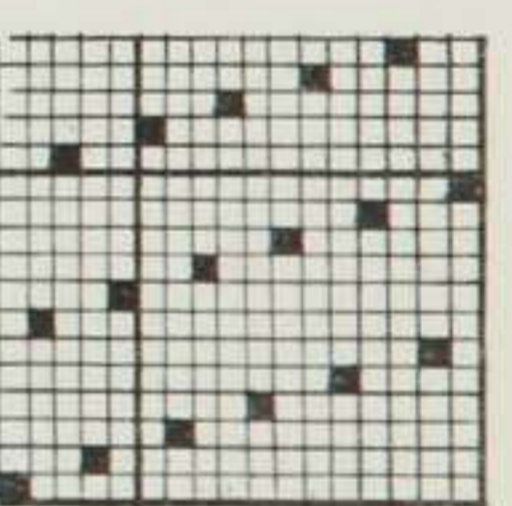
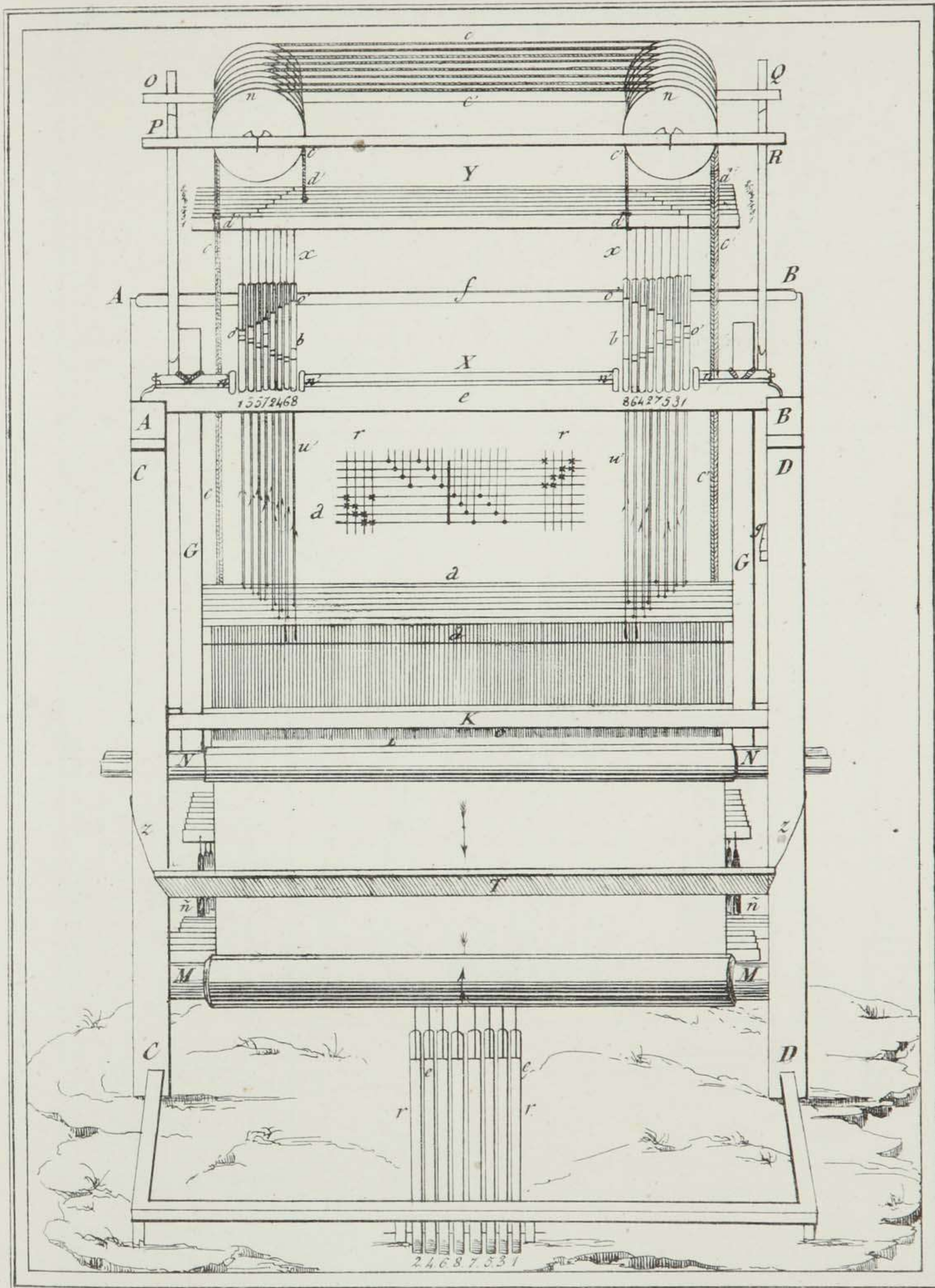


Fig 25<sup>a</sup>

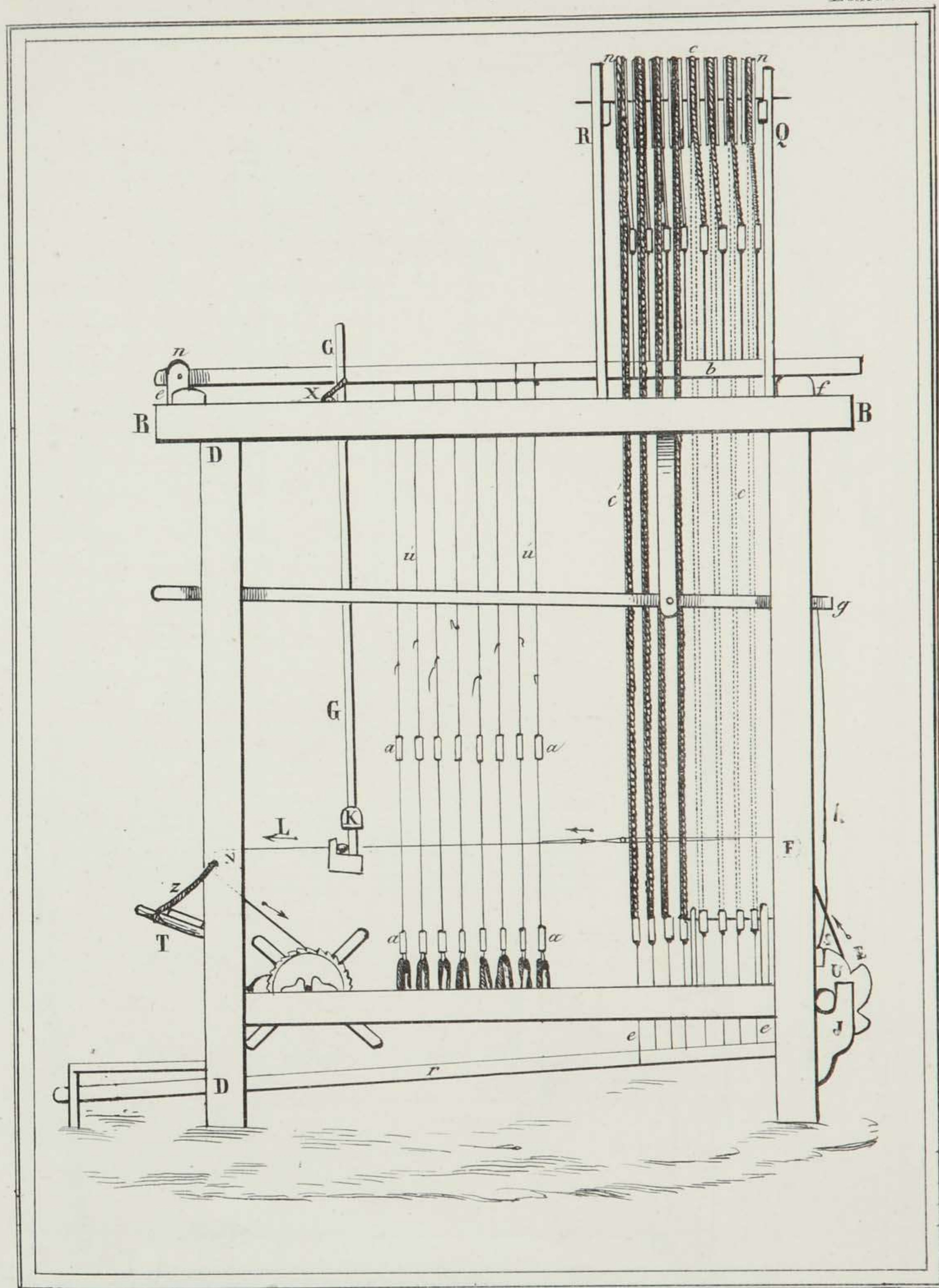


Telar y castillete de tejedor para lizos de subida  
visto de frente.

*Lam XIII.*

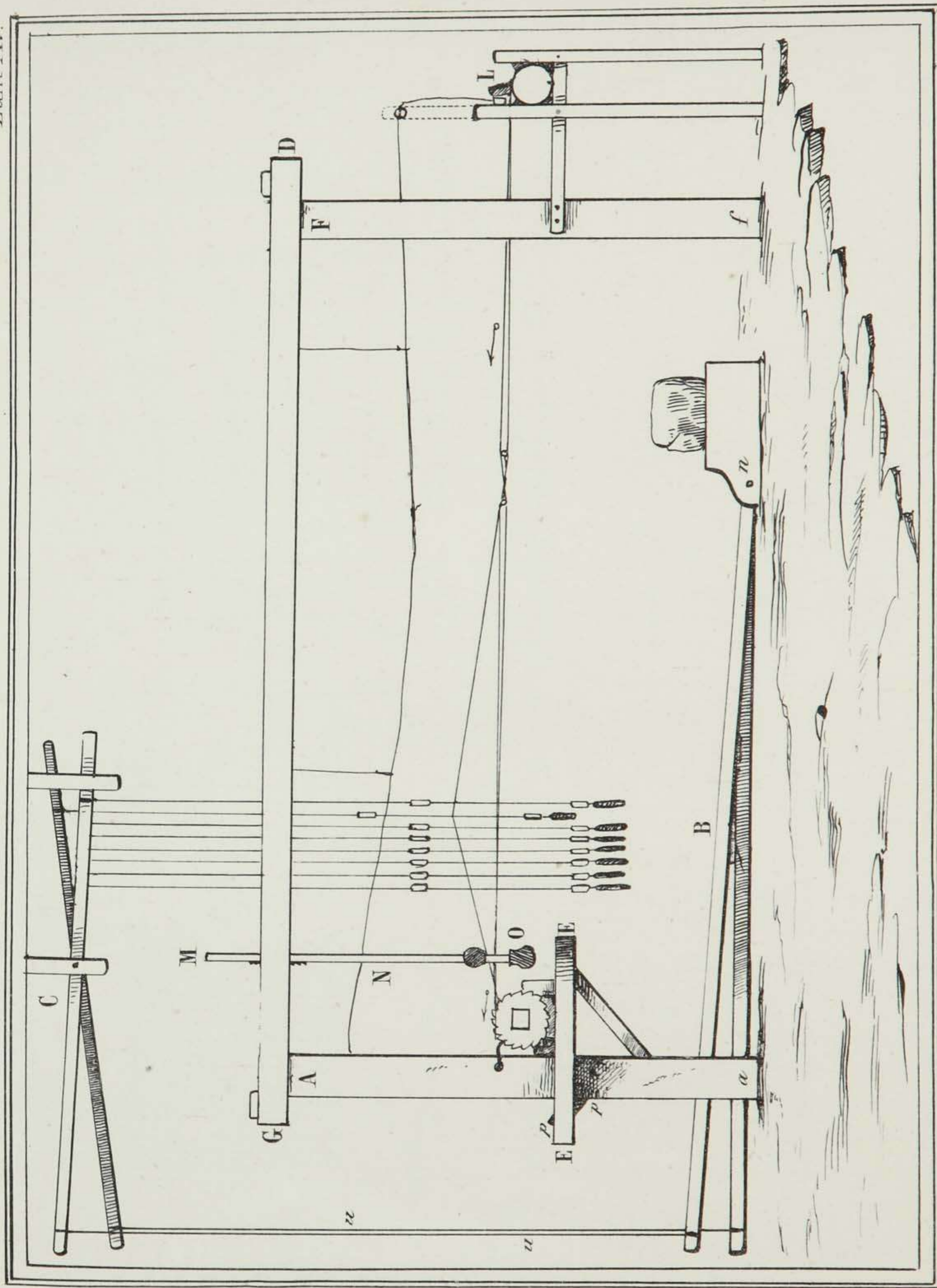


Alzado lateral del telar de tejedor para lizos de subida. *Lam. XIV.*



TELAR PARA SEDA.  
alzado lateral de la derecha.

Lam. XV.

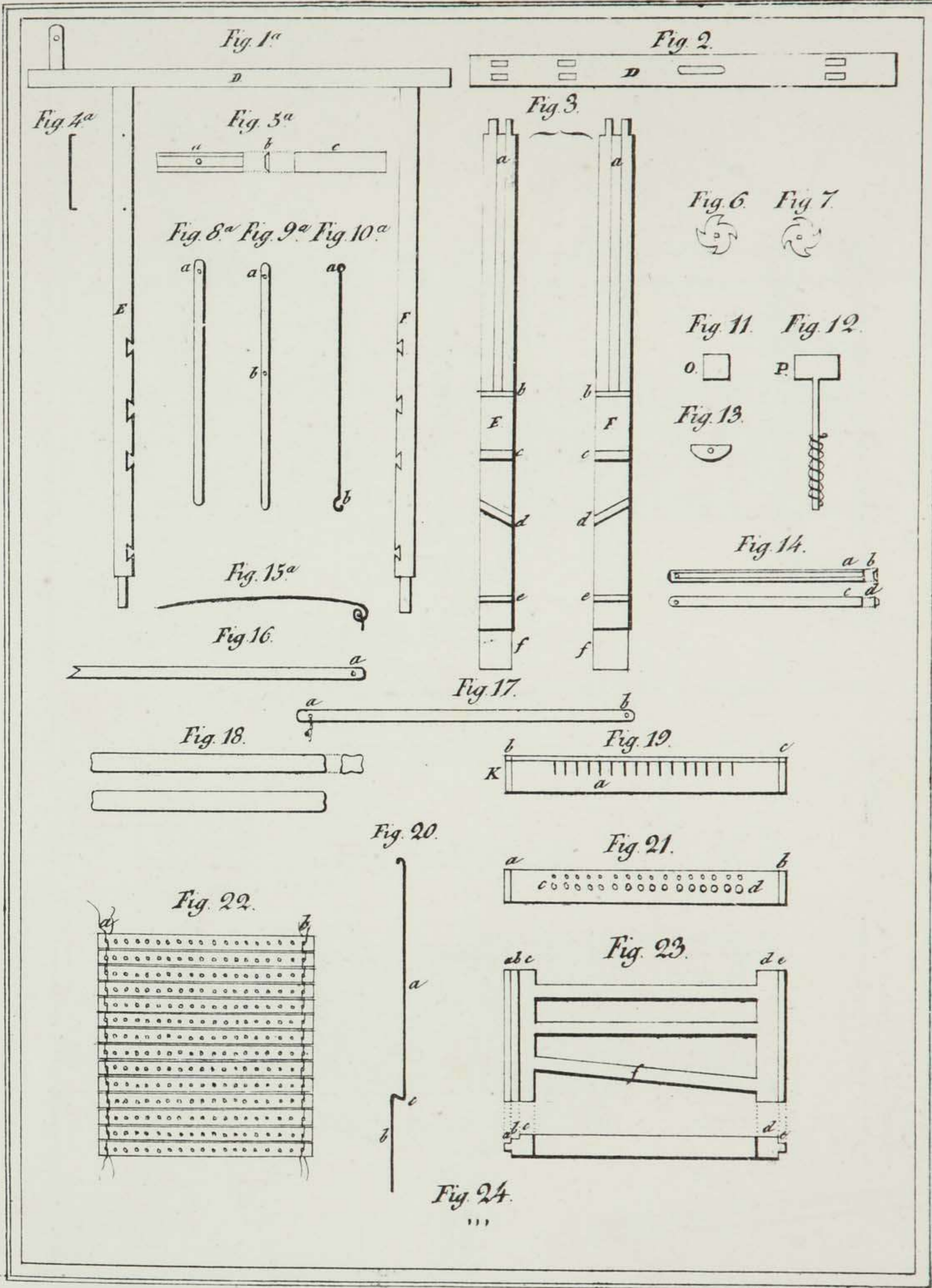


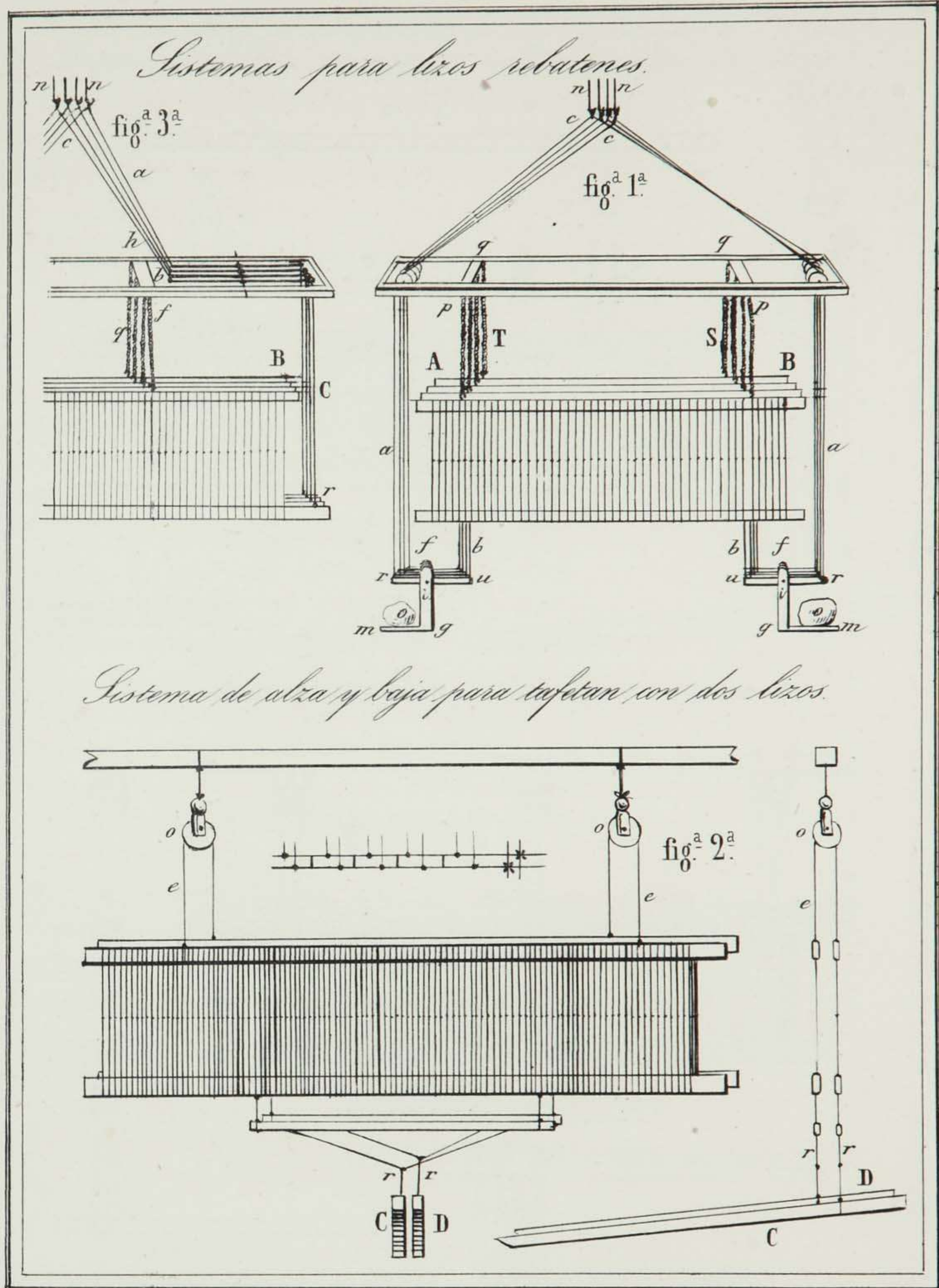


UTENSILIOS .

Piezas de la maquina de ligar N° 2.

Lam XVI





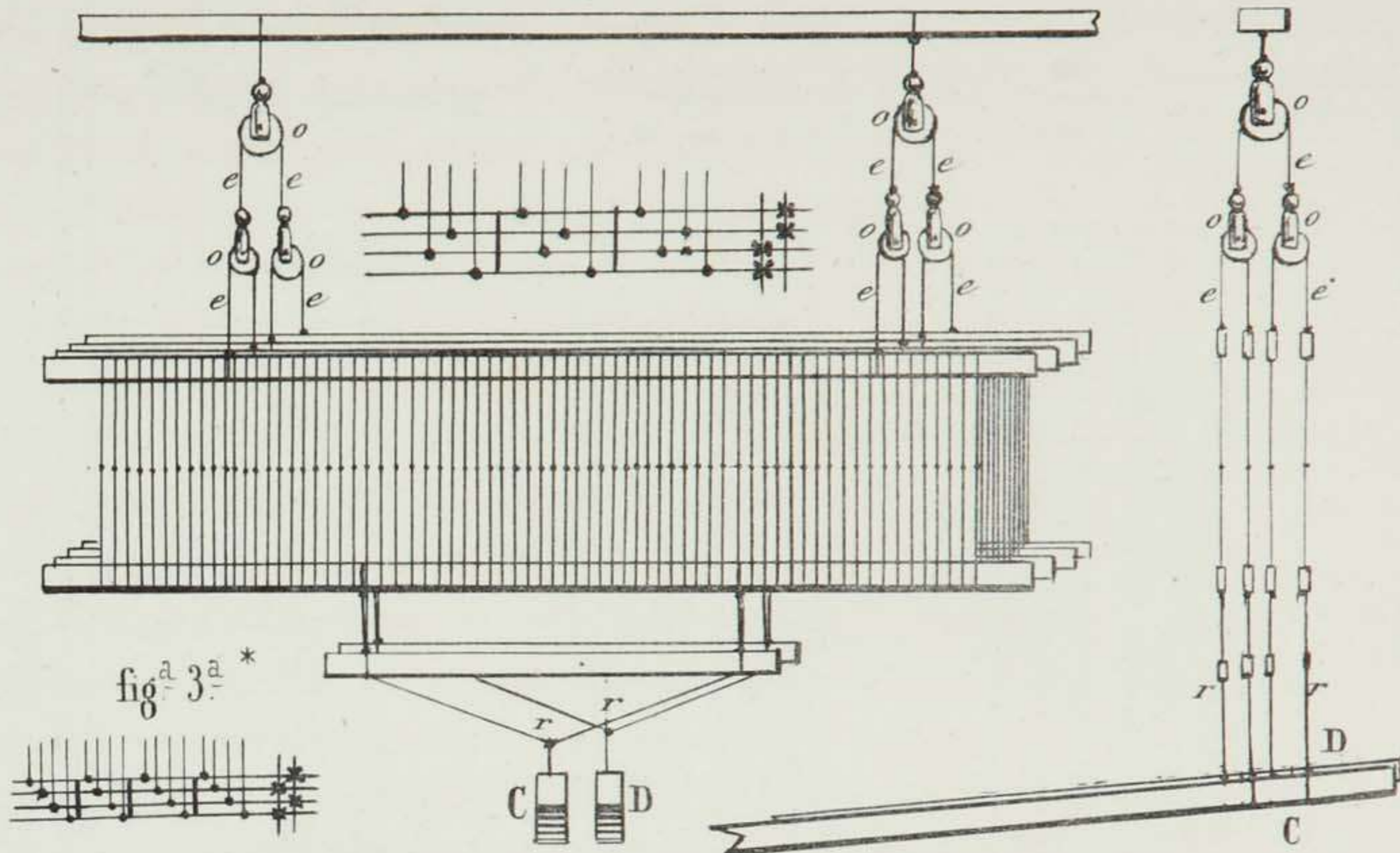
# Movimientos de los lizos.

Lám. XVIII.

*Sistema de alza y baja para tafetan con cuatro lizos.*

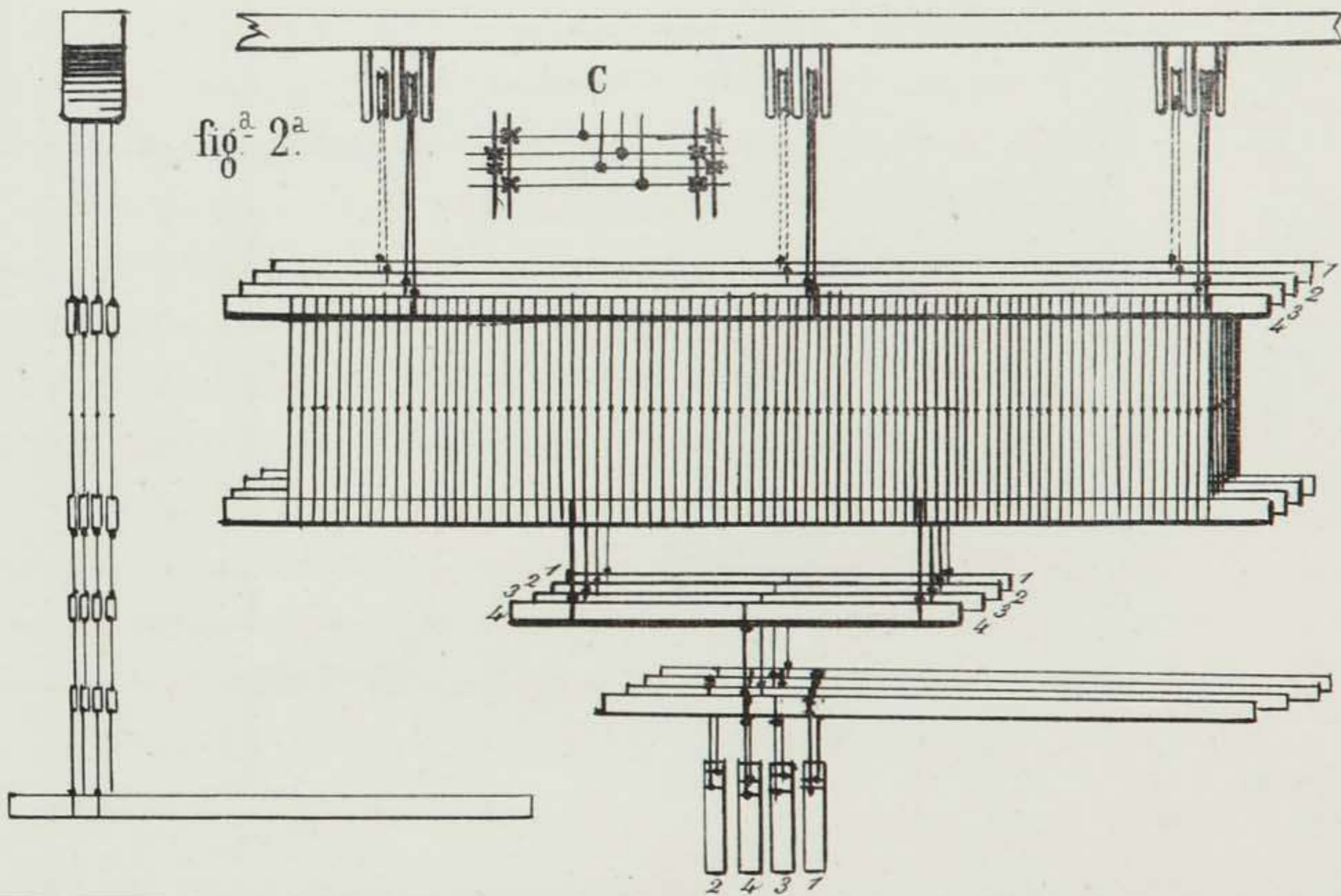
fig.<sup>a</sup> 1.<sup>a</sup>

fig.<sup>a</sup> 3.<sup>a</sup>



*Sistema de alza y baja para batavia.*

fig.<sup>a</sup> 2.<sup>a</sup>



MOVIMIENTOS DE LOS LIZOS  
 Sistema de alza y baja.

Lam. XIX.

*Mantolera de guarnido.*

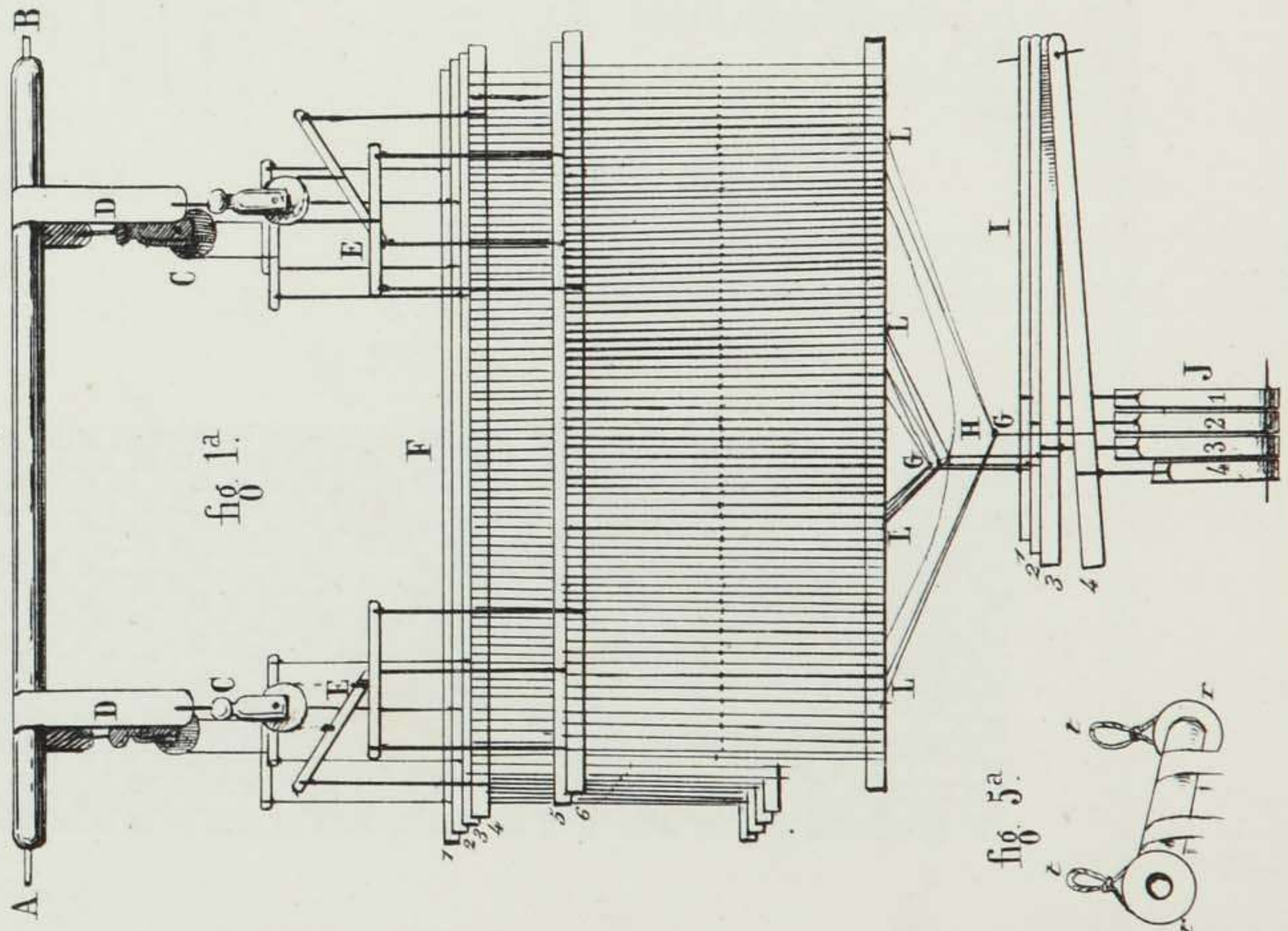


fig 1ª.

fig 6ª.

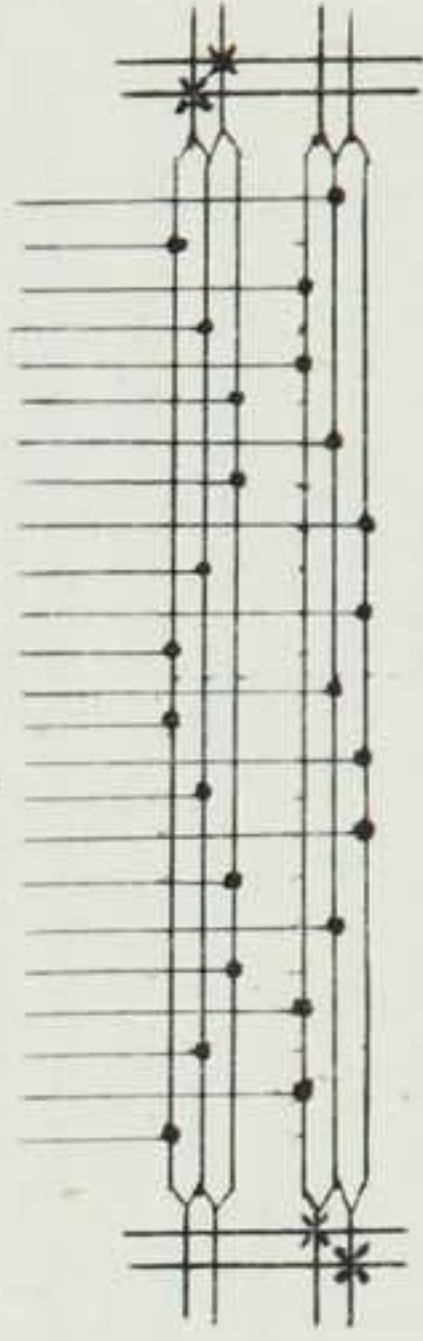


fig 3ª.

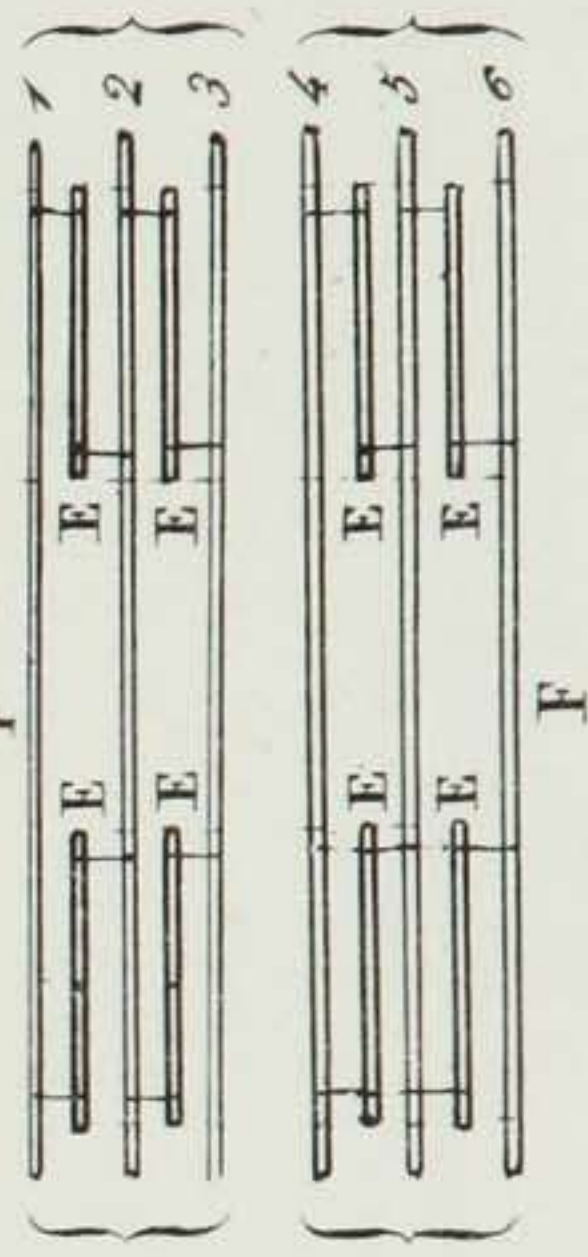


fig 4ª.

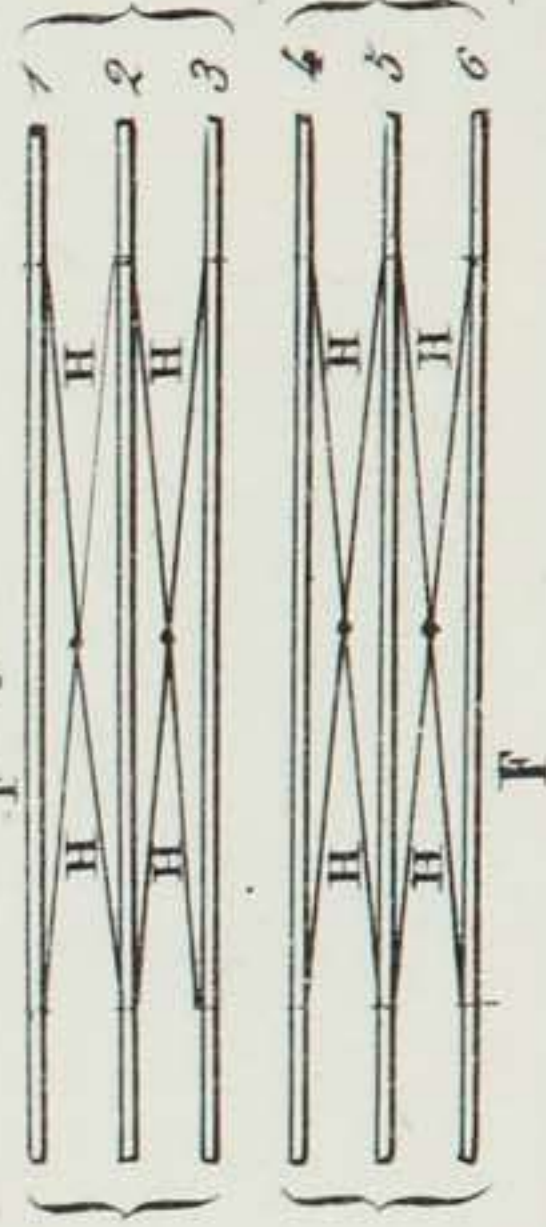


fig. 2ª.

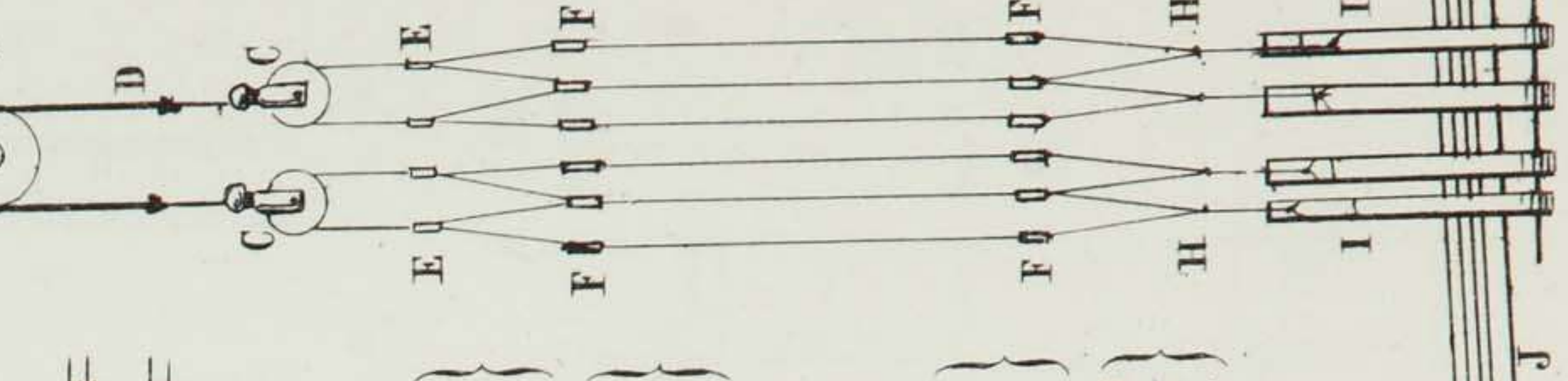
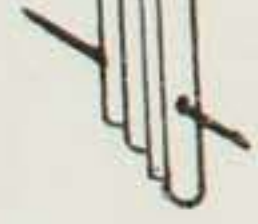
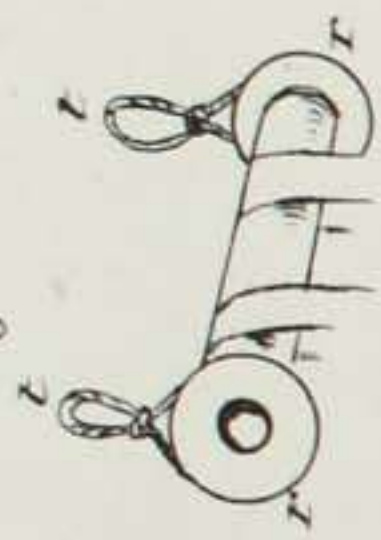
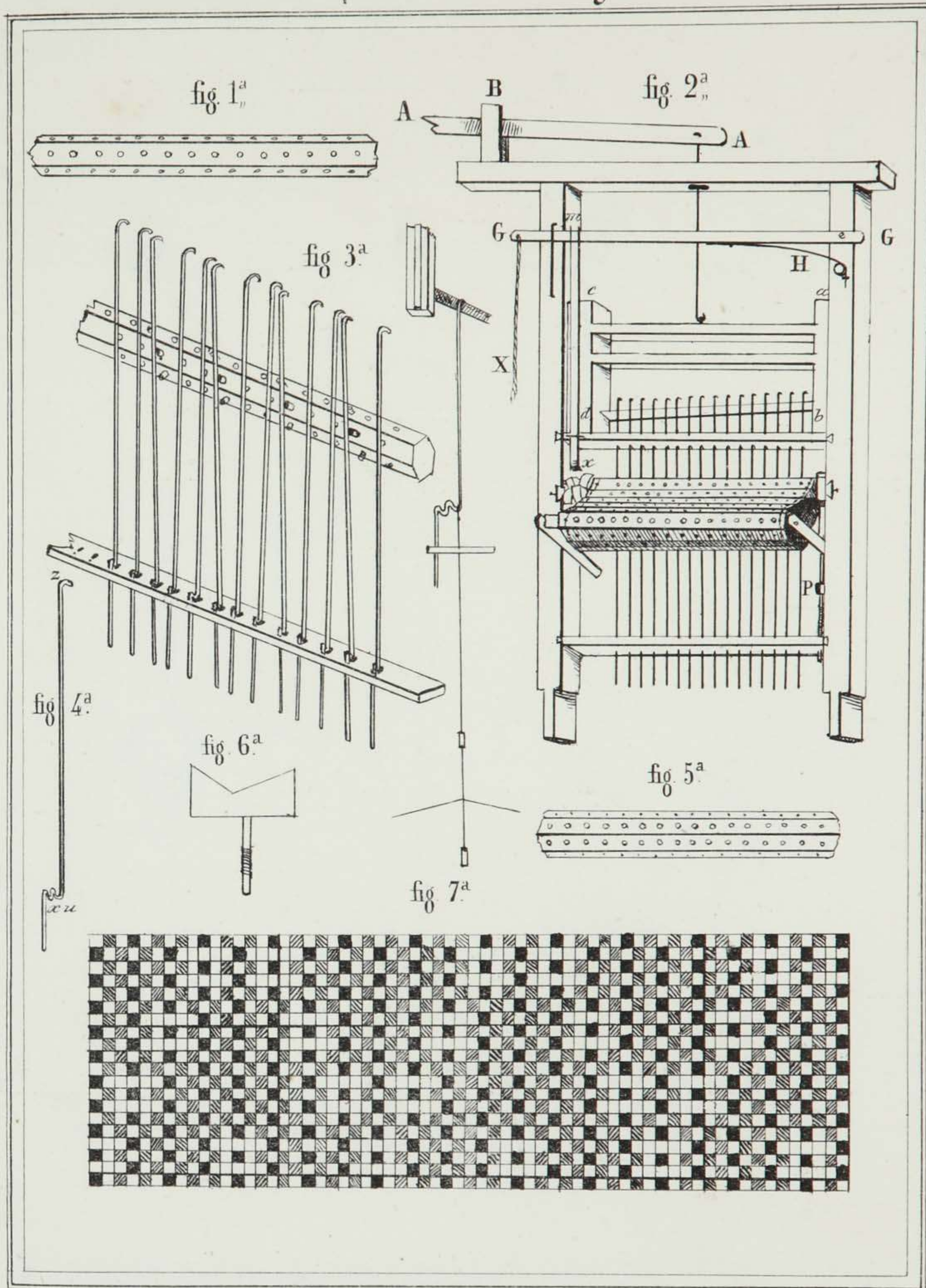
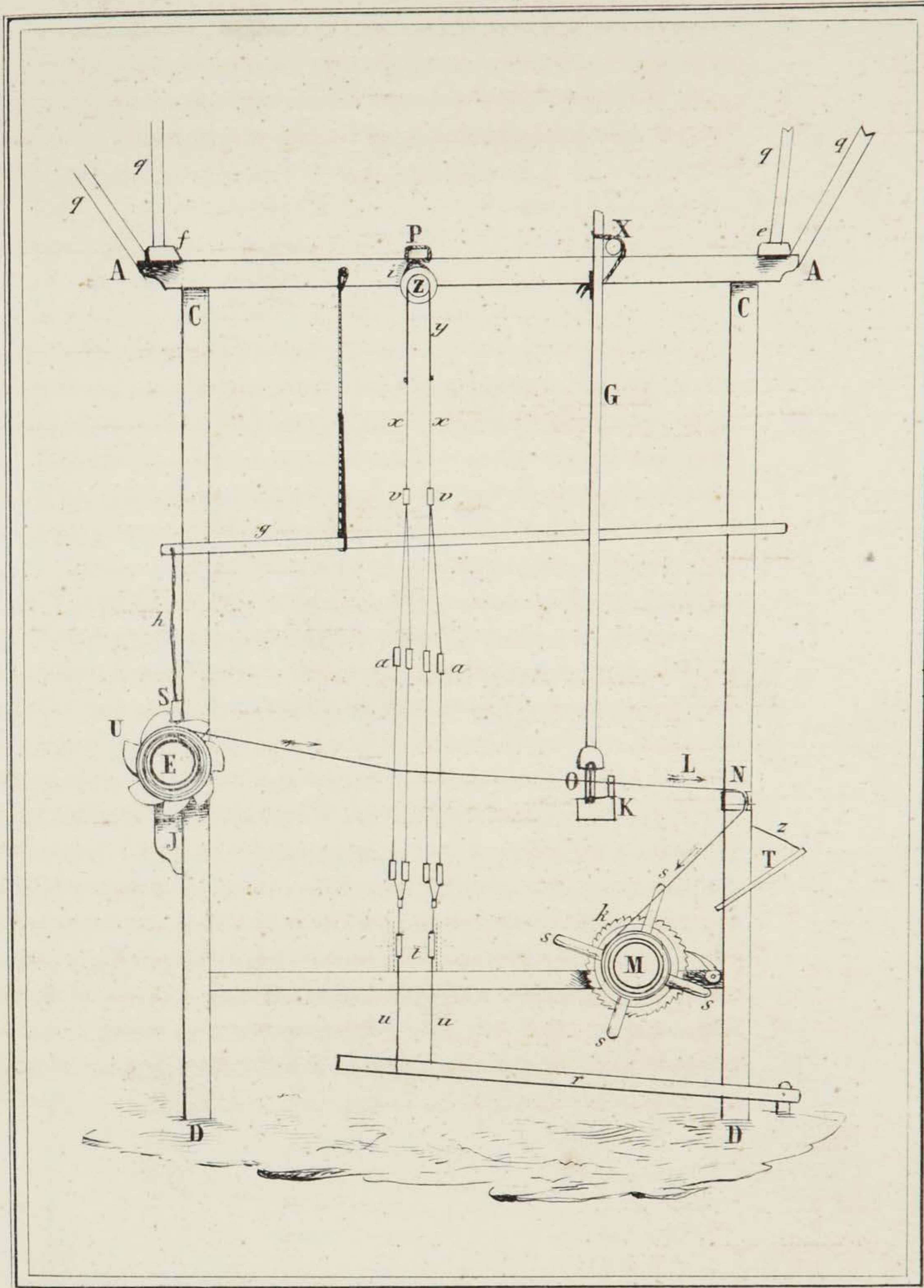


fig 5ª.



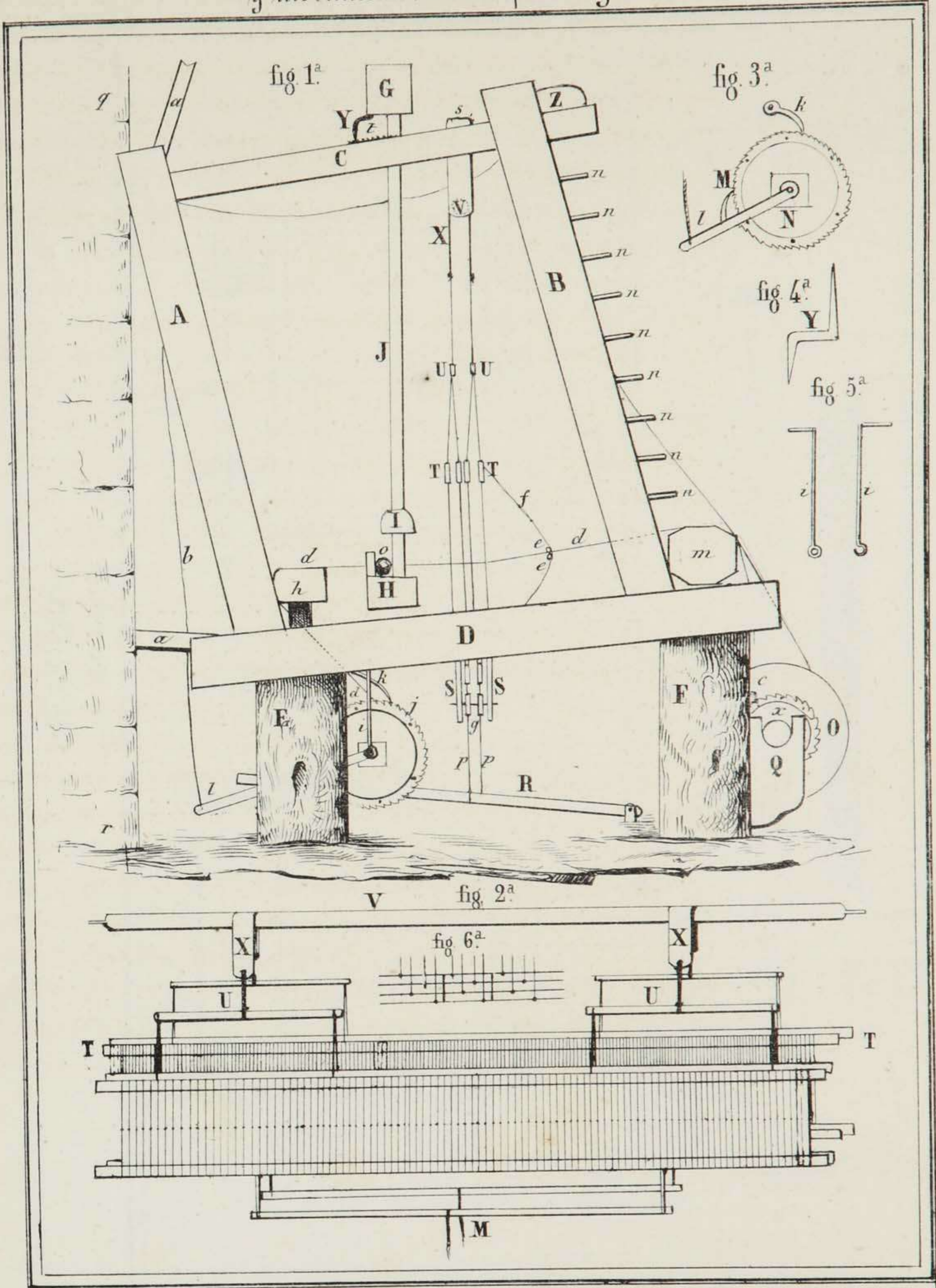


Corie vertical del tejar de tejedor  
visto del lado izquierdo.



Alzado lateral de un telar propio para paños, castorinas &.  
 y movimiento de lizos para tafetan.

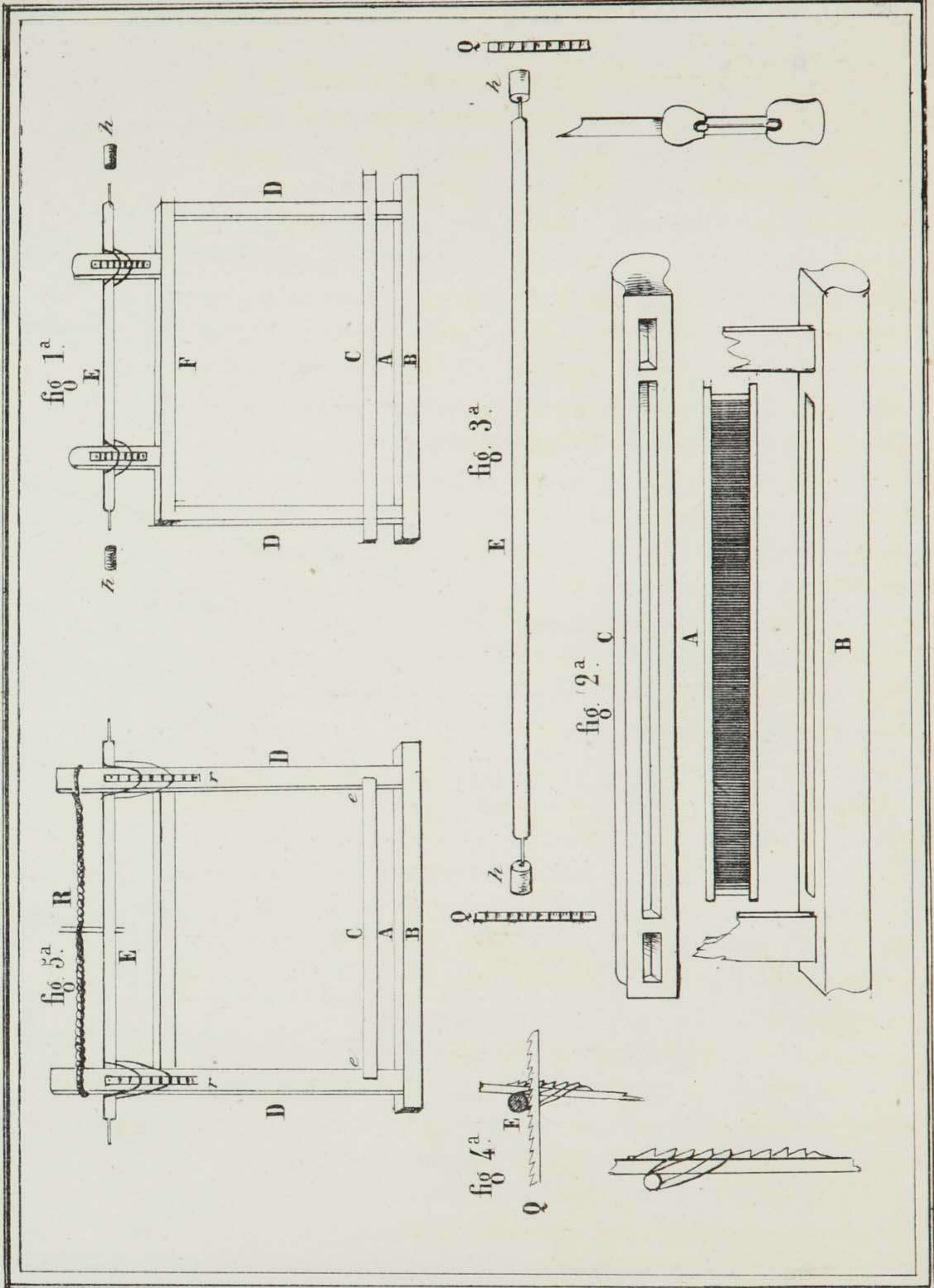
Lam XXII.



# UTENSILIOS

cajas de mano.

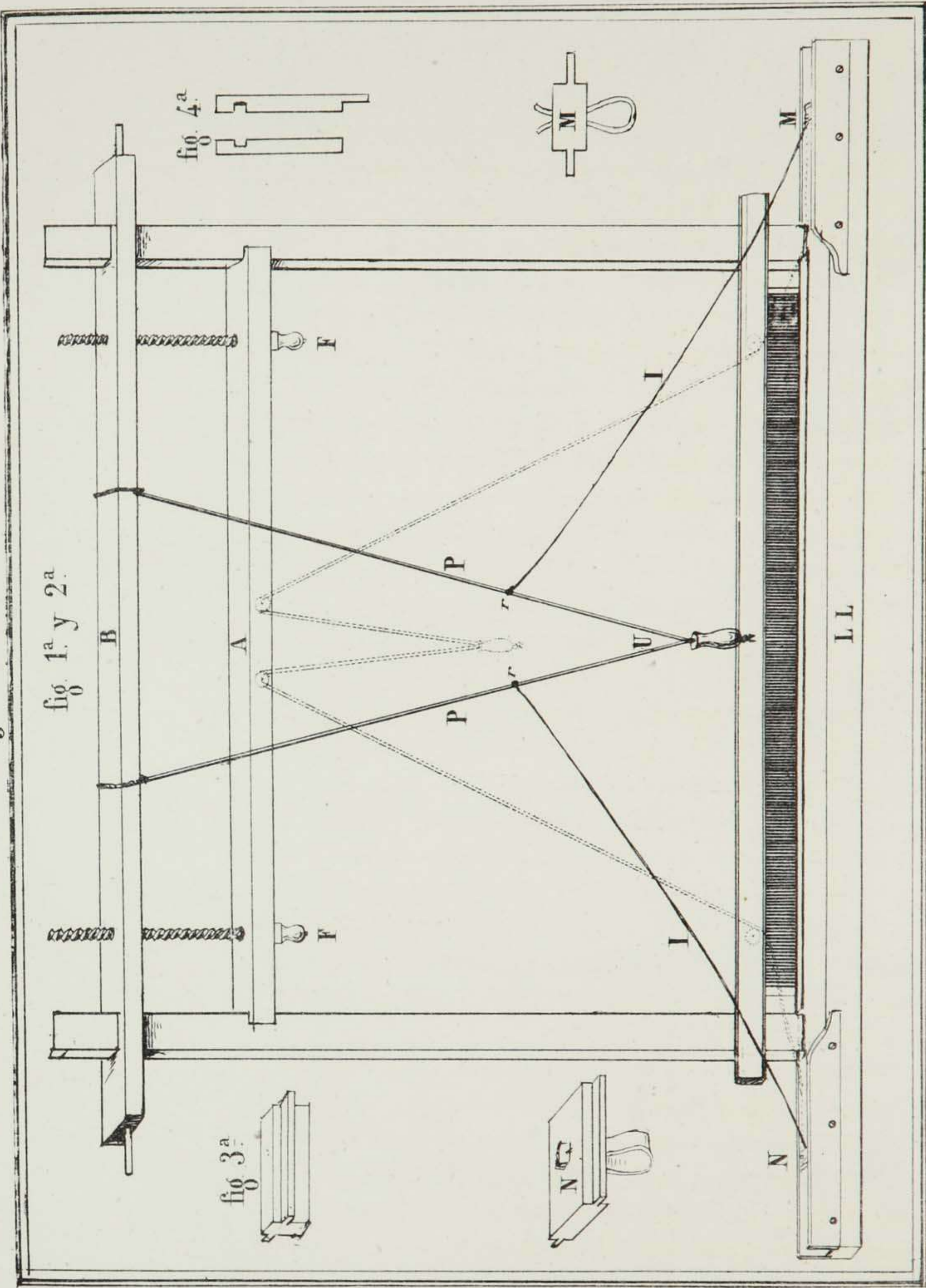
Lam. XXIII.





UTENSILIOS  
caja de volante.

Lam. XXIV.



UTENSILIOS.  
Lanzaderas.

Lam. XXV.

fig. 1<sup>a</sup>

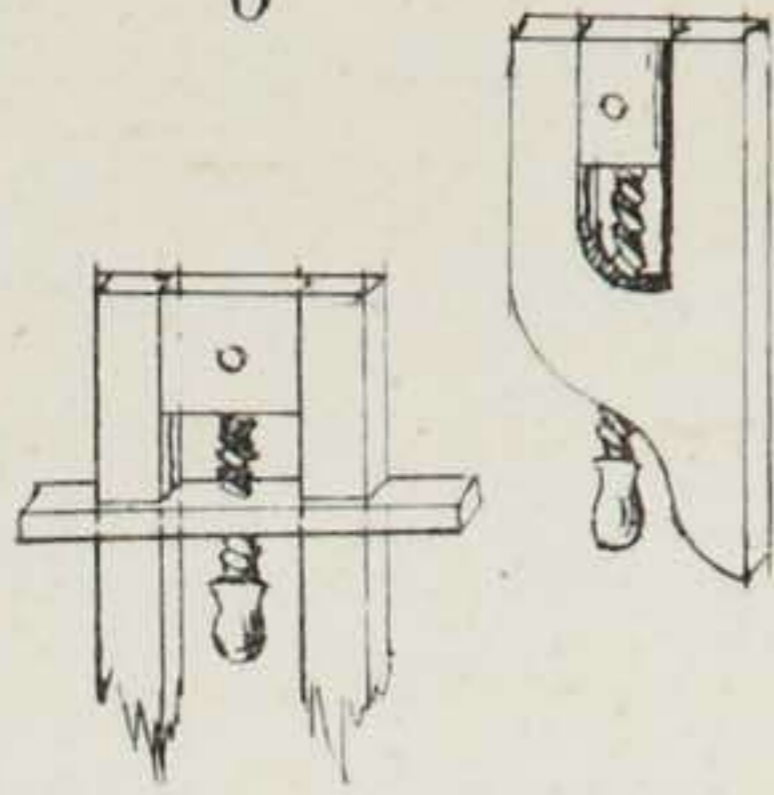


fig. 5<sup>a</sup>

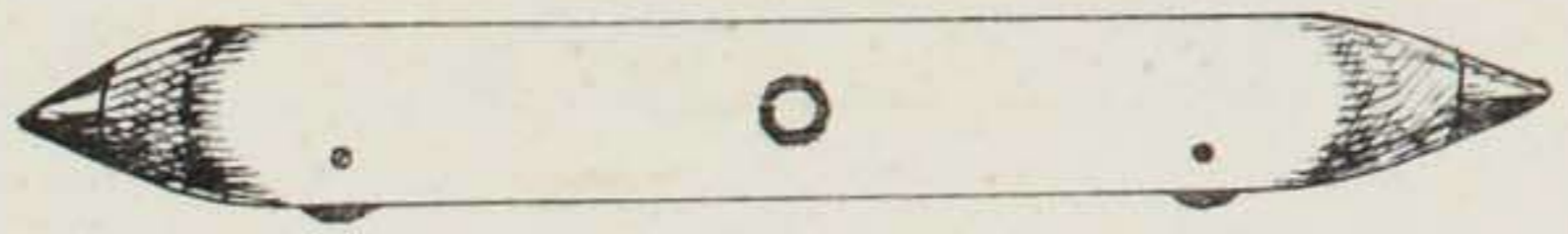
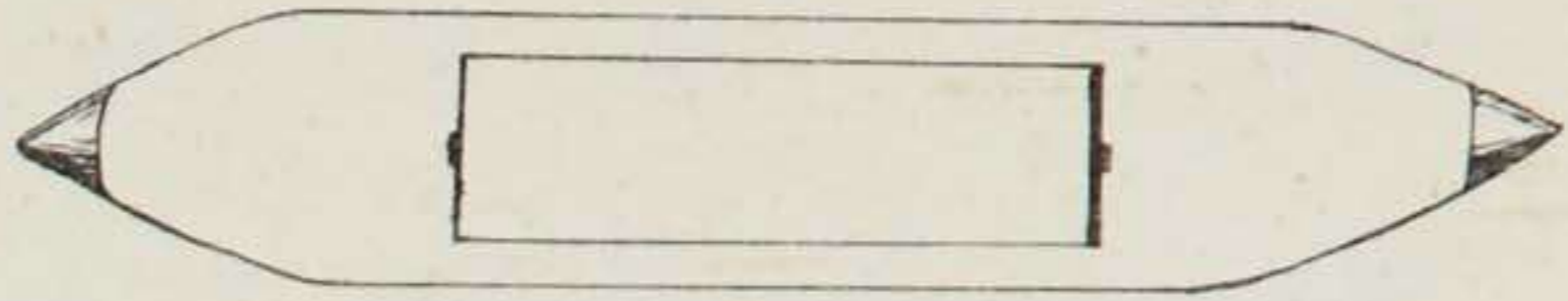


fig. 2<sup>a</sup>

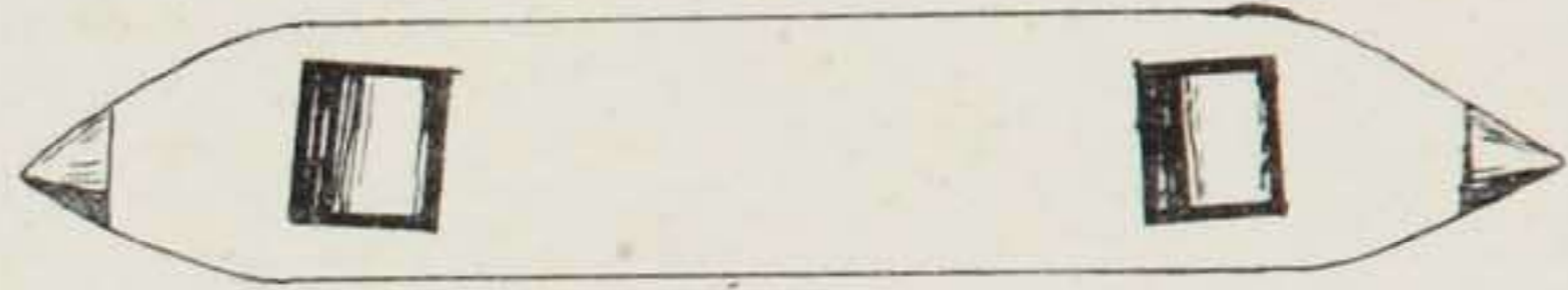
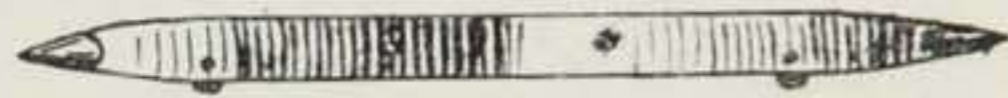


fig. 6<sup>a</sup>

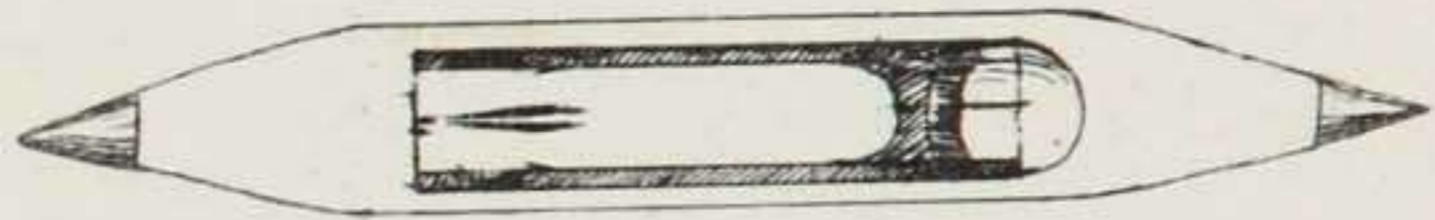


fig. 3<sup>a</sup>



fig. 4<sup>a</sup>

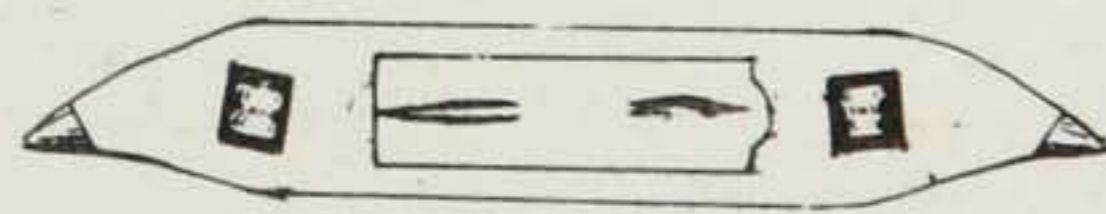
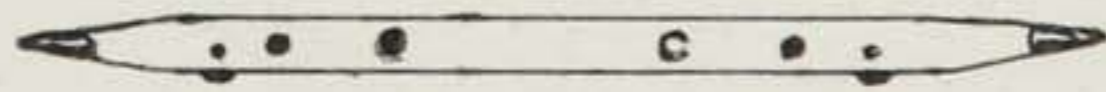
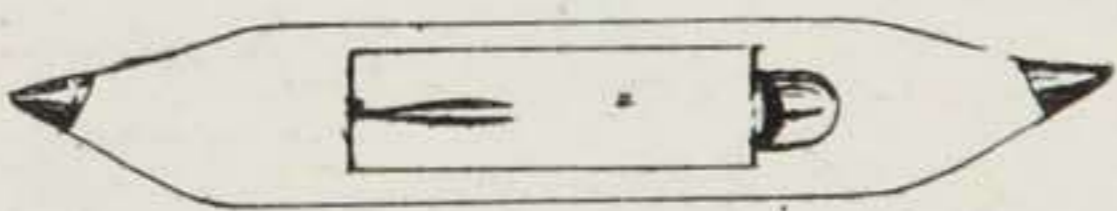
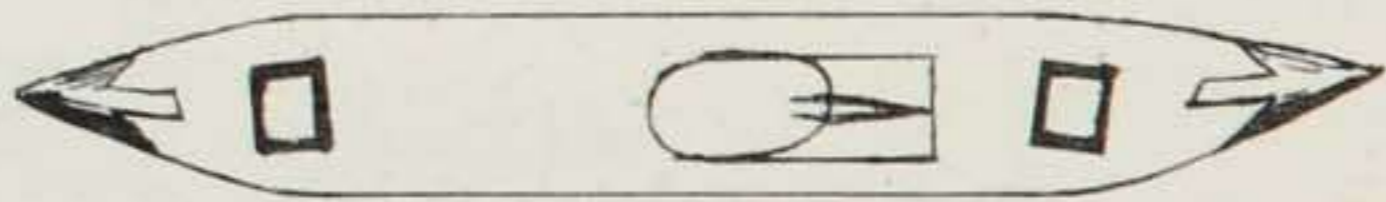
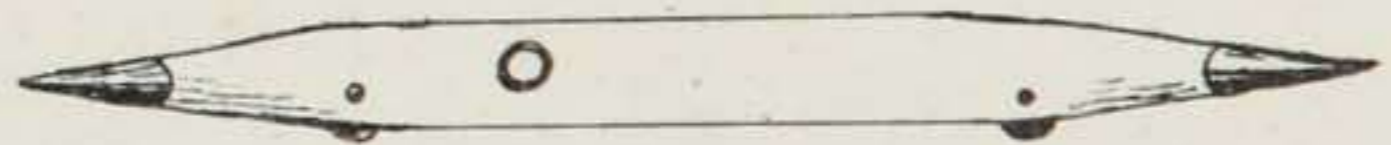
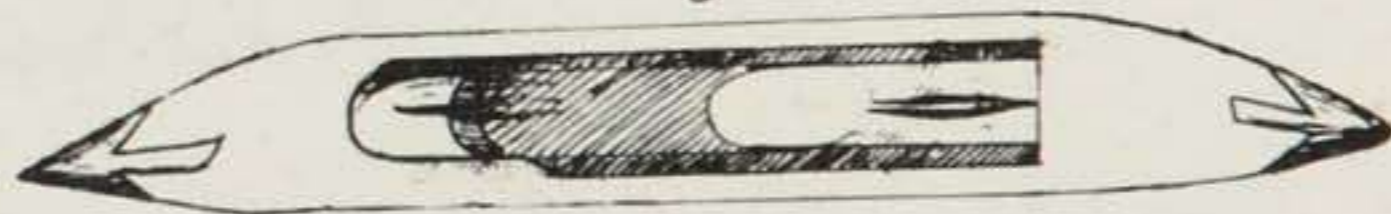
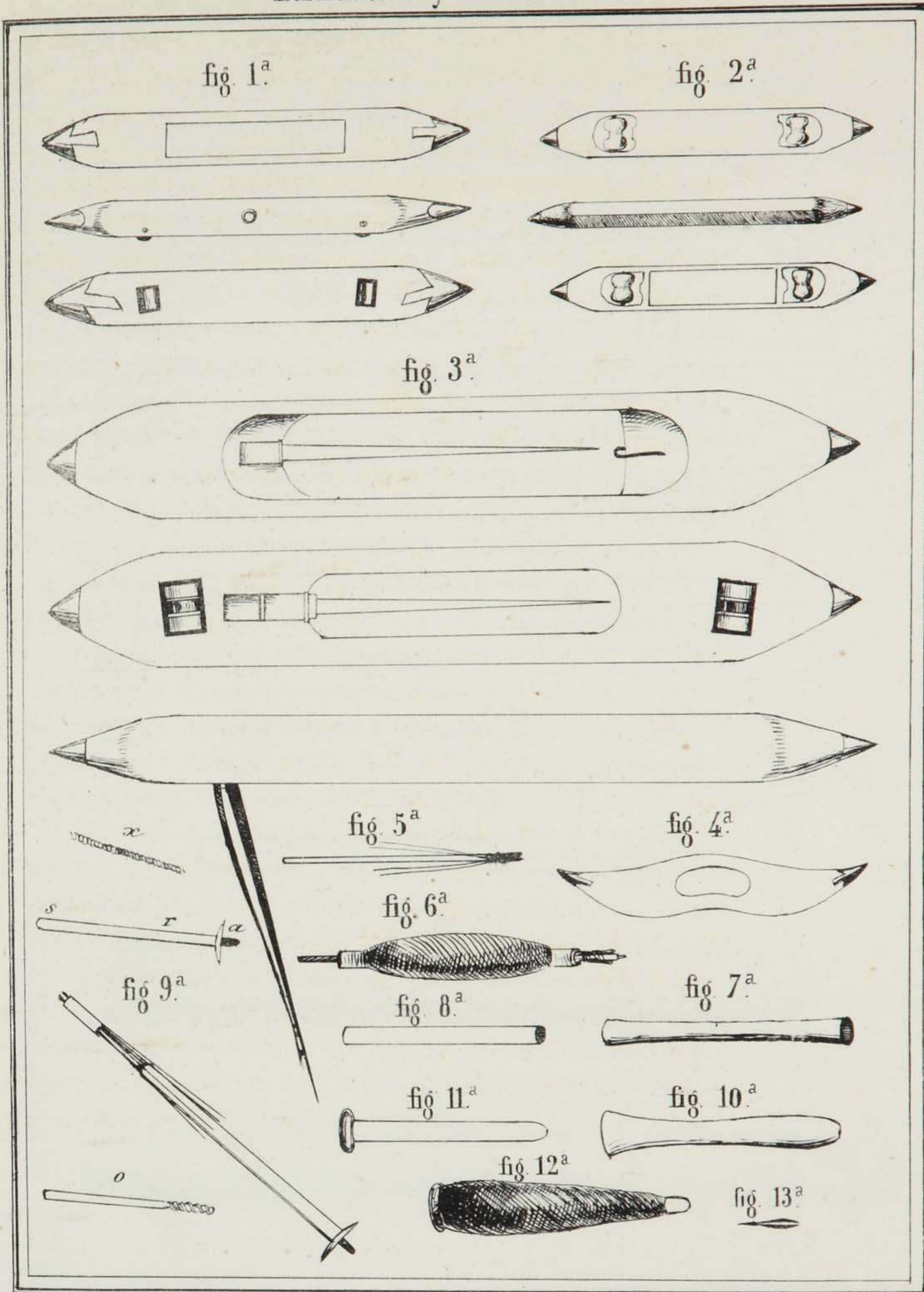


fig. 7<sup>a</sup>



UTENSILIOS.  
Lanzaderas y sus accesorios.

Lam. XXVI.



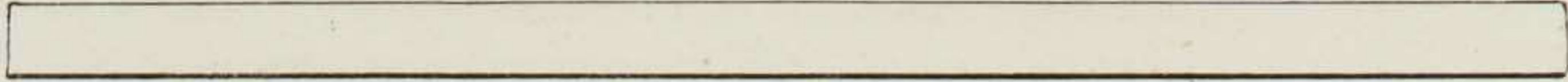
# UTENSILIOS

## Puas, templadores y plegadores.

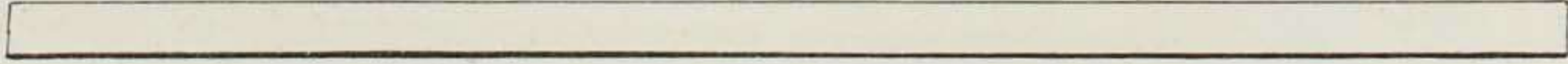
*Lam. XXVII.*

fig. 1<sup>a</sup>

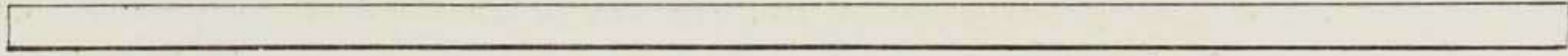
Nº 1. Para tej. de velas.



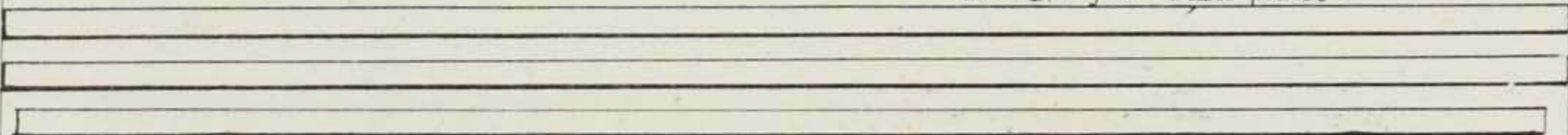
Nº 2. id.



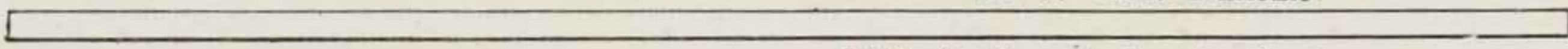
Nº 3. id.



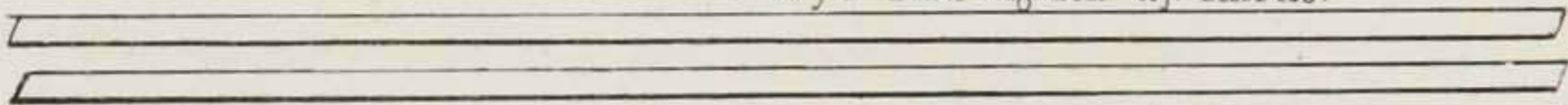
Nº 4, 5 y 6 Para paños.



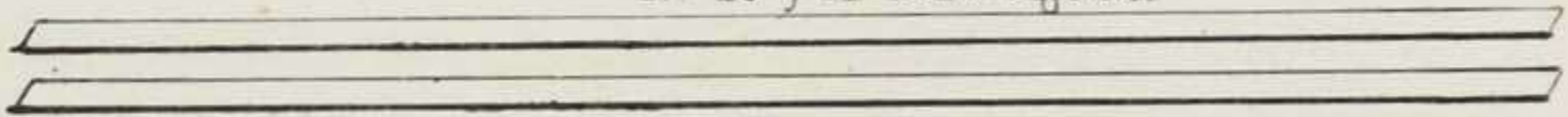
Nº 7. Para franelas.



Nº 8 y 9 Para algodón tej. fuertes.



Nº 10 y 11 Para algodón



Nº 12 y 13 Para seda.

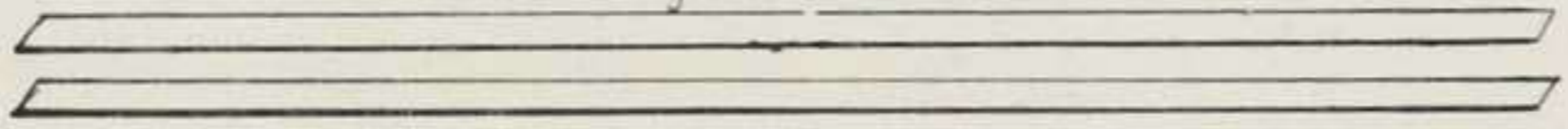


fig. 7<sup>a</sup>



fig. 6<sup>a</sup>



fig. 2<sup>a</sup>

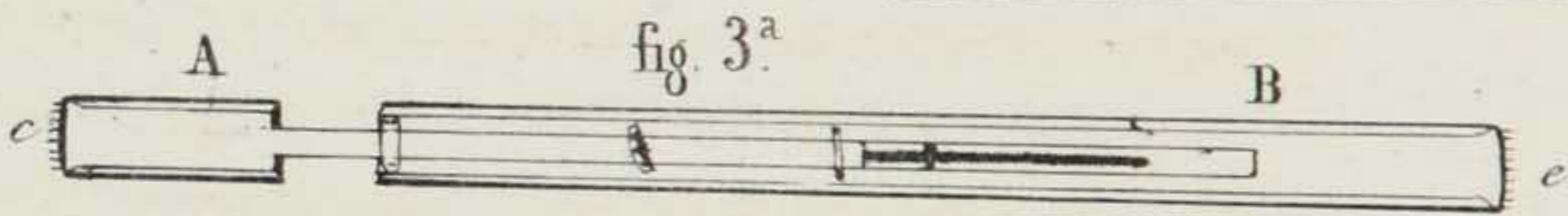


fig. 3<sup>a</sup>

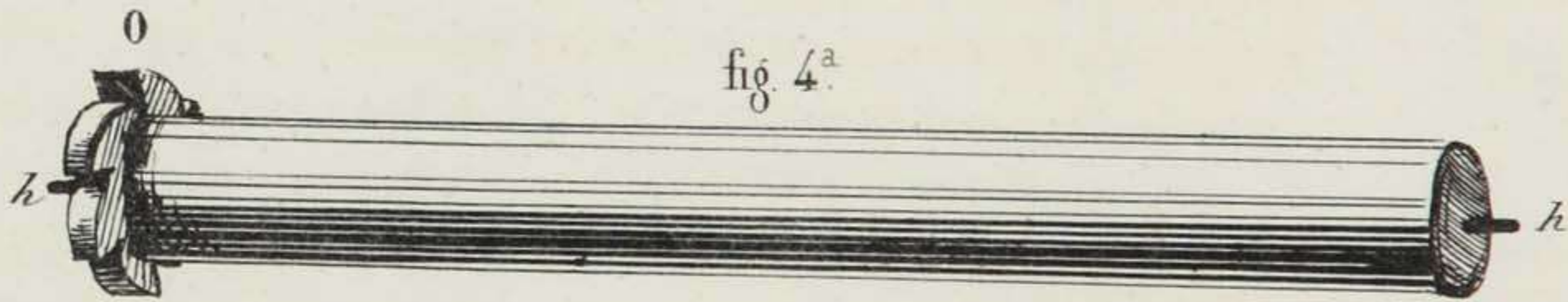
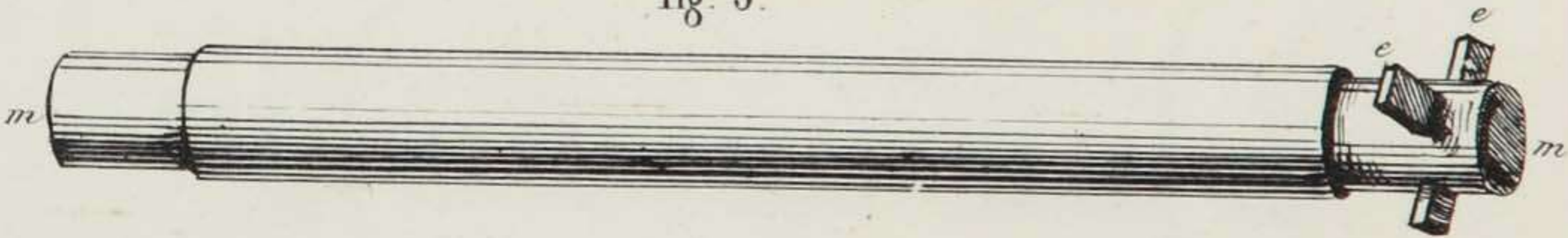


fig. 4<sup>a</sup>

fig. 5<sup>a</sup>



UTENSILIOS  
Plegadores.

Lam. XXVIII.

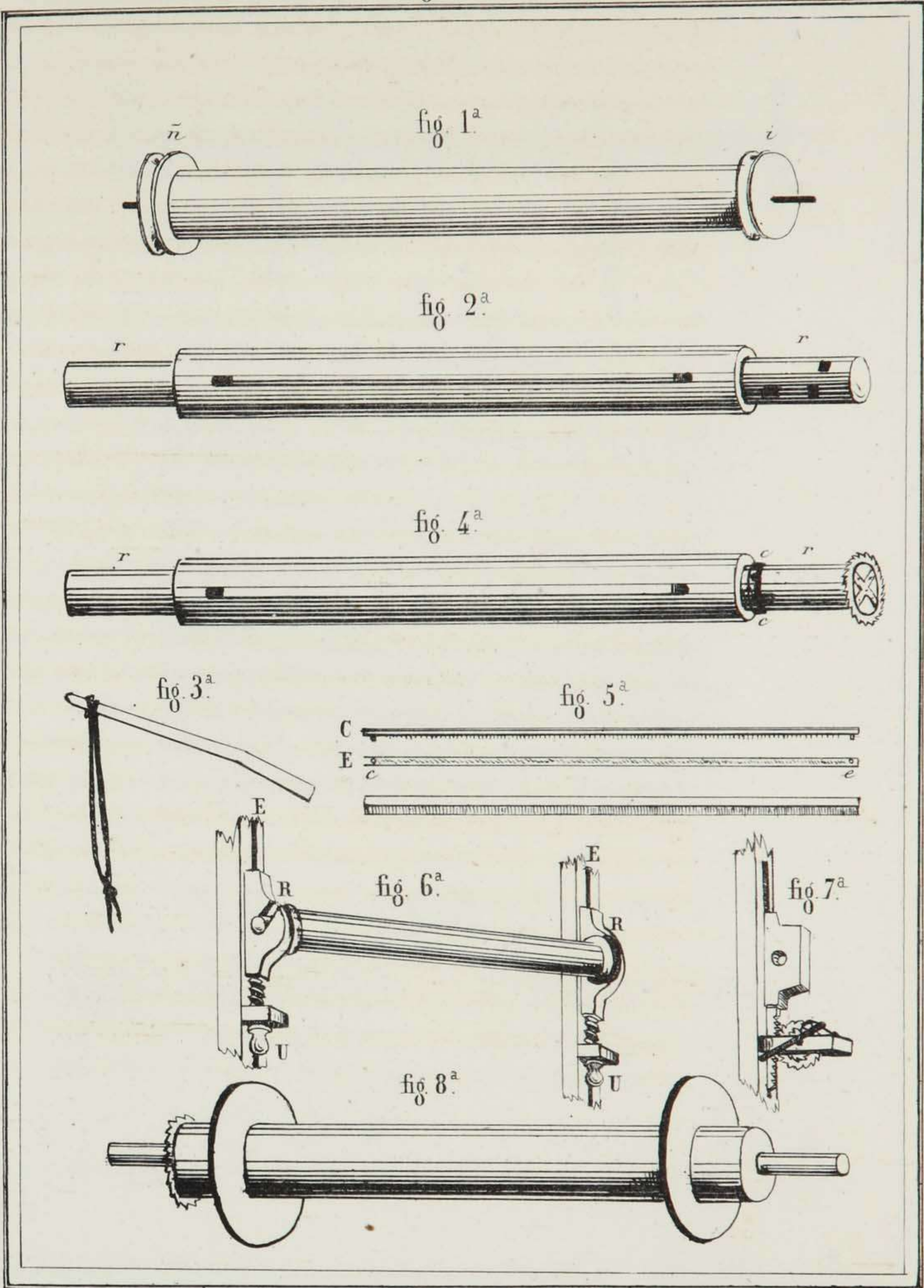


Fig 1<sup>a</sup>

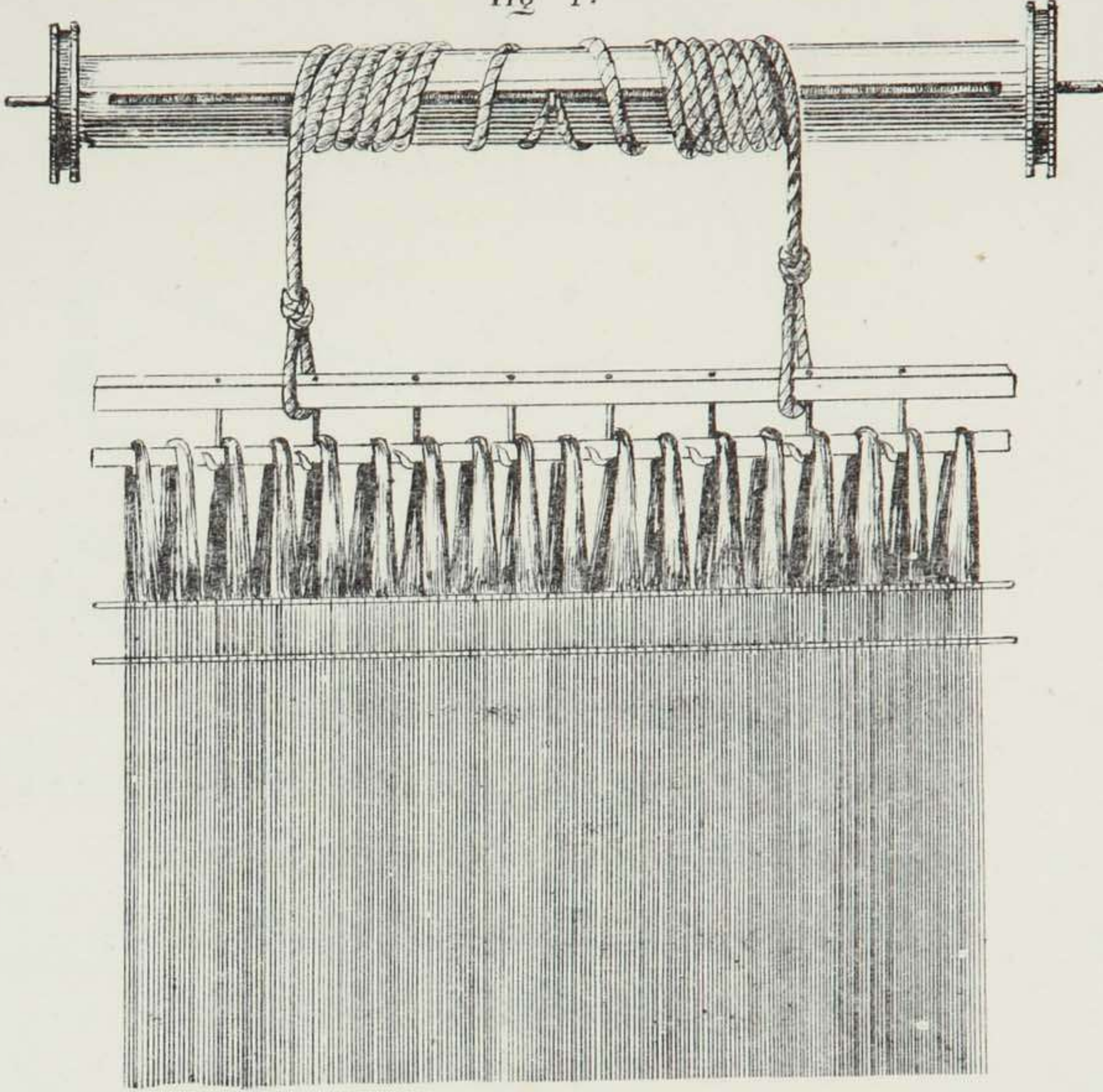


Fig 2<sup>a</sup>



Fig 3<sup>a</sup>

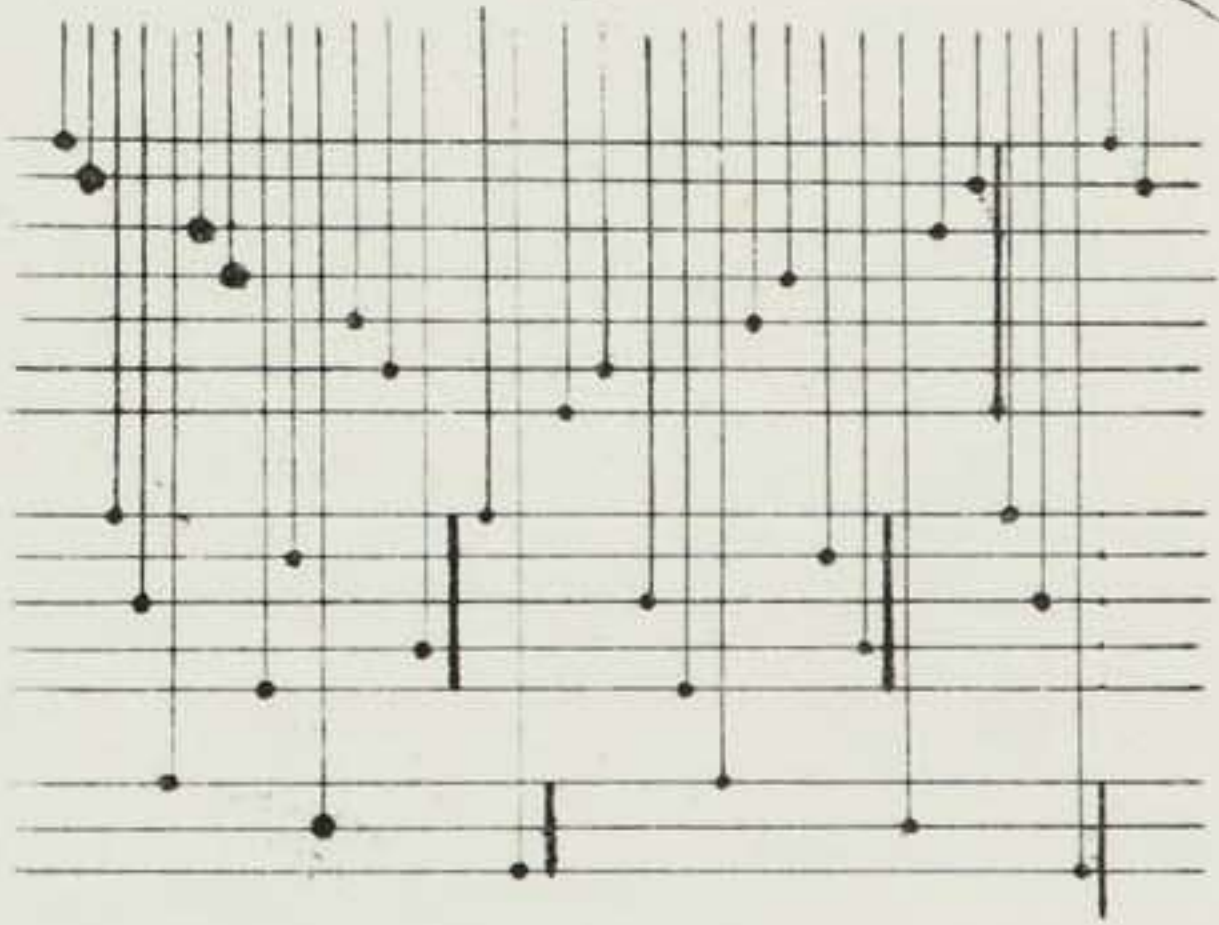
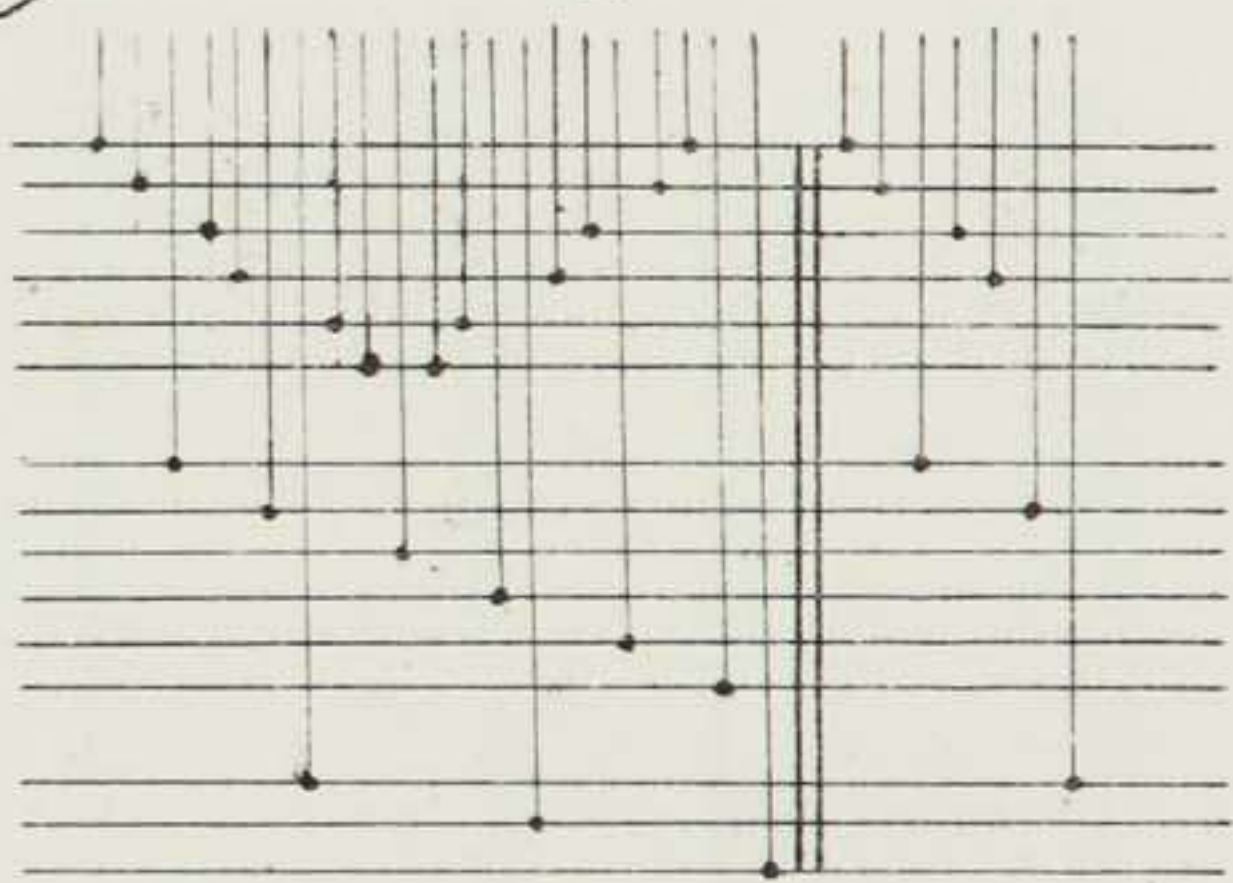
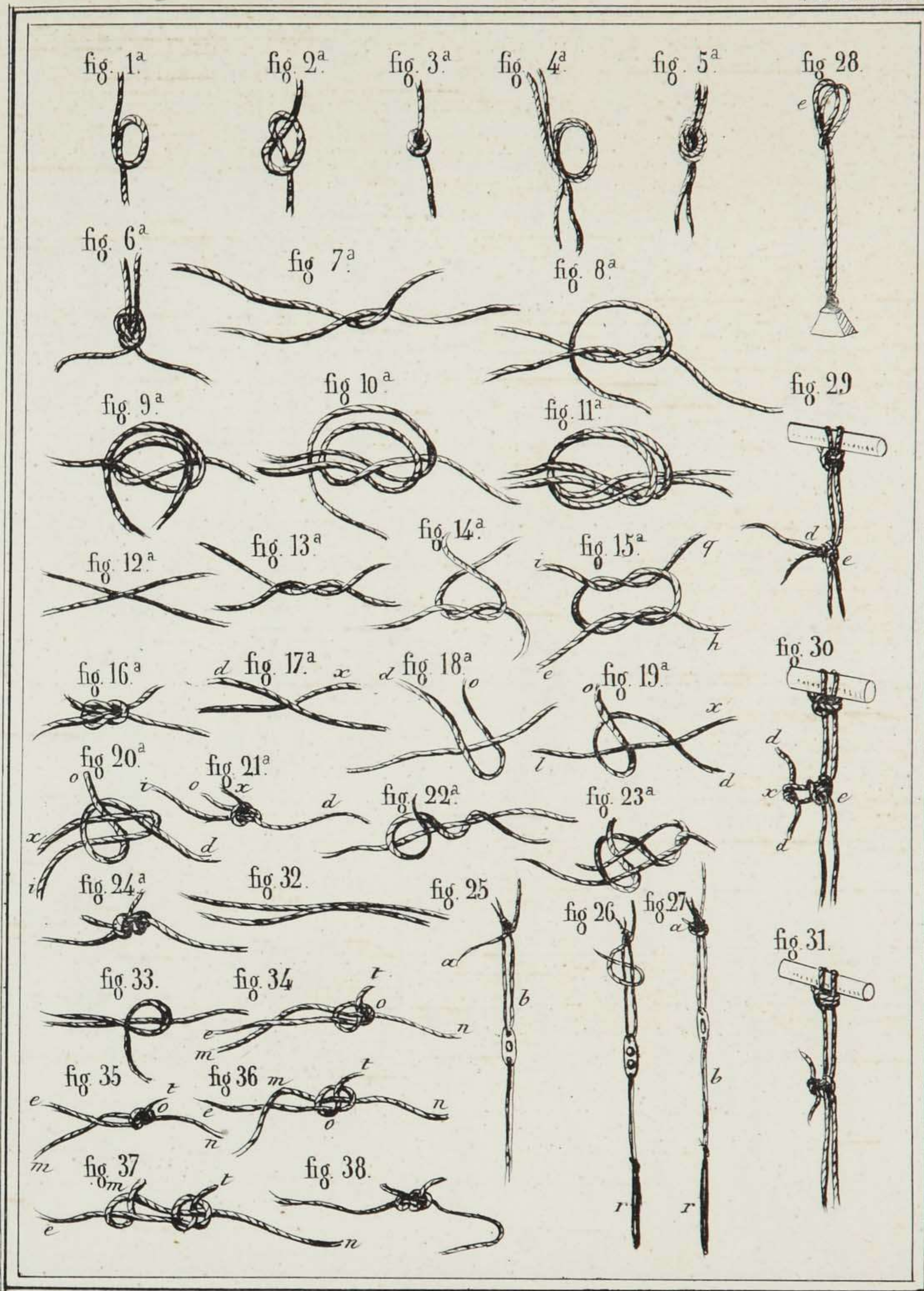


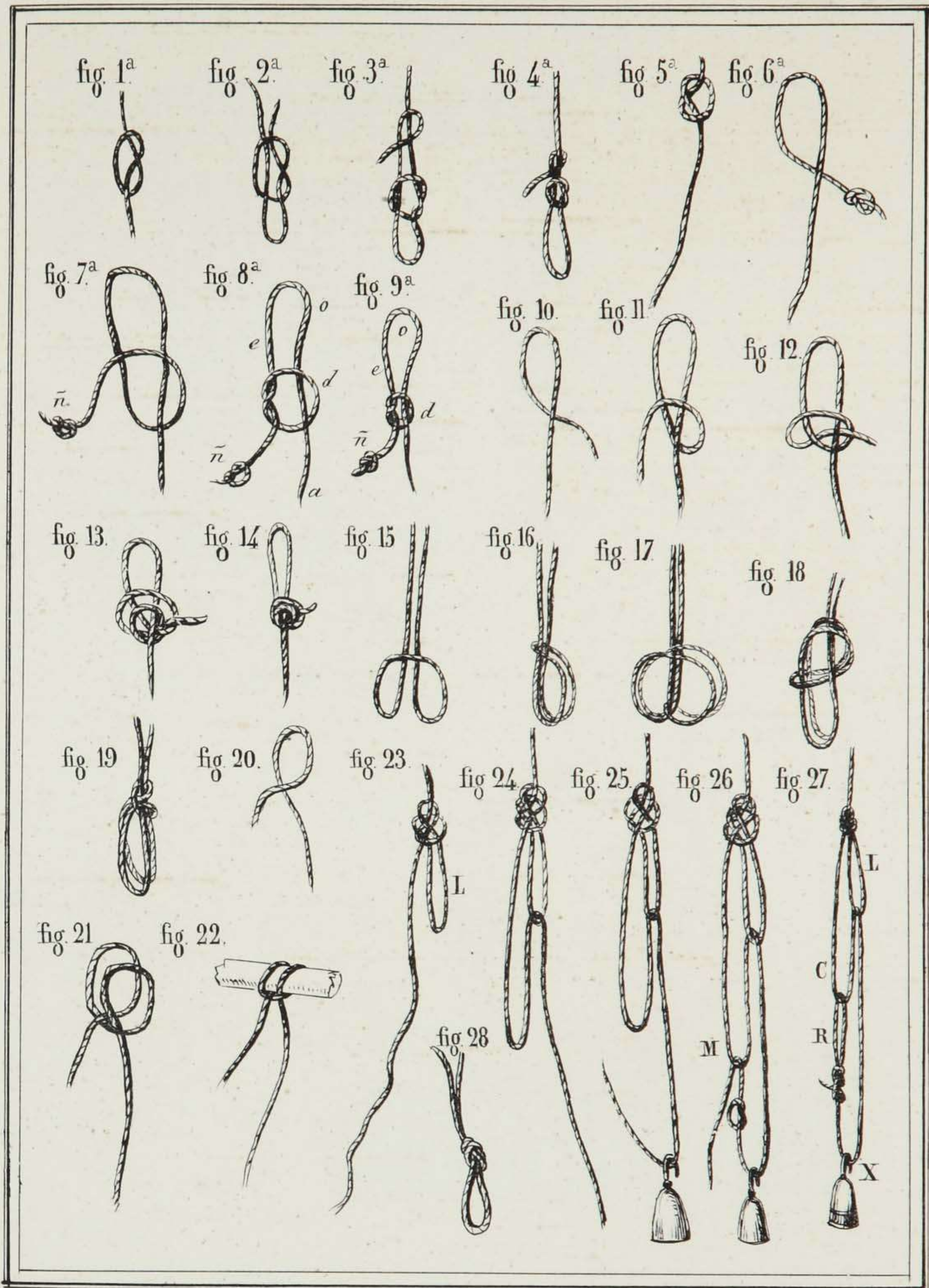
Fig 4<sup>a</sup>



Nudos y los varios tiempos de su formacion.

Lam. XXX.

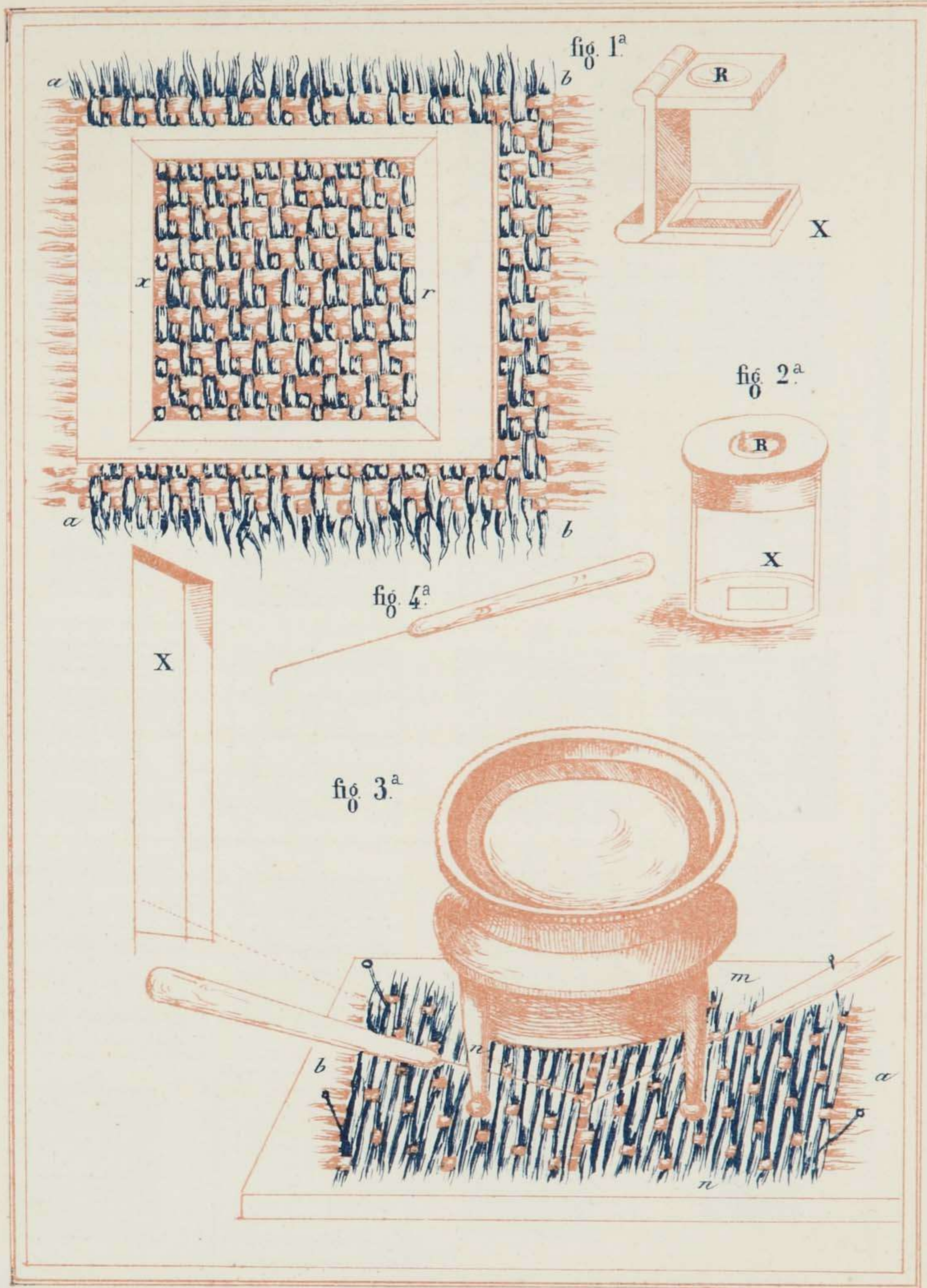


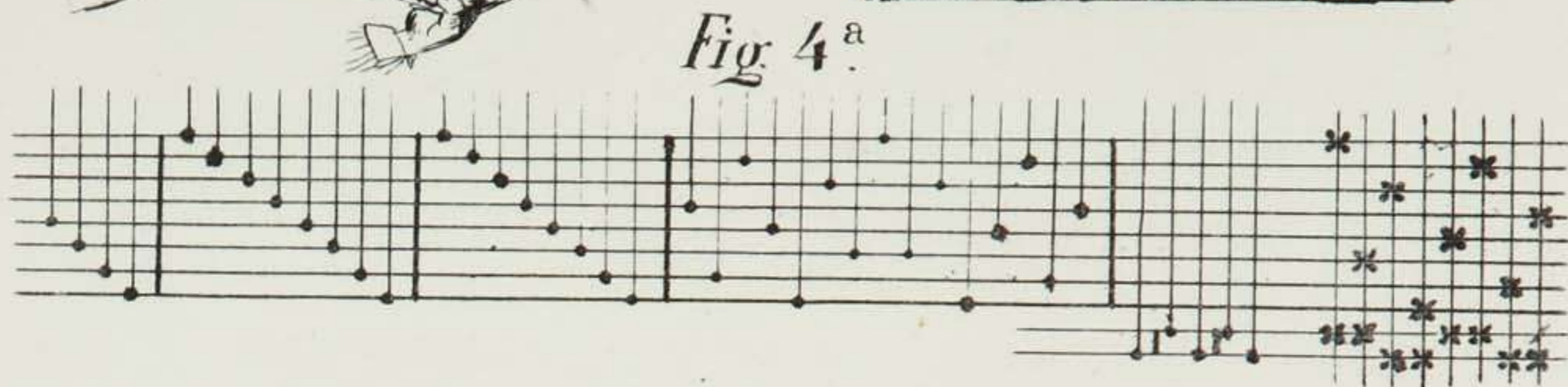
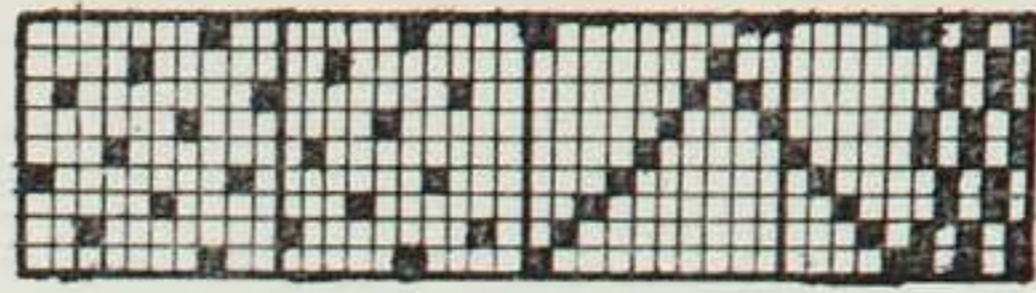
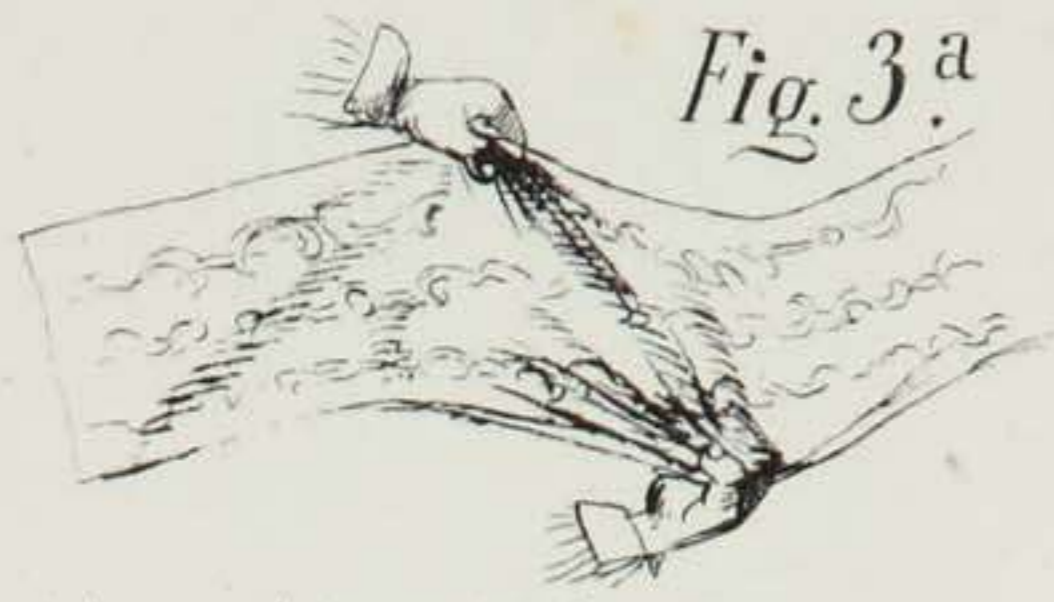




ANÁLISIS  
Lentes, cuenta hilos &c.

Lam. XXXII.





1	2	6	7
8	9	10	11
12	13	14	15
16	17	18	19

ANÁLISIS

Ligamientos derivados de los fundamentales.

Lam XXXIV.

fig 1<sup>a</sup>

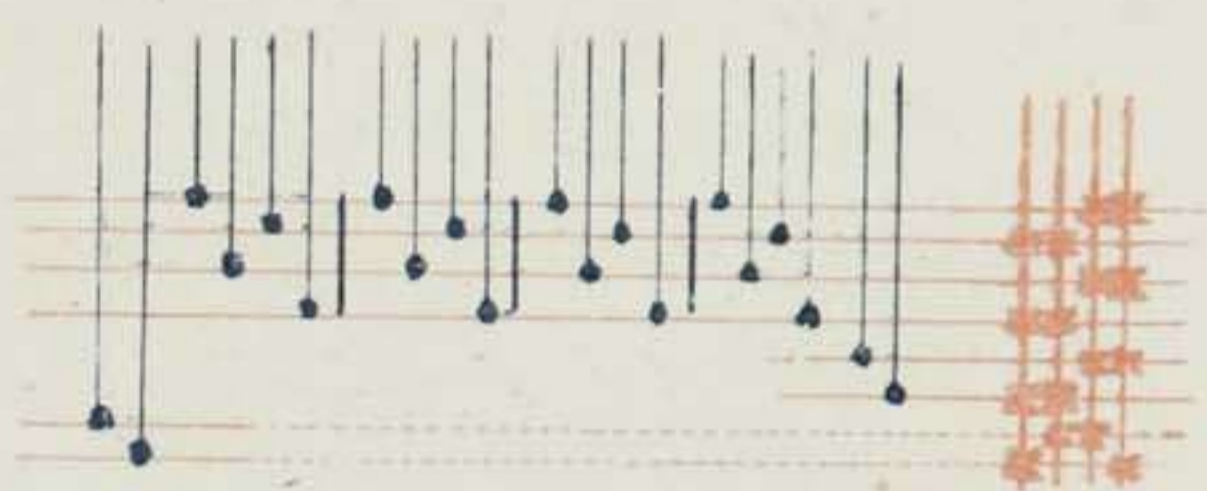
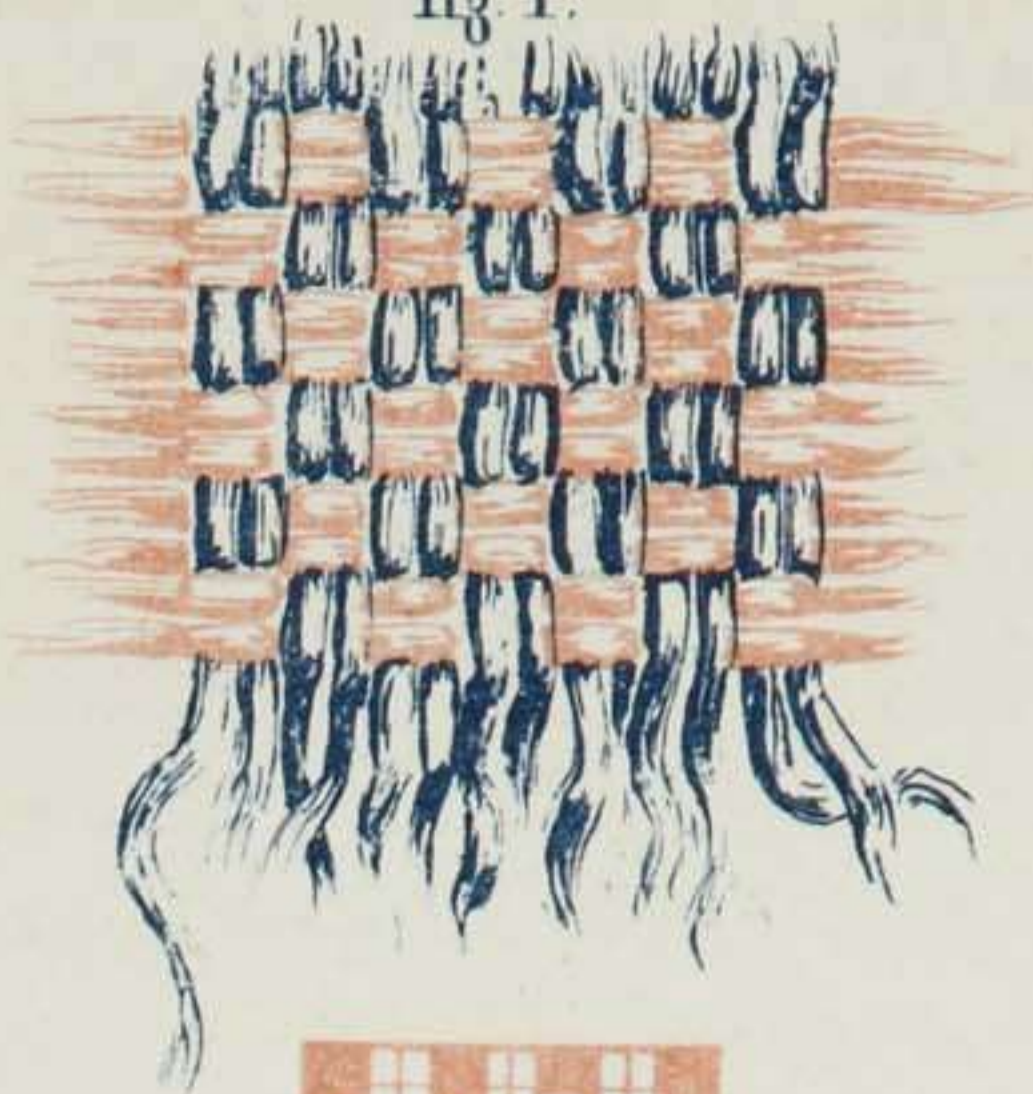


fig 3<sup>a</sup>

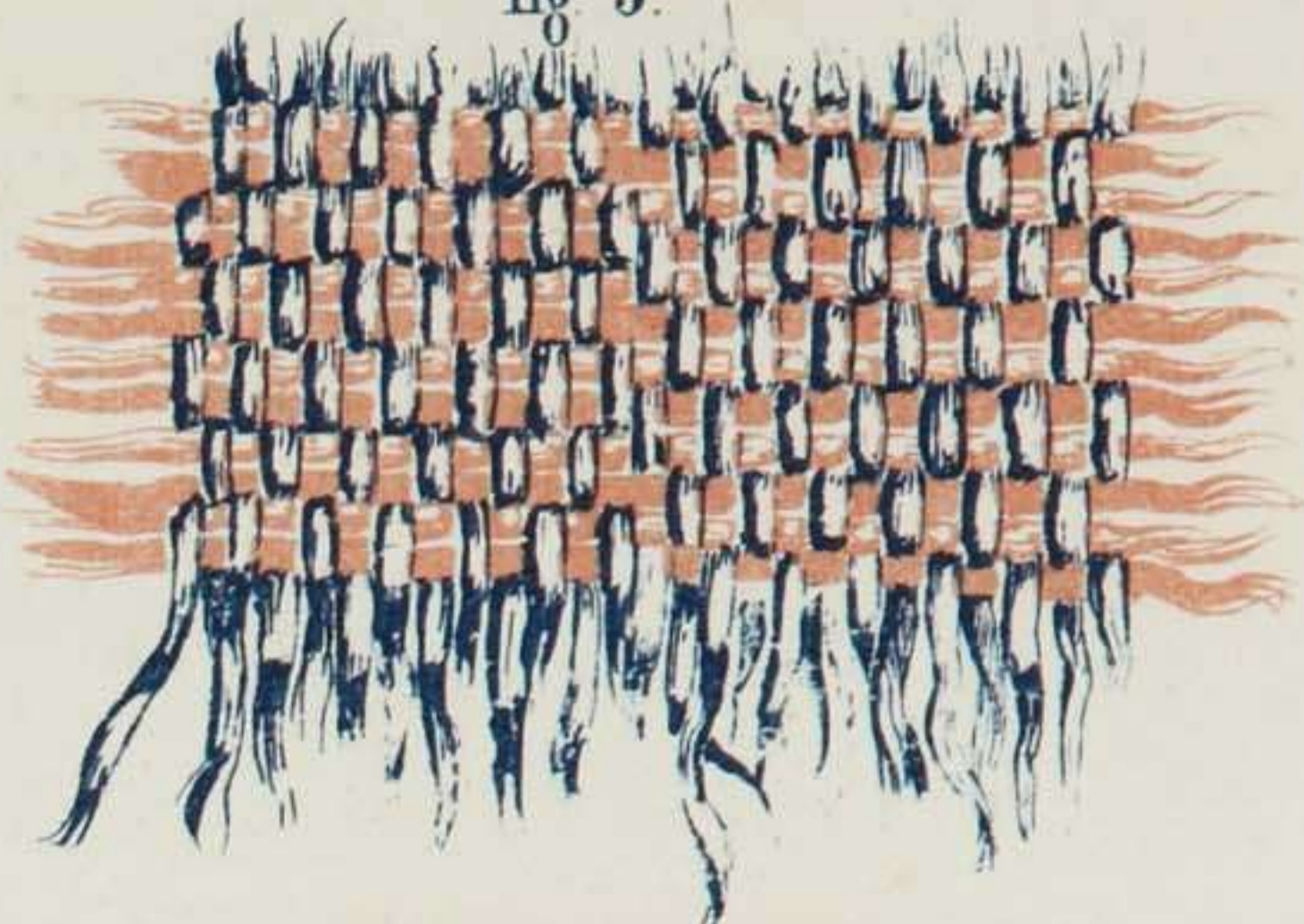


fig 2<sup>a</sup>

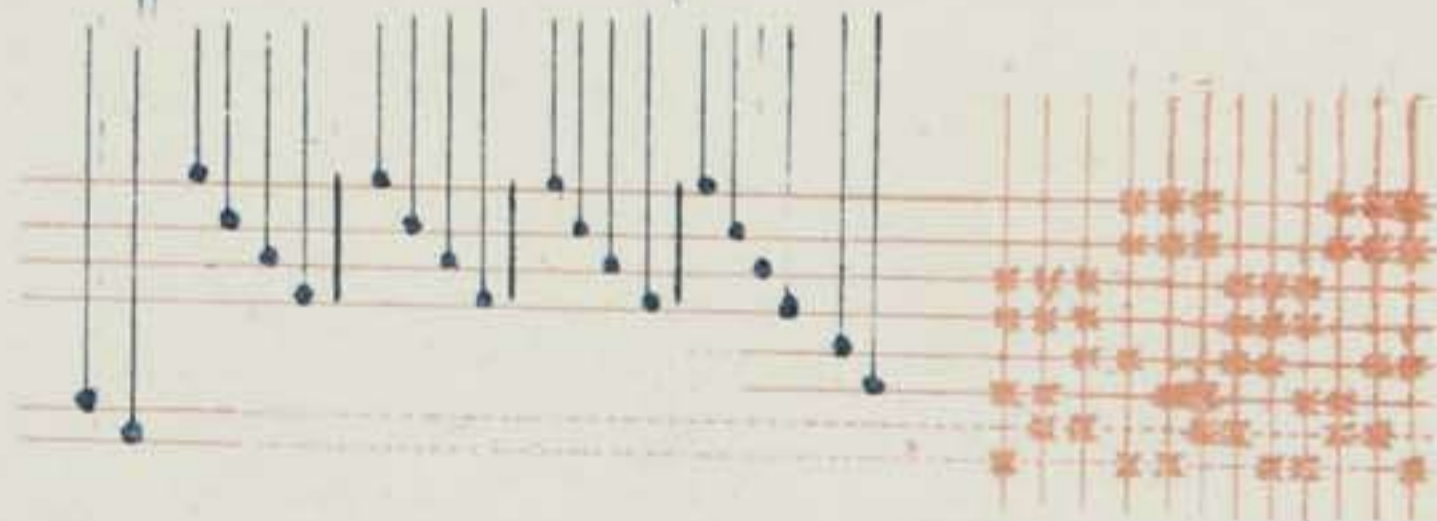
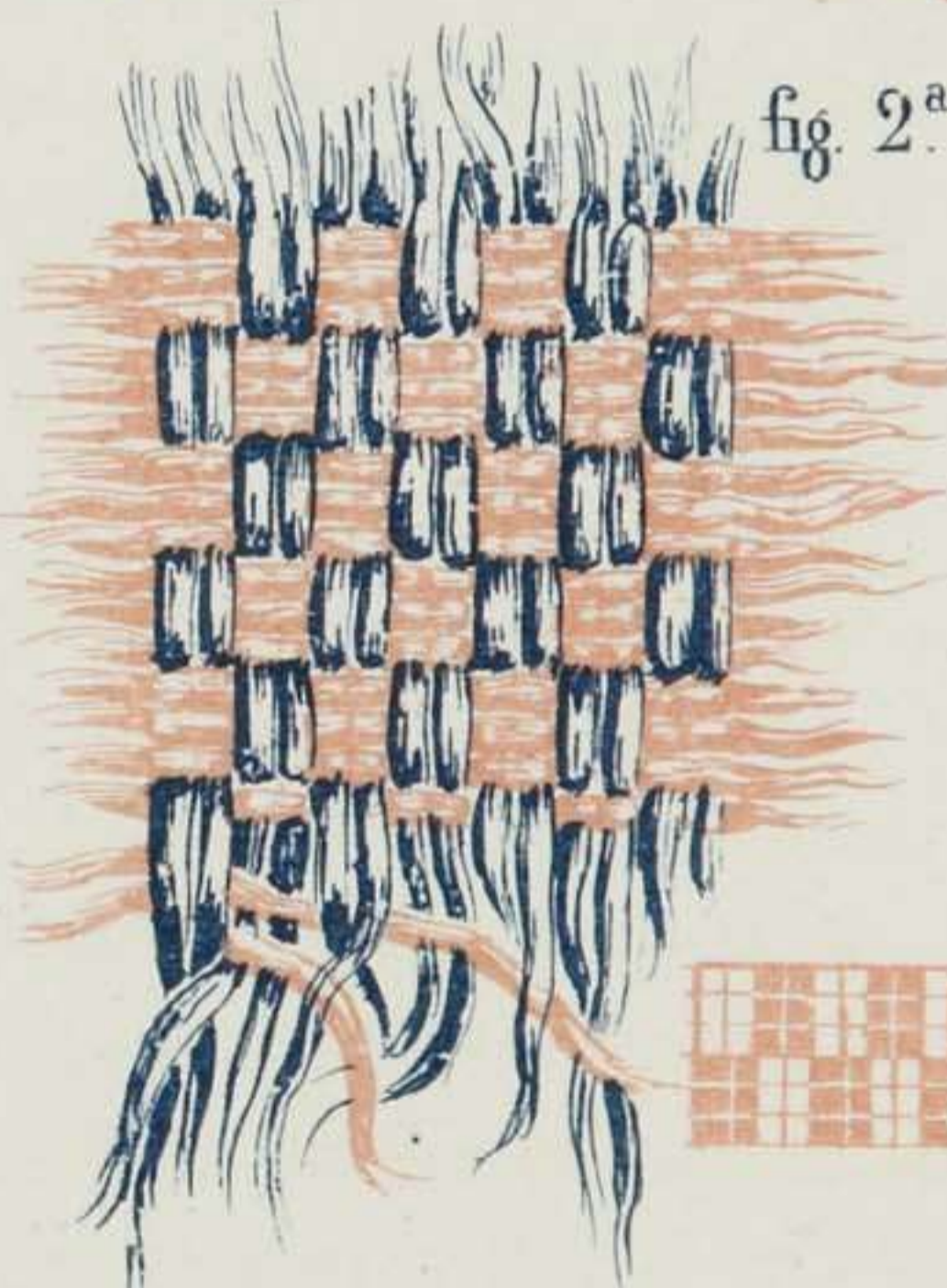
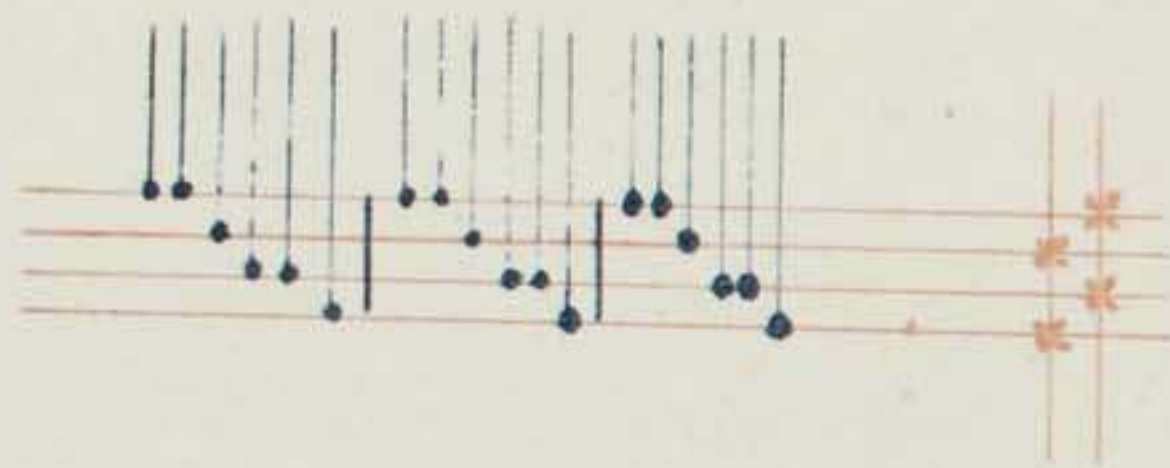
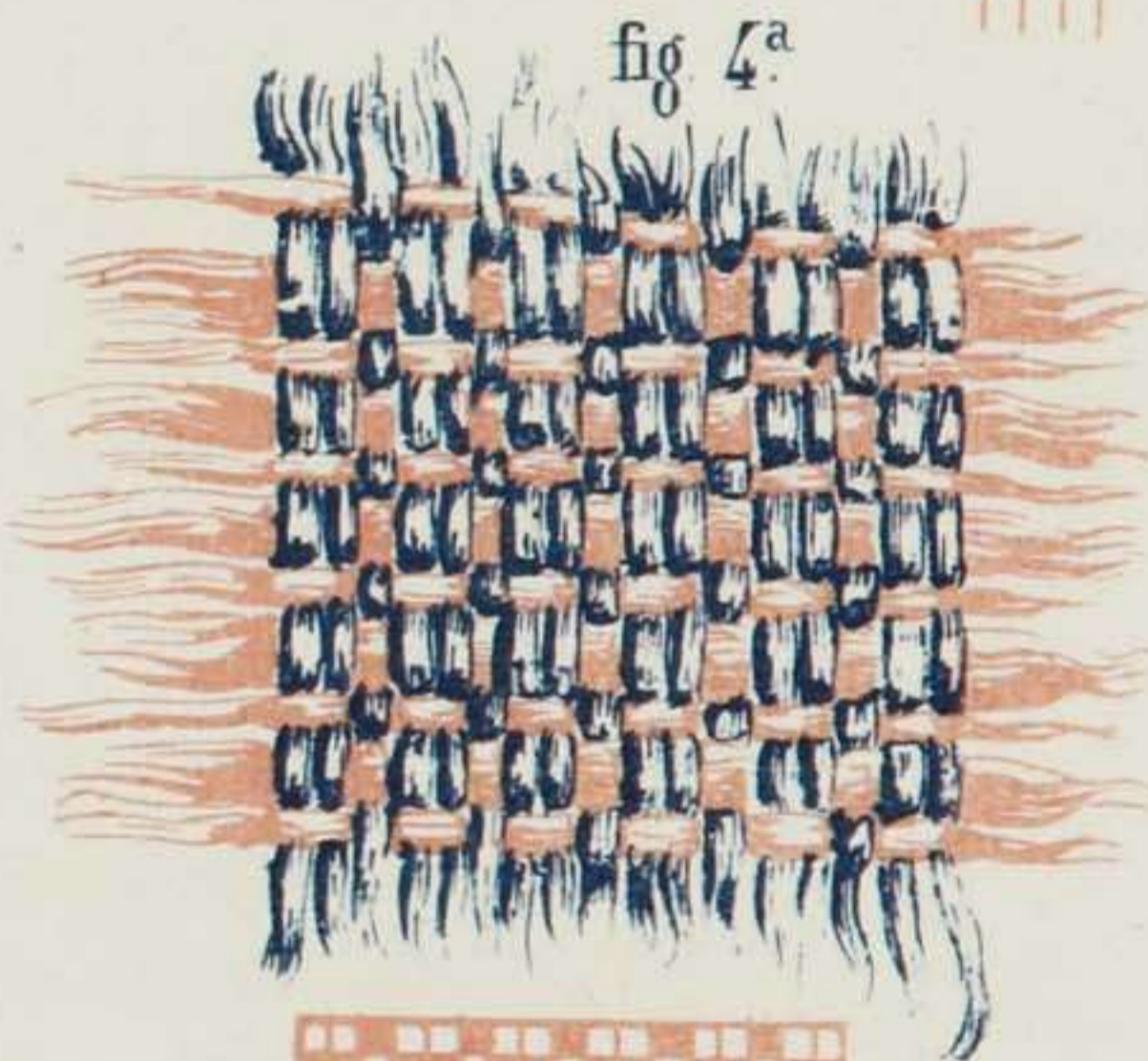


fig 4<sup>a</sup>

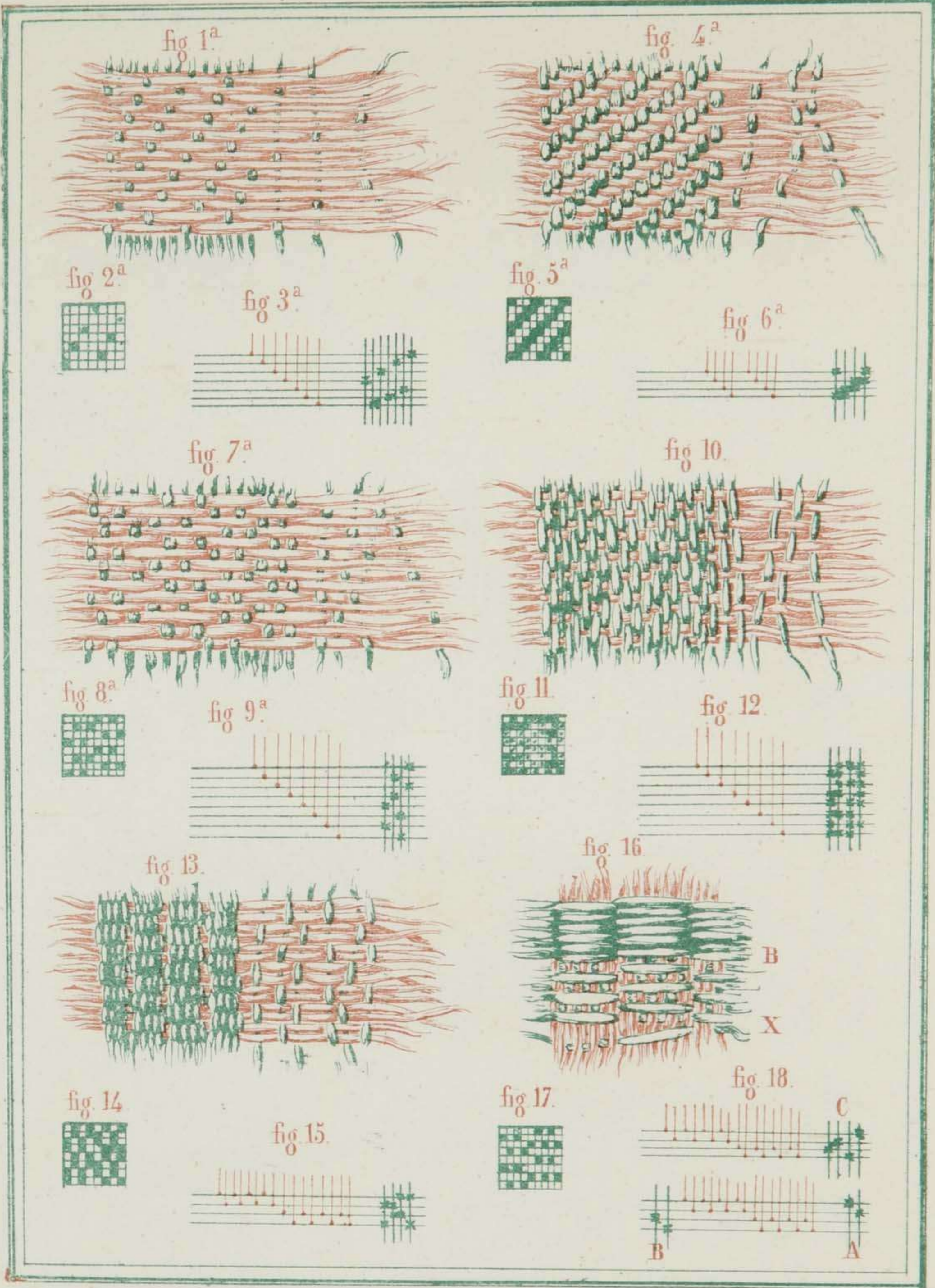


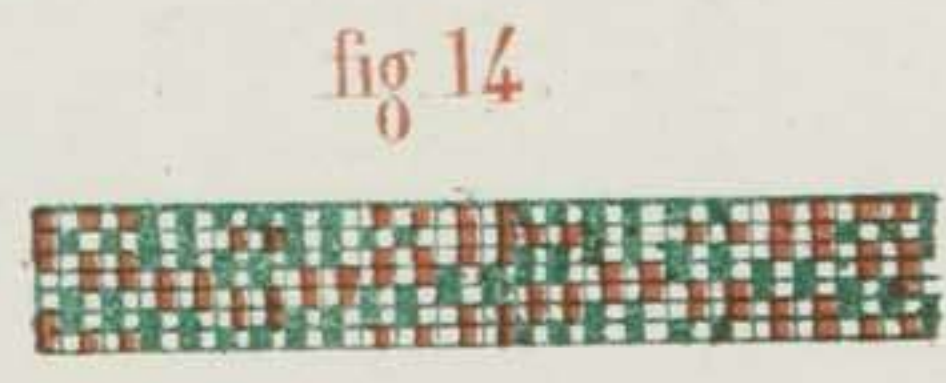
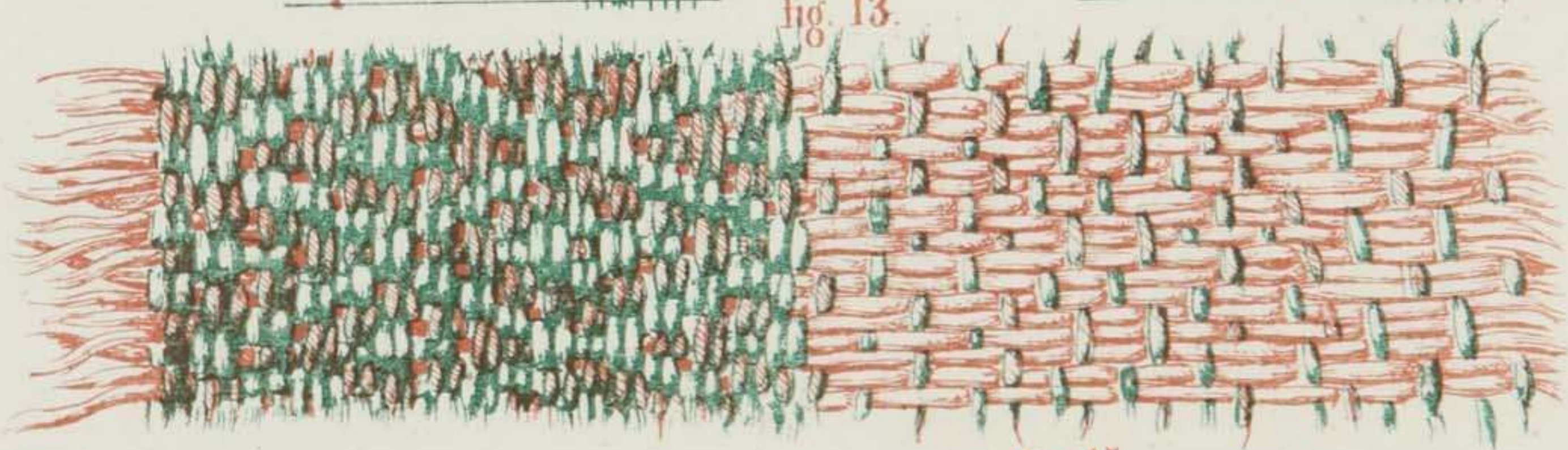
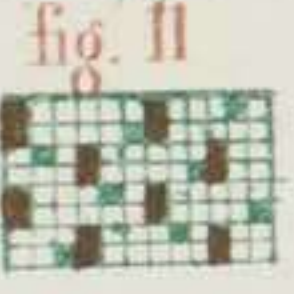
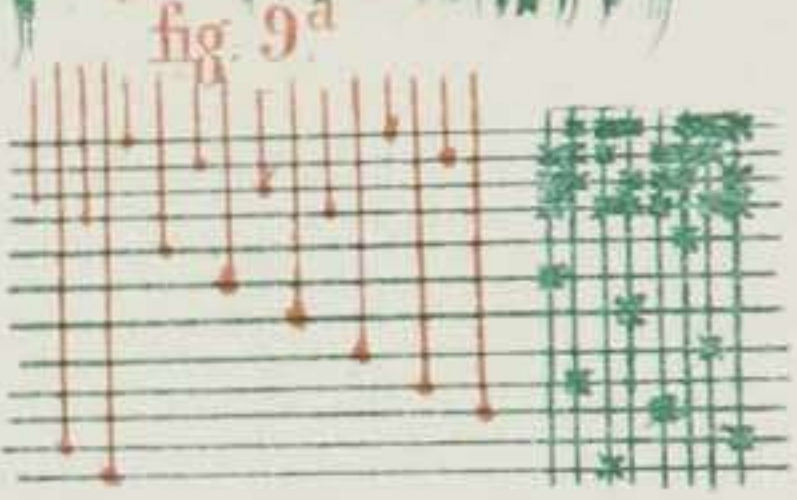
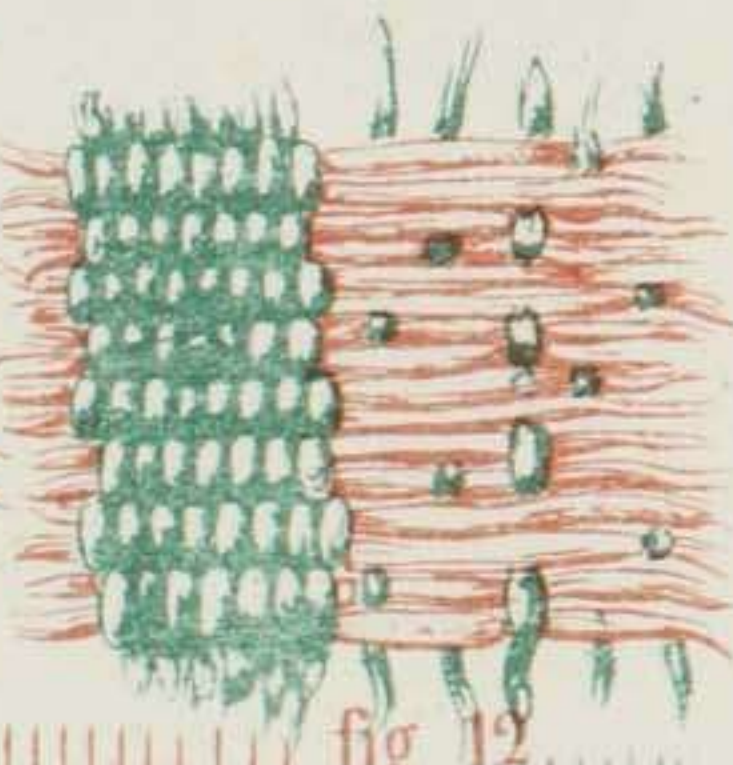
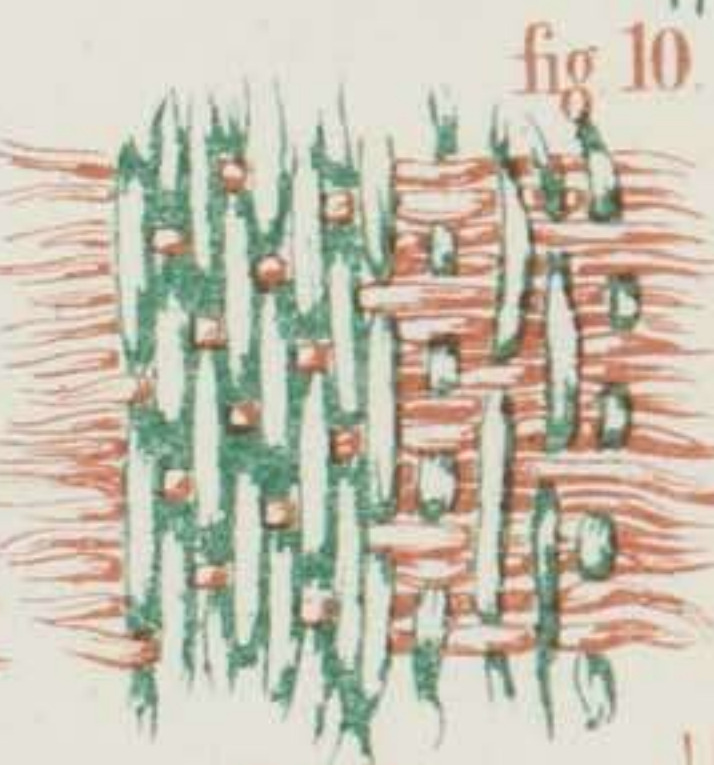
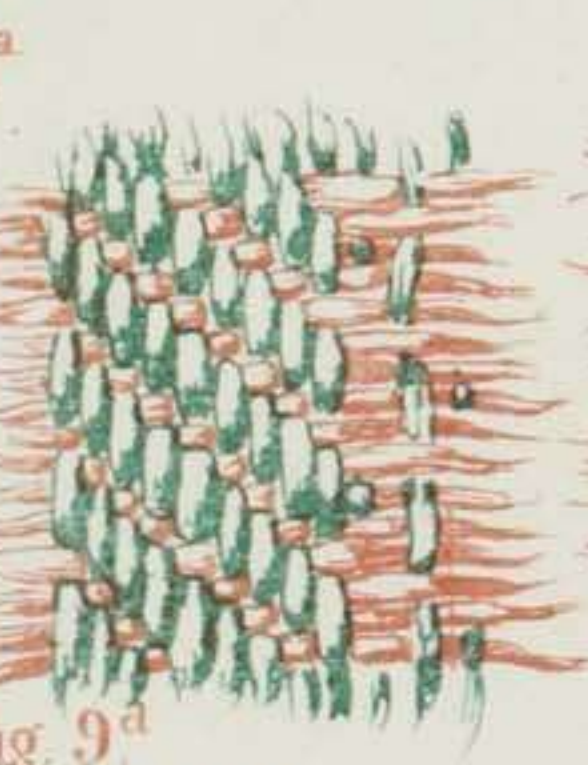
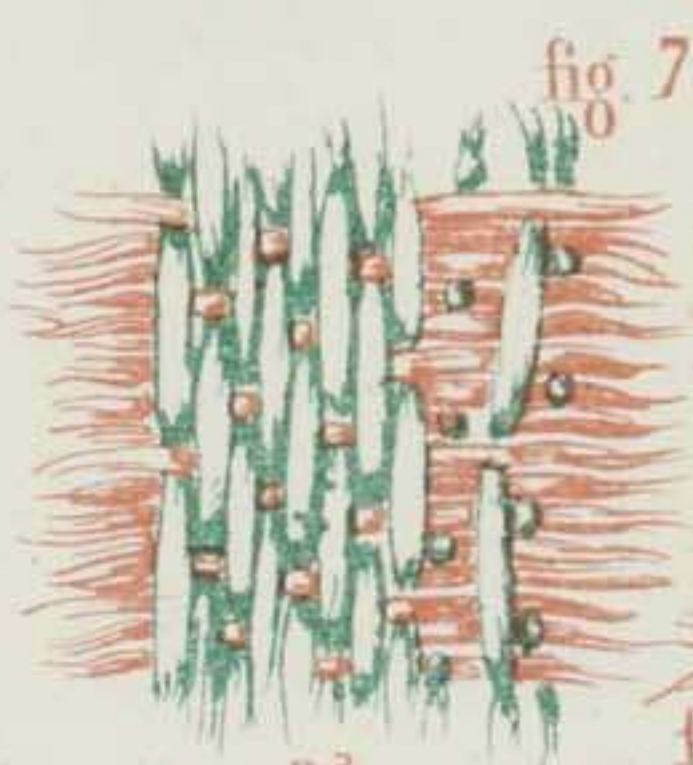
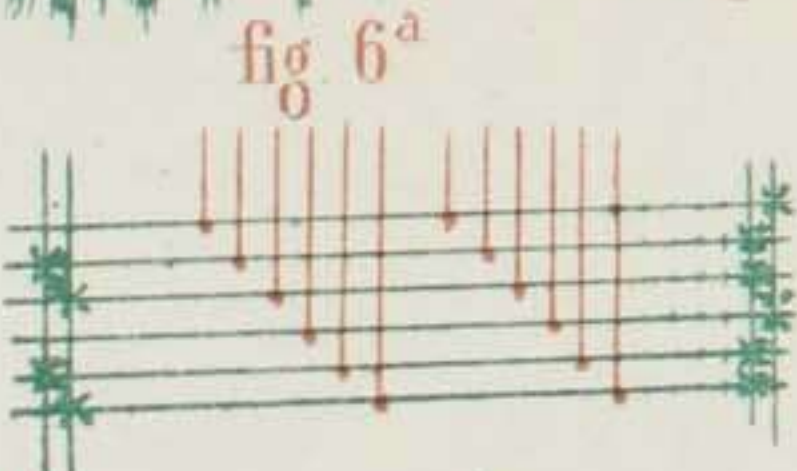
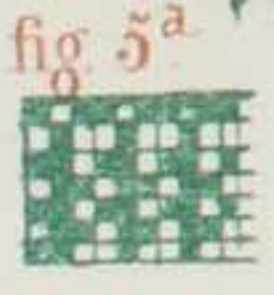
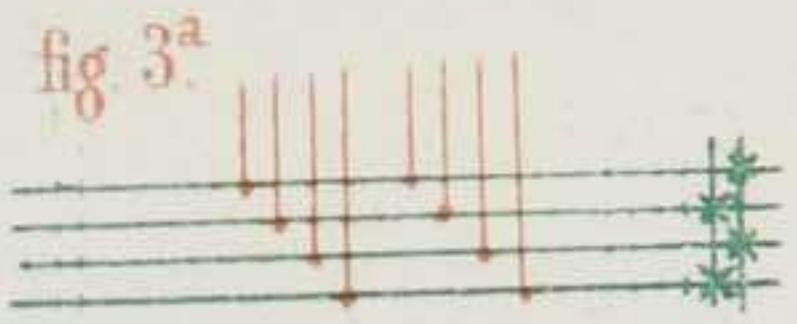
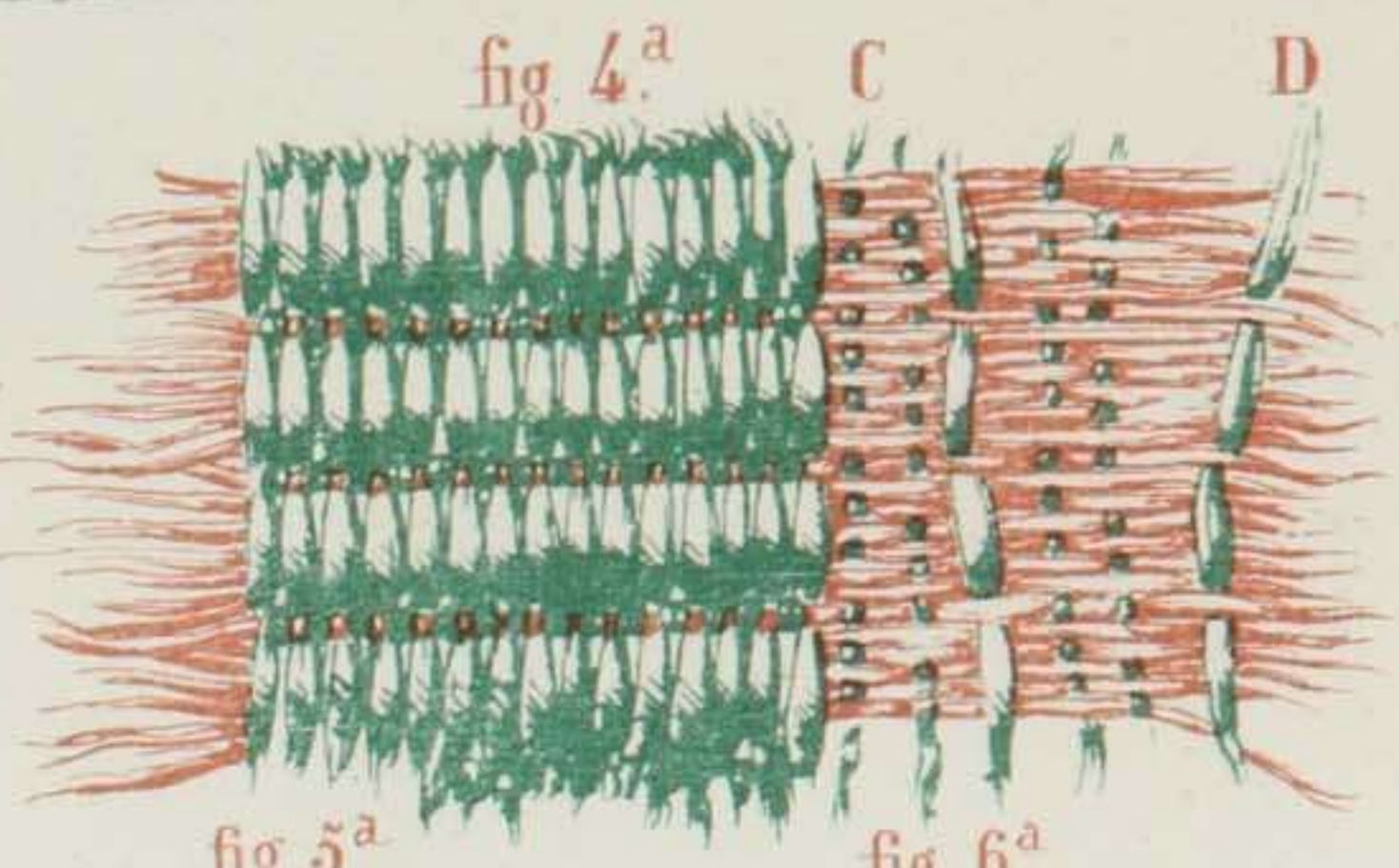
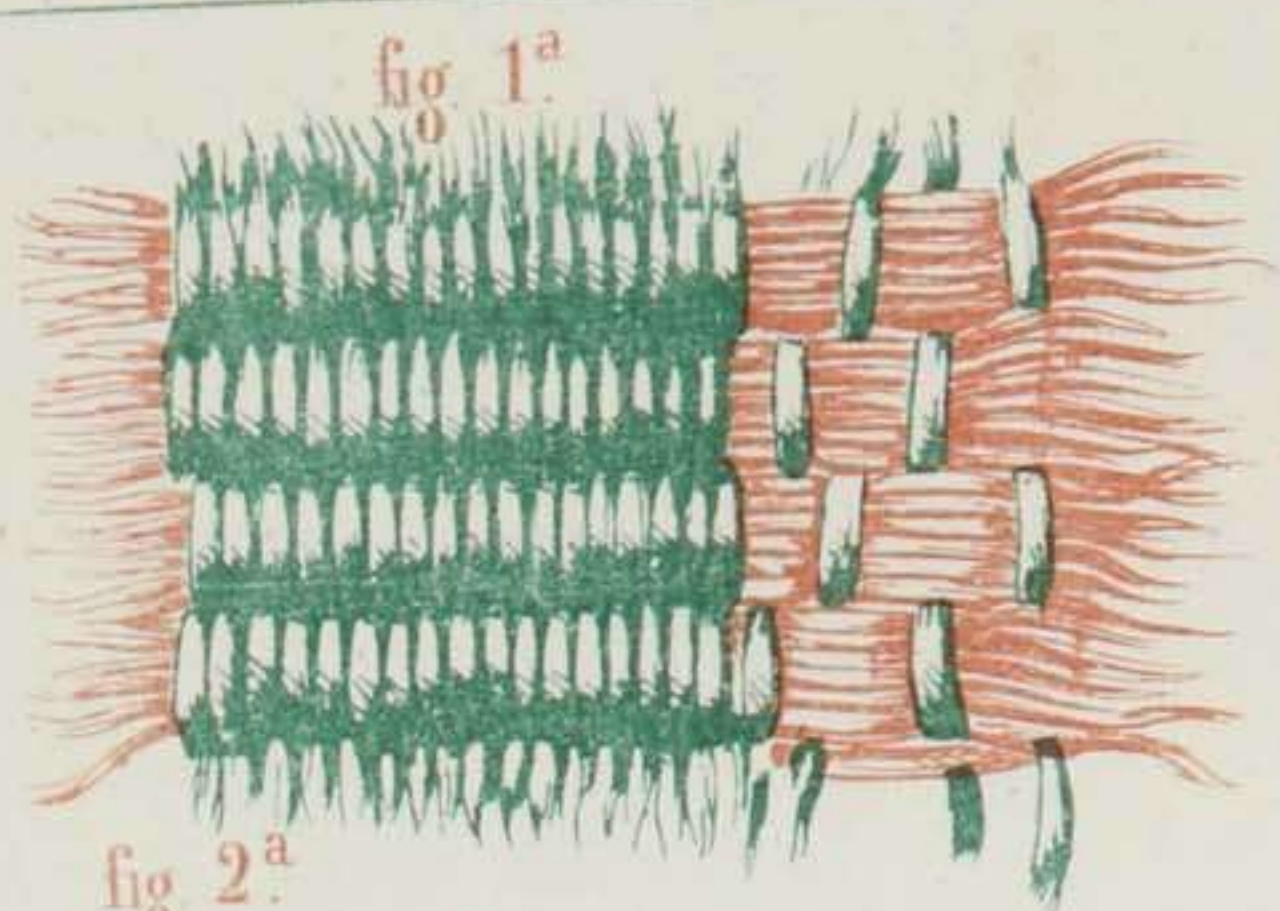
Ligamientos y disposiciones.

Lam. XXXV.

The page contains 23 numbered figures, each illustrating a specific musical ligament or disposition. Each figure is composed of two parts: a musical staff with notes and a grid pattern of black and white squares. The figures are arranged in two columns, with the right column containing more figures than the left. The figures are labeled as follows:

- Fig. 1<sup>a</sup>
- Fig. 2<sup>a</sup>
- Fig. 3<sup>a</sup>
- Fig. 4<sup>a</sup>
- Fig. 5<sup>a</sup>
- Fig. 6<sup>a</sup>
- Fig. 7<sup>a</sup>
- Fig. 8<sup>a</sup>
- Fig. 9<sup>a</sup>
- Fig. 10<sup>a</sup>
- Fig. 11<sup>a</sup>
- Fig. 12<sup>a</sup>
- Fig. 13<sup>a</sup>
- Fig. 14<sup>a</sup>
- Fig. 15<sup>a</sup>
- Fig. 16<sup>a</sup>
- Fig. 17<sup>a</sup>
- Fig. 18<sup>a</sup>
- Fig. 19<sup>a</sup>
- Fig. 20<sup>a</sup>
- Fig. 21<sup>a</sup>
- Fig. 22<sup>a</sup>
- Fig. 23<sup>a</sup>





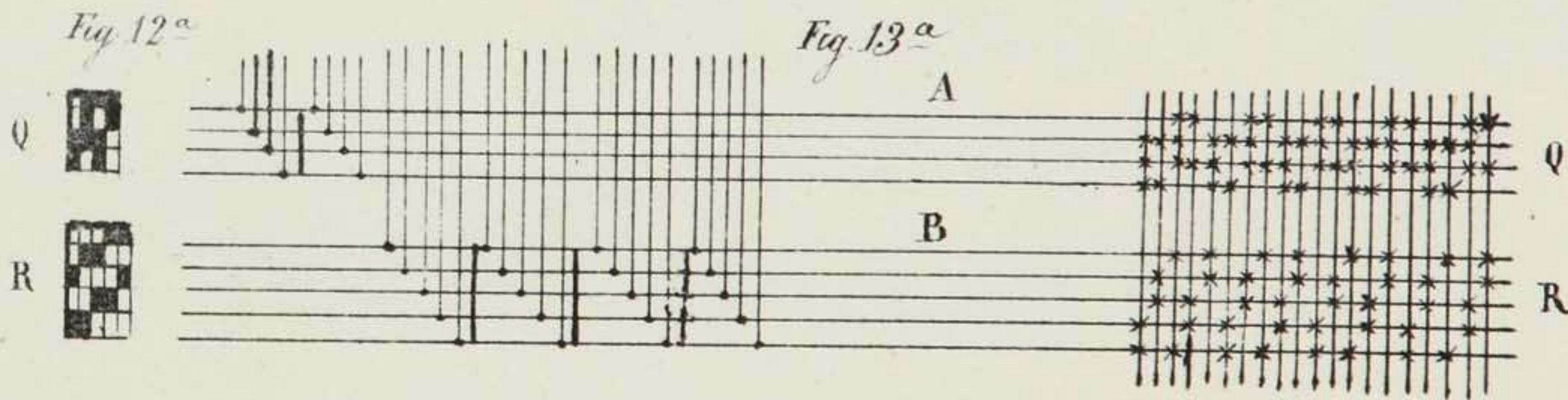
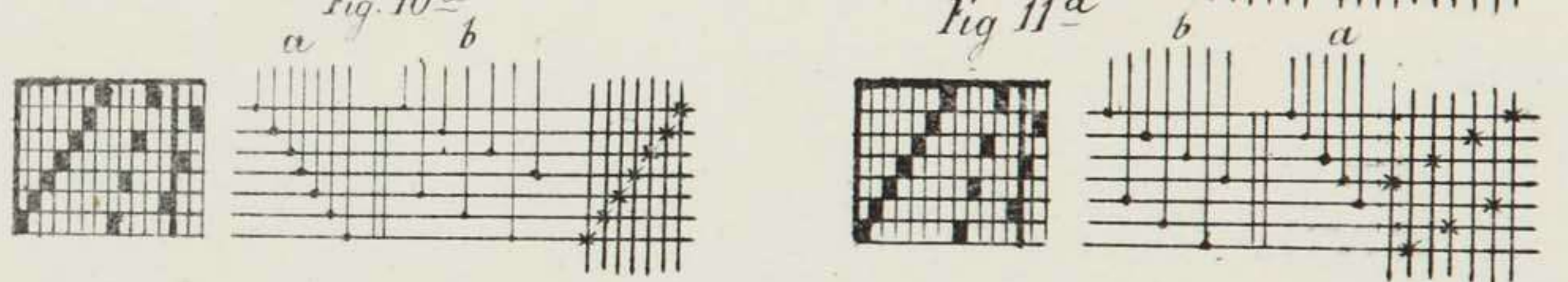
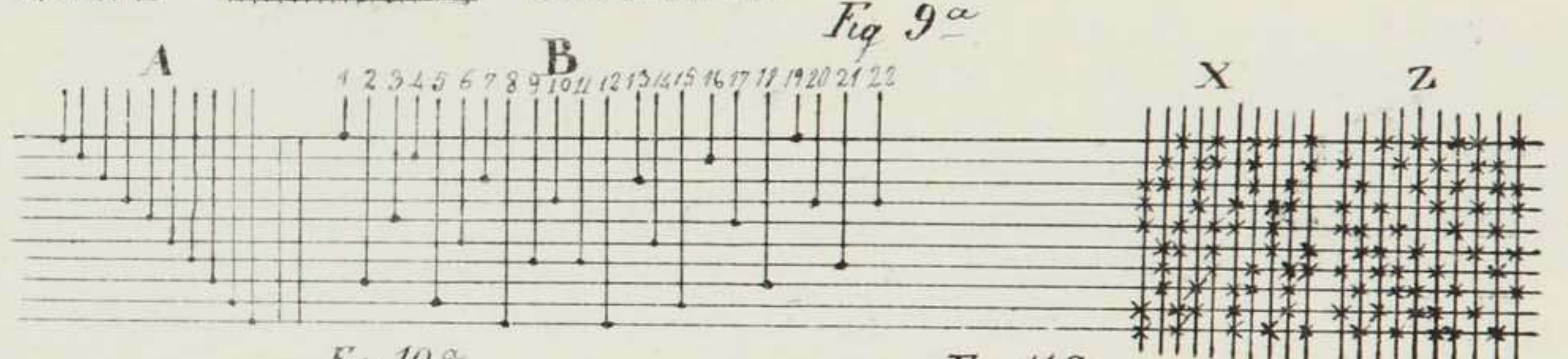
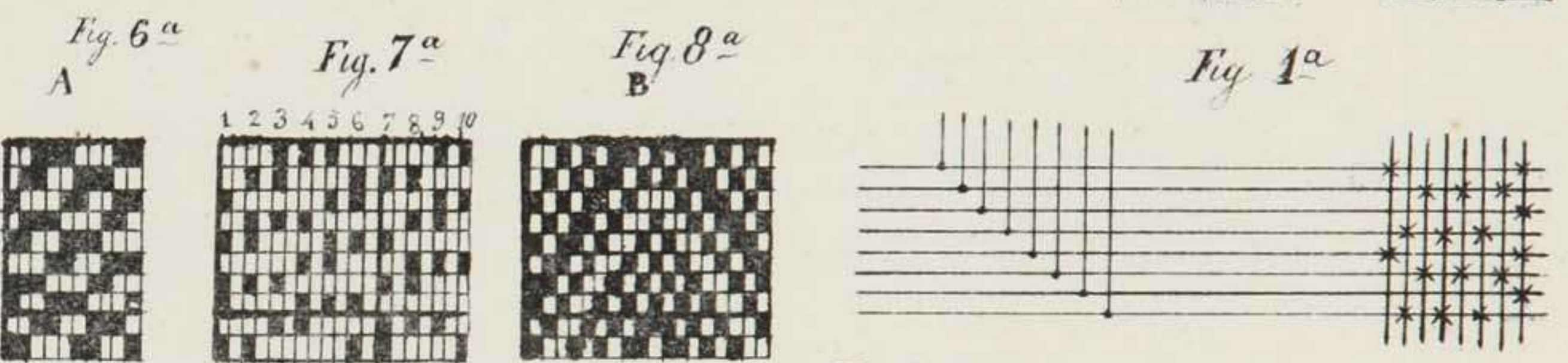
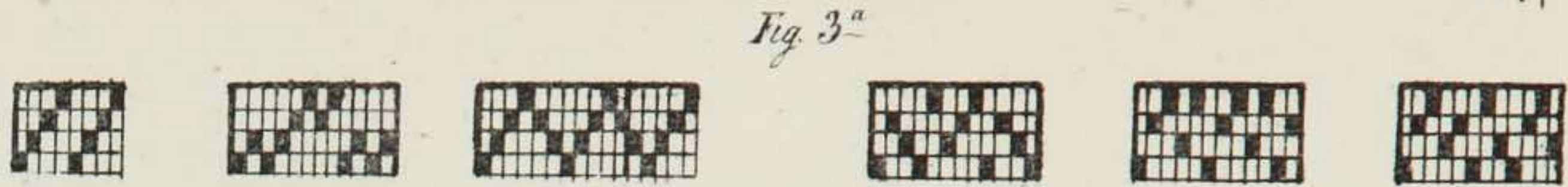


fig. 1<sup>a</sup>

fig. 2<sup>a</sup>

fig. 3<sup>a</sup>

fig. 4<sup>a</sup>

fig. 5<sup>a</sup>

fig. 6<sup>a</sup>

fig. 7<sup>a</sup>

fig. 8<sup>a</sup>

fig. 9<sup>a</sup>

fig. 10<sup>a</sup>

fig. 11<sup>a</sup>

fig. 12<sup>a</sup>

fig. 13<sup>a</sup>

fig. 14<sup>a</sup>

fig. 15<sup>a</sup>

L

C

B

e

D

T

S

E

G

R

O

a

b

c

m

n

rep. de 8 cur. mas.

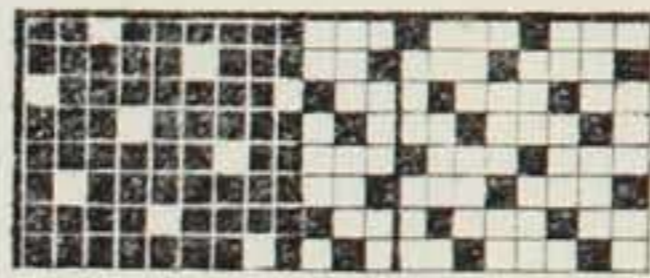
rep. 11 cur. mas.



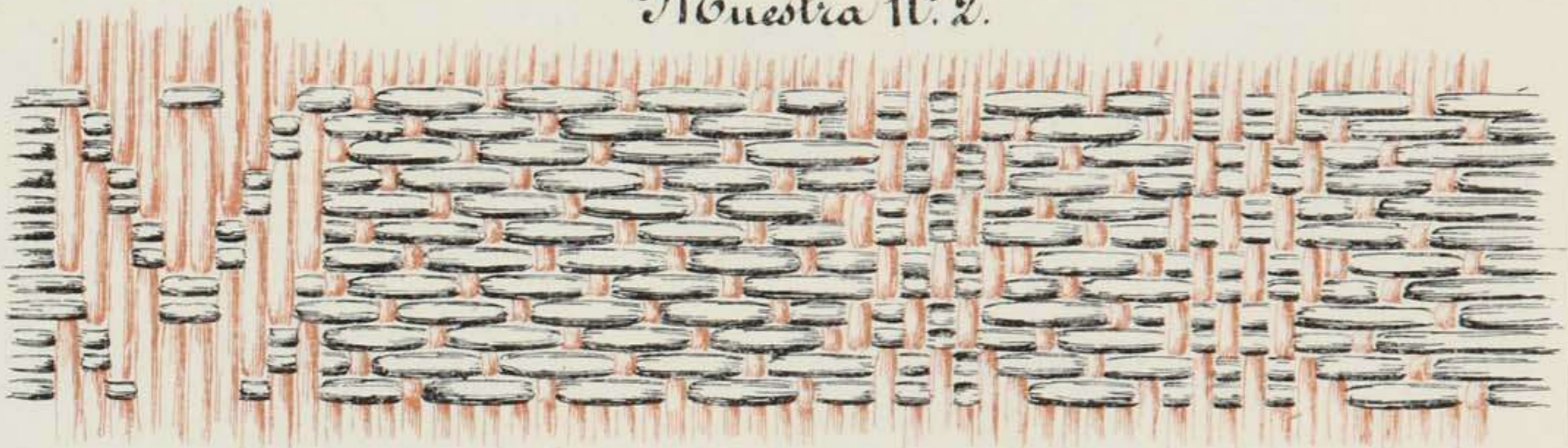
Muestra N.º 1.



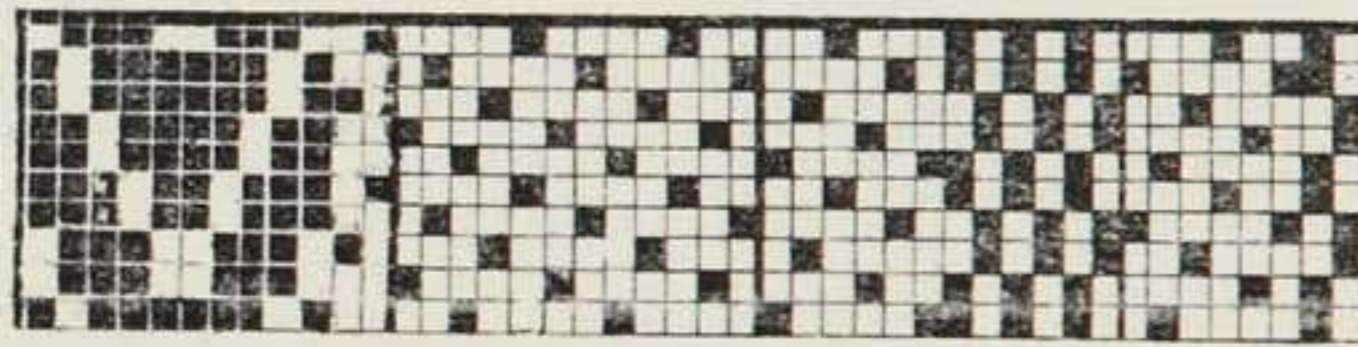
Ligamientos del N.º 1.



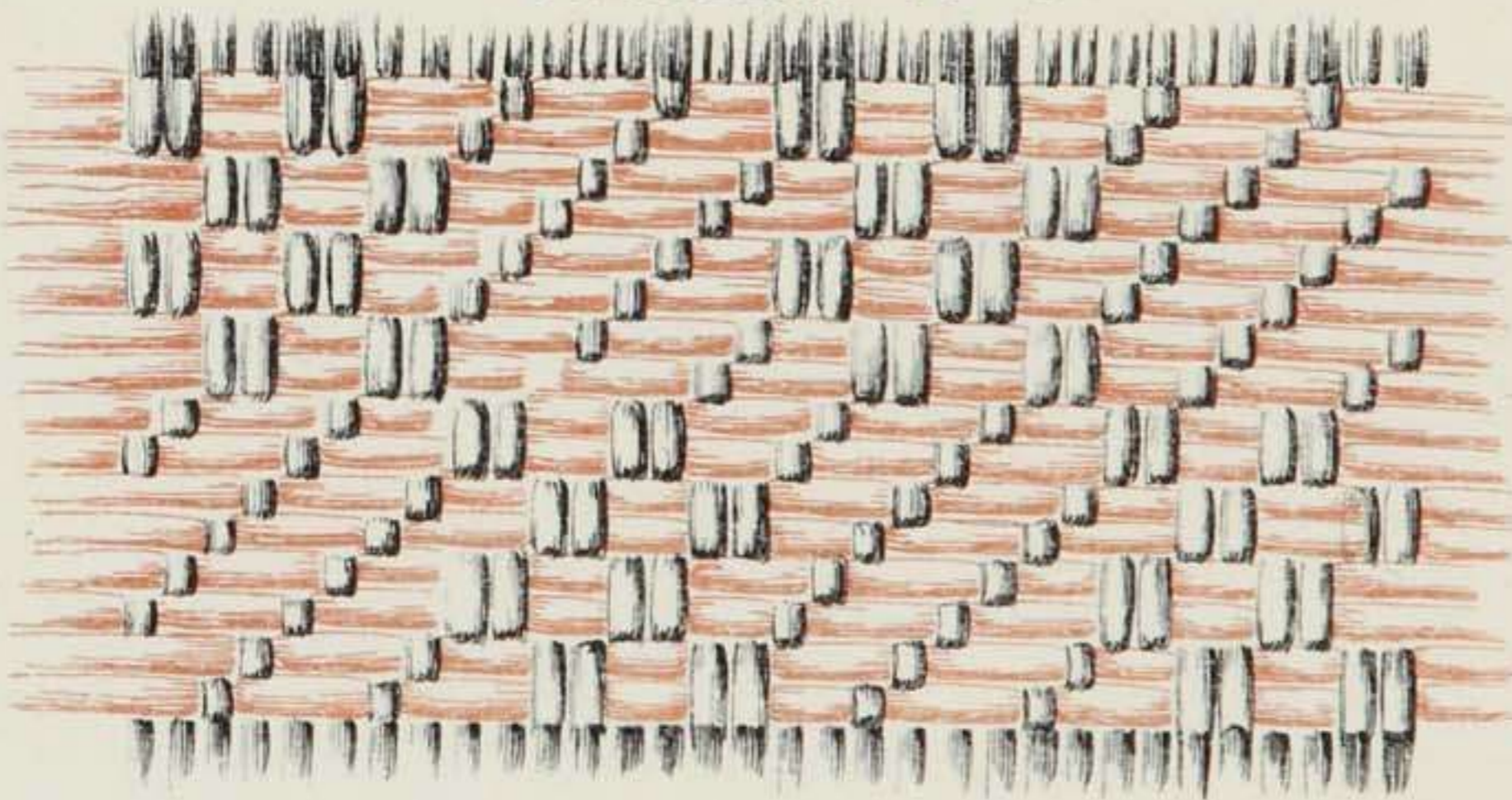
Muestra N.º 2.



Ligamientos del N.º 2.



Muestra N.º 3.



Ligamientos del N.º 3.

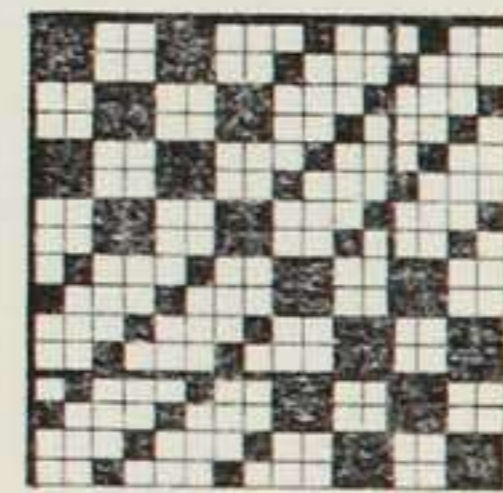


fig. 1<sup>a</sup>

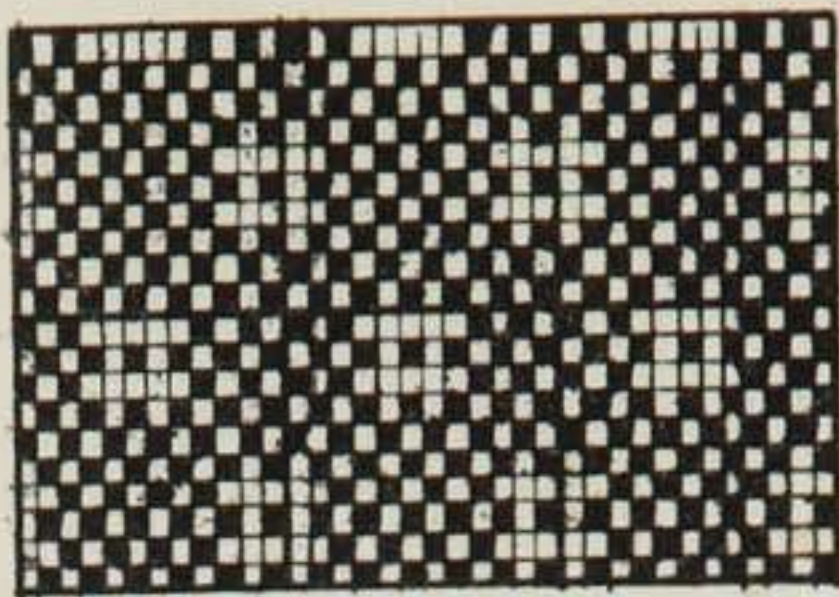


fig. 2<sup>a</sup>

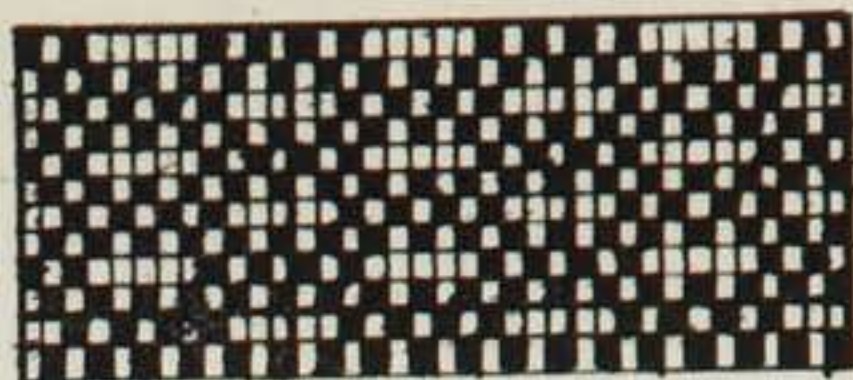


fig. 3<sup>a</sup>

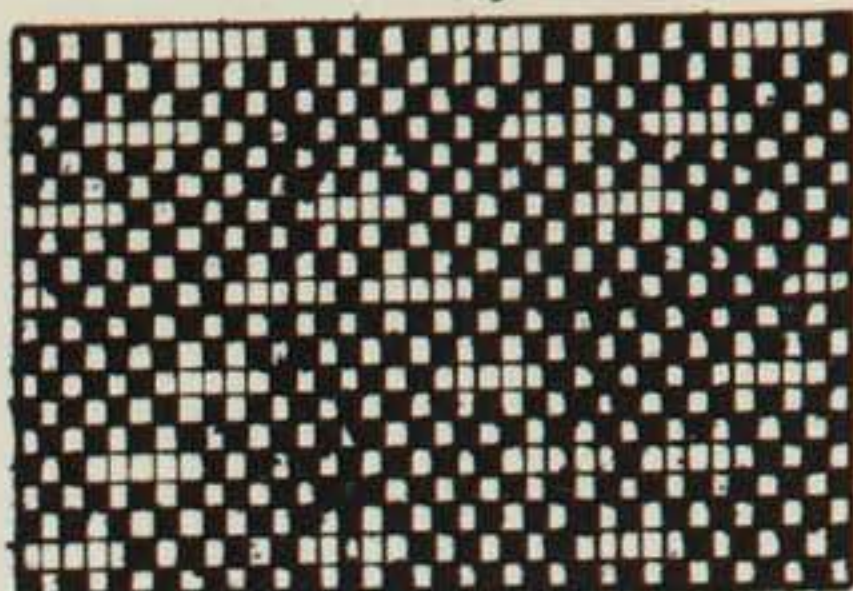


fig. 5<sup>a</sup>

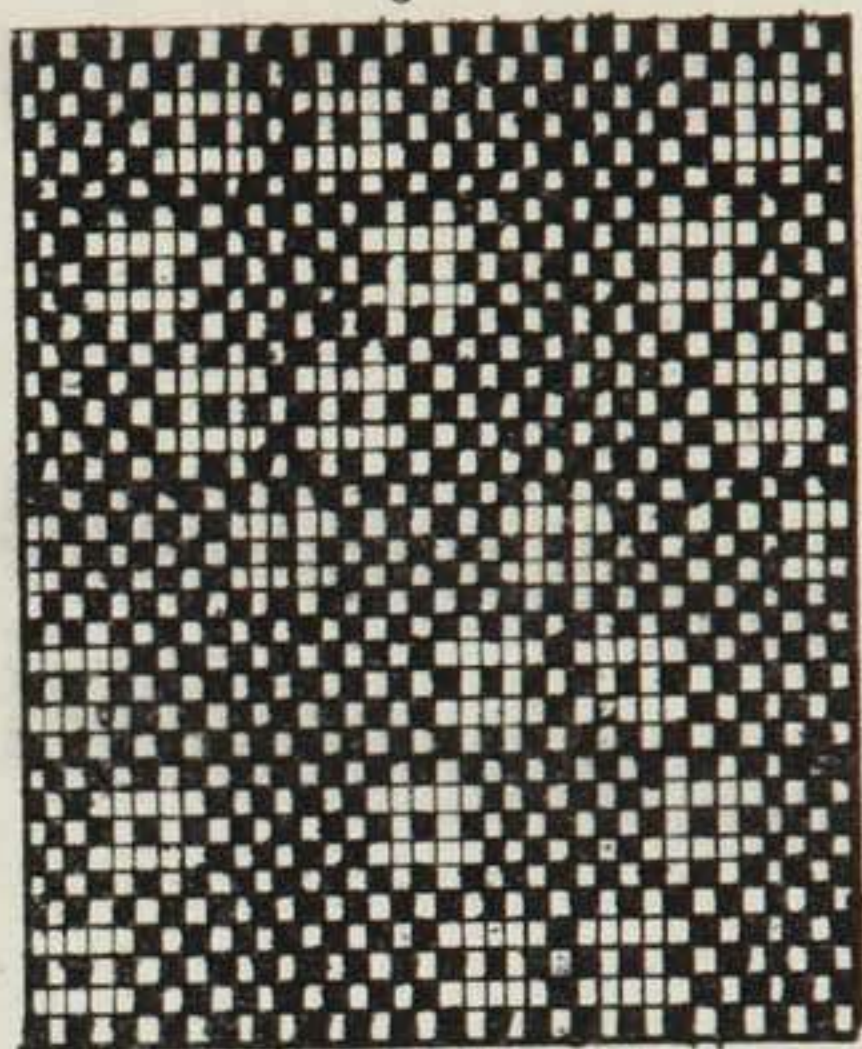


fig. 4<sup>a</sup>

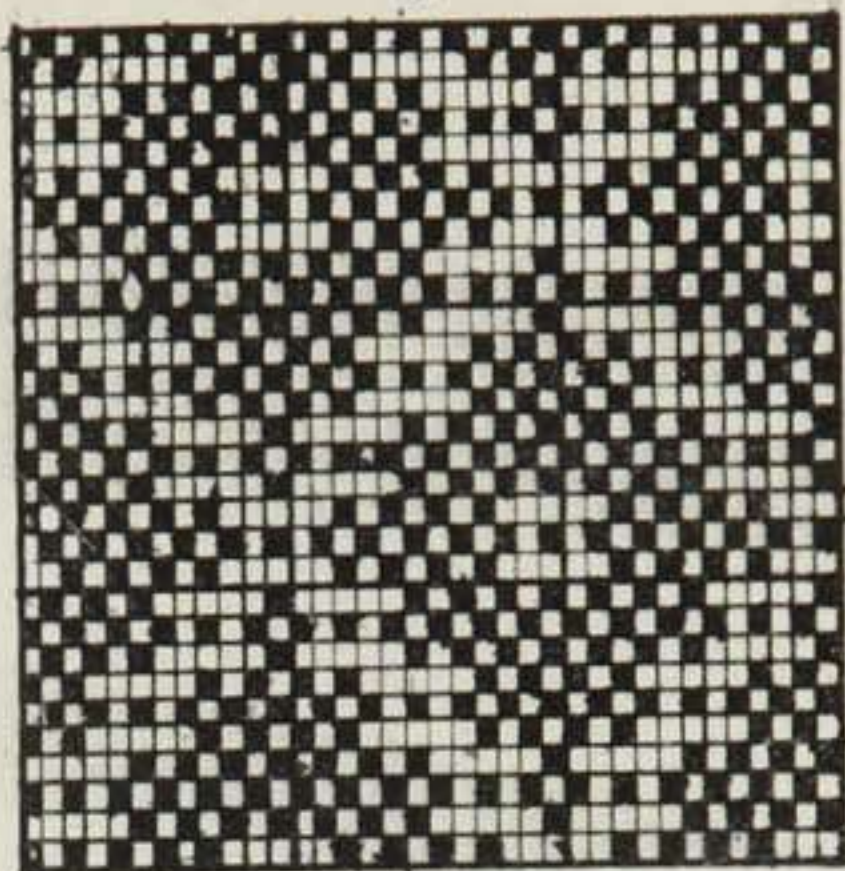


fig. 6<sup>a</sup>

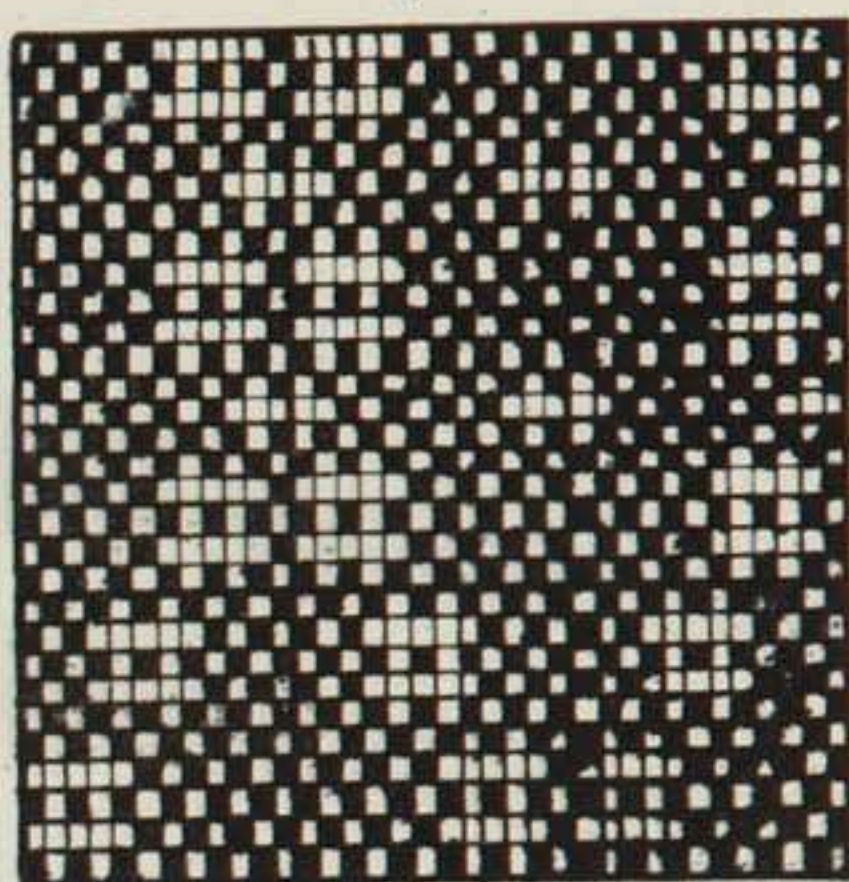


fig. 9<sup>a</sup>

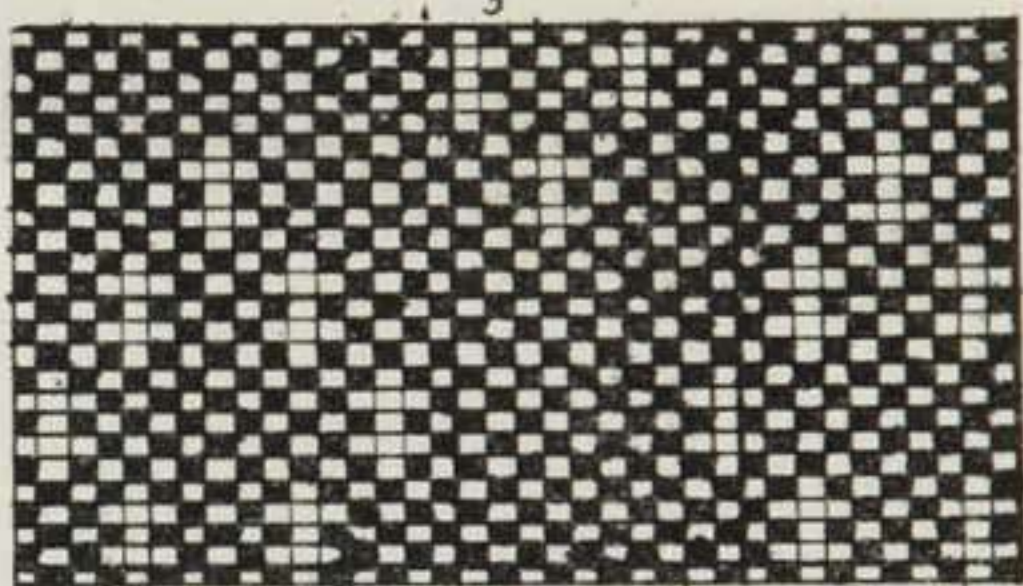


fig. 7<sup>a</sup>

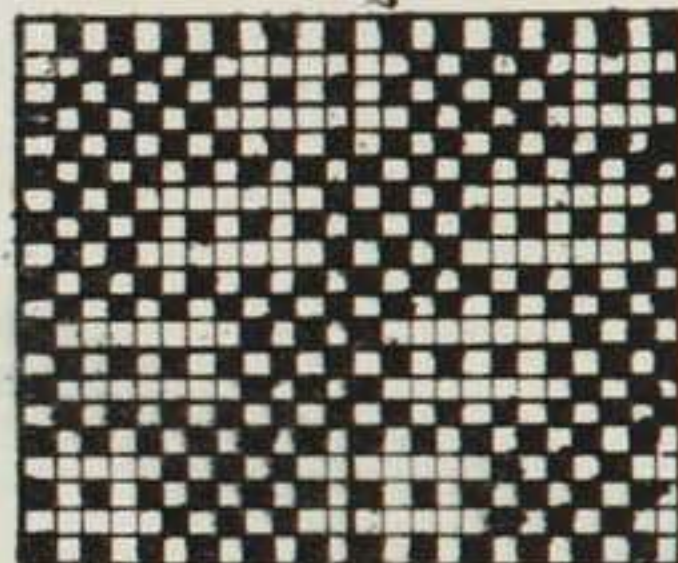


fig. 10<sup>a</sup>



fig. 8<sup>a</sup>



fig. 11<sup>a</sup>

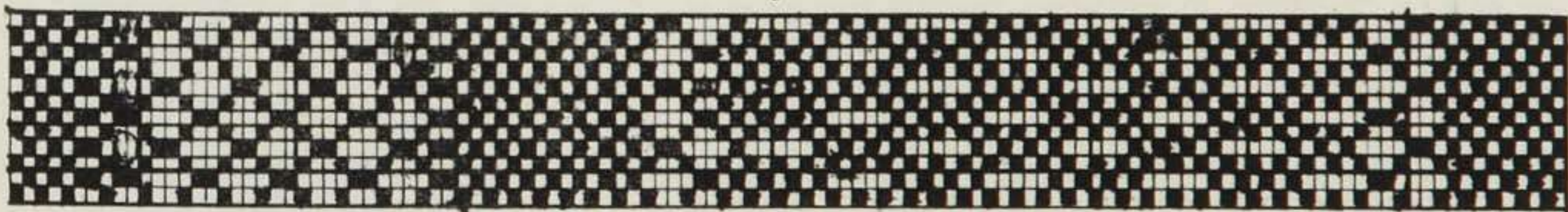
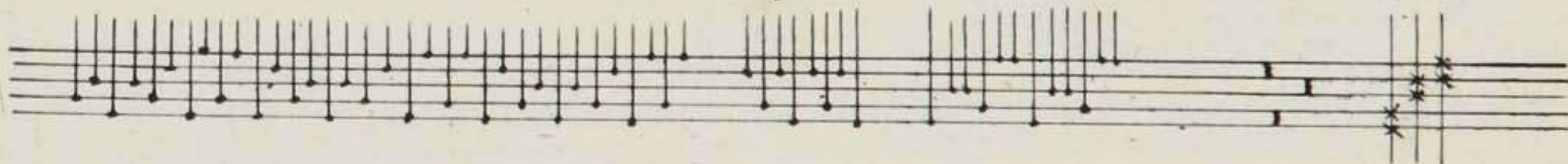
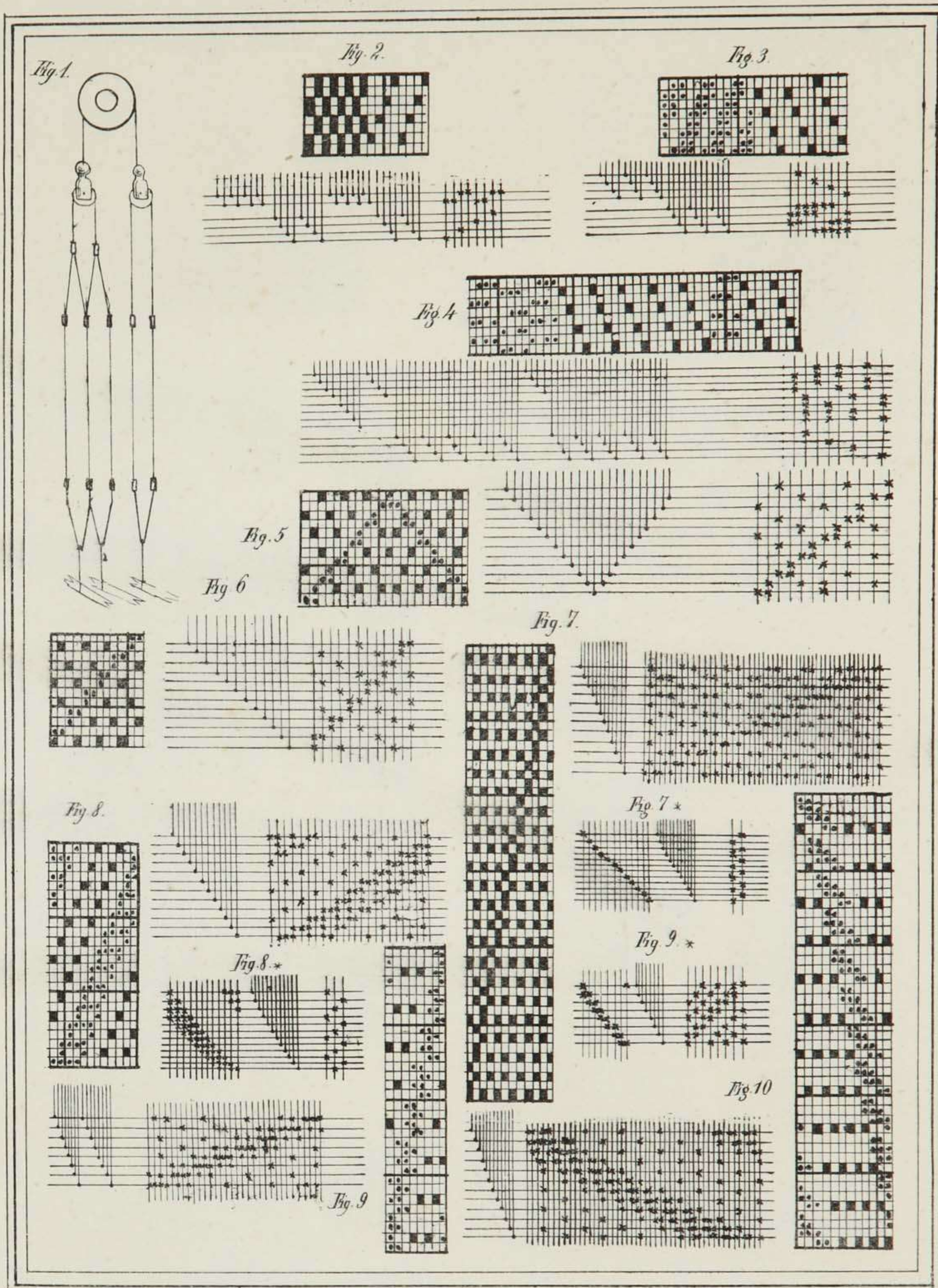


fig. 12<sup>a</sup>



321



Nota. Las figuras anotadas con la \* son las mismas disposiciones simplificadas.

Fig. 2.

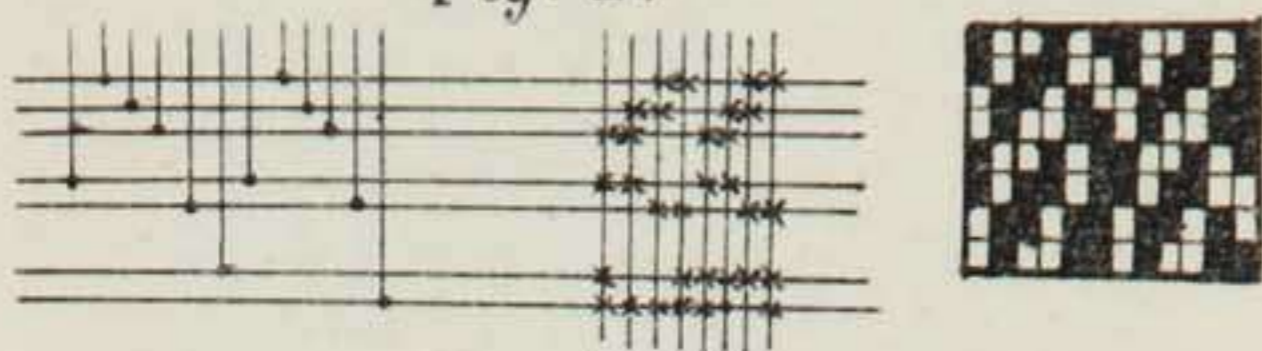


Fig. 1.

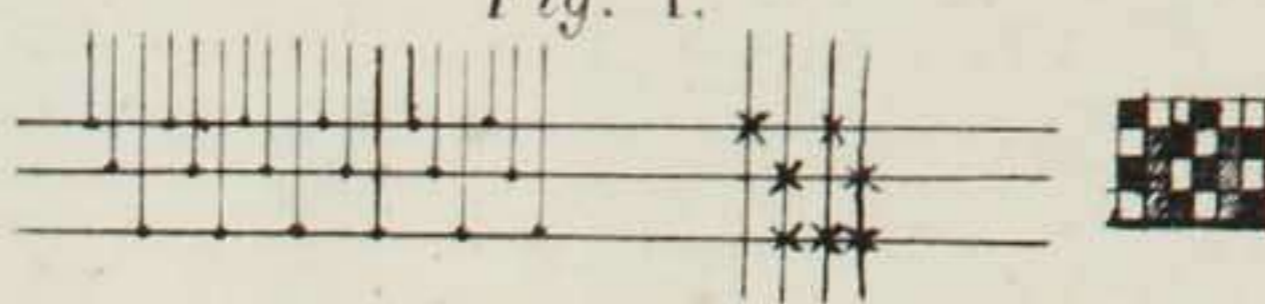


Fig. 4.



Fig. 3.

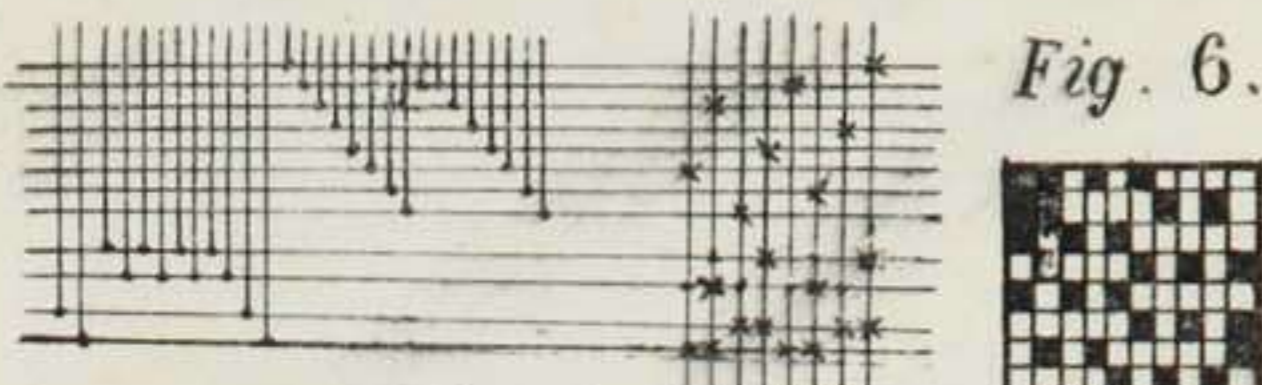


Fig. 5.

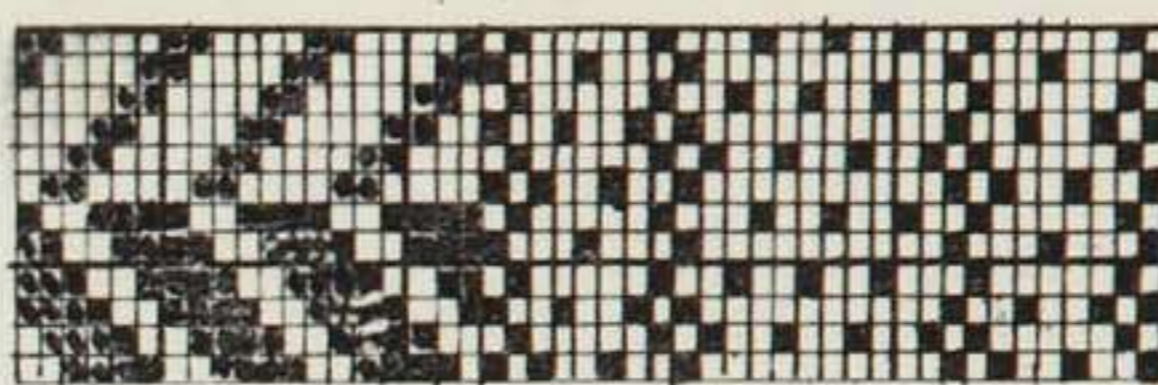


Fig. 6.

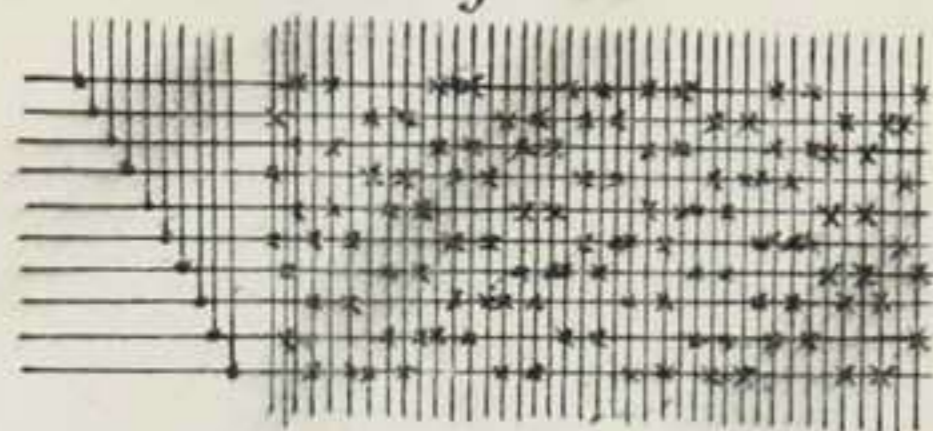


Fig. 9.

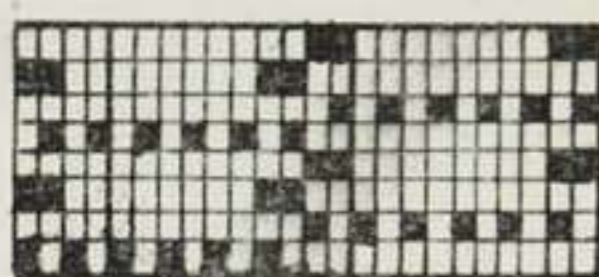


Fig. 7.

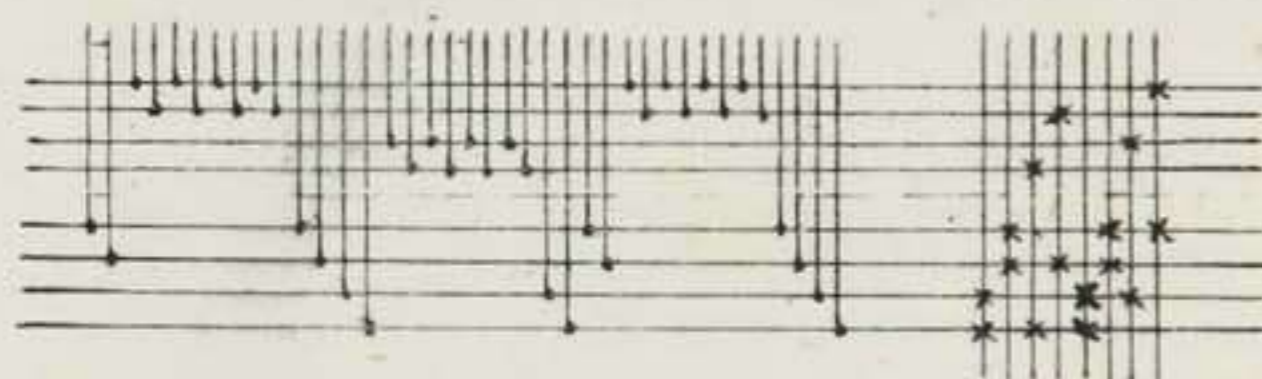


Fig. 8.

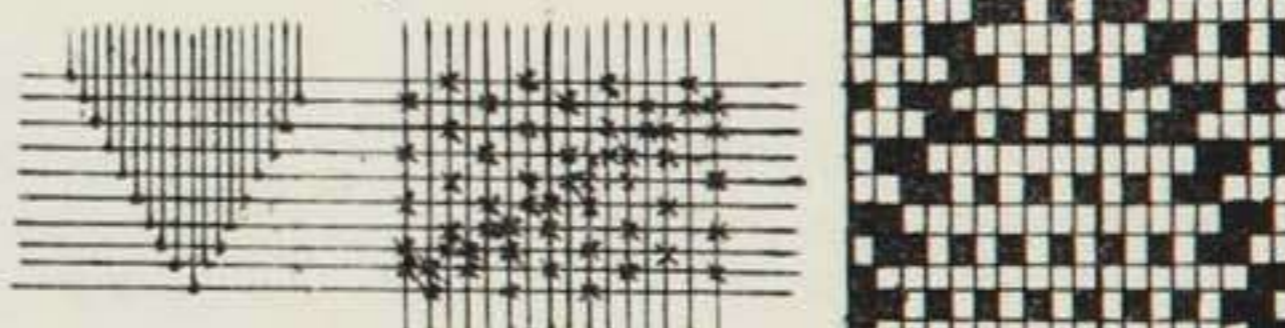


Fig. 11.

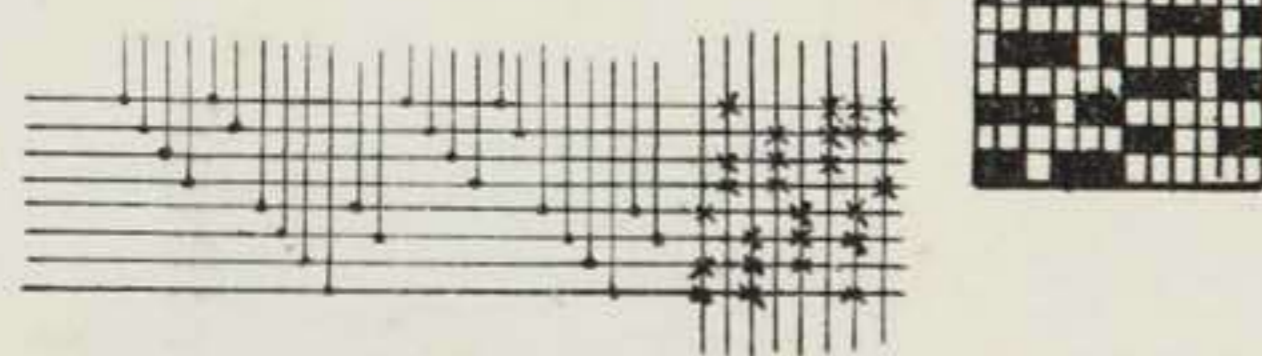


Fig. 10.

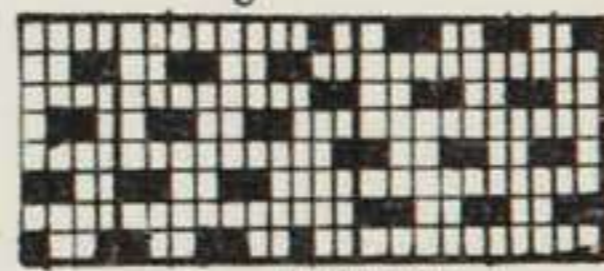


Fig. 13.

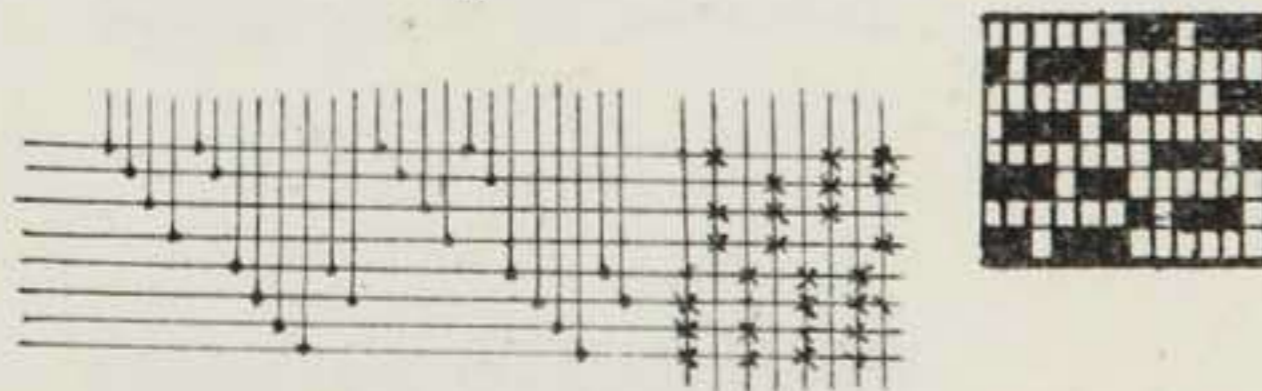


Fig. 12.



fig. 1<sup>a</sup>

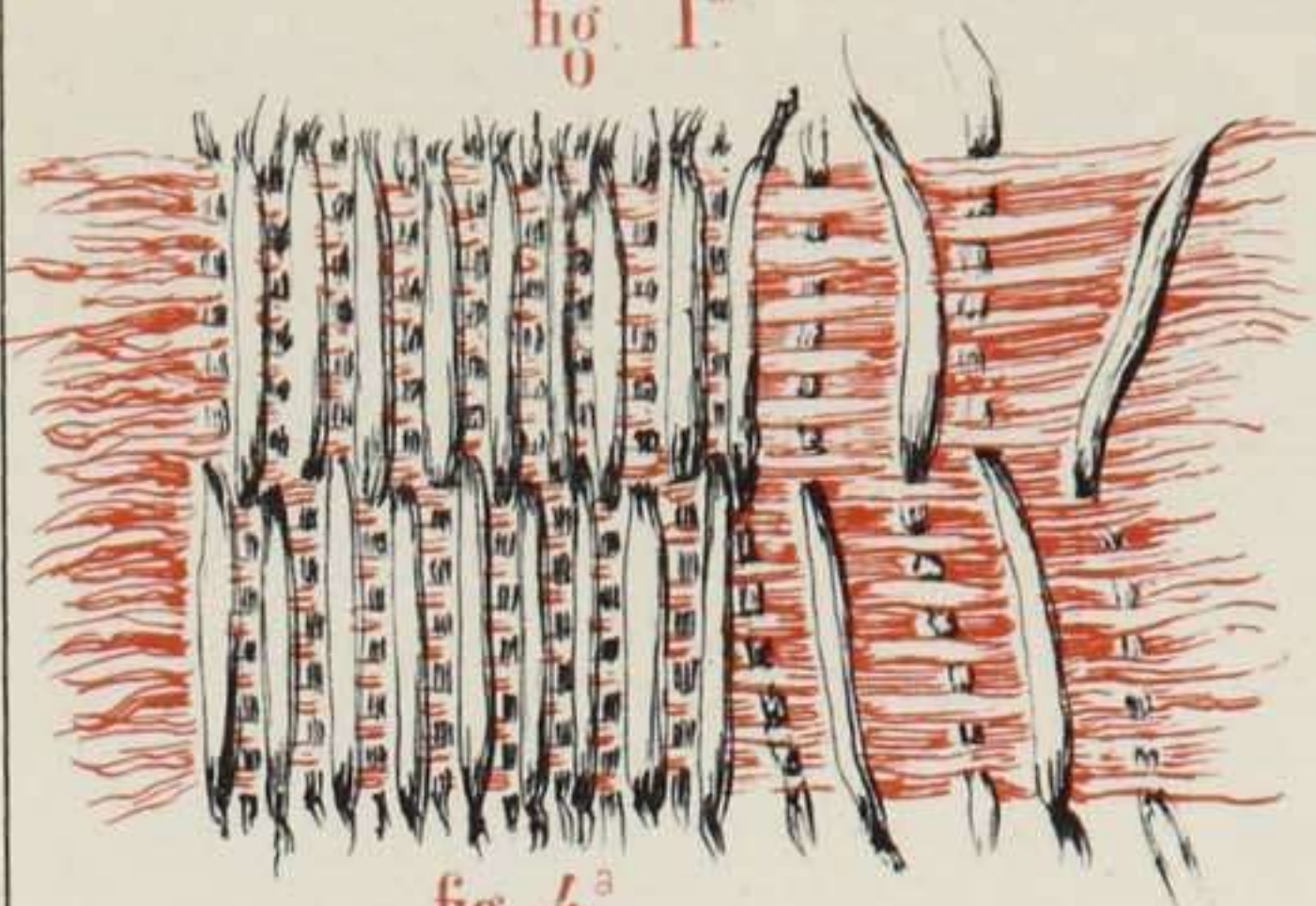


fig. 2<sup>a</sup>

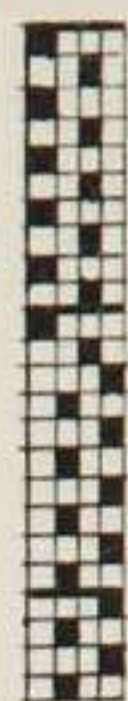


fig. 5<sup>a</sup>



fig. 21<sup>b</sup>

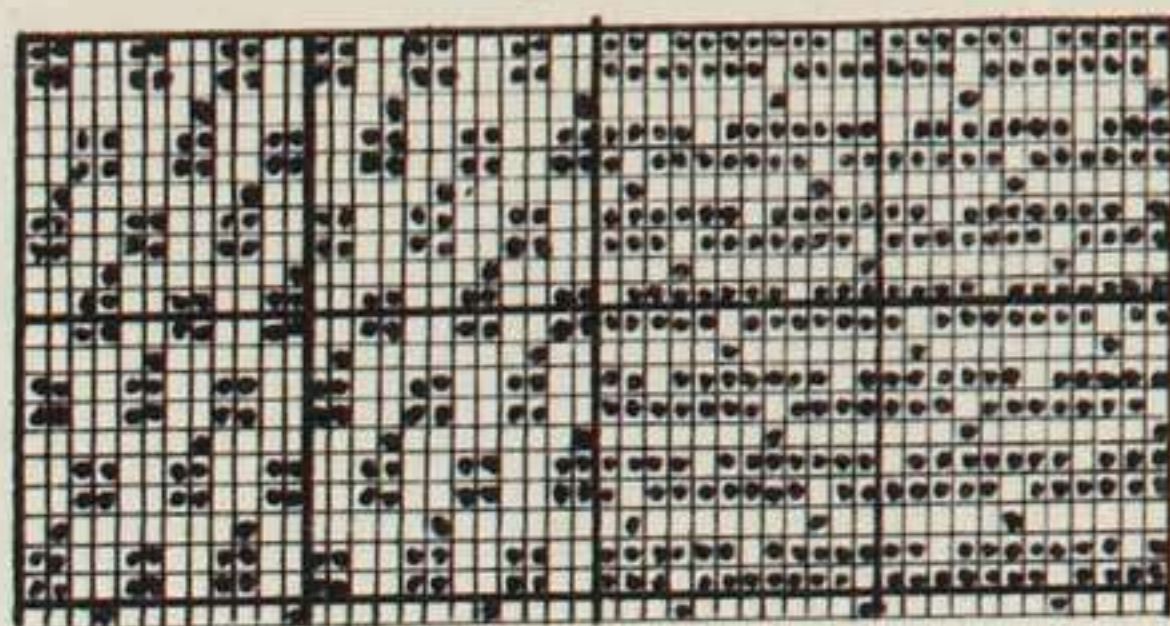


fig. 4<sup>a</sup>

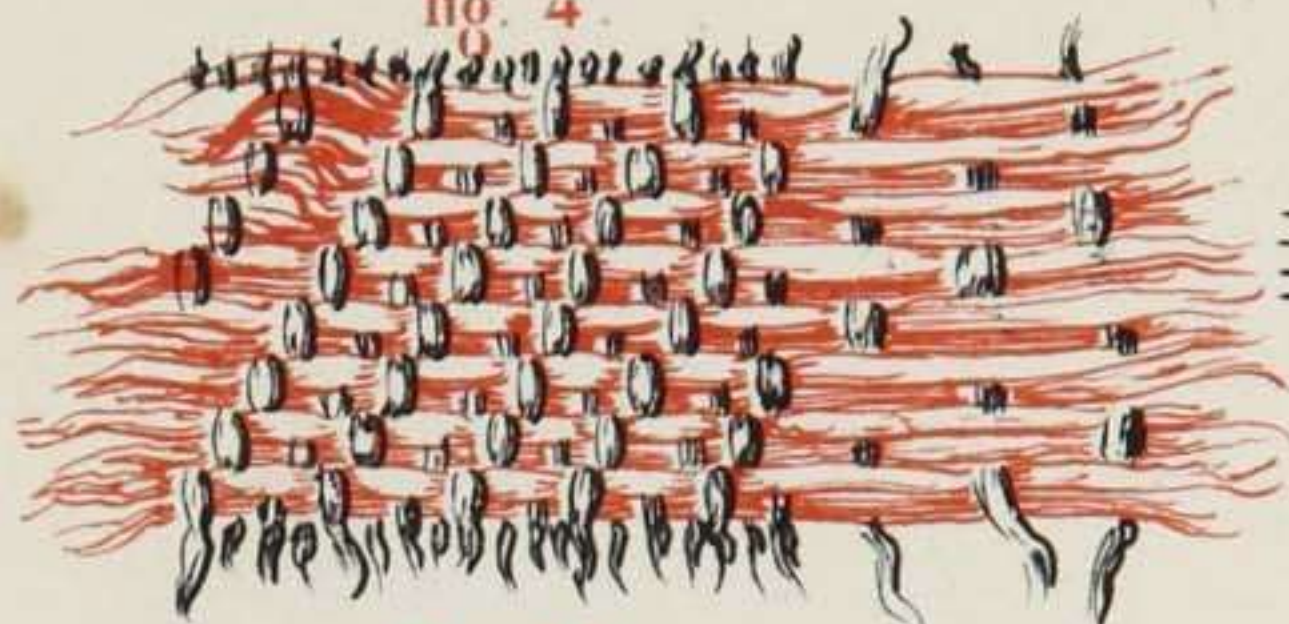


fig. 3<sup>a</sup>

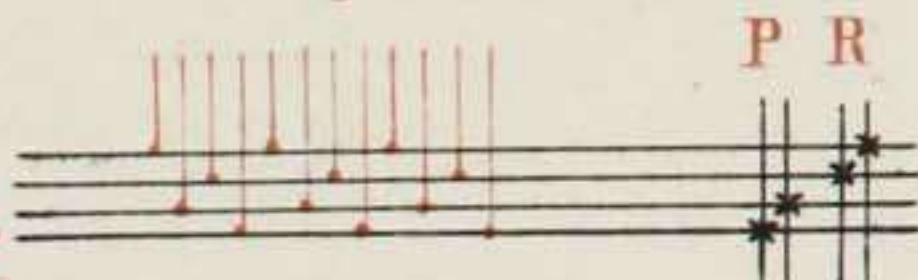


fig. 6<sup>a</sup>

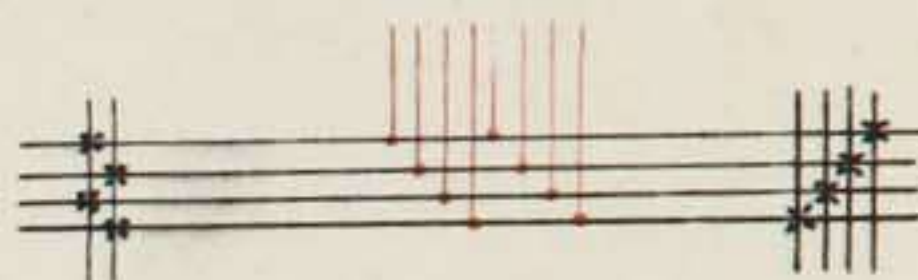


fig. 8<sup>a</sup>



fig. 9<sup>a</sup>

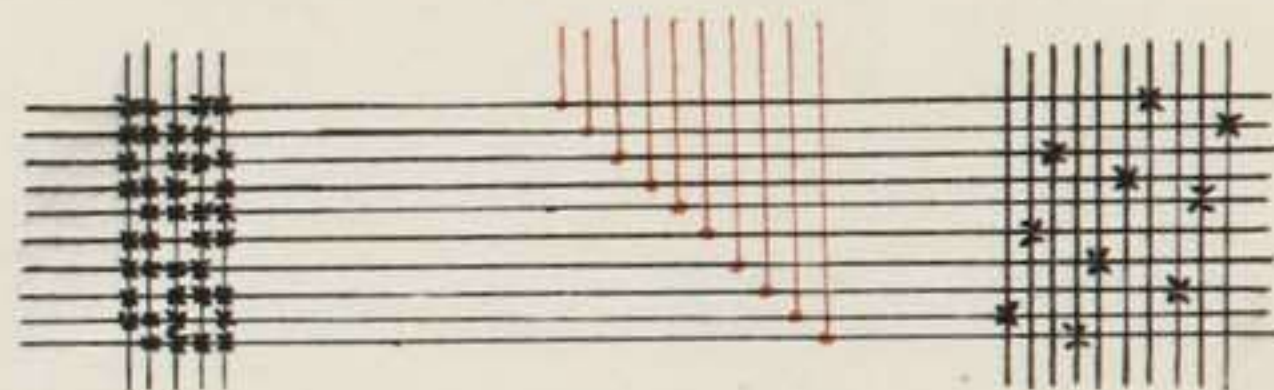


fig. 7<sup>a</sup>



fig. 11<sup>a</sup>

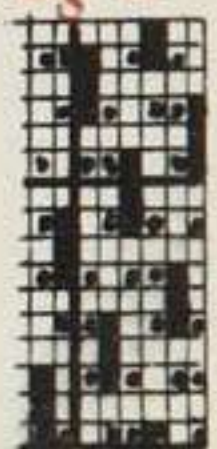


fig. 12<sup>a</sup>

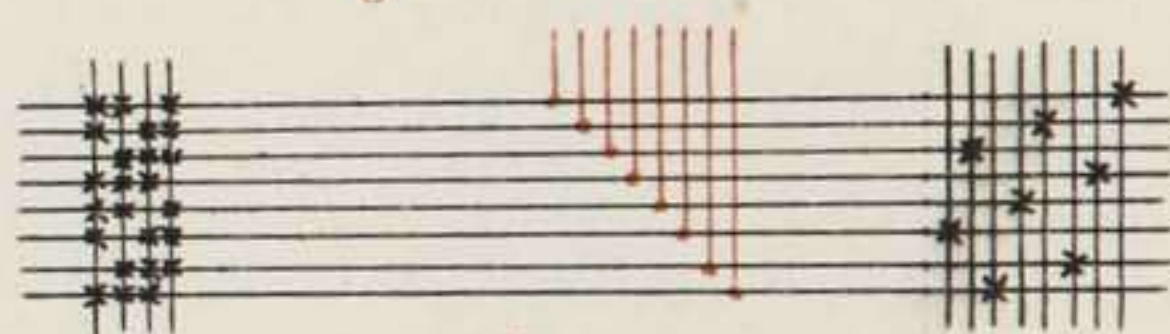


fig. 10<sup>a</sup>

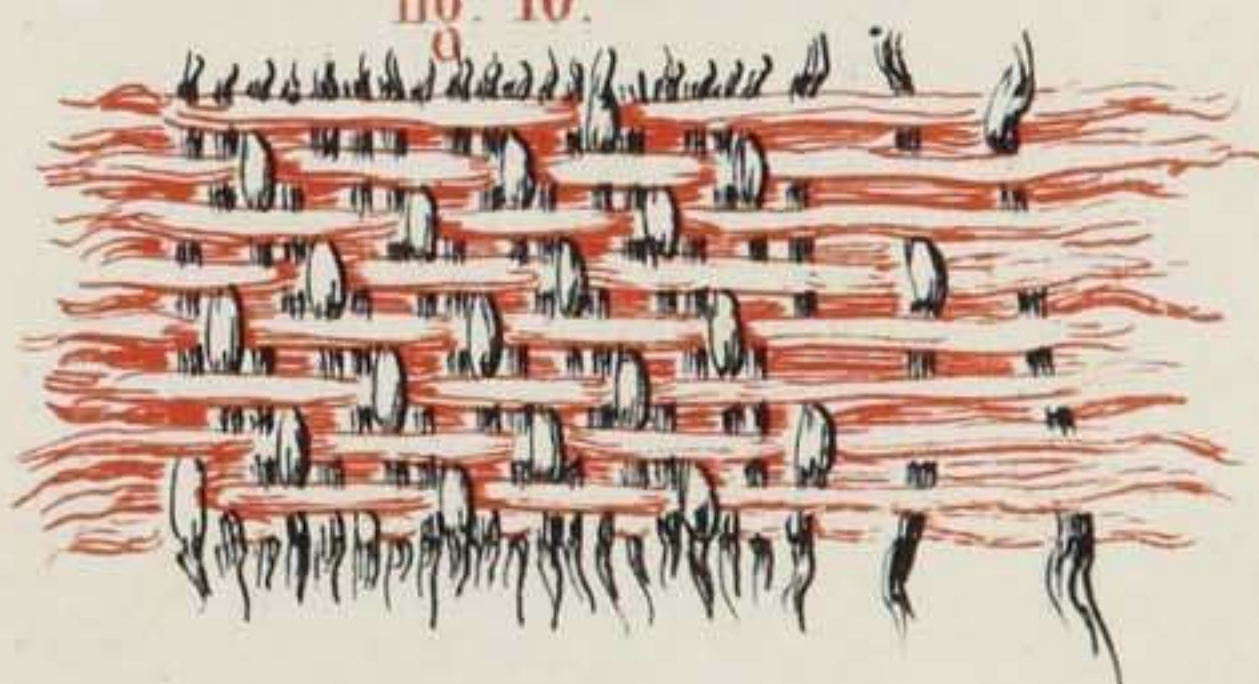


fig. 15<sup>a</sup>



fig. 14<sup>a</sup>

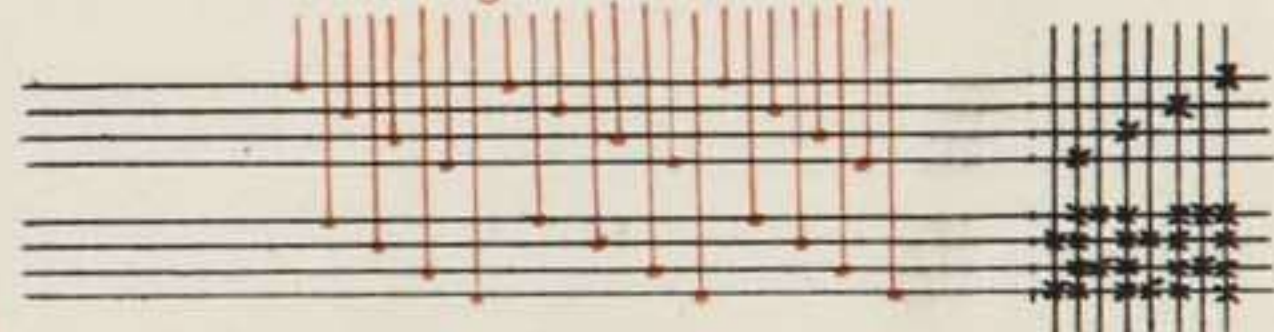


fig. 15<sup>b</sup>

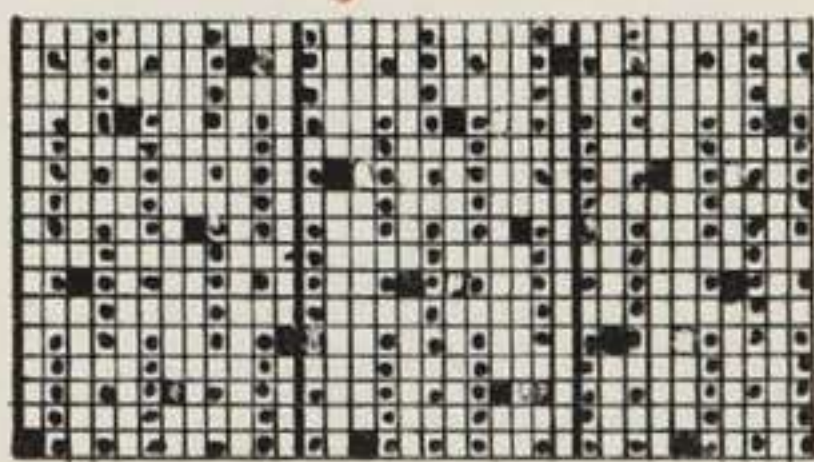


fig. 16<sup>b</sup>

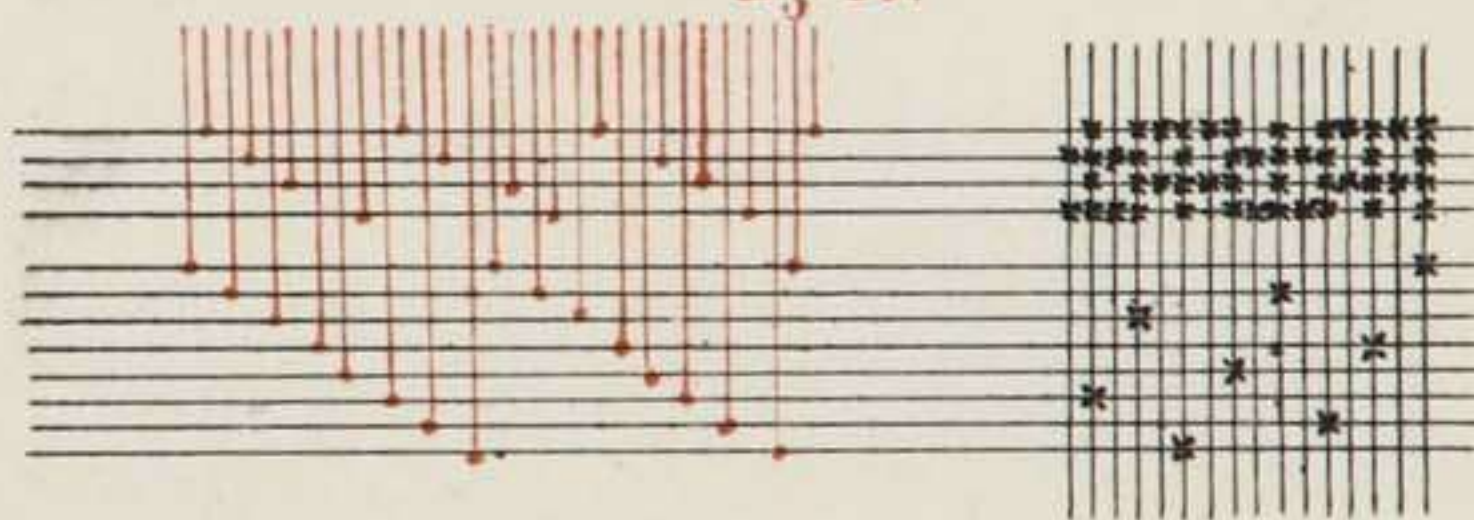


fig. 19<sup>a</sup>



fig. 20<sup>a</sup>



fig. 17<sup>a</sup>

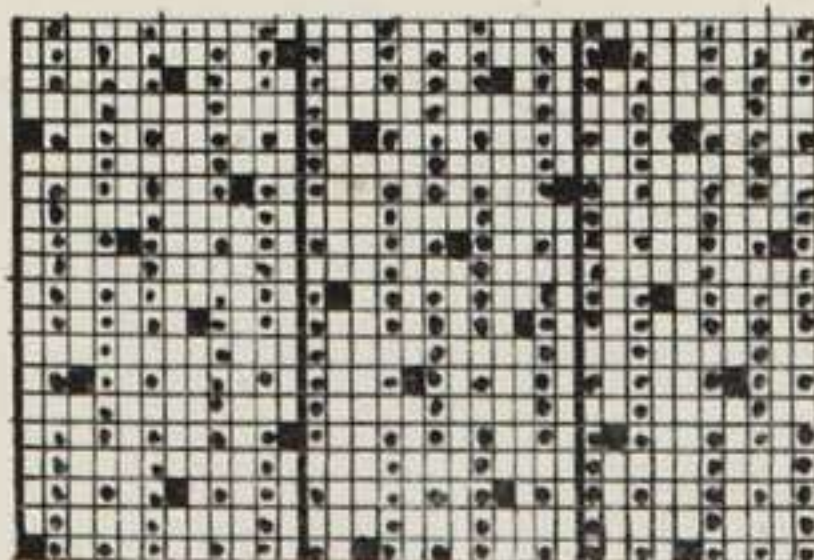
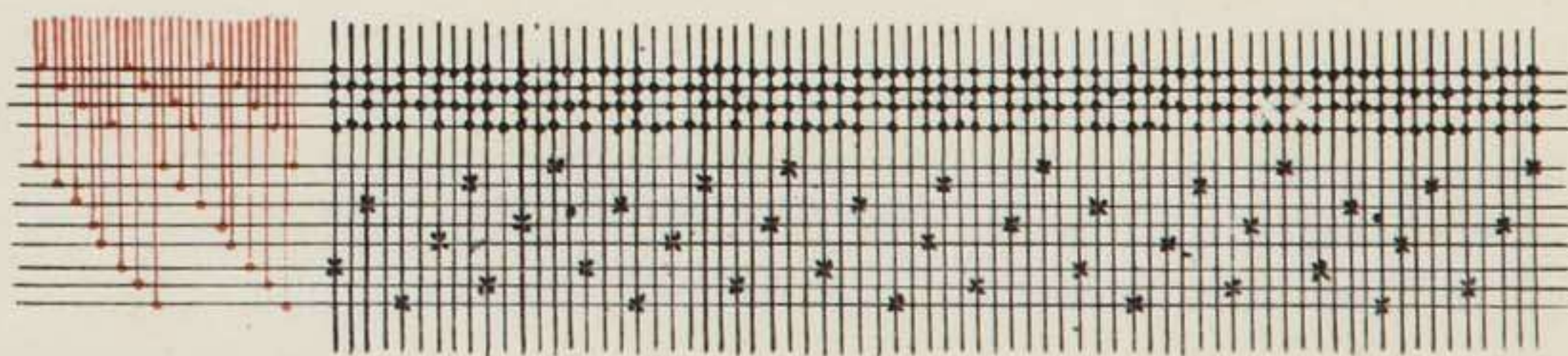


fig. 18<sup>b</sup>



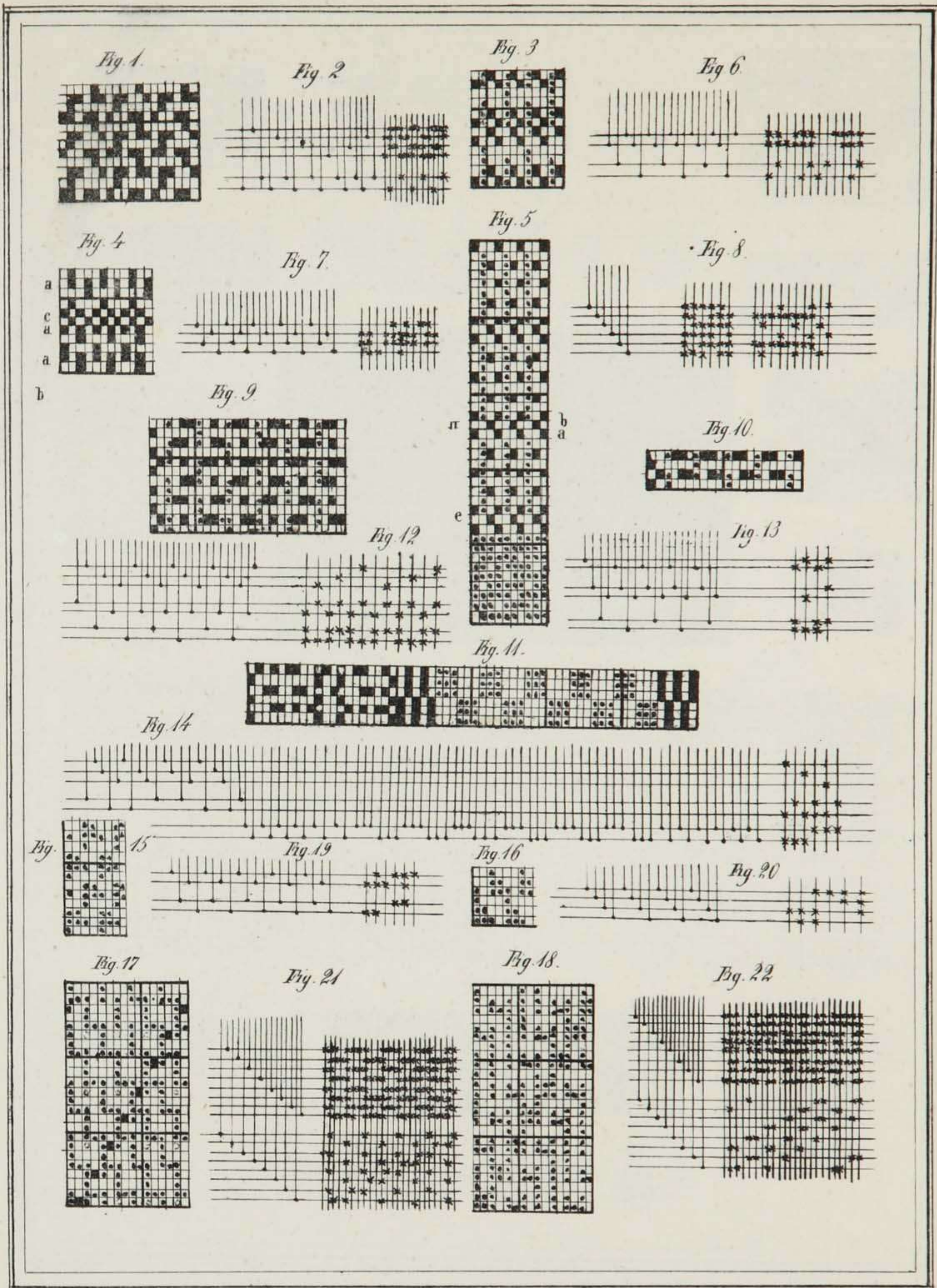
# EMBUTIDOS. ligamientos y Disposiciones.

Lam. XIV.

*fig. 2<sup>a</sup>*  
*fig. 10<sup>a</sup> (D. de la fig. 1<sup>a</sup>)*  
*fig. 1<sup>a</sup>*  
*fig. 11 (D. de la fig. 2<sup>a</sup>)*  
*fig. 3<sup>a</sup>*  
*izq. der.*  
*fig. 15 (D. de la fig. 3<sup>a</sup>)*  
*fig. 4<sup>a</sup>*  
*izq. der.*  
*fig. 8<sup>a</sup>*  
*b a*  
*fig. 9<sup>a</sup>*  
*b a*  
*fig. 15 (D. de la fig. 5<sup>a</sup>)*  
*fig. 5<sup>a</sup>*  
*fig. 12<sup>a</sup>*  
*fig. 6<sup>a</sup>*  
*fig. 7<sup>a</sup>*  
*fig. 17 Rectif<sup>n</sup> de la disp<sup>n</sup> fig<sup>a</sup> 3<sup>a</sup> lam<sup>a</sup> 34.*  
*fig. 16 (D. de la fig. 12<sup>a</sup>)*

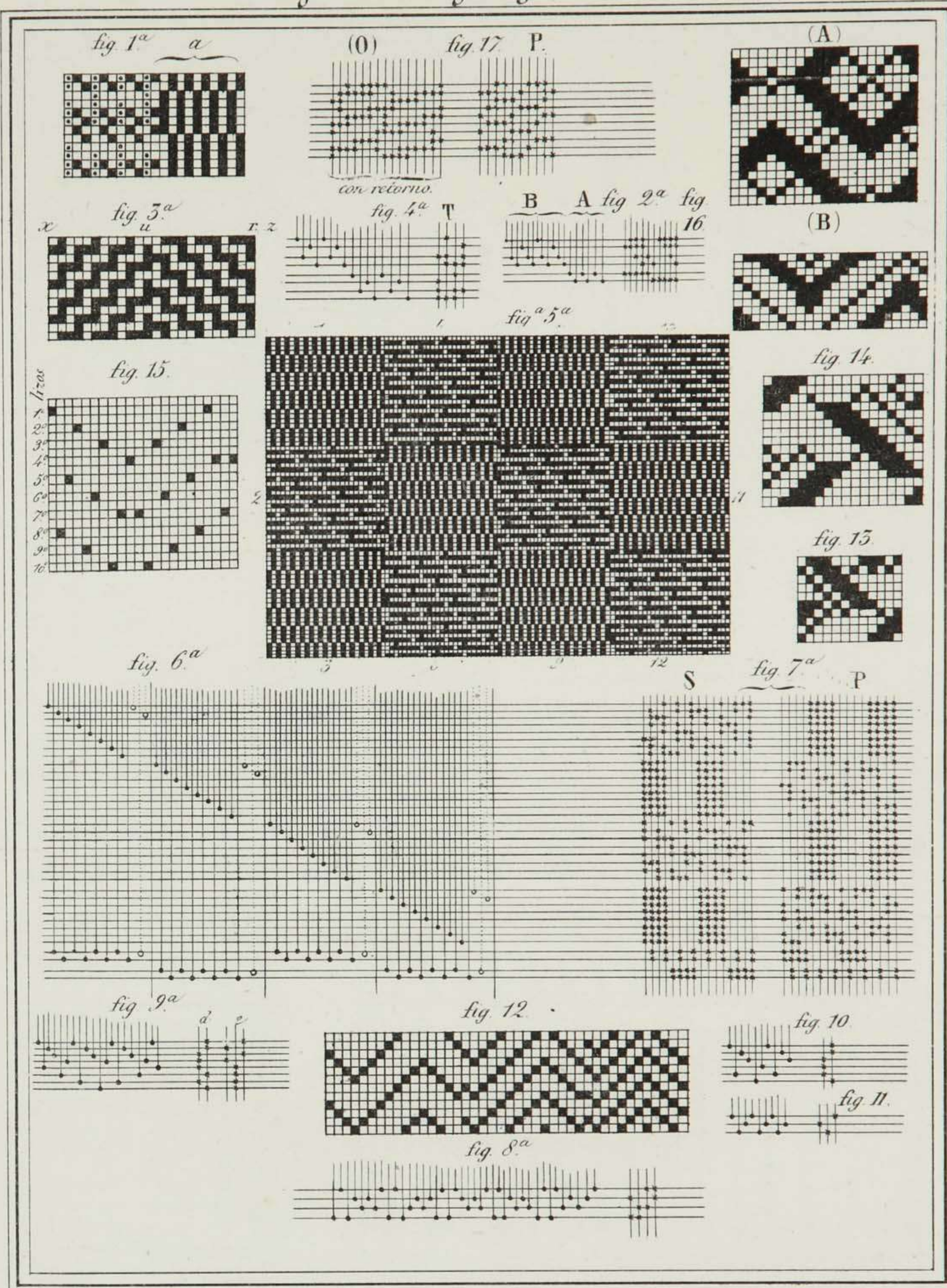
# LIGAMIENTOS Y DISPOSICIONES

Lám XLVI



TEJIDOS COMPUESTOS COMBINADOS.  
ligamientos y Disposiciones.

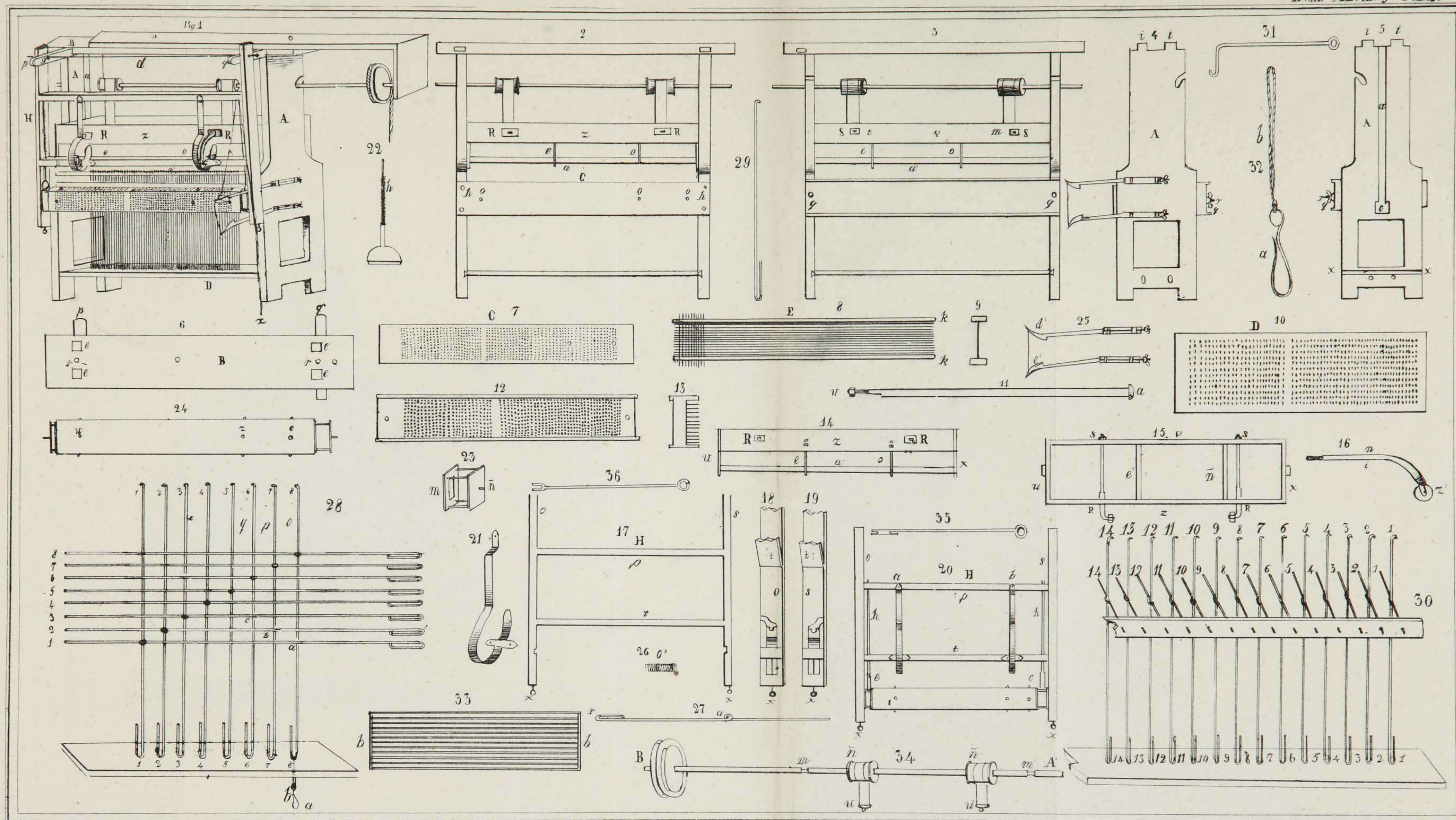
Lam. XLVII.





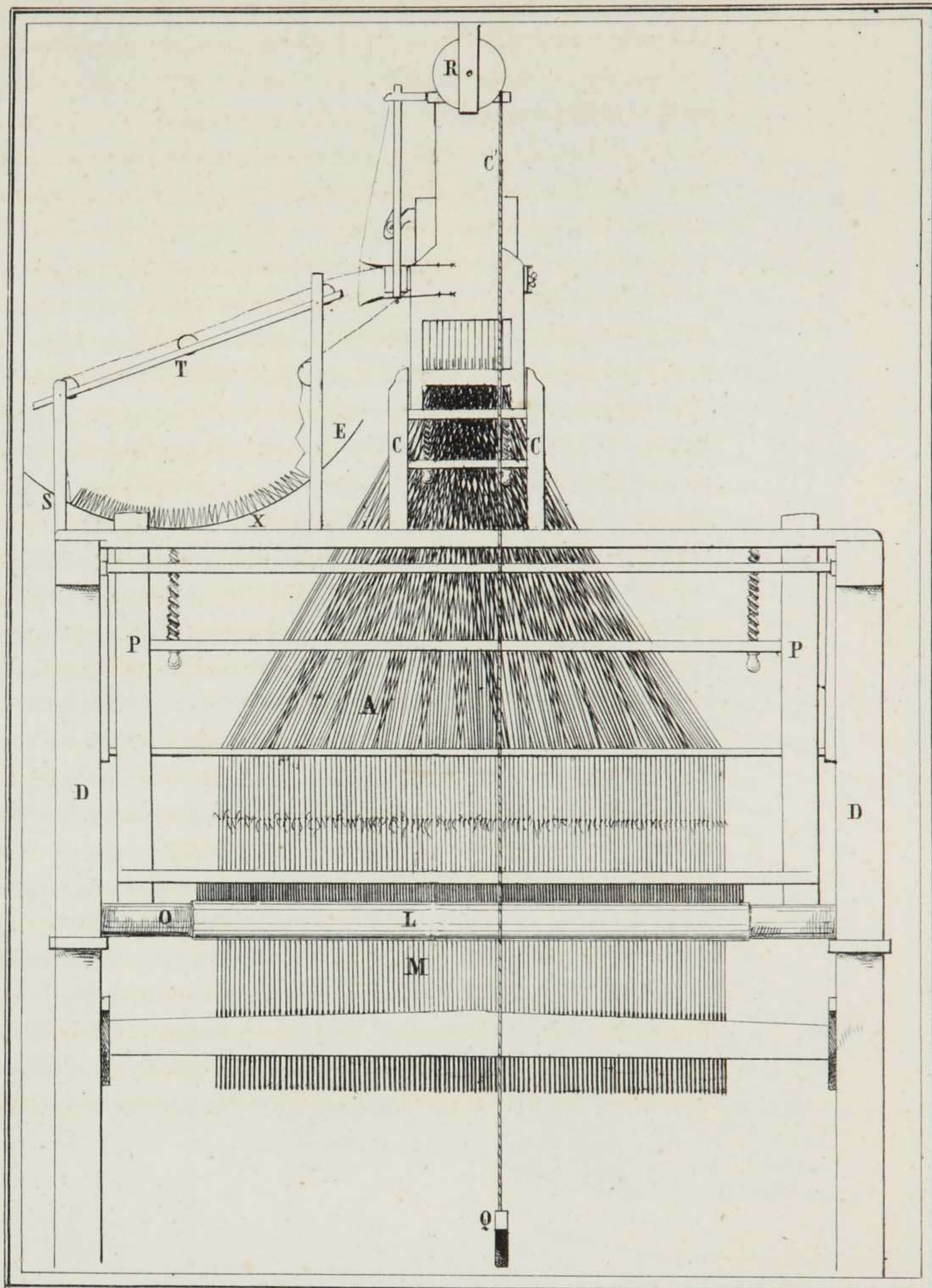
# MÁQUINA DE JACQUARD.

Lam. XLVIII y XLIX.



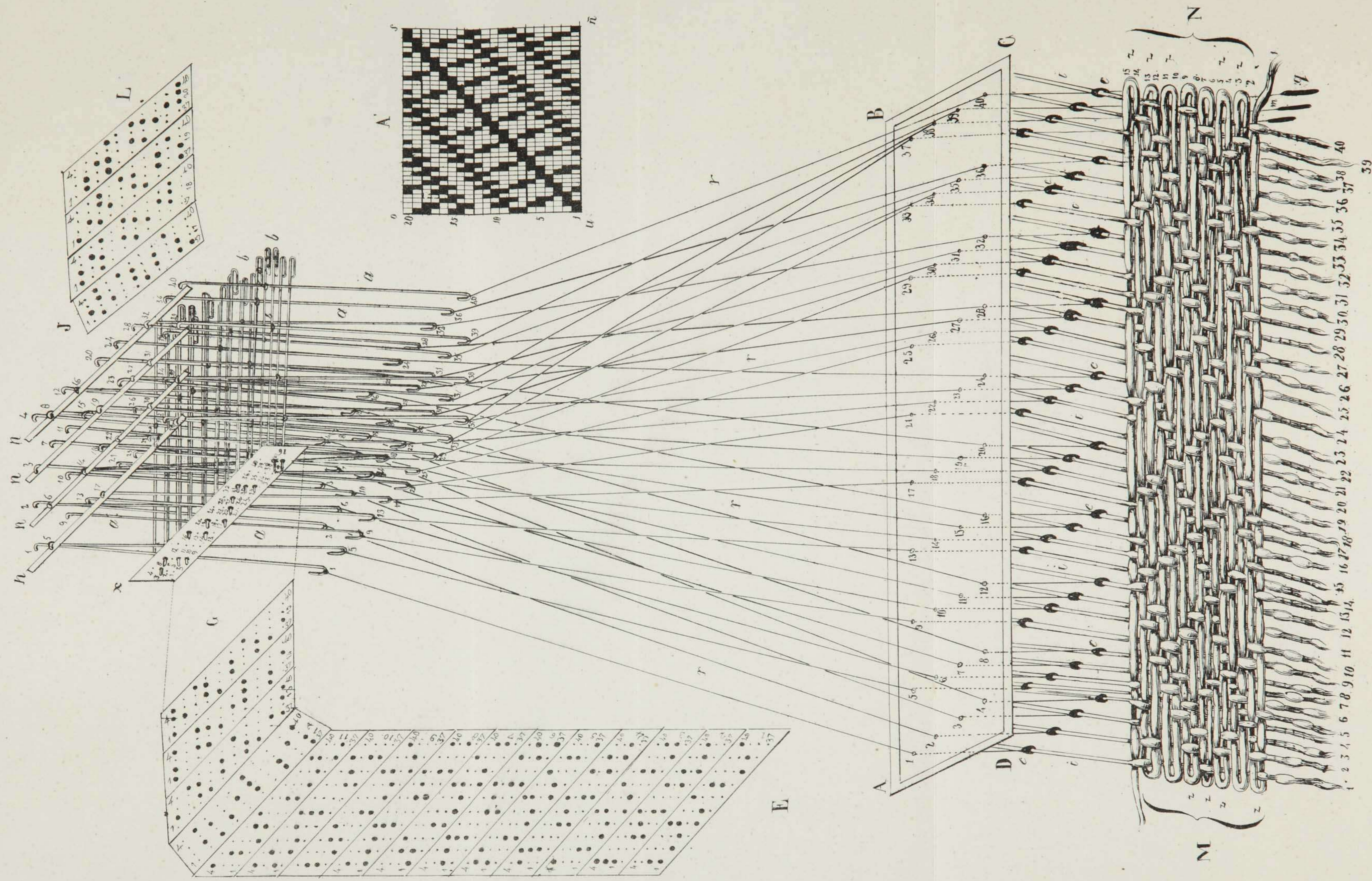
TELAR A LA JACQUART. (visto de frente.)

Lám. II.\*



**MONTURA DE TELAR A CUERPO SIMPLE.**  
 Enlace y dependencia en las varias operaciones de dicho sistema que  
 corresponde el dibujo con el tejido.

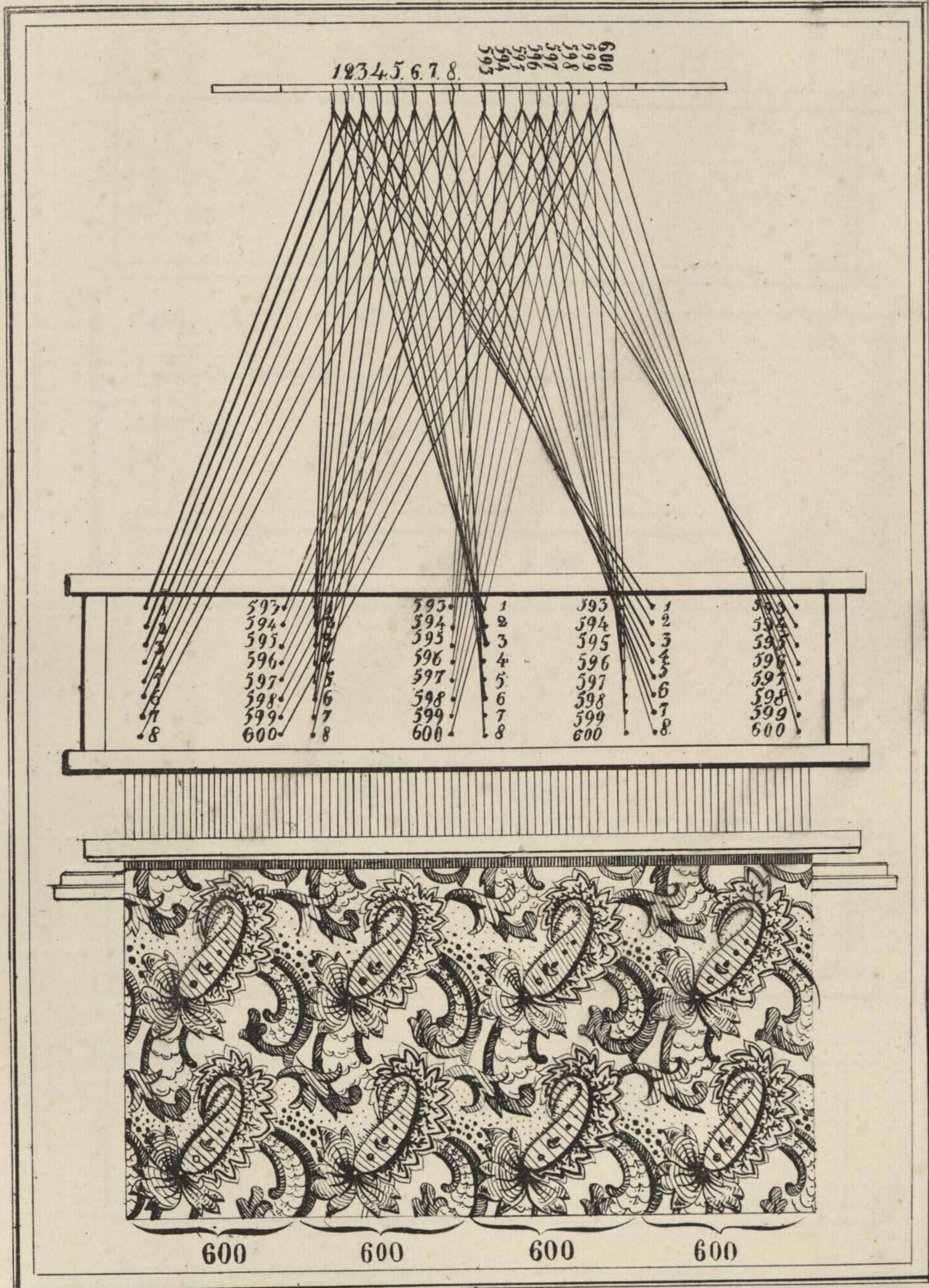
Lam. LXXXII



# PASAR LA TABLA

Aorden seguido.

Lam. LI.



# PARAR LA TABLA

## Disposiciones.

Lam. LI.\*

Fig. 1<sup>a</sup> correspondiente Lám. 52.

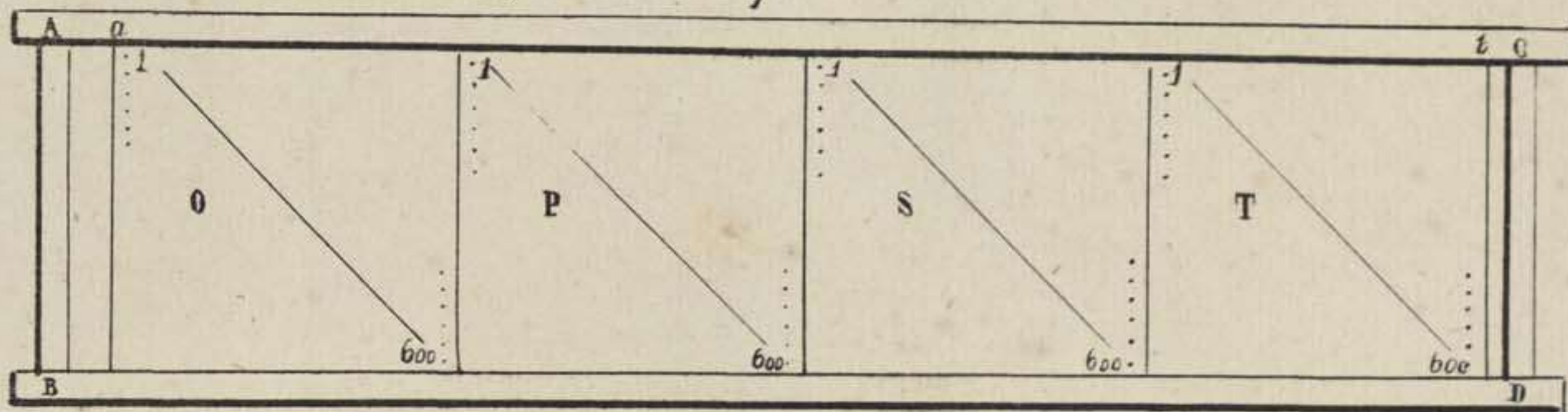


Fig. 2.

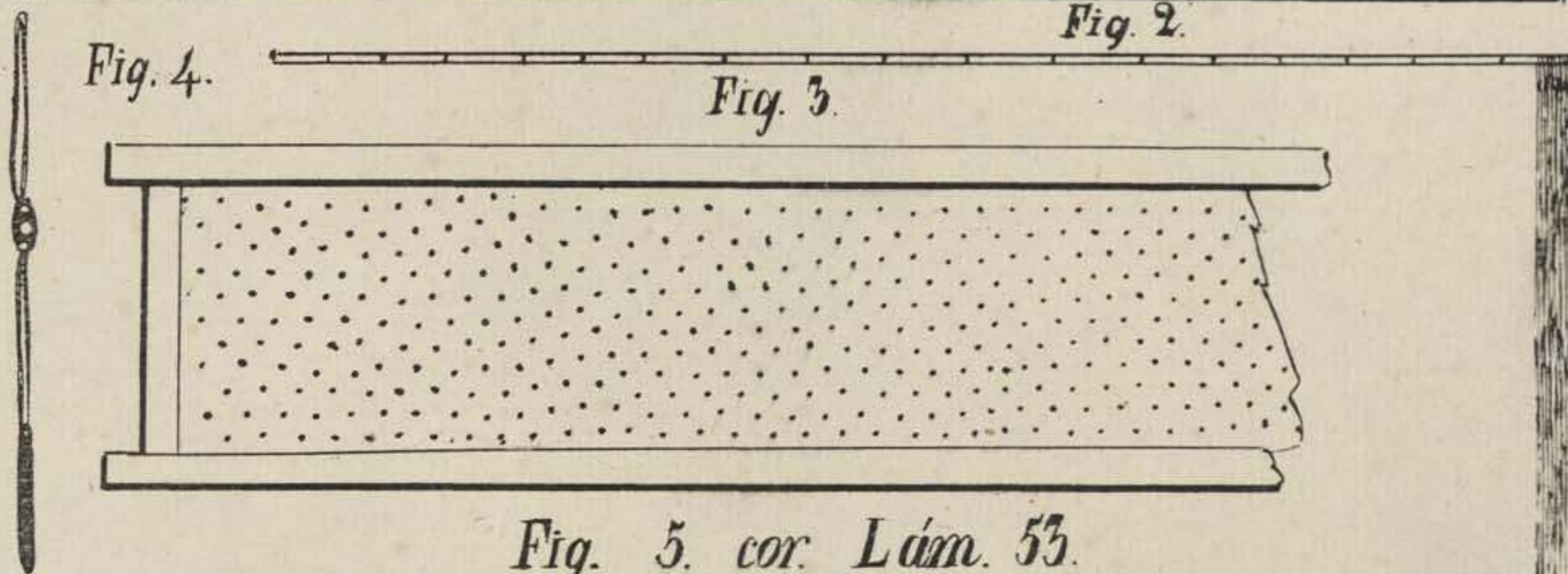


Fig. 5. cor Lám. 53.

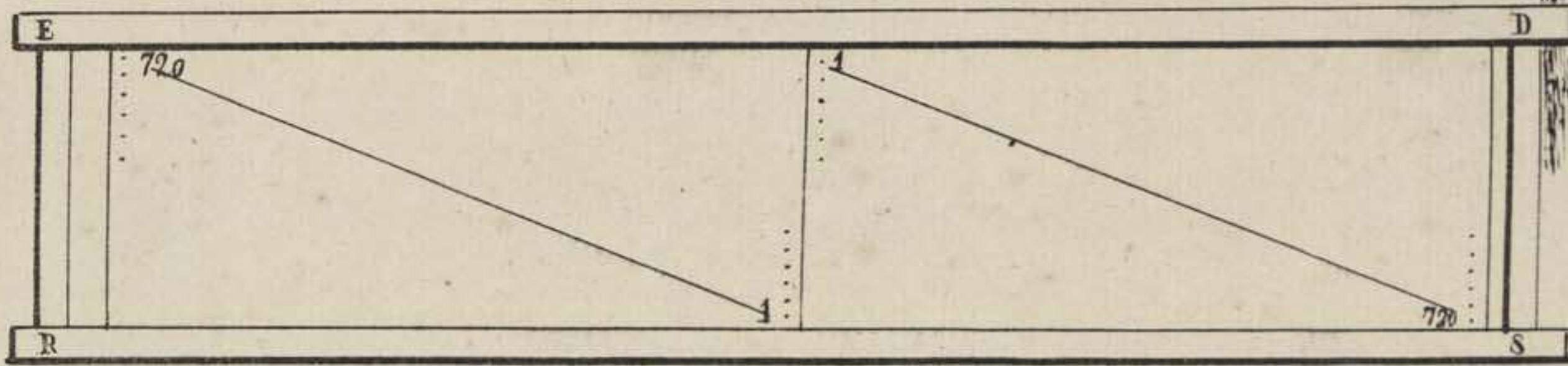


Fig. 6. cor Lám. 53.

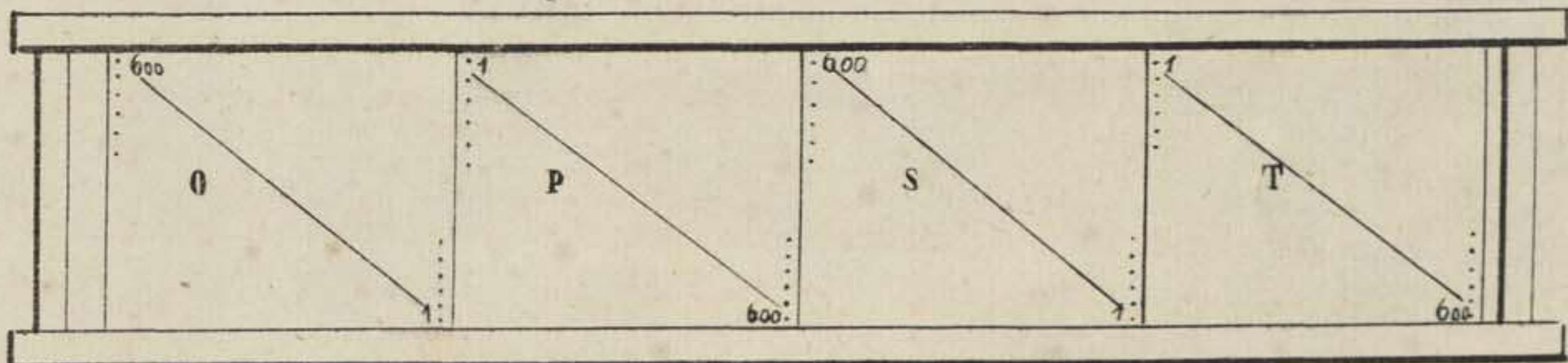
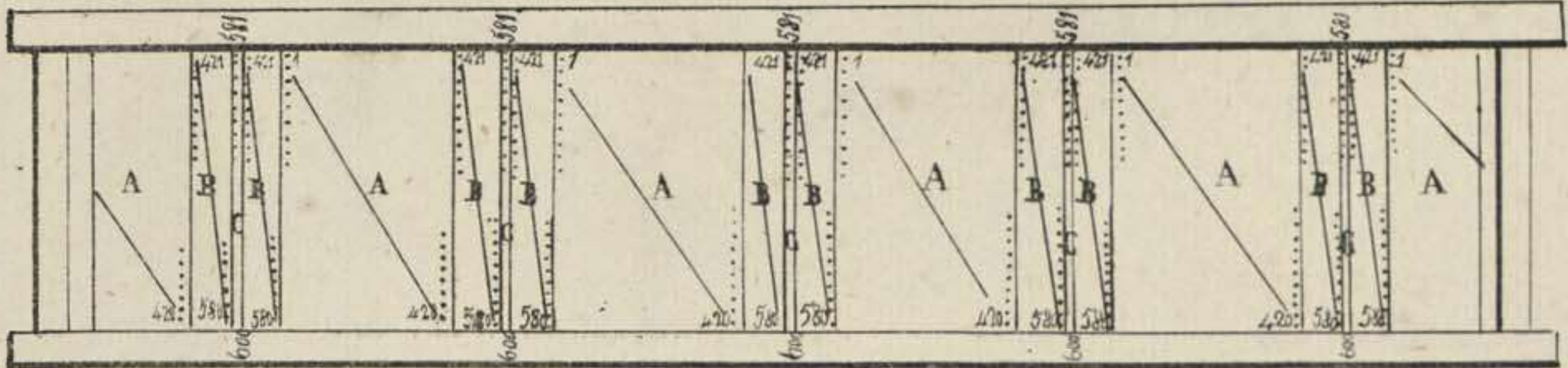
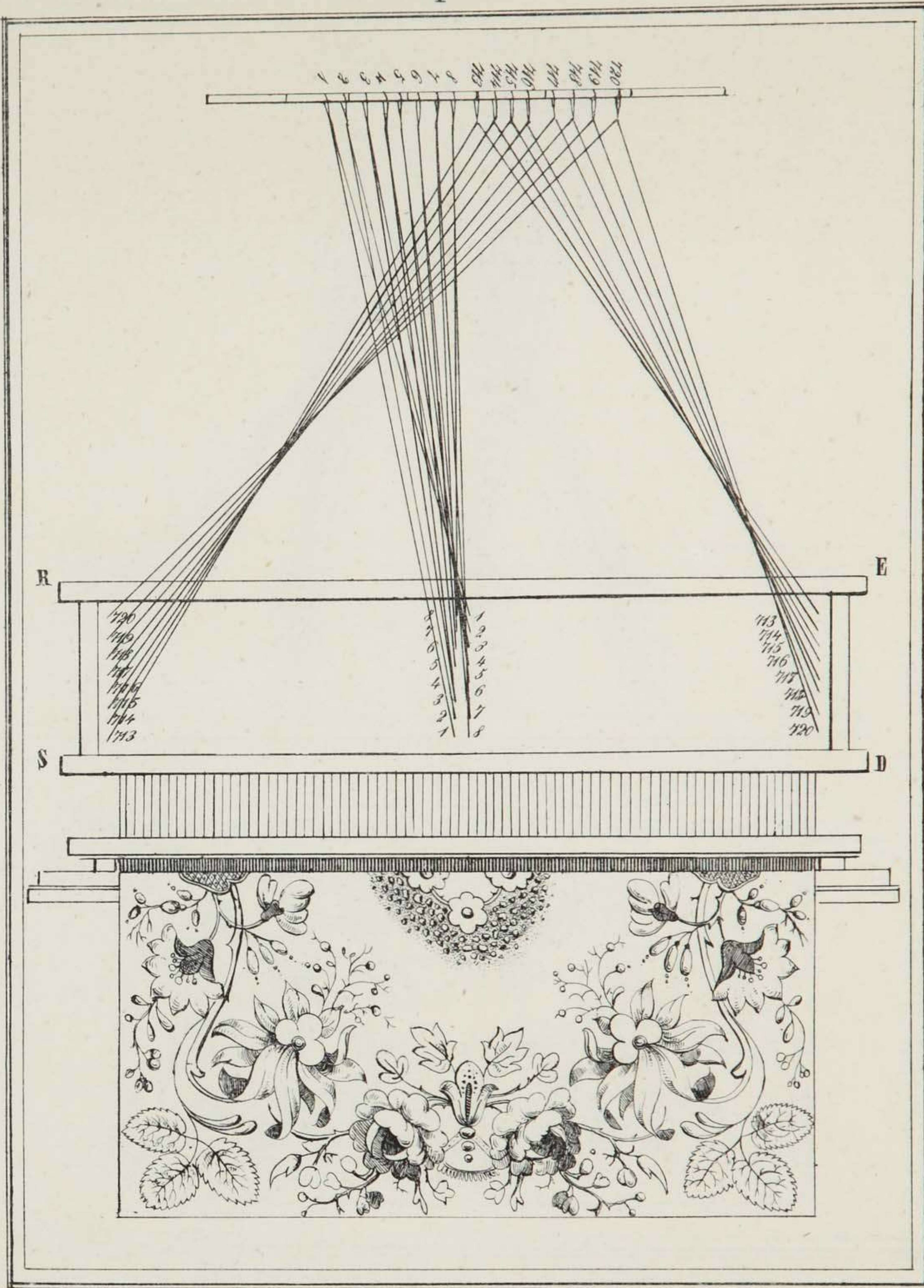


Fig. 7. cor Lám. 56.\*



PASAR LA TABLA  
à punta .

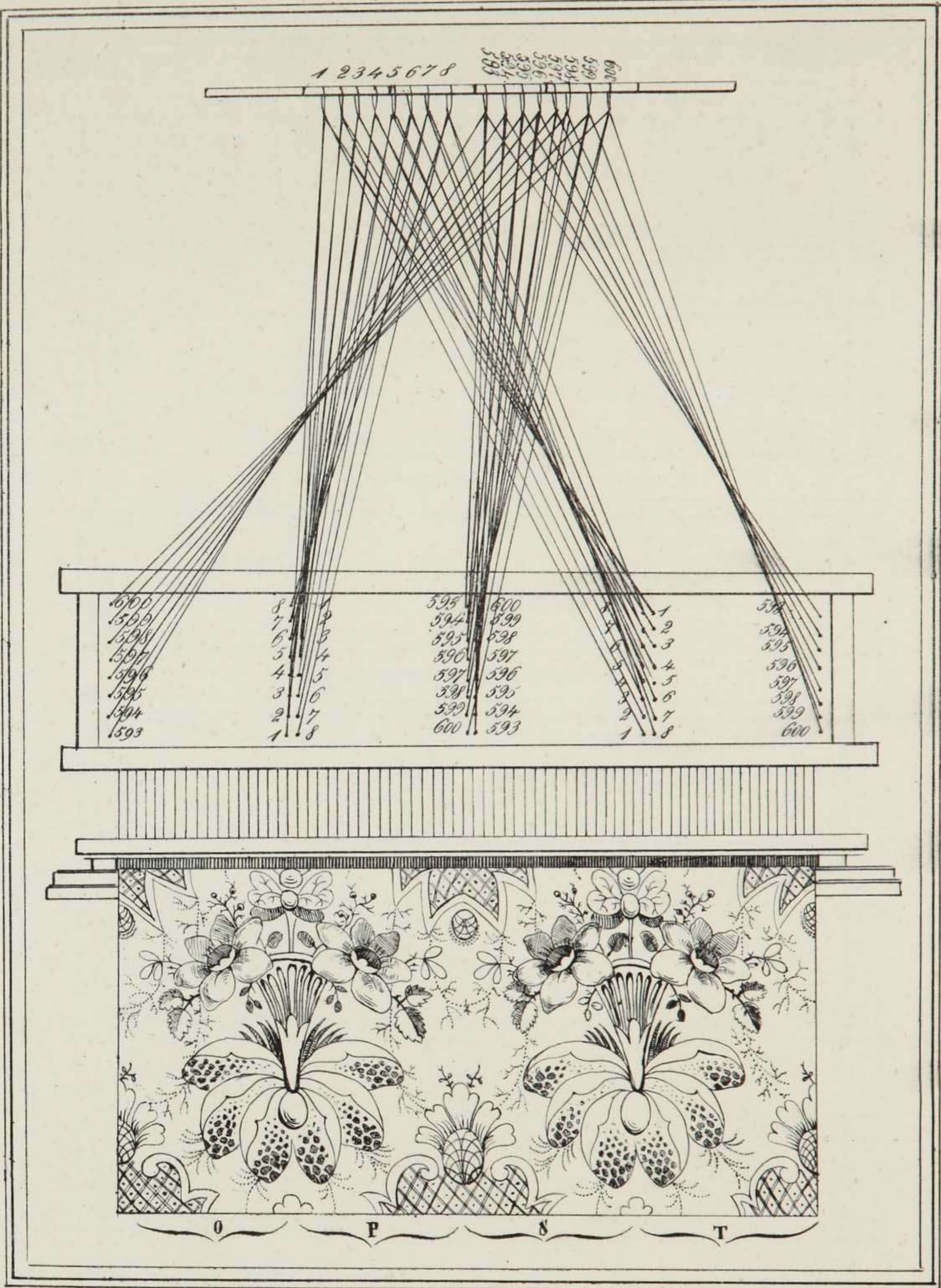
Làm. LIII .



# PASAR LA TABLA

à punta y retorno.

Lám. LIII



PASAR LA TABLA  
Disposiciones.

Lam.<sup>a</sup> LIV.

fig.<sup>a</sup> 1.<sup>a</sup> correspondiente á la lam.<sup>a</sup> 57.

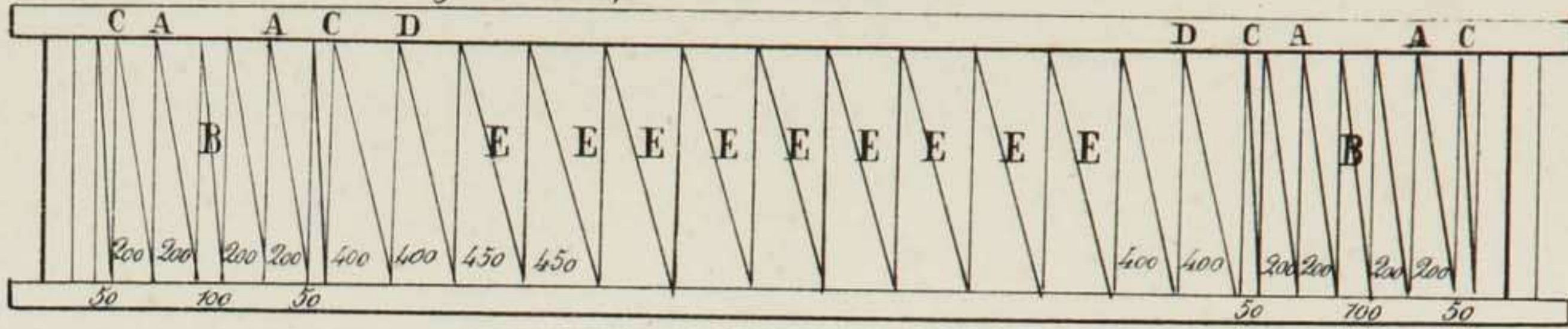


fig.<sup>a</sup> 2.<sup>a</sup>

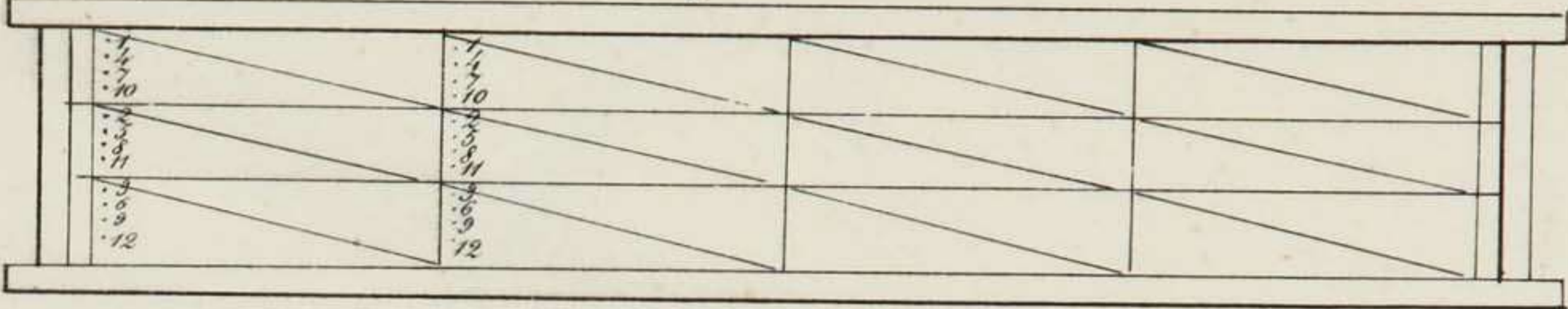


fig.<sup>a</sup> 3.<sup>a</sup> corresp.<sup>te</sup> á la lam.<sup>a</sup> 56.

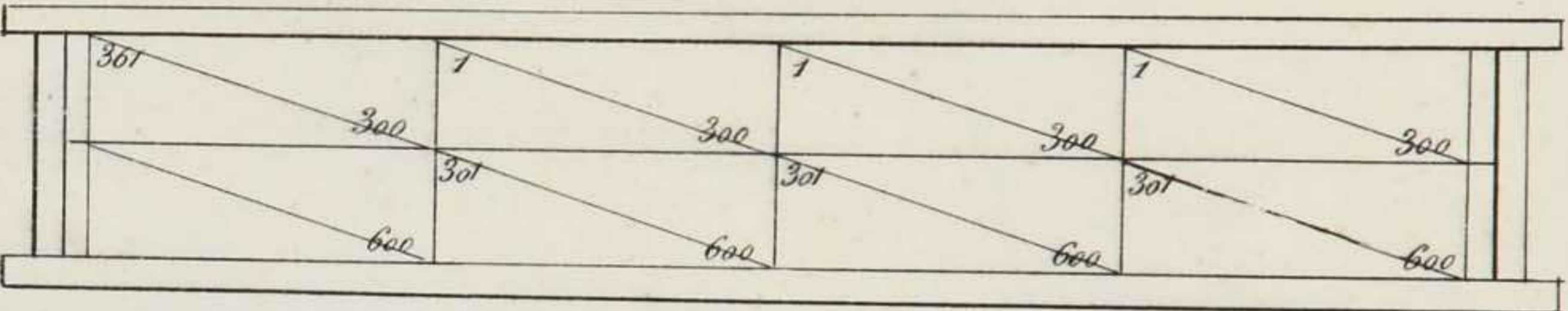


fig.<sup>a</sup> 4.<sup>a</sup> corresp.<sup>te</sup> á la lam.<sup>a</sup> 55.

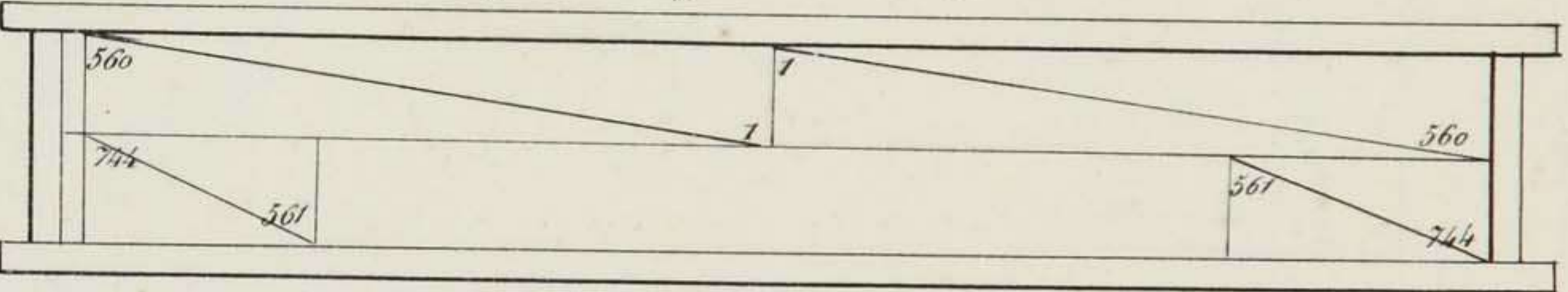


fig.<sup>a</sup> 5.<sup>a</sup>

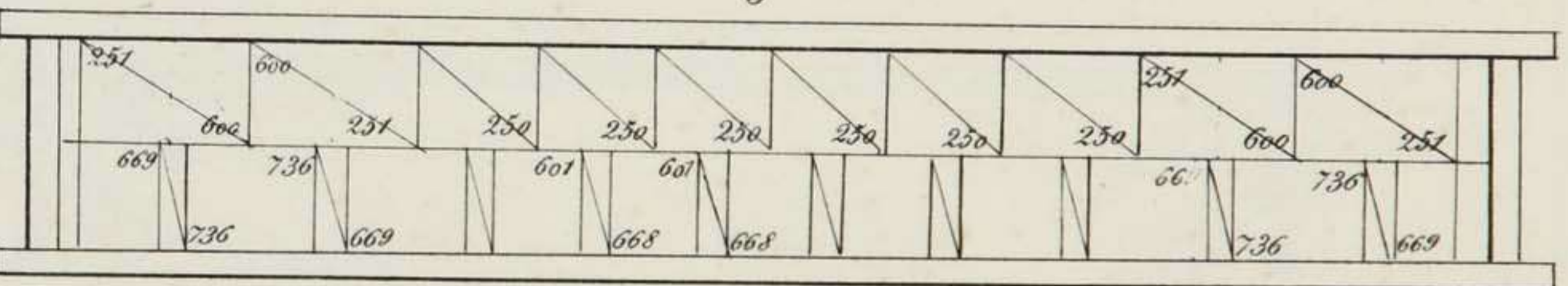
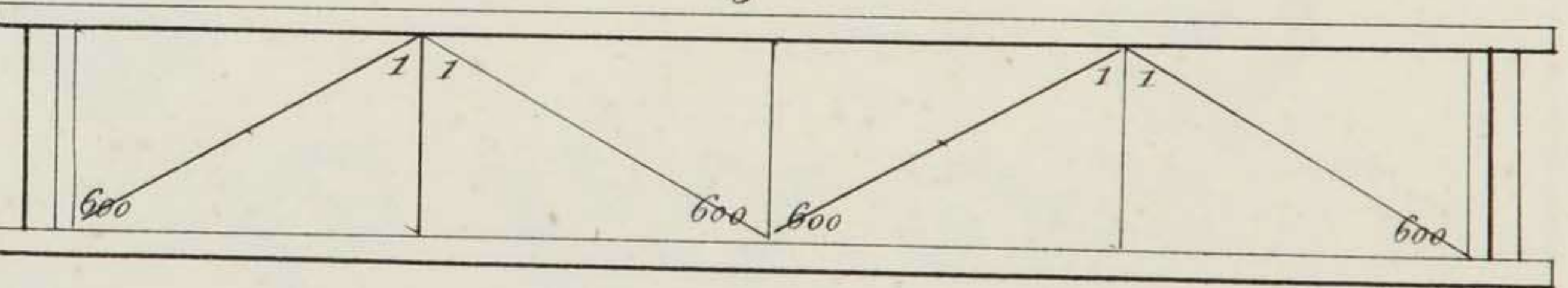


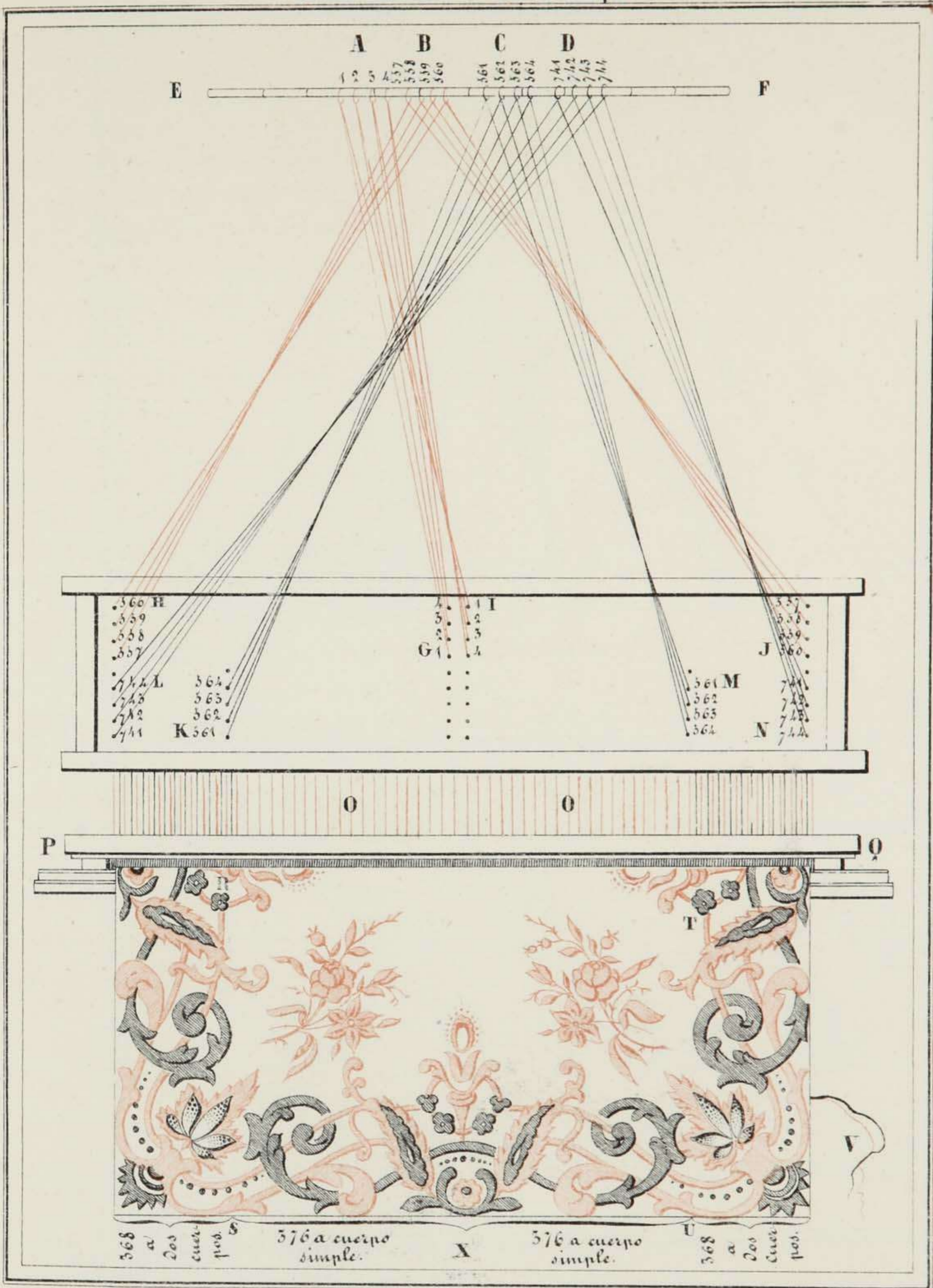
fig.<sup>a</sup> 6.<sup>a</sup>





PASAR LA TABLA  
 Combinacion a Dos Cuerpos.

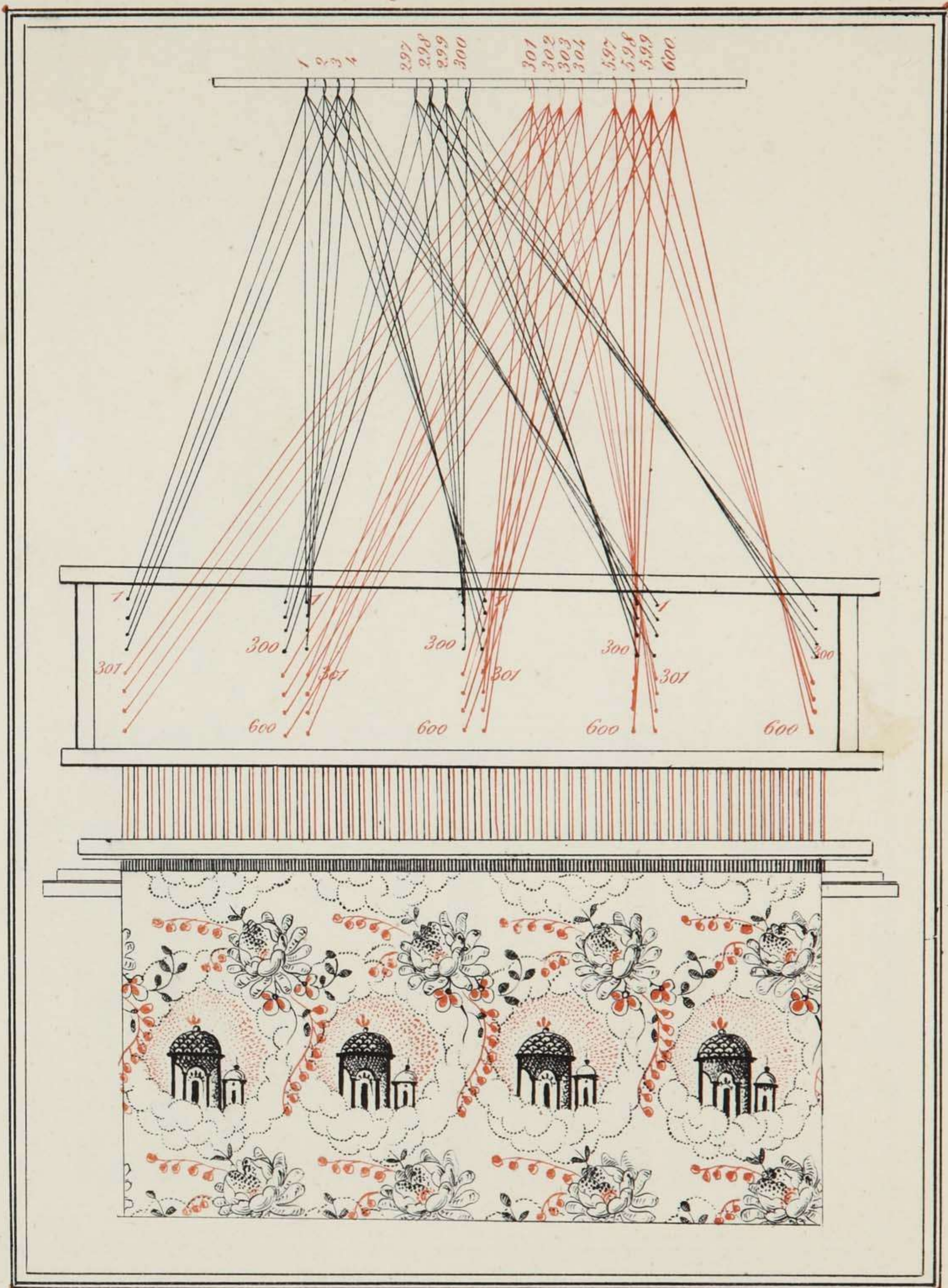
Lam. LV.



# PASAR LA TABLA

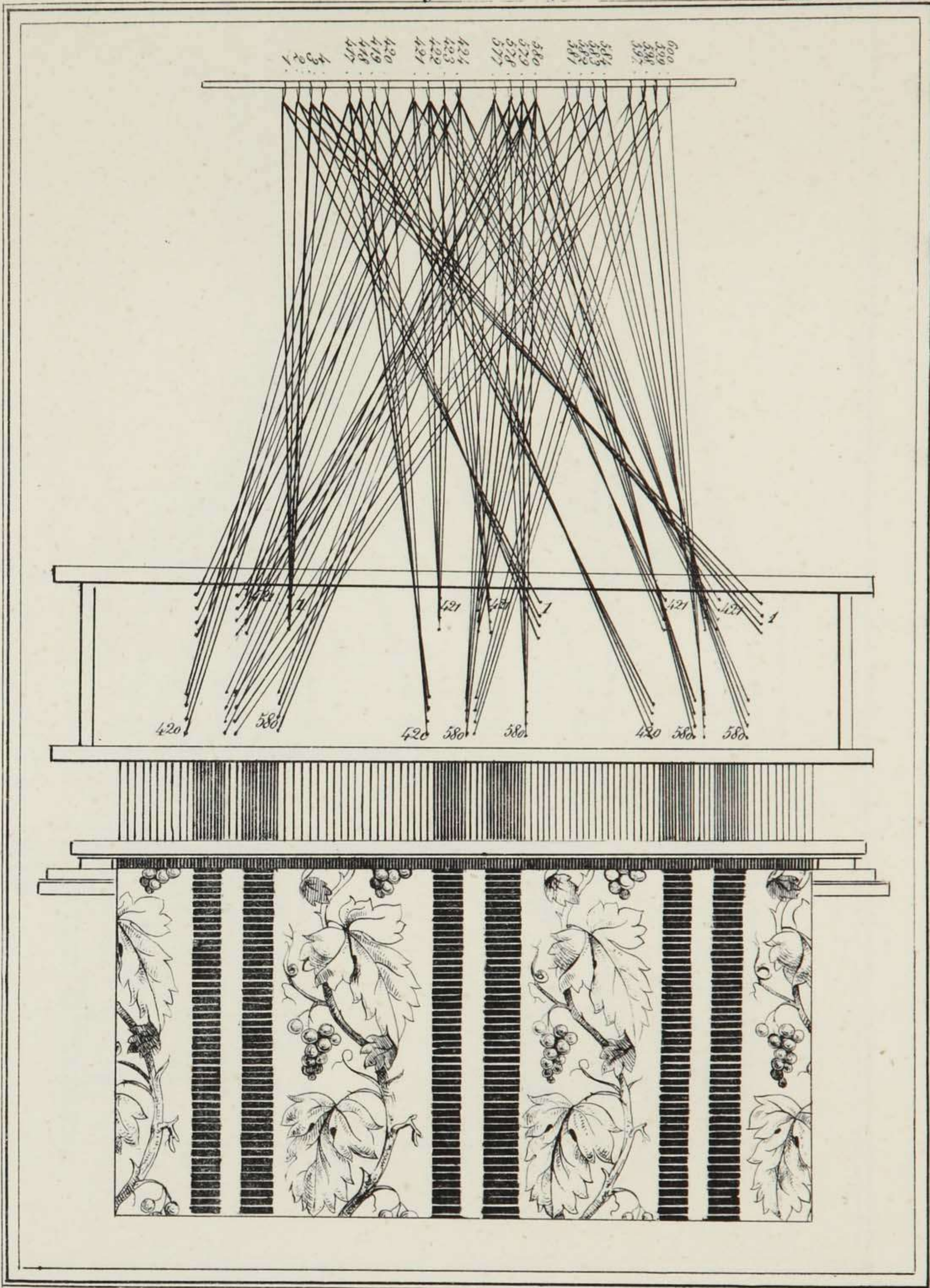
orden seguido á dos cuerpos.

Lam. LVI.



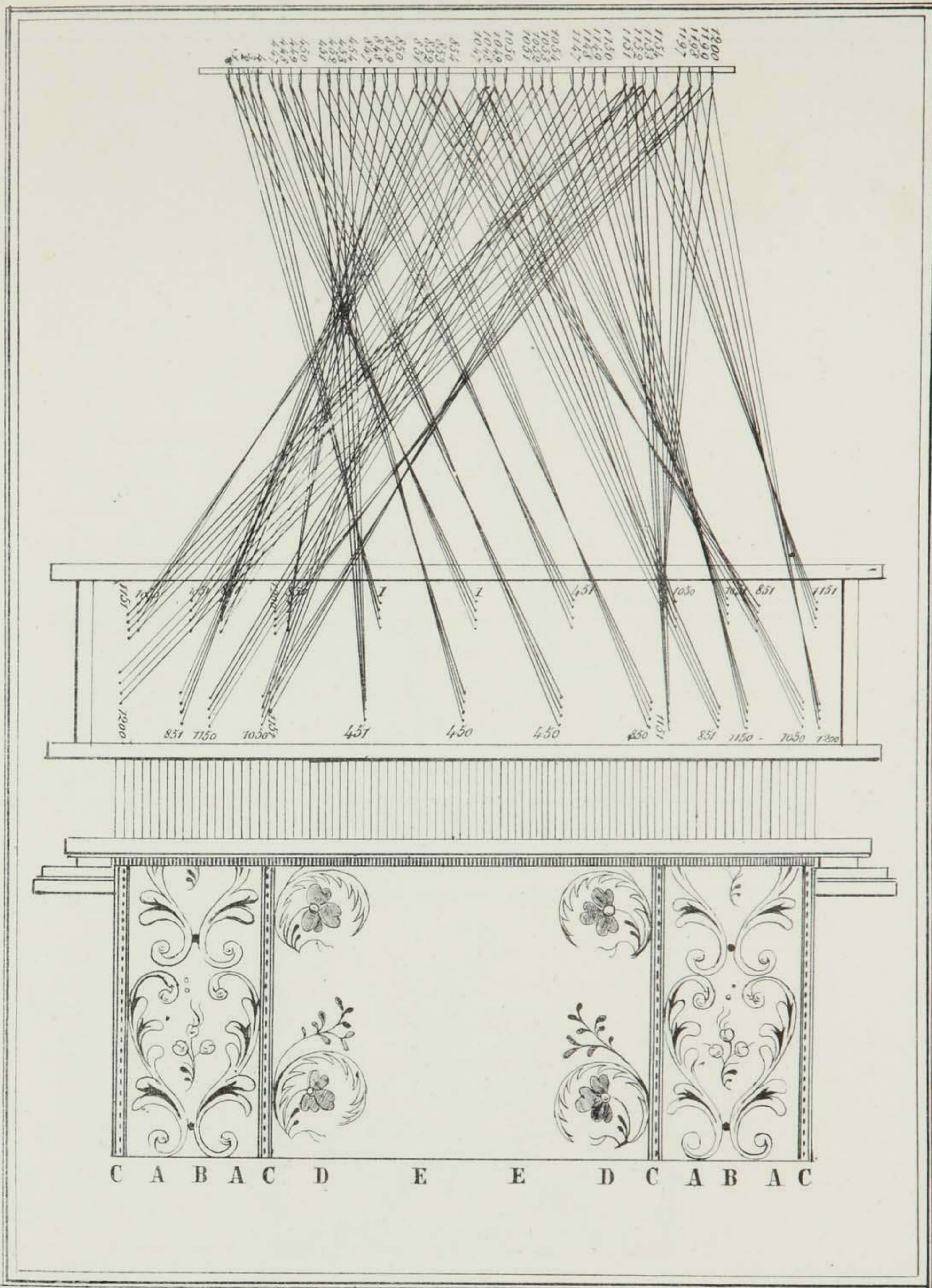
PASAR LA TABLA  
orden seguido compuesto.

Lam.<sup>a</sup> IV \*



PASAR LA TABLA  
orden mixto.

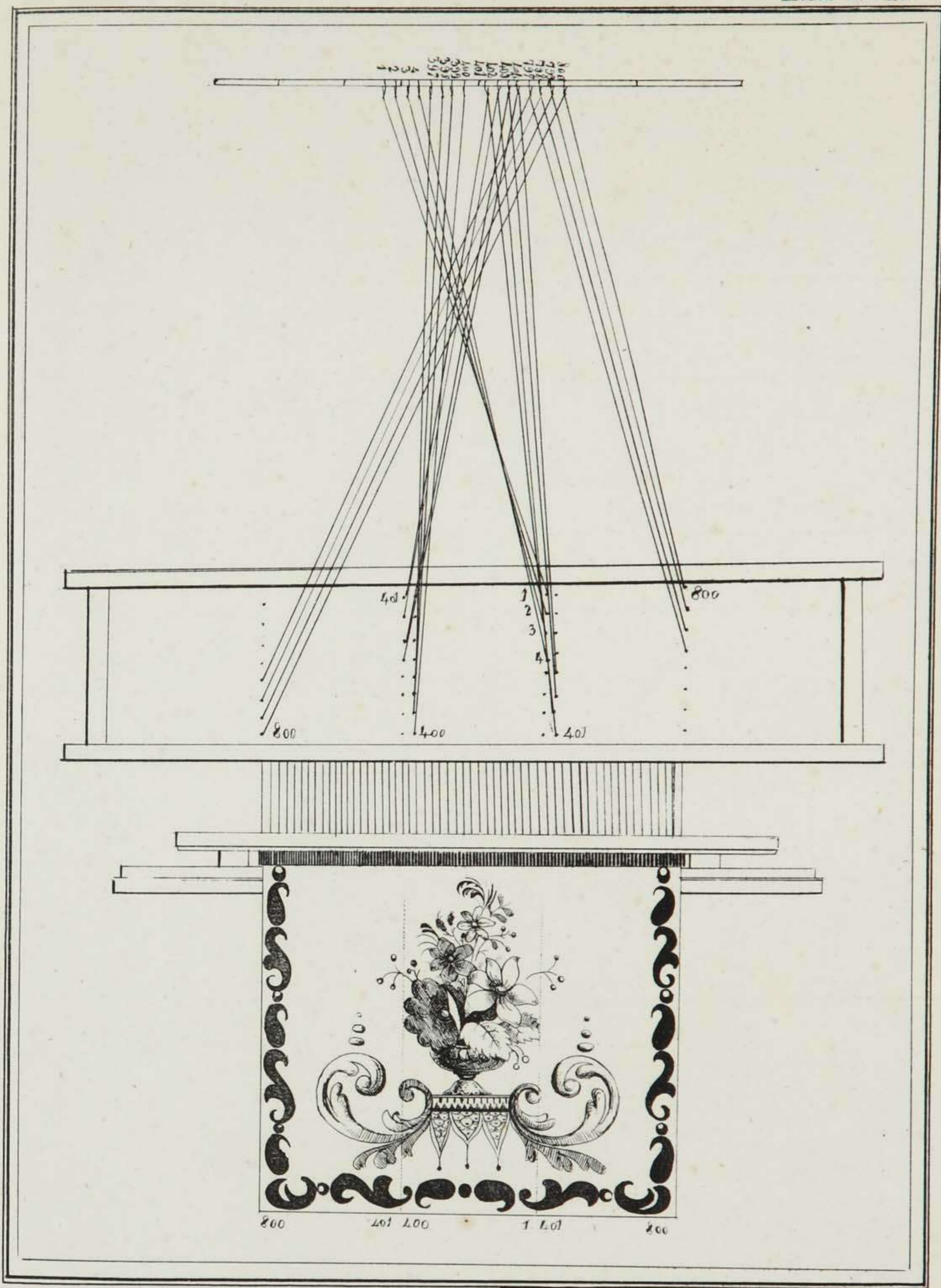
Lam. XVII.



# PASAR LA TABLA

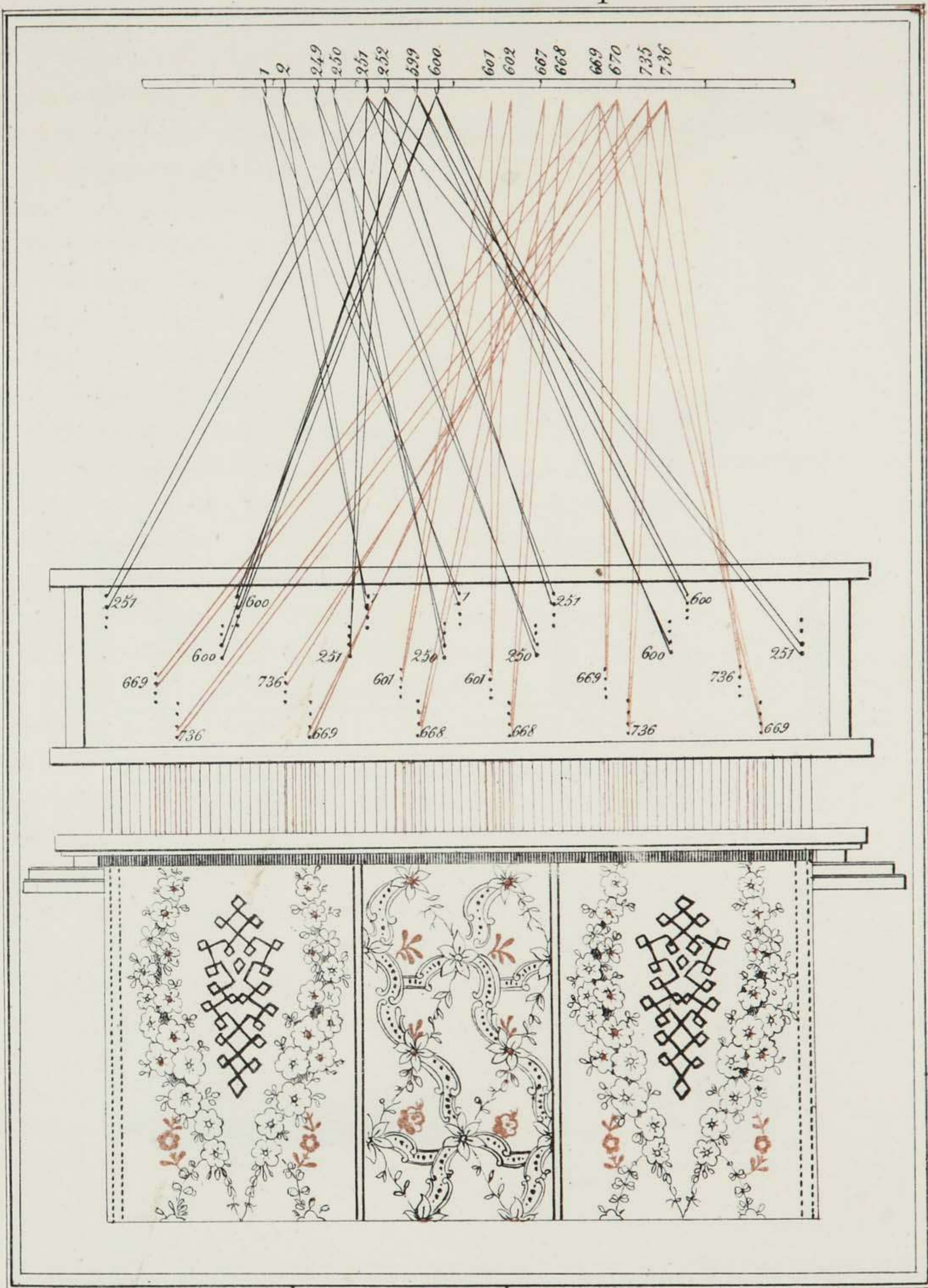
Orden bastardo.

Lam. LVIII.



PASAR LA TABLA  
Combinacion á dos cuerpos.

Lám. LIX



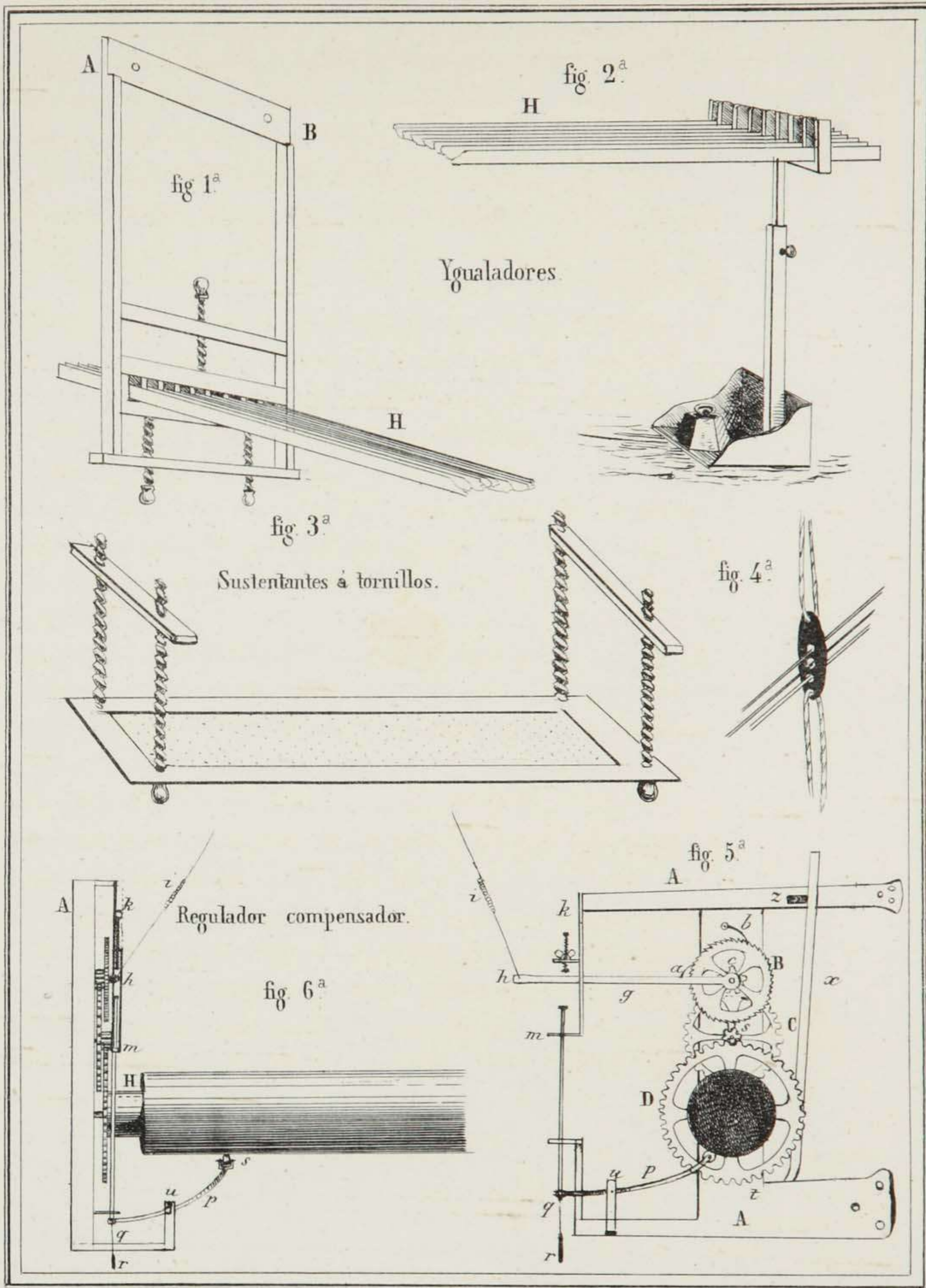


fig 1<sup>a</sup>



fig 2<sup>a</sup>

COMPOSICIONES.

fig 3<sup>a</sup>

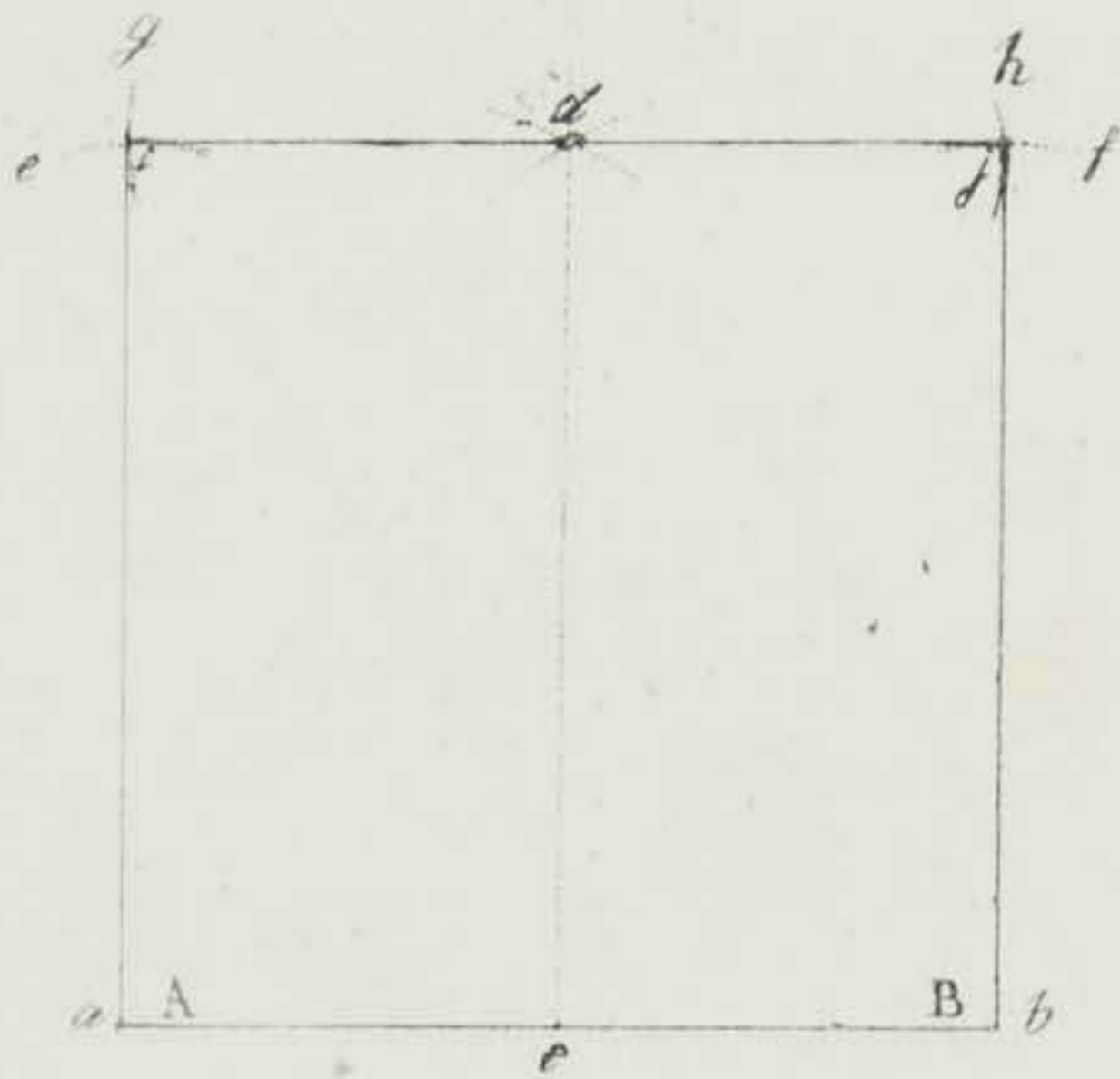


fig 4<sup>a</sup>

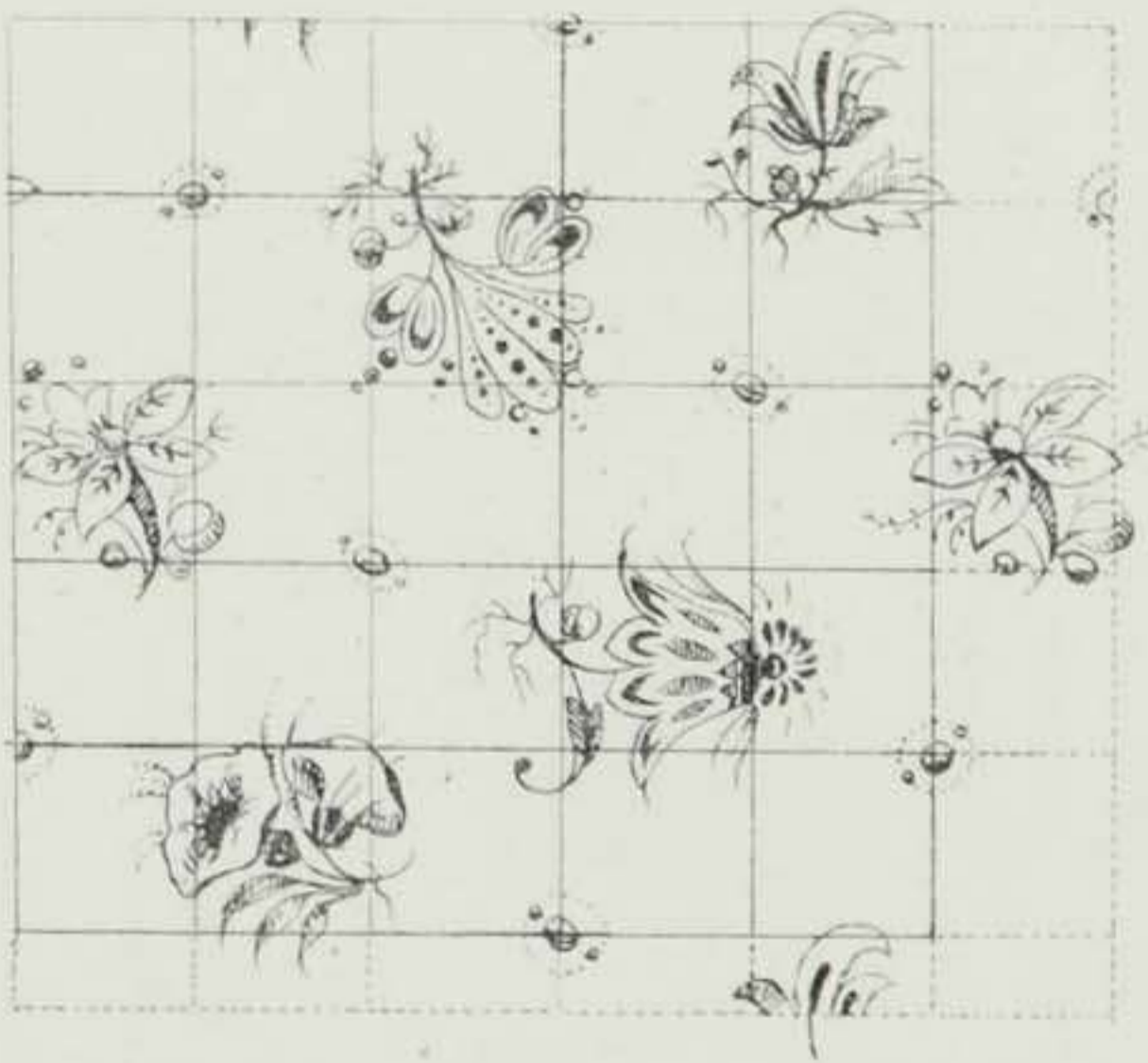


fig 5<sup>a</sup>

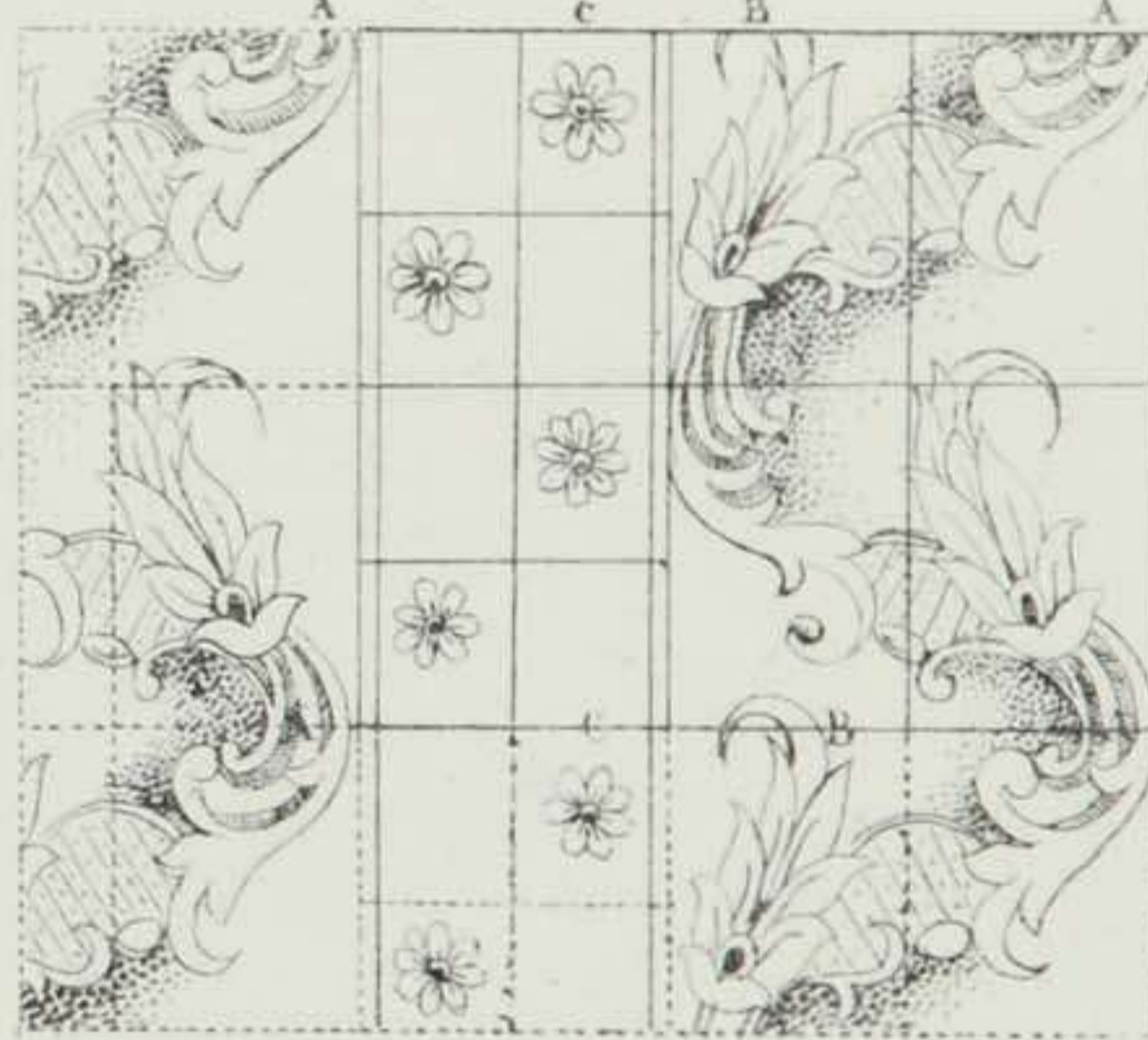




fig. 1<sup>a</sup>

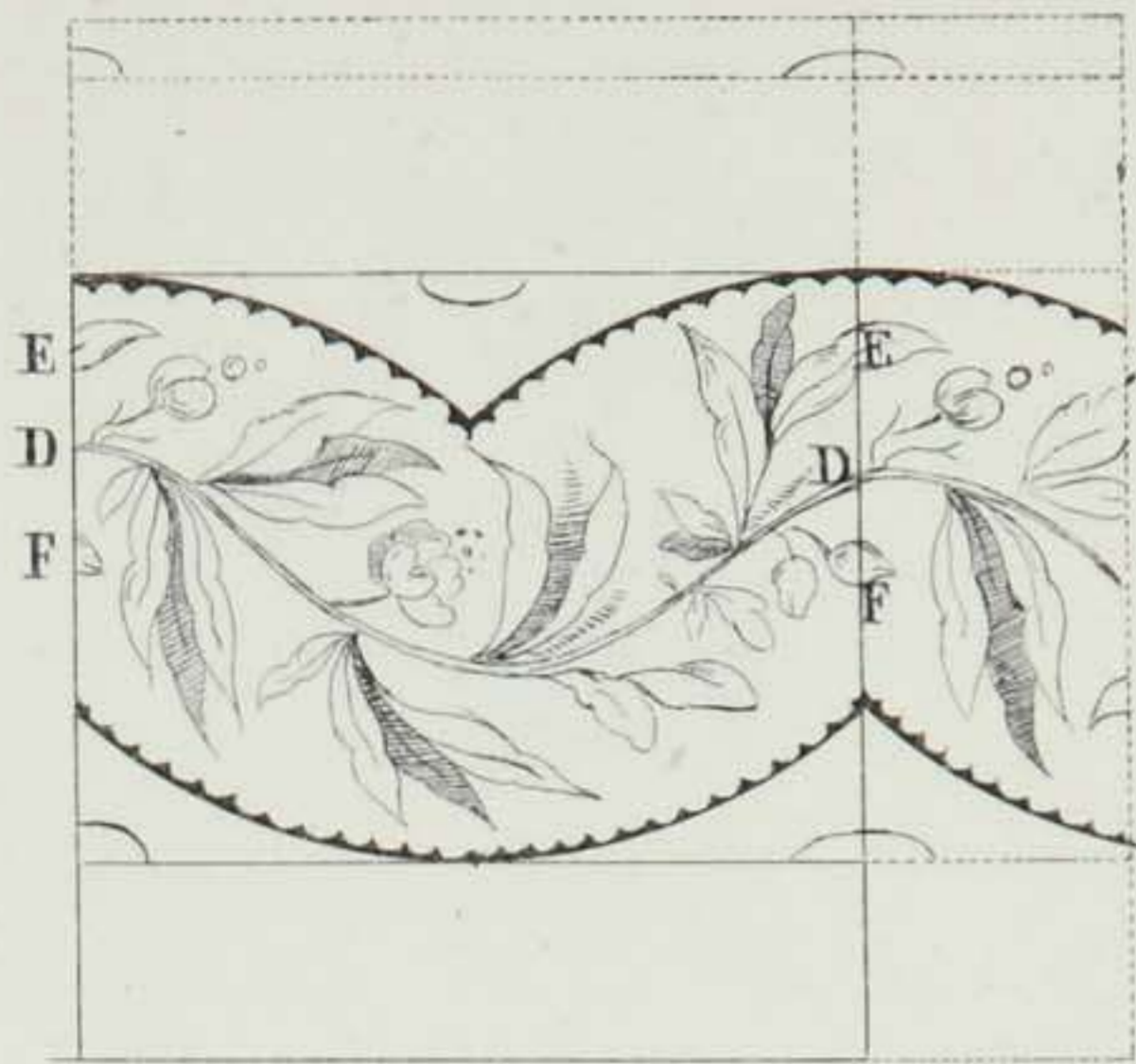


fig. 2<sup>a</sup>

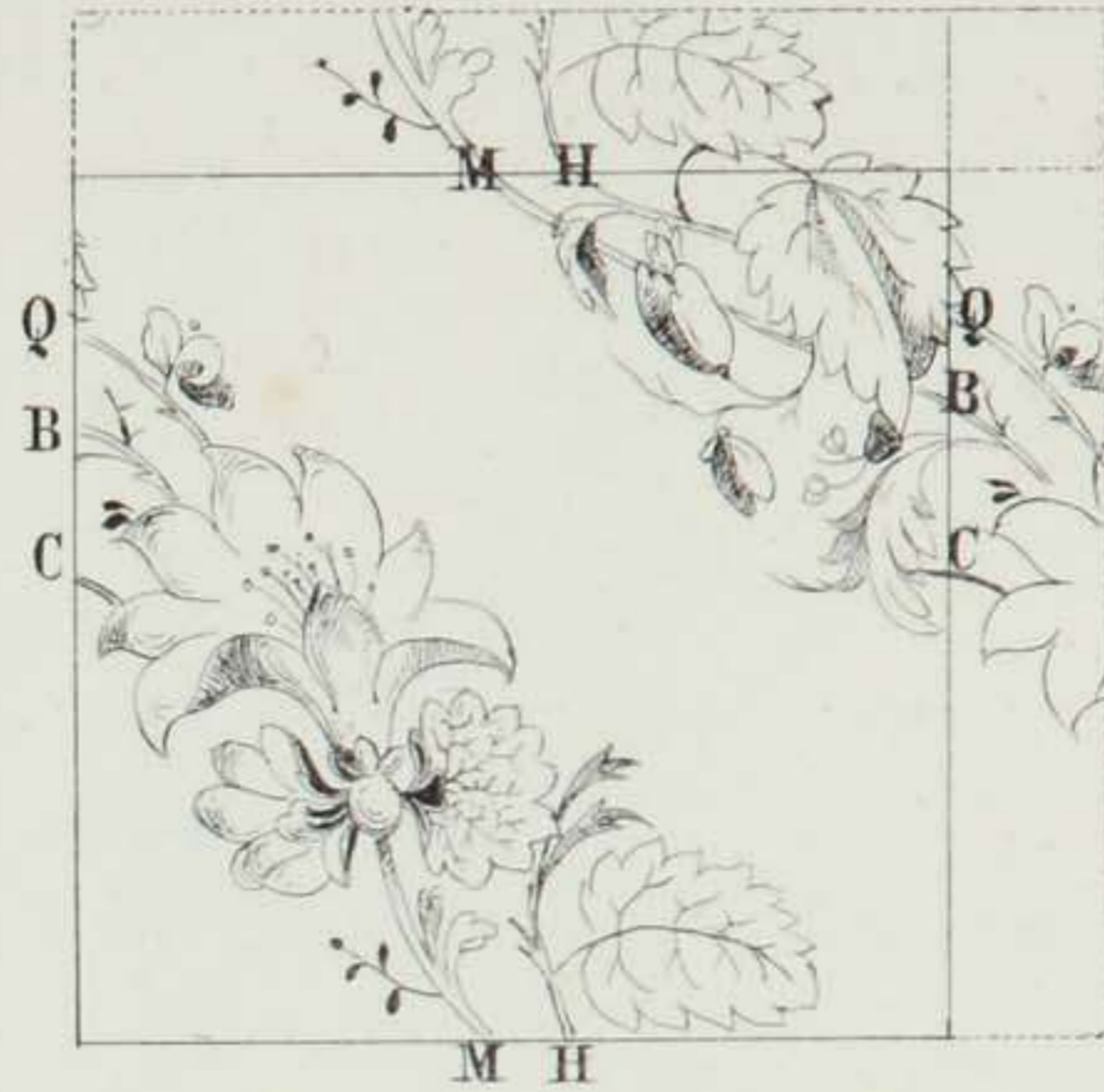


fig. 3<sup>a</sup>

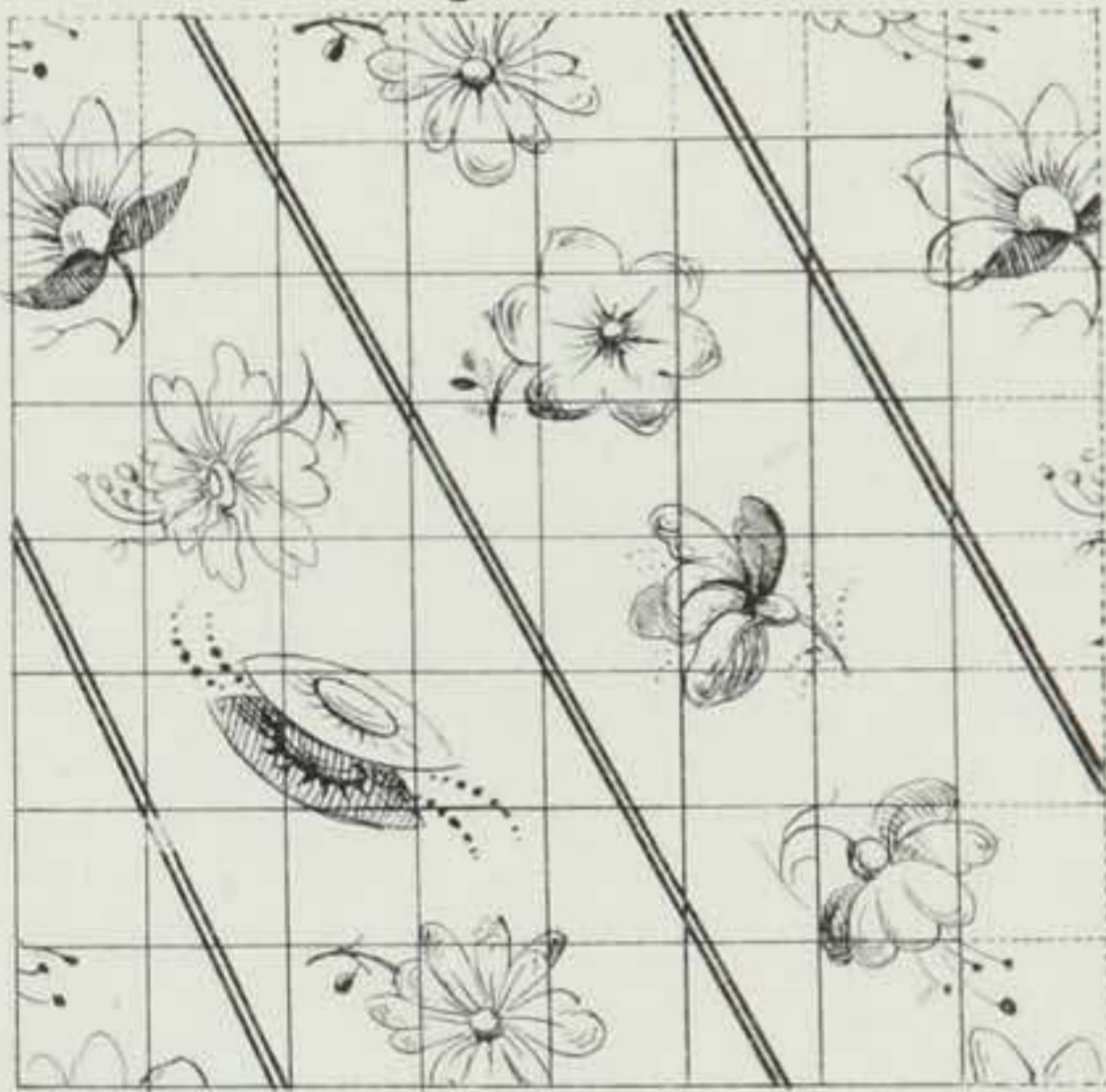


fig. 4<sup>a</sup>

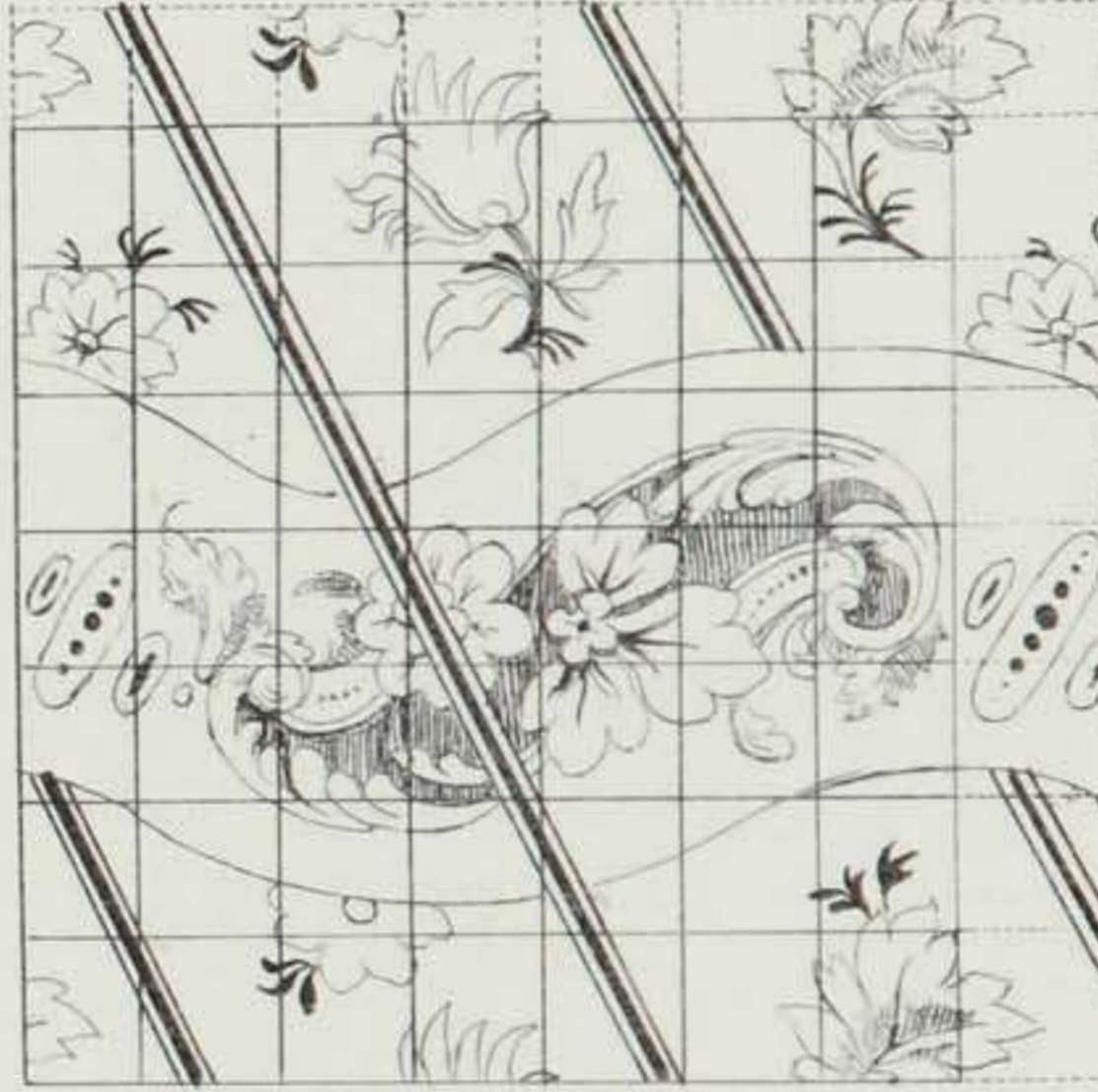


fig. 5<sup>a</sup>

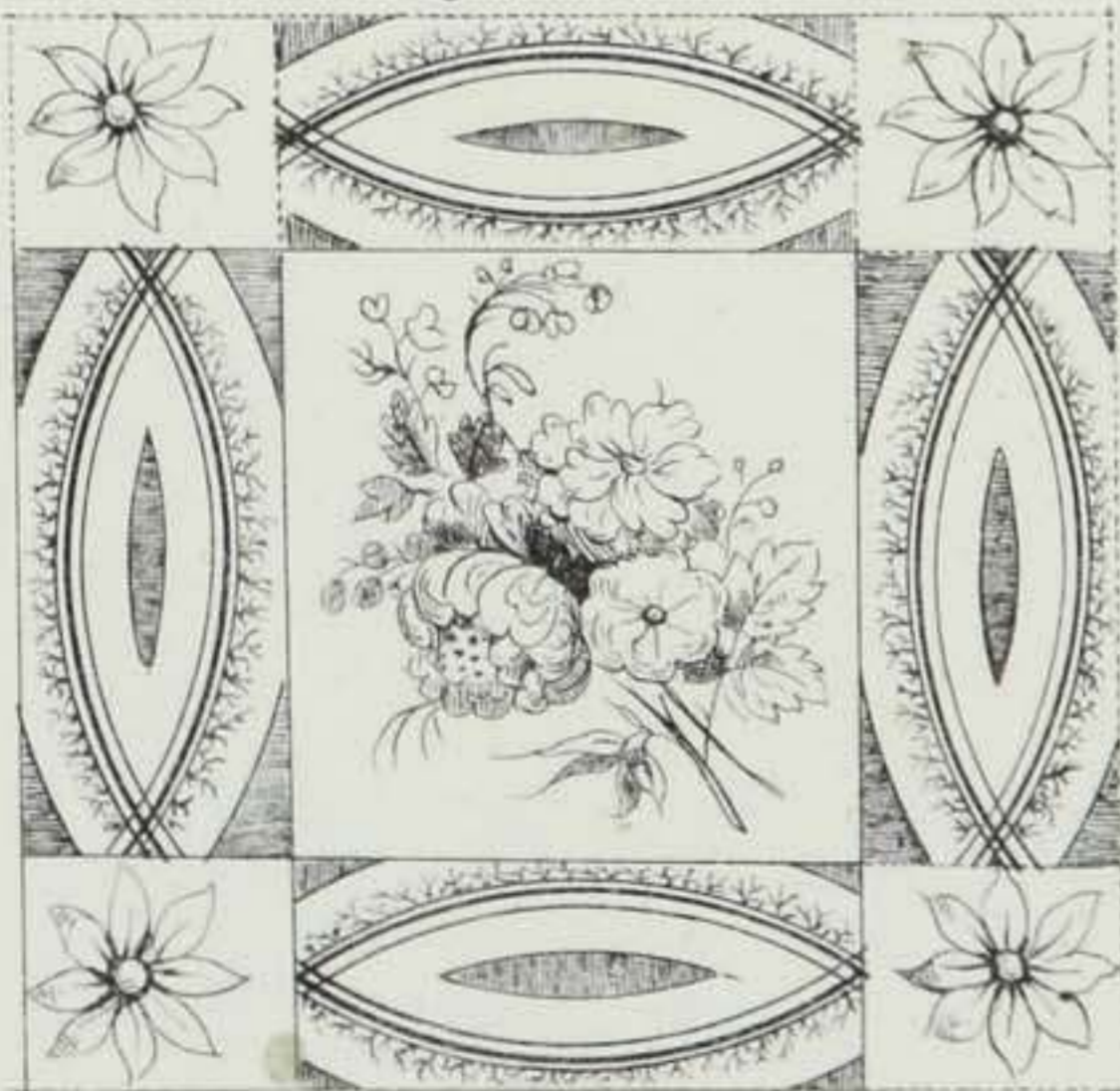


fig. 6<sup>a</sup>



fig. 2<sup>a</sup>

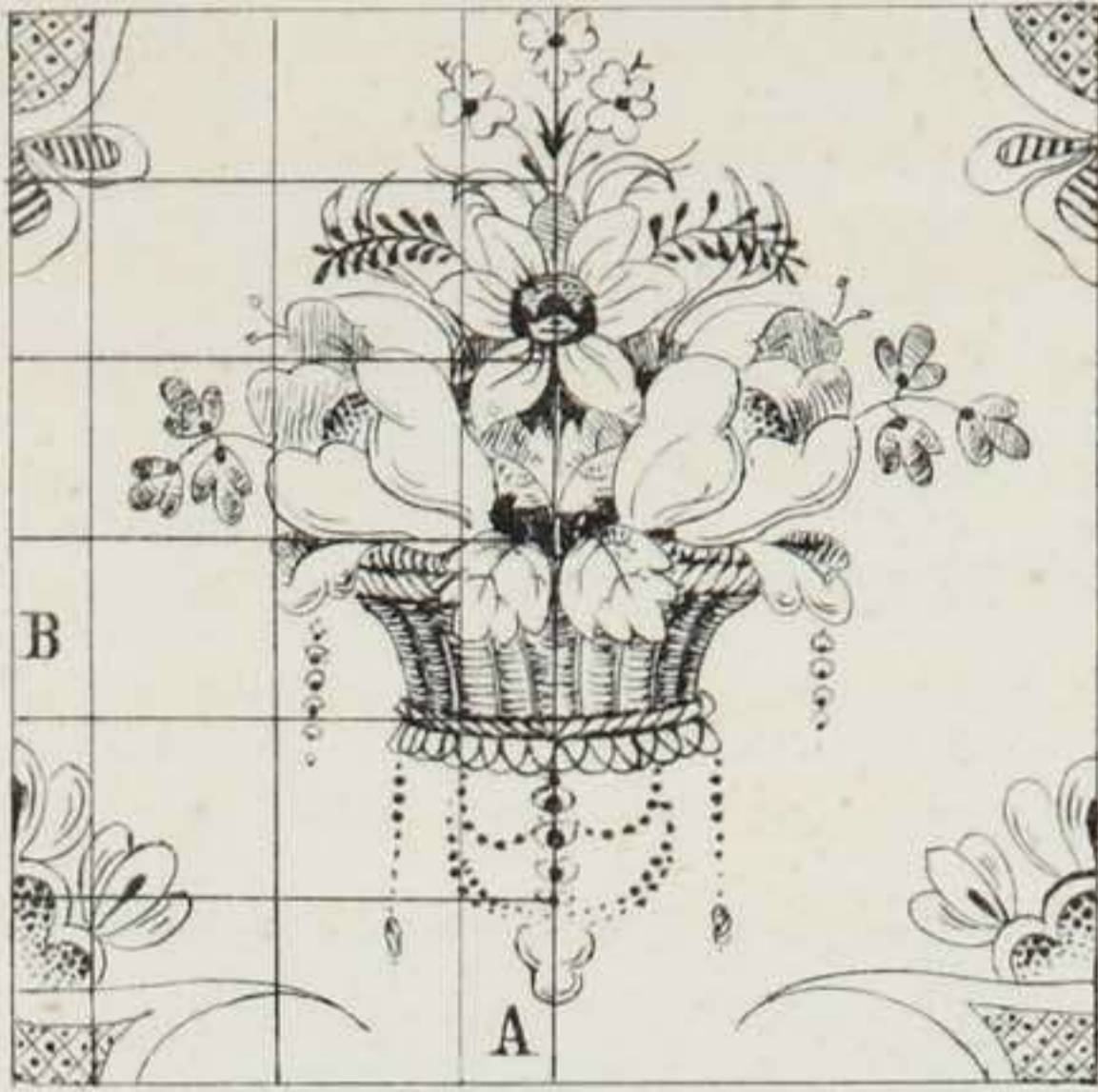


fig. 1<sup>a</sup>

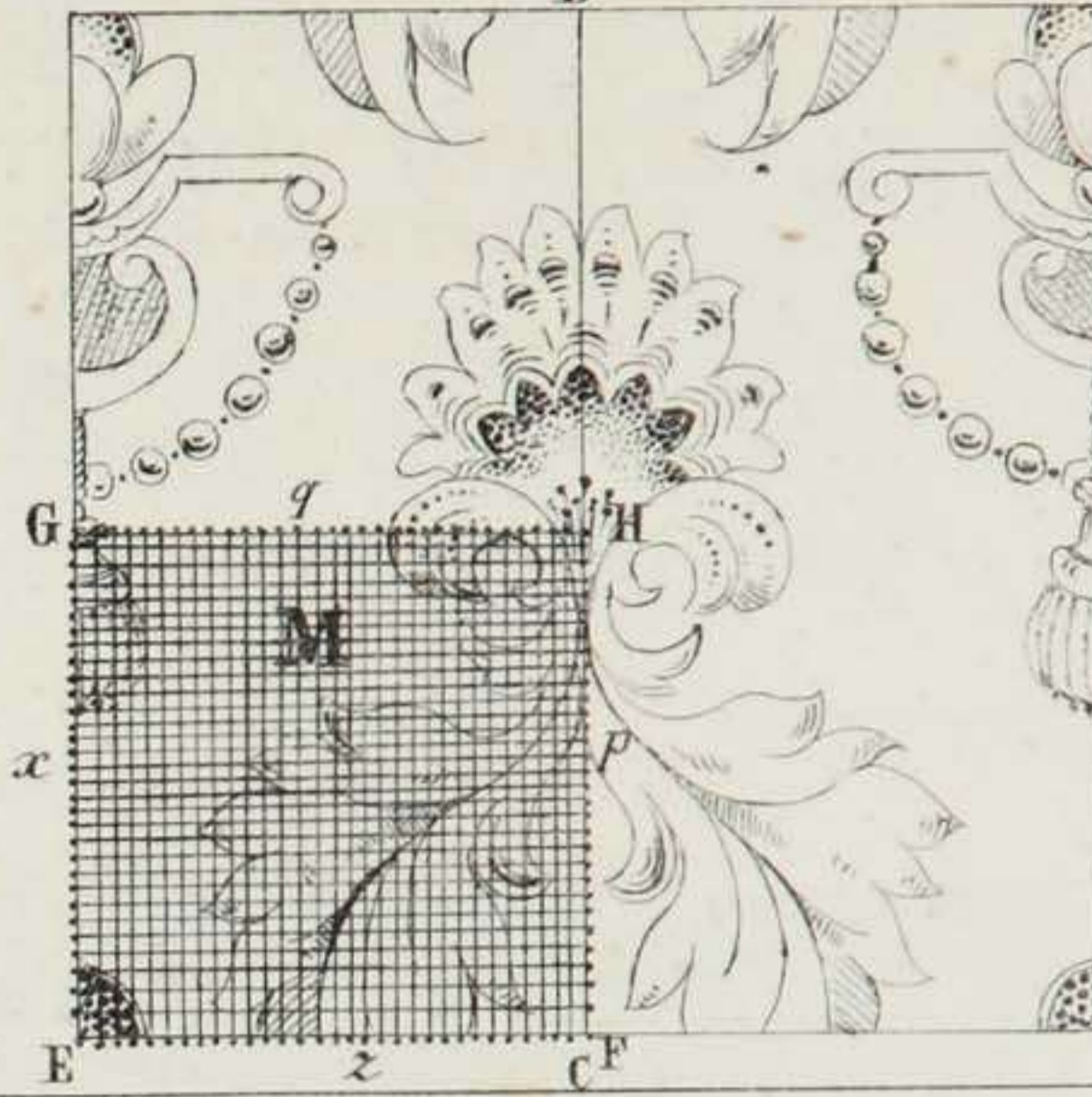


fig. 3<sup>a</sup>

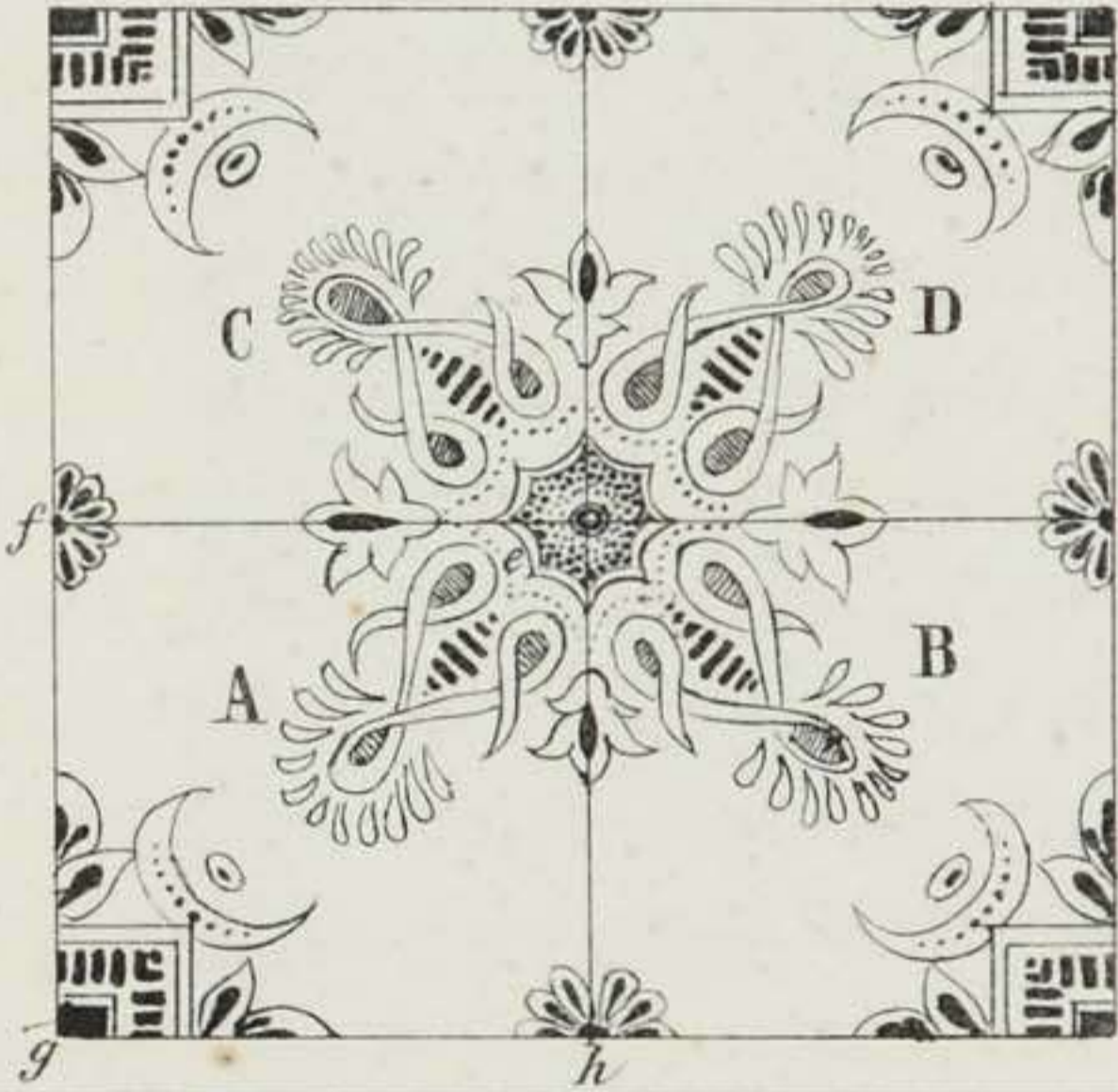


fig. 4<sup>a</sup>



fig. 5<sup>a</sup>

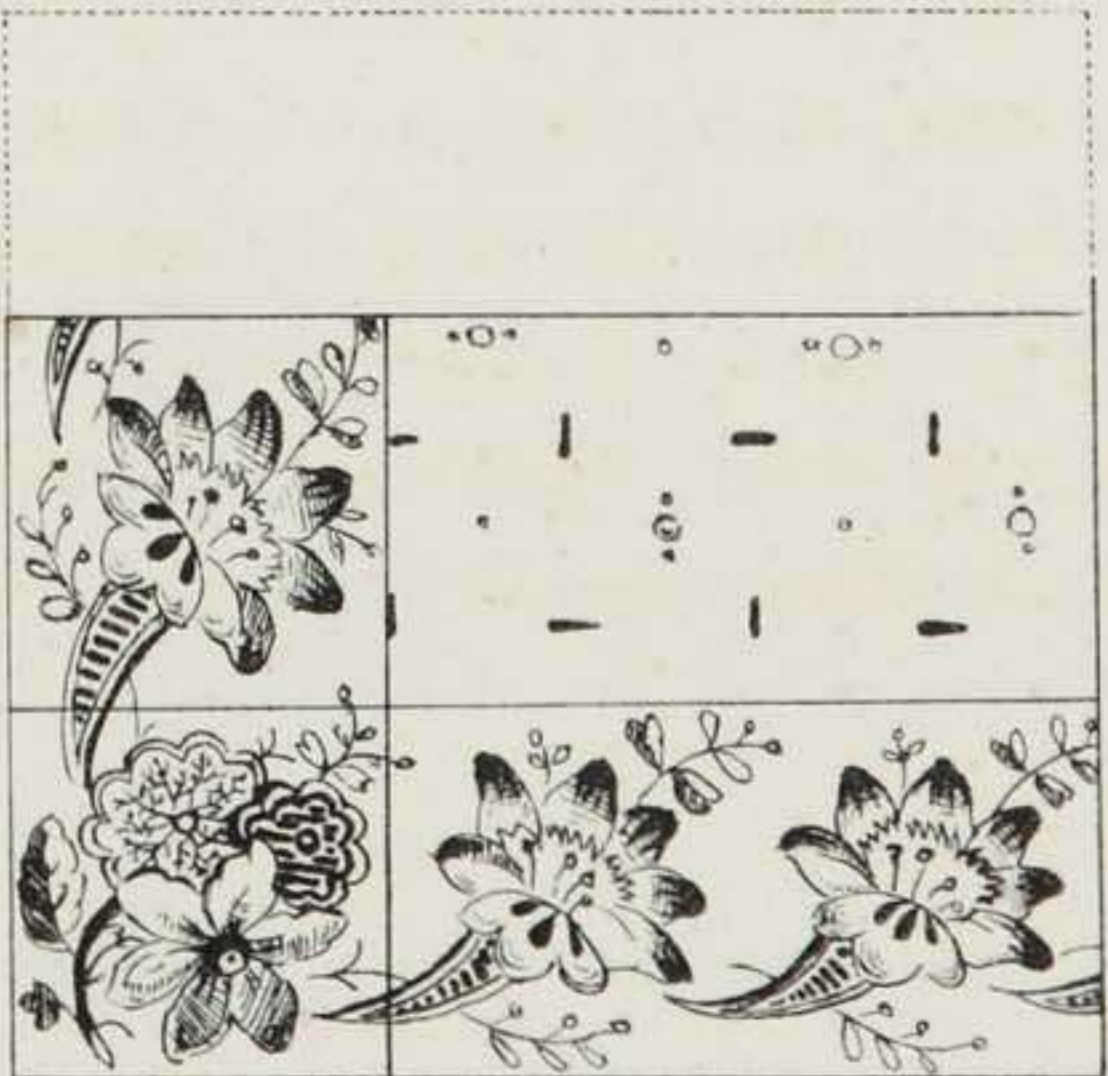
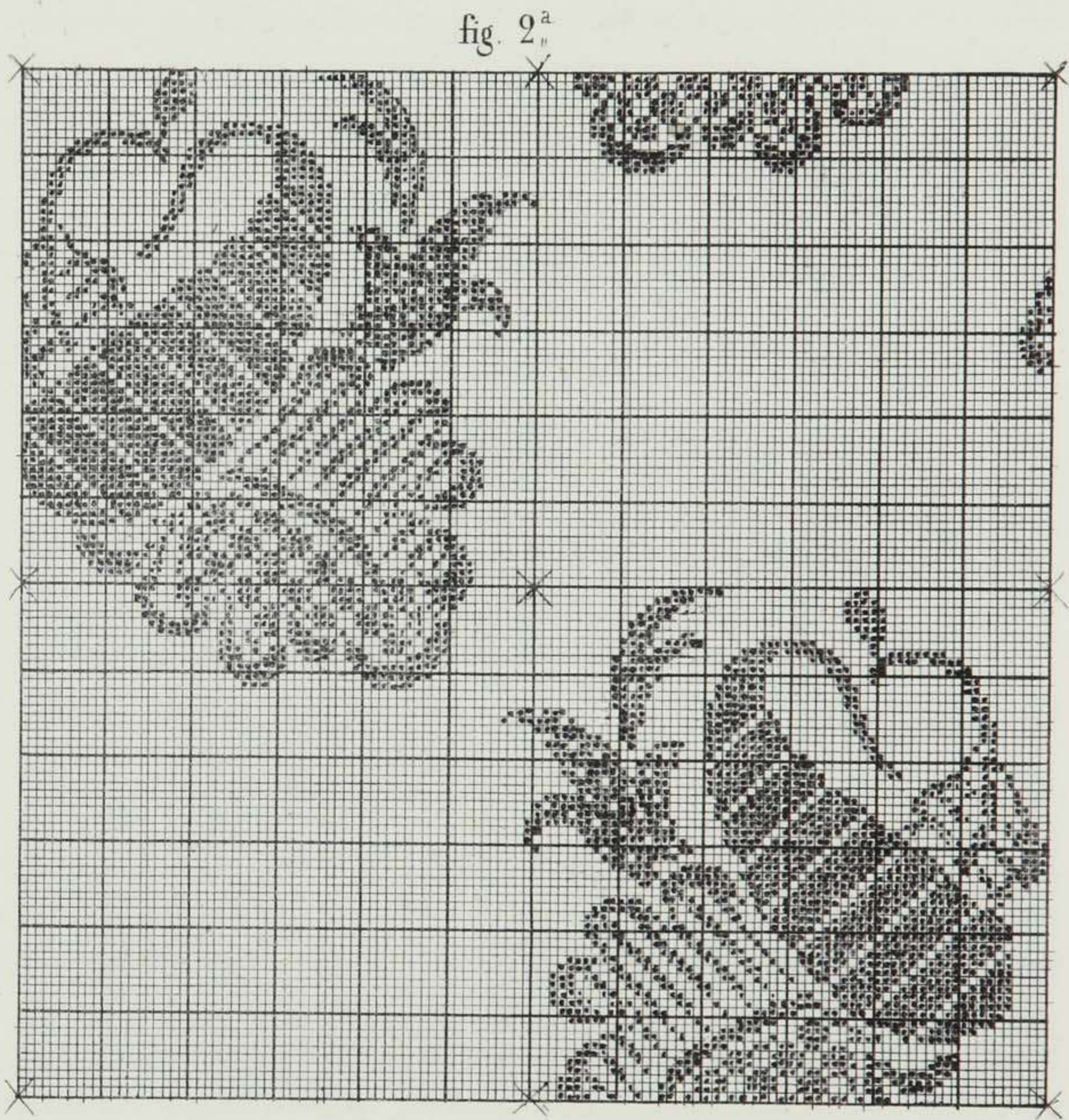
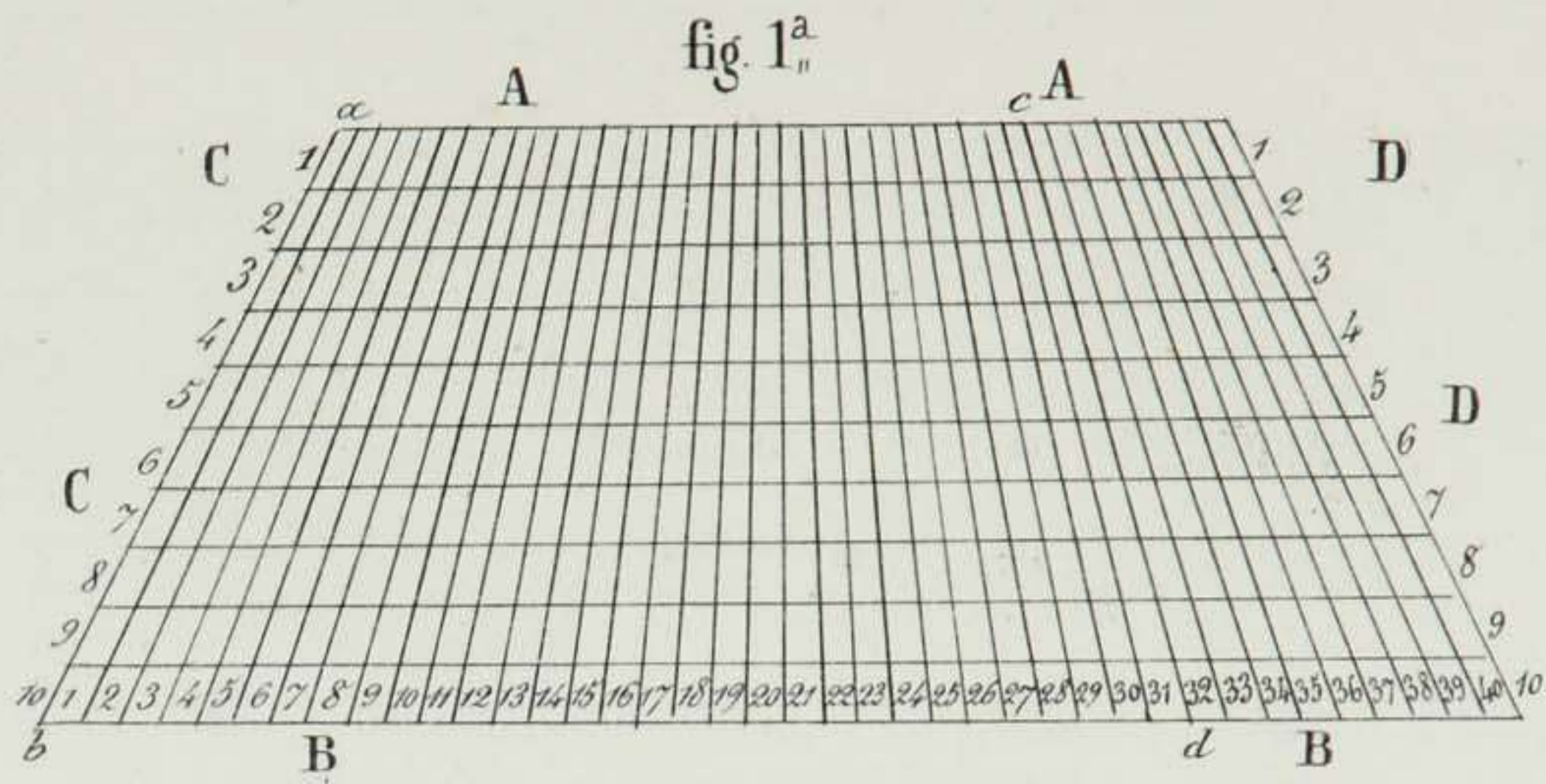


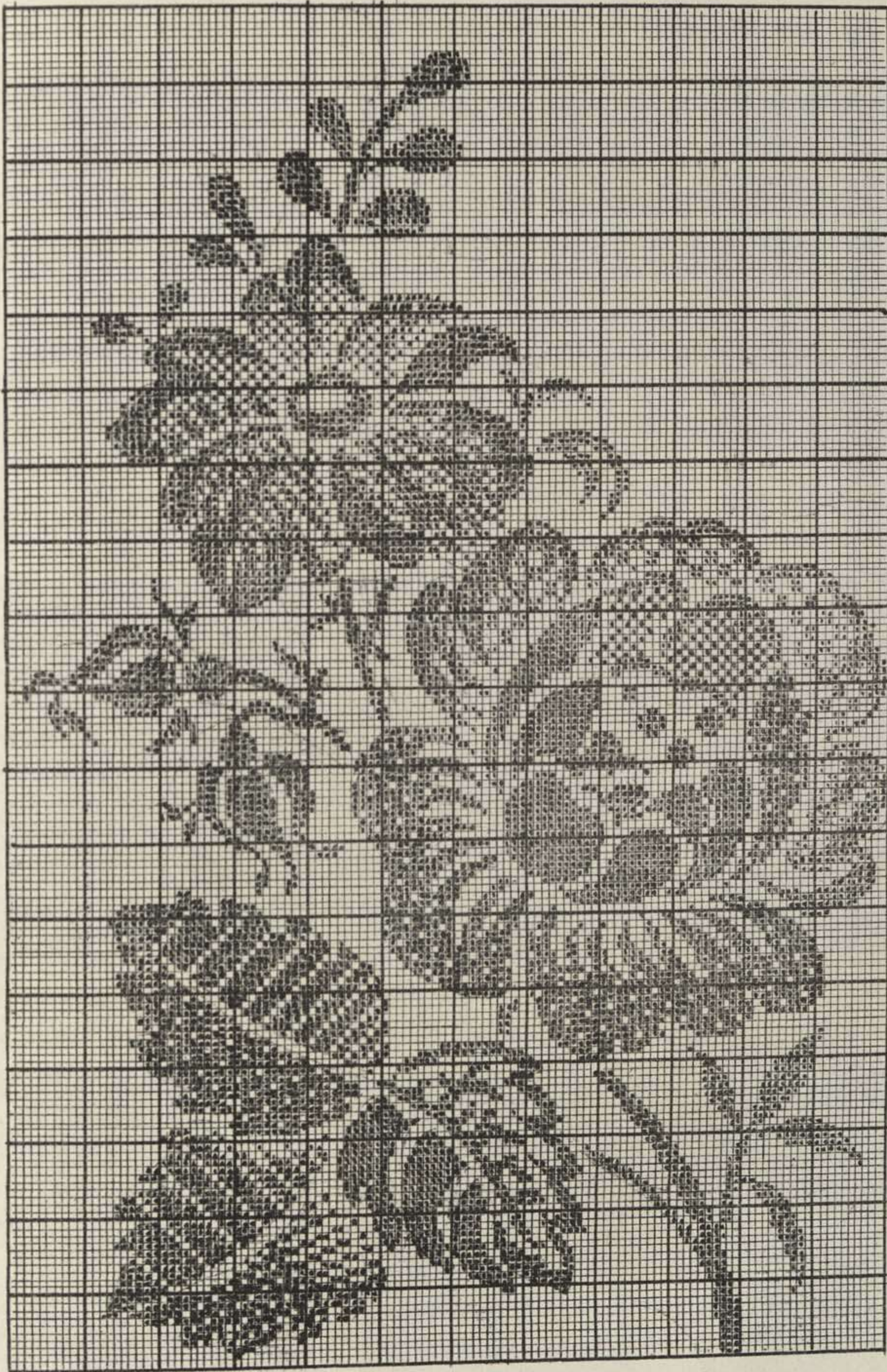
fig. 6<sup>a</sup>





PUESTA EN CARTA.

*Lám. LXV.*



SOMBREADOS.

Lám. LXVI.

fig. 1<sup>a</sup>

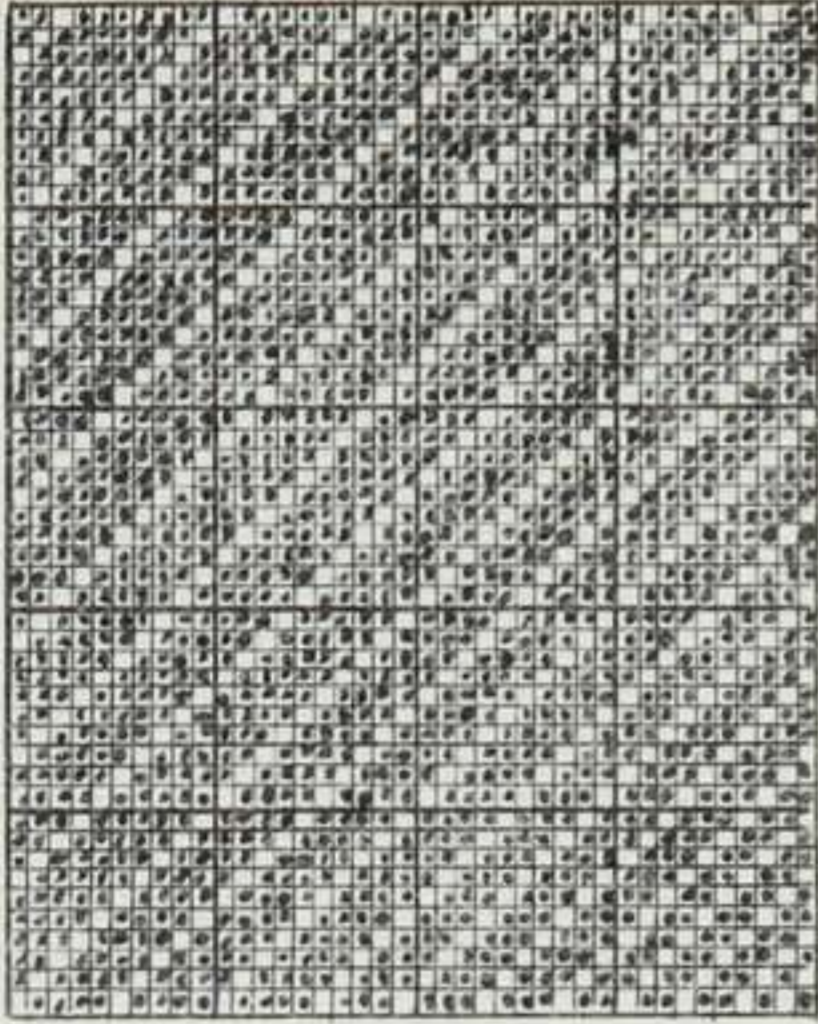


fig. 2<sup>a</sup>

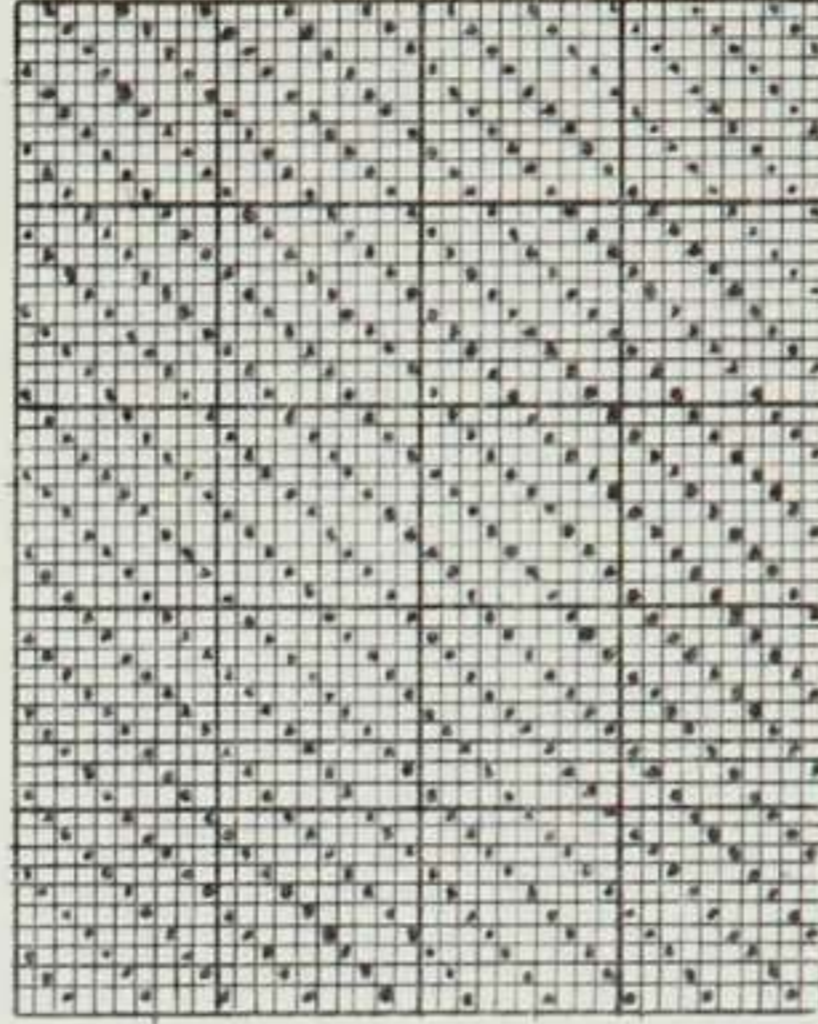


fig. 3<sup>a</sup>

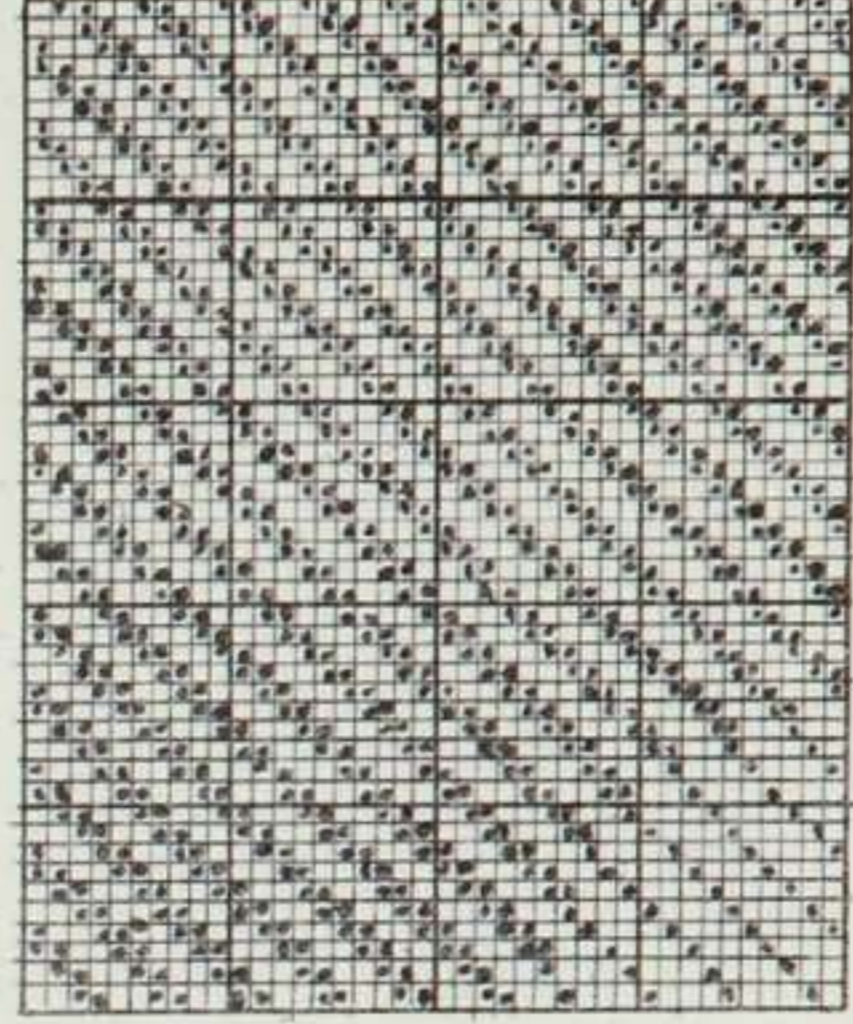


fig. 4<sup>a</sup>

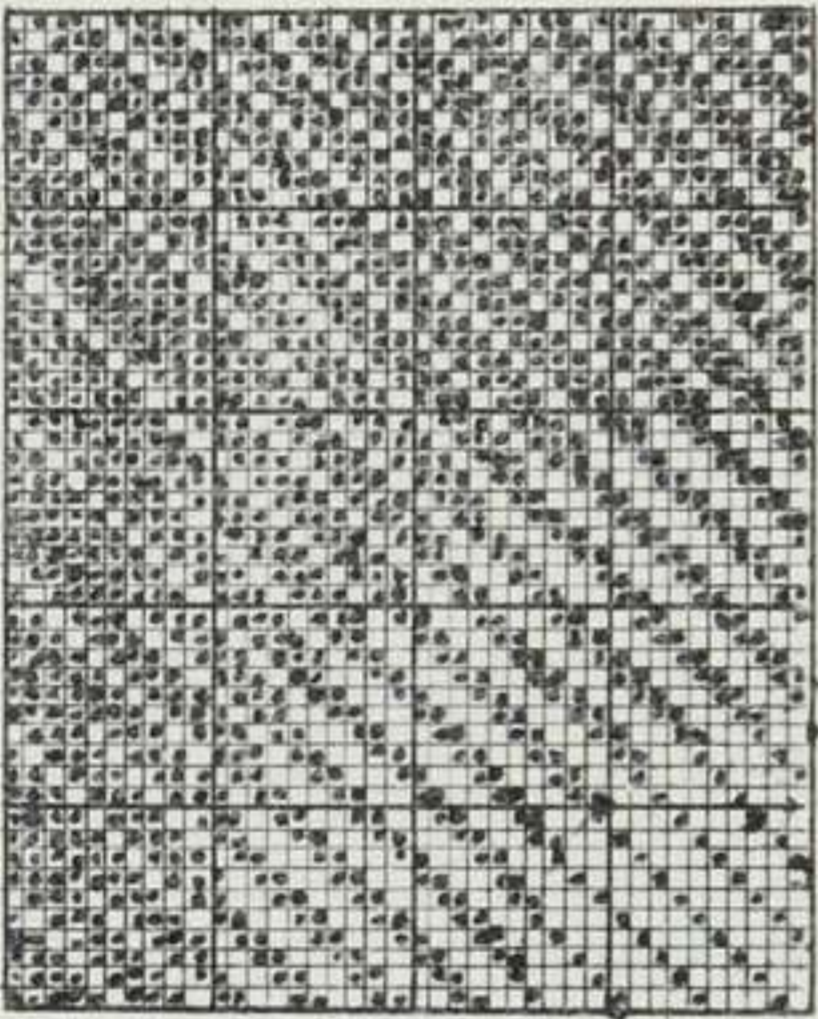


fig. 5<sup>a</sup>

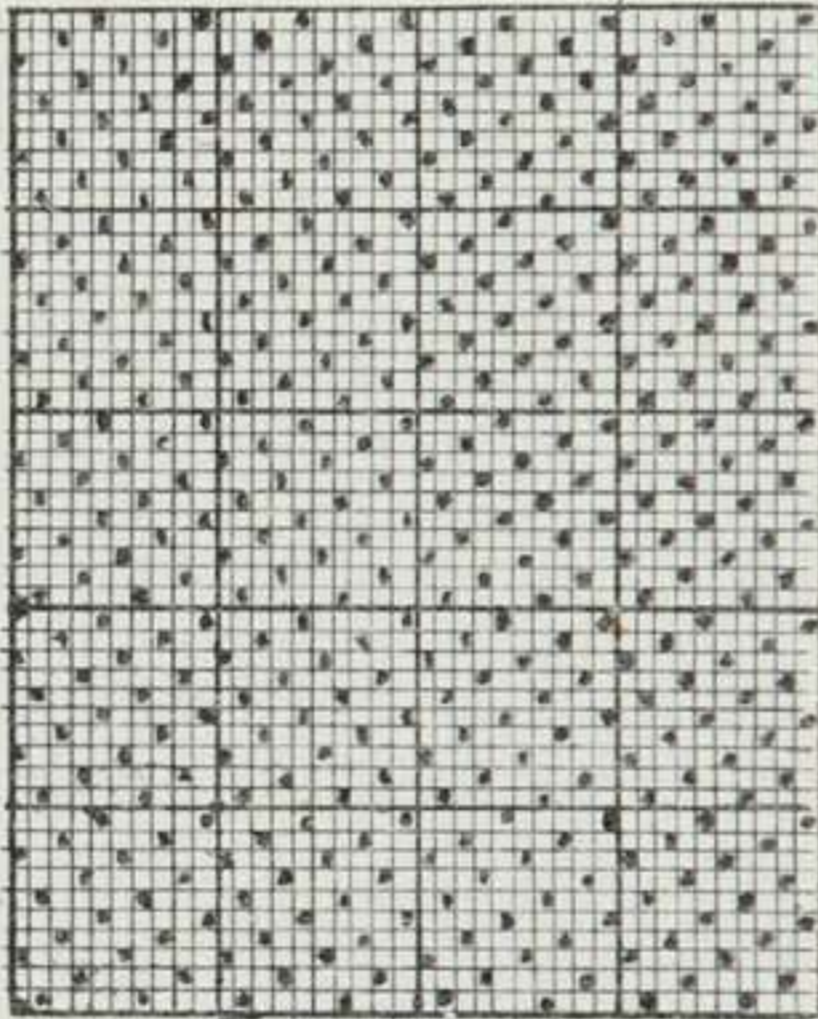


fig. 6<sup>a</sup>

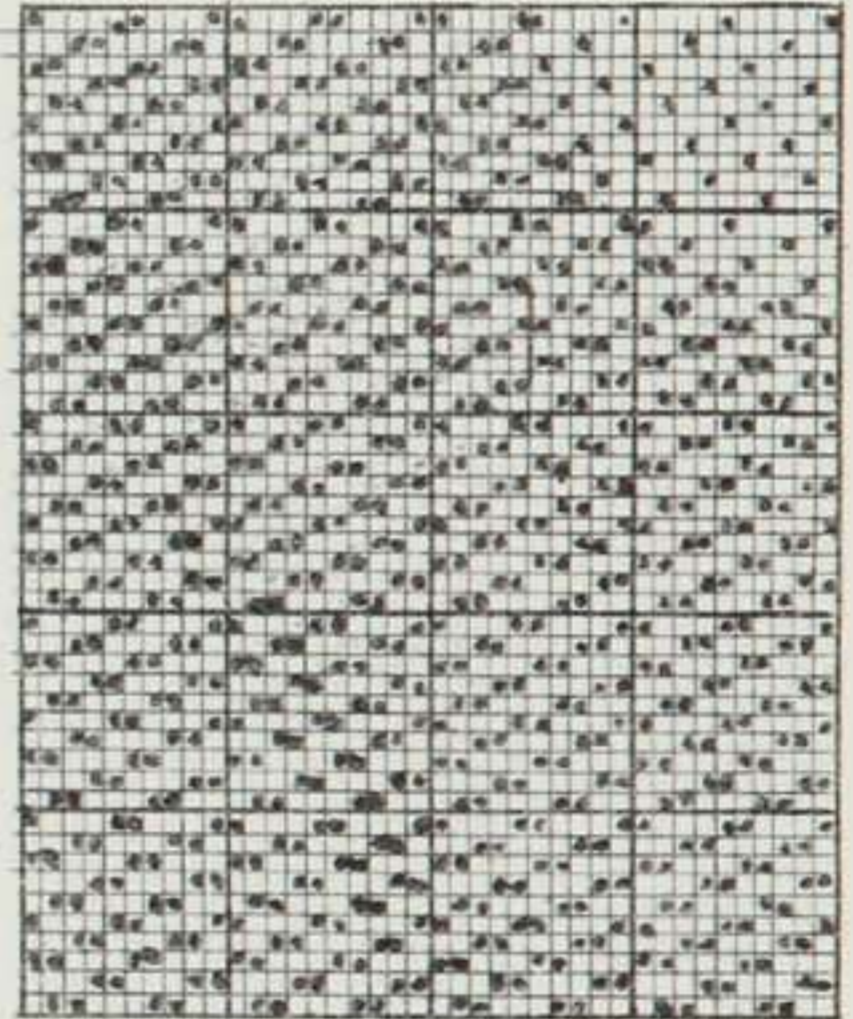


fig. 7<sup>a</sup>

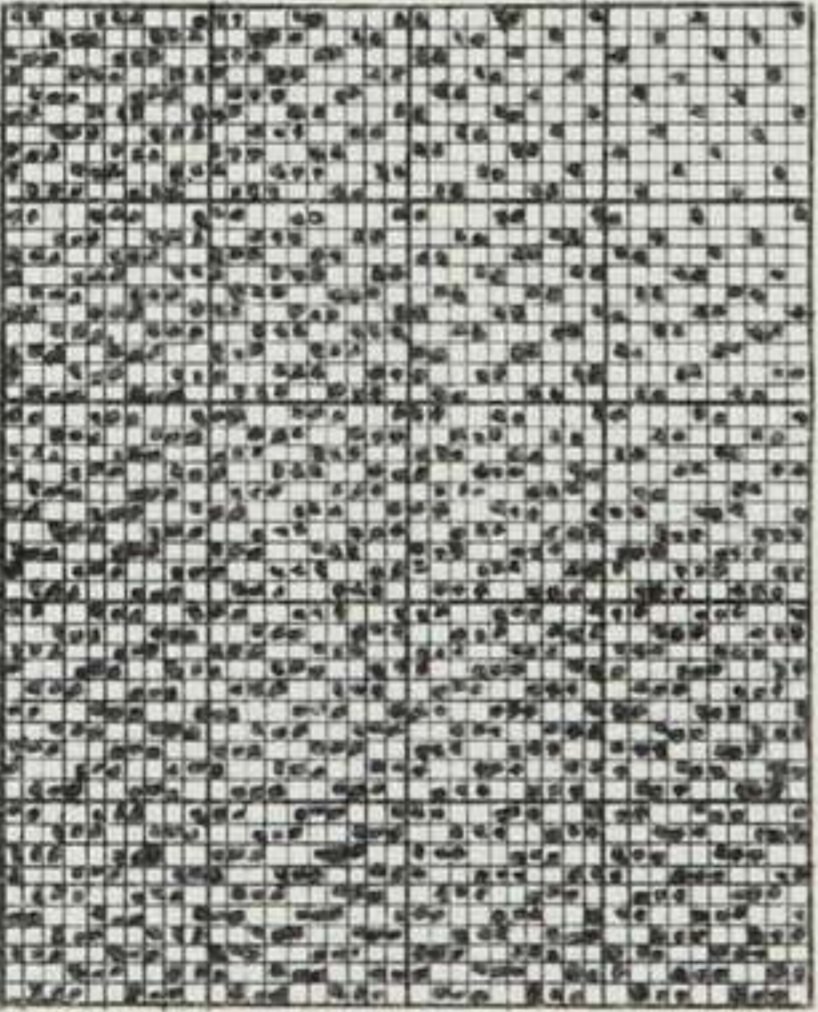


fig. 8<sup>a</sup>

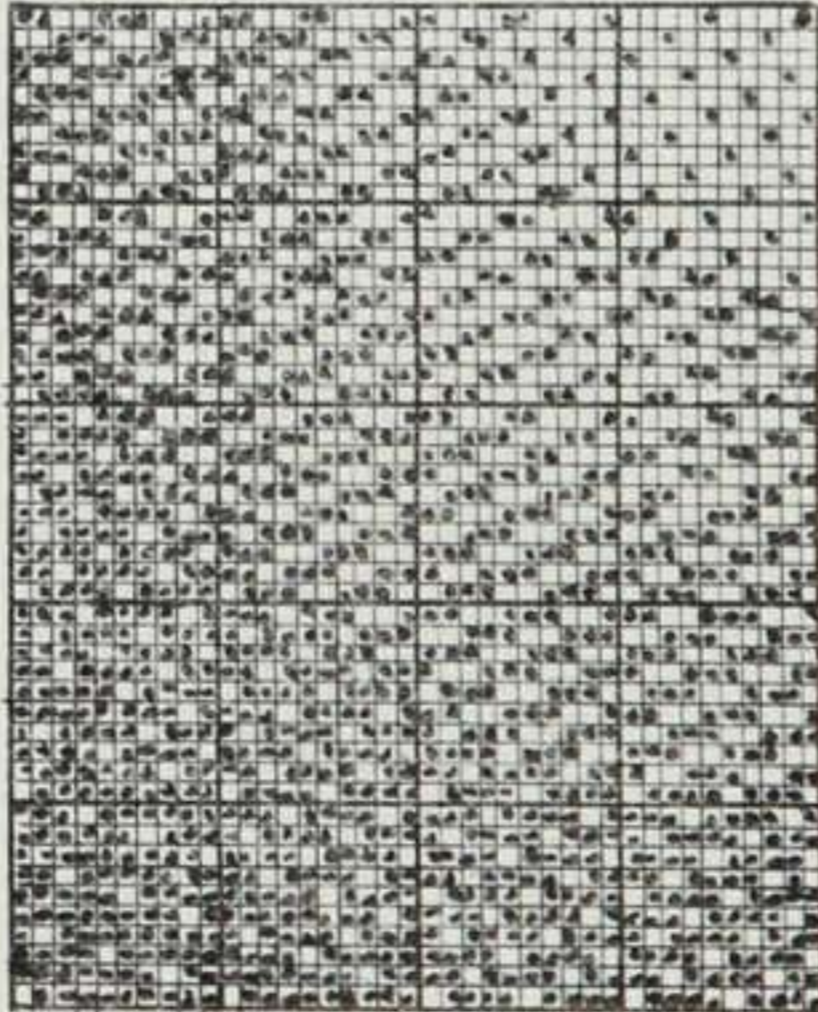
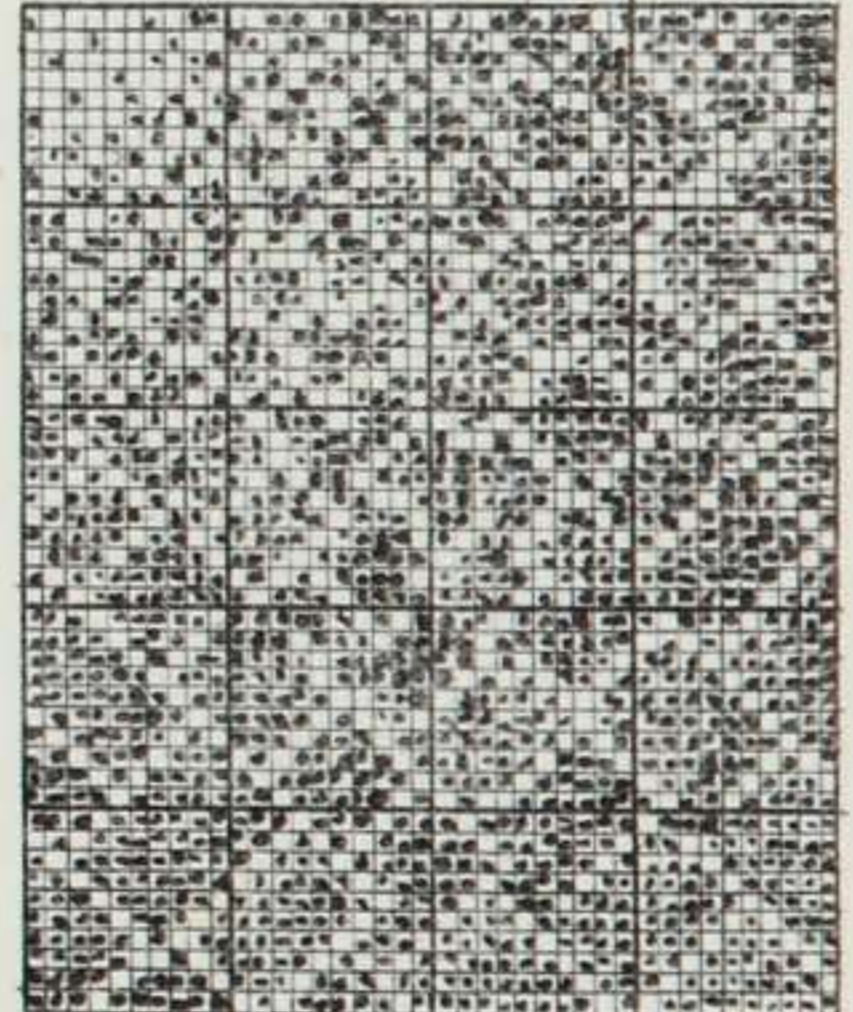
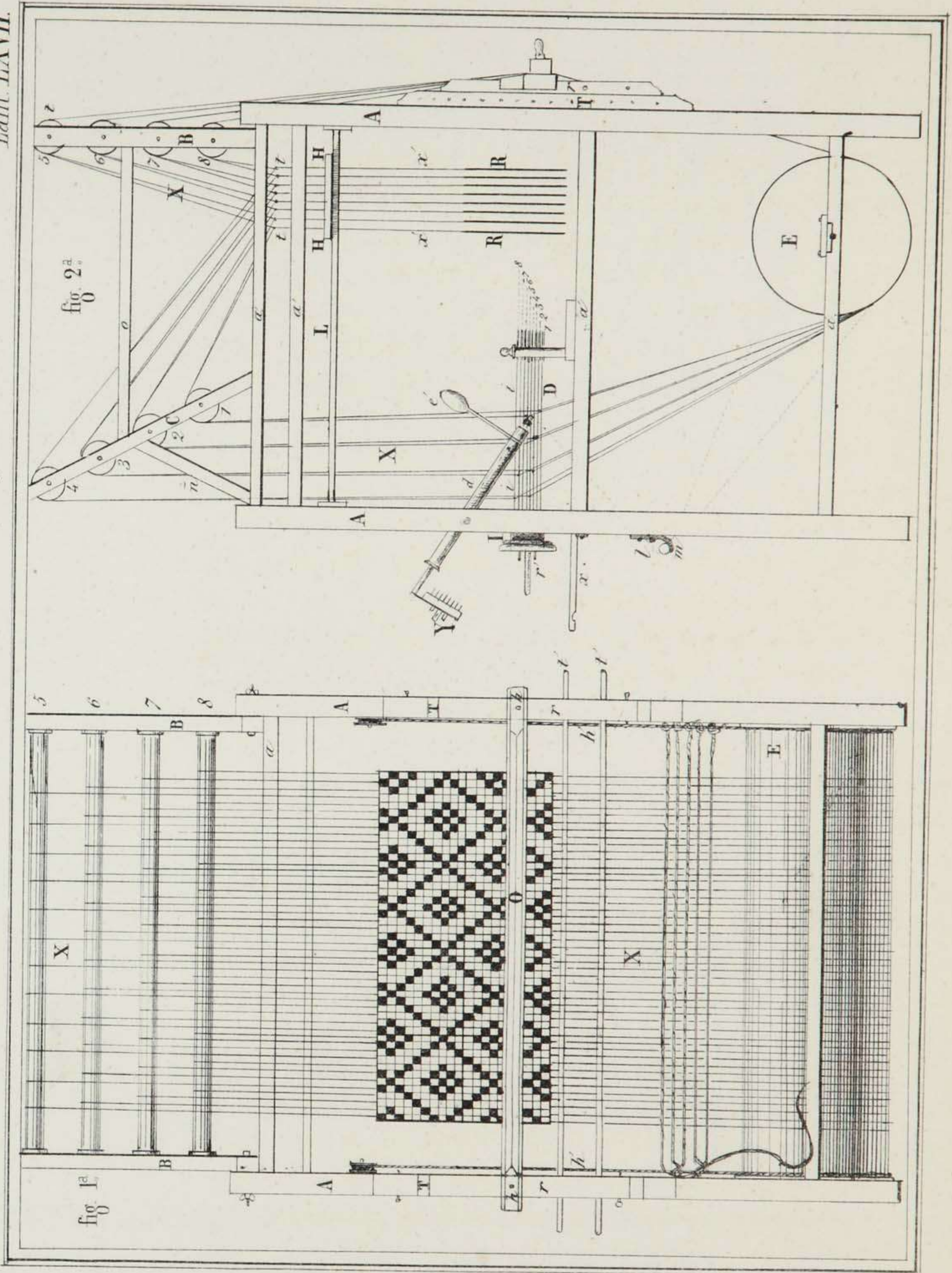


fig. 9<sup>a</sup>



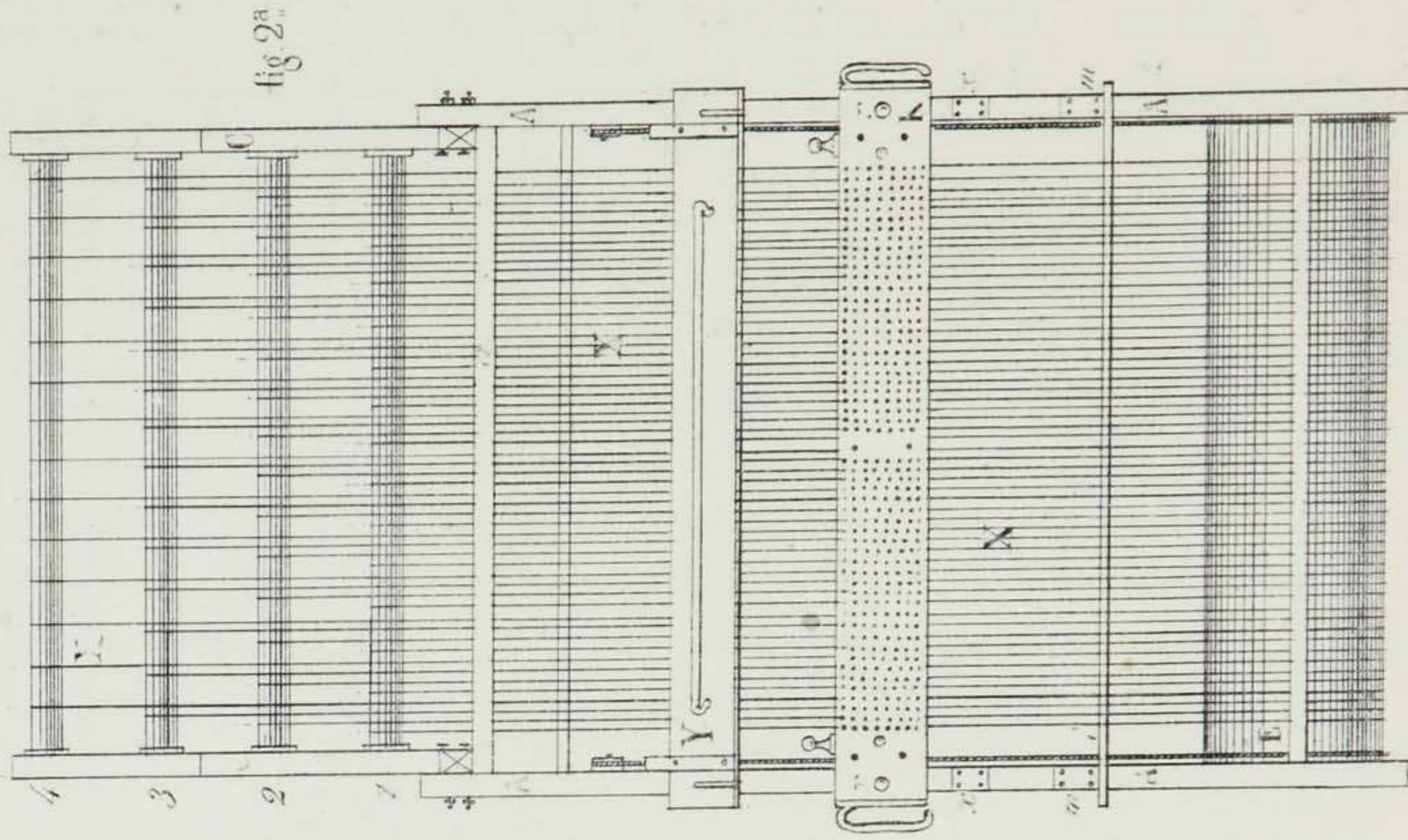
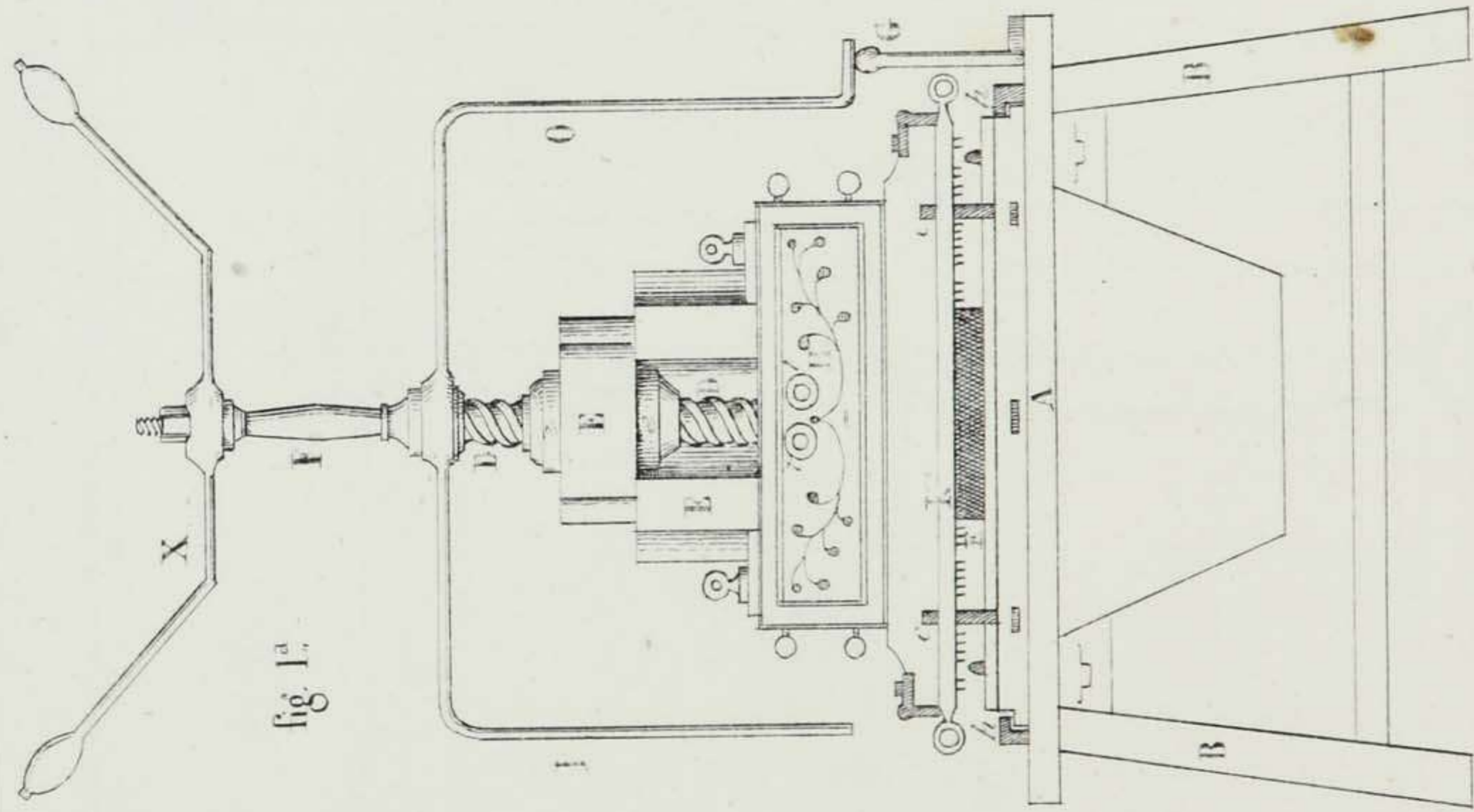
LISAGE DE TAMBOR. (de frente y de lado.)

Lám. LXVII.



LISAGE DE TAMBOR (detrás.)  
Y PRENSA DE PICAR.

Lám. LXVIII



MAQUINA DE REPICAR  
Y PLANCHAS.

Lám. LXX.

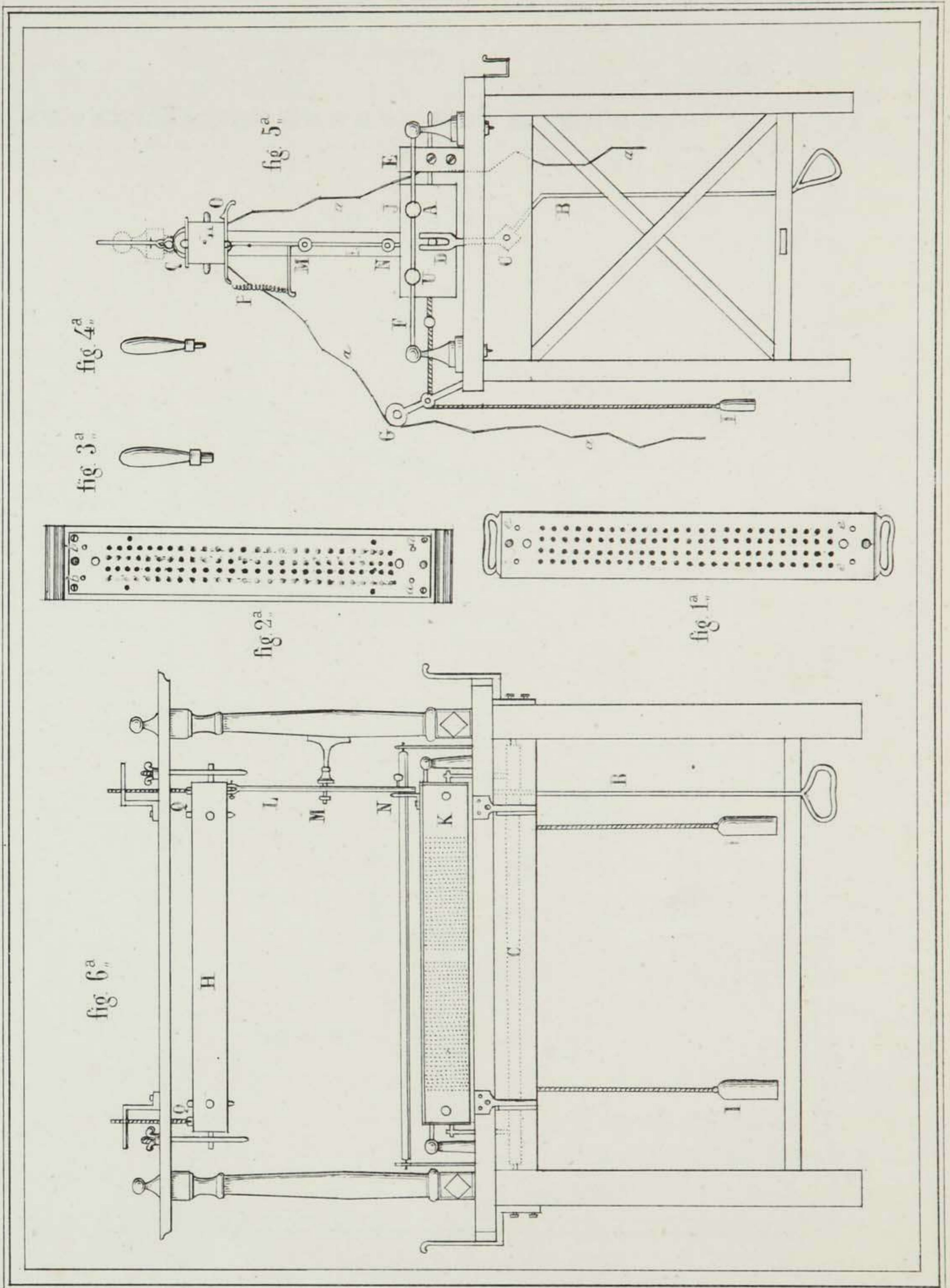




fig. 1.<sup>a</sup>  
Escala de la leedora.



fig. 3.<sup>a</sup>

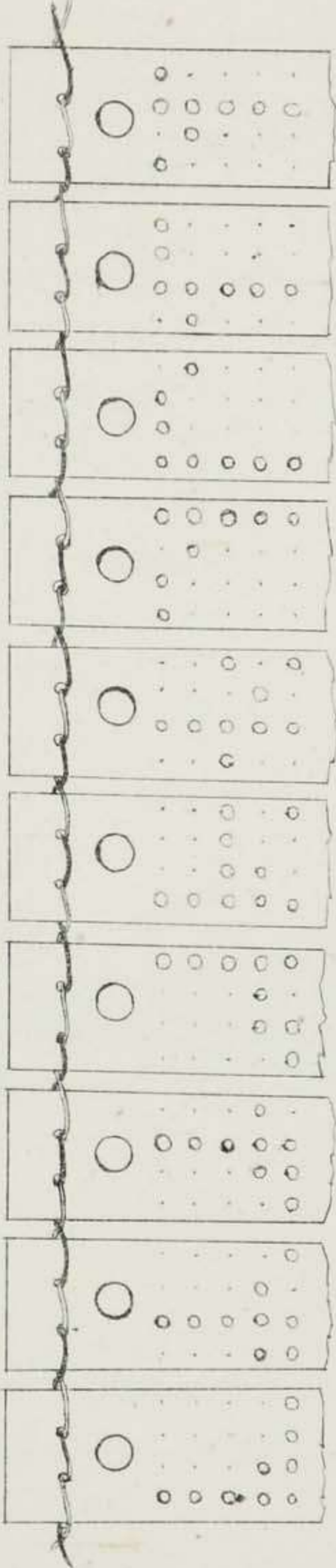


Tabla de cortar  
los cartones.

fig. 2.<sup>a</sup>

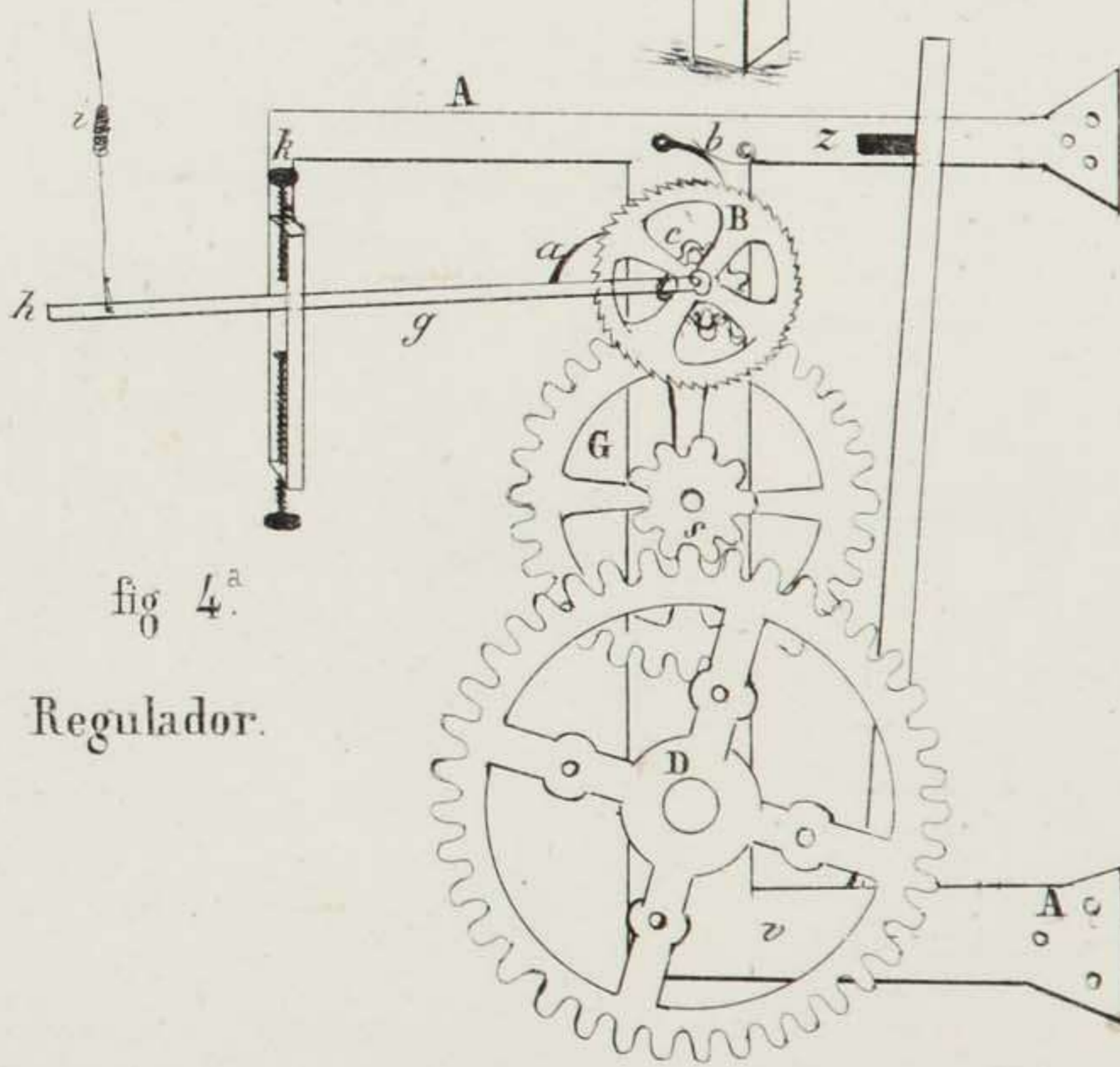
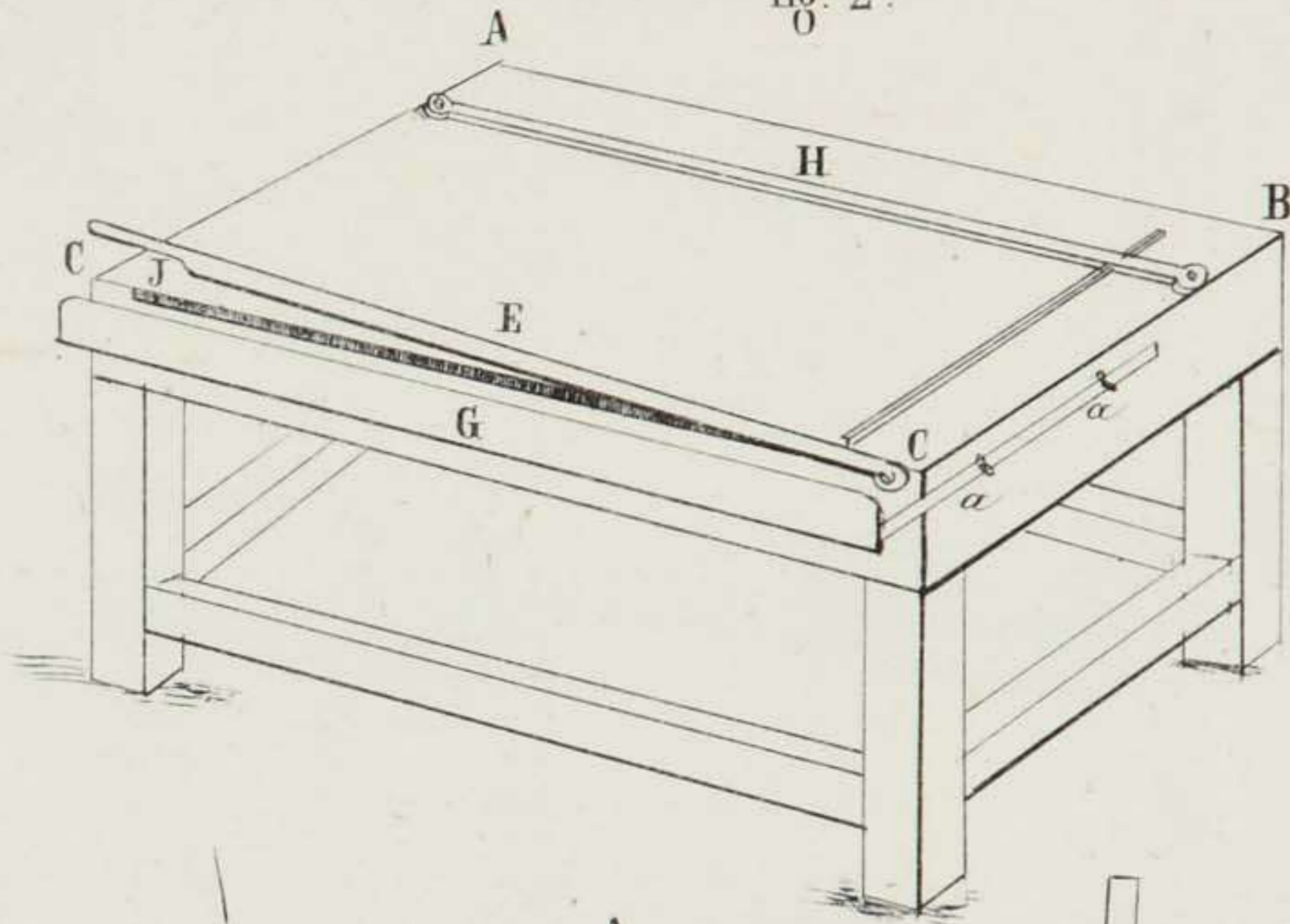
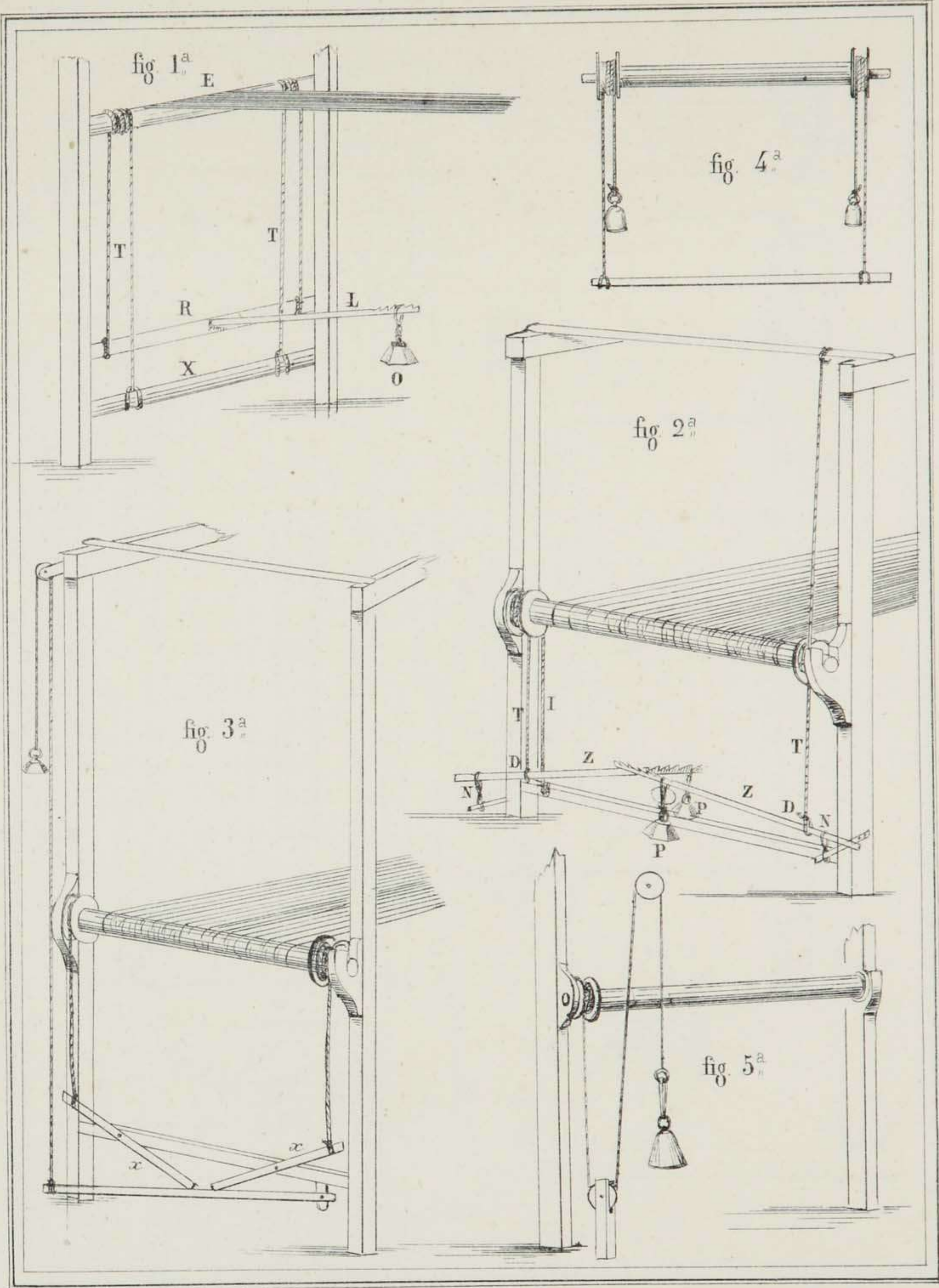
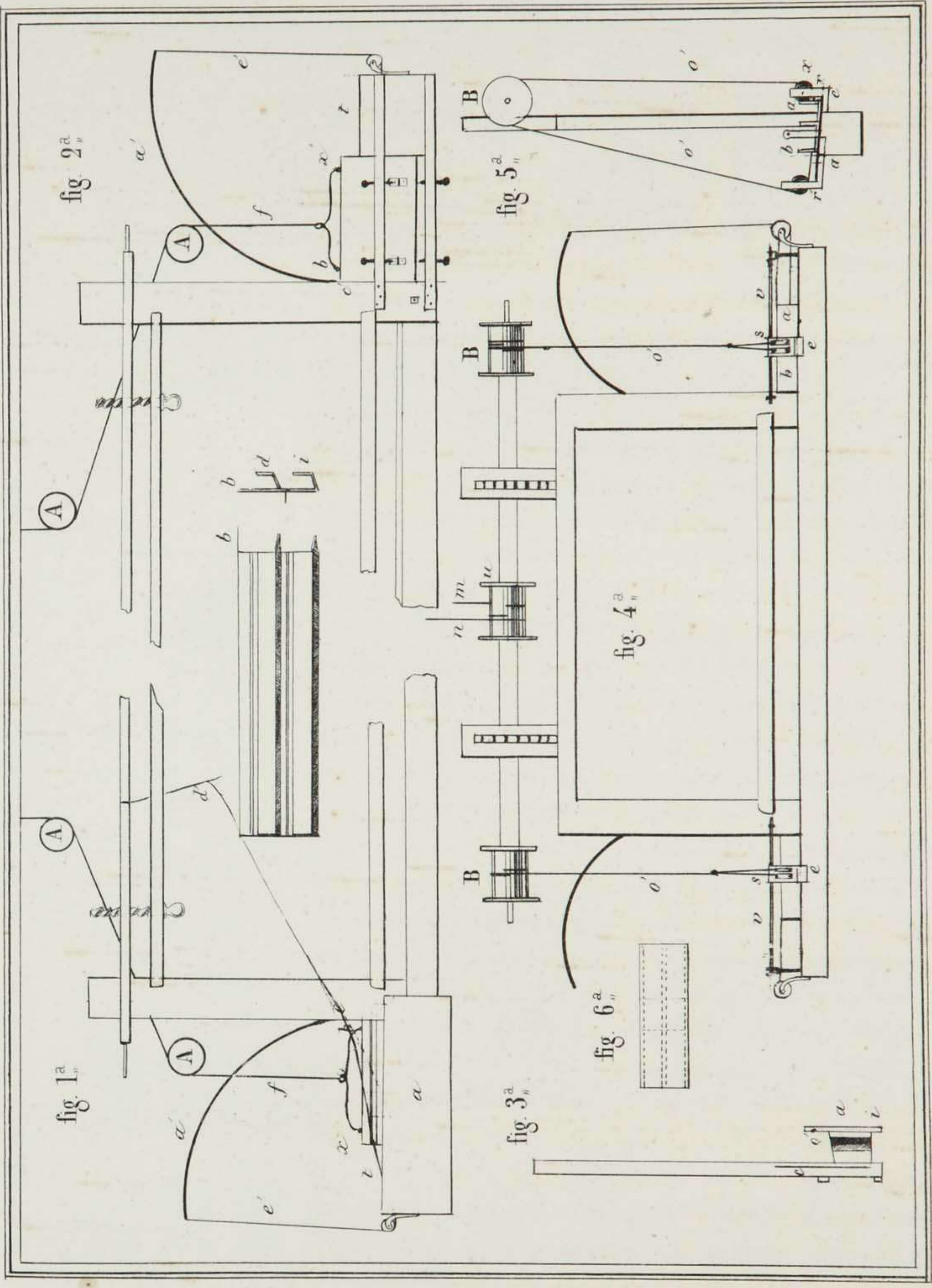


fig. 4.<sup>a</sup>  
Regulador.

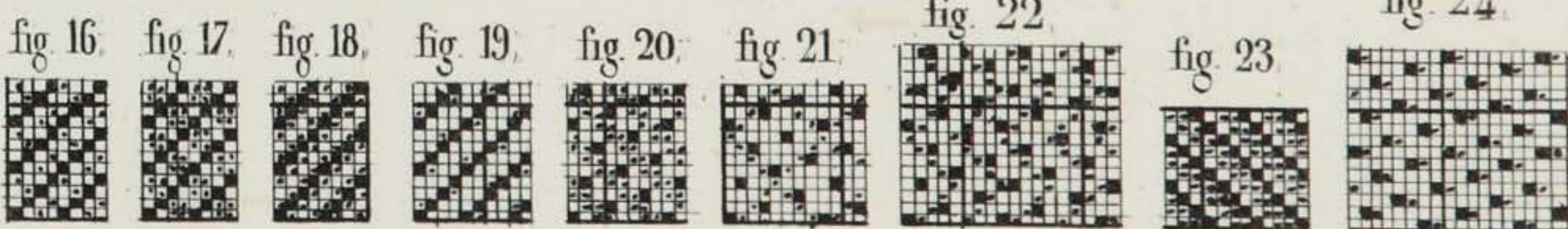
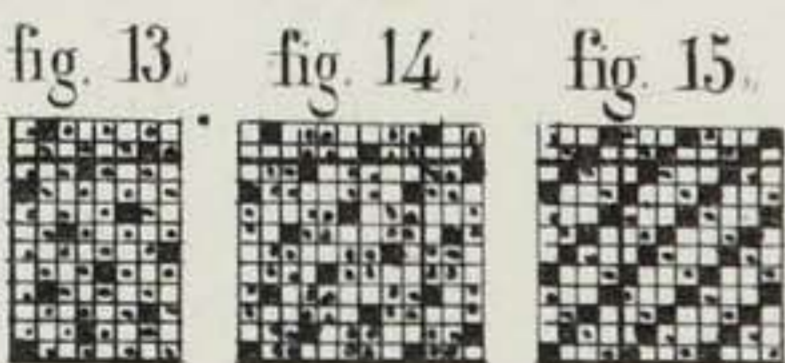
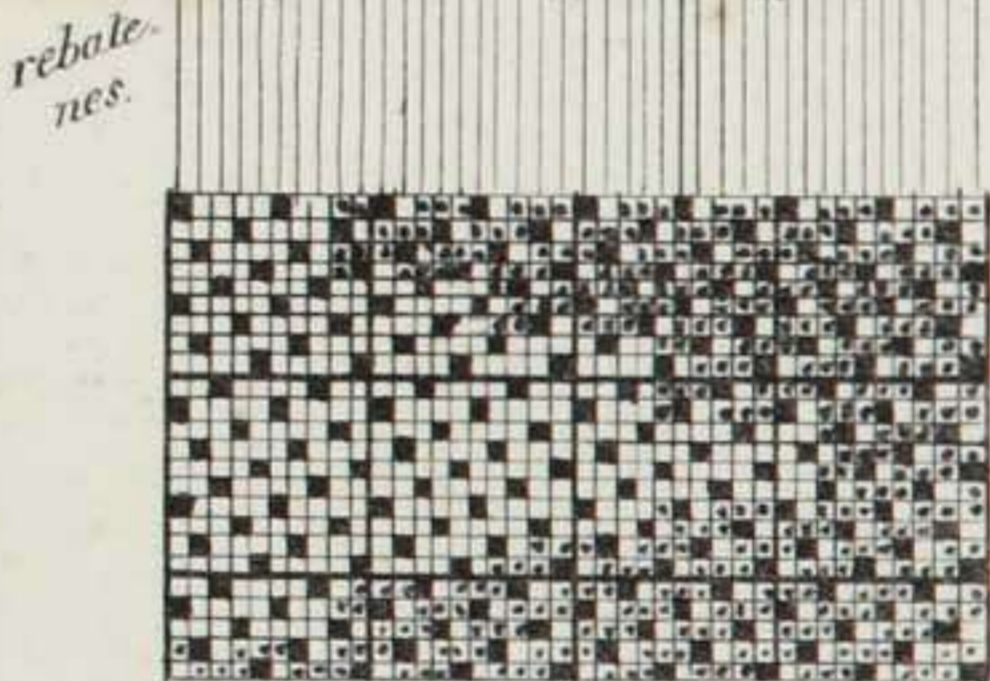
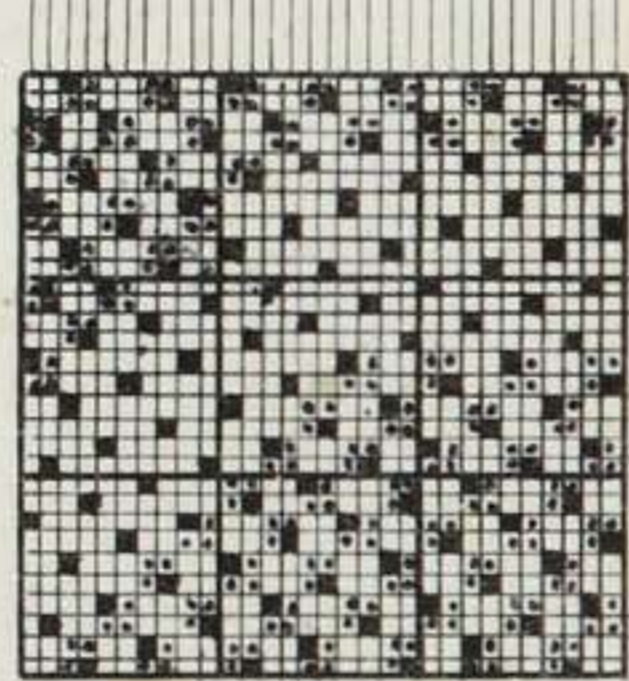
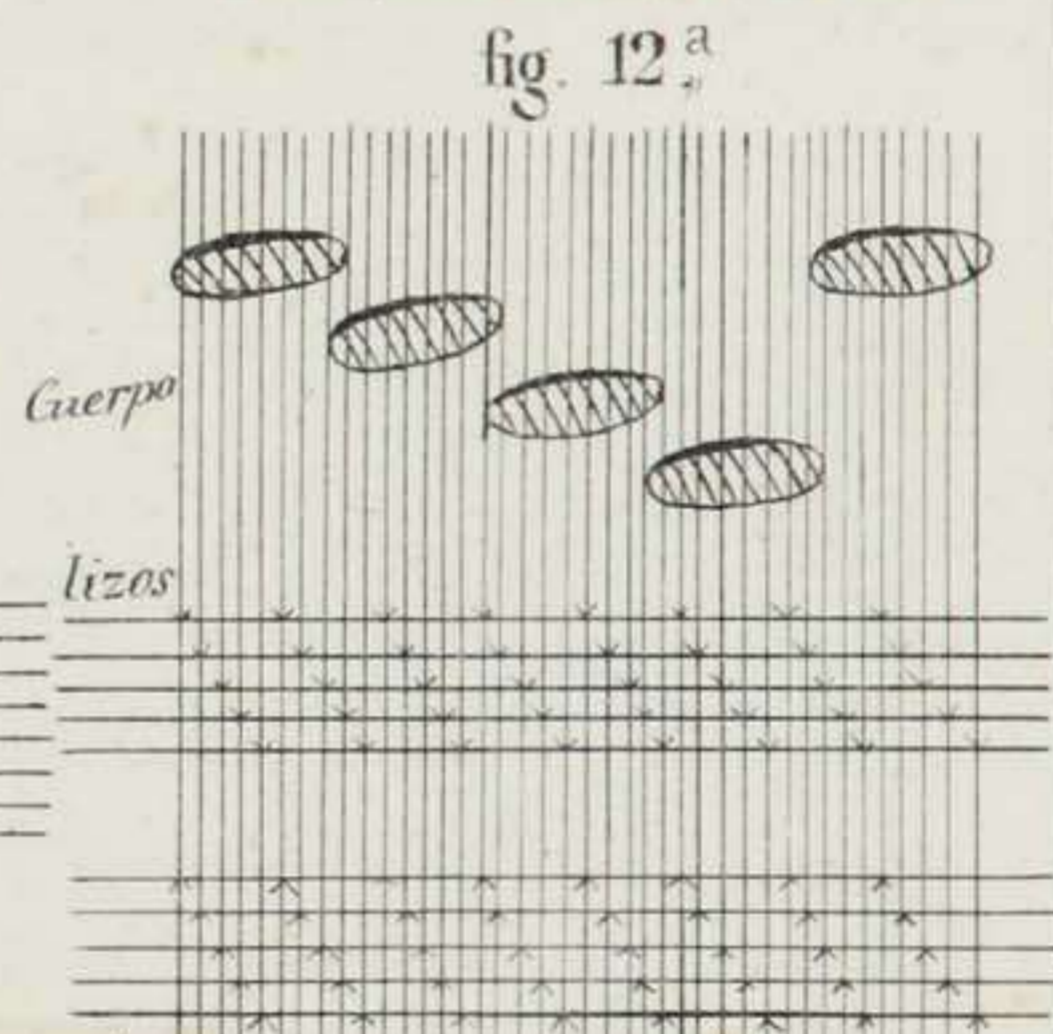
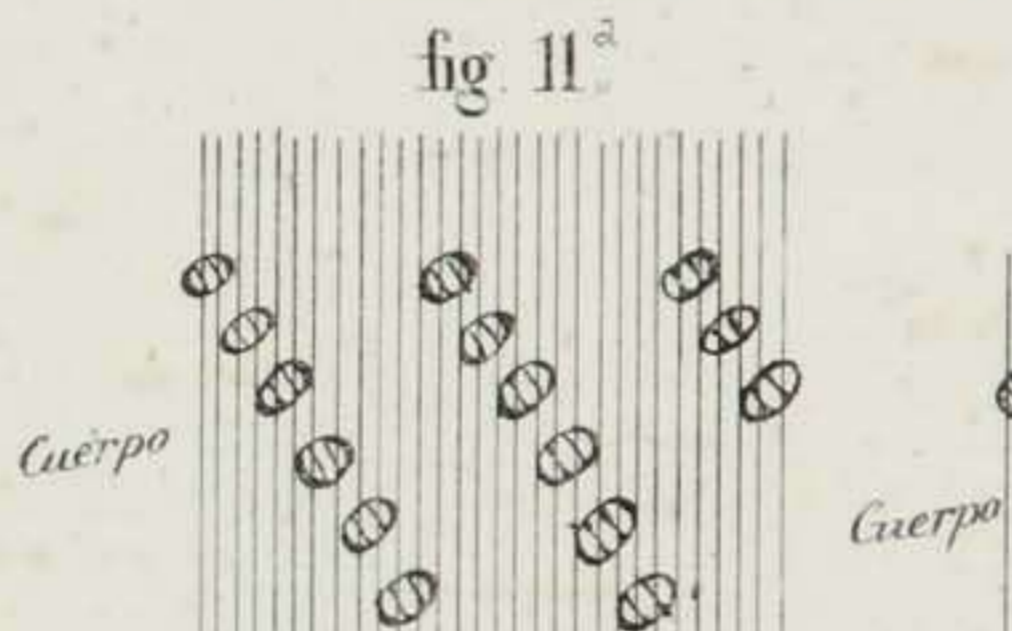
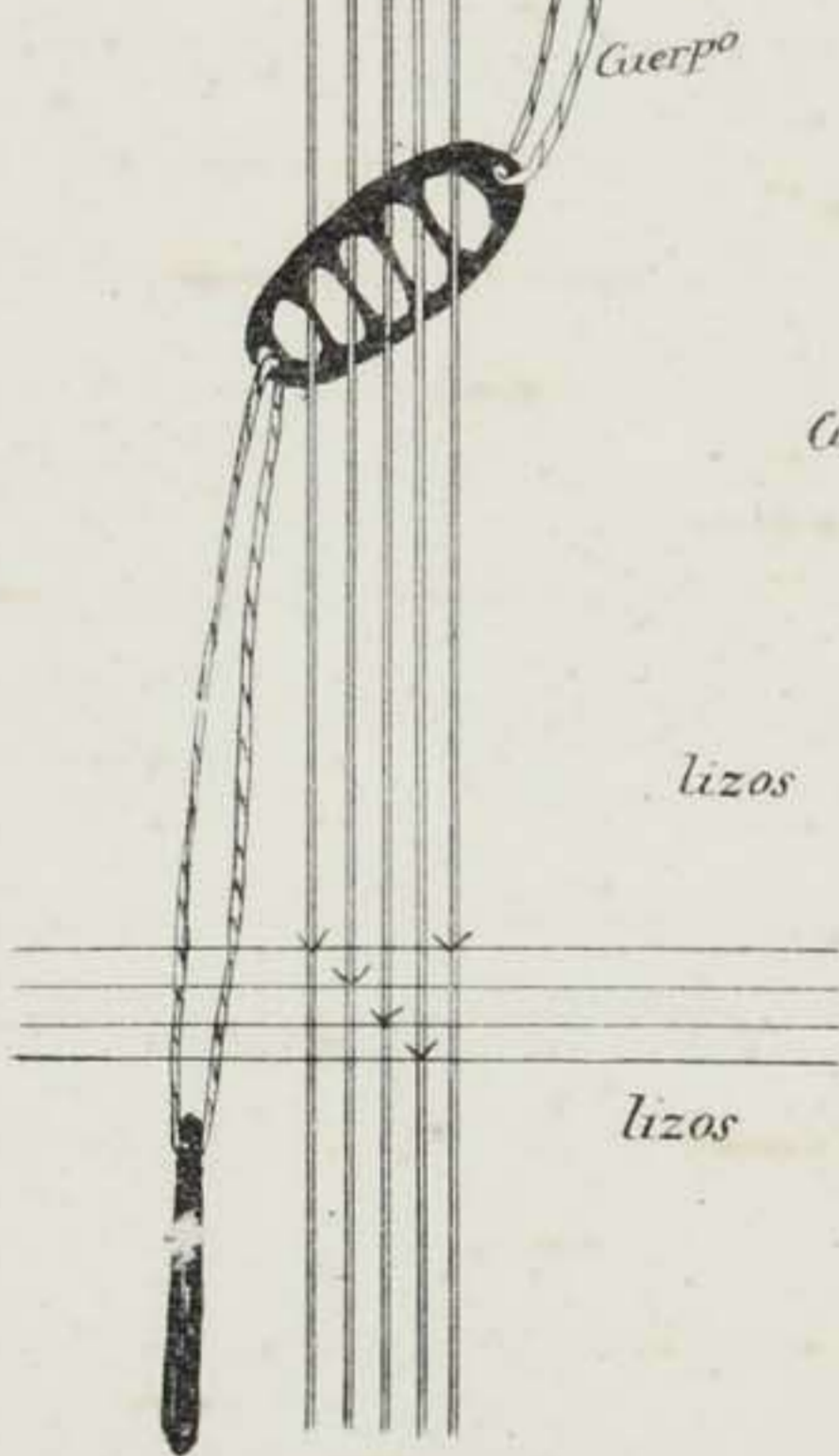
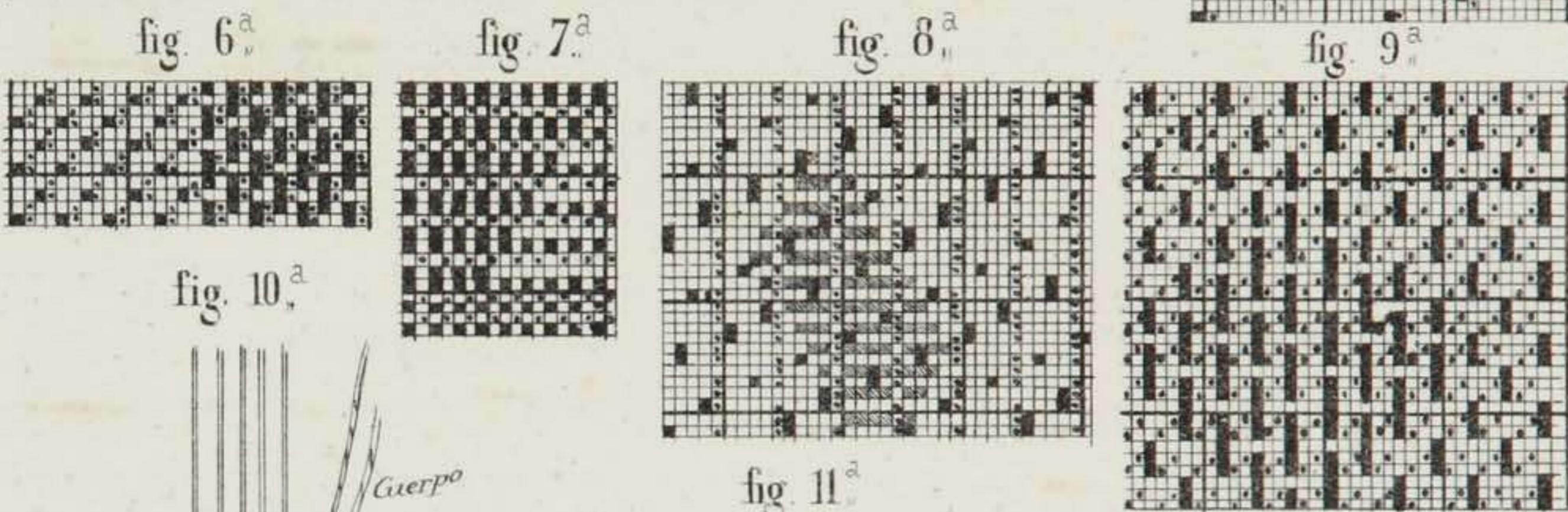
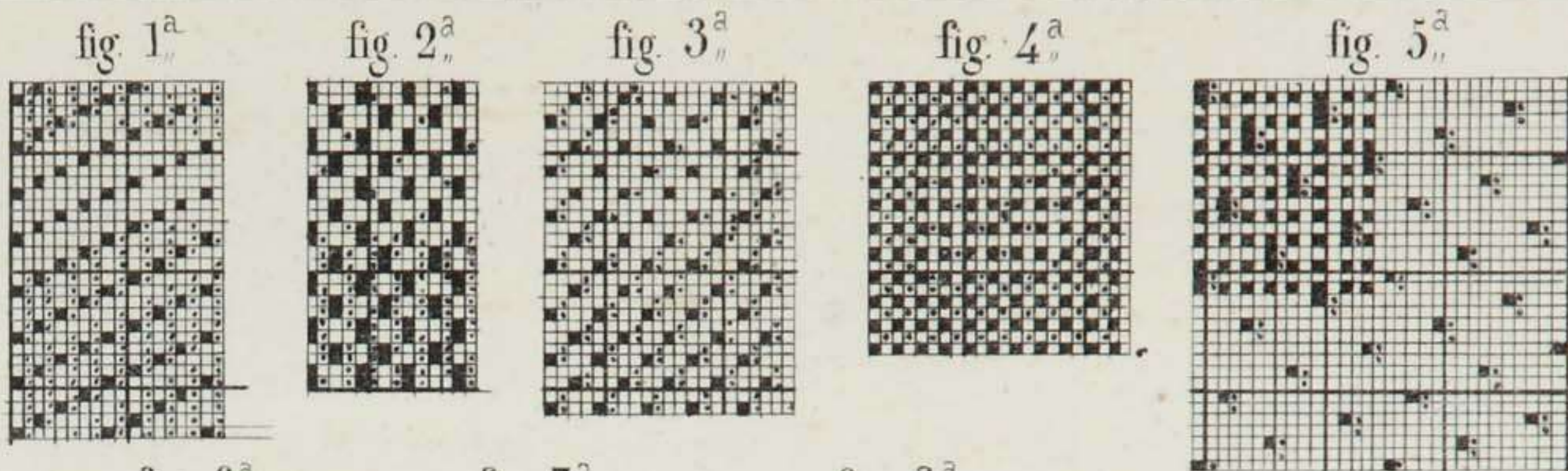




# LIGAMIENTOS COMBINADOS

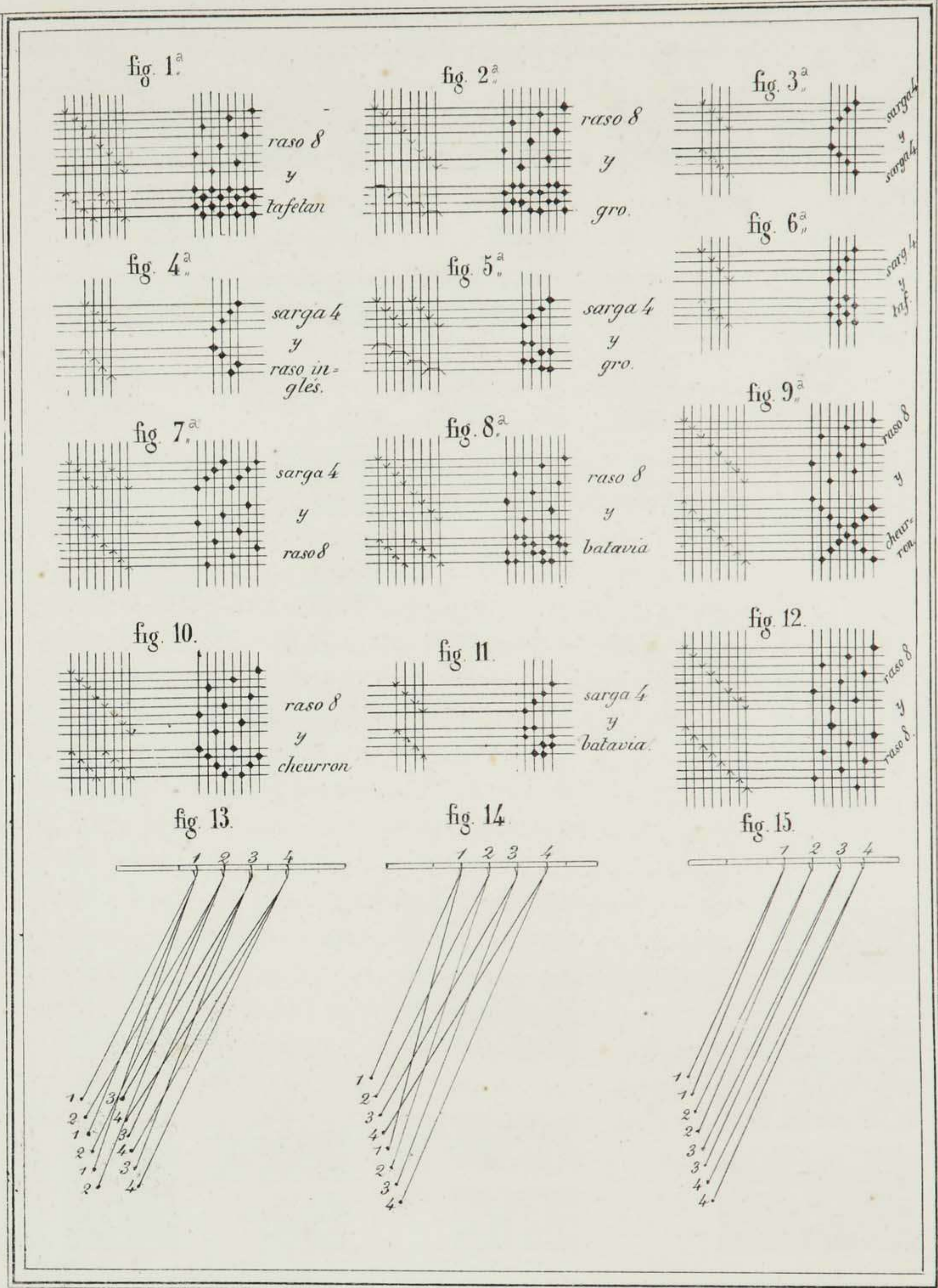
para cuerpo y lizos.

Lám. LXXIII



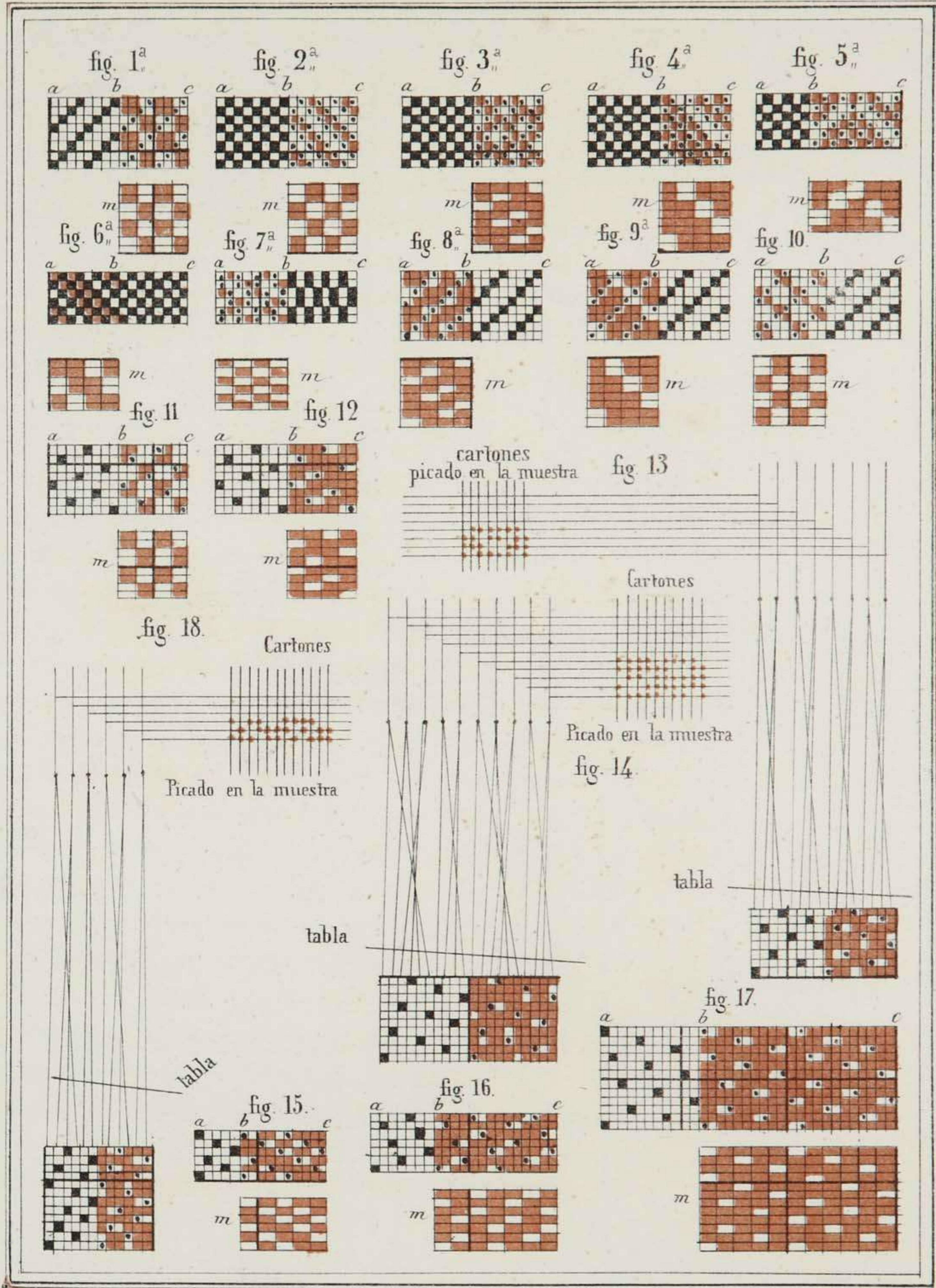
# DISPOSICIONES

para armaduras con cuerpo, lizos y rebatenes. Lám. LXXIV.



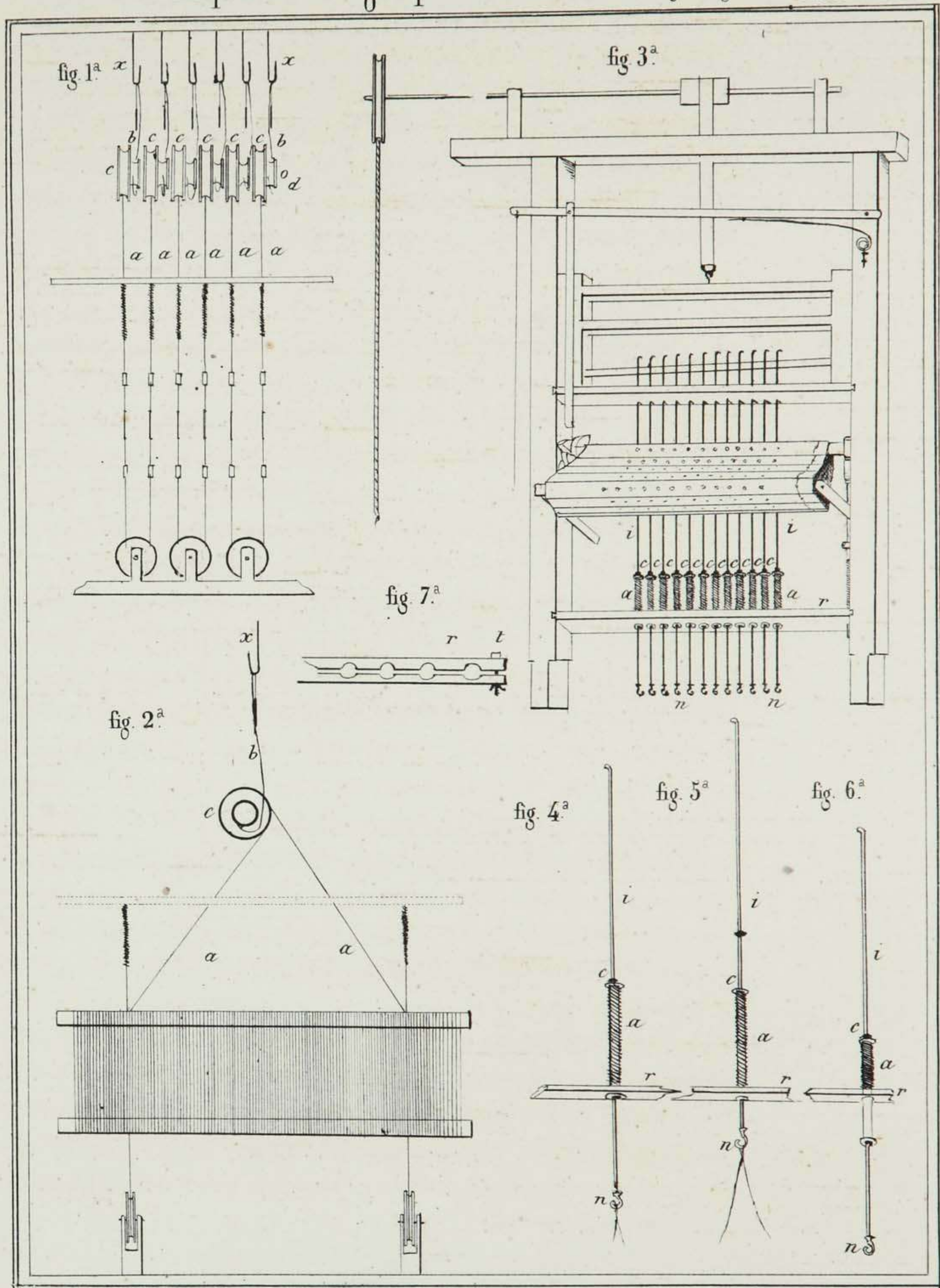
Combinaciones para supresion de lizos rebatenes, en tejidos adamascados.

Lám. LXXV.

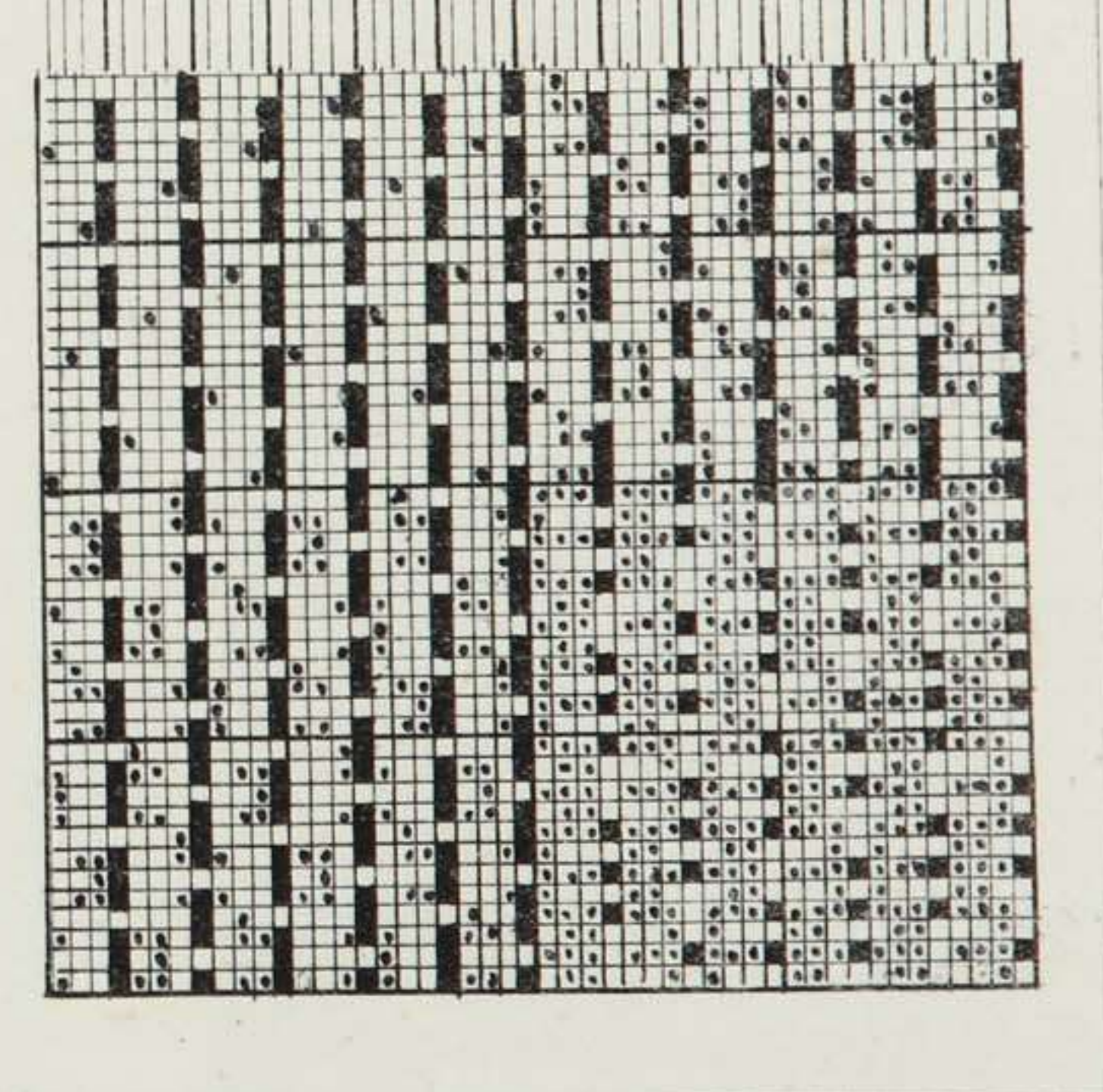
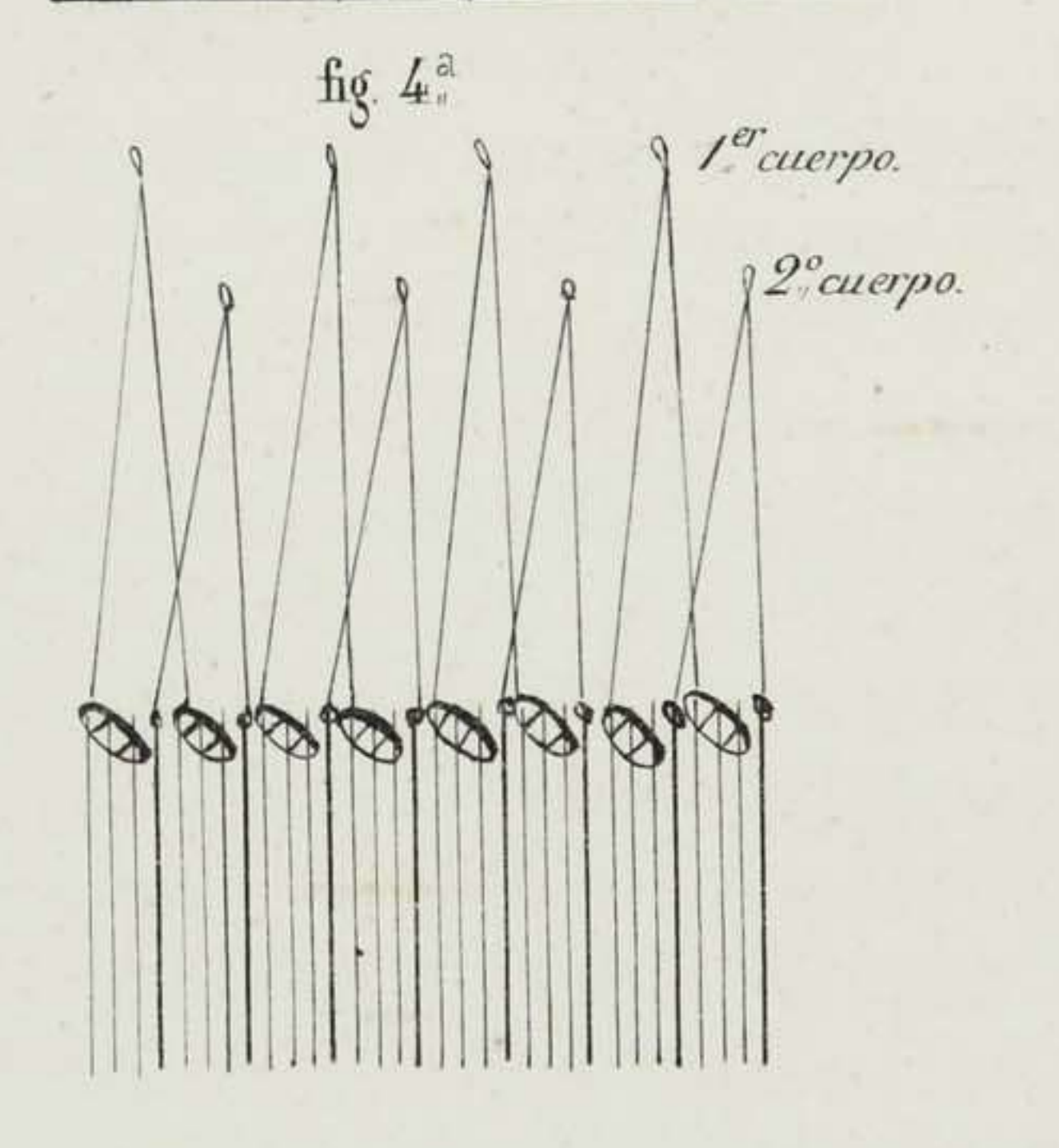
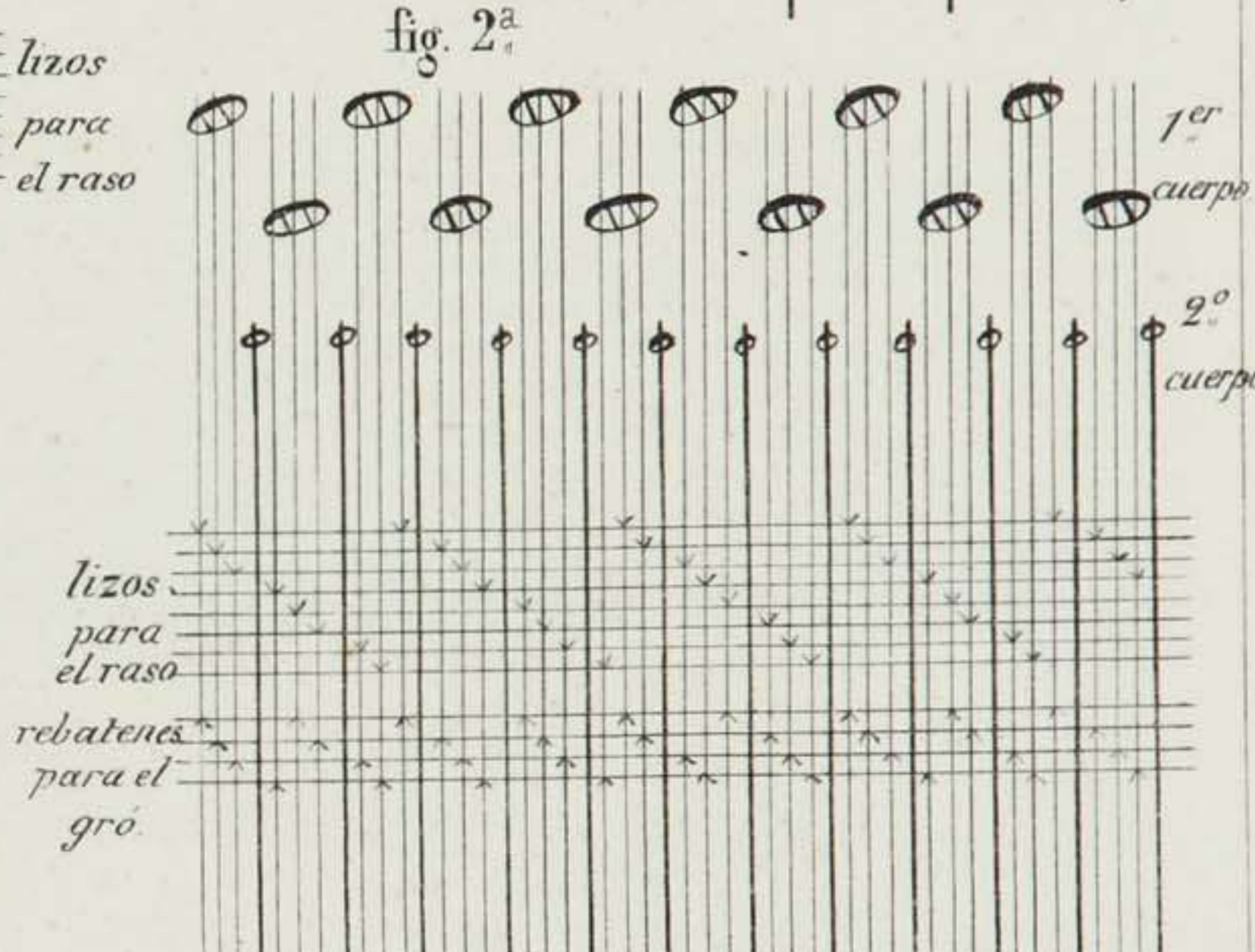
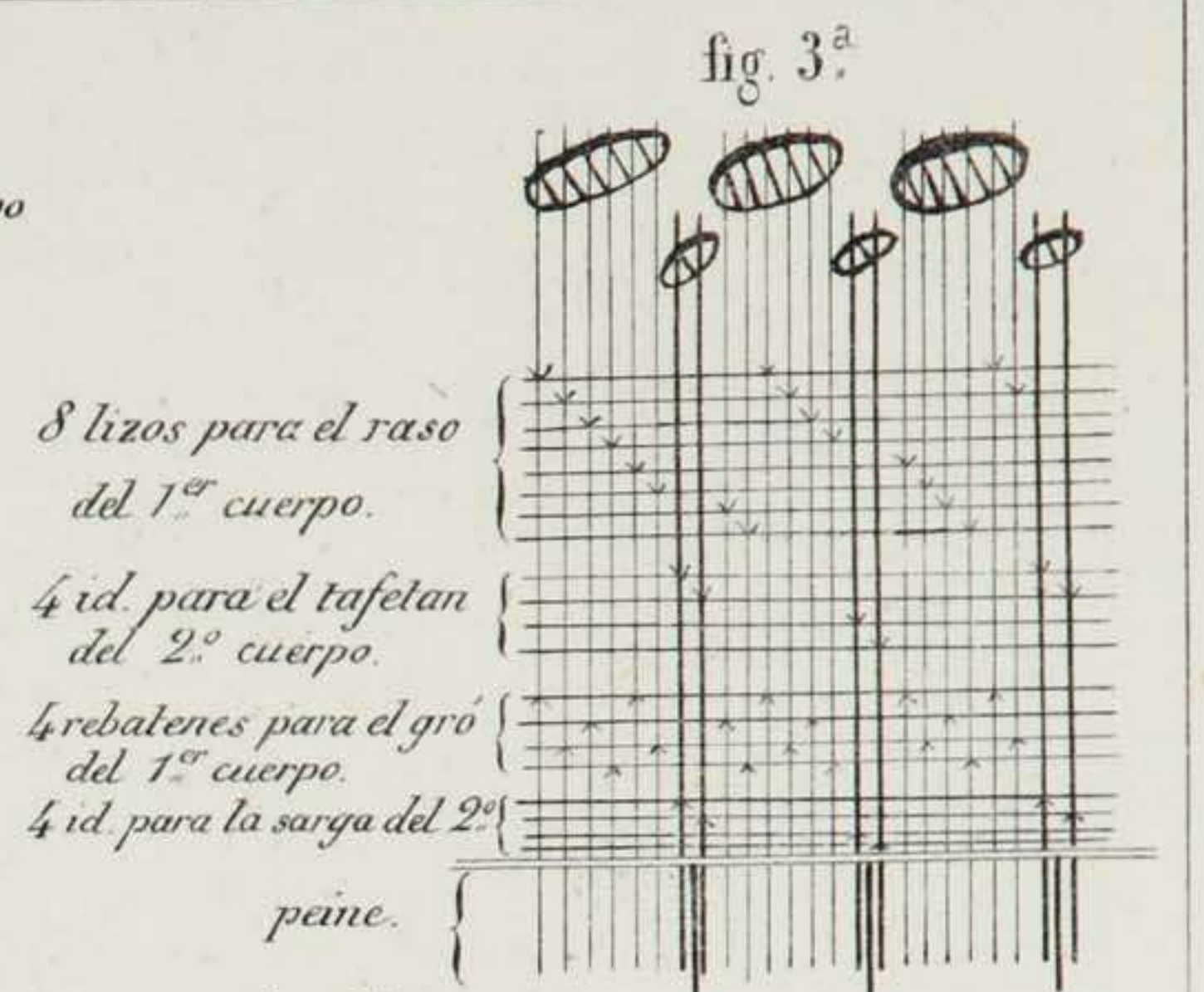
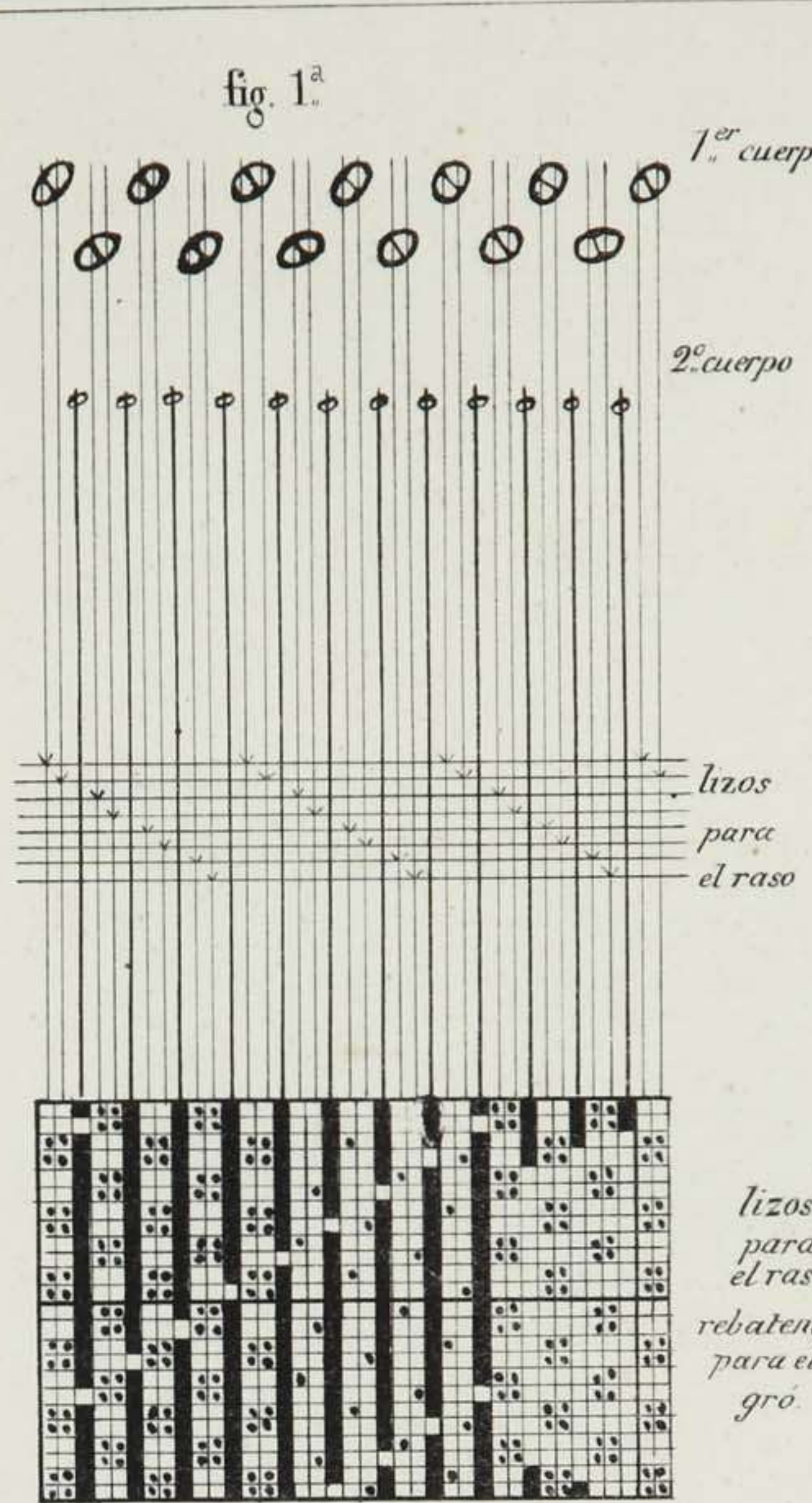


# UTENSILIOS.

Maquinita de ligar por sistema de alza y baja. *Lám. LXXVI.*



Tejidos de un urdimbre á cuerpo y lizos en combinacion de otro, á cuerpo simple.  
 Tejidos de dos ó mas urdimbres á cuerpo y lizos cada uno de ellos. *Lám. LXXVII*





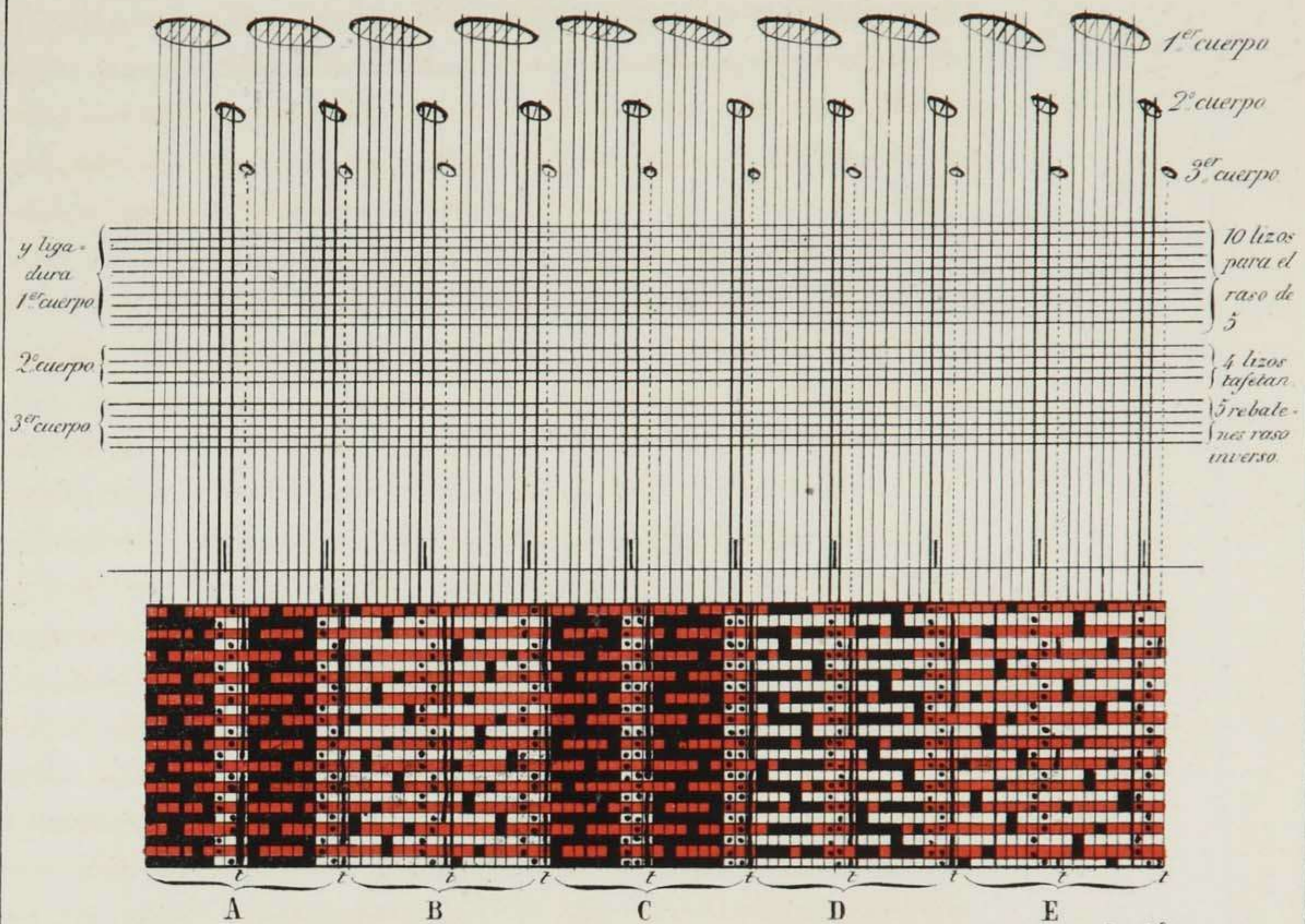
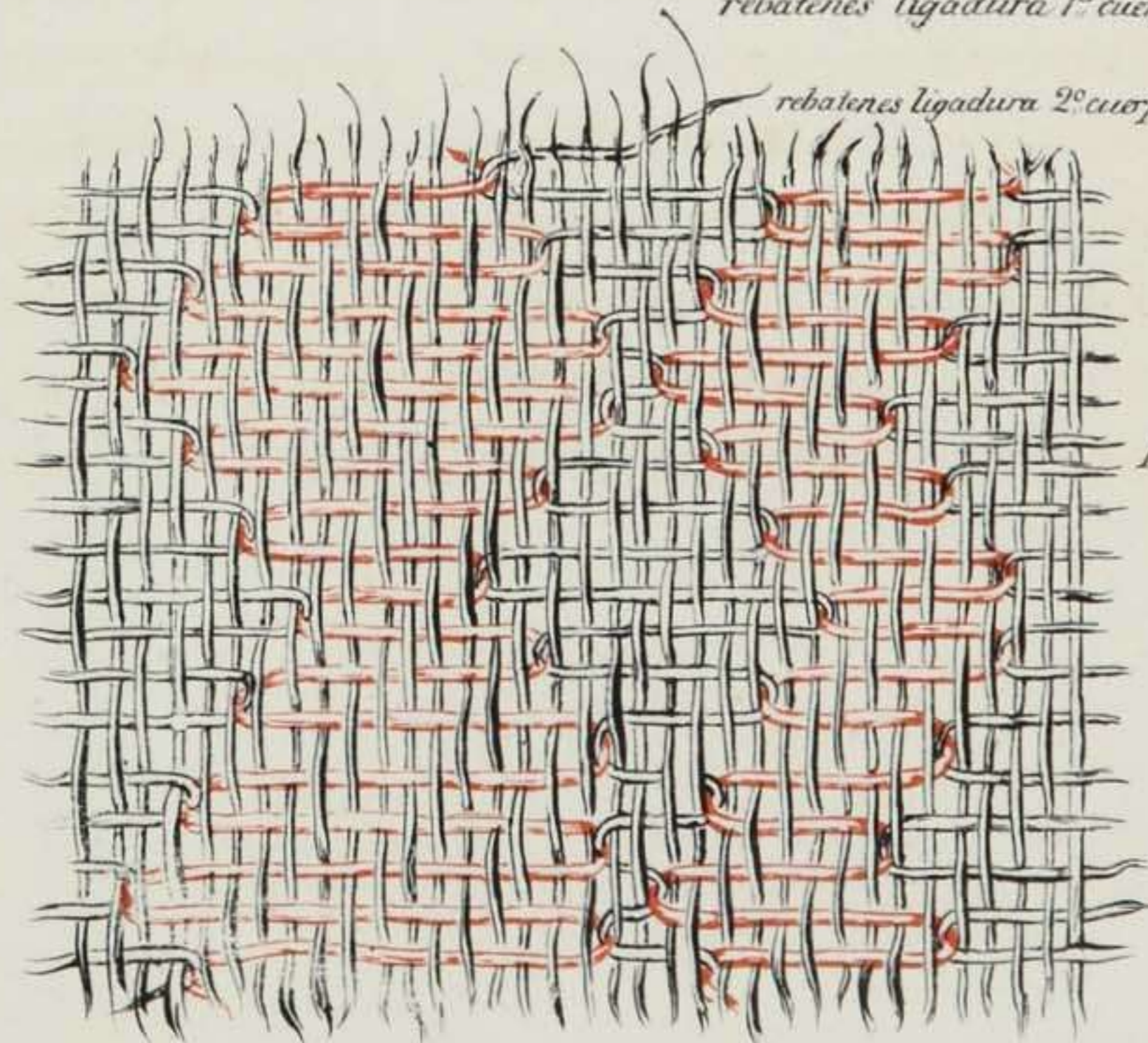


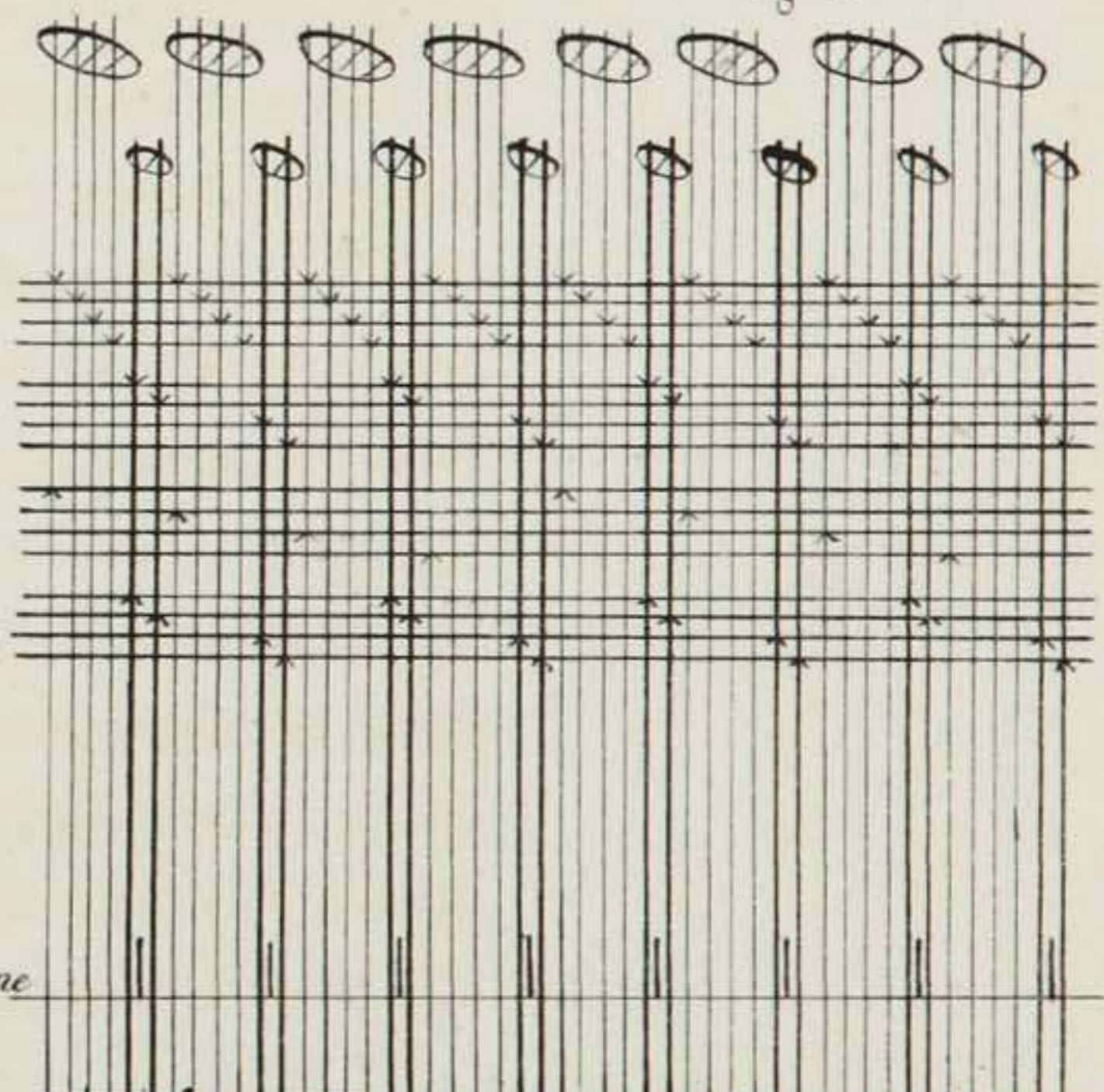
fig. 1ª

fig. 2ª

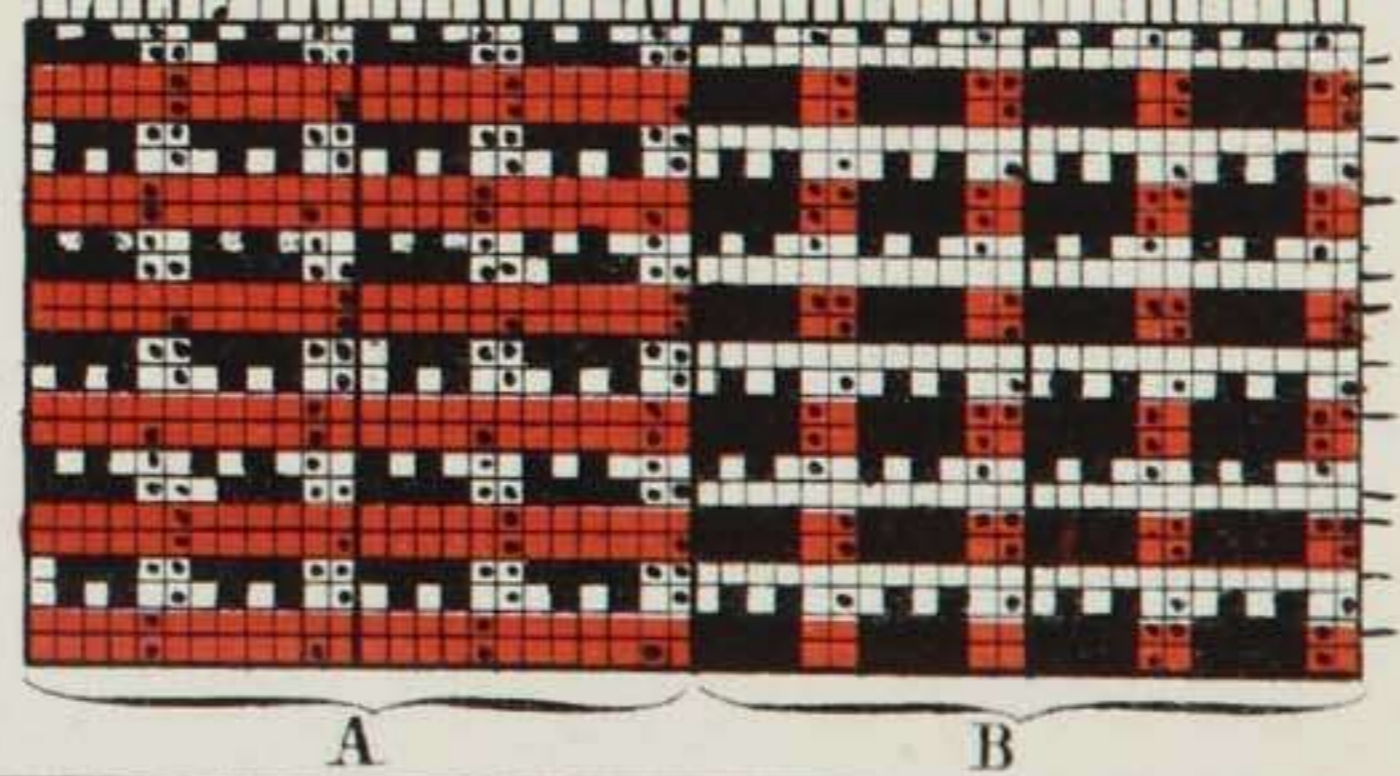
Espolinado continuo.



1º cuerpo  
2º cuerpo  
lizos tafetán 1º cuerpo.  
lizos tafetán 2º cuerpo.  
rebatenes ligadura 1º cuerpo  
rebatenes ligadura 2º cuerpo



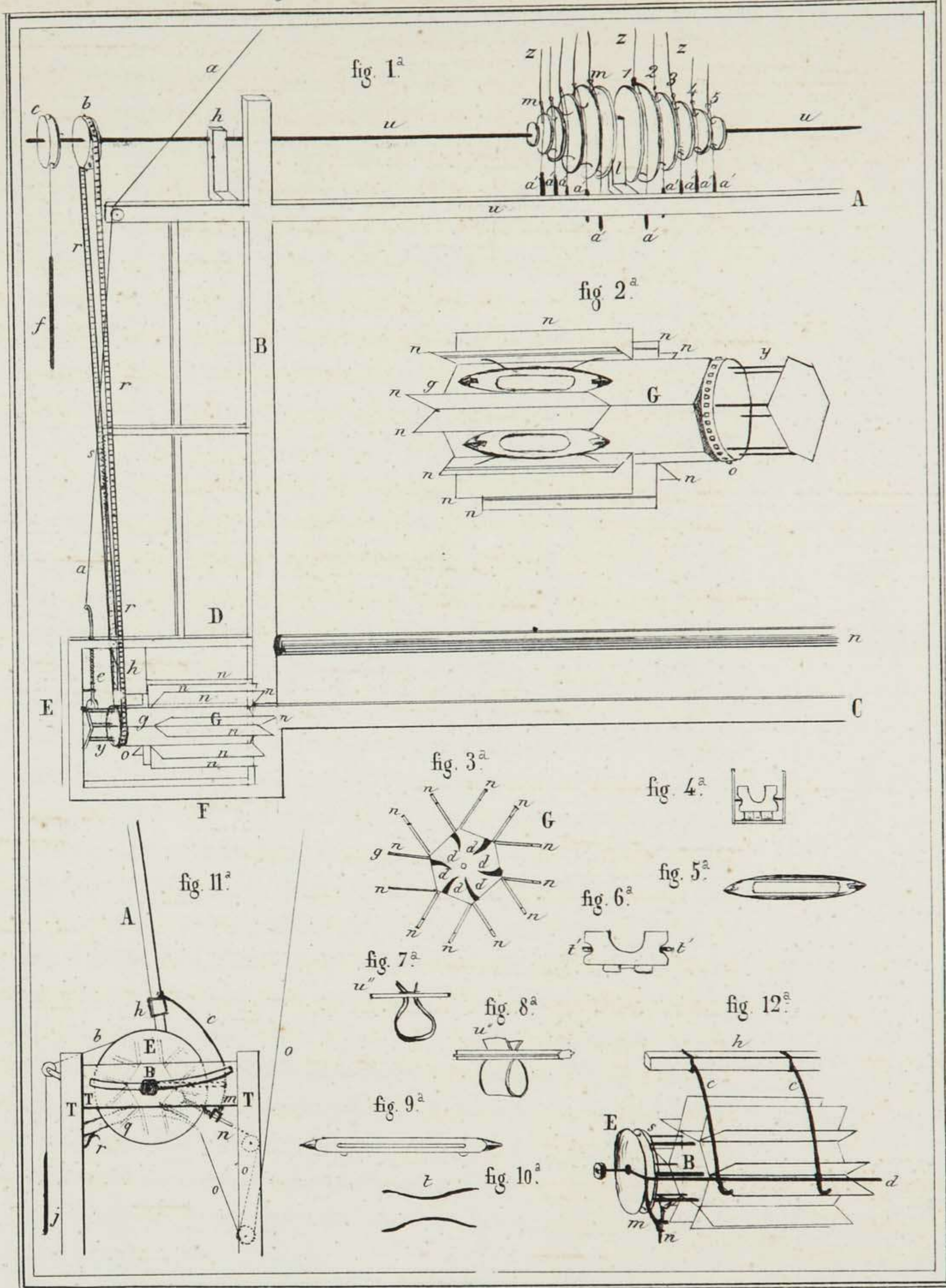
peine



# UTENSILIOS.

## Cajas para artículos de perdido.

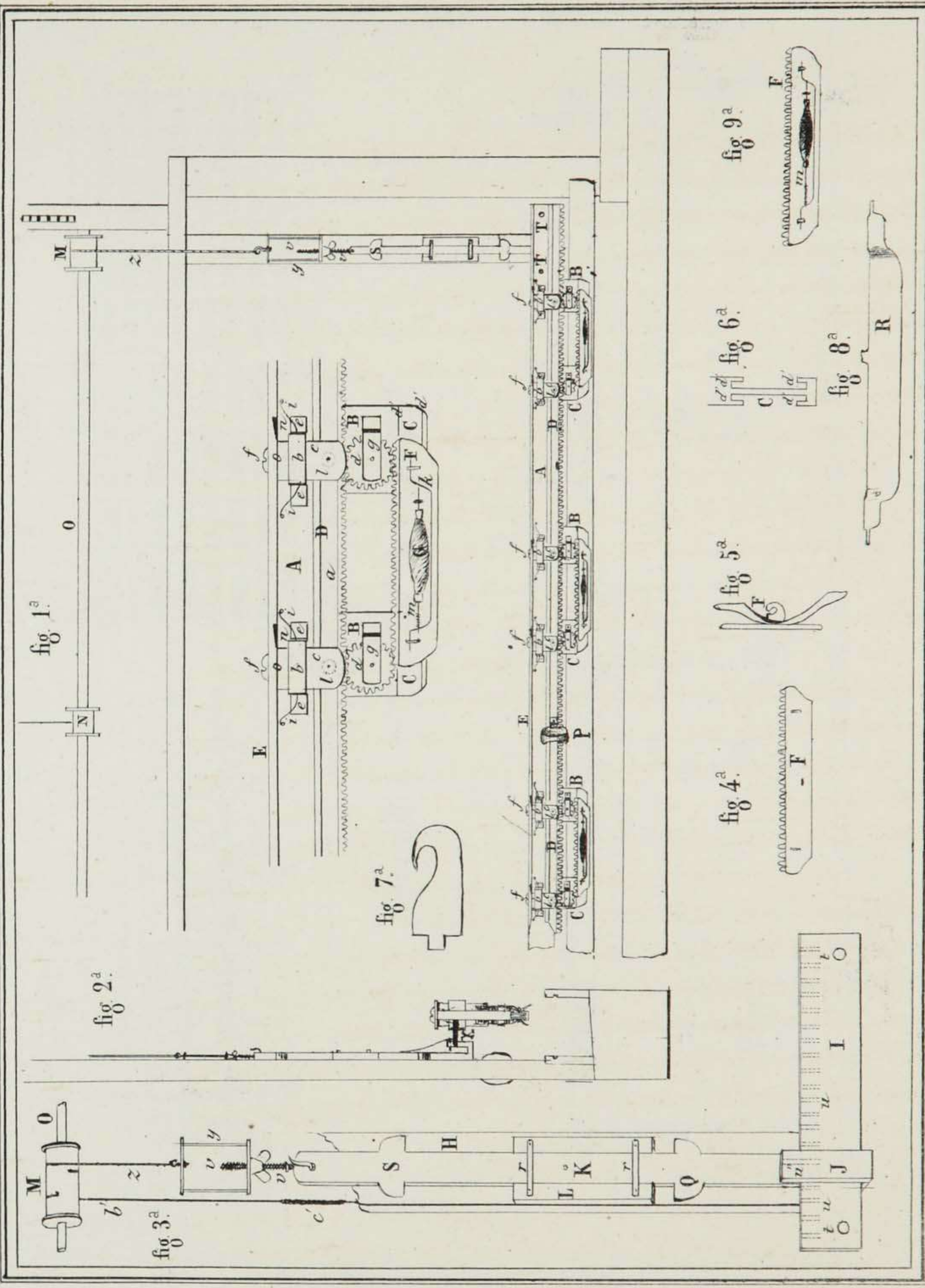
Lám. LXXIX



# UTENSILIOS

Caja de espolinar.

Lam. LXXX.



Prensa de chinár.

fig. 1<sup>a</sup>

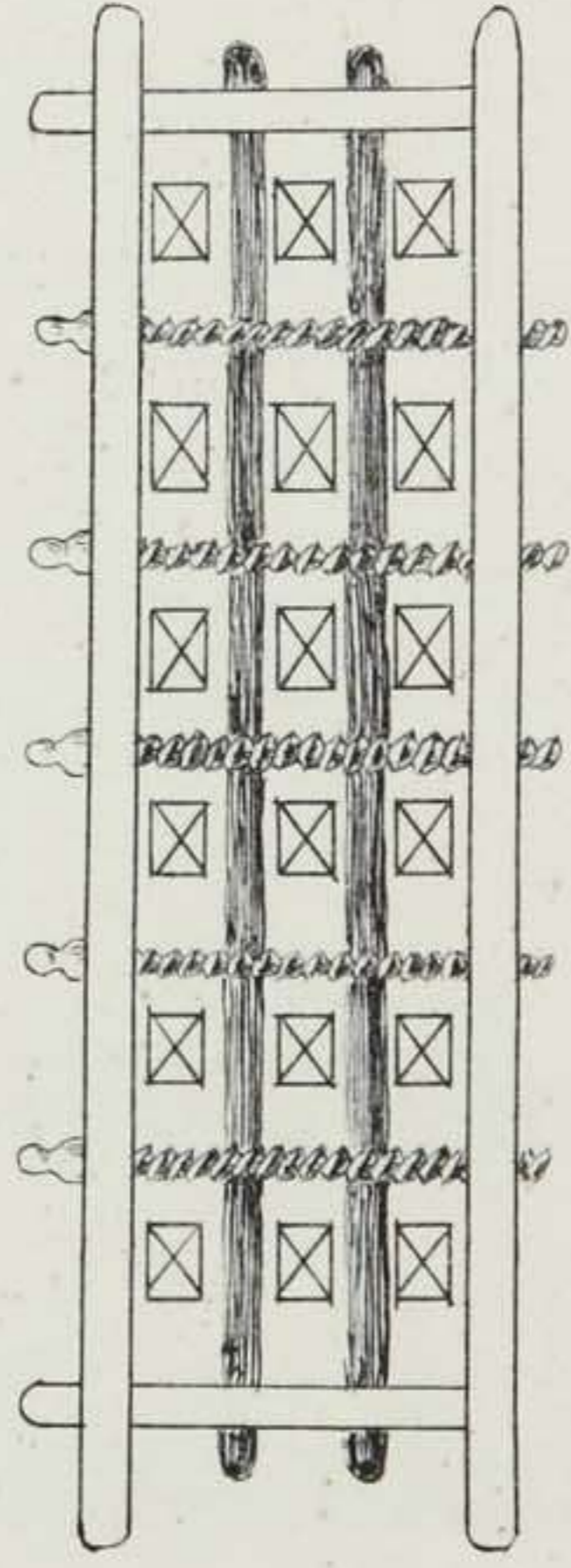
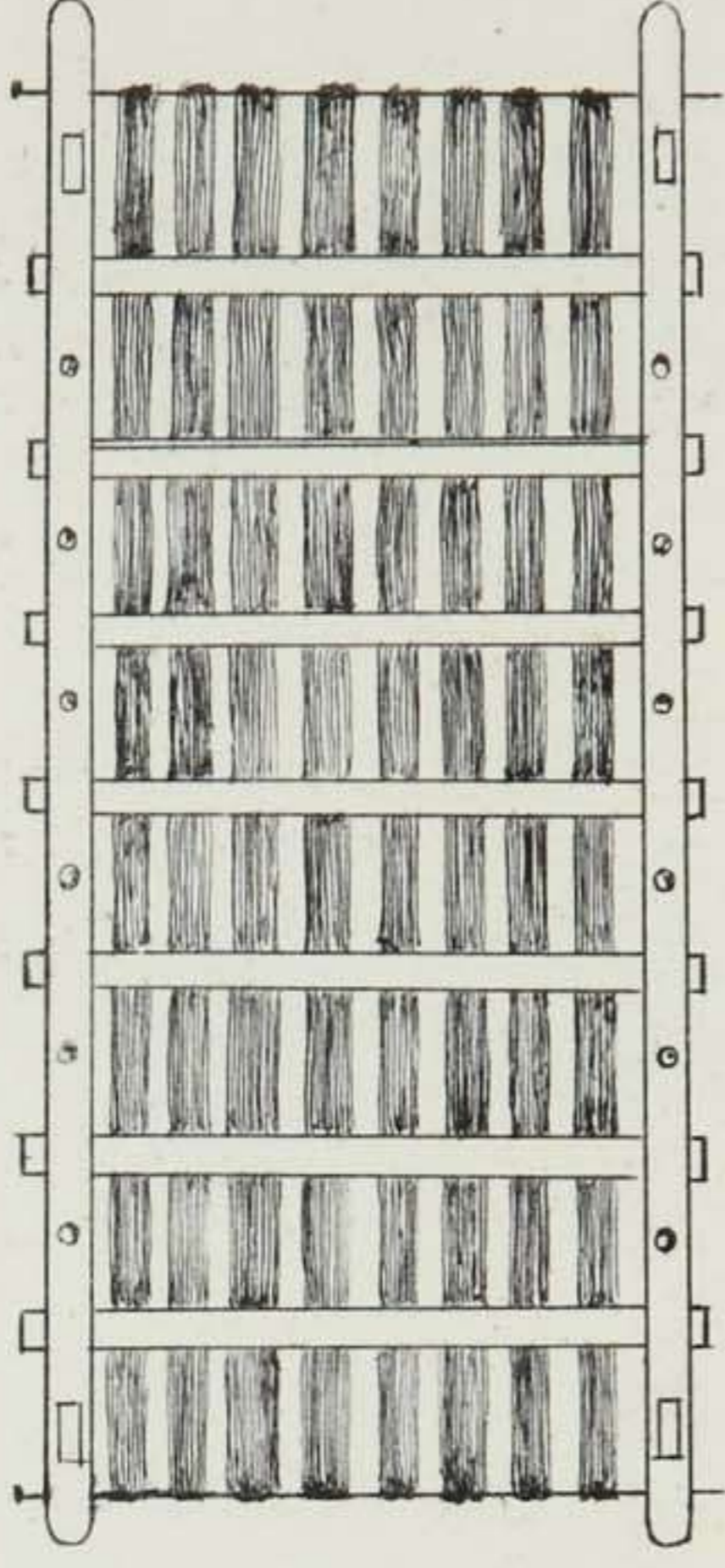


fig. 2<sup>a</sup>



Mecanismo para chinár en estampado.

fig. 3<sup>a</sup>

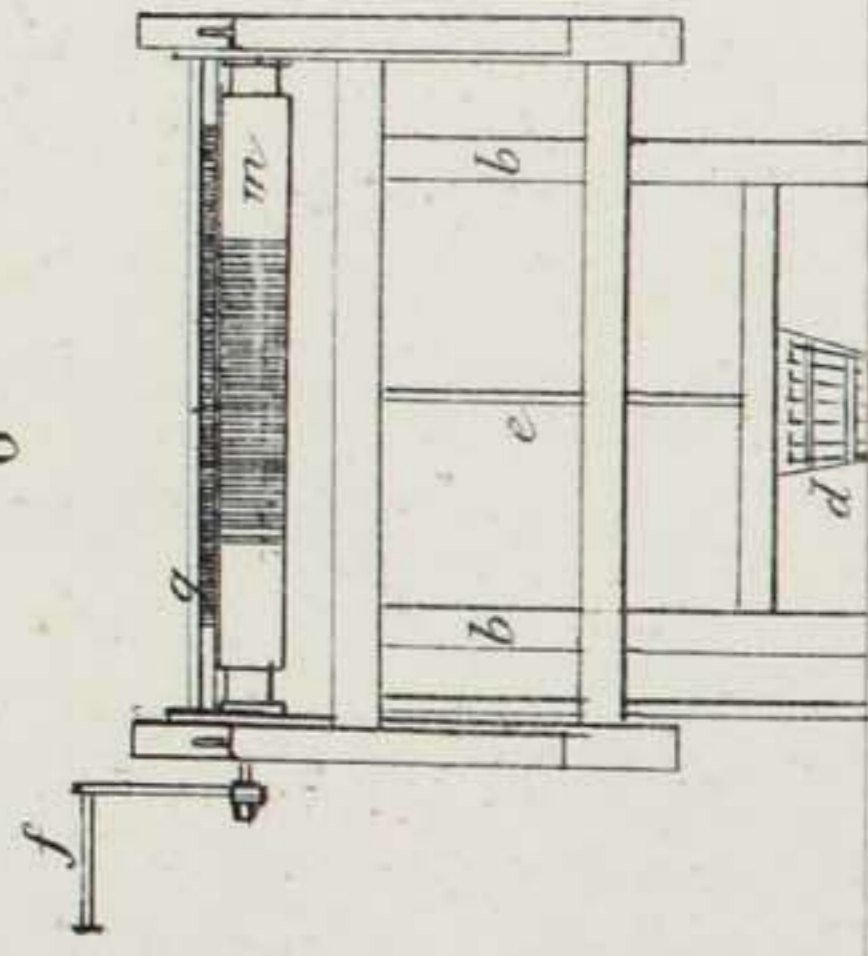
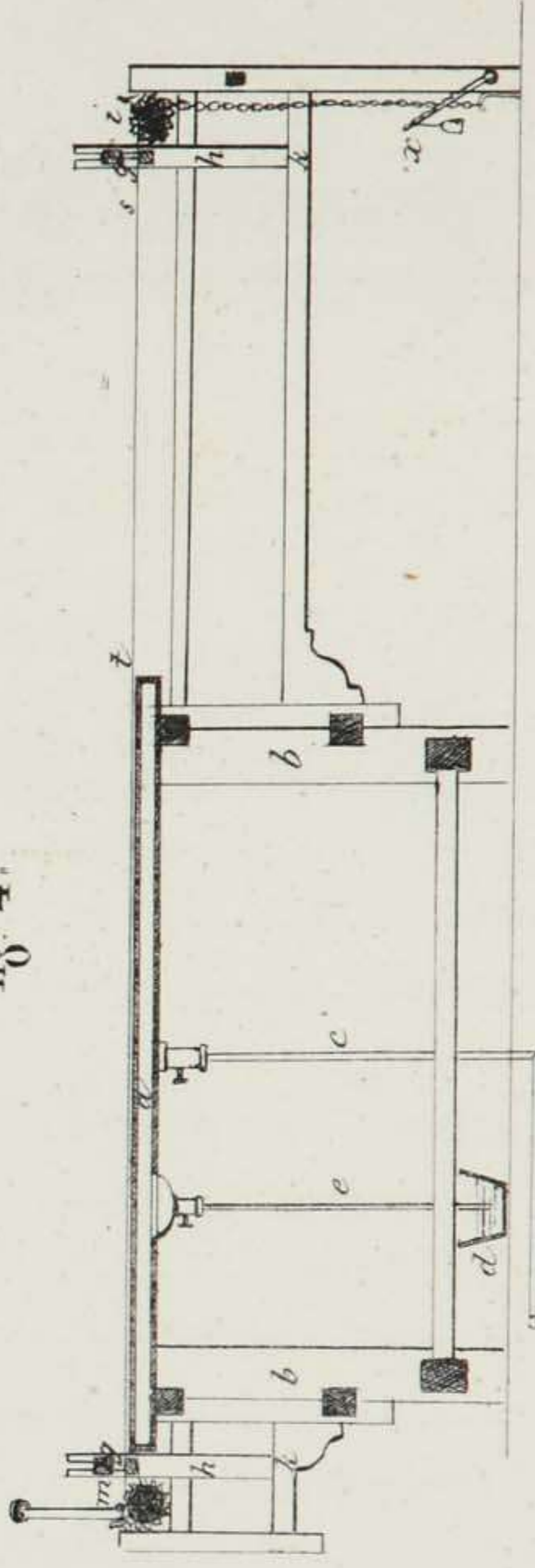
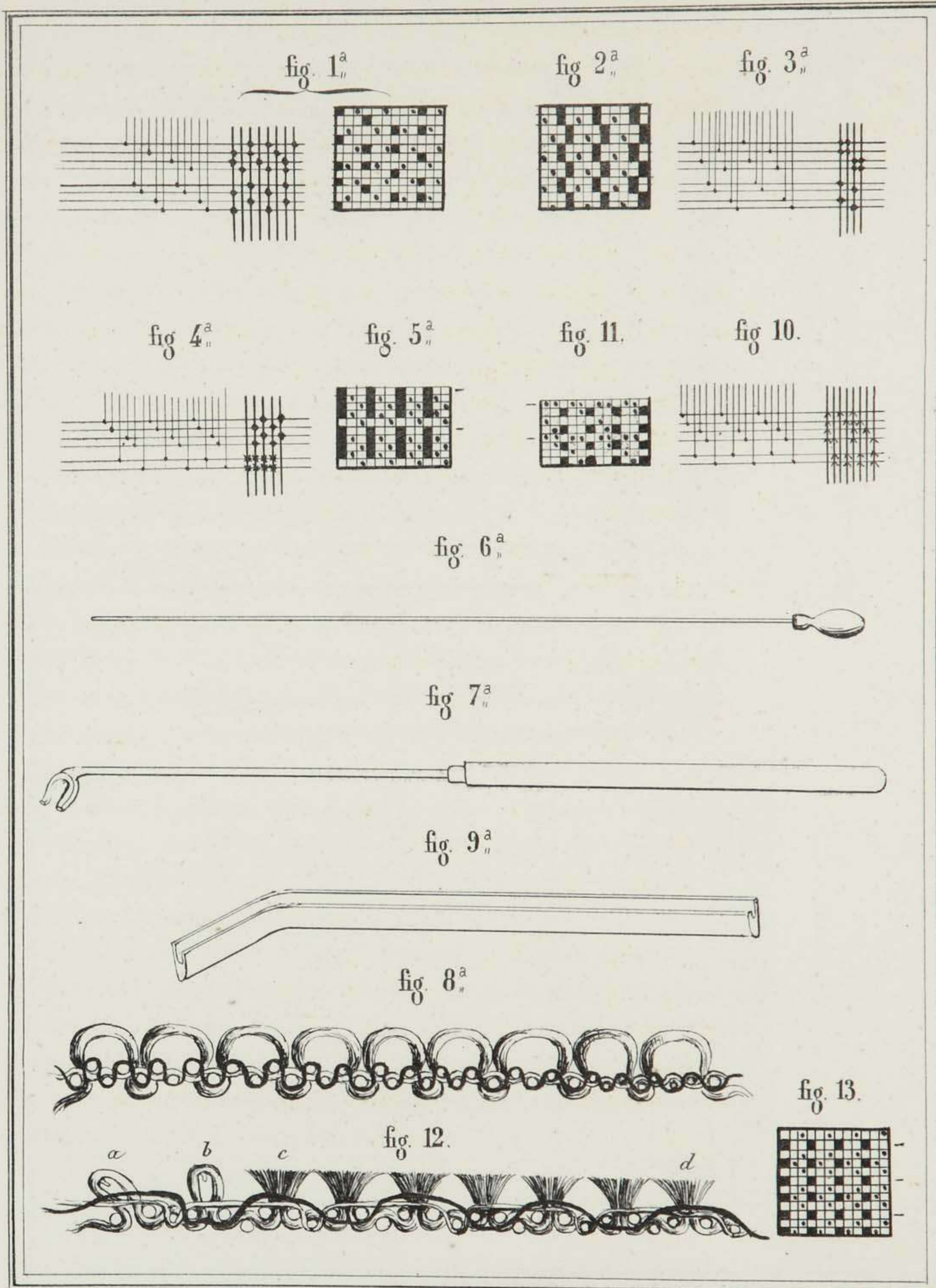


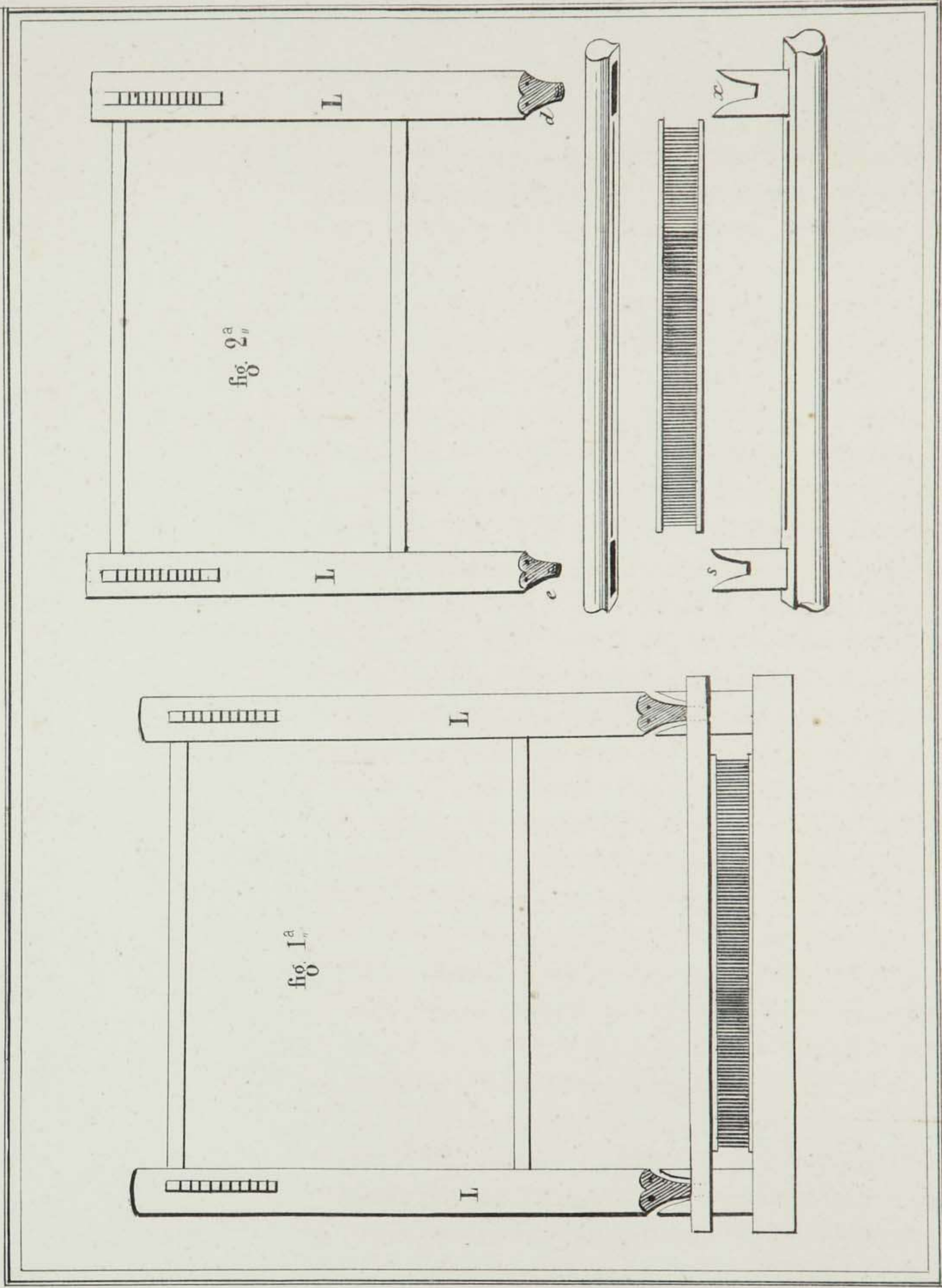
fig. 4<sup>a</sup>





CAJA QUEBRADA PARA TERCIOPELO.

Lám. LXXXIII.



# TERCIOPELOS.

Lám. LXXXIV.

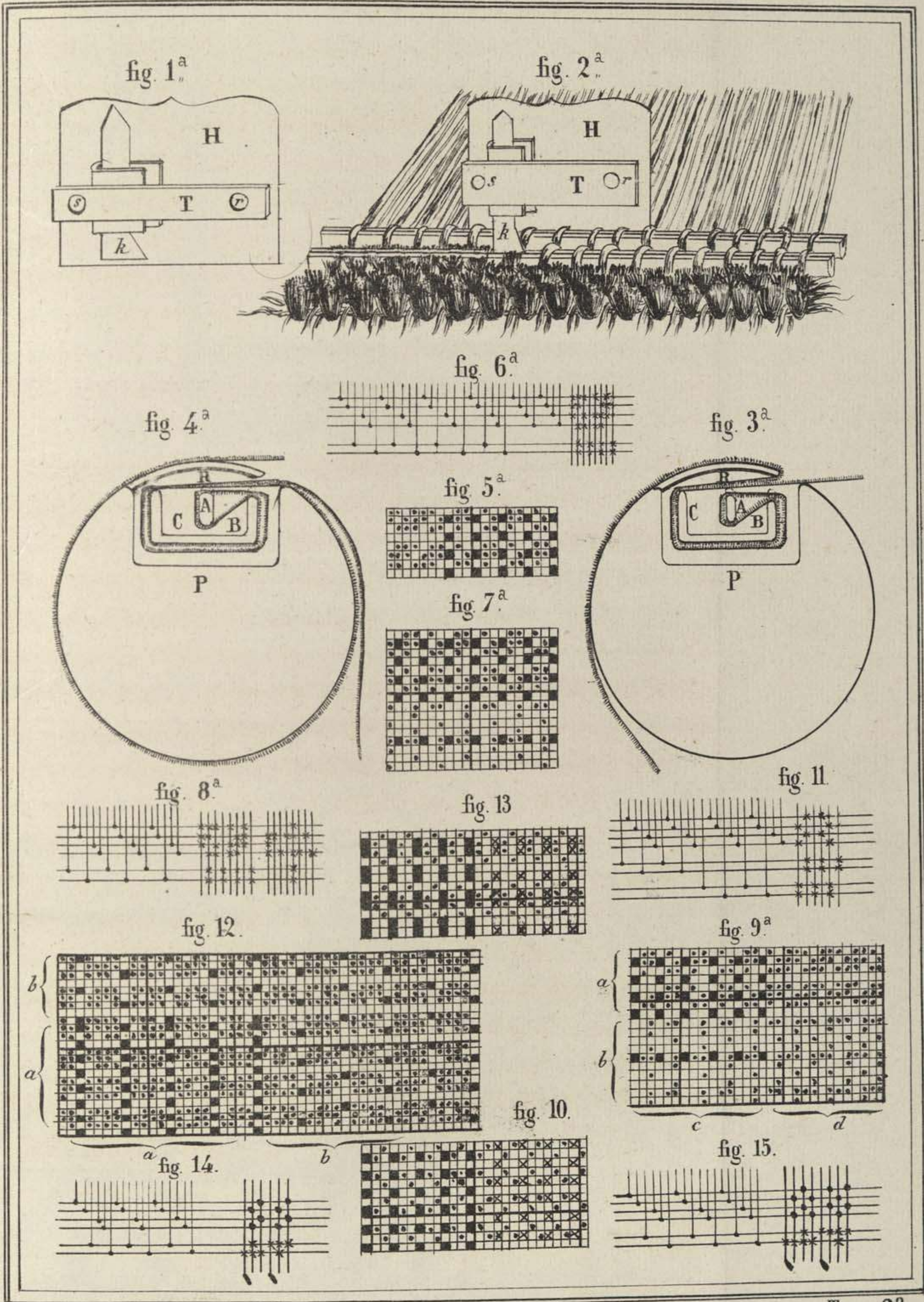


fig. 1<sup>a</sup>

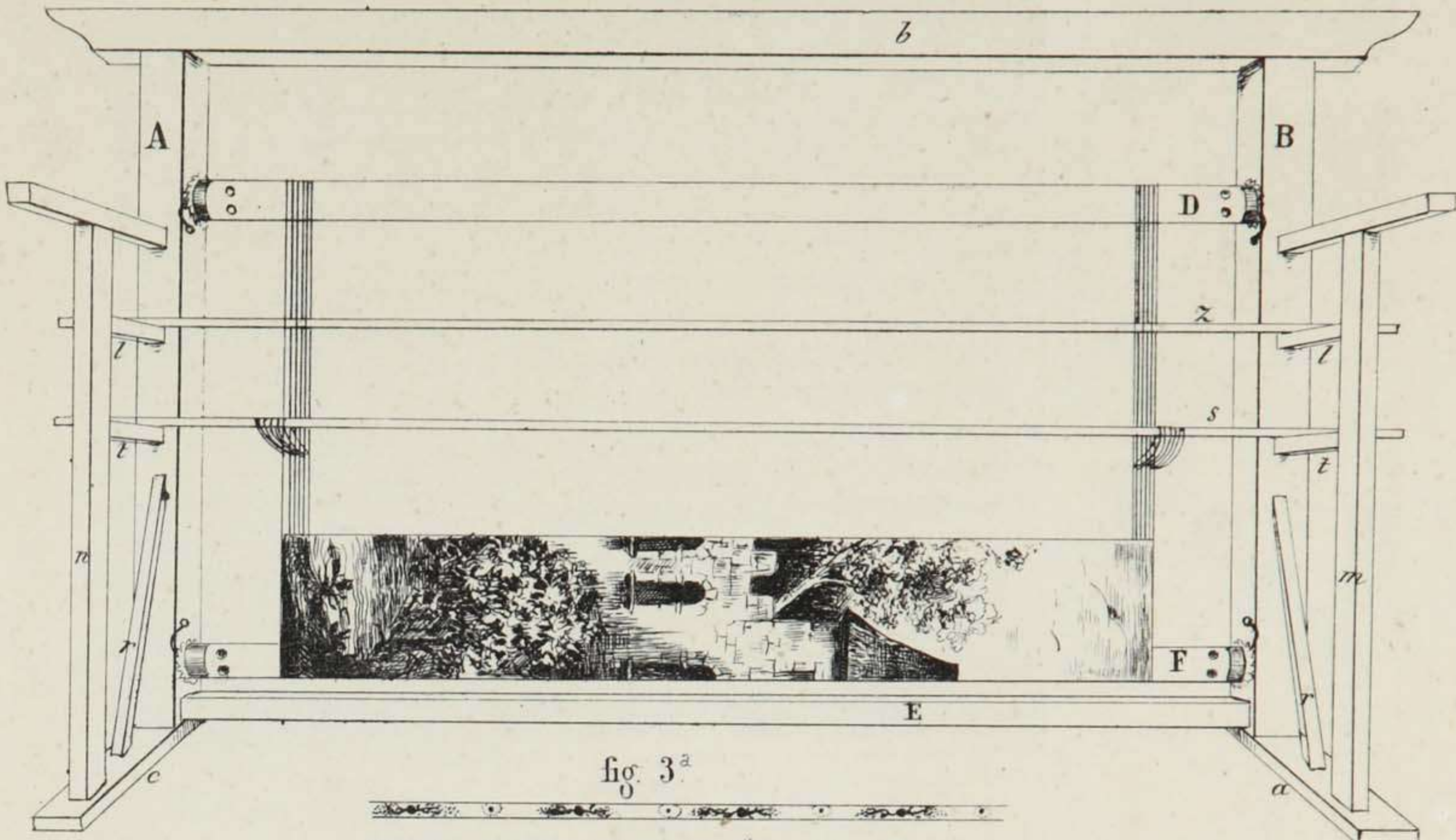


fig. 3<sup>a</sup>

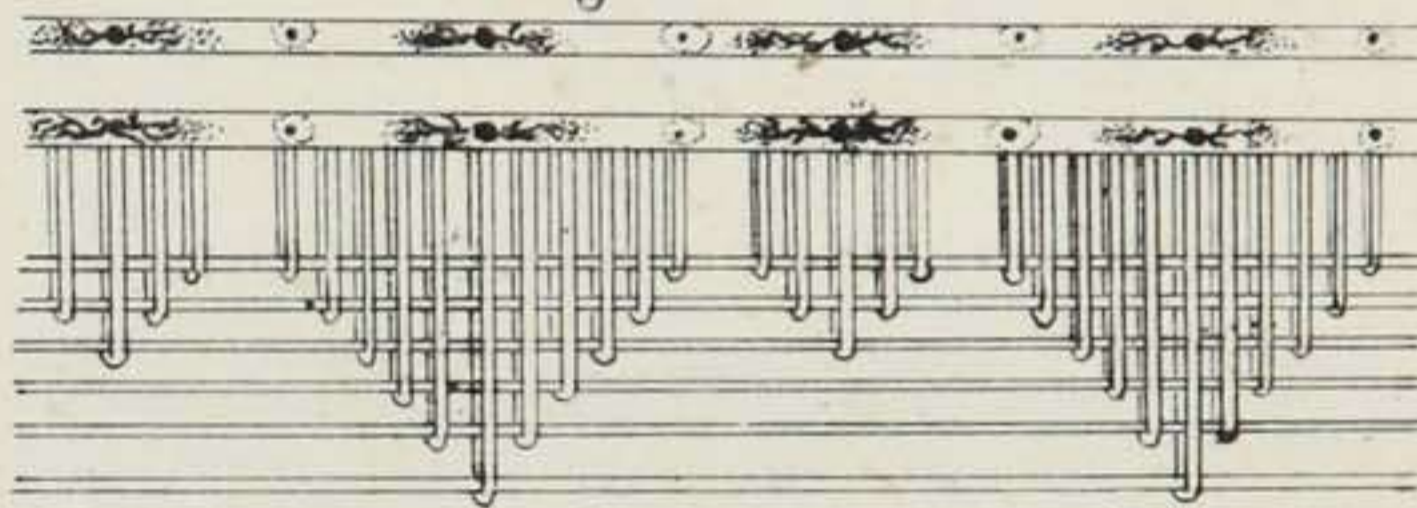


fig. 4<sup>a</sup>

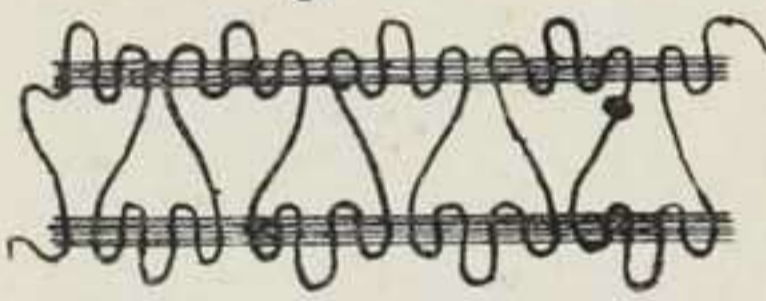


fig. 5<sup>a</sup>

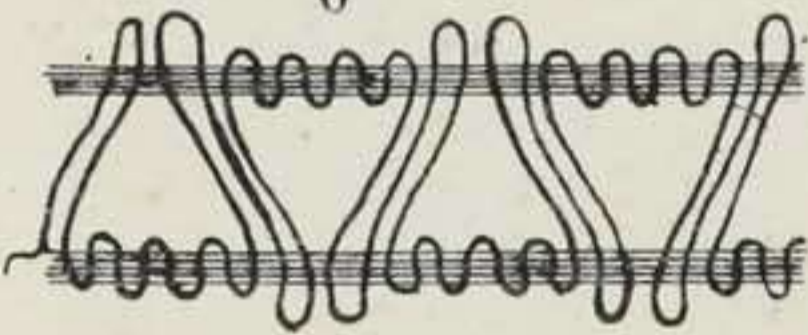


fig. 6<sup>a</sup>

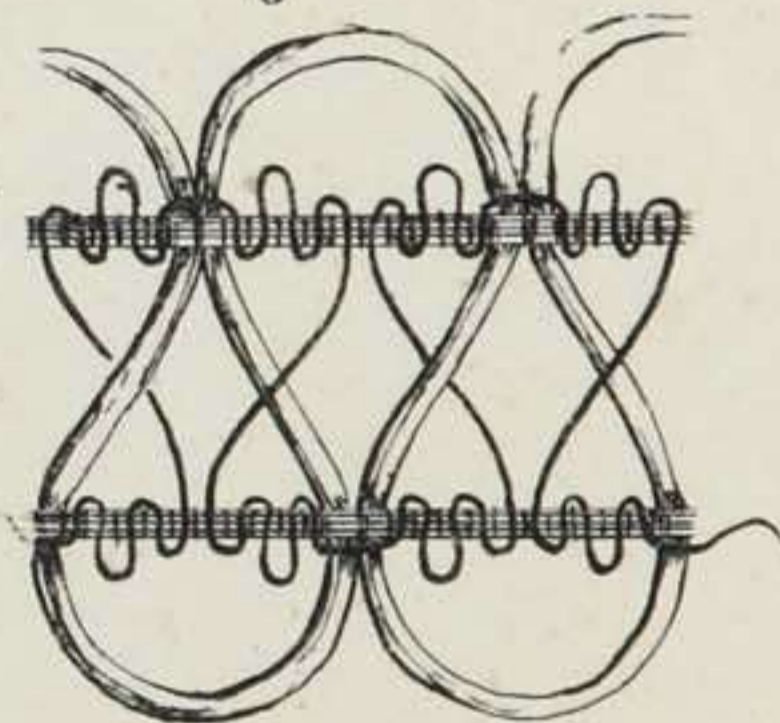


fig. 7<sup>a</sup>

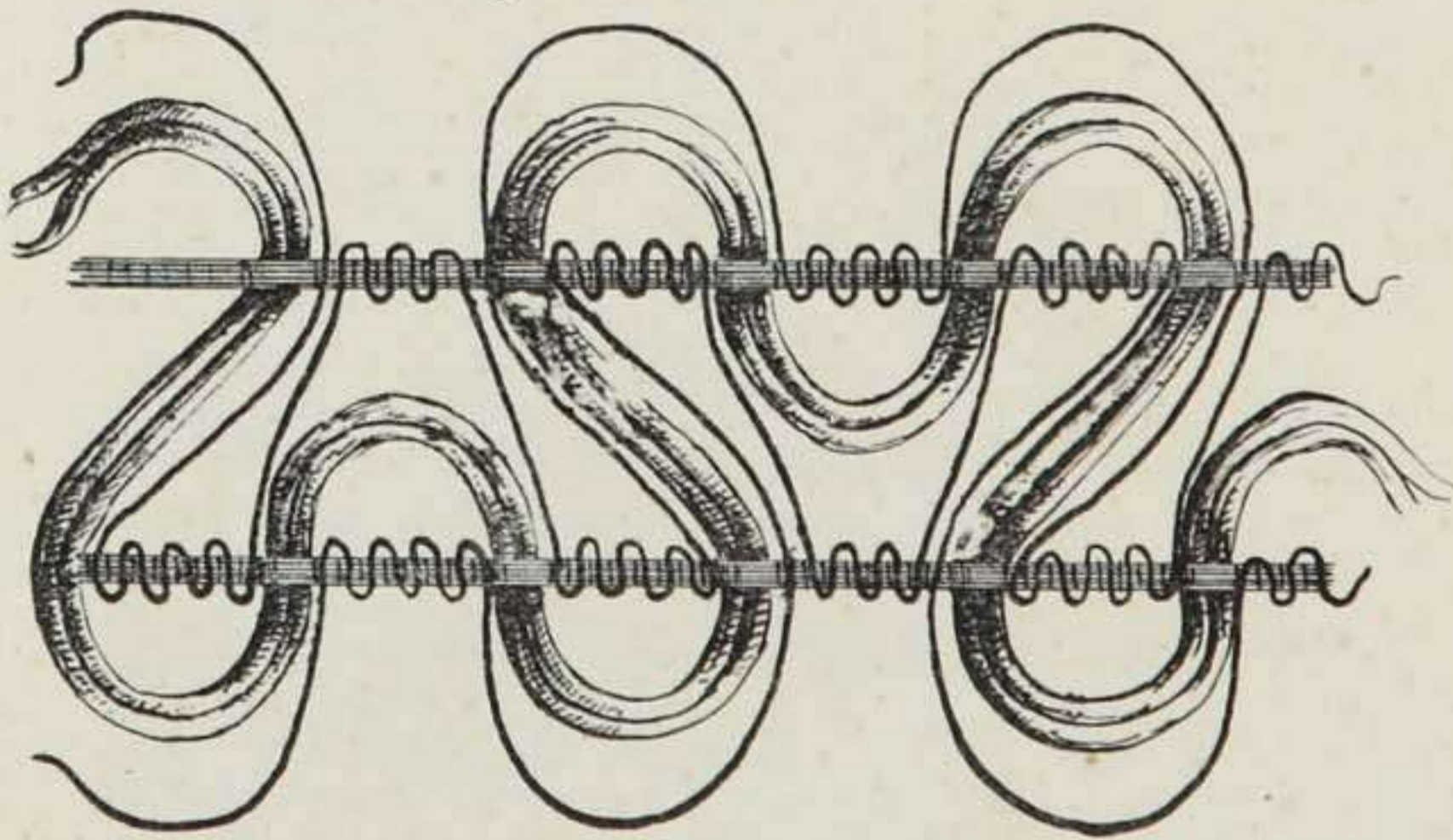
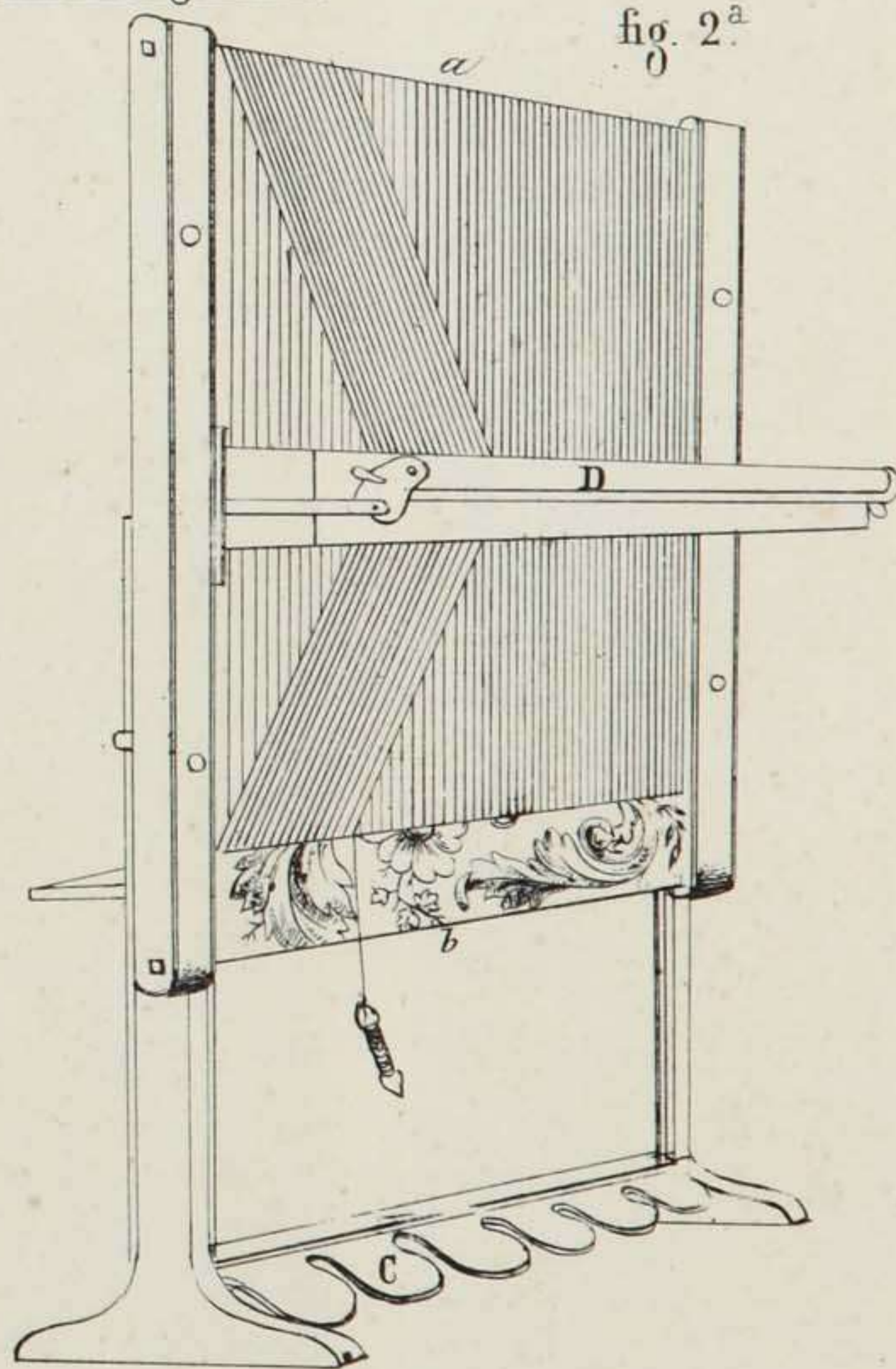


fig. 2<sup>a</sup>

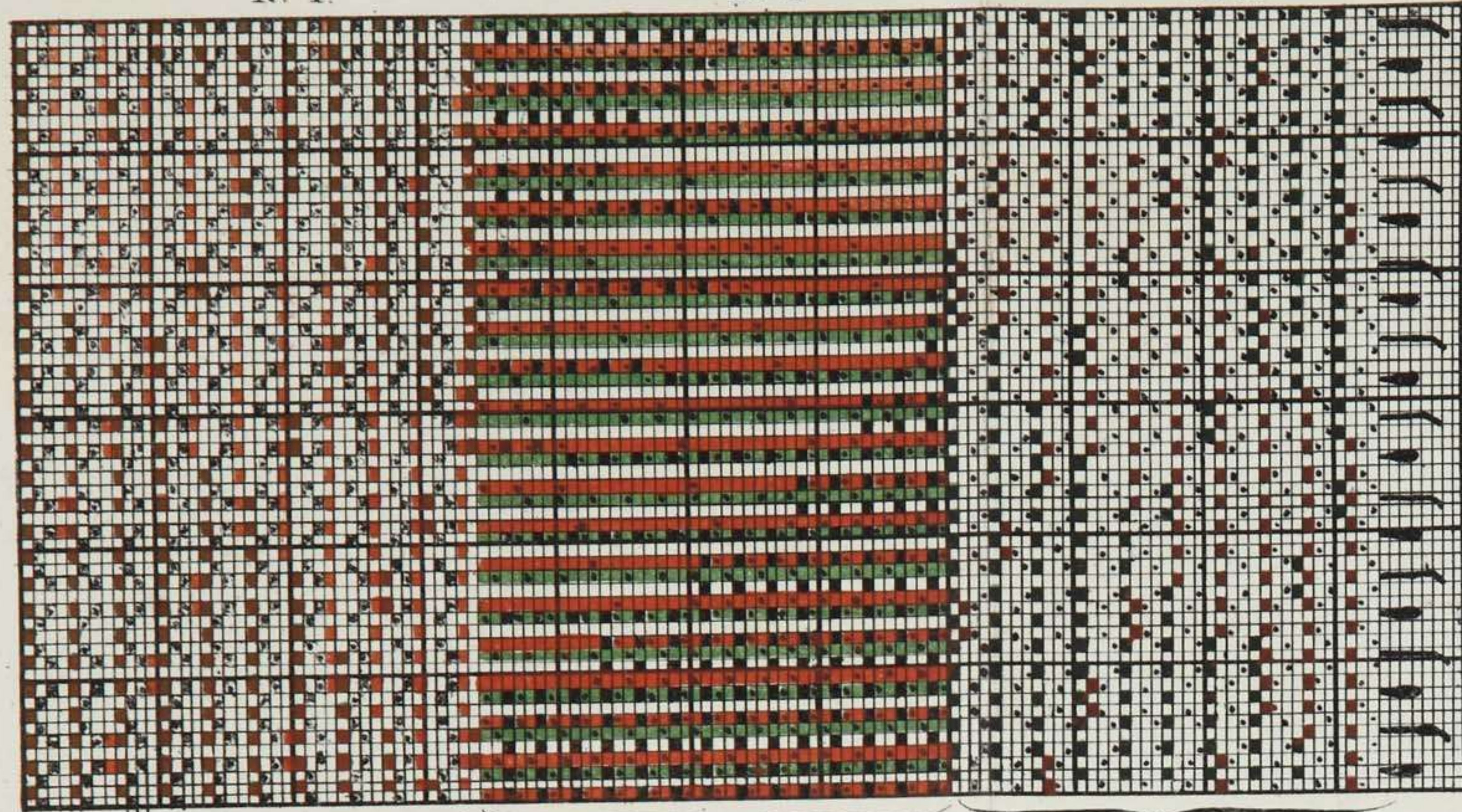




Nº 1.

fig 1<sup>a</sup>  
Nº 2

Nº 3.



Terciopelo a 2 cuerpos.

Terciopelo con recamado de filetes por 2 tramás.

Terciopelo y rizo.

fig 2<sup>a</sup>



fig 4<sup>a</sup>

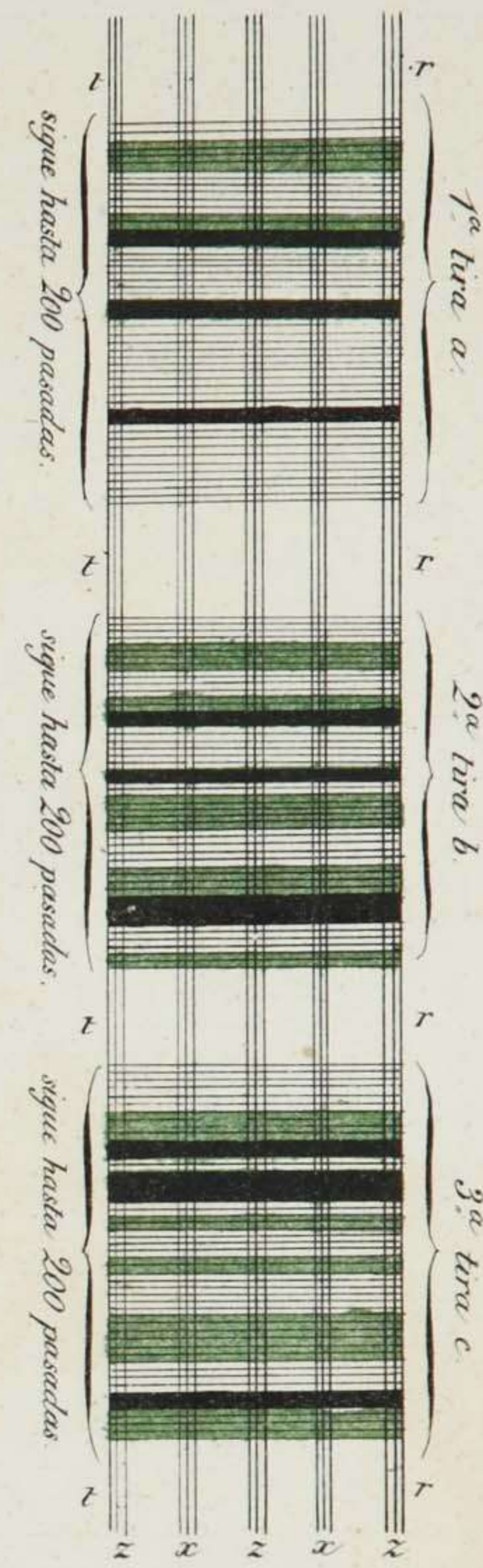


fig 3<sup>a</sup>

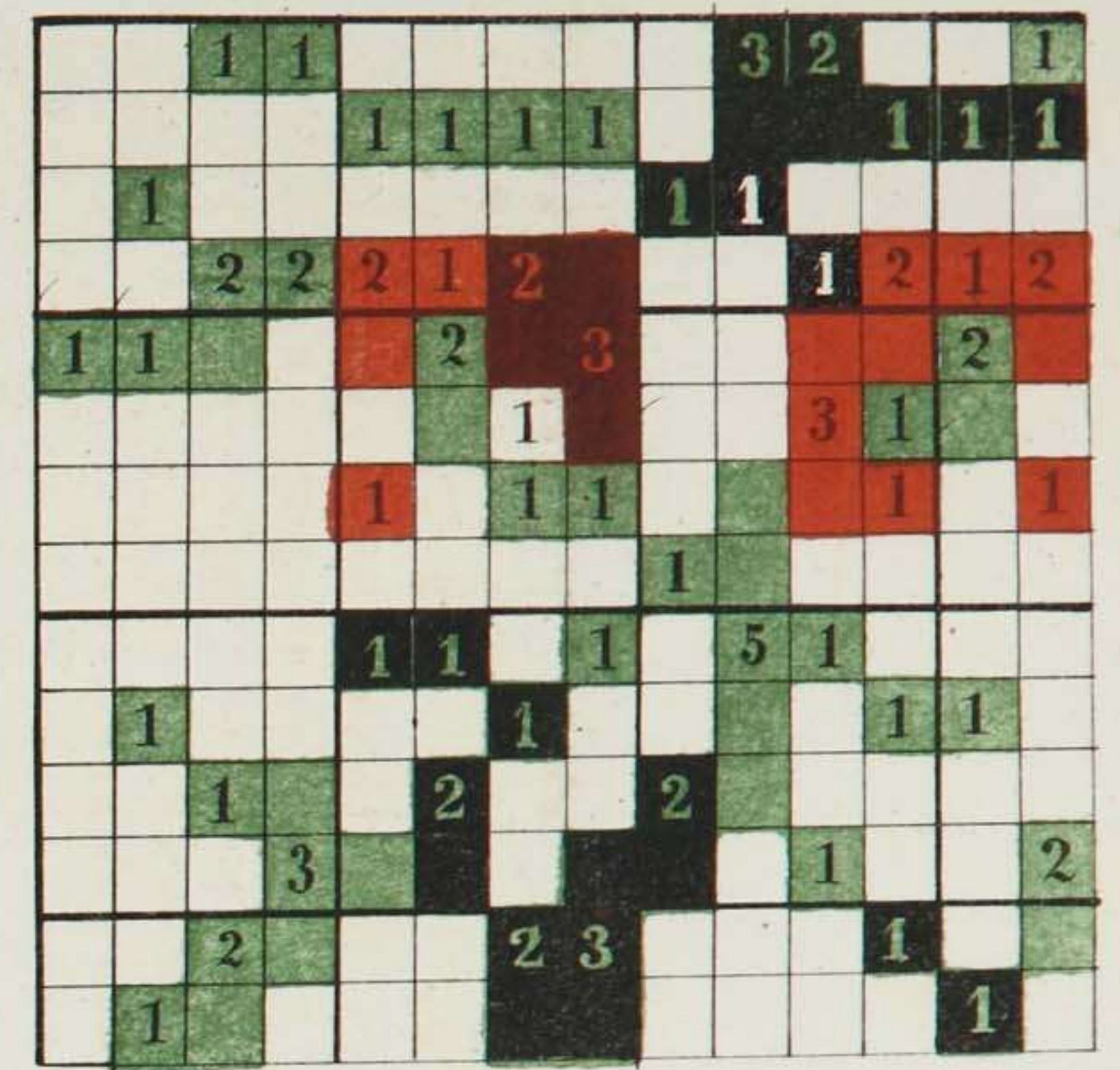


fig 7<sup>a</sup>

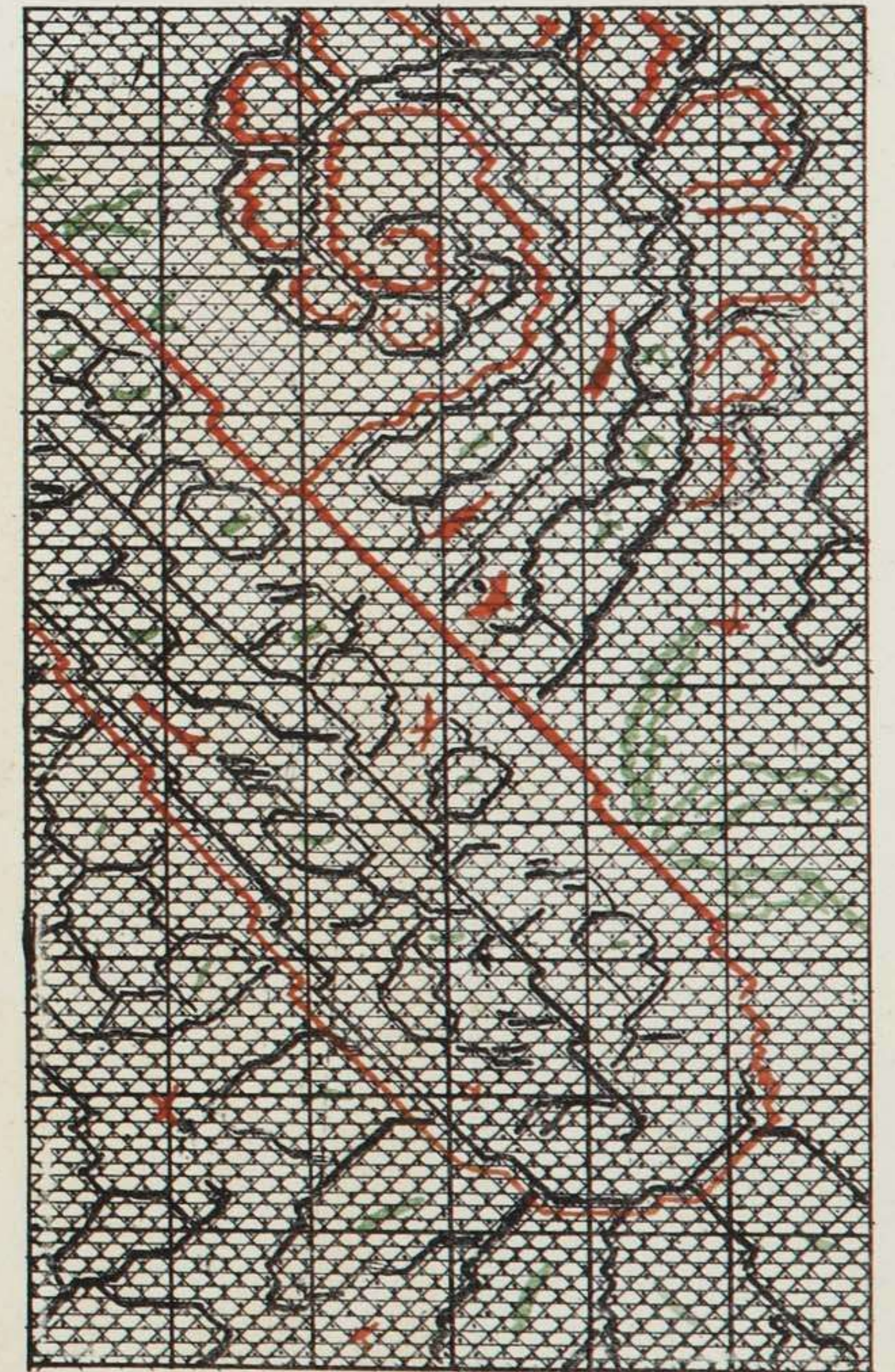


fig 8<sup>a</sup>



fig 5<sup>a</sup>

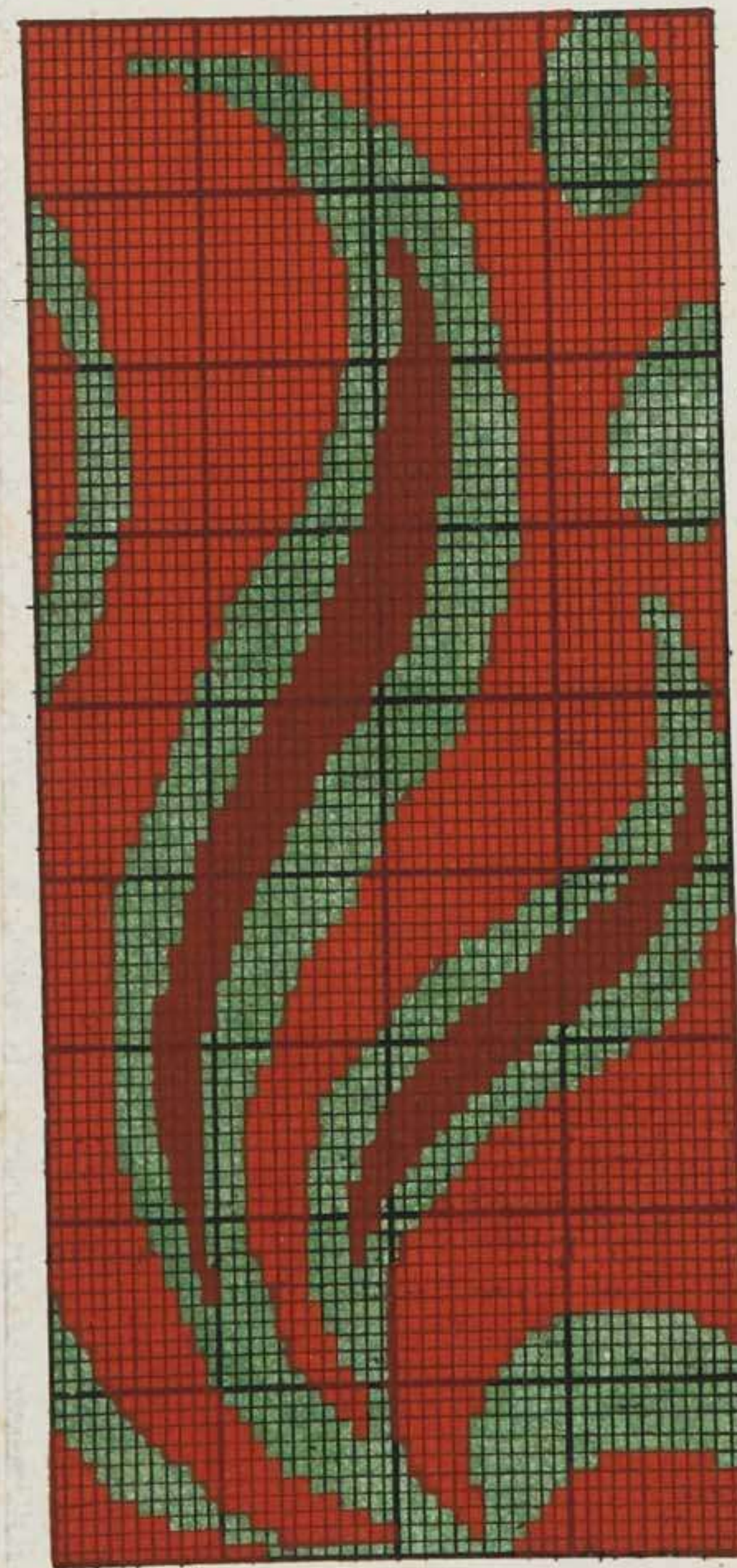
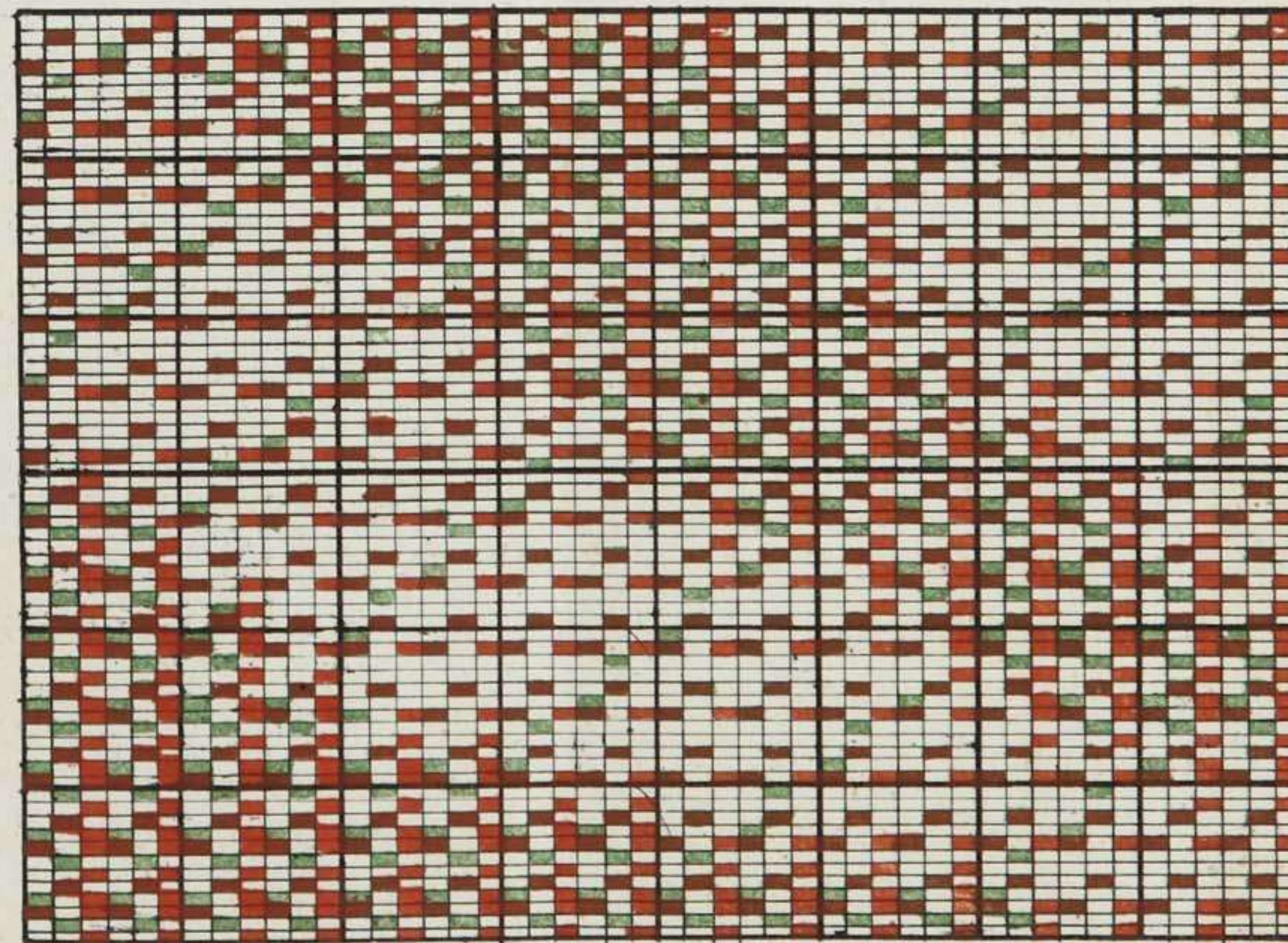
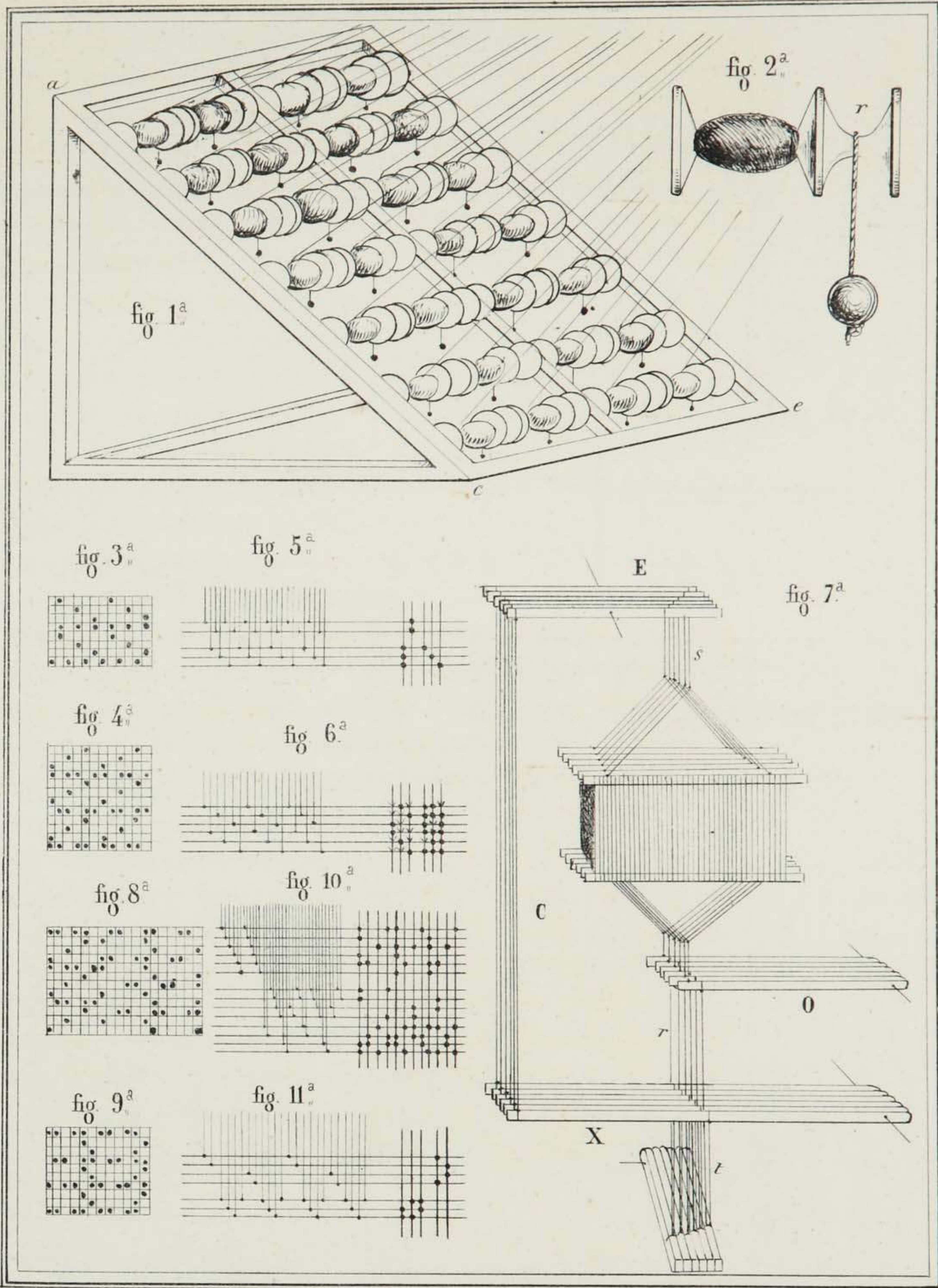


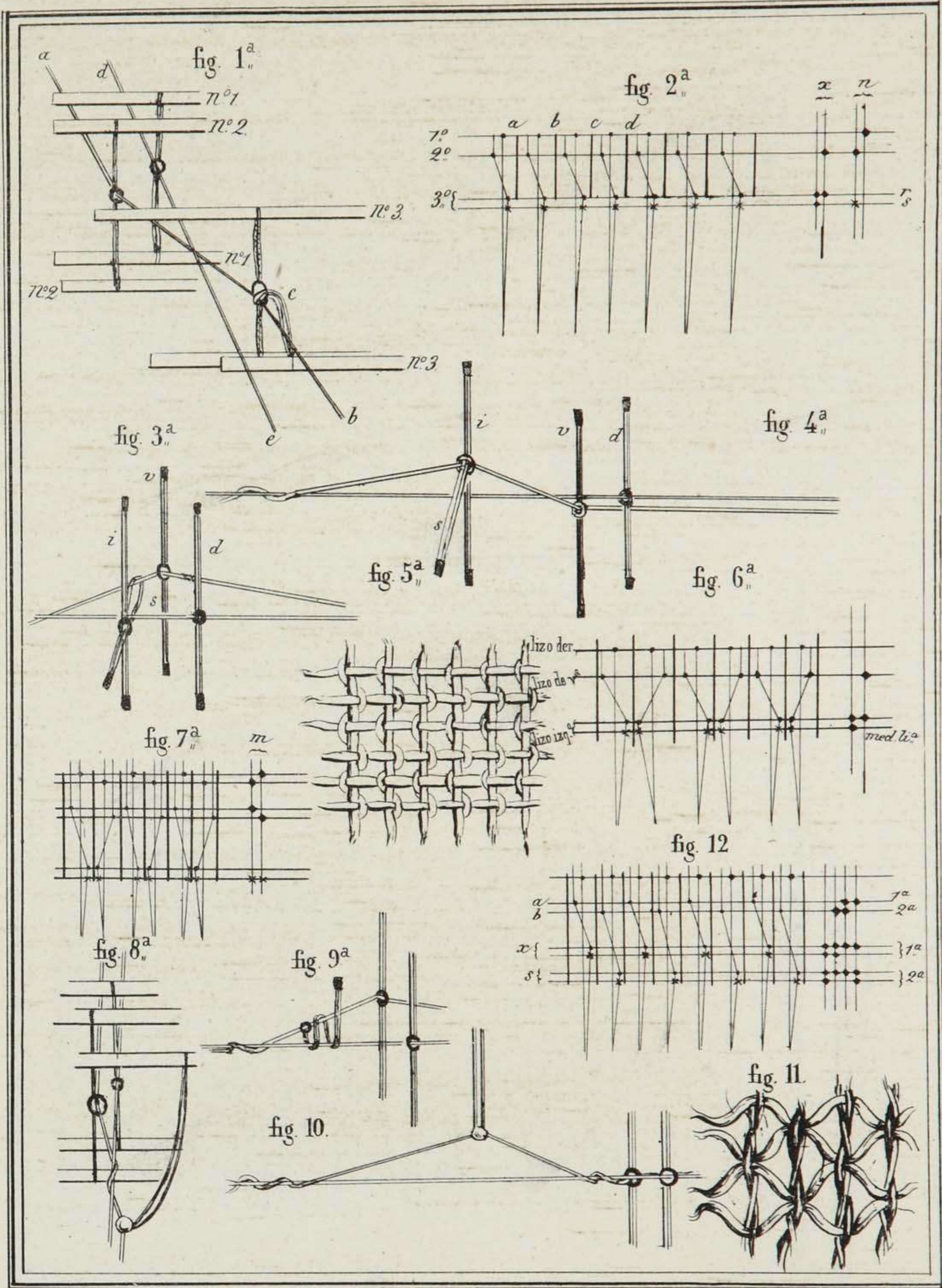
fig 6<sup>a</sup>

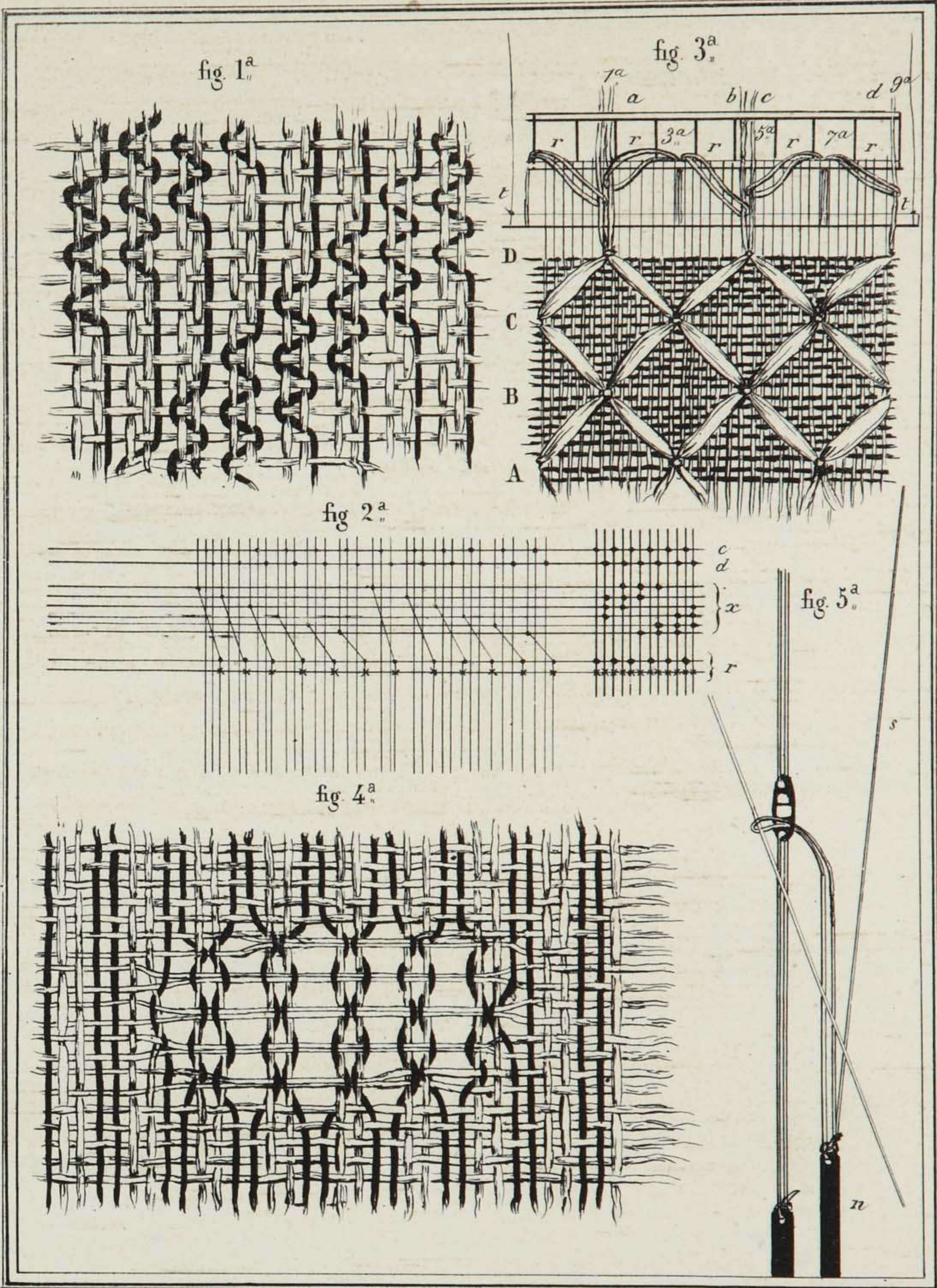


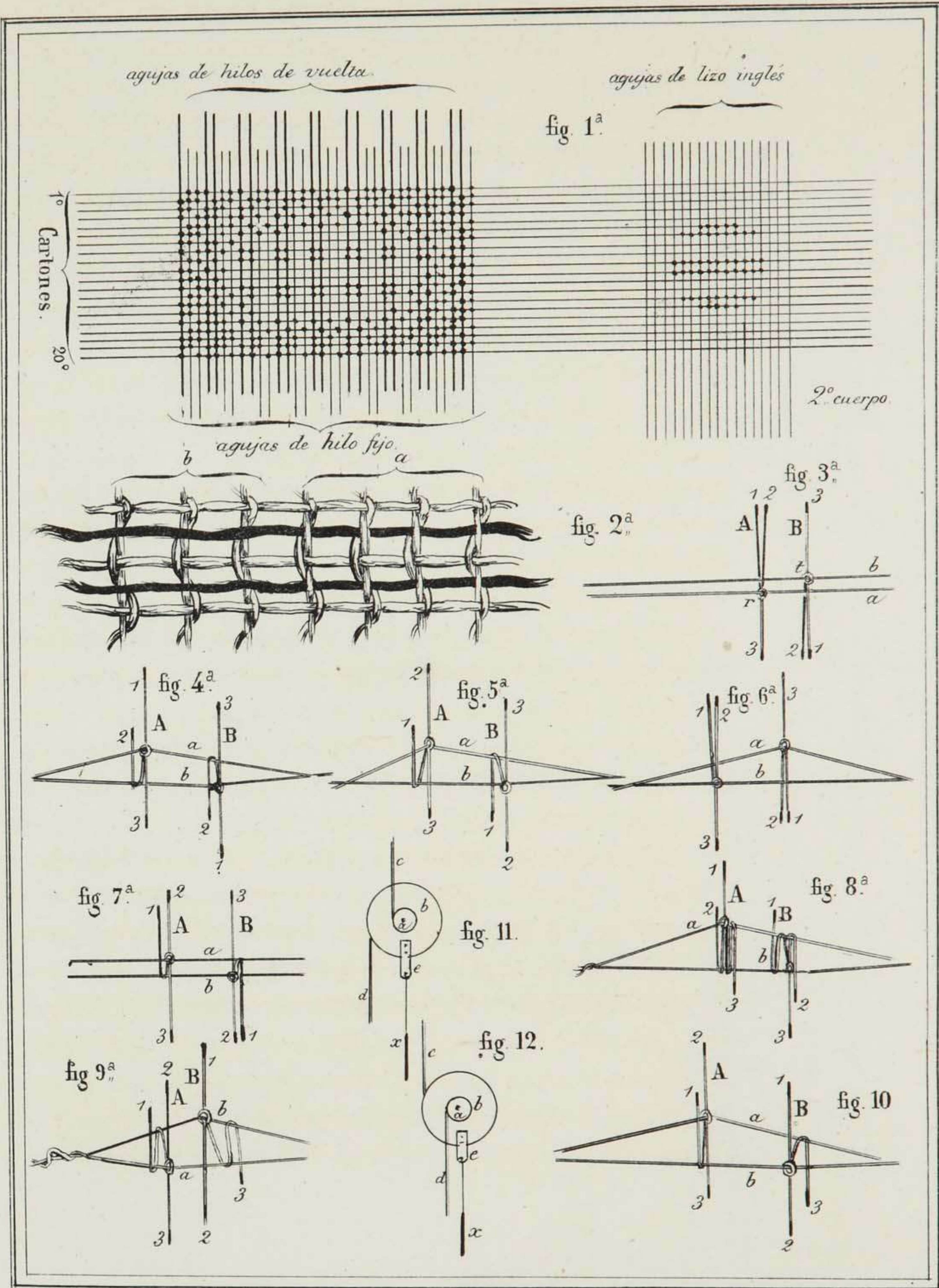
CÁNTARA PARA TERCIOPELO.  
 ALZA Y BAJA DE LOS LIZOS.  
 TERCIOPELOS ALGODON.

Lam. LXXXVII



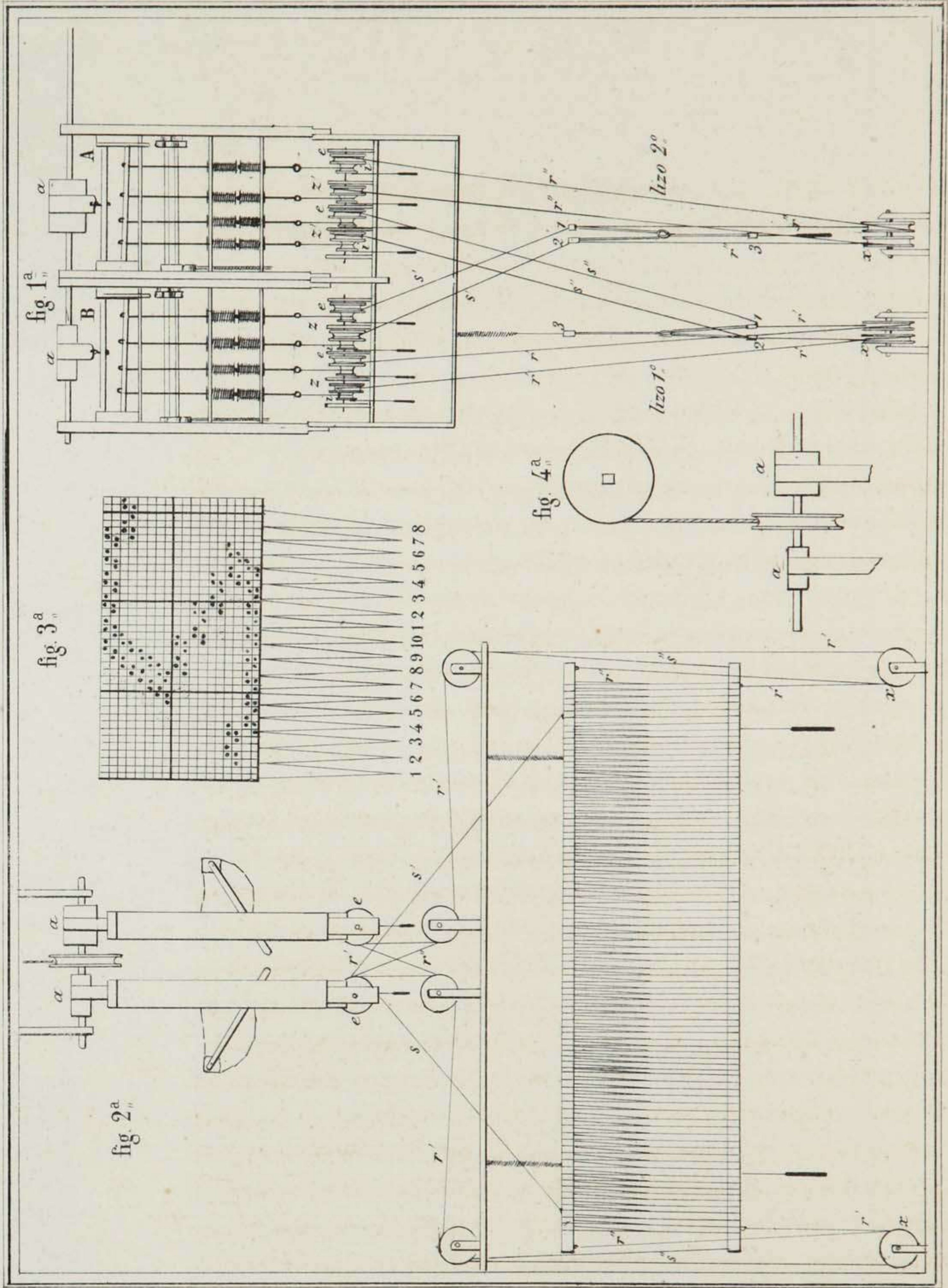






MONTURA PARA GASAS, (nuevo sistema.)

Lám. XCI.



# PAÑUELOS CACHEMIRA, TERCIOPELOS, CINTERIA.

Lám. XCII.

fig. 4<sup>a</sup>

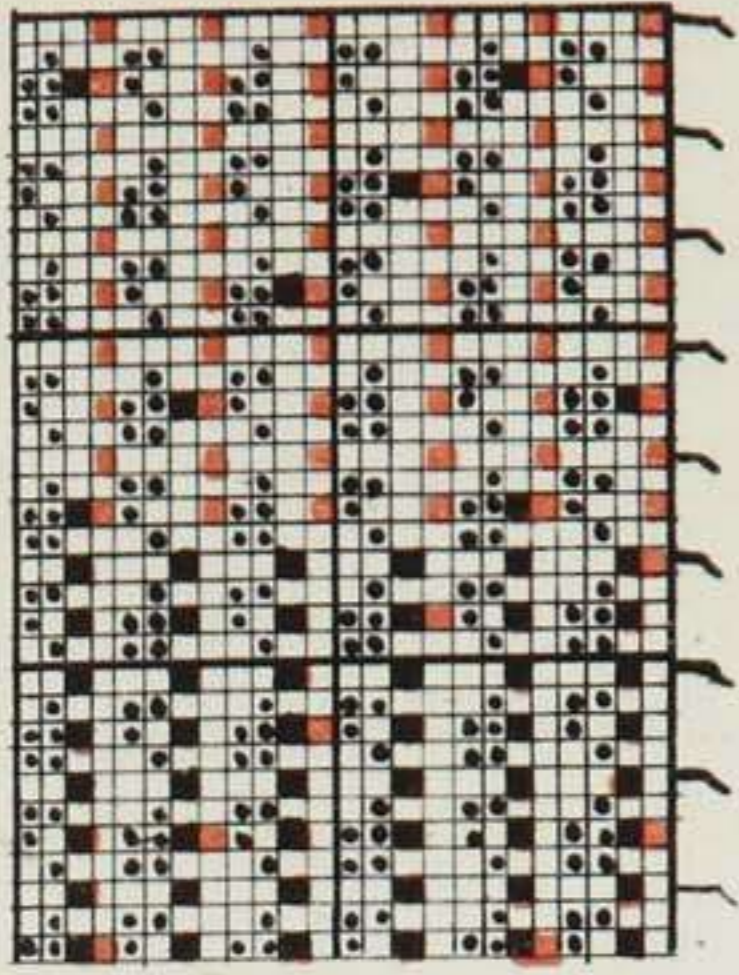


fig. 1<sup>a</sup>

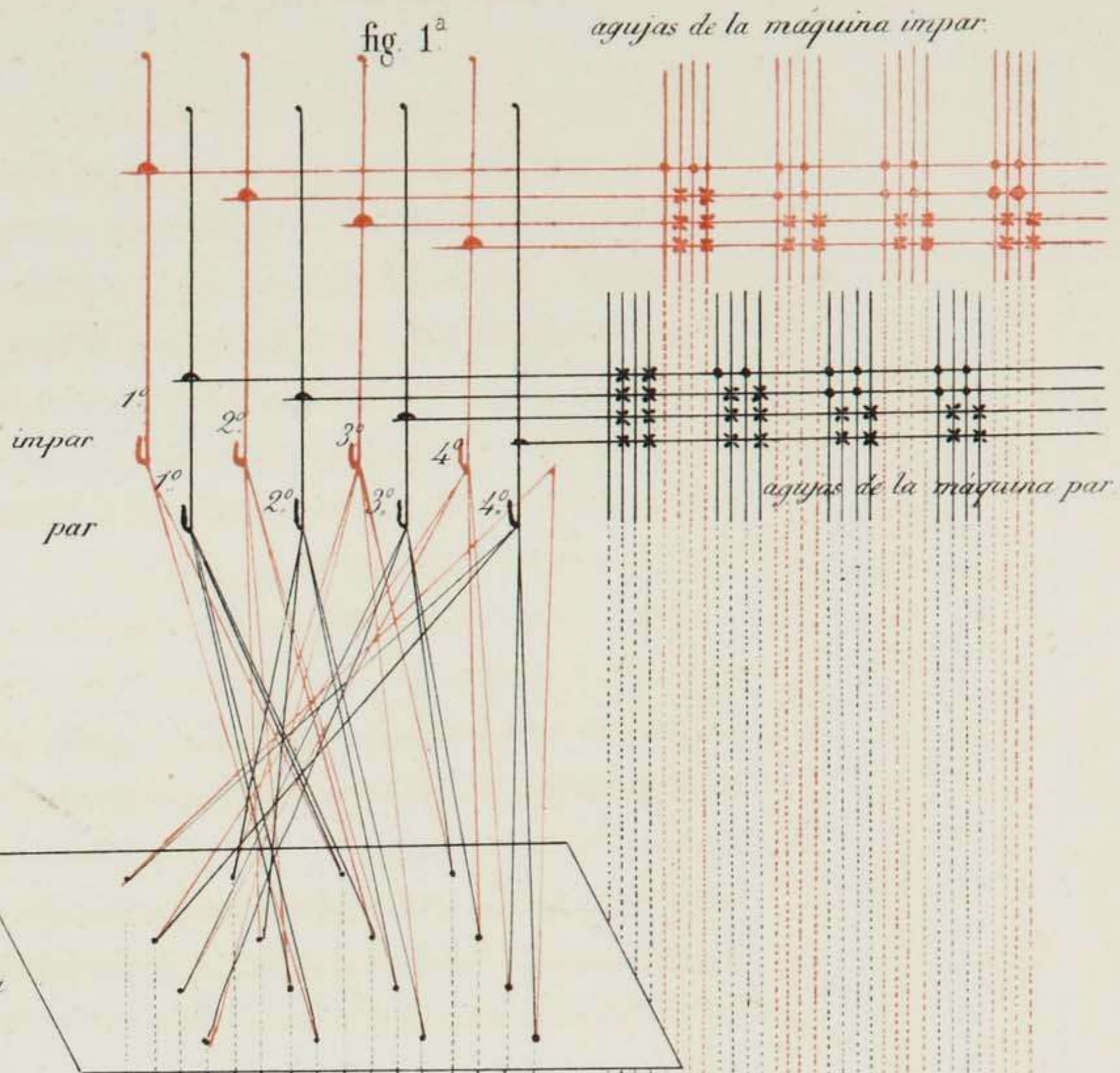
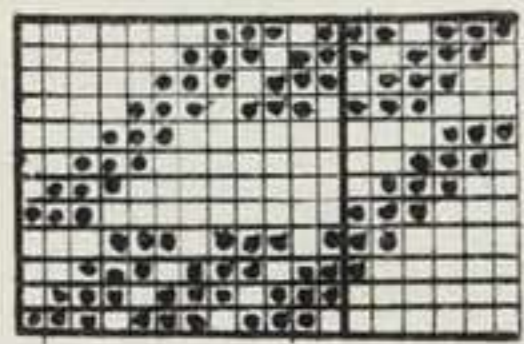


fig. 2<sup>a</sup>

D



fig. 3<sup>a</sup>



lizados de subida.  
lizados rebates.

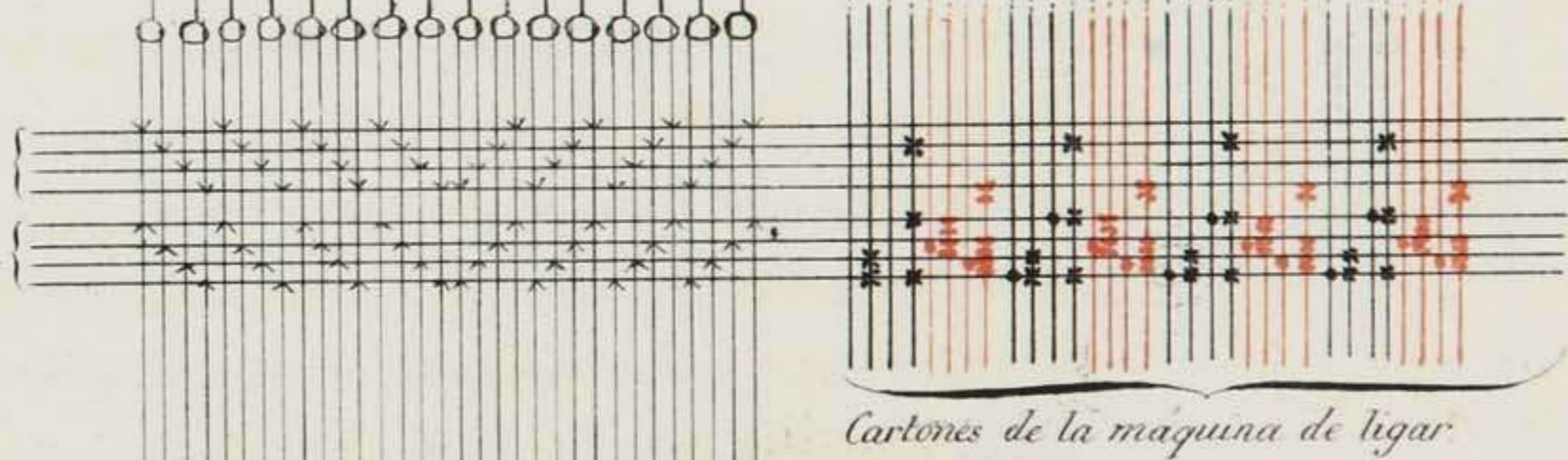


fig. 5<sup>a</sup>

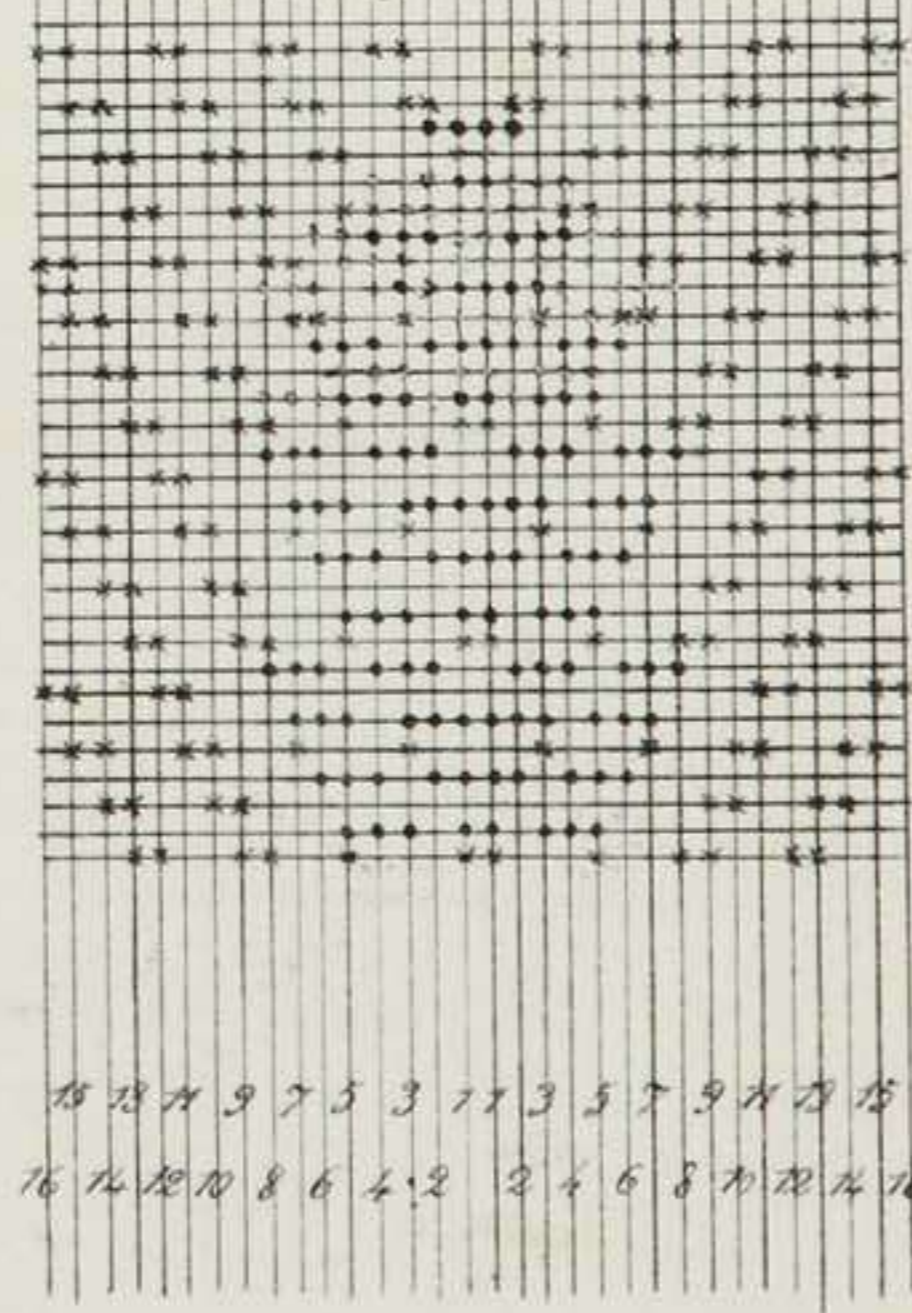
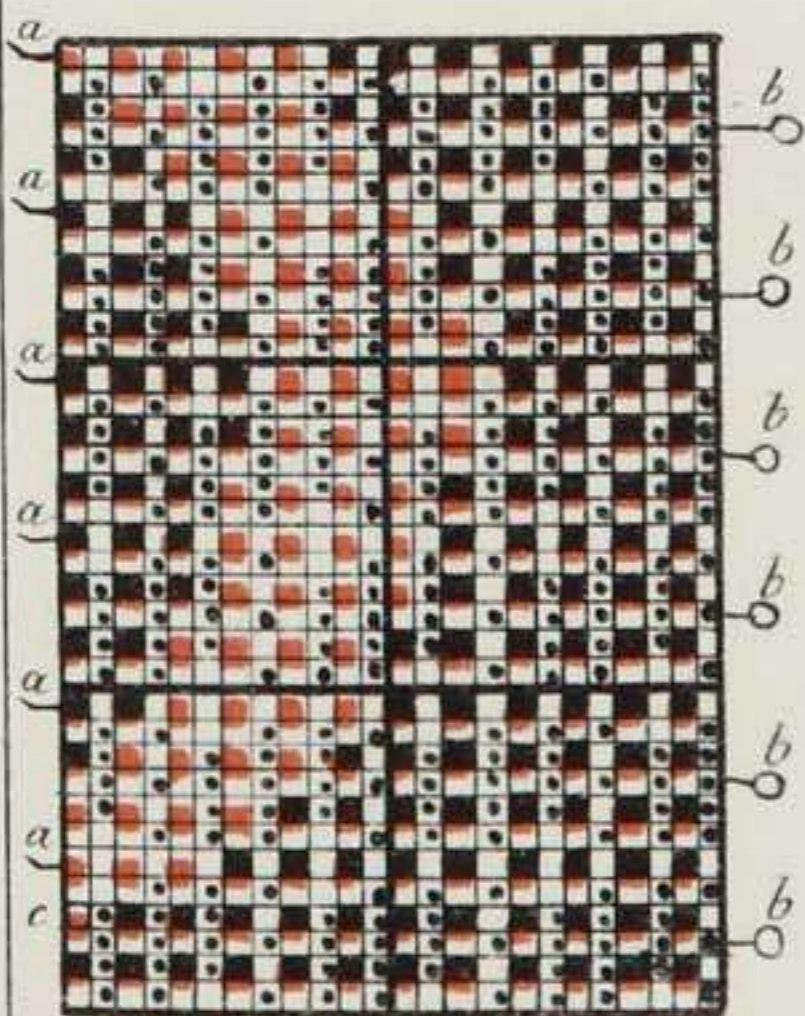
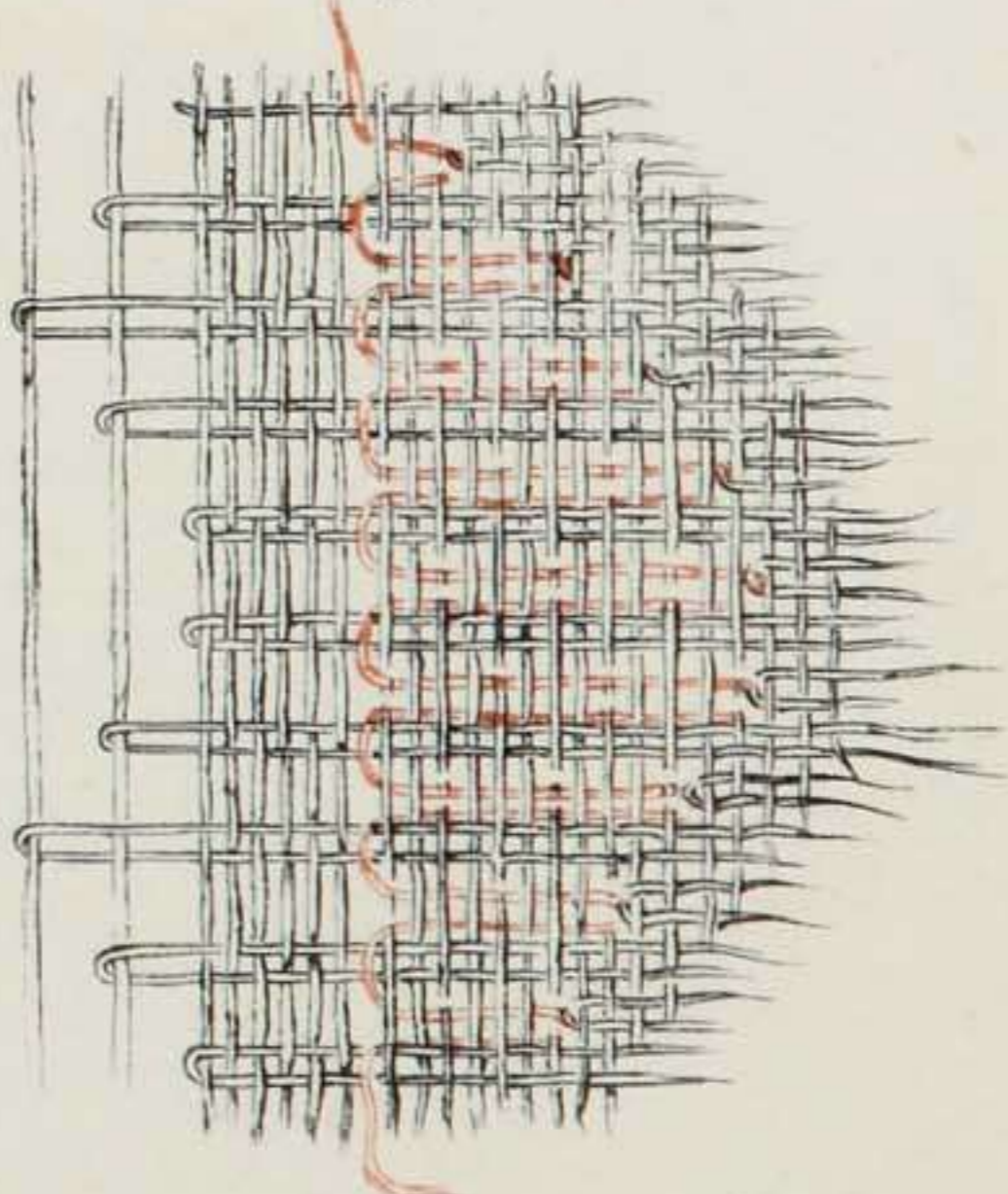


fig. 6<sup>a</sup>



PAPELES GRILLET Y BRIQUETE.  
 MAQUINA DE DOBLE GRIFA.

Lám. VIII.

fig. 1<sup>a</sup>

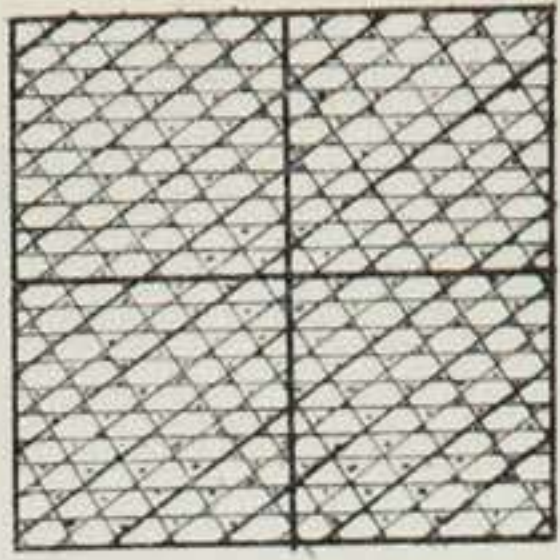


fig. 2<sup>a</sup>

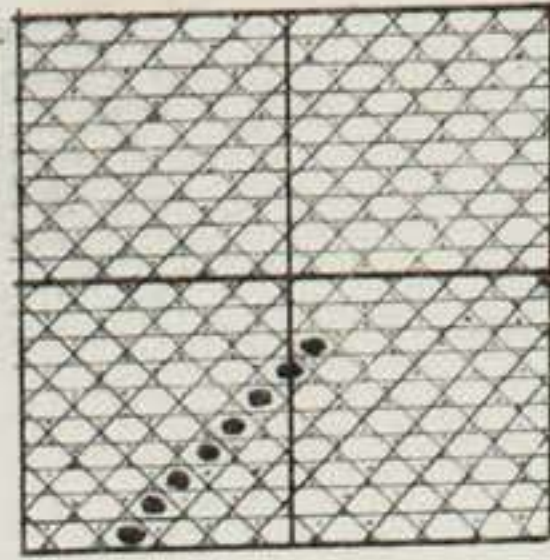


fig. 3<sup>a</sup>

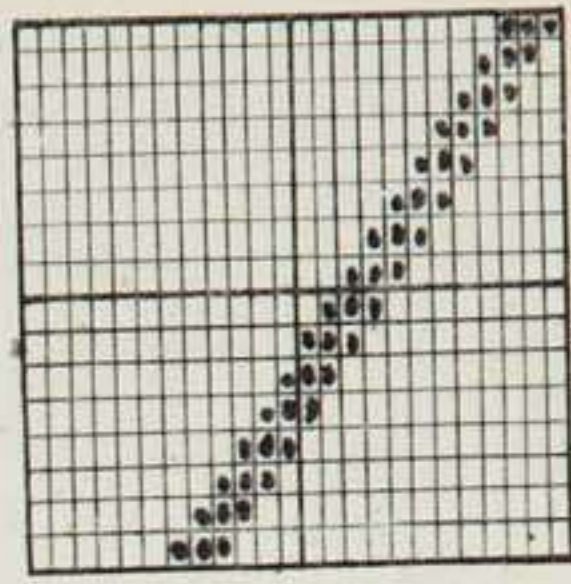


fig. 4<sup>a</sup>

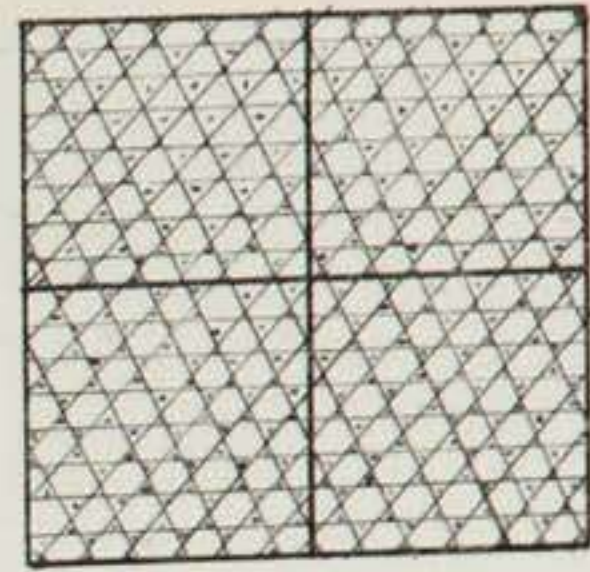


fig. 5<sup>a</sup>

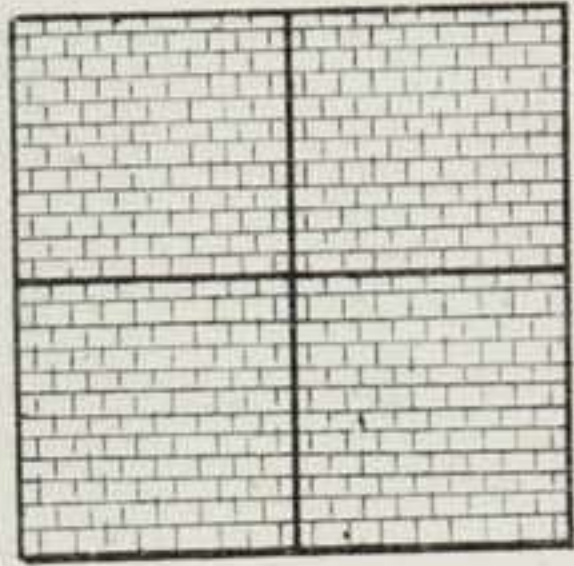


fig. 6<sup>a</sup>

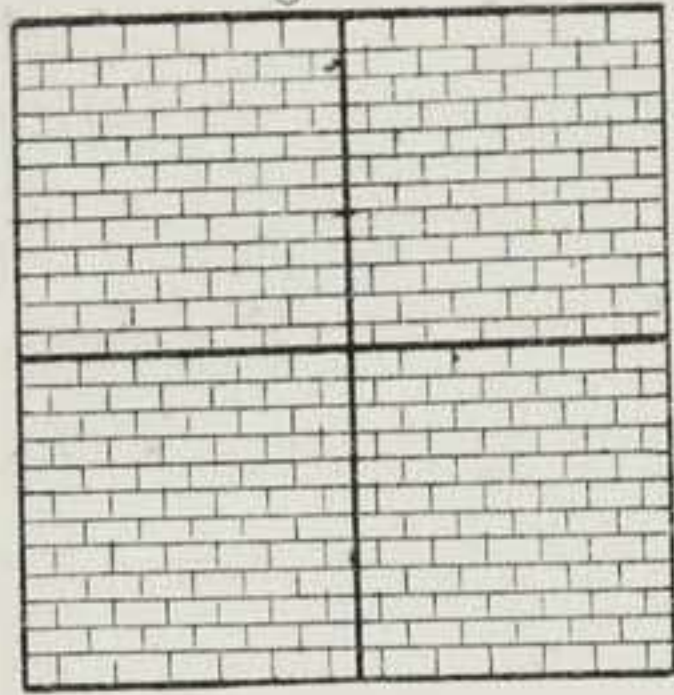


fig. 7<sup>a</sup>

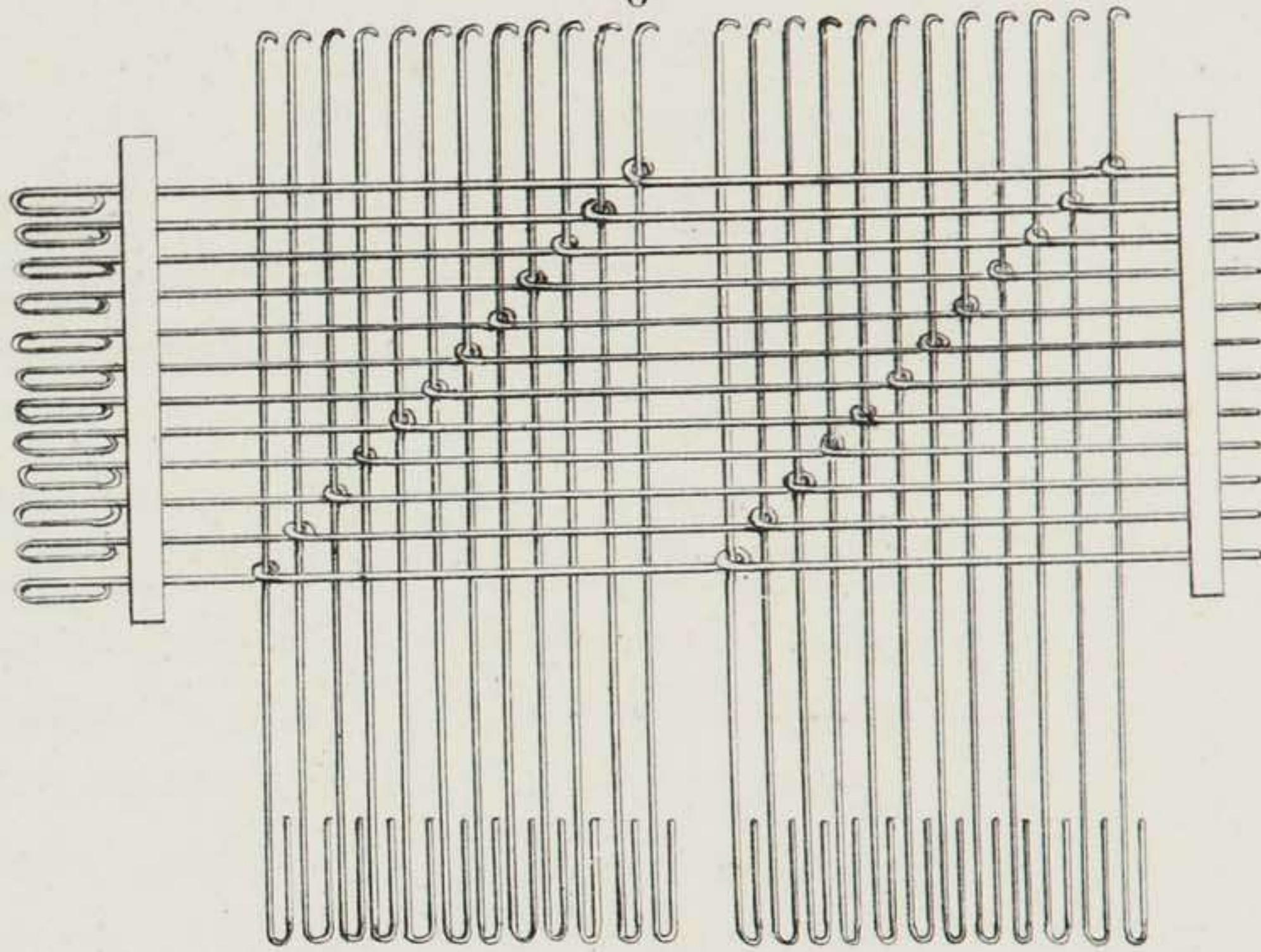


fig. 8<sup>a</sup>

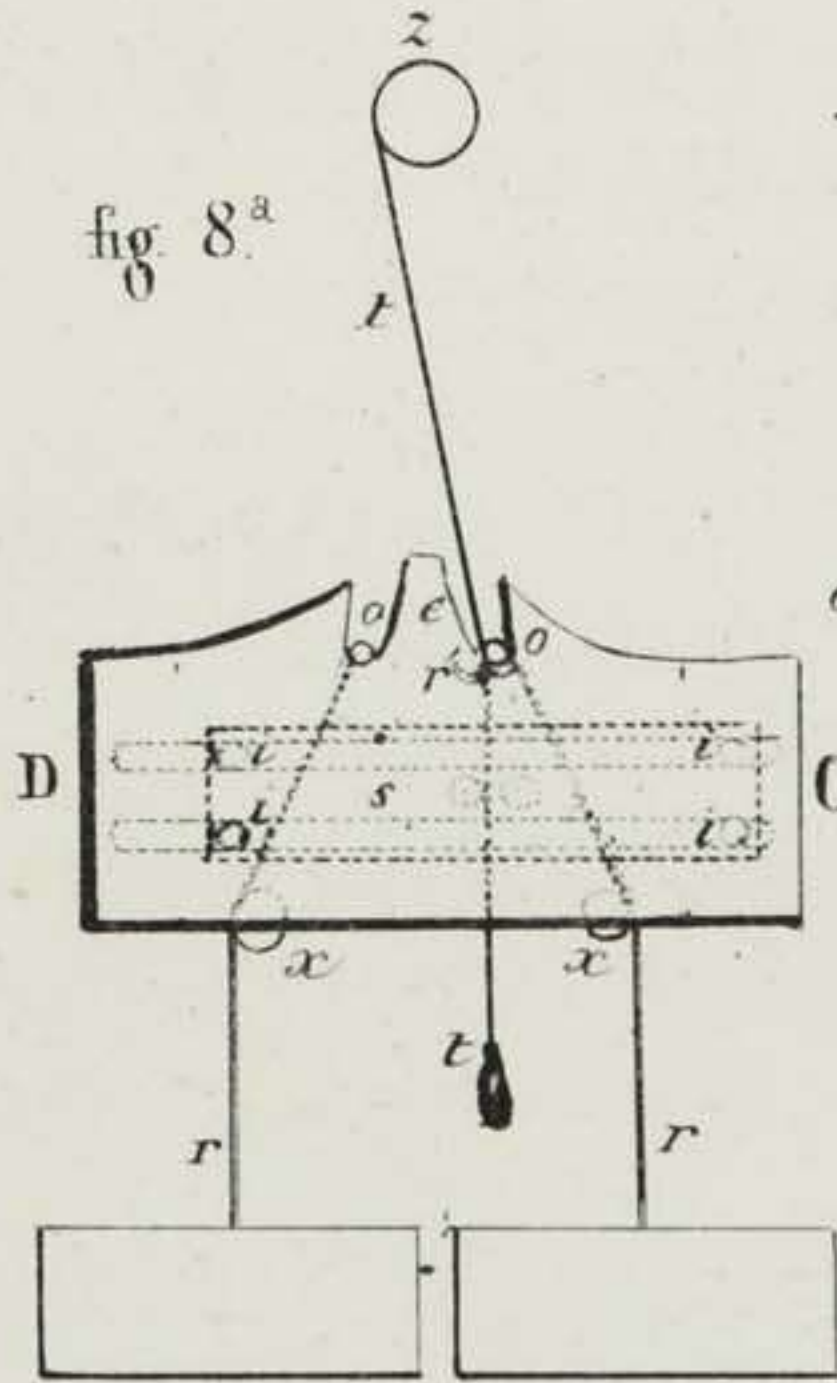


fig. 9<sup>a</sup>

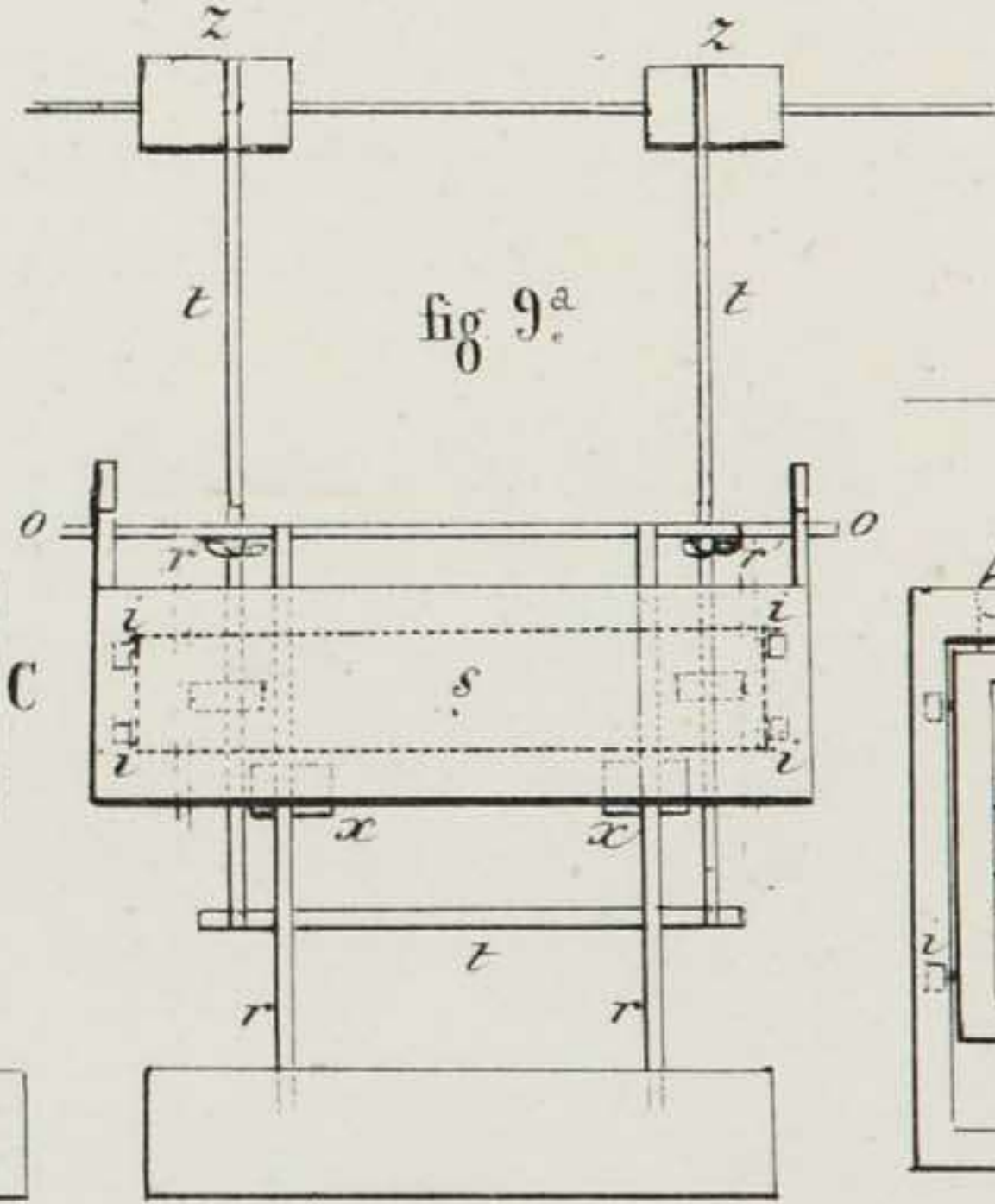
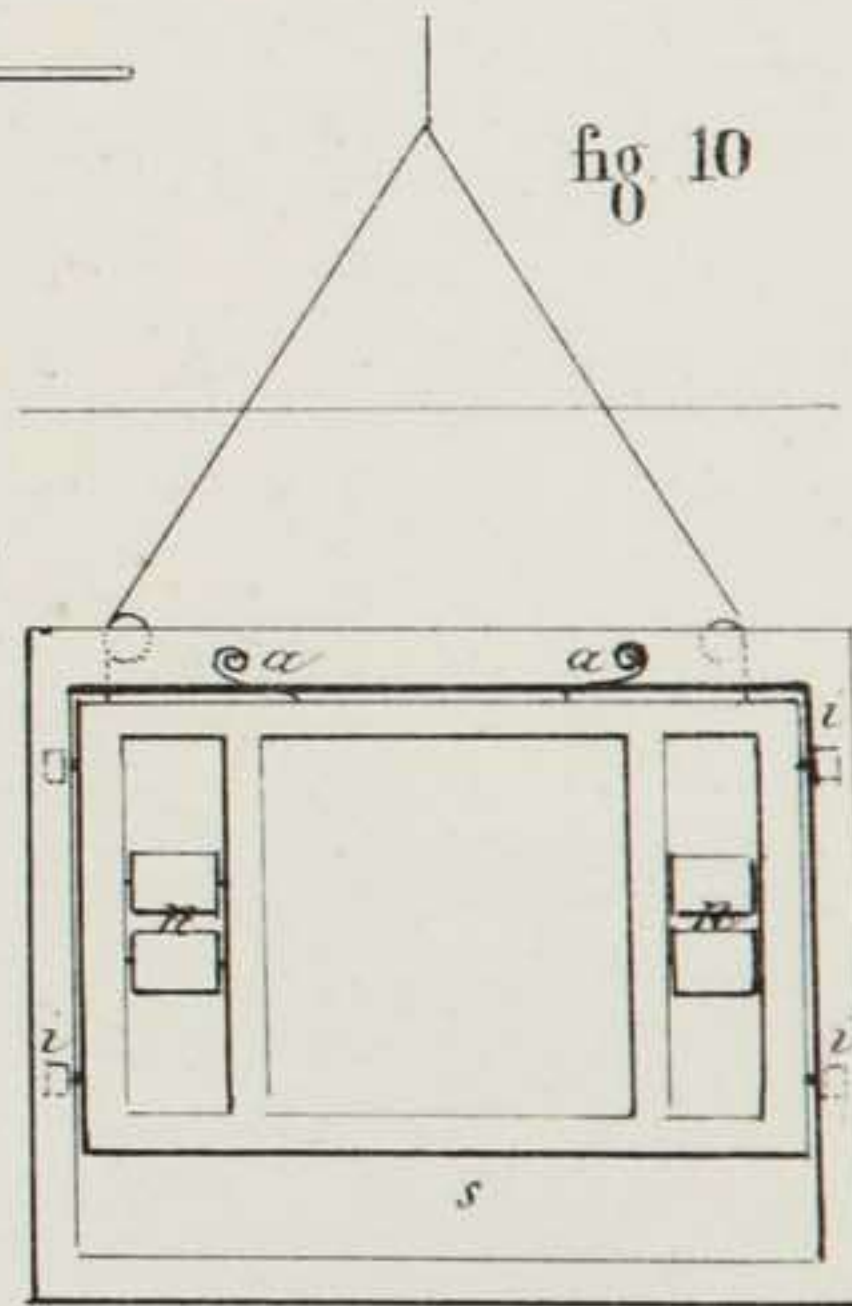


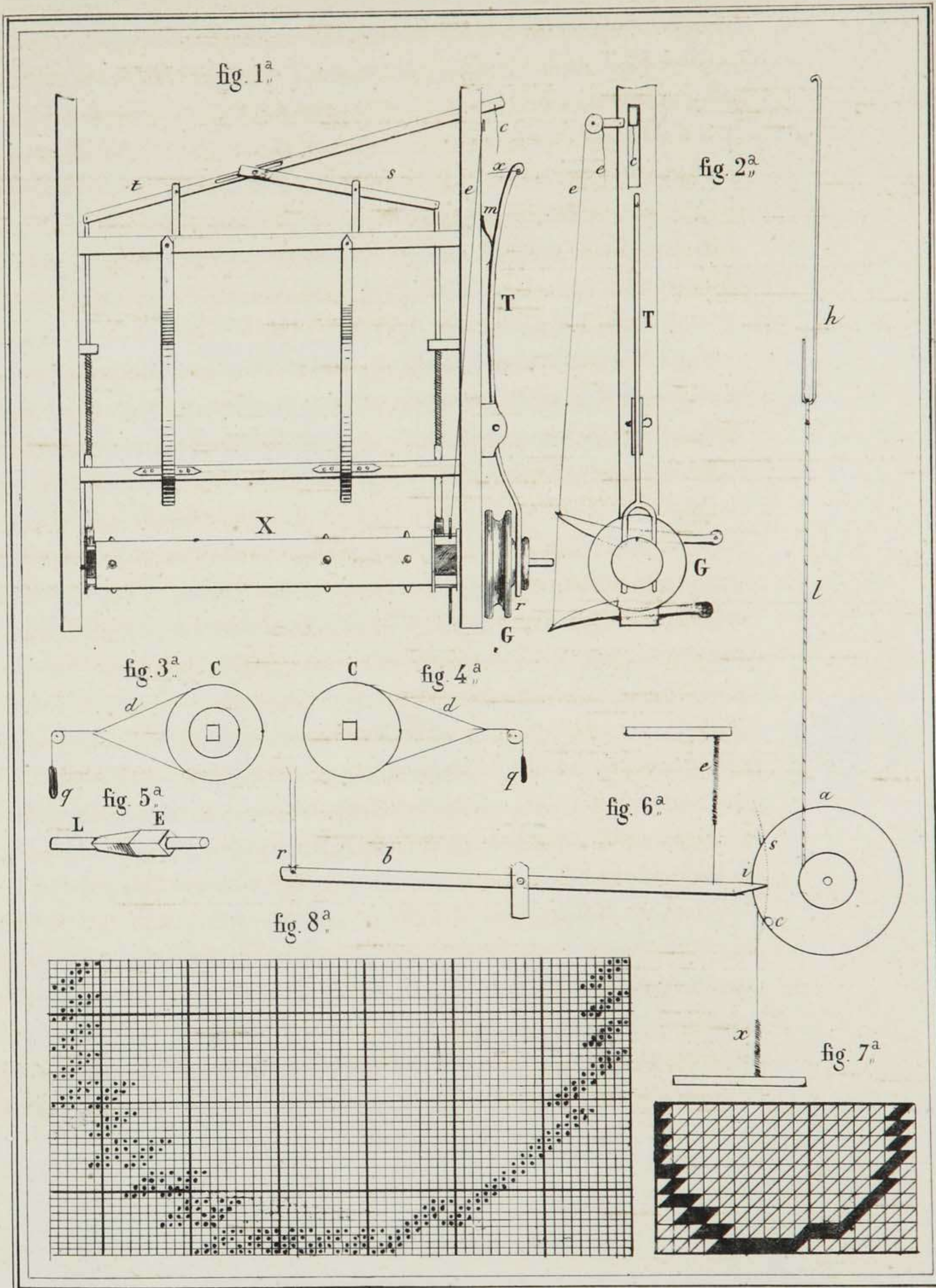
fig. 10





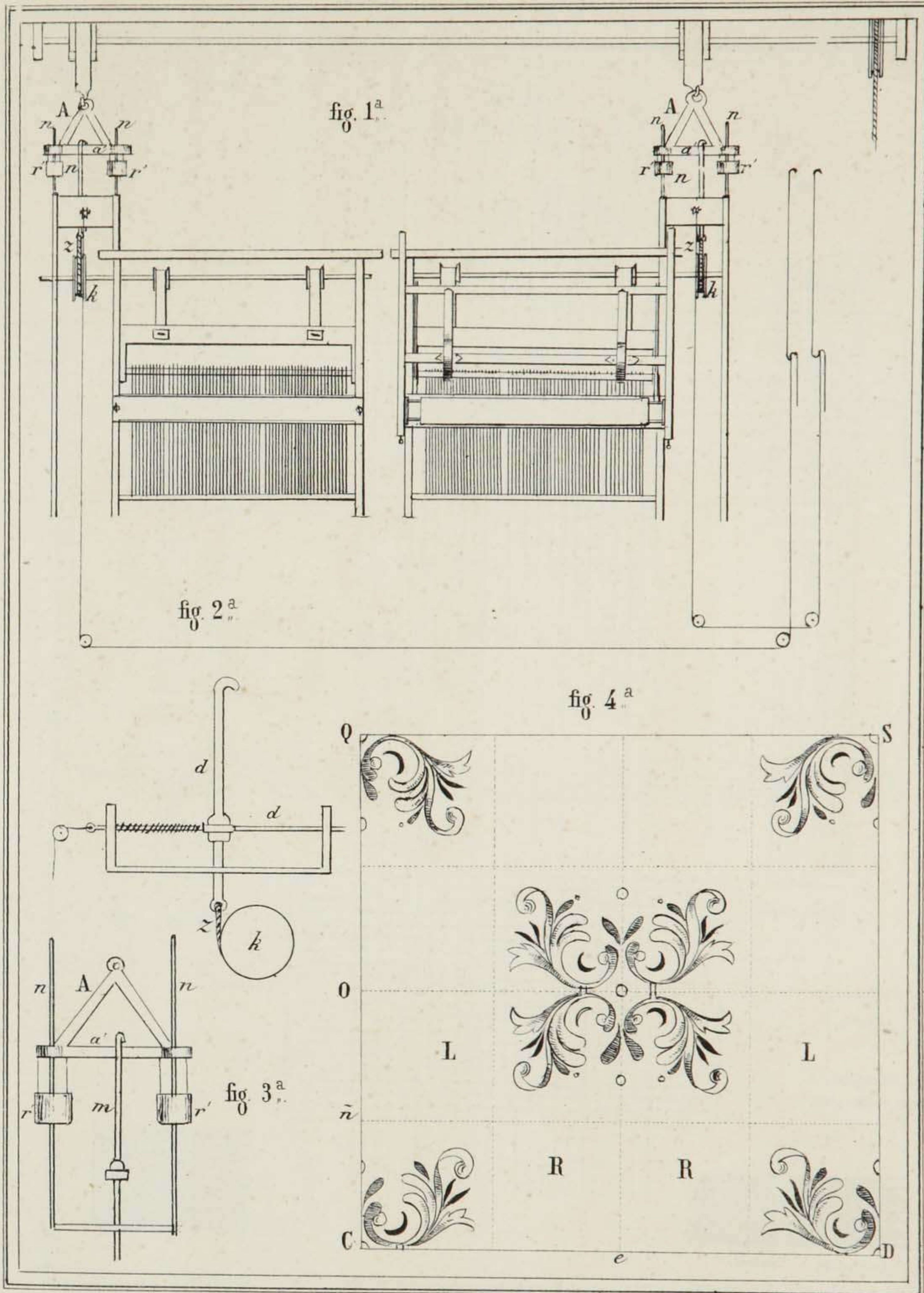
PAÑUELOS CACHEMIRA.  
RETROCESO DE LOS CARTONES.

Lám. XCIV.



# PAÑUELOS CACHEMIRA.

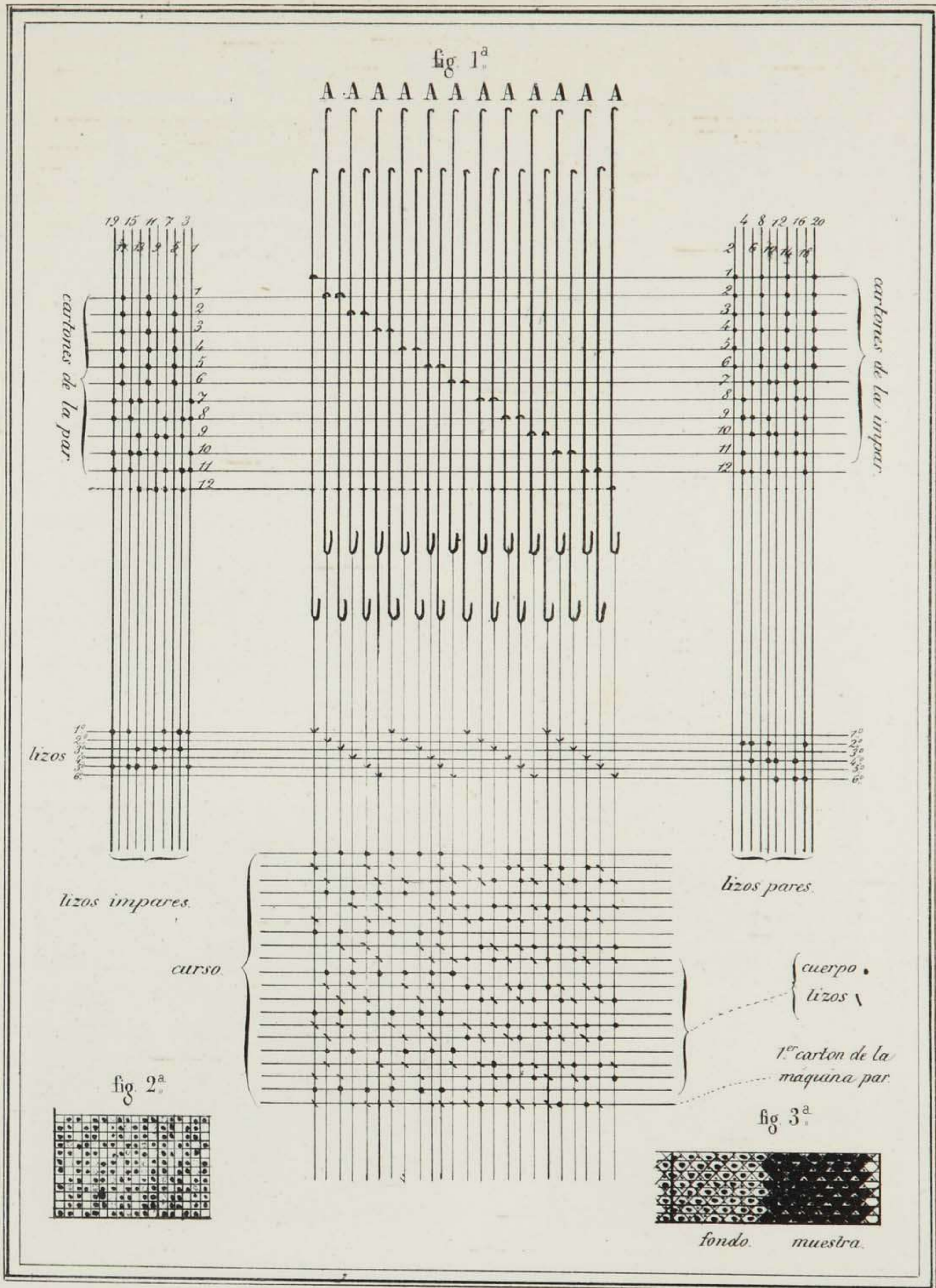
Lam. XCV.



Tom. 2°.

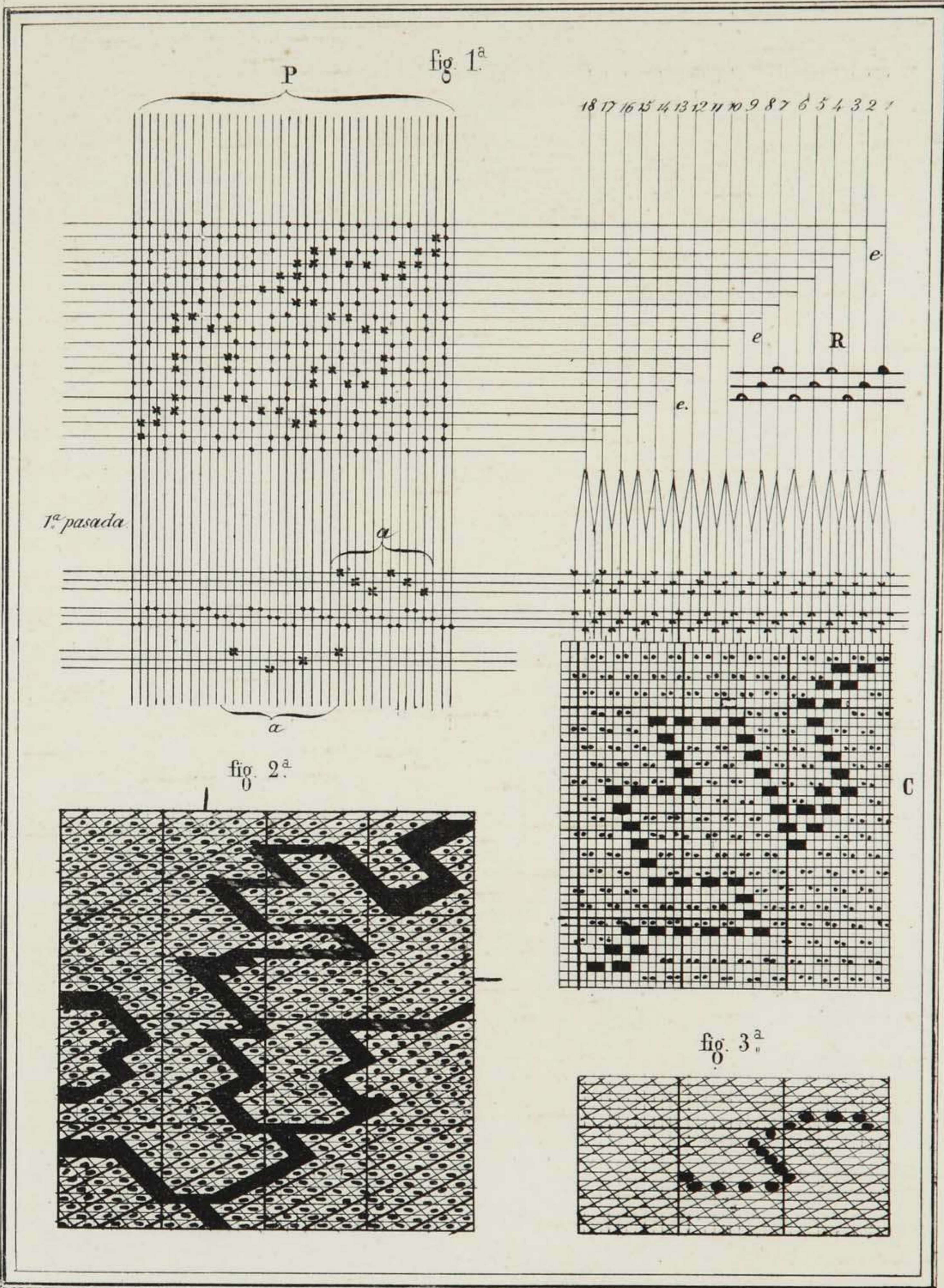
# PAÑUELOS CACHEMIRA.

Lám. XCVI.



# PAÑUELOS CACHEMIRA.

Lám. XCVII.



# PAÑUELOS CACHEMIRA.

Lám. XCVIII.

fig. 1<sup>a</sup>

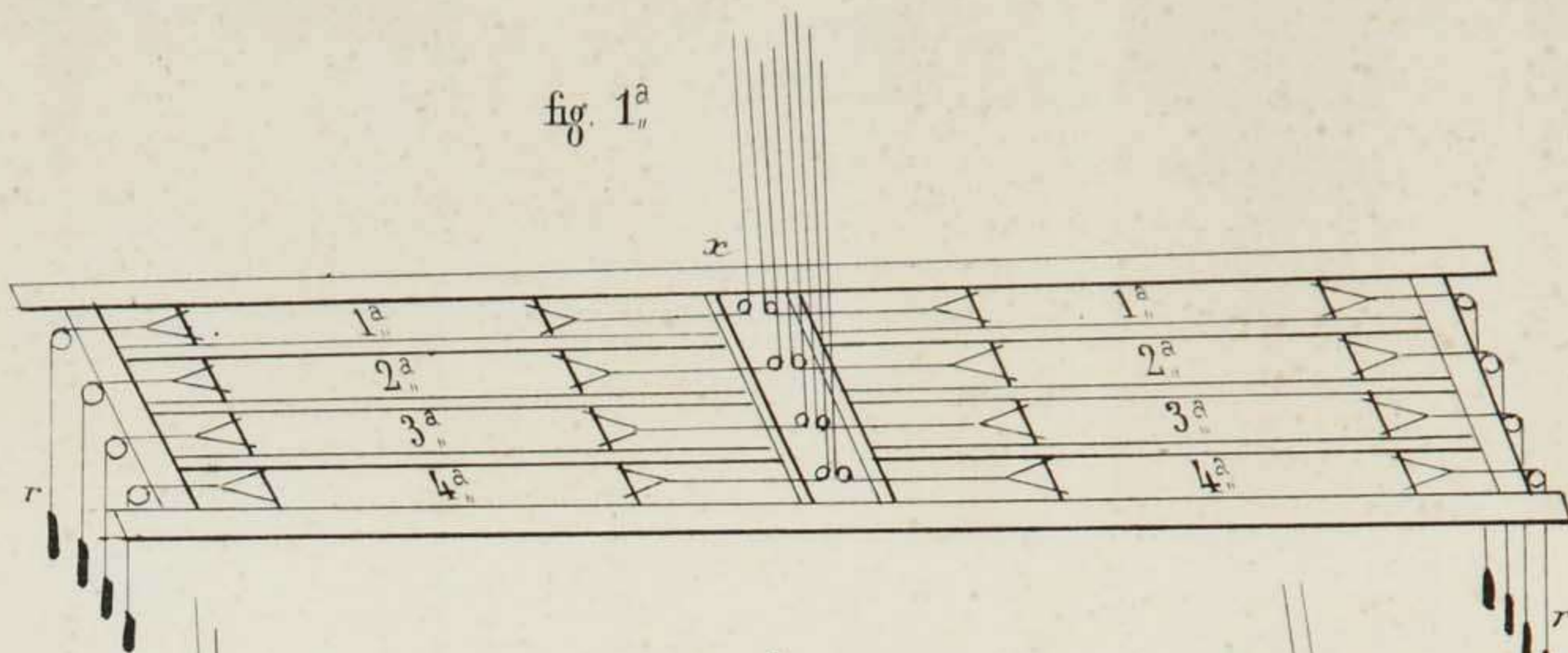


fig. 2<sup>a</sup>

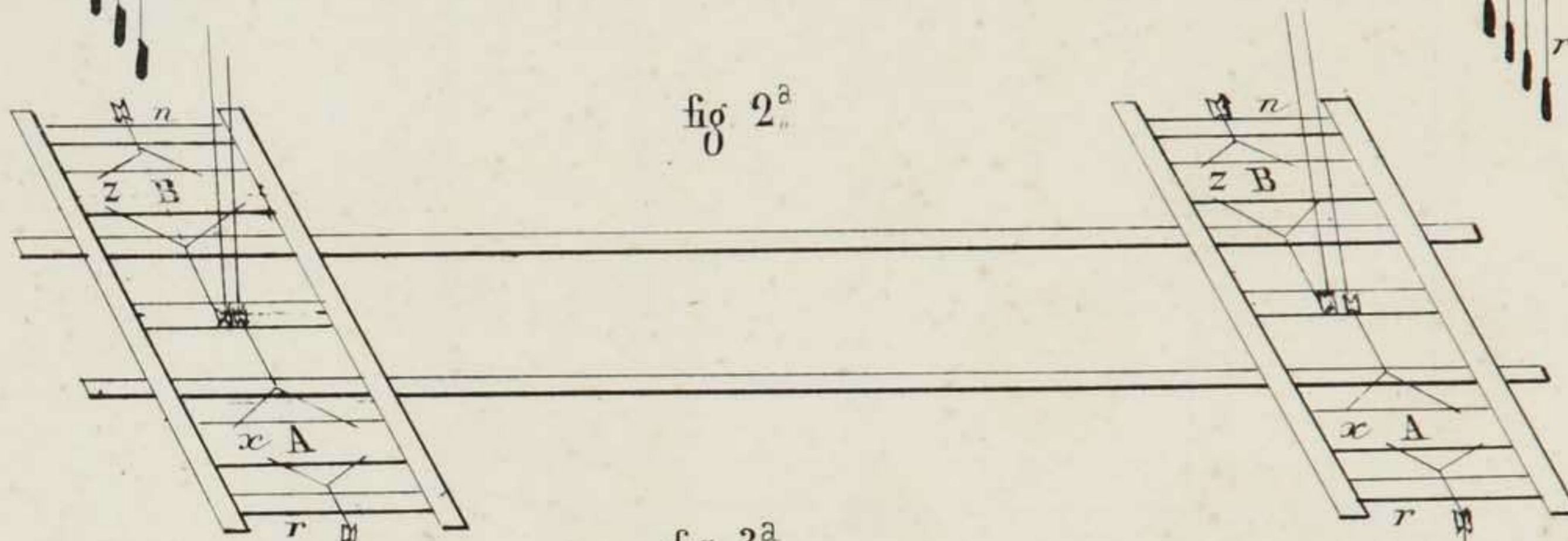
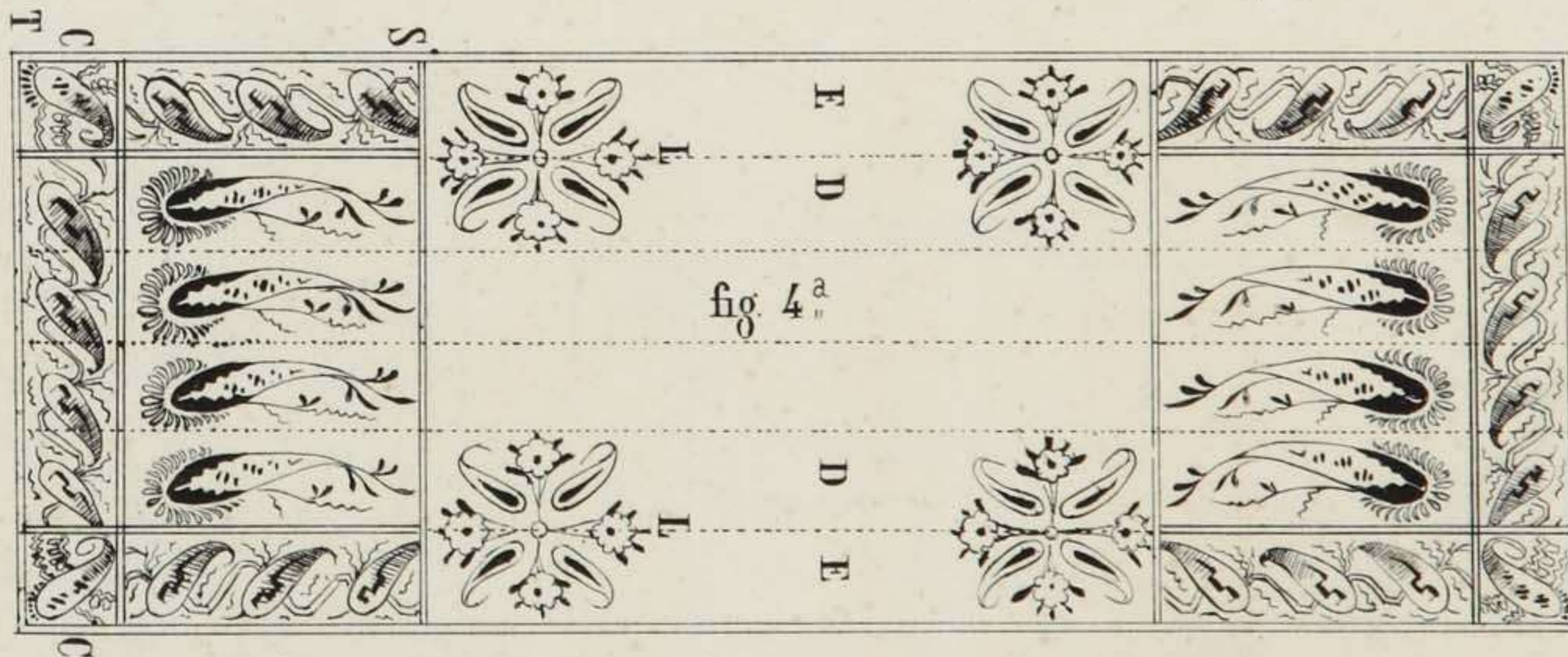
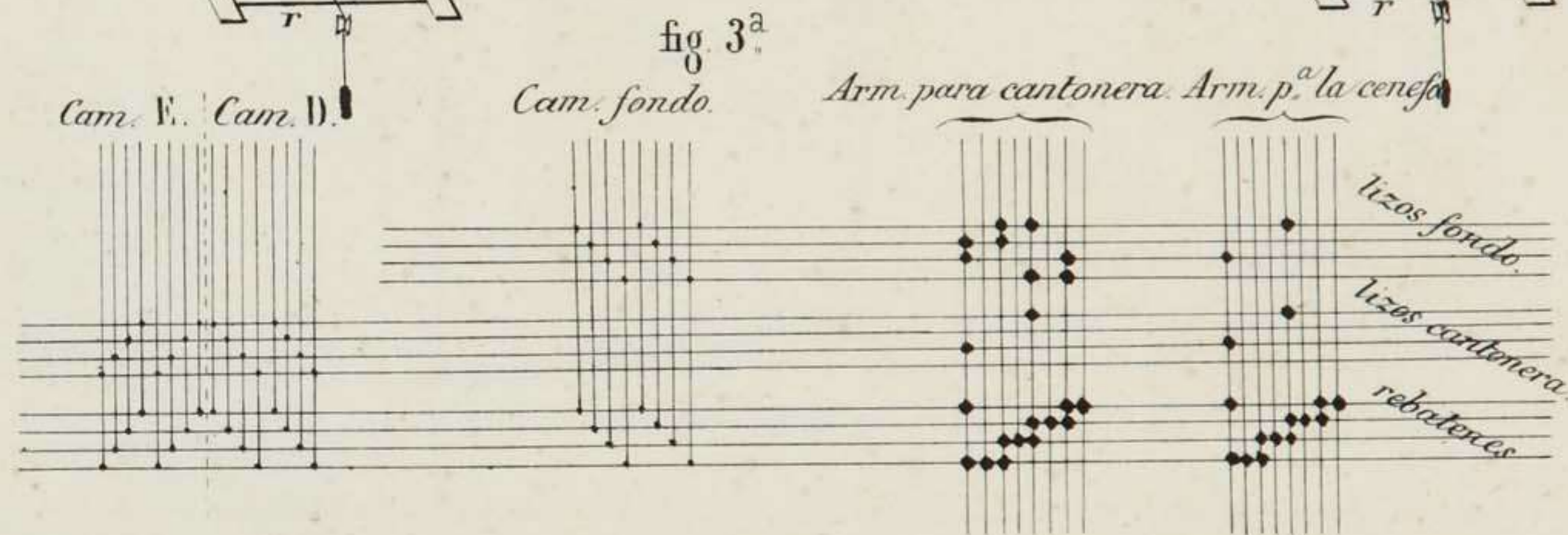
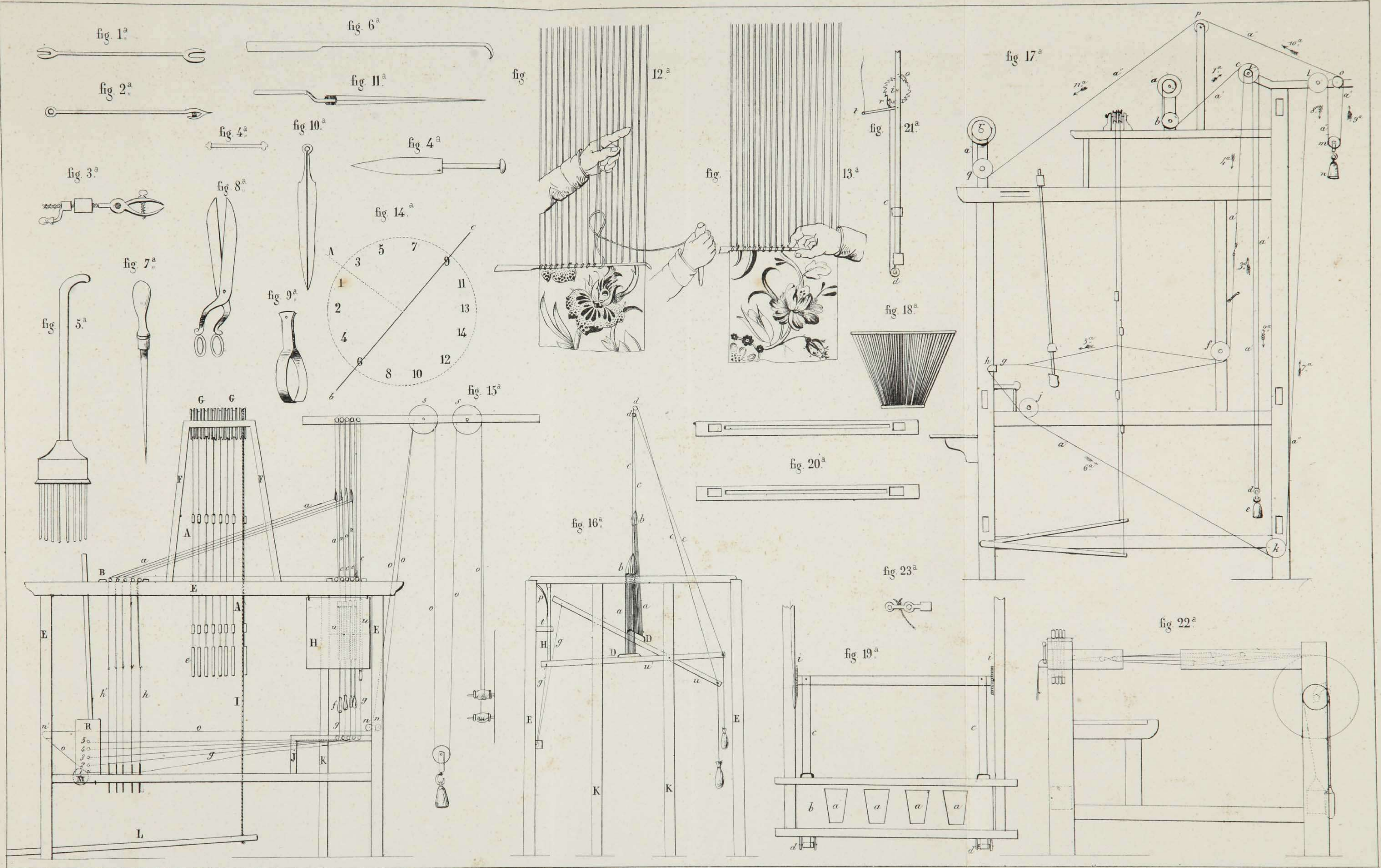
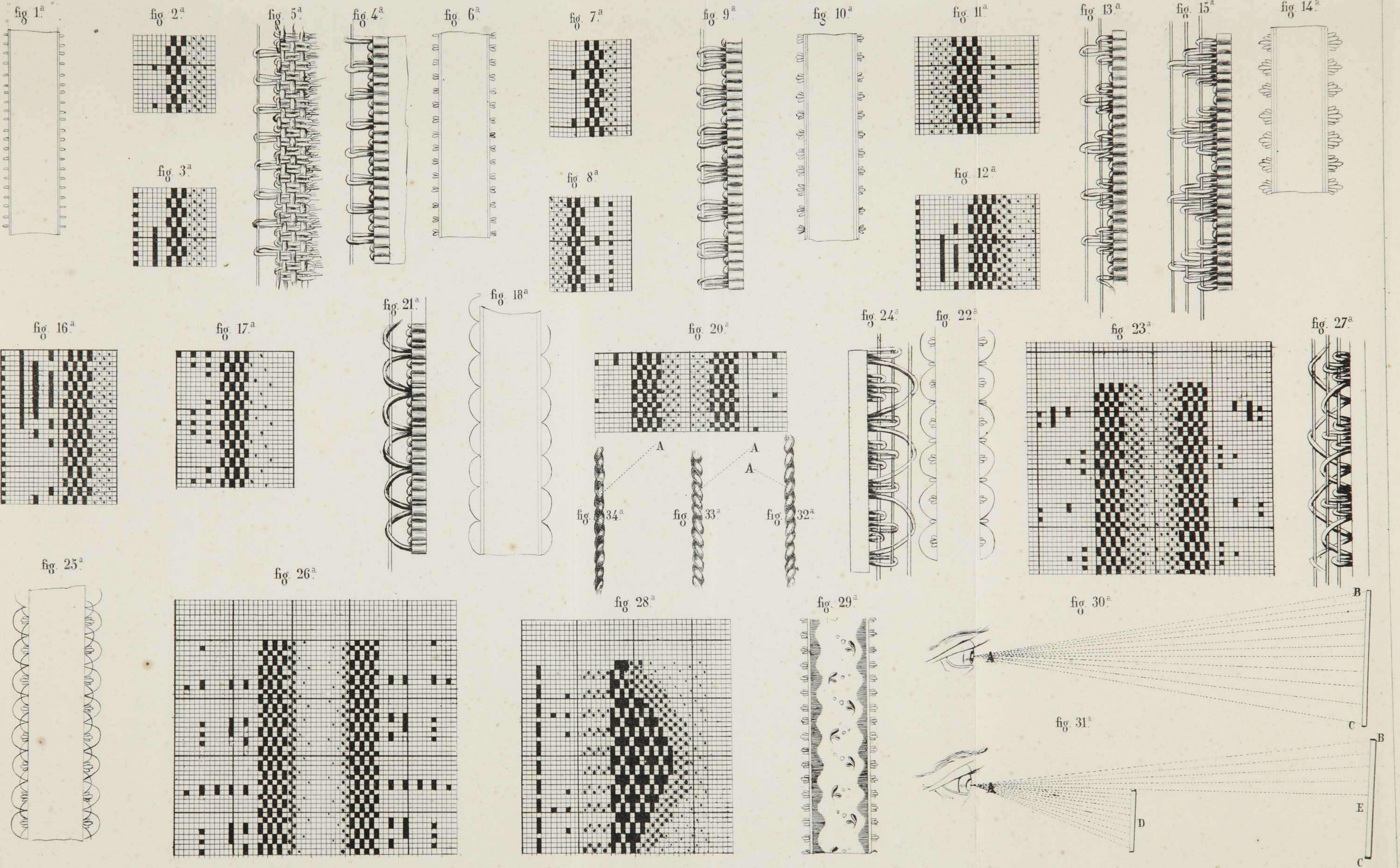
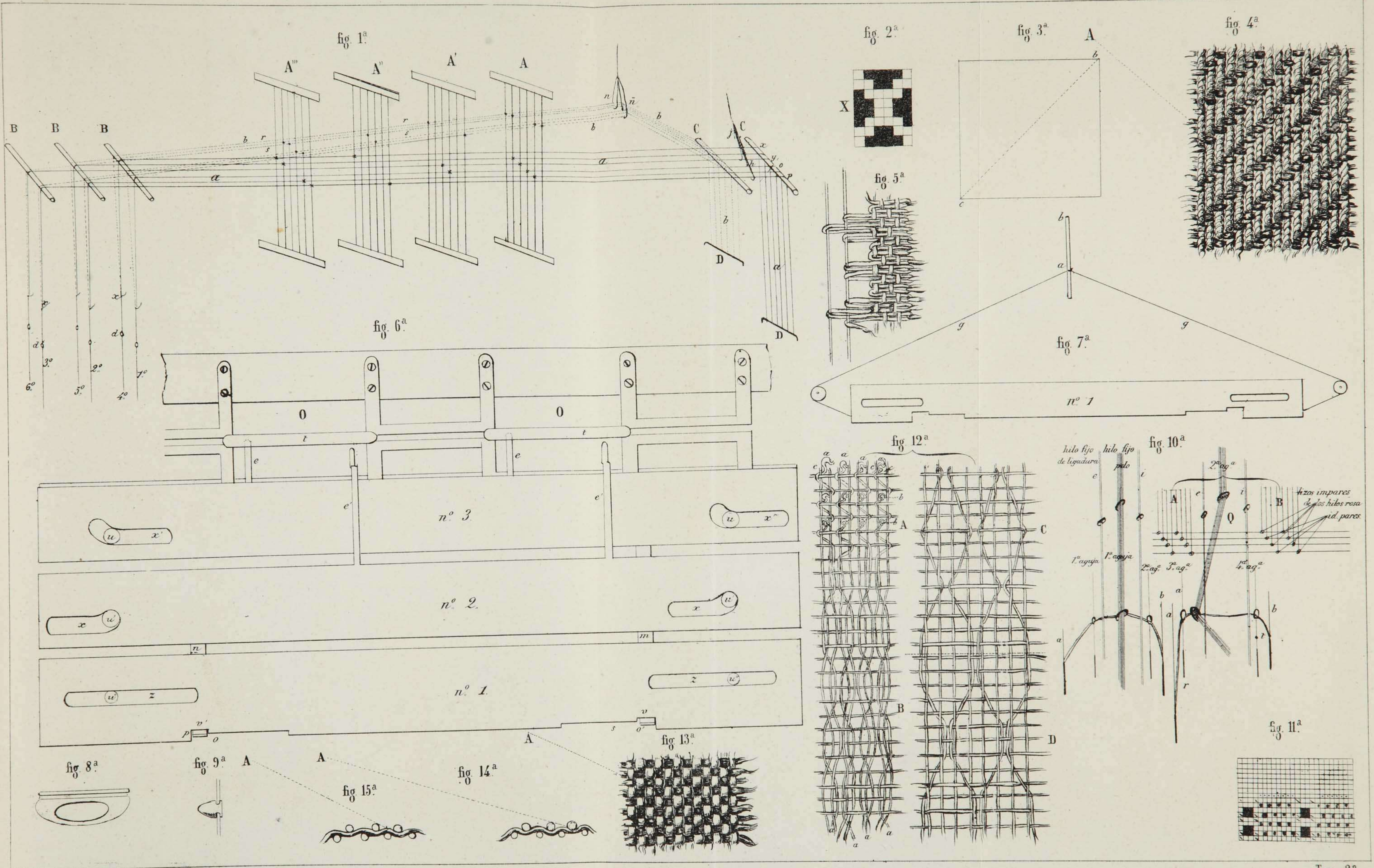


fig. 3<sup>a</sup>



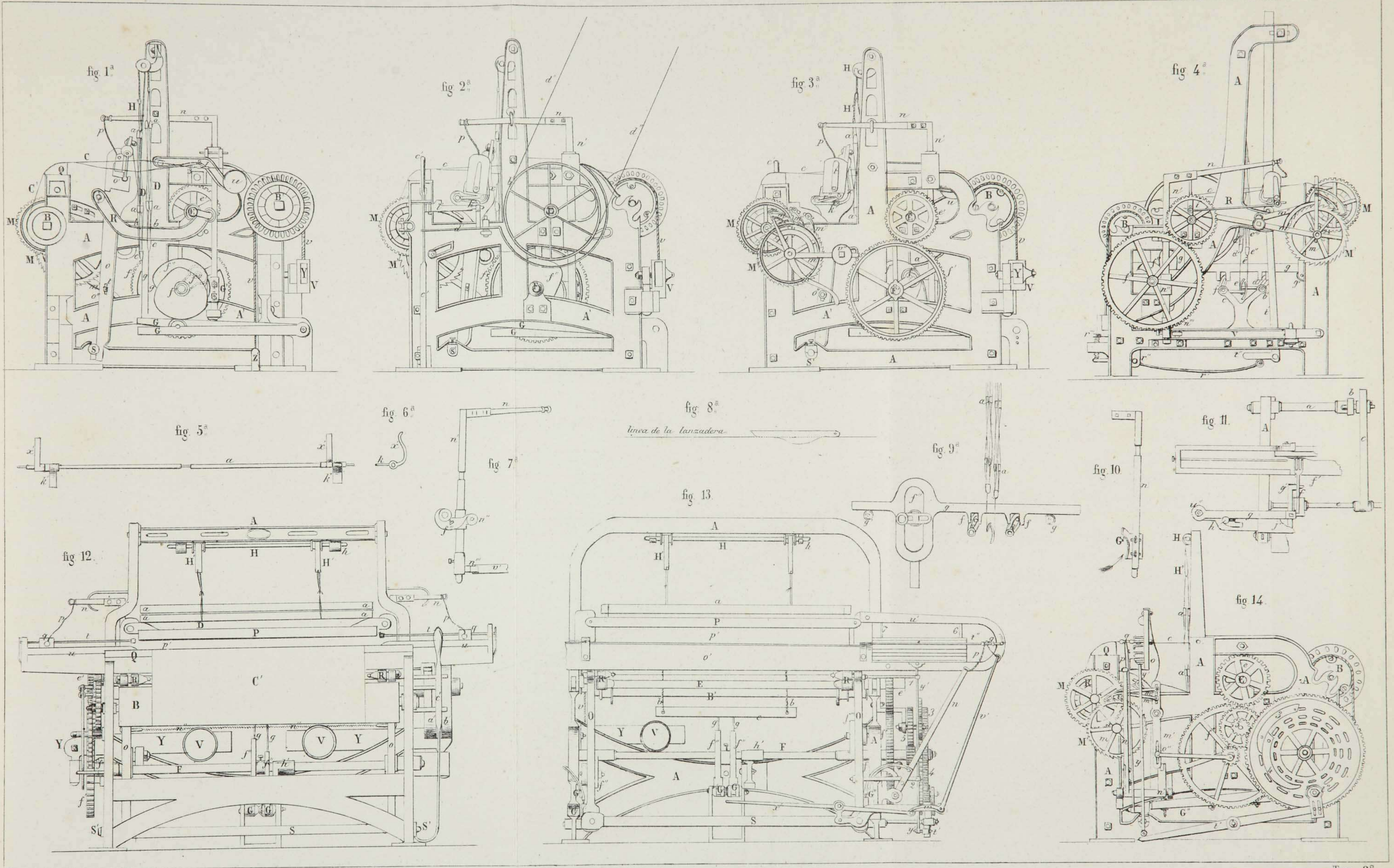


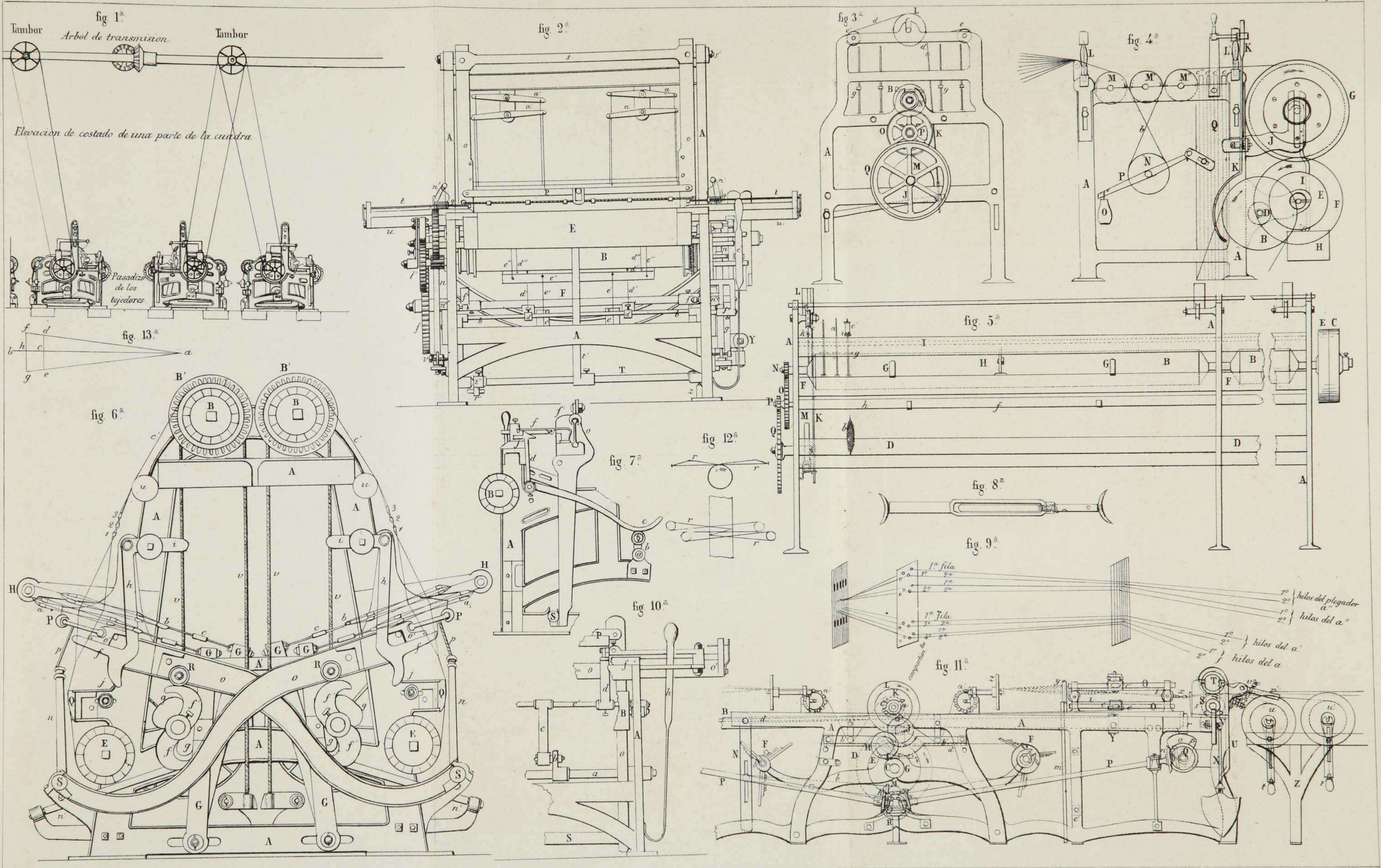












COMBINACIONES DE COLORES

1934

BIBLIOTECA  
CENTRE DE DOCUMENTATION  
UNIVERSITE

