

Donatus Sr. Alegre



ATLAS
DE
HILADURA Y TISAJE

HILADURA Y TISAJE



TRATADO TEÓRICO PRÁCTICO

DE HILADOS, PREPARACION Y TISAJE MANUAL Ó MECÁNICO ARTÍSTICO EN LANA, SEDA,
CÁÑAMO, LINO, YUTE, RAMIO, ETC.;

PERO ESPECIALMENTE EN ALGODON

REDACTADO

SEGUN LOS AUTORES MAS EMINENTES DE FRANCIA, ALEMANIA, INGLATERRA, ESPAÑA, ETC.

BAJO LA DIRECCION DE

D. JOAQUIN RIBERA

(INGENIERO MECÁNICO)

Obra ilustrada con unas 250 láminas en fólío que representan máquinas, aparatos.
ligamientos de tejidos, modelos, etc., etc.

ATLAS

BARCELONA

ESTABLECIMIENTO TIPOGRÁFICO DE F. NACENTE, EDITOR

PASEO DE GRACIA, NÚM. 149

1887

Esta obra es propiedad del Editor, quien se reserva todos los derechos de propiedad literaria y artística de la misma, y perseguirá al amparo de las leyes á todo aquel que la reimprima ó que reproduzca sus láminas fraudulentamente.

Imprenta y Litografía de F. Nacente.—Paseo de Gracia, 149.

COLOCACION DE LAS LÁMINAS

HILADURA Y PREPARACION

Lám. 1. ^a	figs. 1. ^a á 5. ^a	Lám. 18	figs. 110 y 111
» 2. ^a	» 6. ^a á 9. ^a	» 19	» 104 á 106
» 3. ^a	» 10 á 13	» 20	» 107 á 109
» 4. ^a	» 14 á 17	» 21	» 101 á 103
» 5. ^a	» 18 á 17	» 22	» 112 y 113
» 6. ^a	» 28 á 32	» 23	» 114 á 117
» 7. ^a	» 33 á 37	» 24	» 118 á 120
» 8. ^a	» 38 á 50	» 25	» 121 á 125
» 9. ^a	» 51 á 63	» 26	» 126 y 127
» 10	» 64 á 69	» 27	» 128 á 130
» 11	» 70 á 76	» 28	» 131 á 135
» 12	» 77 á 81	» 29	» 136 y 137
» 13	» 82 á 88	» 30	» 138 á 141
» 14	» 89 á 93	» 31	» 142 á 145
» 15	» 94 á 96	» 32	» 146 á 150
» 16	» 97 y 98	» 33	» 151 á 154
» 17	» 99 y 100	» 34	» 155 á 158

COLOCACION DE LAS LÁMINAS

Lám. 35	figs. 159 á 161	Lám. 89 A,	figs. 299 á 302 y 306 á 309
» 36	» 162 á 166	» 90 A,	» 307 y 310 á 313
» 37	» 167 á 170	» 91 A,	» 314 á 318
» 38	» 171 á 173	» 92 A,	» 319 á 321, 323 y 328
» 39	» 174 á 177	» 93 A,	» 322, 324 á 326, 329 y 331
» 40	» 178 á 182	» 94 A,	» 327 y 330
» 41	» 183 á 189	» 49	» 214 á 217
» 42	» 190	» 50	» 218 á 221
» 43	» 191	» 51	» 222 á 226
» 44	» 192 á 199	» 52	» 227 á 238
» 45	» 200 á 203	» 53	» 239 á 244
» 46	» 204 á 206	» 54	» 245 á 249
» 47	» 207 á 210	» 55	» 250 á 255
» 48	» 211 á 213	» 56	» 256 á 270
» 69 A,	» 214 á 222	» 57	» 290 y 291
» 70 A,	» 223 á 229	» 58	» 292 á 294
» 71 A,	» 230 á 242	» 59	» 295 y 296
» 72 A,	» 243 y 244, 246 á 252	» 60	» 297 y 298
» 73 A,	» 253 á 258	» 61	» 271 á 289
» 74 A,	» 259 á 264	» 62	» 299 á 303
» 75 A,	» 265 á 268	» 63	» 304 á 310
» 76 A,	» 269 á 272	» 64	» 311 y 312
» 77 A,	» 273	» 65	» 313 á 316
» 78 A,	» 274 á 280	» 66	» 317 á 326
» 79 A,	» 281 y 282	» 67	» 327 á 332
» 80 A,	» 283, 285 á 287	» 68	» 333 á 342
» 85 A,	» 284 y 288	» 81	» 343 á 351
» 86 A,	» 289 á 293	» 82	» 352 á 356
» 87 A,	» 294 á 298	» 83	» 357 á 366
» 88 A,	» 303 á 305	» 84	» 367 á 379

Las figuras de las láminas señaladas con la letra A son repetidas, y deben ocupar el final de esta pauta para las láminas de HILADURA Y PREPARACION.

TEORIA DE TEJIDOS Y TISAJE

Lám. 1. ^a ,	figs. 1. ^a á 18	Lám. 12,	figs. 123 á 131
» 2. ^a ,	» 19 á 27	» 13,	» 132 á 138 y 140
» 3. ^a ,	» 28 á 35	» 14,	» 139 y 141 á 144
» 4. ^a ,	» 36 á 57	» 15,	» 145 á 151
» 5. ^a ,	» 58 á 74	» 16,	» 152 y 153
» 6. ^a ,	» 75 á 85	» 17,	» 154 á 156
» 7. ^a ,	» 86 á 94	» 18,	» 157 á 169
» 8. ^a ,	» 95 á 99	» 19,	» 170 á 176
» 9. ^a ,	» 100 á 103	» 20,	» 177 á 181 y 184 á 187
» 10,	» 104 á 117	» 21,	» 182 y 183, 188 á 193 y 195
» 11,	» 118 á 122	» 22,	» 194 y 196 á 198

Lám. 23, figs. 199 á 213
 » 24, » 214 á 228
 » 25, » 229 á 235, 237 y 238
 » 26, » 236, 239 á 245, 247 y 248
 » 27, » 246 y 249 á 257
 » 28, » 258 á 266
 » 29, » 267 á 288 y 291 á 294
 » 30, » 289 y 290 y 295 á 300
 » 31, » 301, 305 y 306 y 314 á 319
 » 32, » 302 á 304 y 307 á 313
 » 33, » 320 y 321
 » 34, » 323, 325 y 325 bis, 327 y 329 á 332
 » 35, » 322, 324, 326, 328 y 333 á 336
 » 36, » 337 á 345
 » 37, » 346 á 350
 » 38, » 351 á 361
 » 39, » 362 á 374
 » 40, » 375 á 382
 » 41, » 383 á 395
 » 42, » 396 á 401 y 404
 » 43, » 402 y 403 y 405 á 412
 » 44, » 413 á 421
 » 45, » 422 á 430
 » 46, » 431 á 437
 » 47, » 438 á 451 y 453
 » 48, » 452, 454 á 460, 468 á 471 y 477
 » 49, » 461 á 466
 » 50, » 467, 472 á 476 y 479
 » 51, » 478, 480 á 490
 » 52, » 491 á 500
 » 53, » 501 á 512
 » 54, » 513 á 518
 » 55, » 519 á 523
 » 56, » 524 á 529
 » 57, » 530 á 537
 » 58, » 538 á 549
 » 59, » 550 á 561, 563 y 564
 » 60, » 562
 » 61, » 565 á 570, 572 y 573
 » 62, » 571, 574 á 582
 » 63, » 583 á 596
 » 64, » 597 á 616
 » 65, » 617 á 627 y 629
 » 66, » 628, 630 á 641
 » 67, » 642 á 650
 » 68, » 651 á 658, 662 á 664
 » 69, » 659 á 661, 665 á 666
 » 70, » 667 á 678
 » 71, » 679 á 683 y 685
 » 72, » 684, 686 á 694

Lám. 73, figs. 695 á 708 y 711
 » 74, » 709 y 710, 712 á 723
 » 75, » 724 á 729
 » 76, » 730 á 736
 » 77, » 737 á 747 y 749
 » 78, » 748, 750 á 754
 » 79, » 755 á 758
 » 80, » 759 á 767
 » 81, » 768 á 780
 » 82, » 781 á 784, 787 y 792
 » 83, » 793 y 794
 » 84, » 785 y 786, 789 á 791, 795 y 796
 » 85, » 797, 811 á 814
 » 86, » 798, 834 á 840
 » 87, » 788, 799 y 800, 841 á 848
 » 88, » 801, 849 á 855
 » 89, » 802 y 803, 856 á 860
 » 90, » 804, 862 á 867
 » 91, » 805, 861, 868 á 873
 » 92, » 806, 874 á 879
 » 93, » 807 á 809, 880 á 885
 » 94, » 810, 815 y 824
 » 95, » 816 á 822, 886 á 891
 » 96, » 823, 825 á 828 y 892
 » 97, » 829, 894, 896, y 897
 » 98, » 830 y 831
 » 99, » 832, 895, 898 (dice 888)
 » 100, » 833, 899, 901, 904 á 907
 » 101, » 893
 » 102, » 900, 902 y 903, 908 á 915 (dice 916)
 » 103, » 916 á 919 y 923
 » 104, » 920 á 922, 924 á 926 y 929
 » 105, » 927 y 928, 930 á 933
 » 106, » 934, 937 y 938
 » 107, » 935, 954 á 960
 » 108, » 936, 961 á 964
 » 109, » 939, 965 á 969
 » 110, » 940 y 941 y 978 á 981
 » 111, » 942 á 951
 » 112, » 952 y 953, 970 á 981
 » 113, » 982 á 988
 » 114, » 989 á 997, 999 á 1002
 » 115, » 998 y 998 bis, 1003 á 1006
 » 116, » 1007 á 1011
 » 117, » 1012 á 1018, 1020 y 1021
 » 118, » 1019, 1022 á 1027
 » 119, » 1028, 1030 á 1034
 » 120, » 1029, 1039 á 1045
 » 121, » 1035 á 1038, 1046 á 1050
 » 122, » 1051 á 1053, 1055 á 1058

» 123, » 1054, 1059 á 1069	» 131, » 1105 á 1111
» 124, » 1074 á 1083 y 1090	» 132, » 1118 á 1122
» 125, » 1084 á 1089	» 133, » 1123 á 1129
» 126, » 1070 á 1073	» 134, » 1130
» 127, » 1091 á 1093 y 1095	» 135, » 1131 á 1135
» 128, » 1094, 1096 á 1098 (es 1097) y 1100	» 136, » 1136 á 1140
» 129, » 1099, 1112 á 1104	» 137, » 1141 y 1142, 1147 y 1098
» 130, » 1112 á 1115 y 1117 (la 1111 es 1116)	» 138, » 1143 á 4611

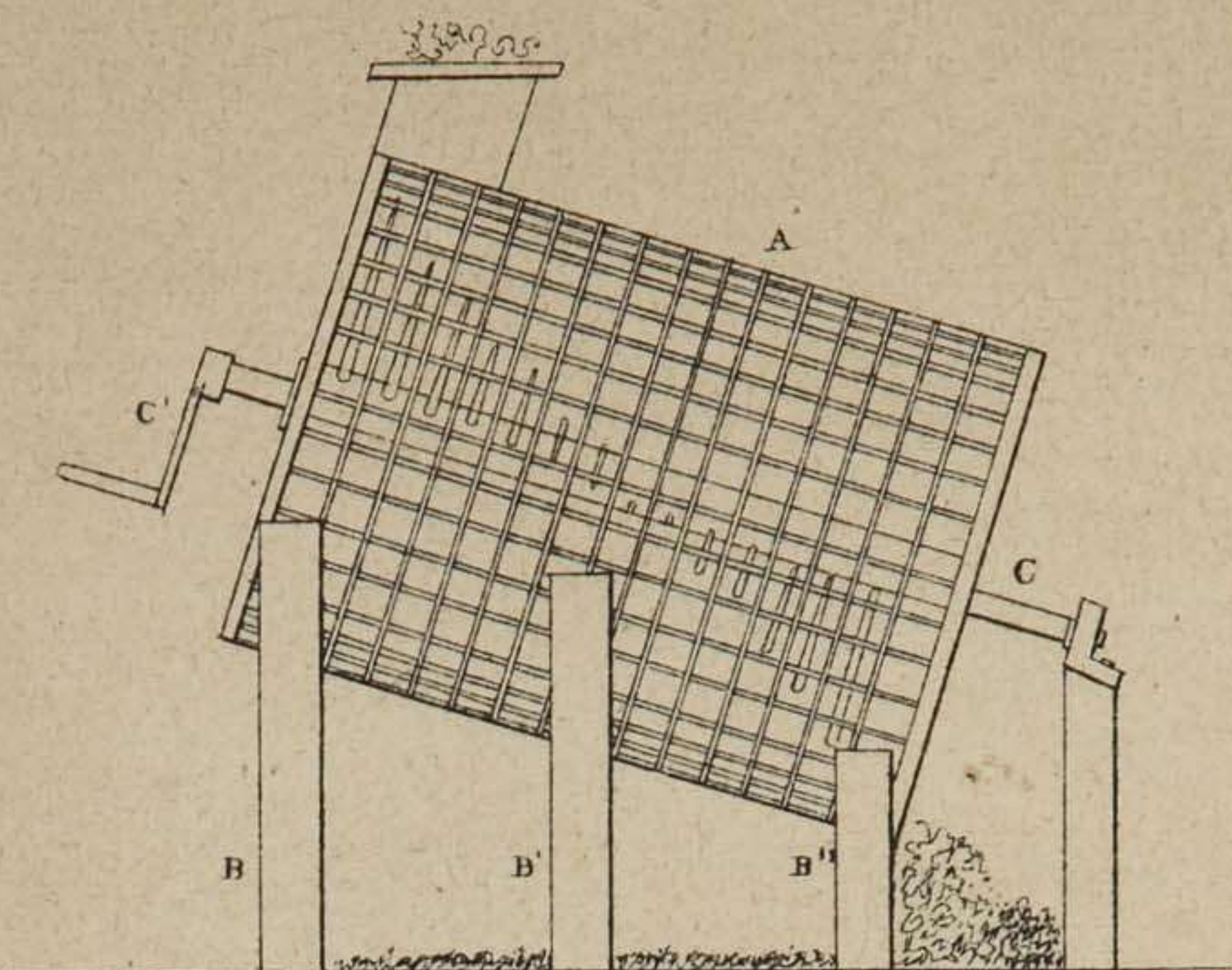


Fig. 1.

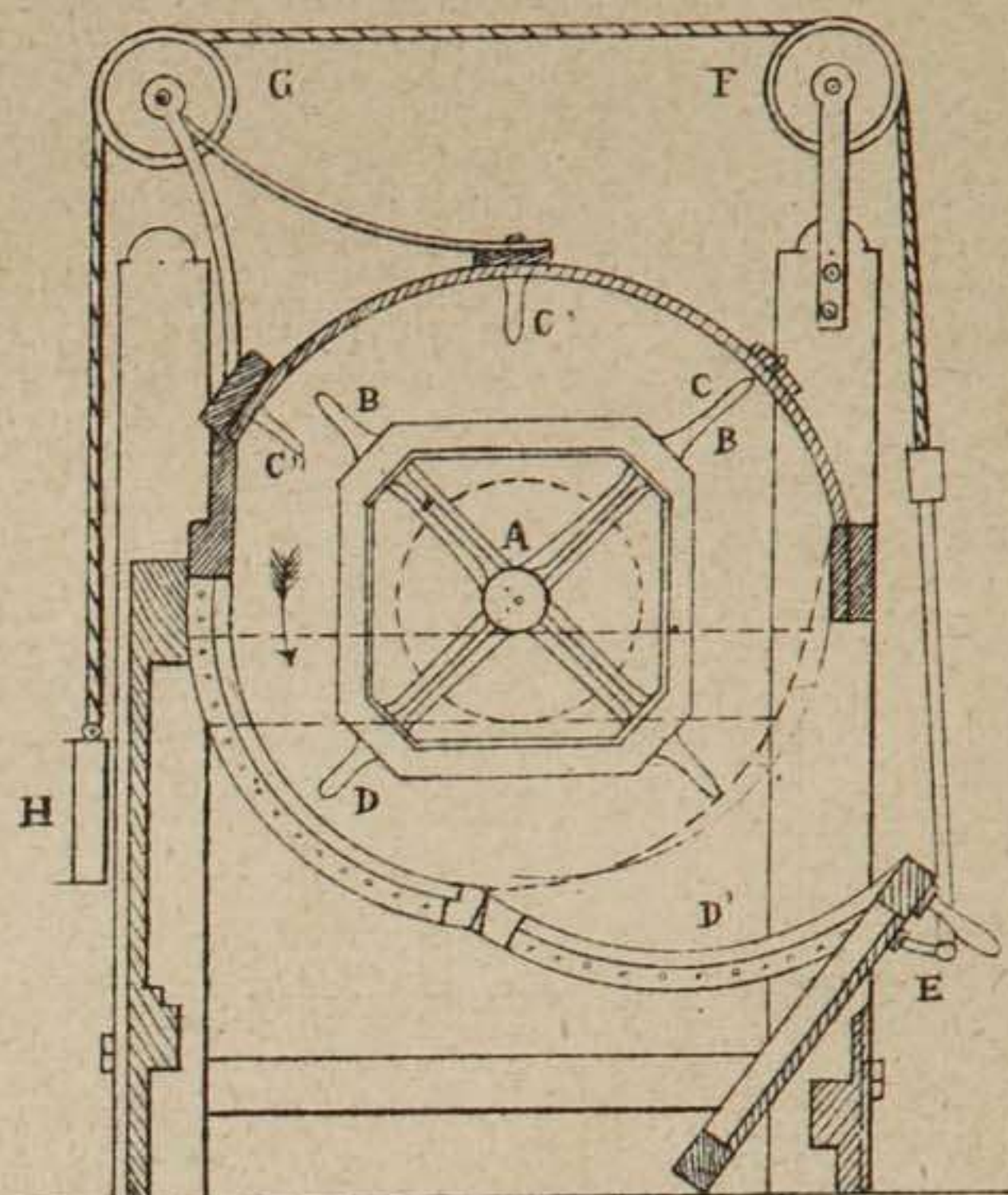


Fig. 2.

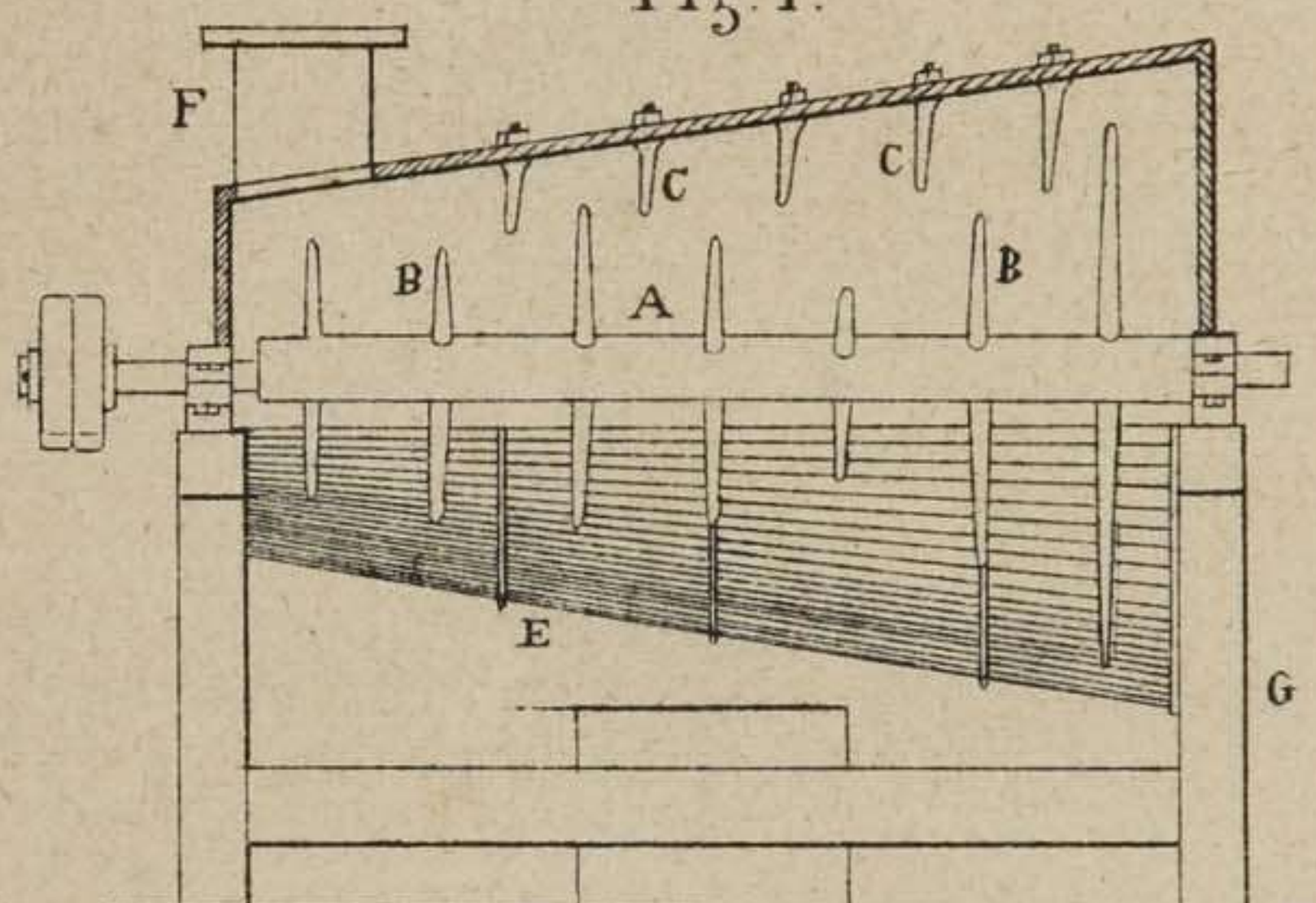


Fig. 3.

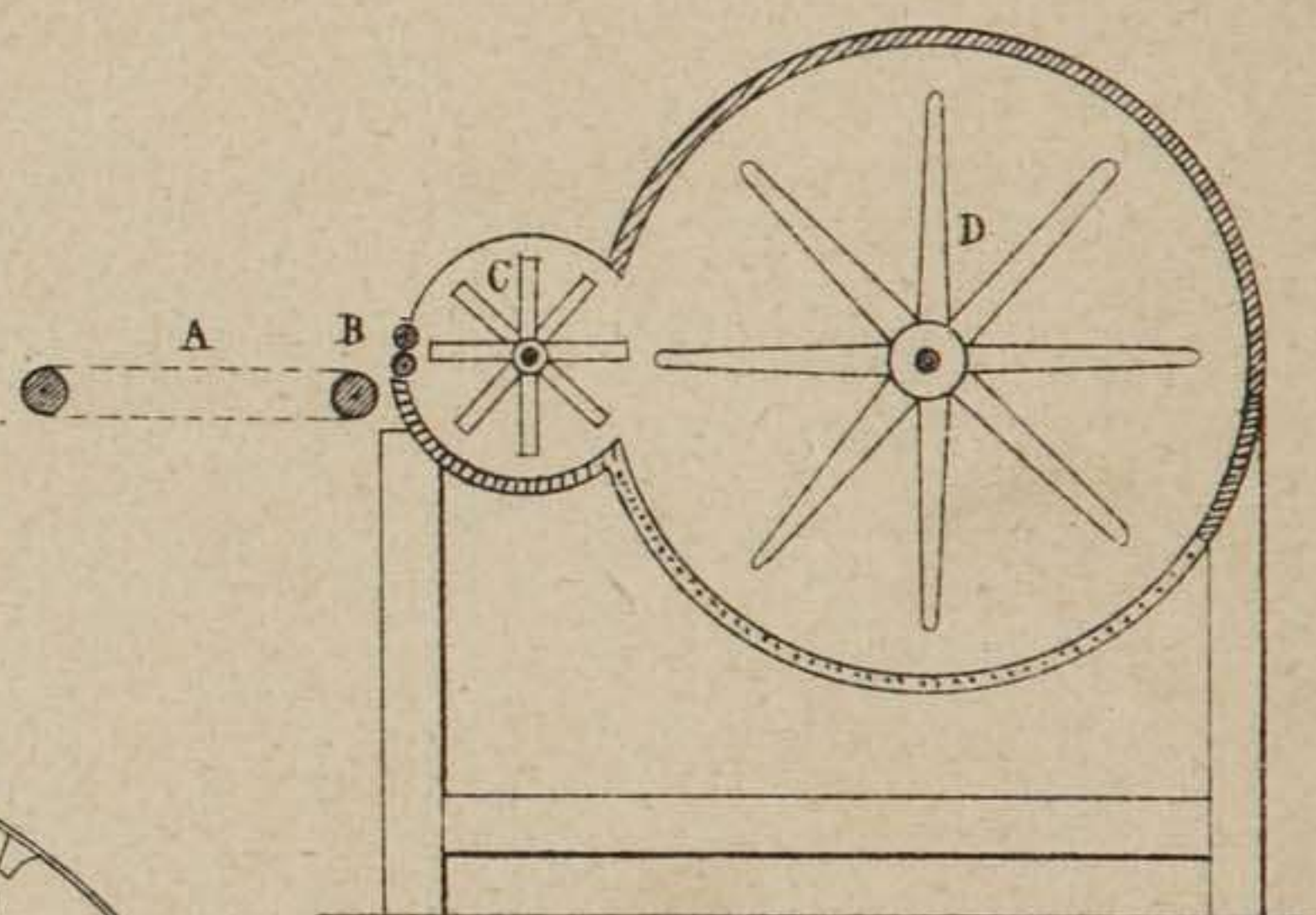


Fig. 4.

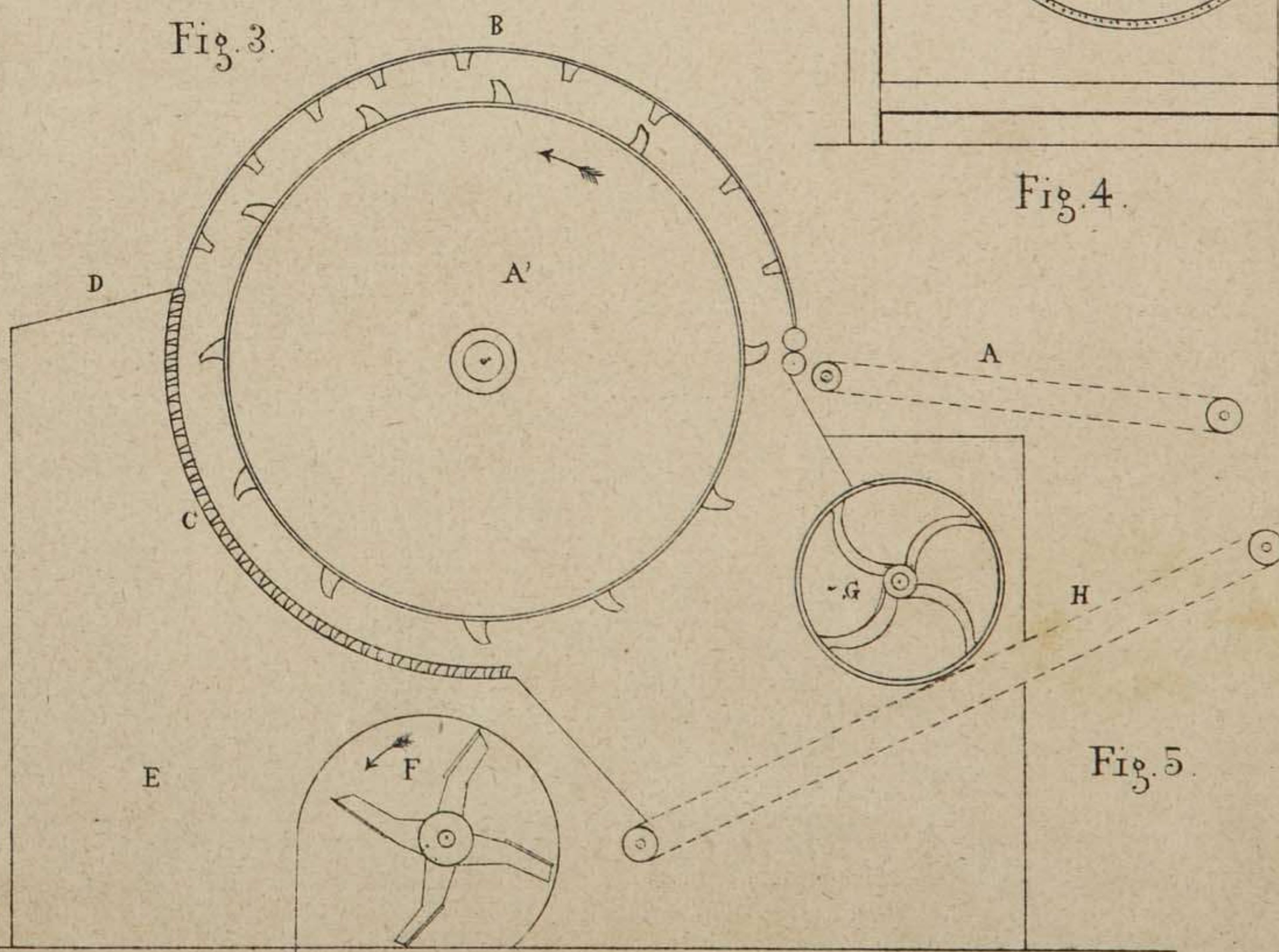


Fig. 5.

Fig 6.

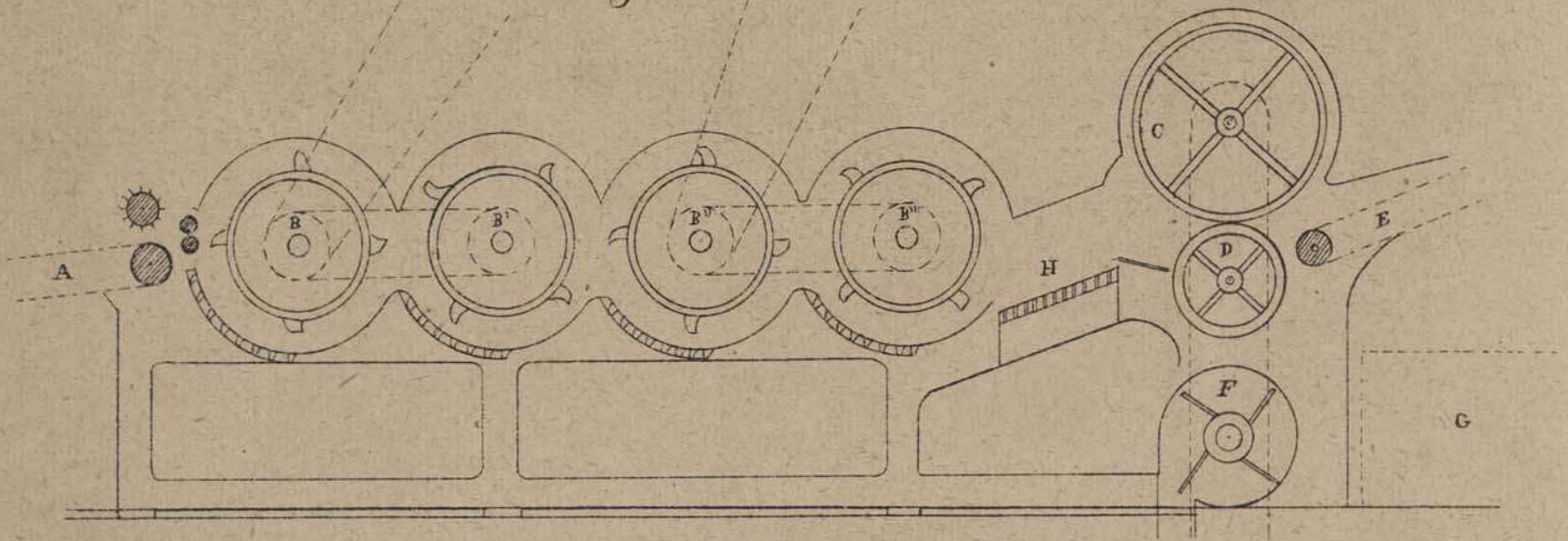


Fig 7

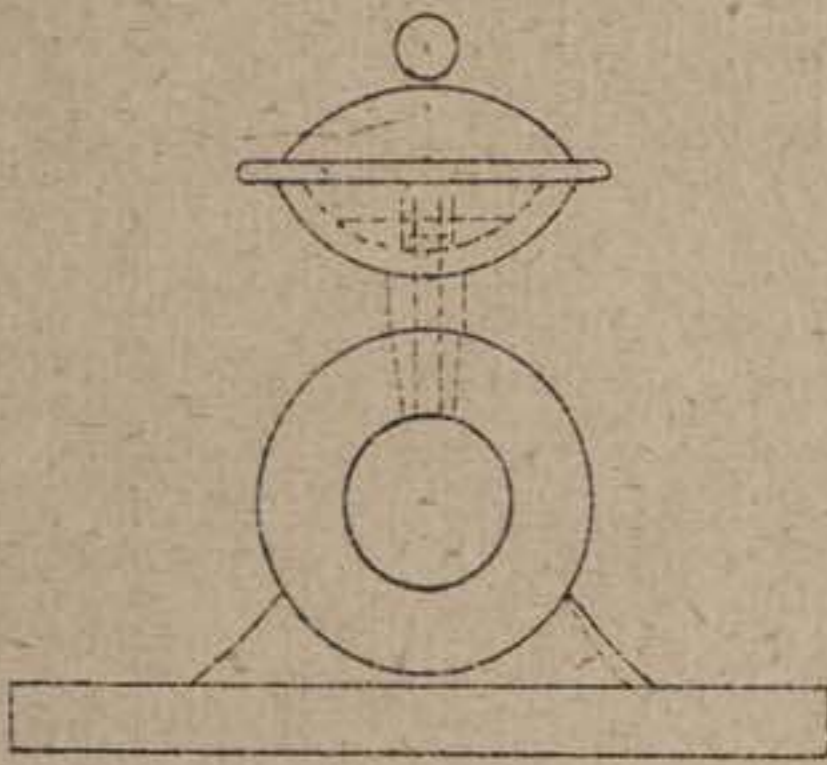


Fig. 8.

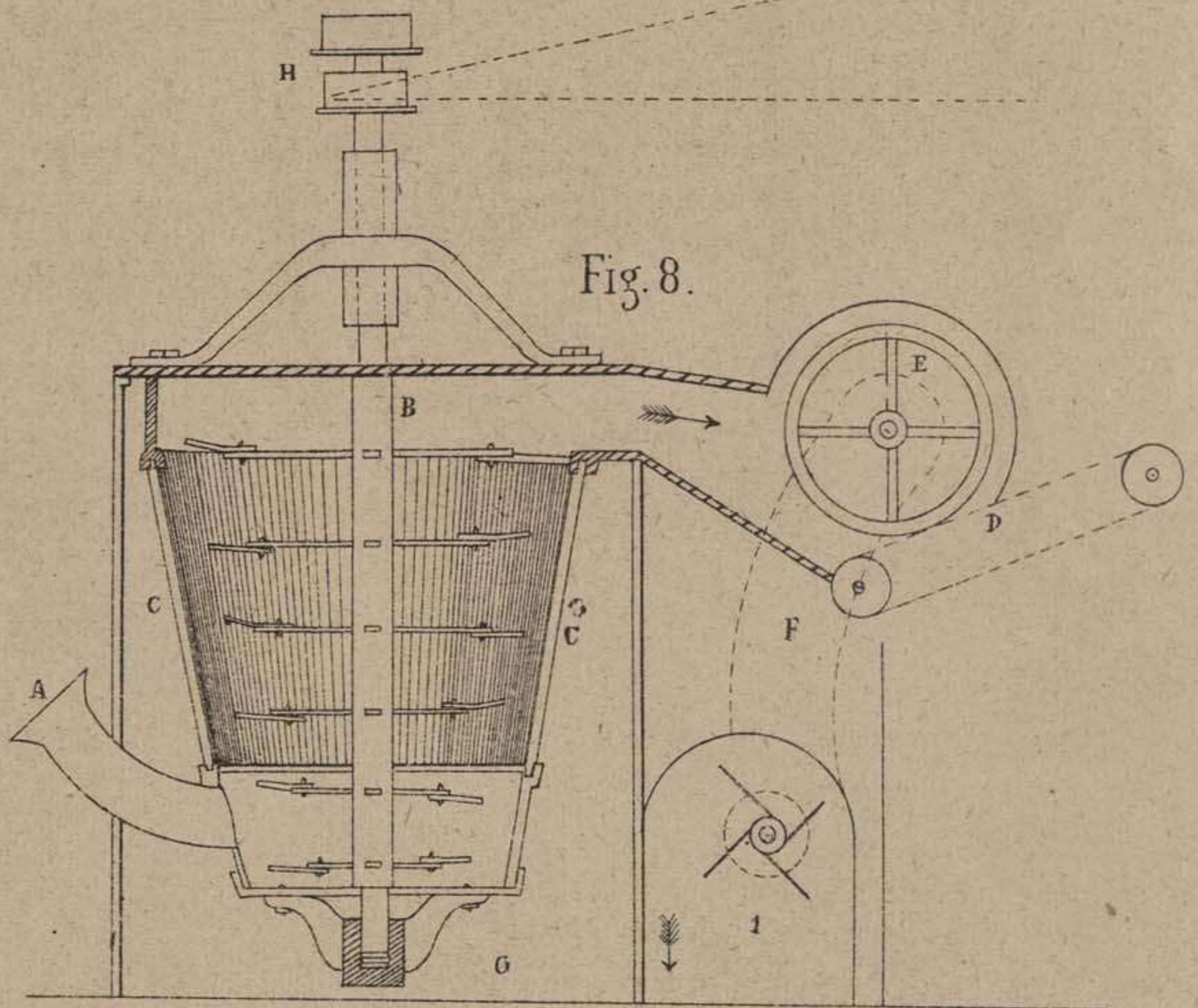


Fig. 9

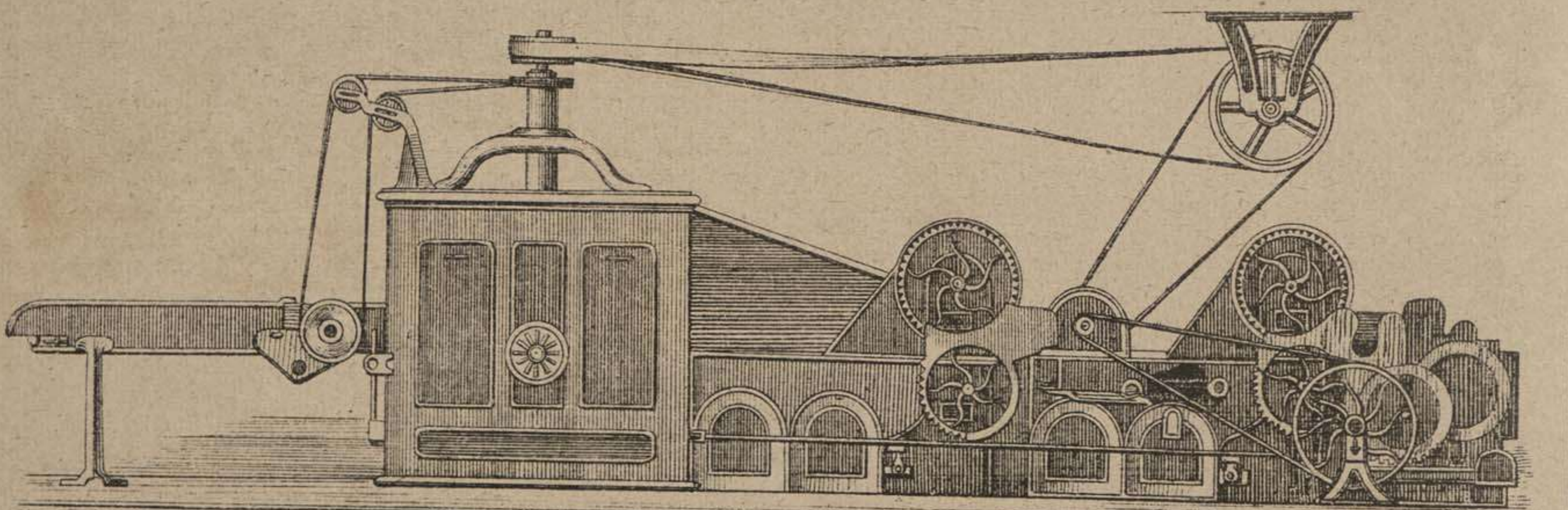


Fig. 13

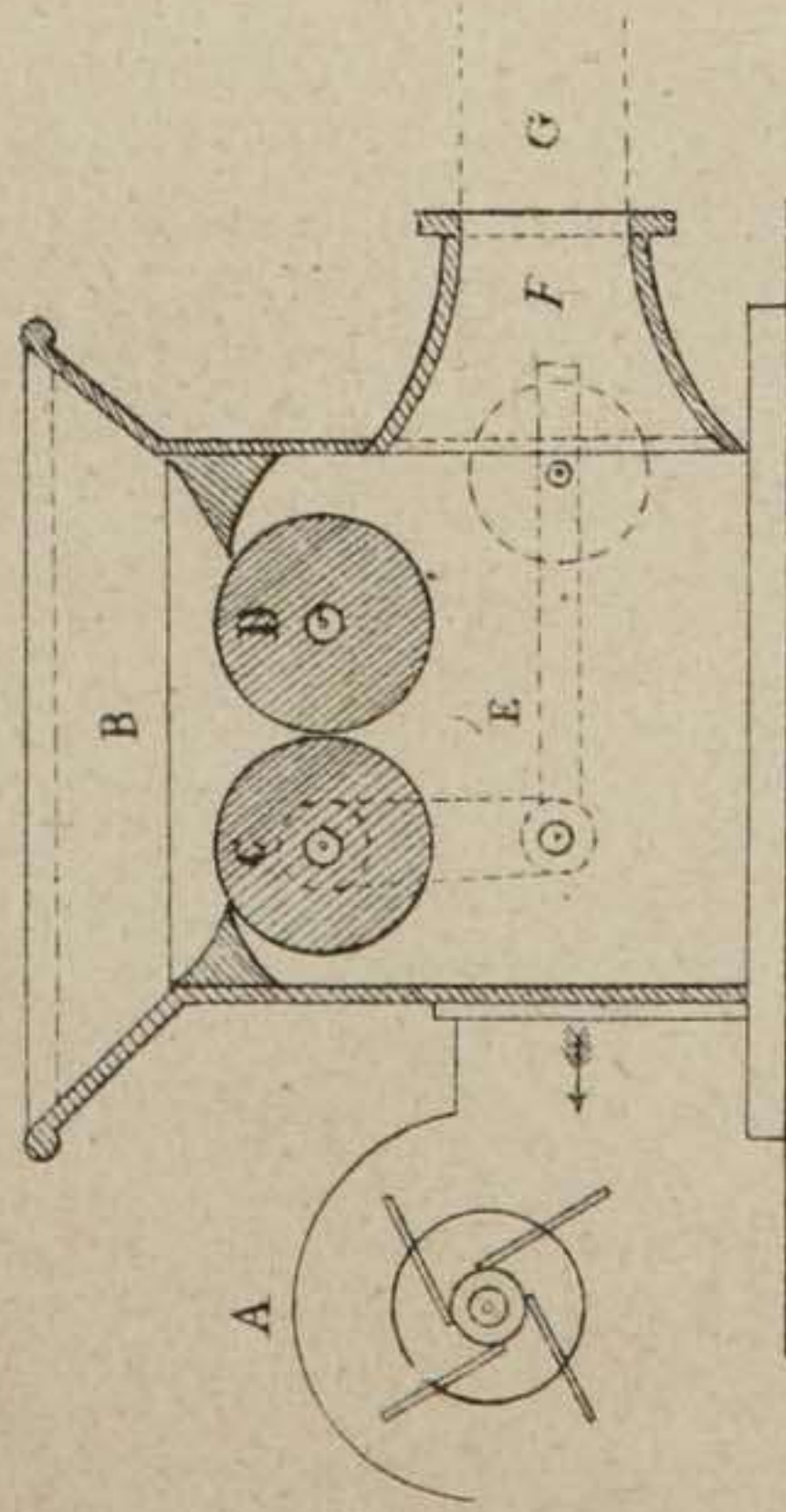


Fig. 10

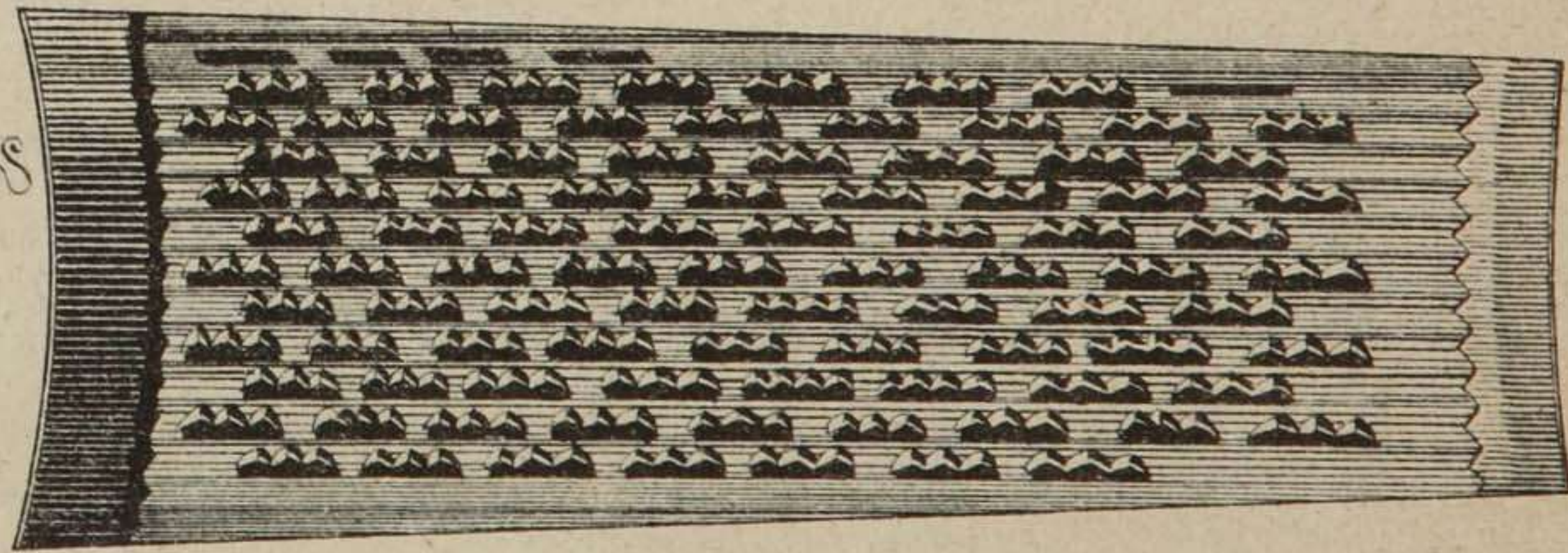


Fig. 12

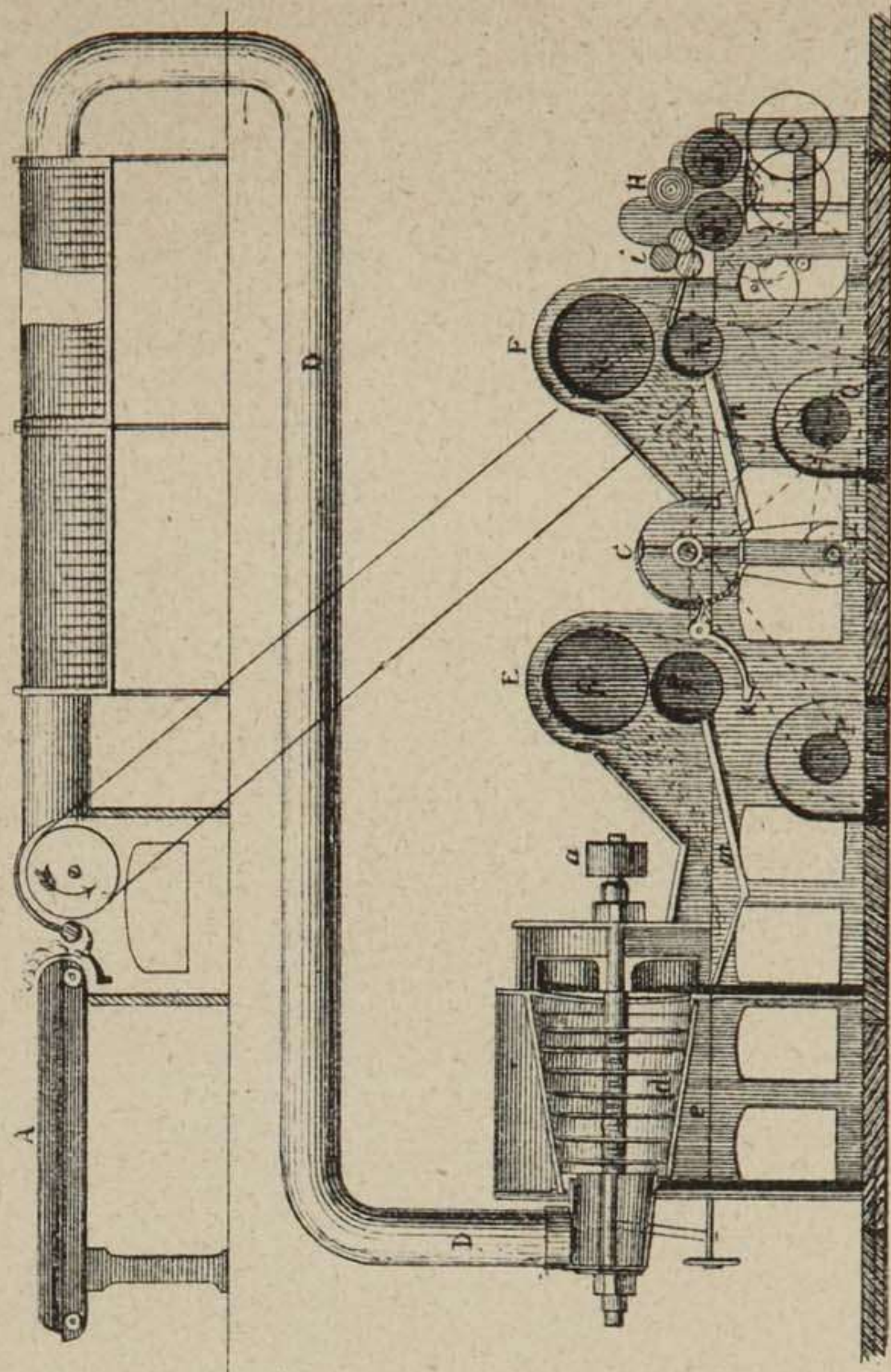
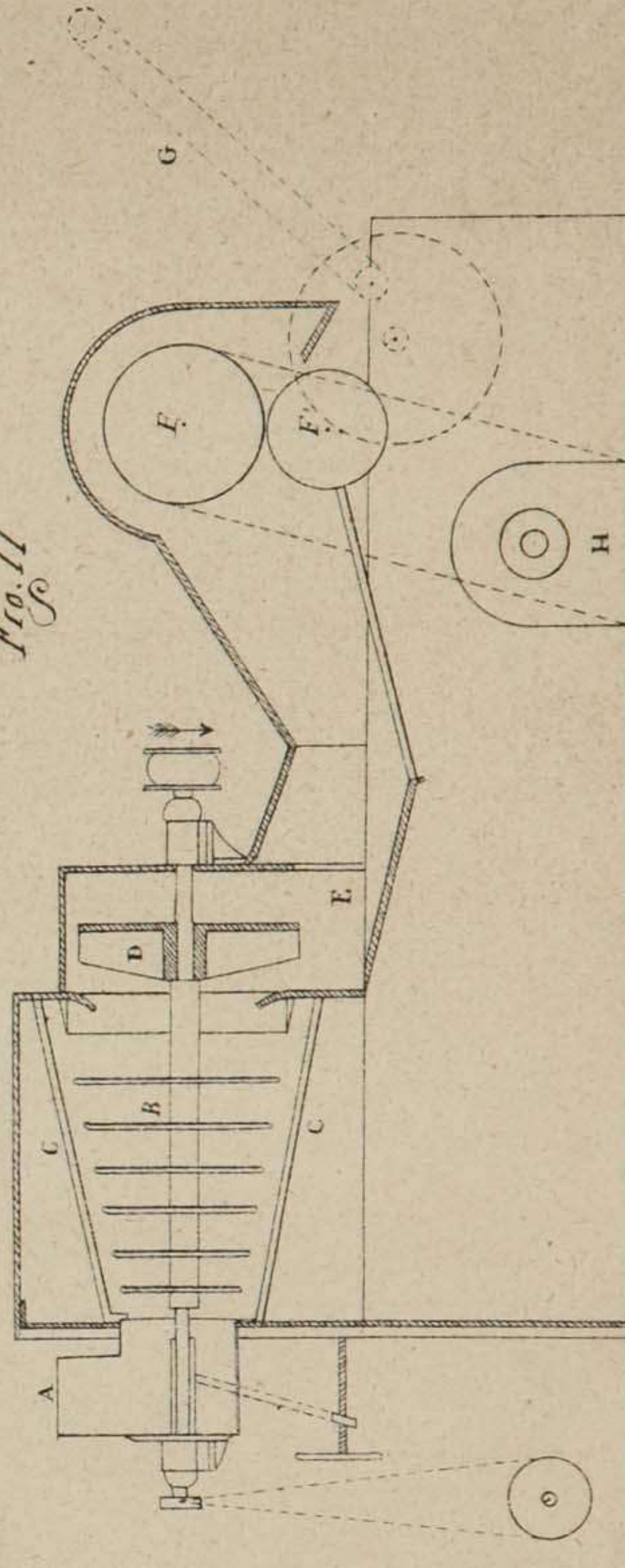


Fig. 11



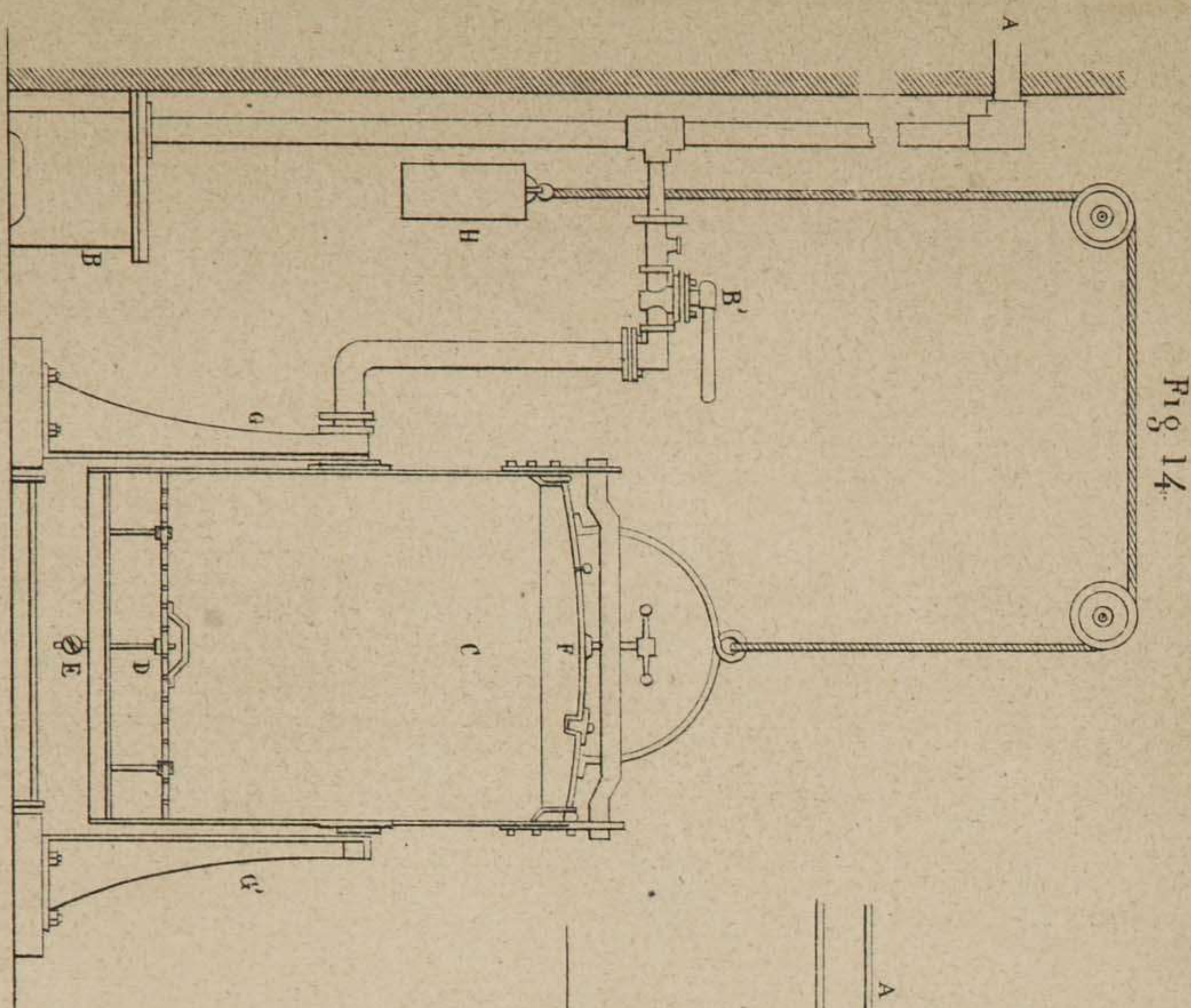


Fig. 14.

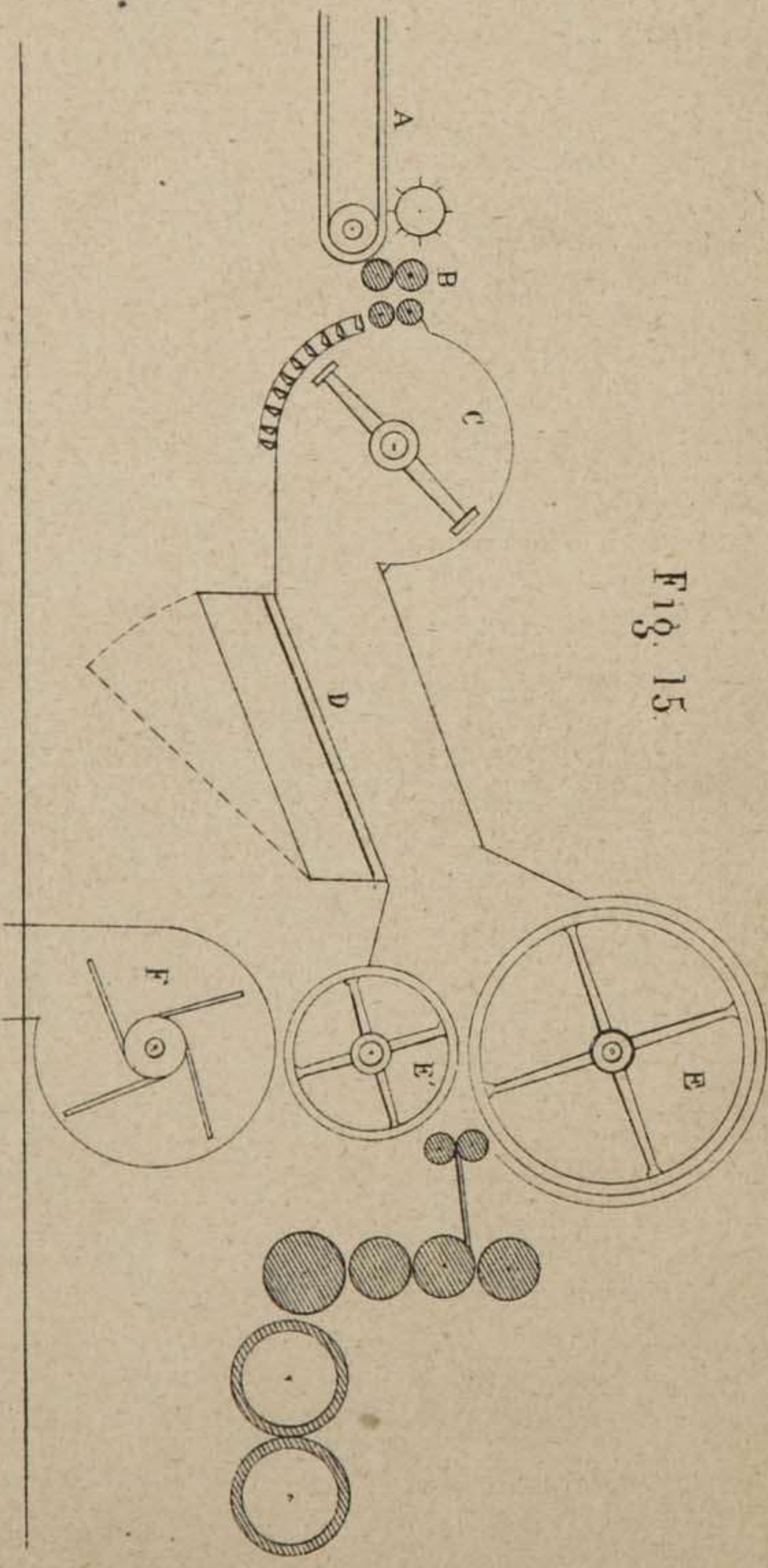


Fig. 15.

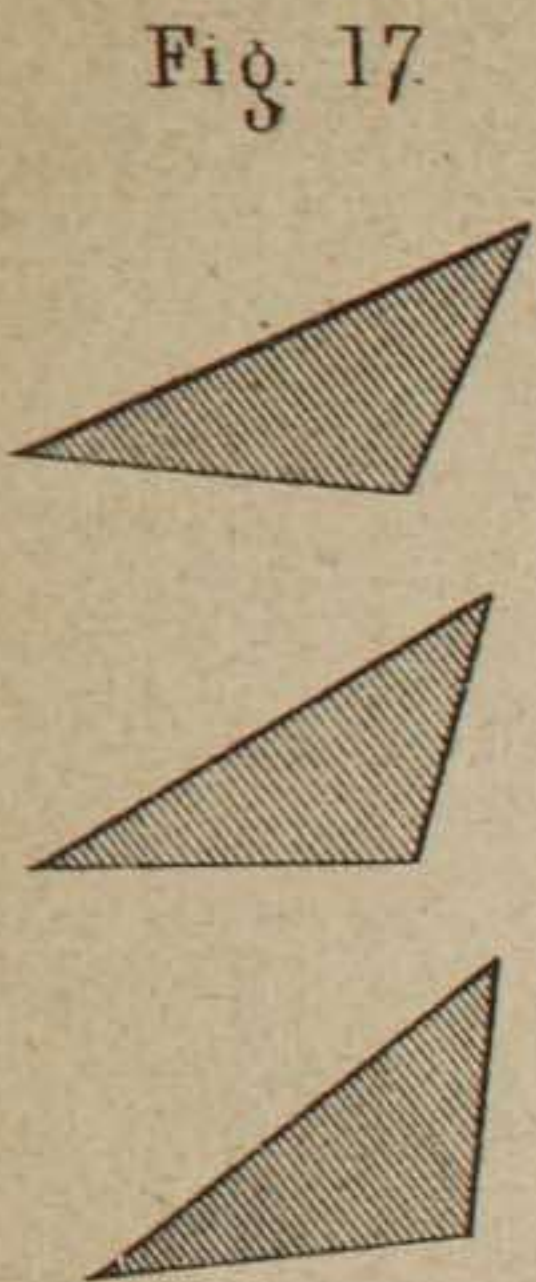


Fig. 17.

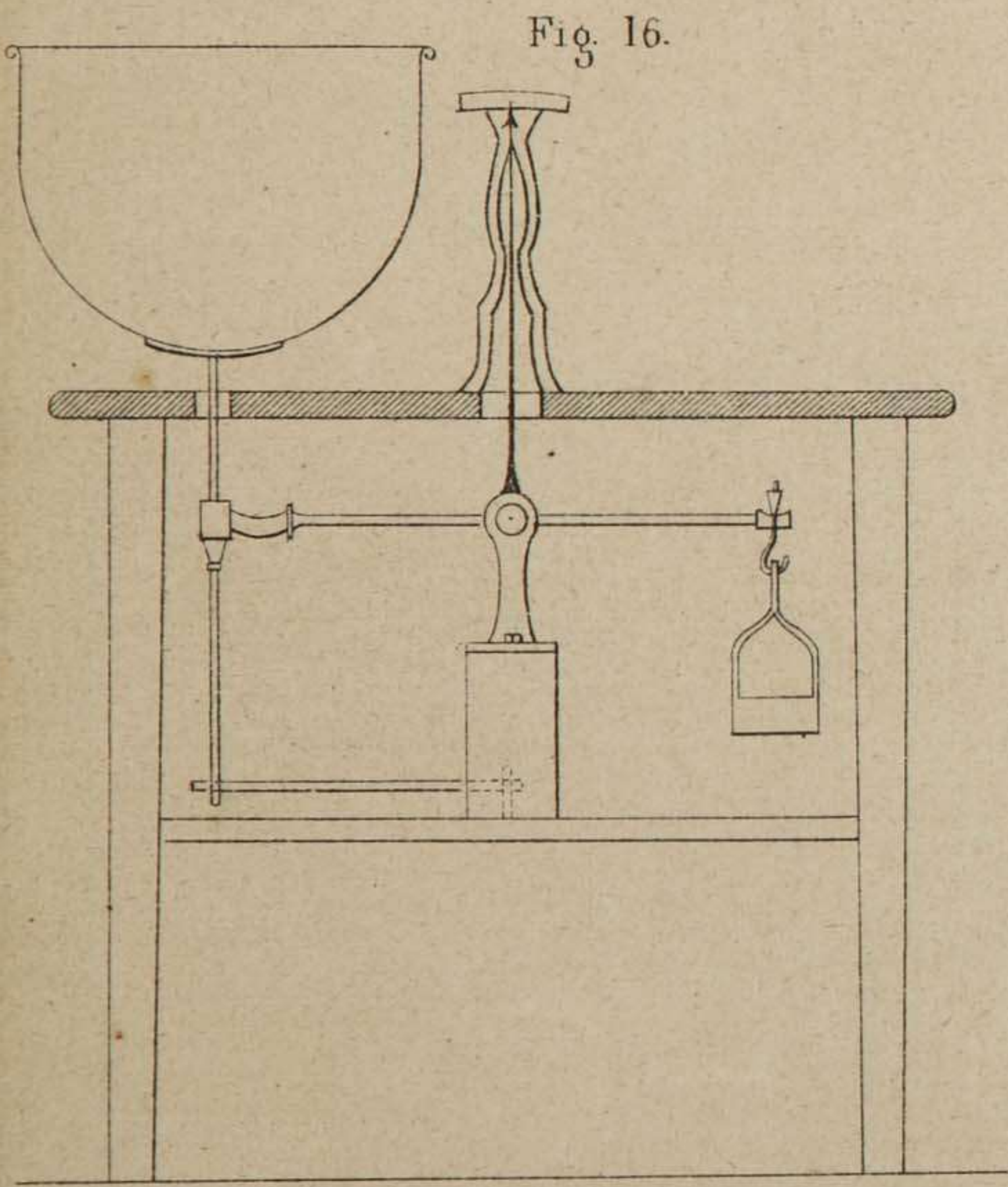


Fig. 16.

Fig. 18.

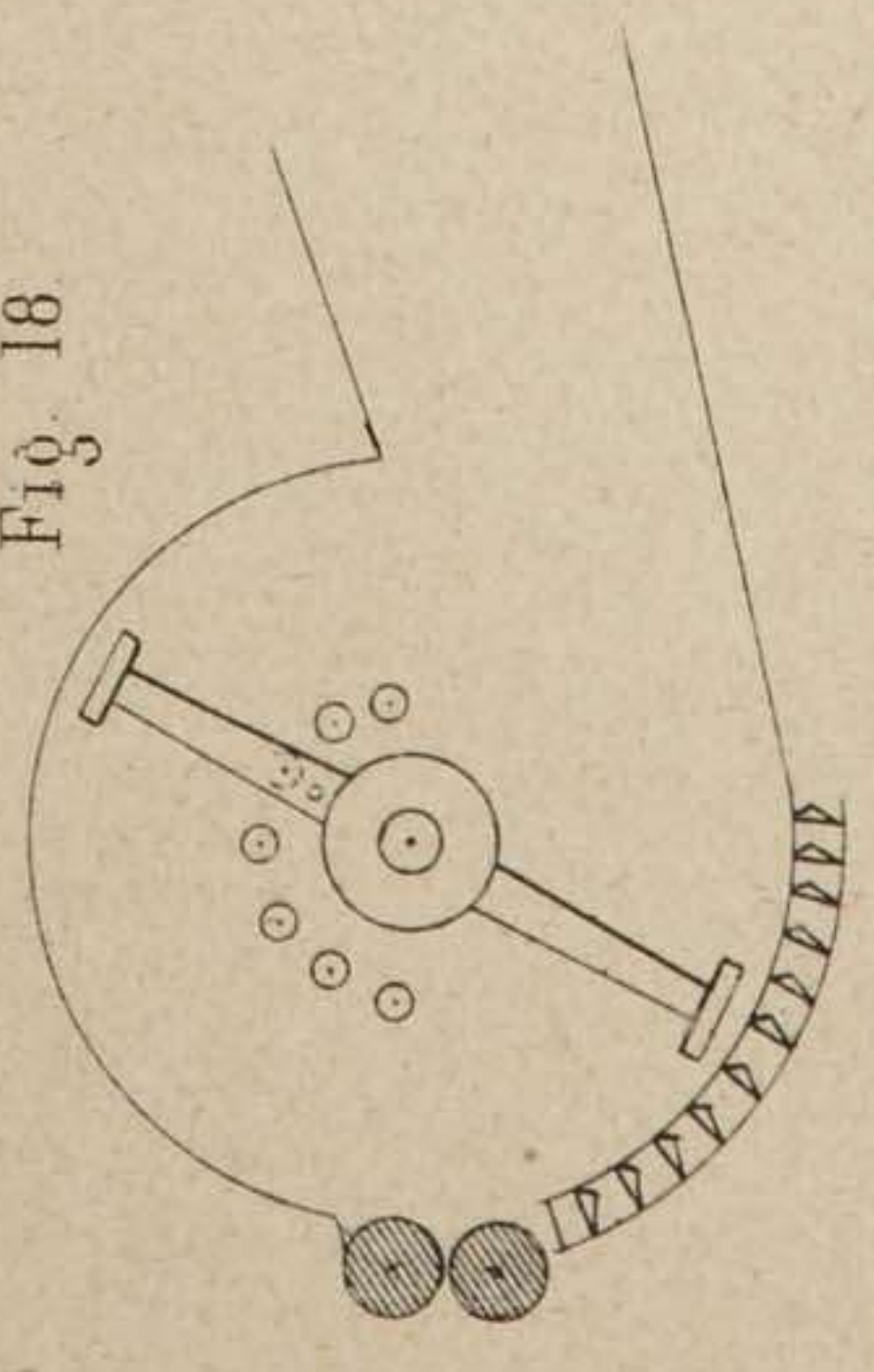


Fig. 19.

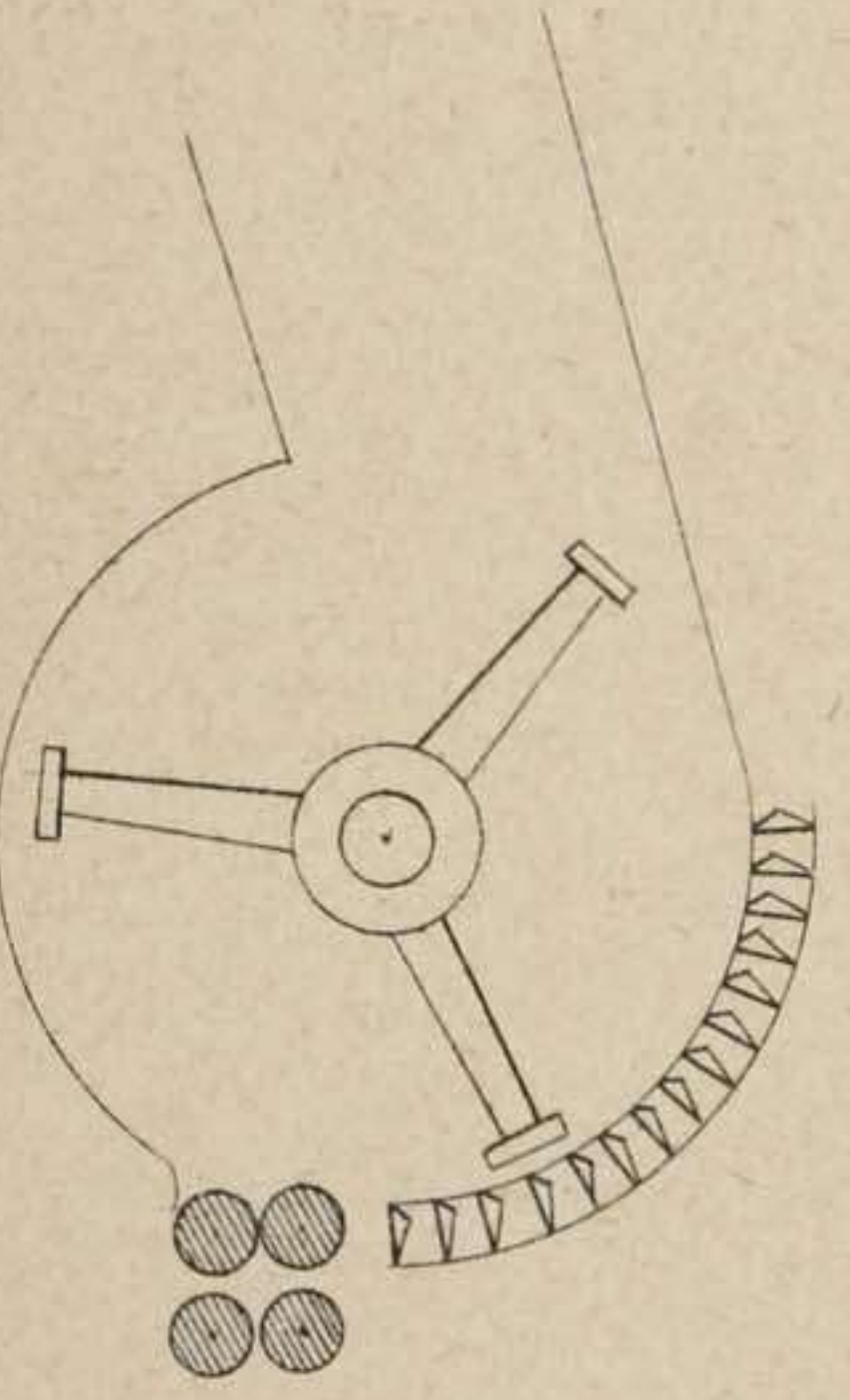


Fig. 20.

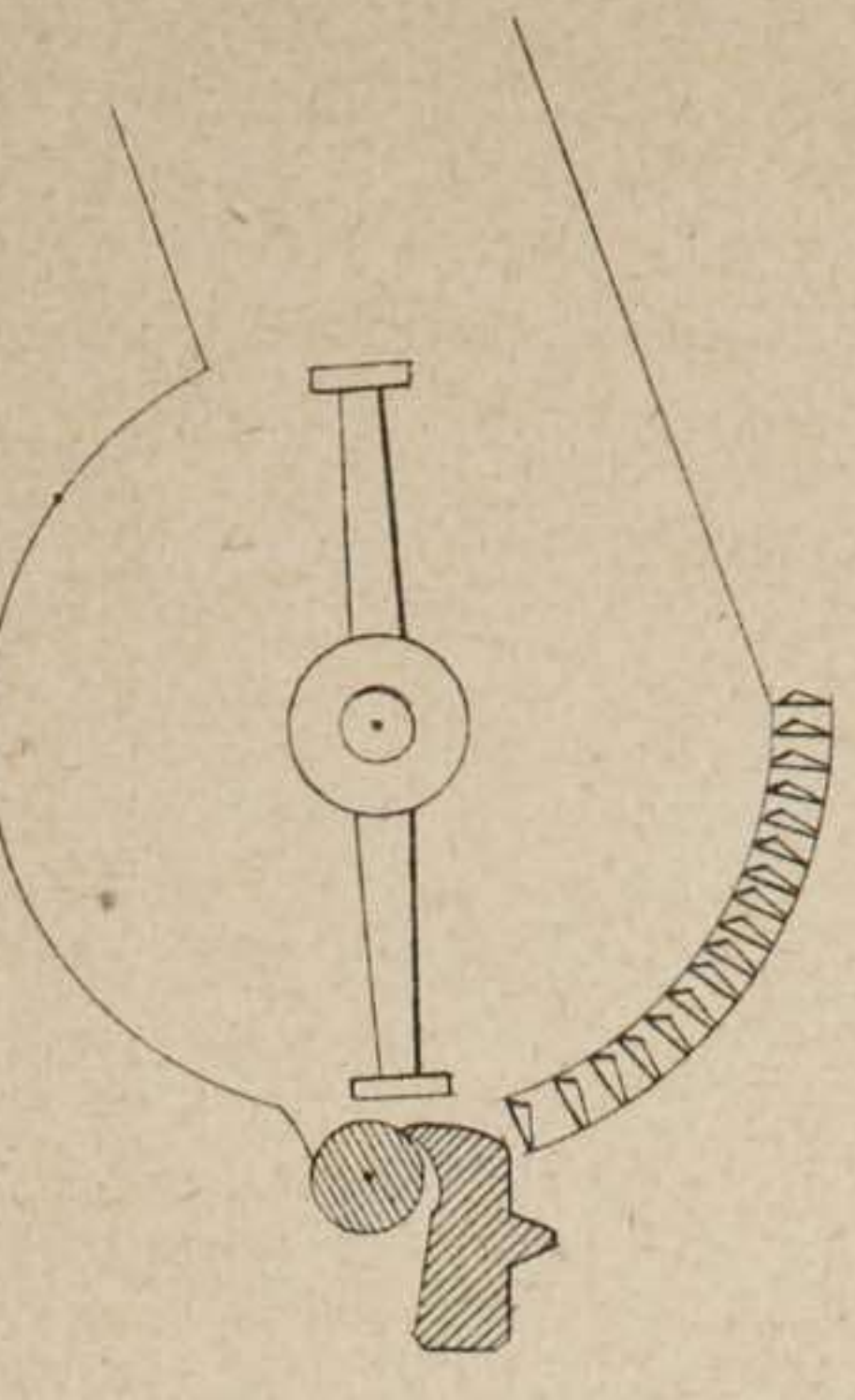


Fig. 21.

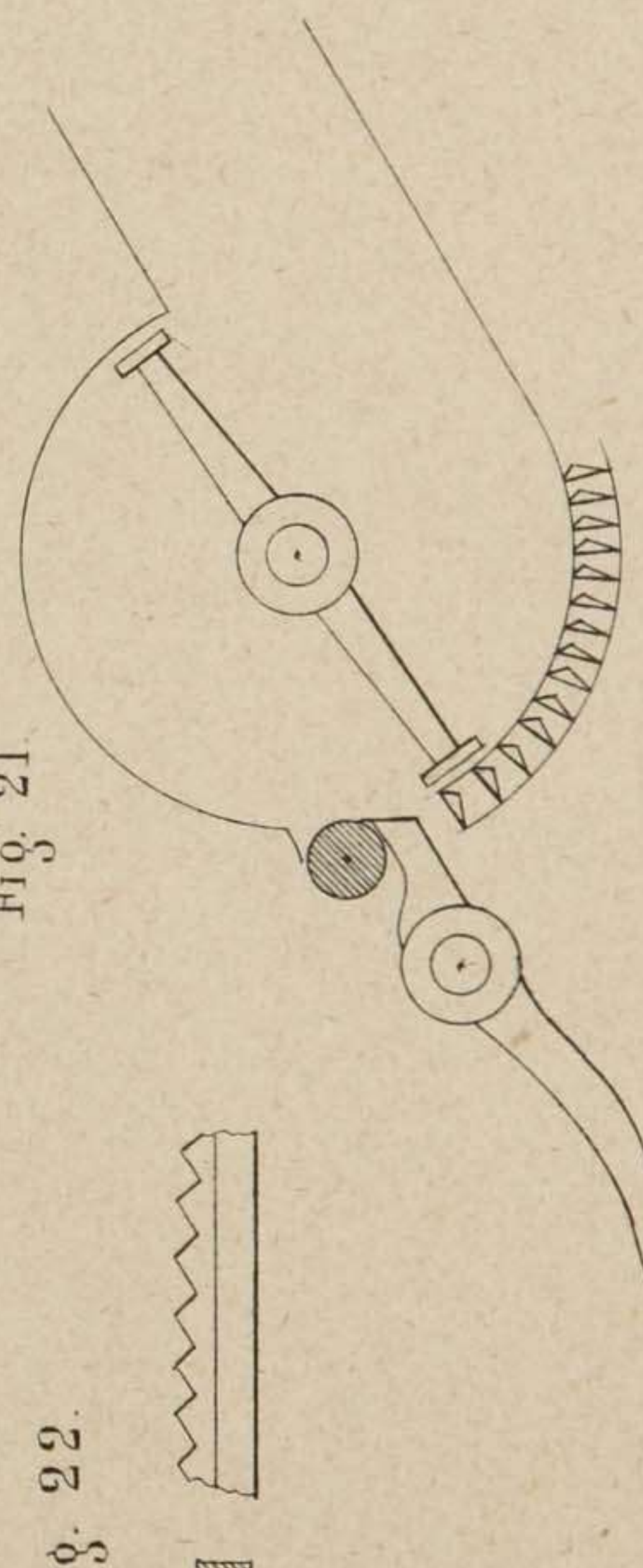


Fig. 22.

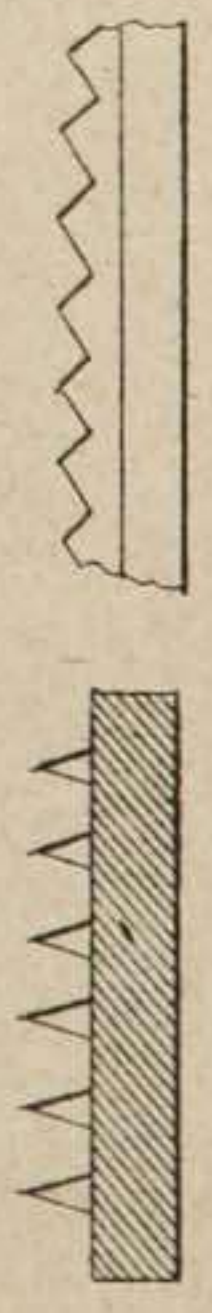


Fig. 23.

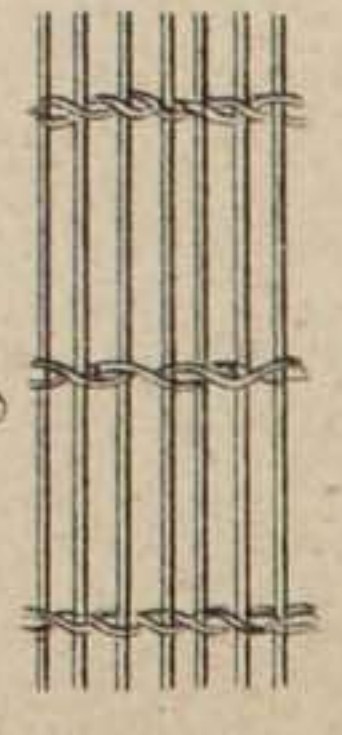


Fig. 26.

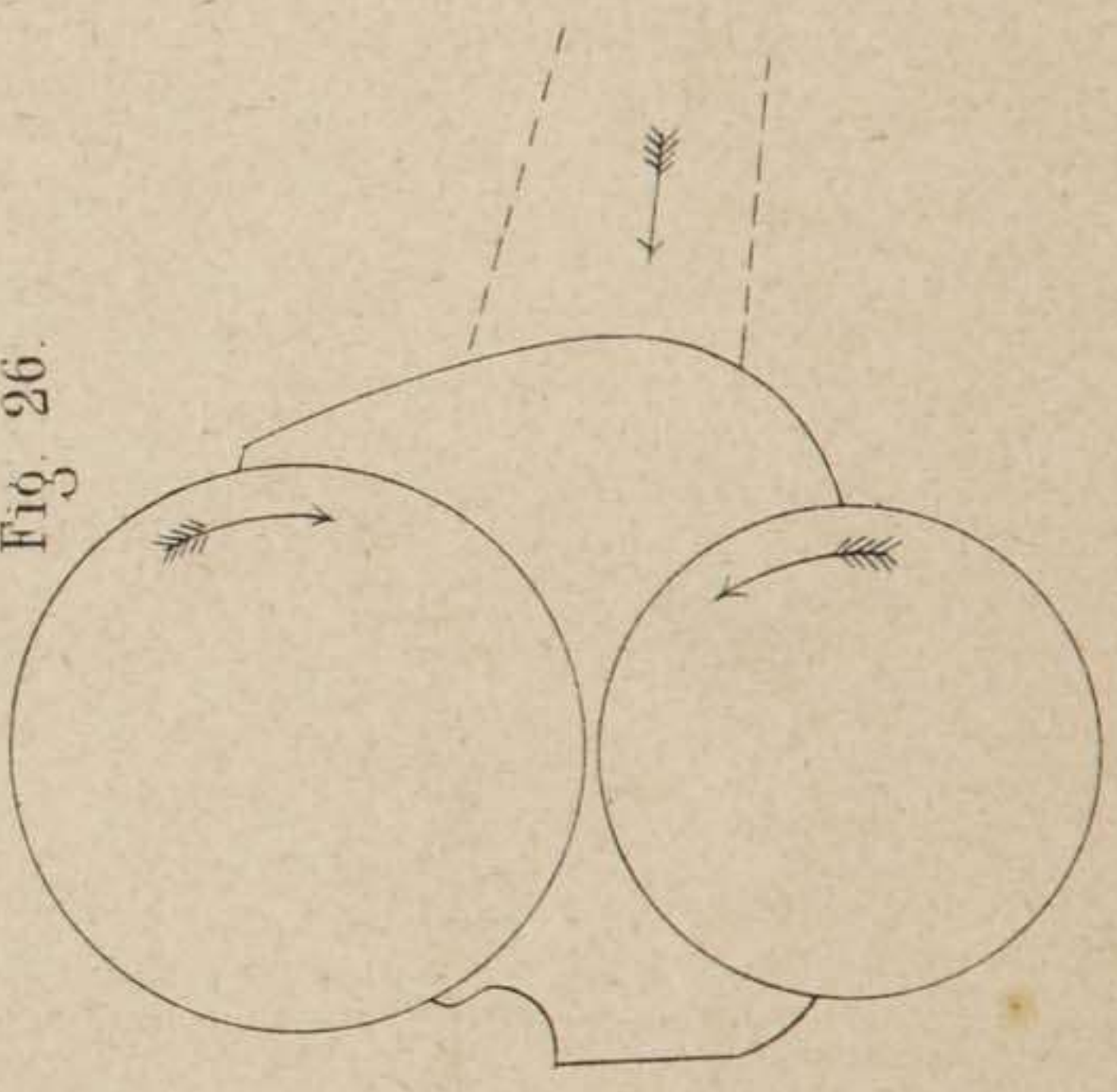


Fig. 27.

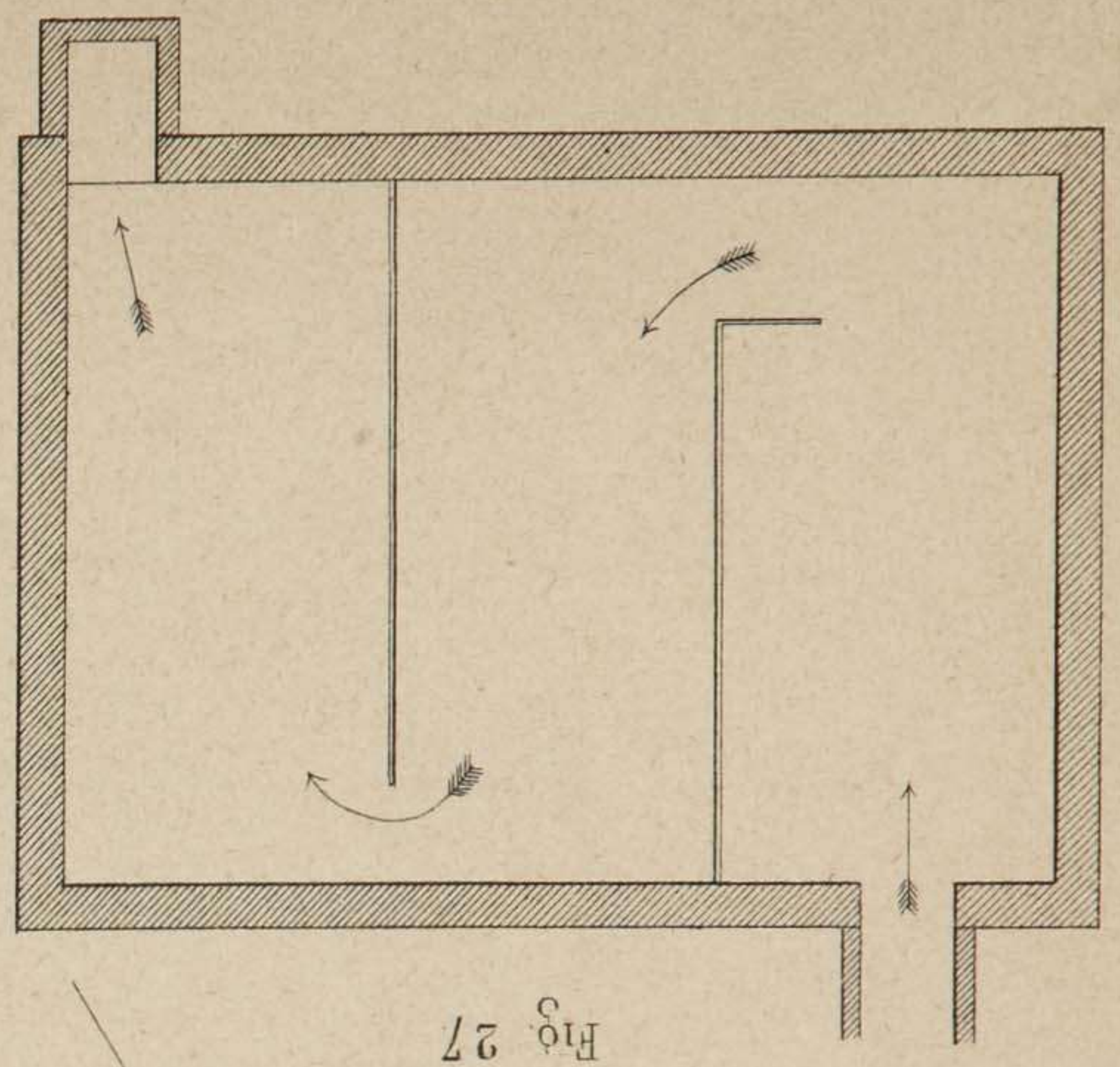


Fig. 25.

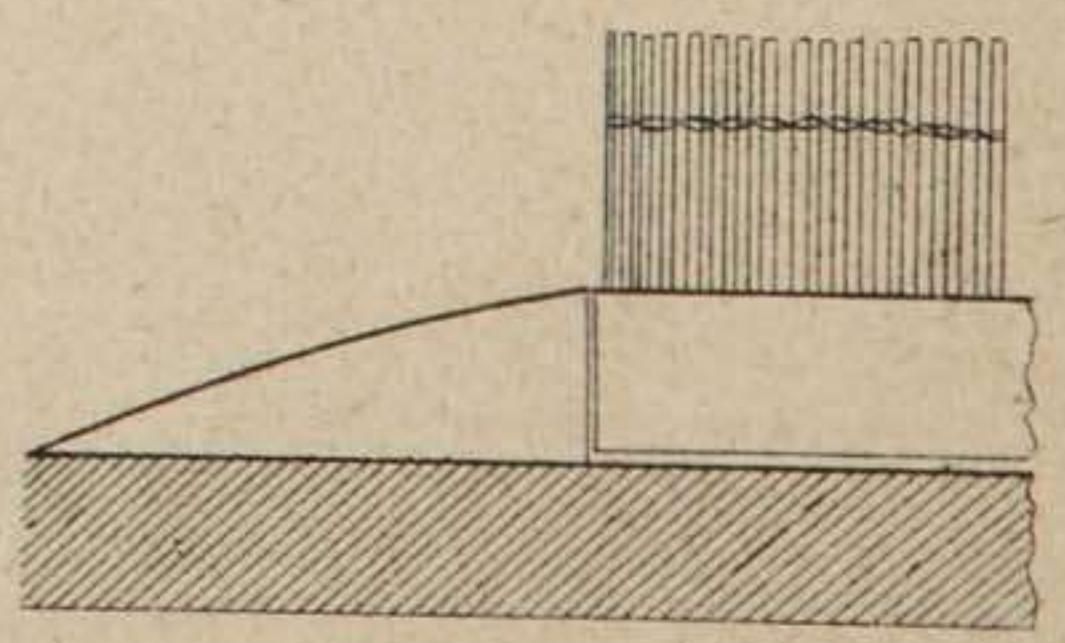


Fig. 24.

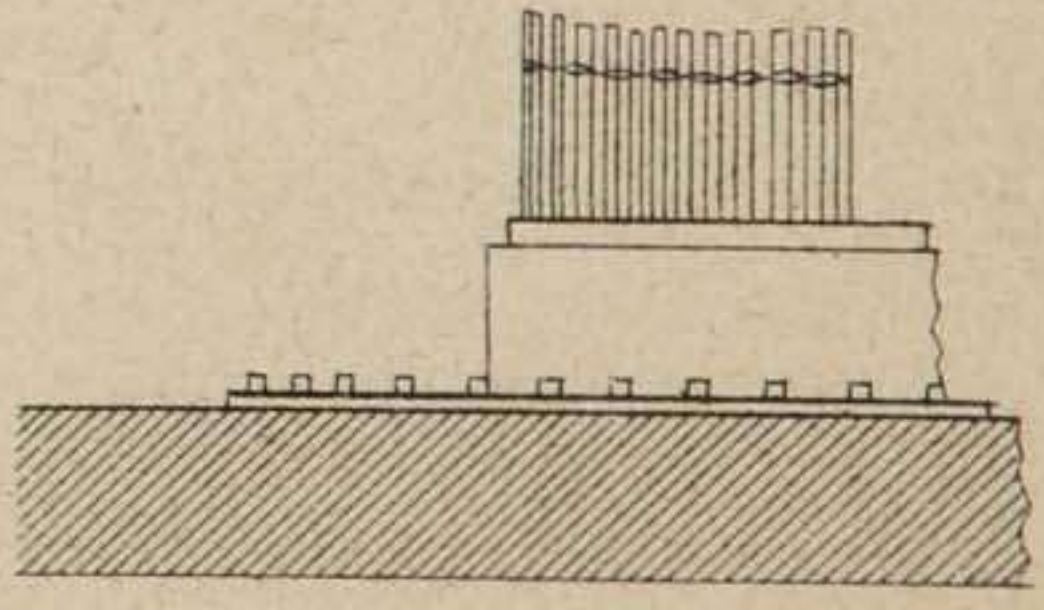


Fig. 28.

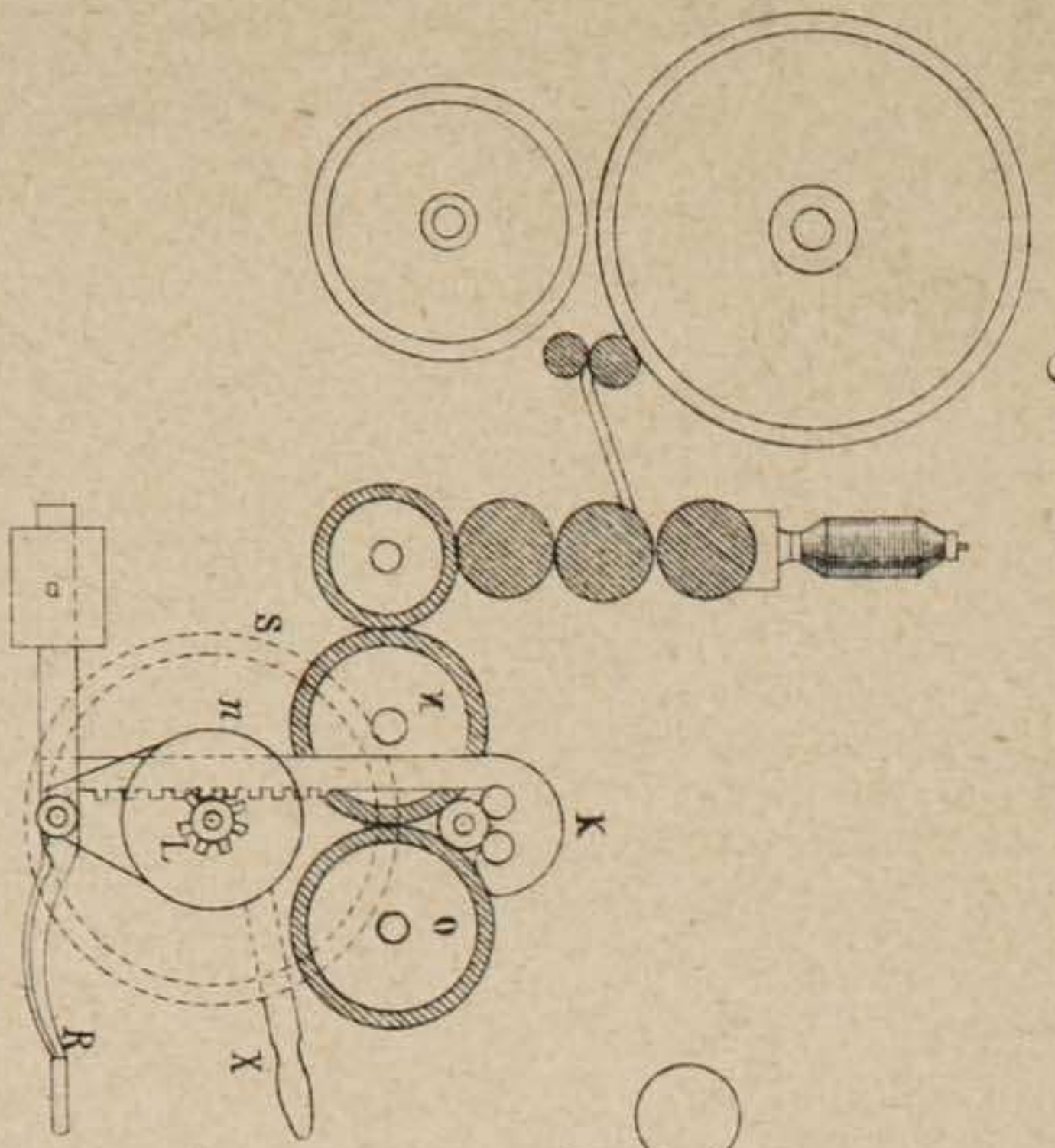


Fig. 29.

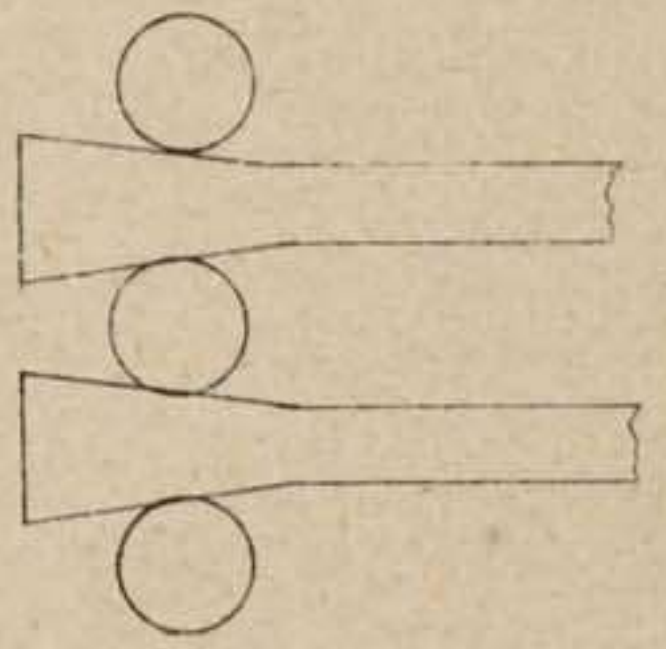


Fig. 29.

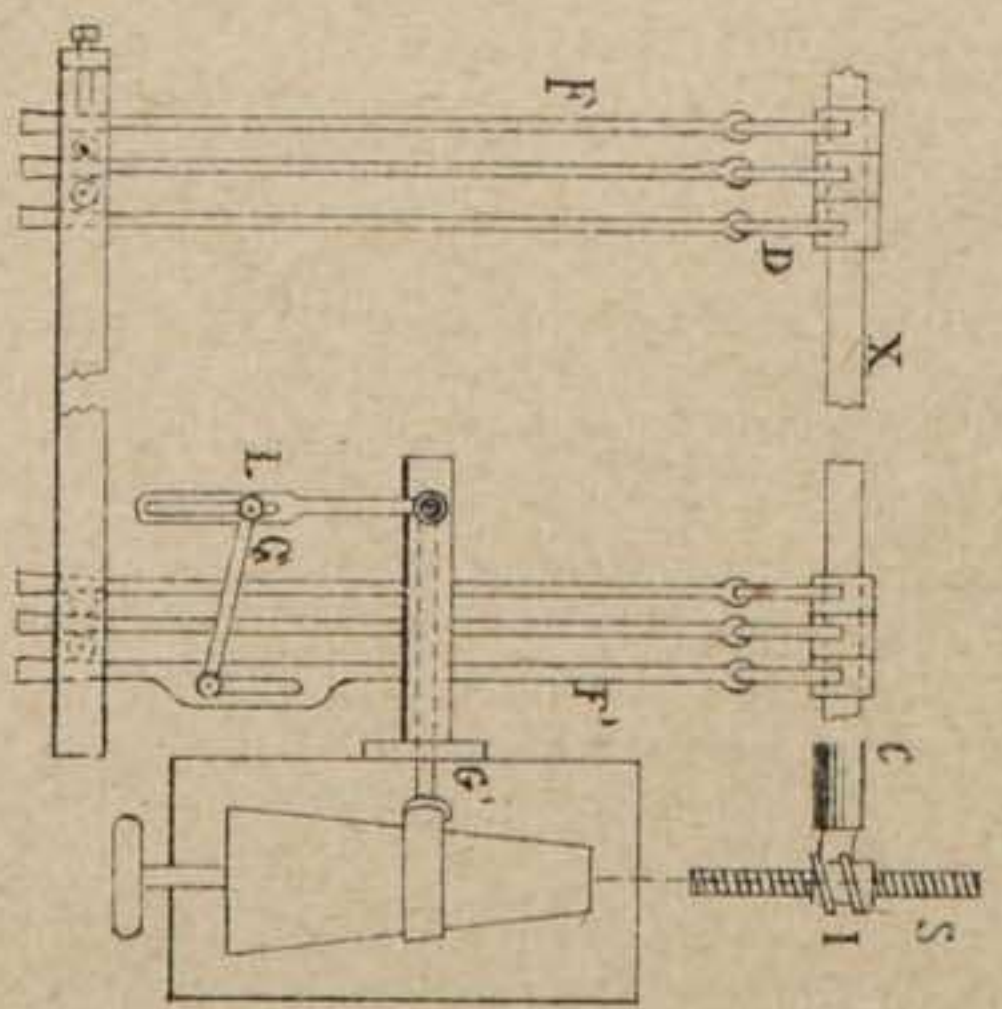
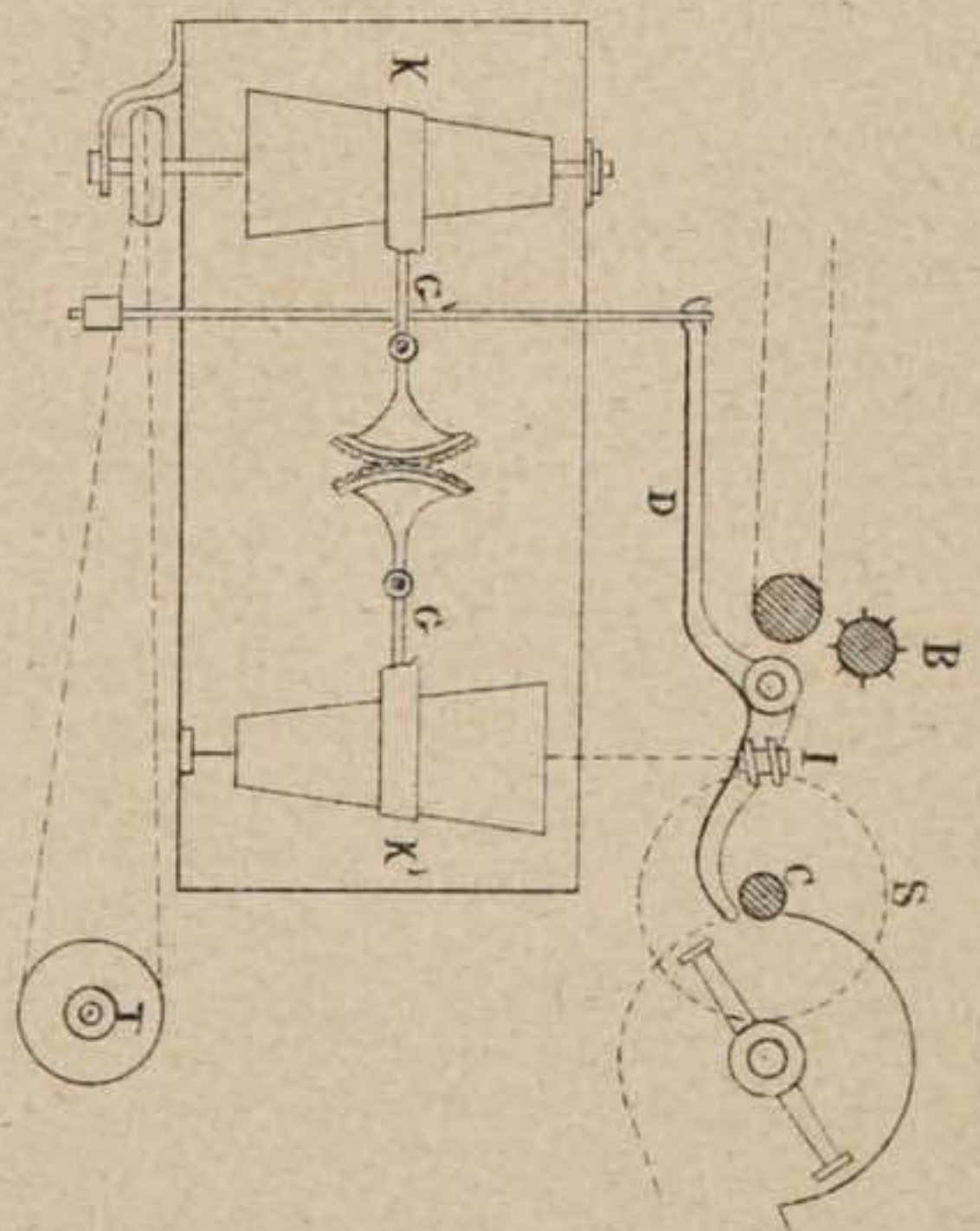


Fig. 30.

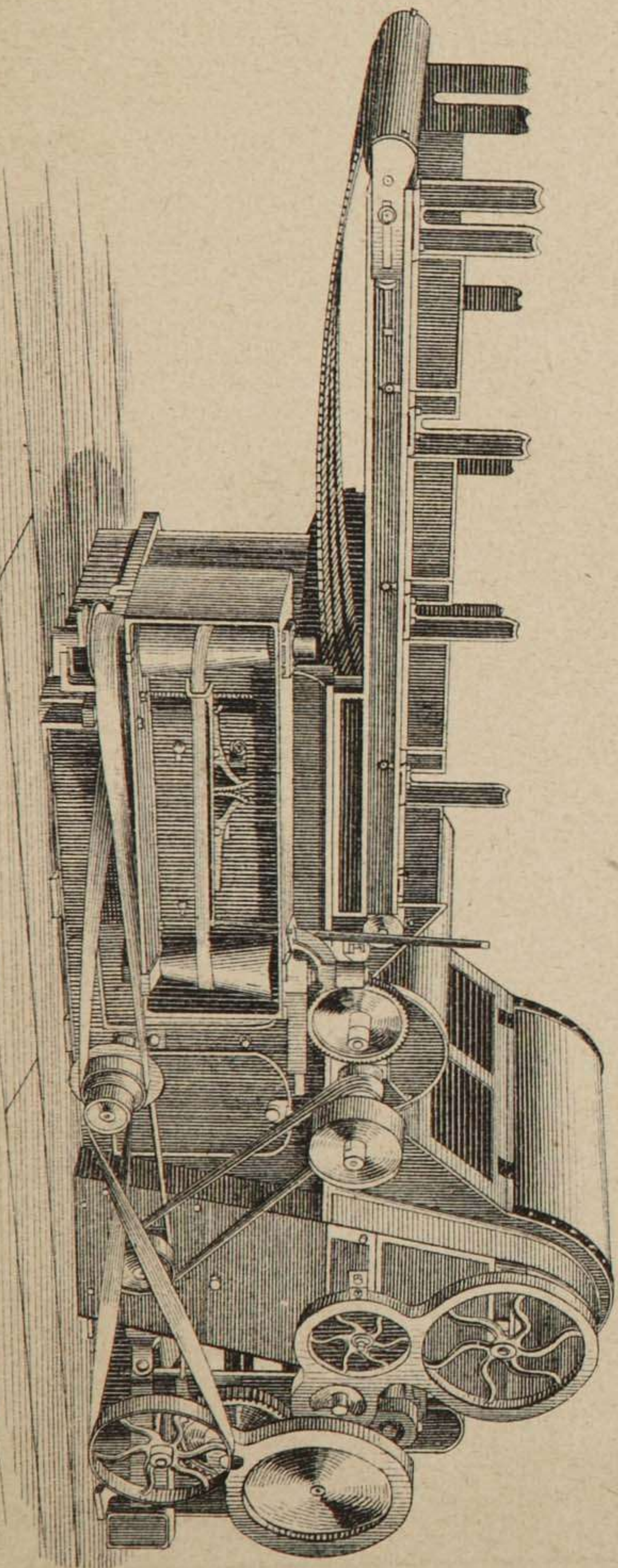


Fig. 31.

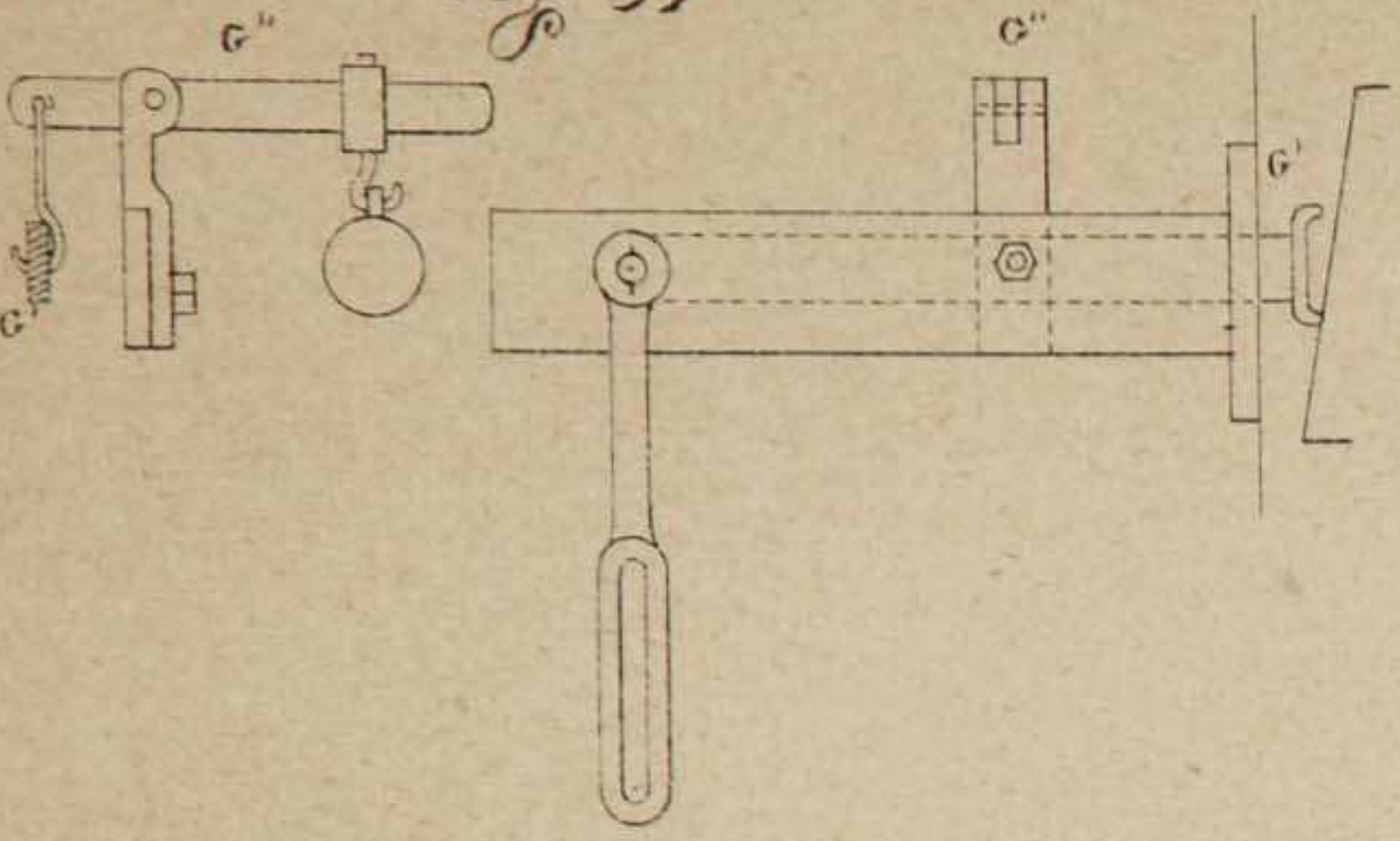


Fig. 33
P

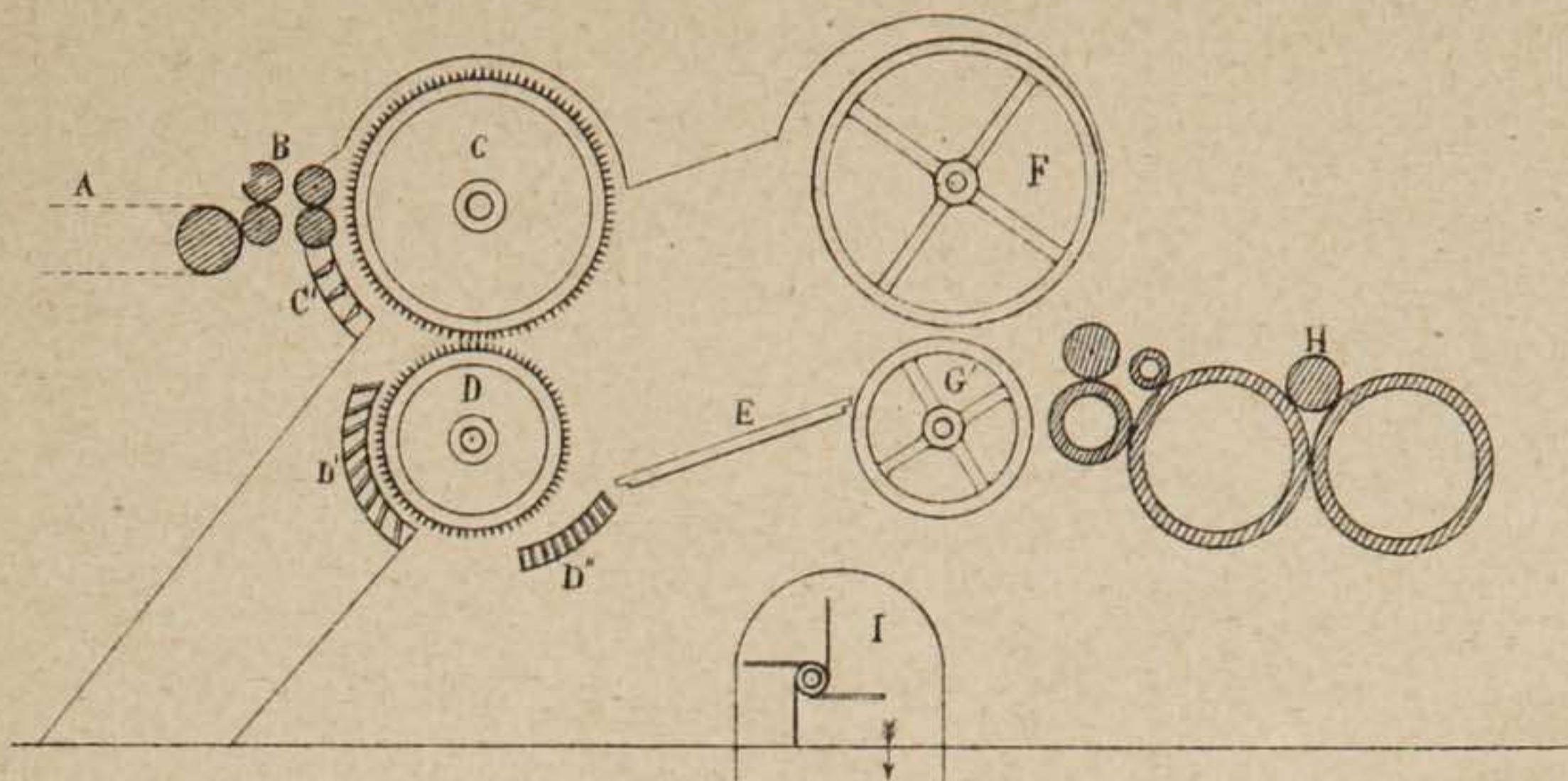


Fig. 37
P

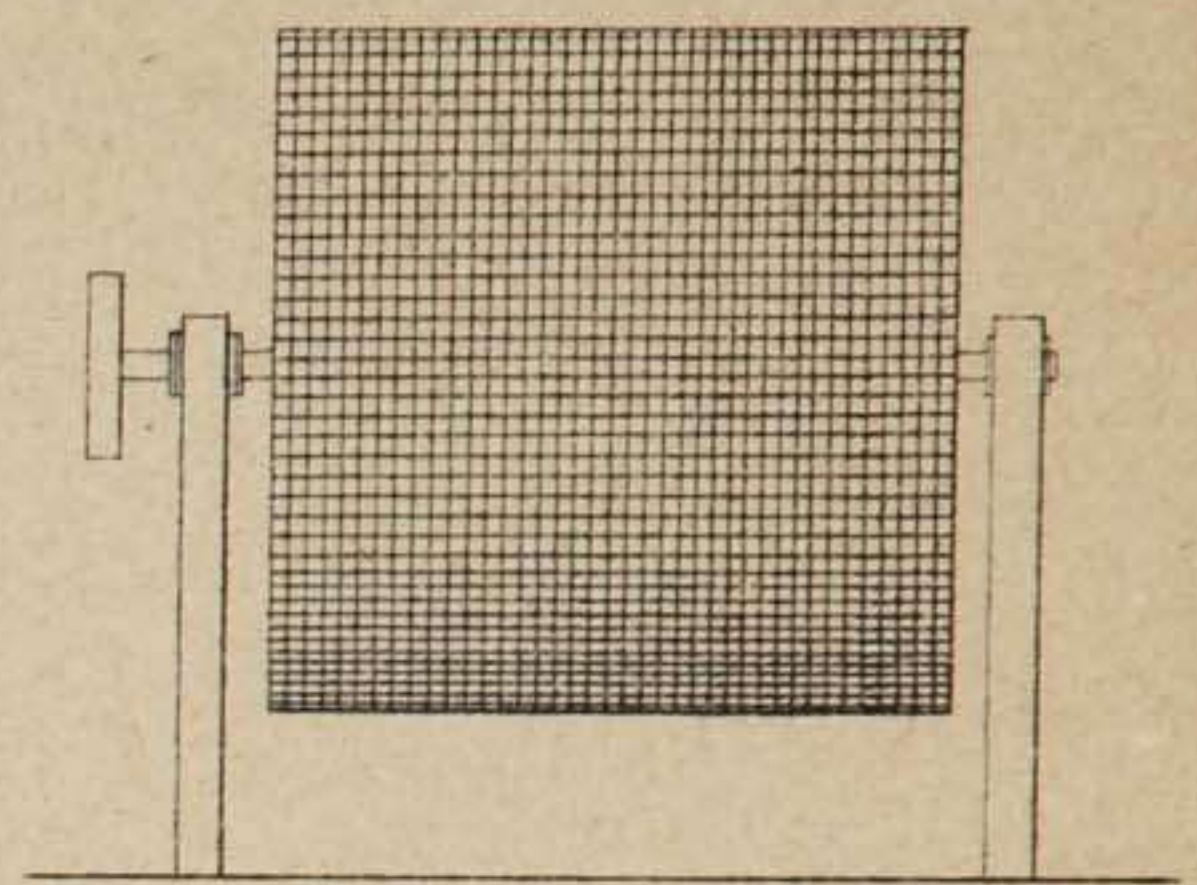


Fig. 34
P

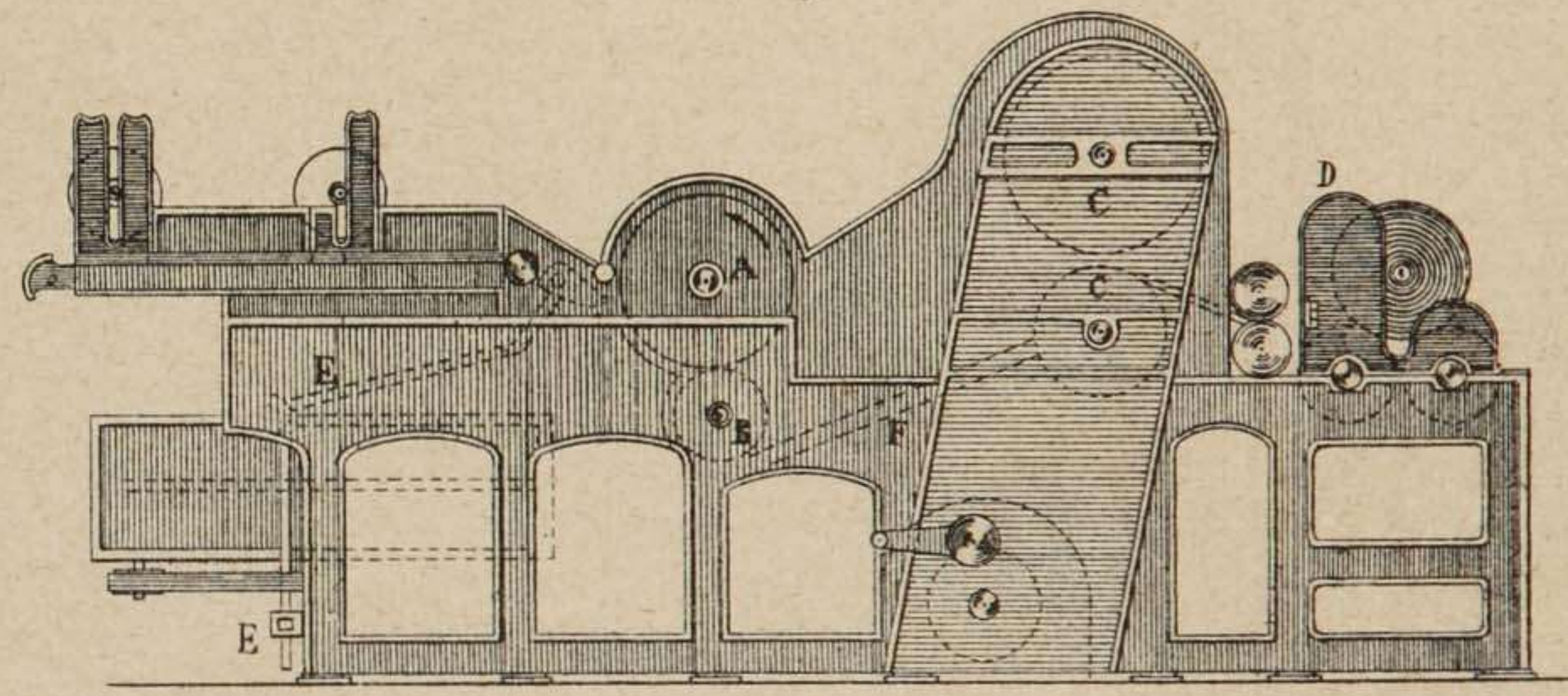


Fig. 35
P

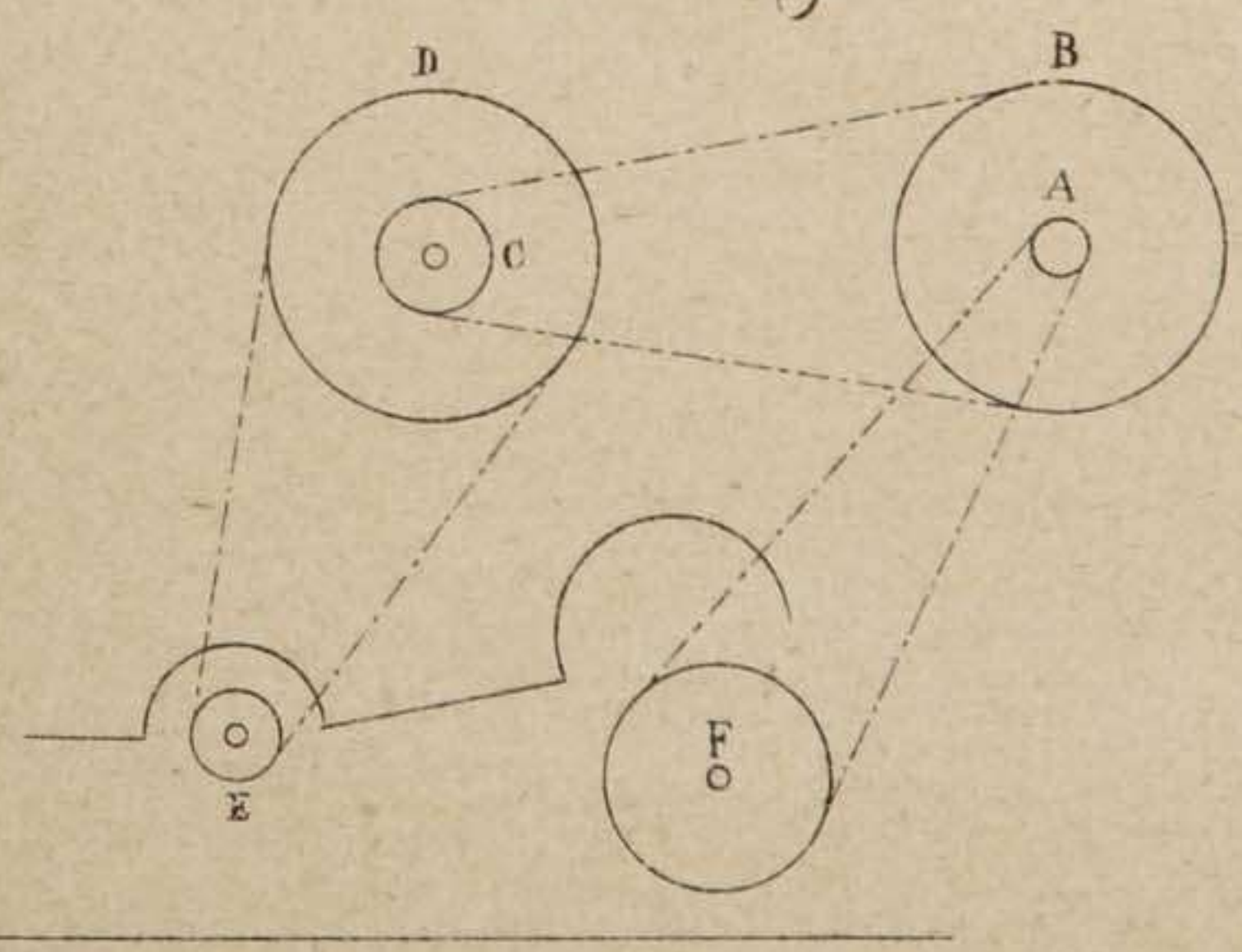
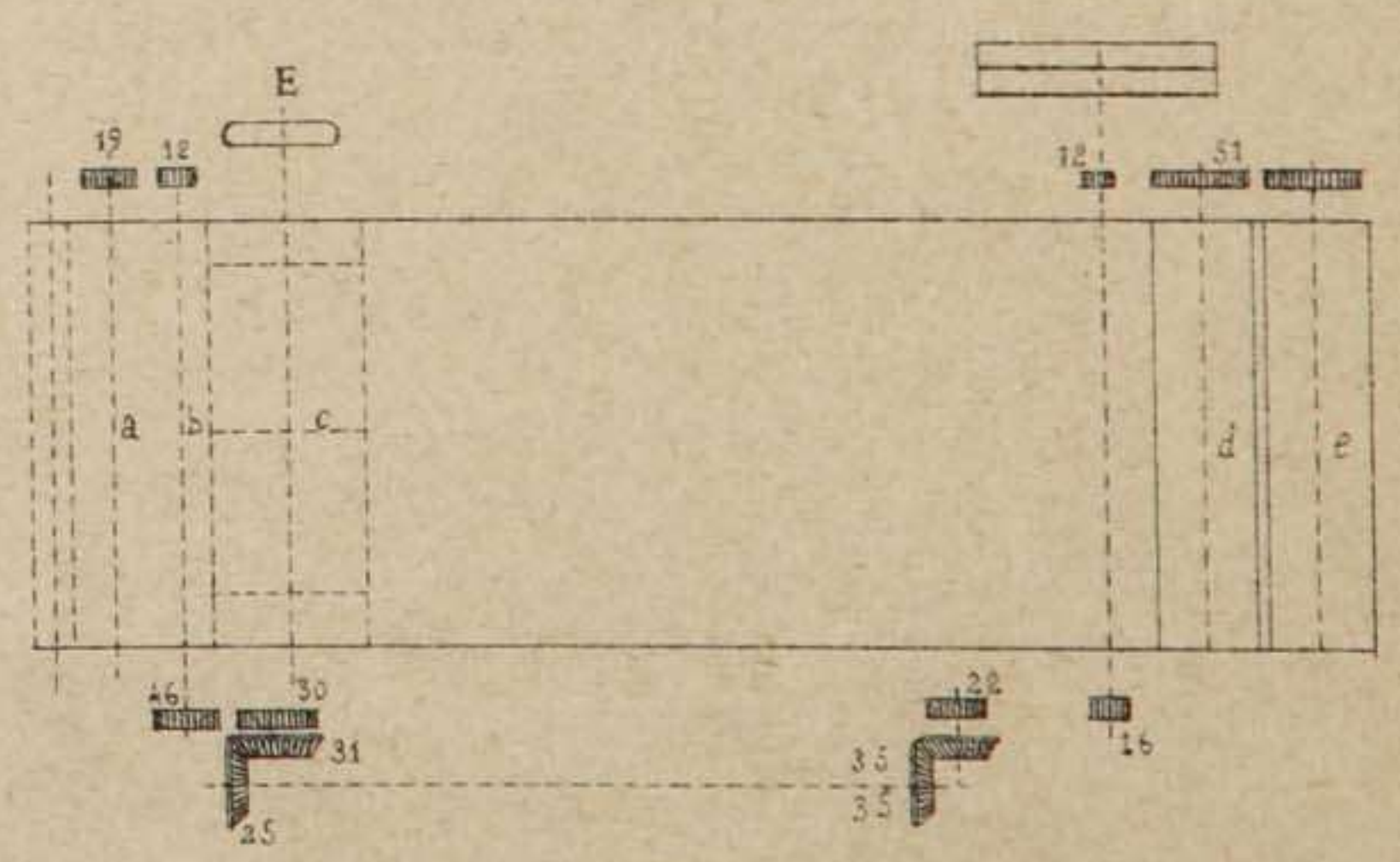


Fig. 36
P



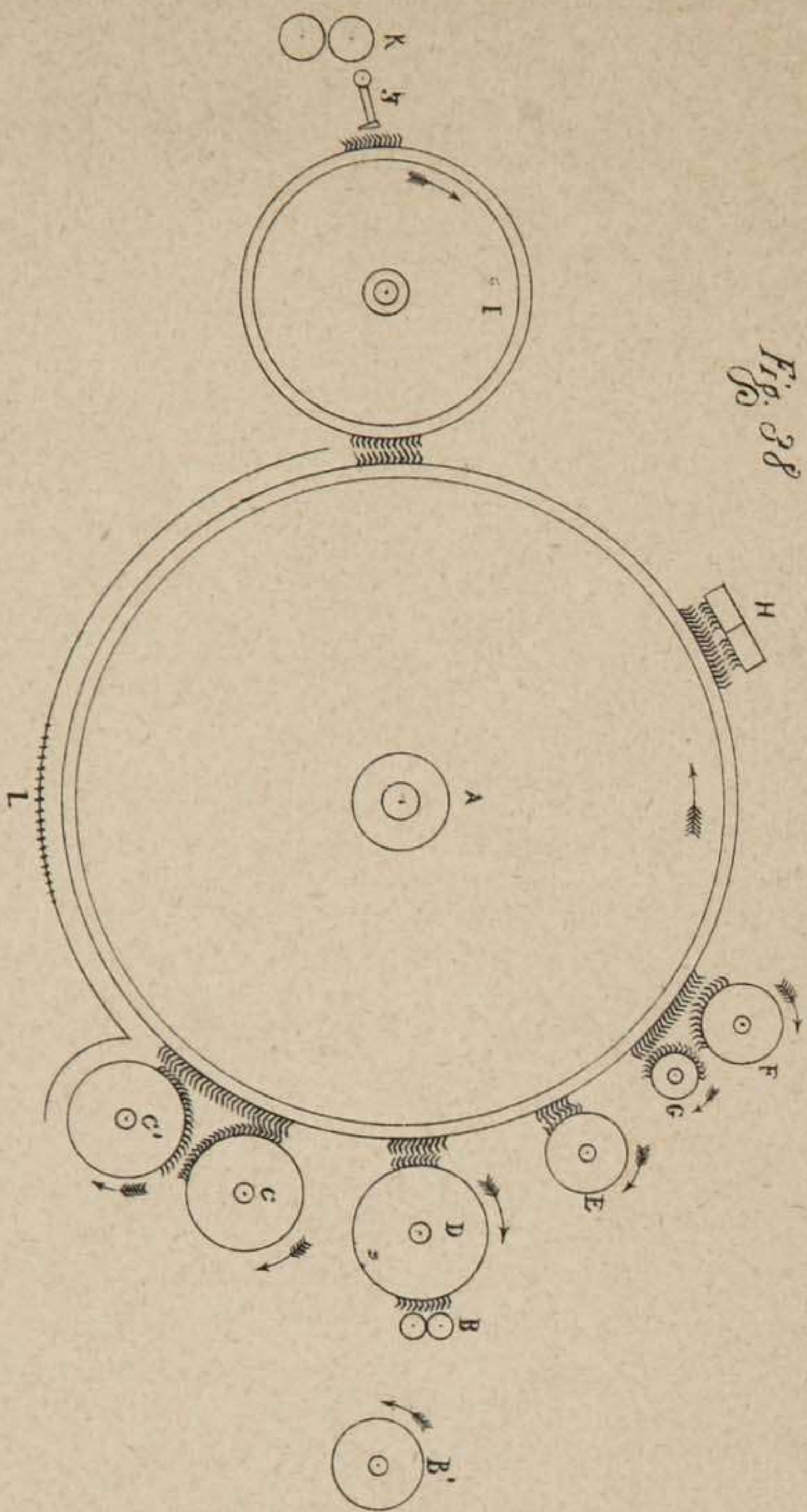


Fig. 38

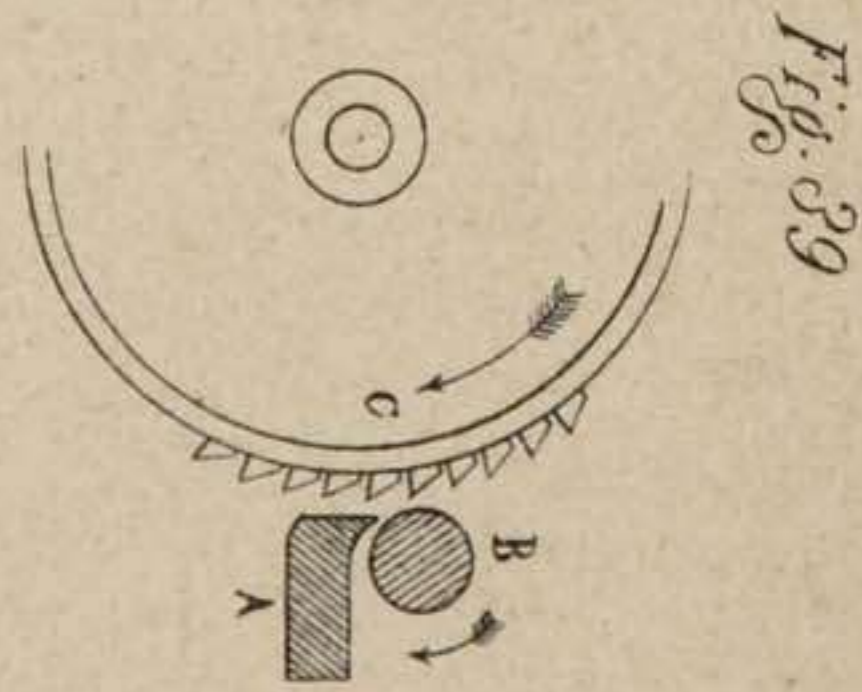


Fig. 39

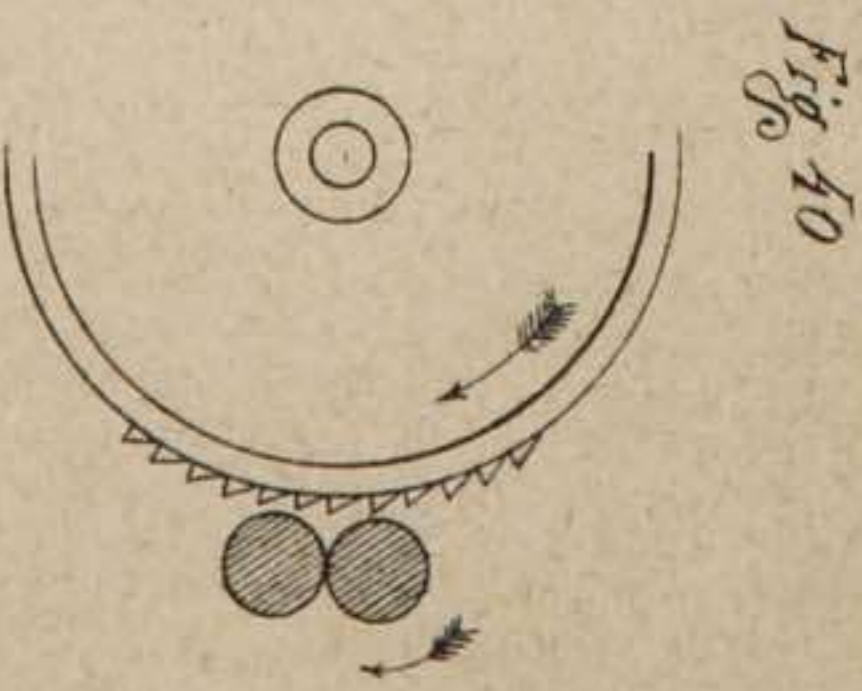


Fig. 40

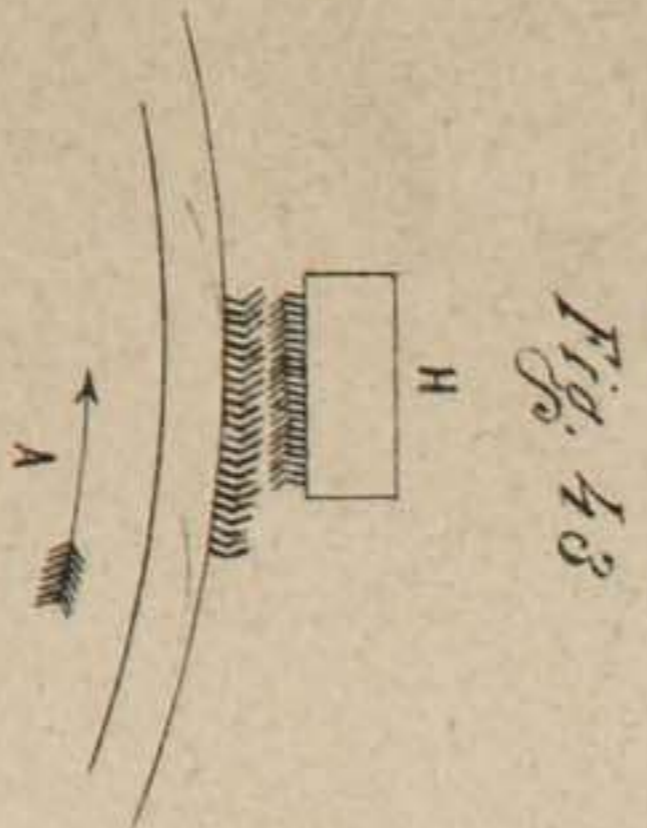


Fig. 43

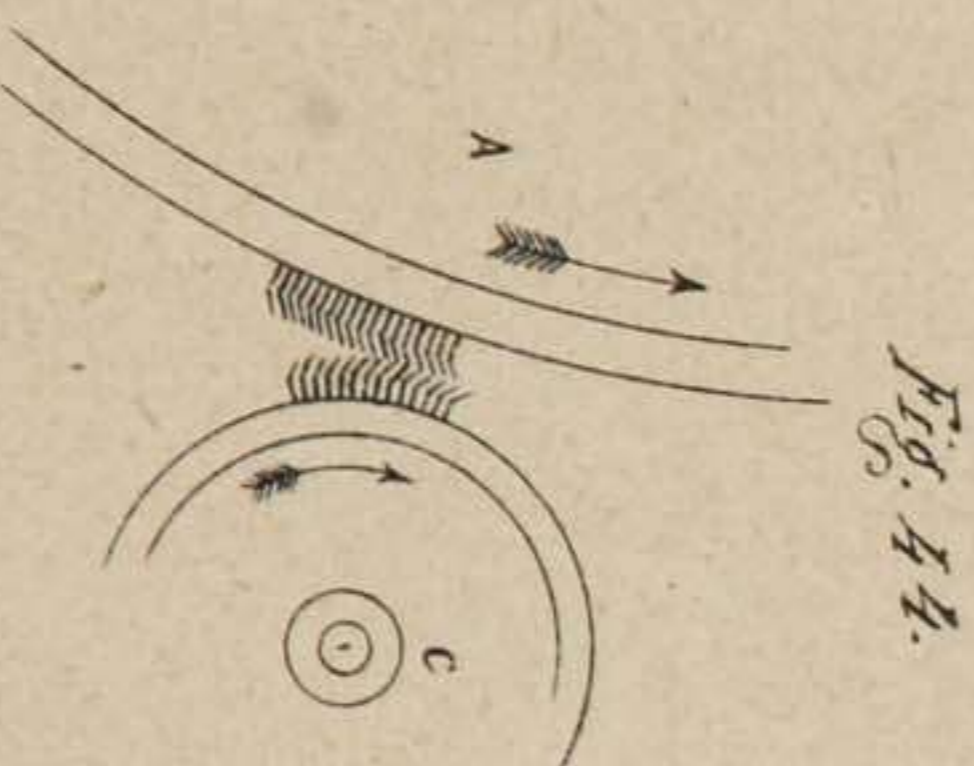


Fig. 44

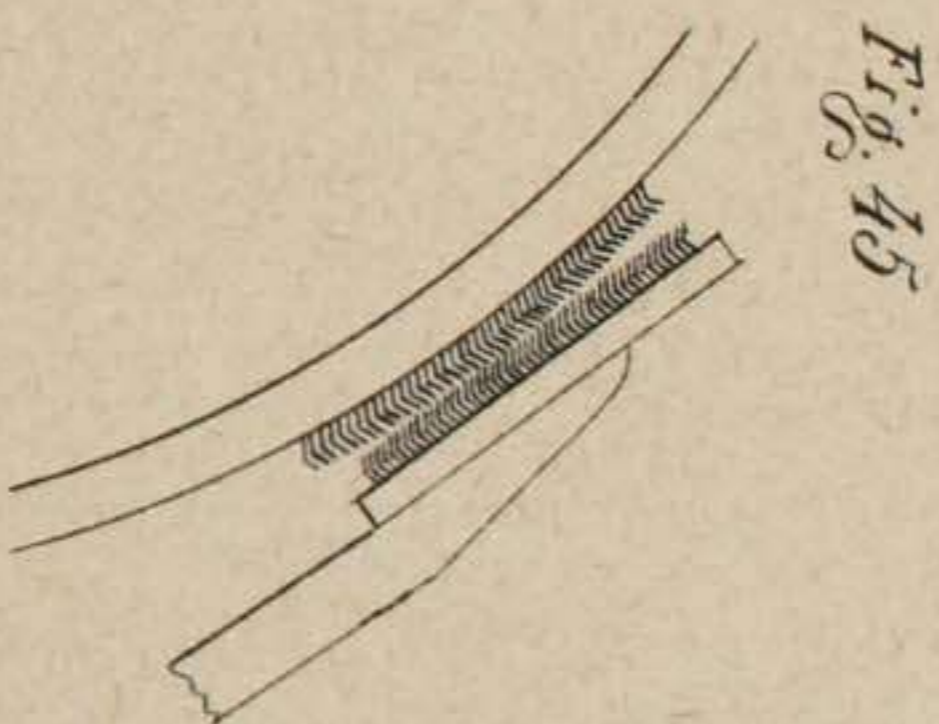


Fig. 45

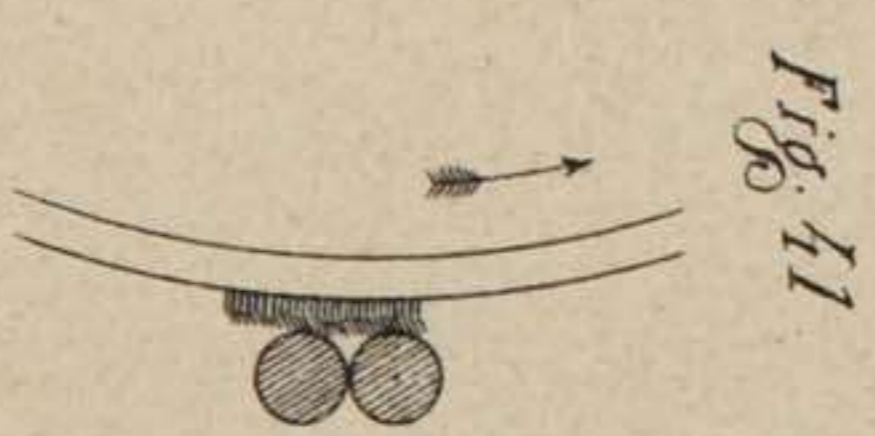


Fig. 41

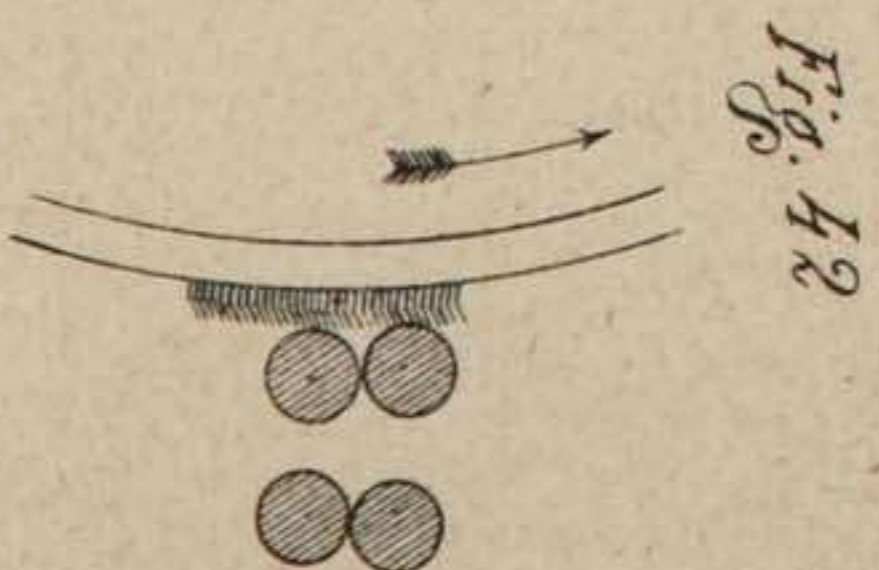


Fig. 42

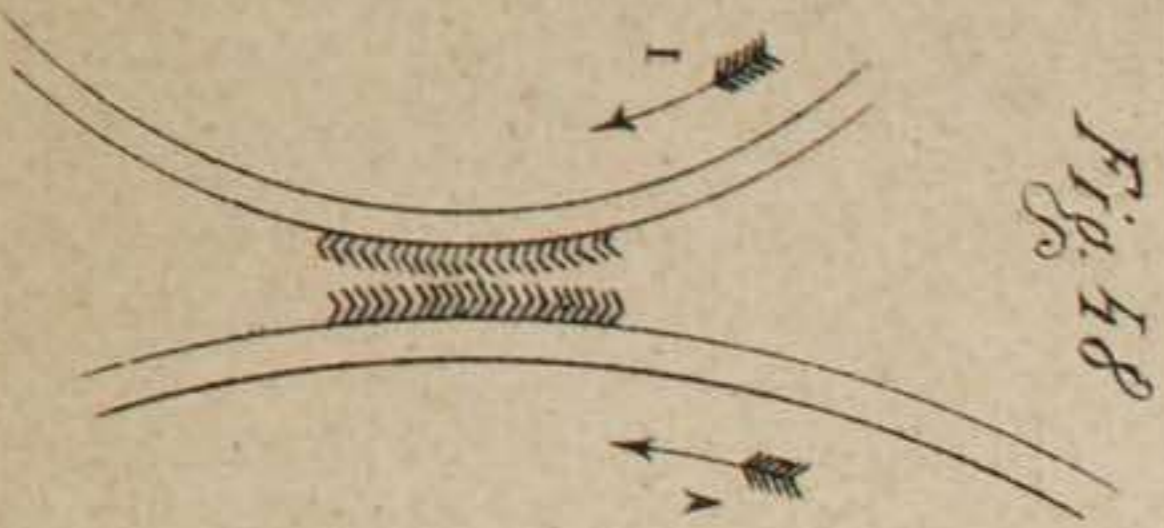


Fig. 48

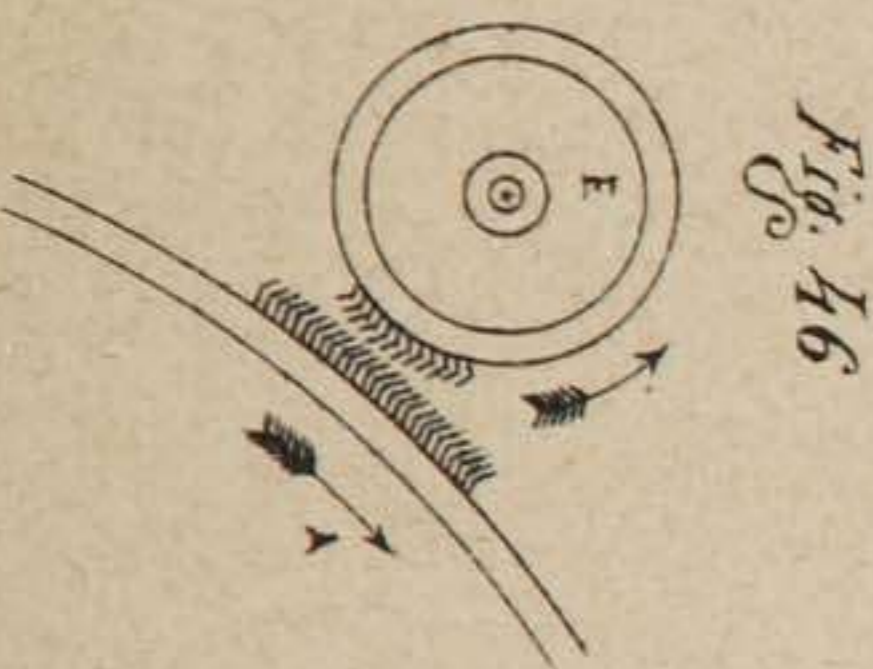


Fig. 46

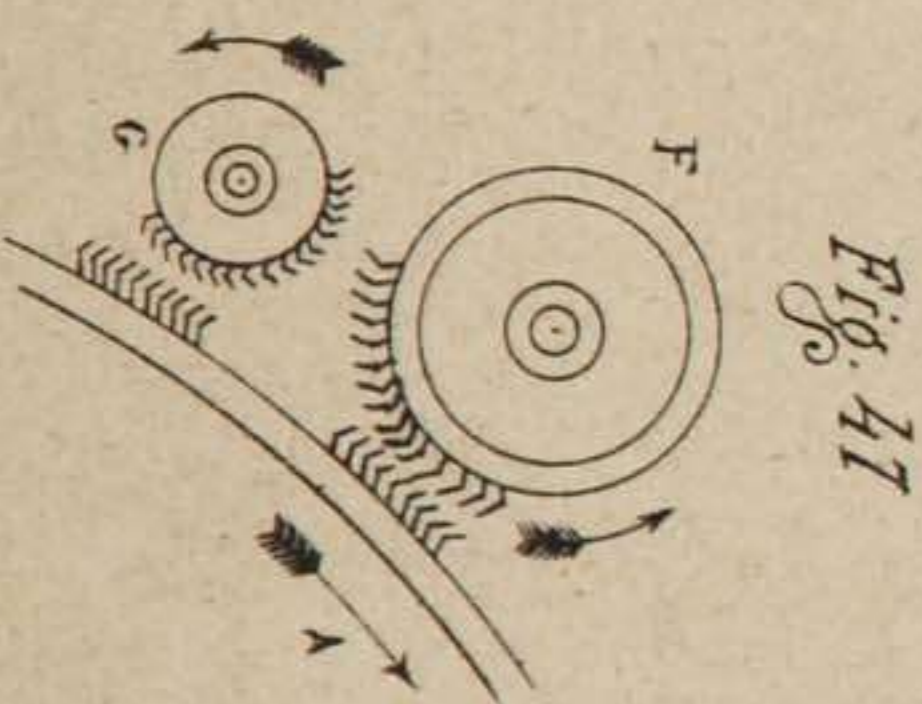


Fig. 47



Fig. 49

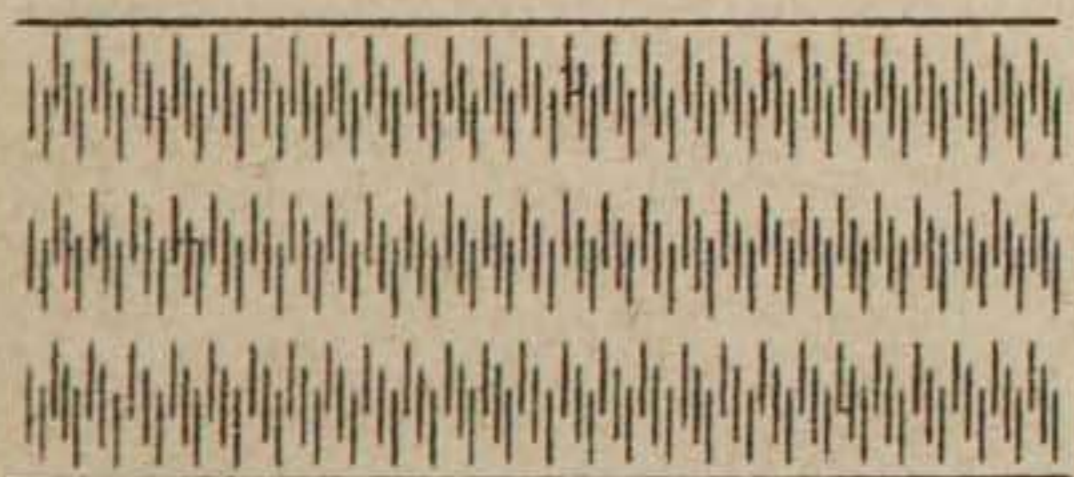


Fig. 50

Fig. 51.

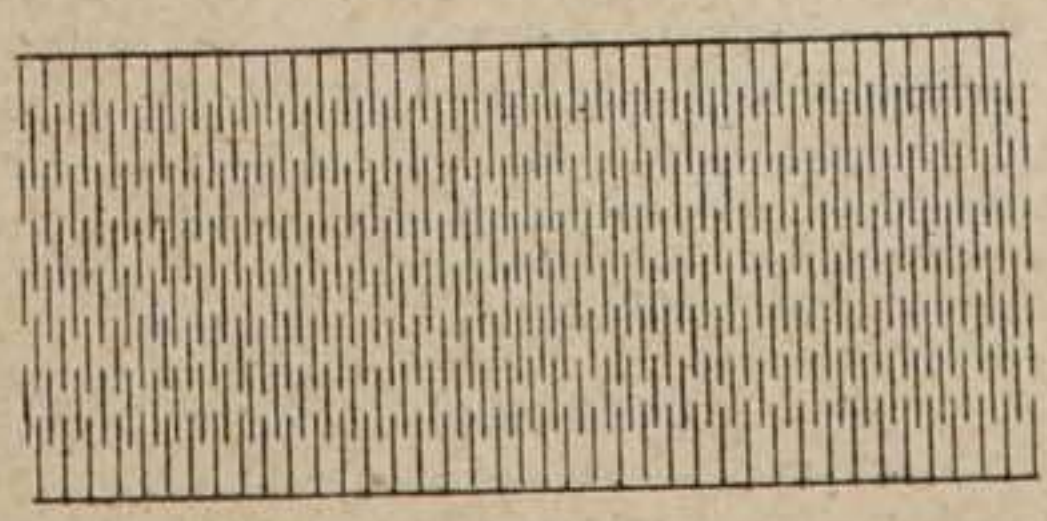


Fig. 52.

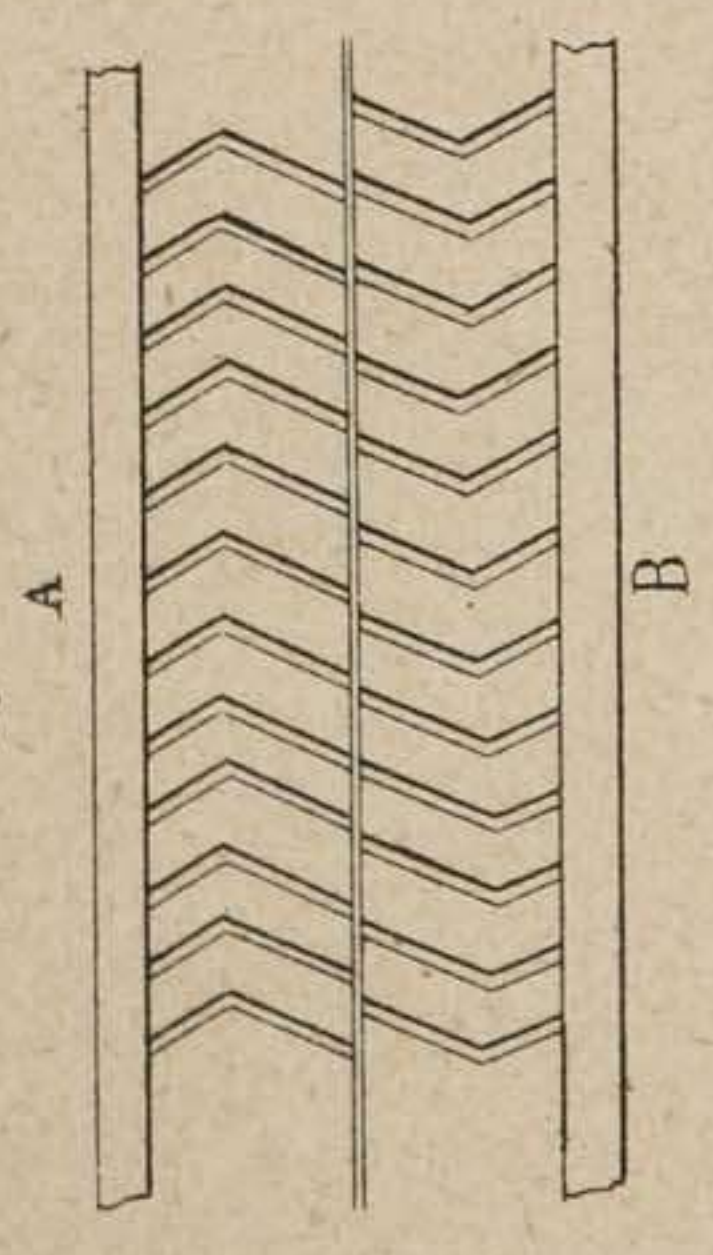


Fig. 57.

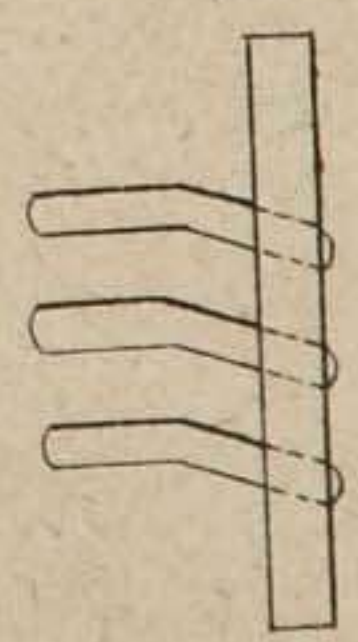


Fig. 55.

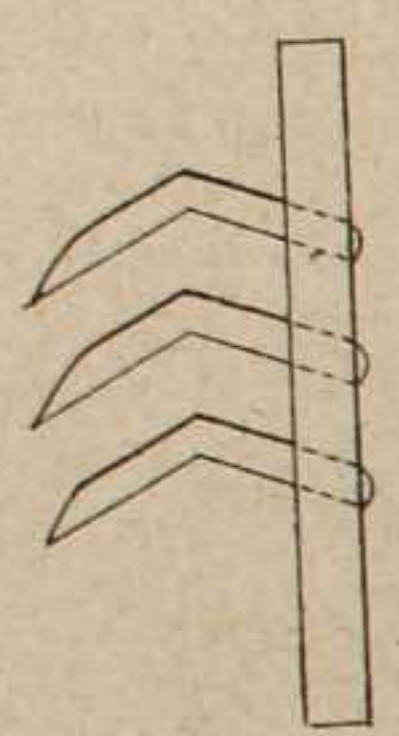


Fig. 56.

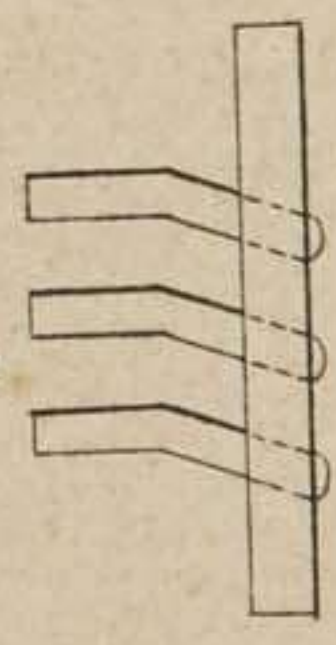


Fig. 59.



Fig. 60.



Fig. 61.

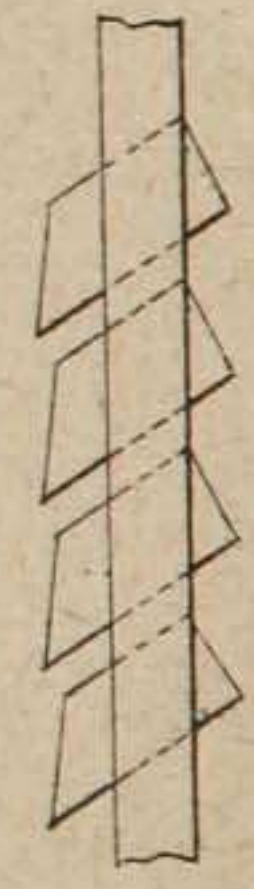


Fig. 58.

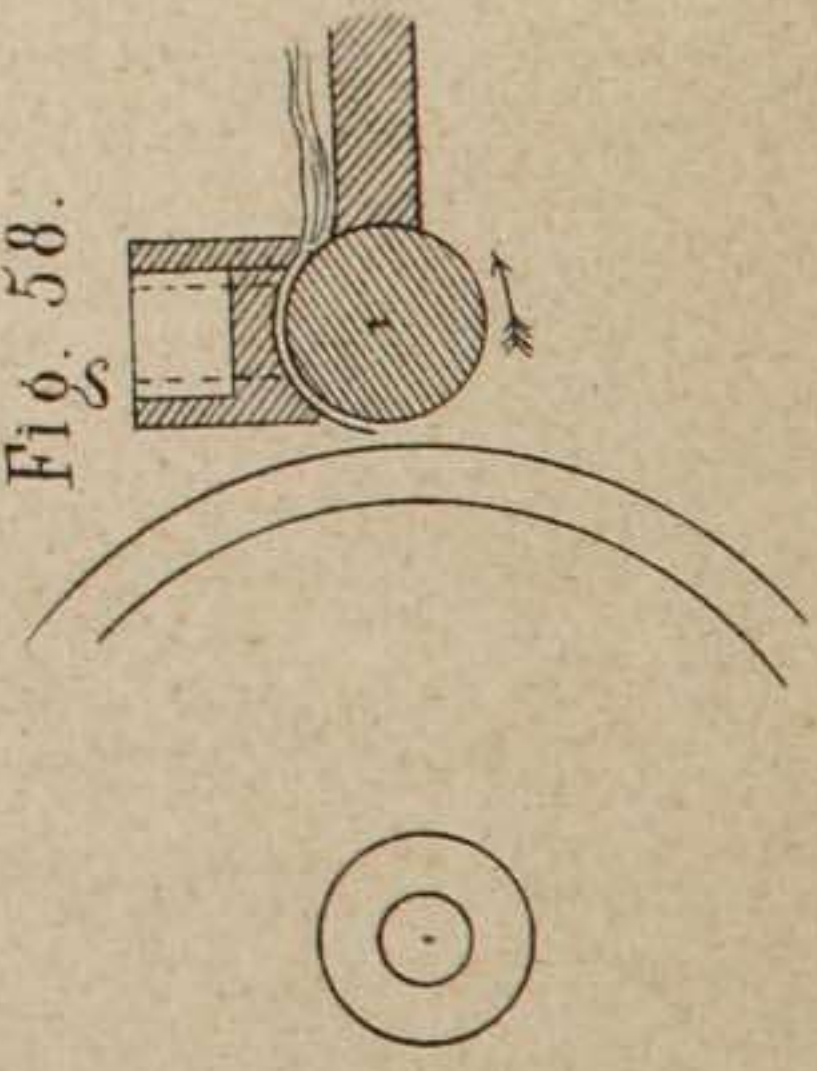


Fig. 53.

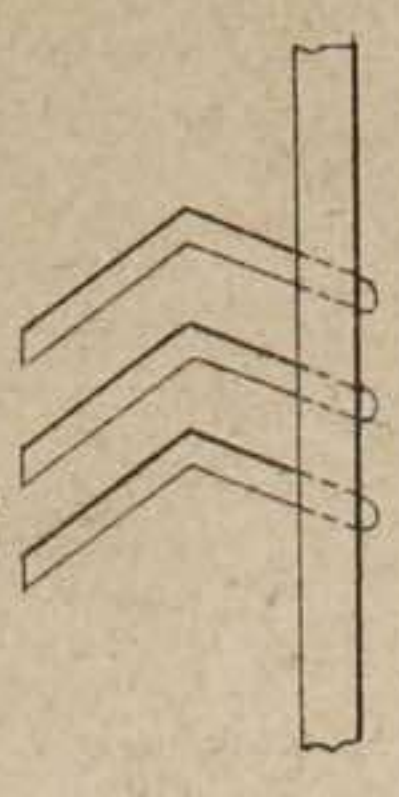


Fig. 54.

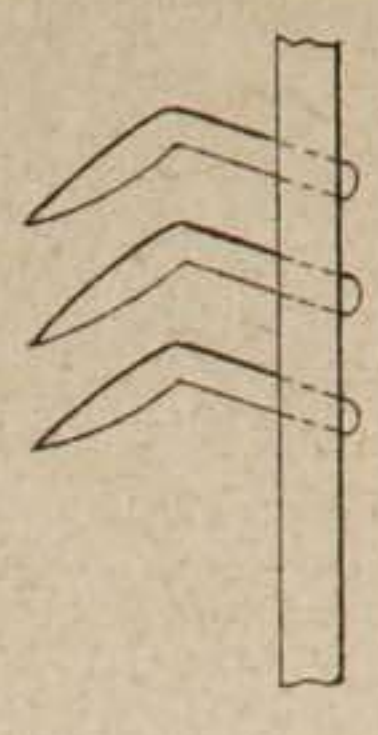


Fig. 63.

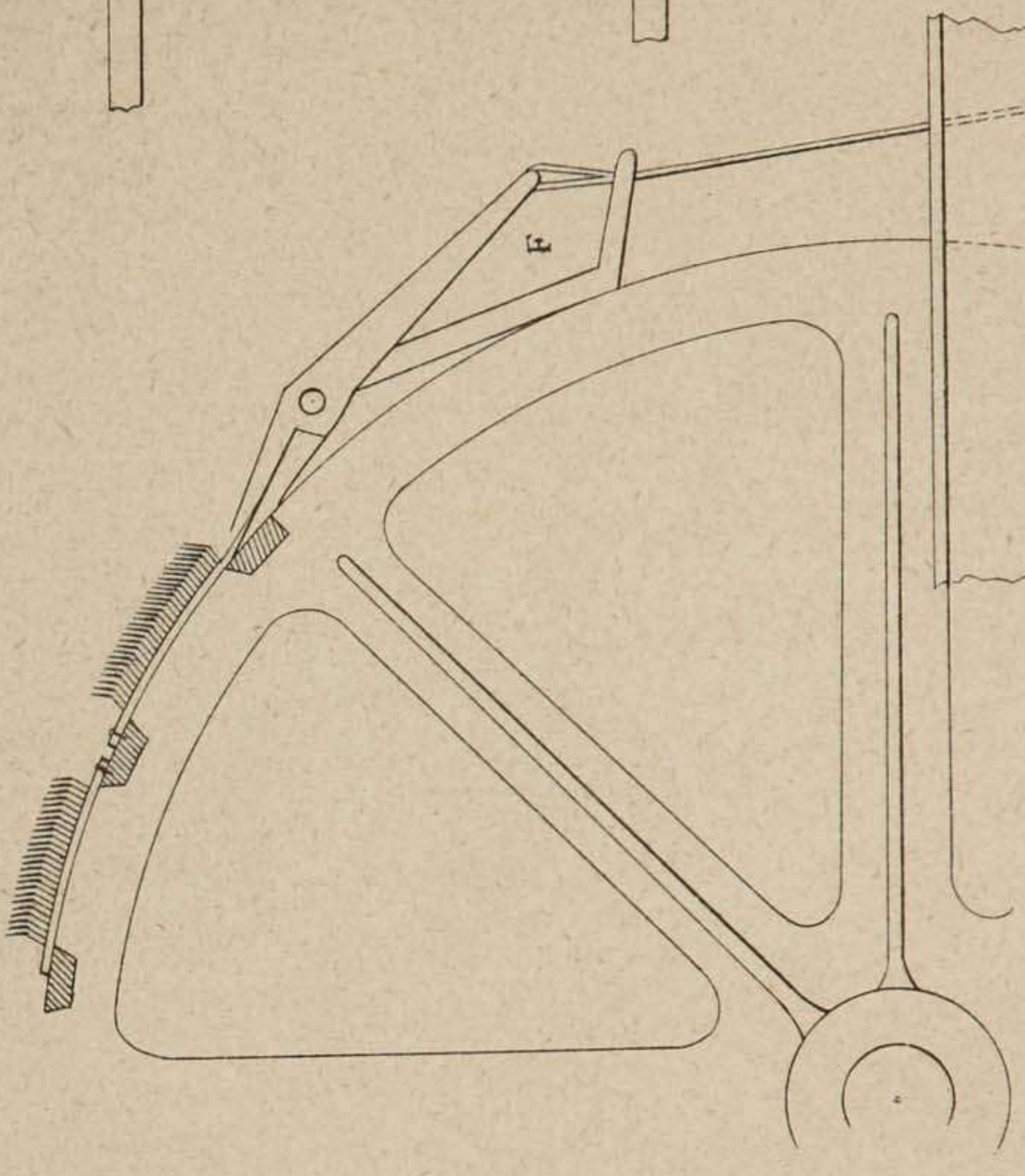


Fig. 62.

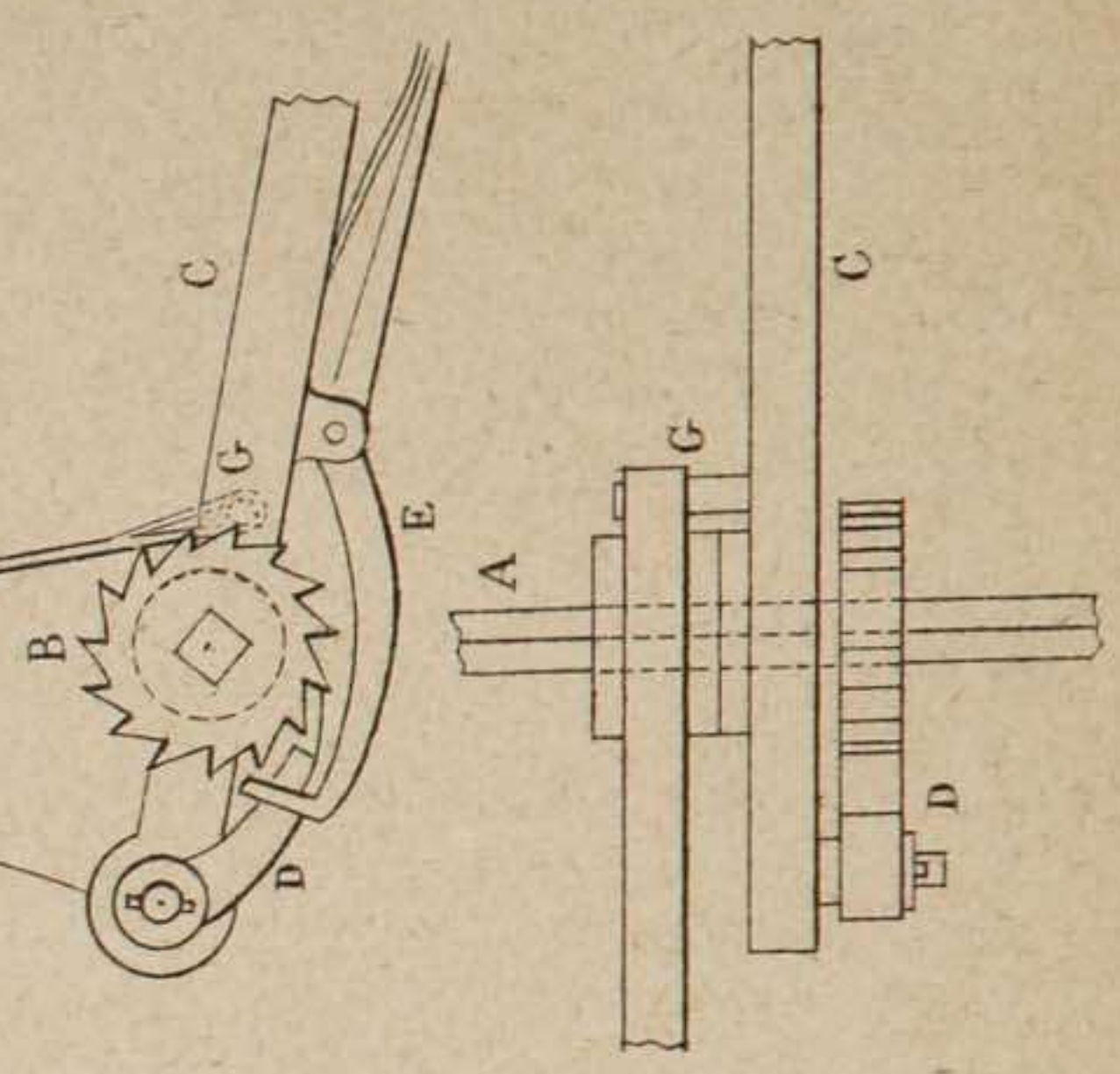
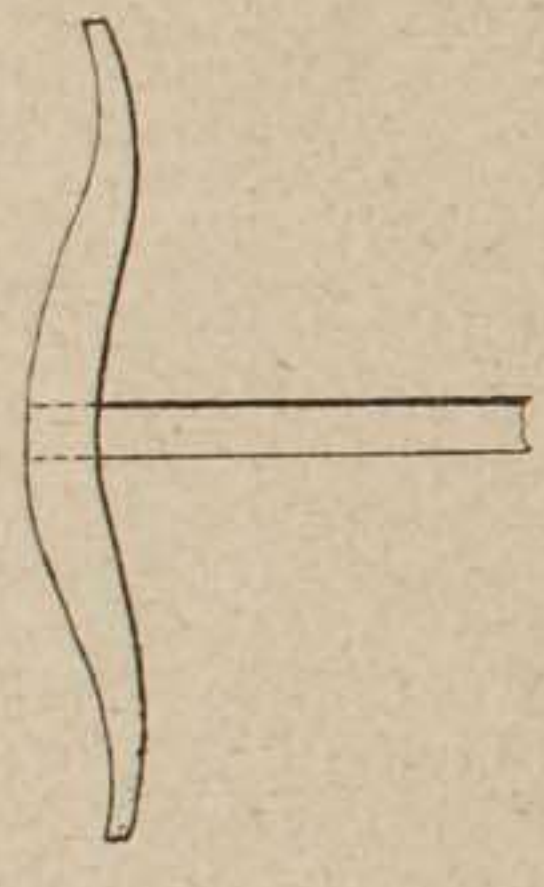


Fig. 64.

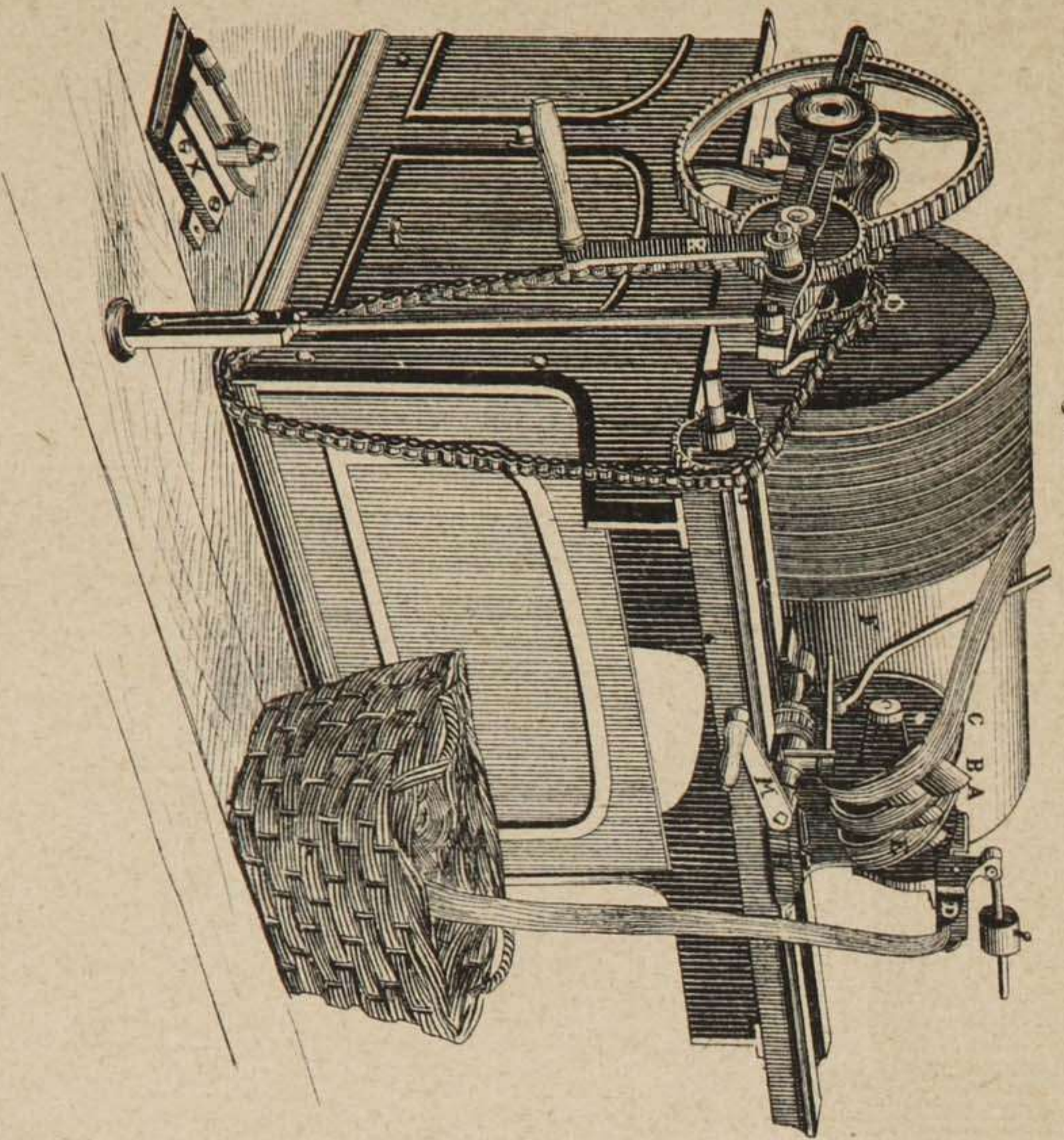


Fig. 65.



Fig. 69.

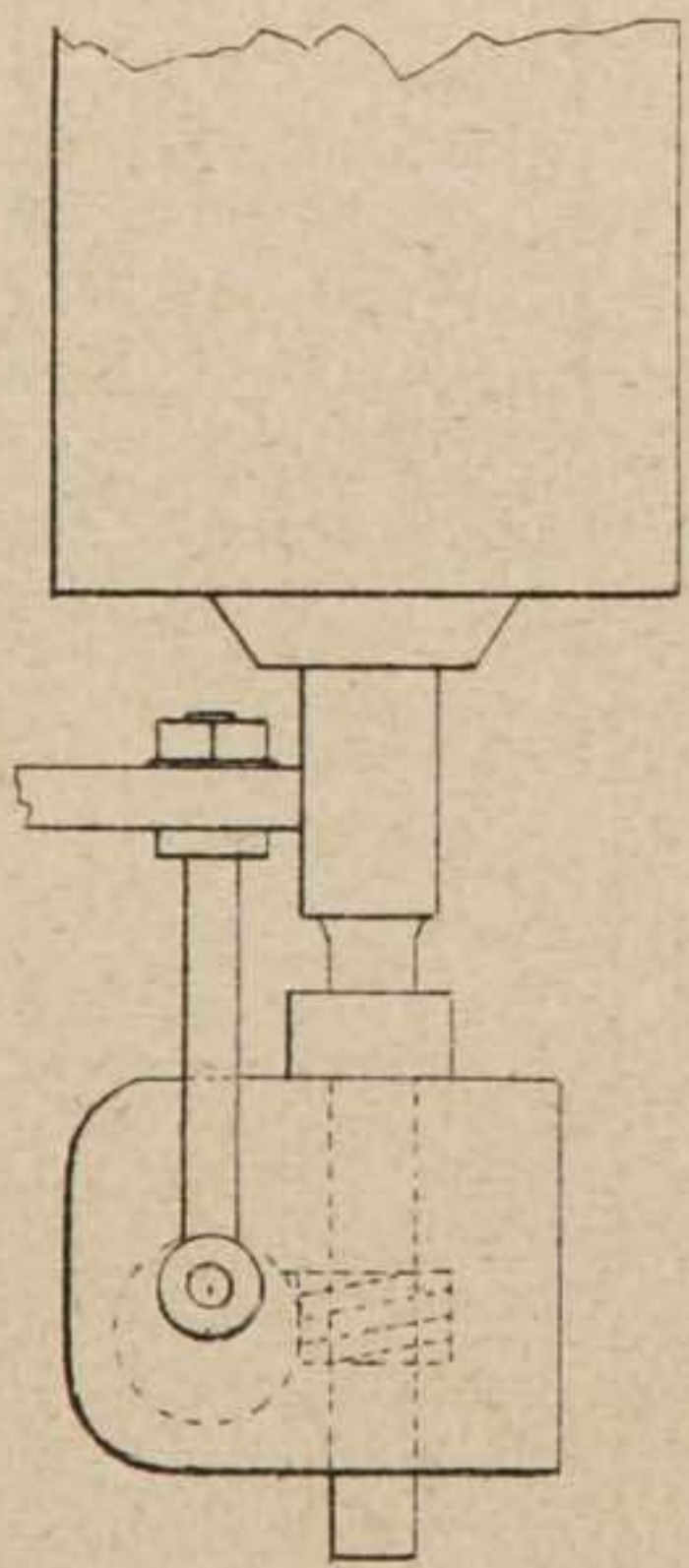


Fig. 68.

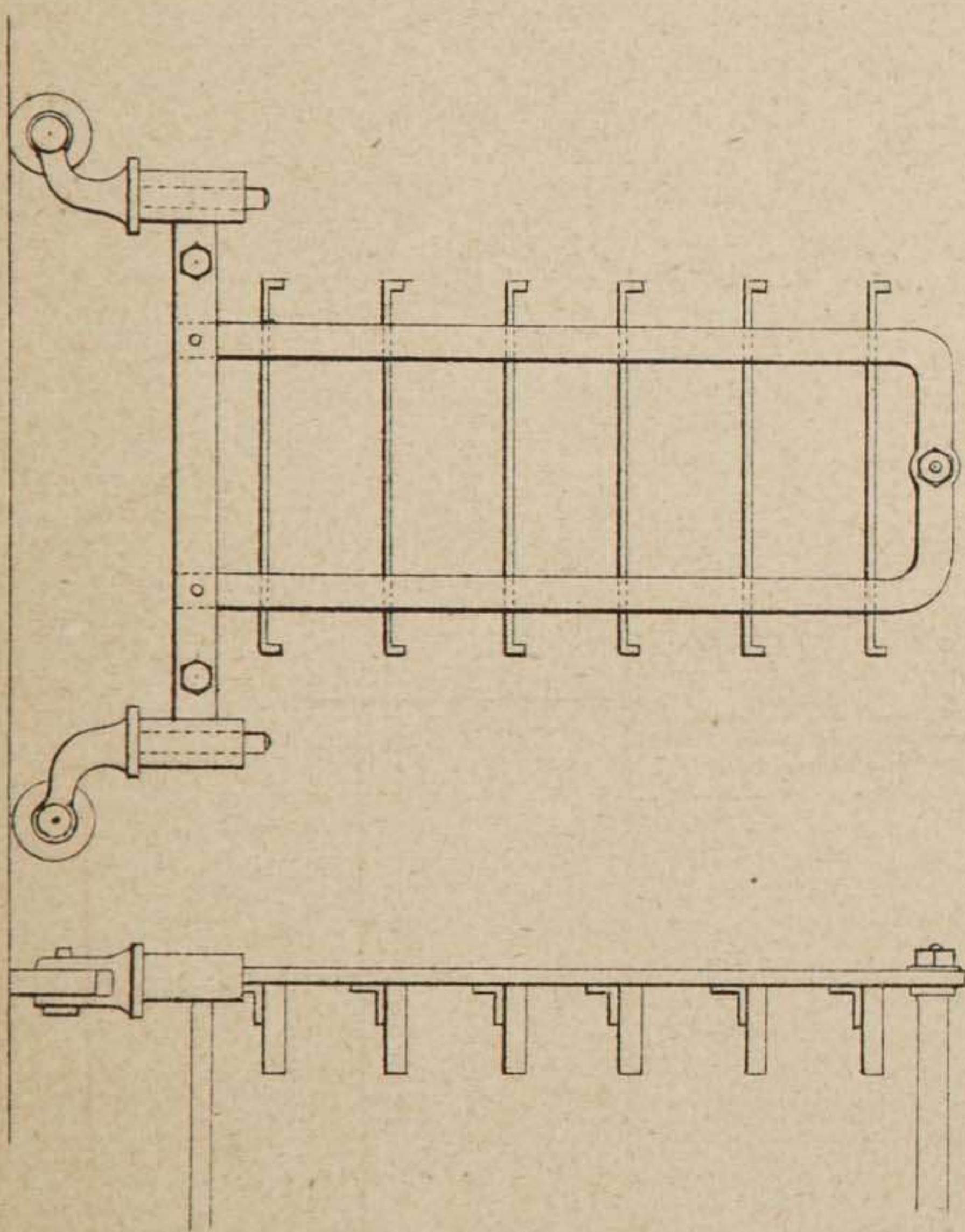


Fig. 66.

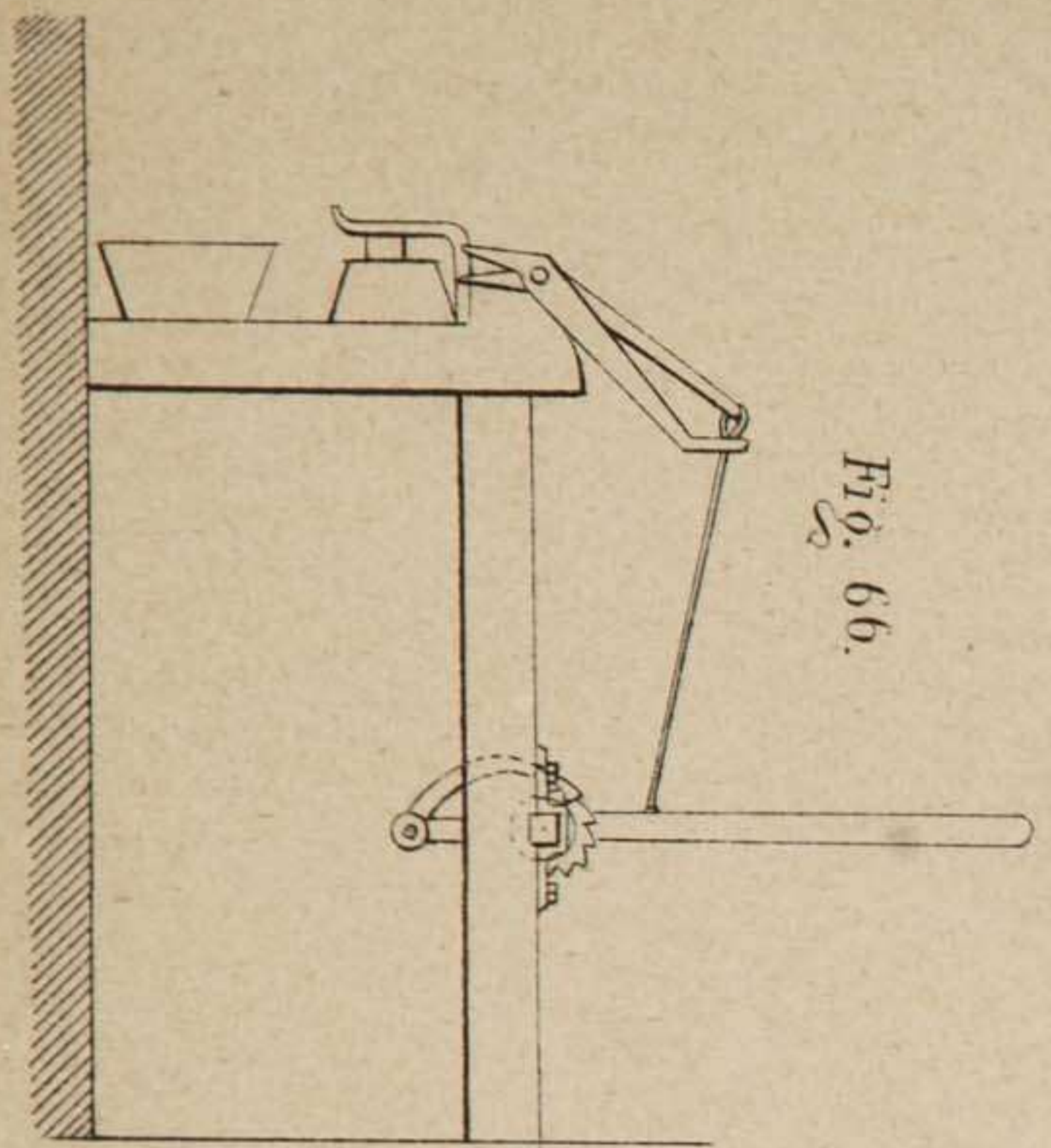


Fig. 67.

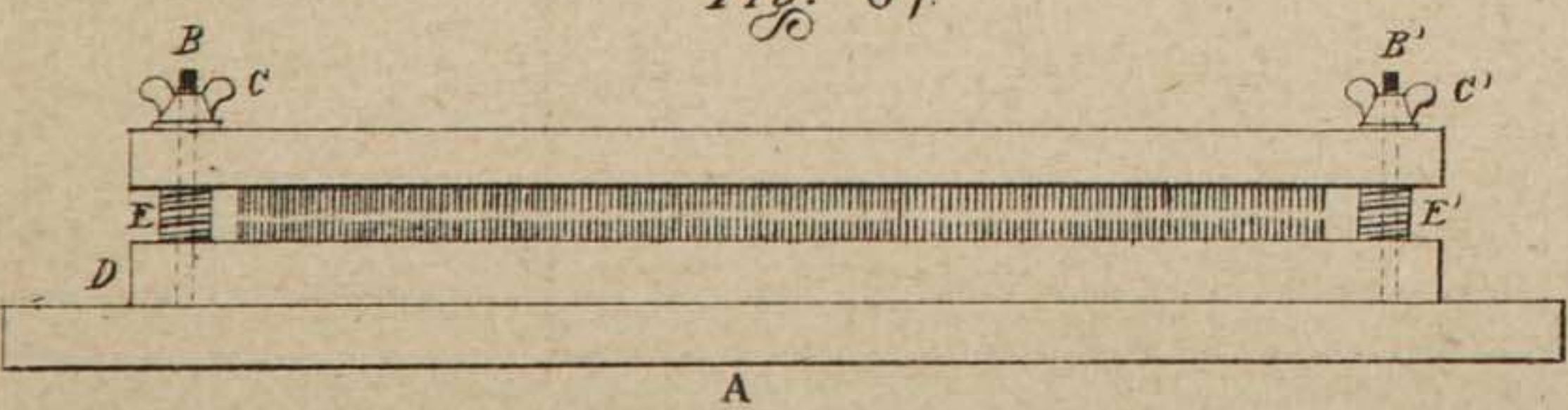


Fig. 70.

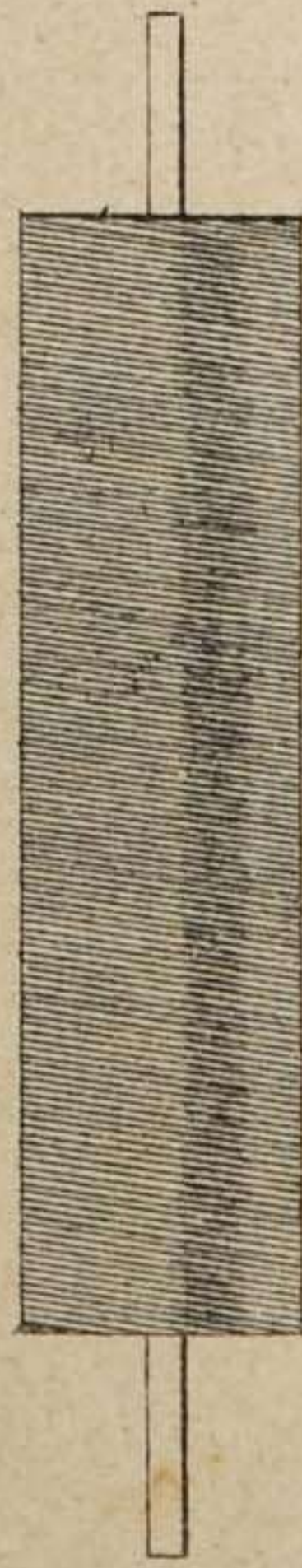


Fig. 76.

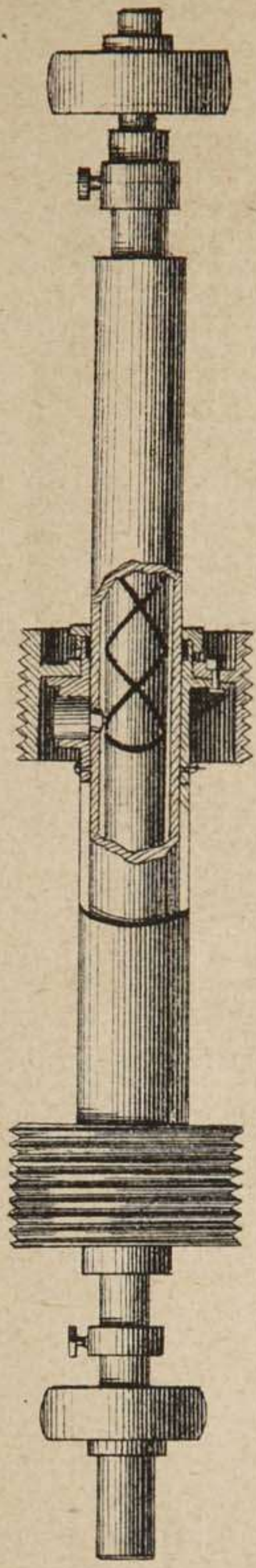


Fig. 72.

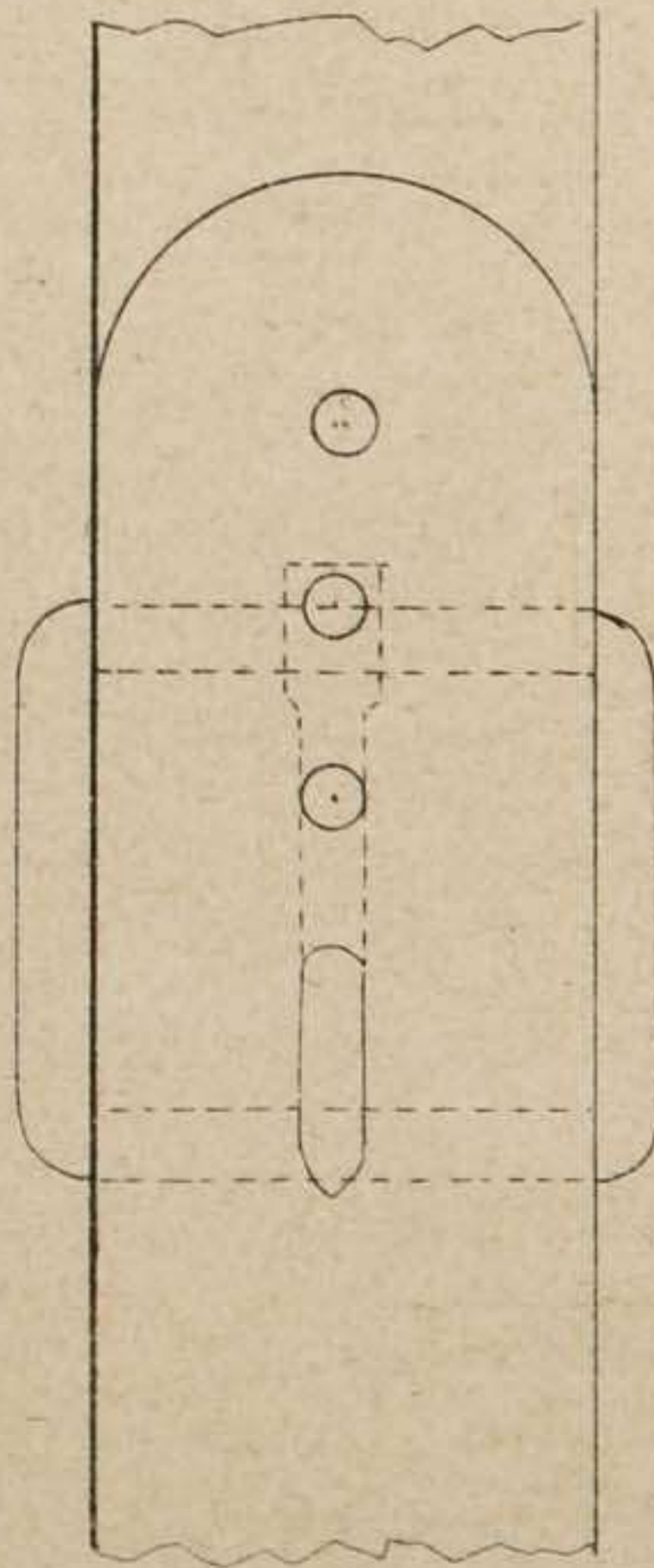


Fig. 73.

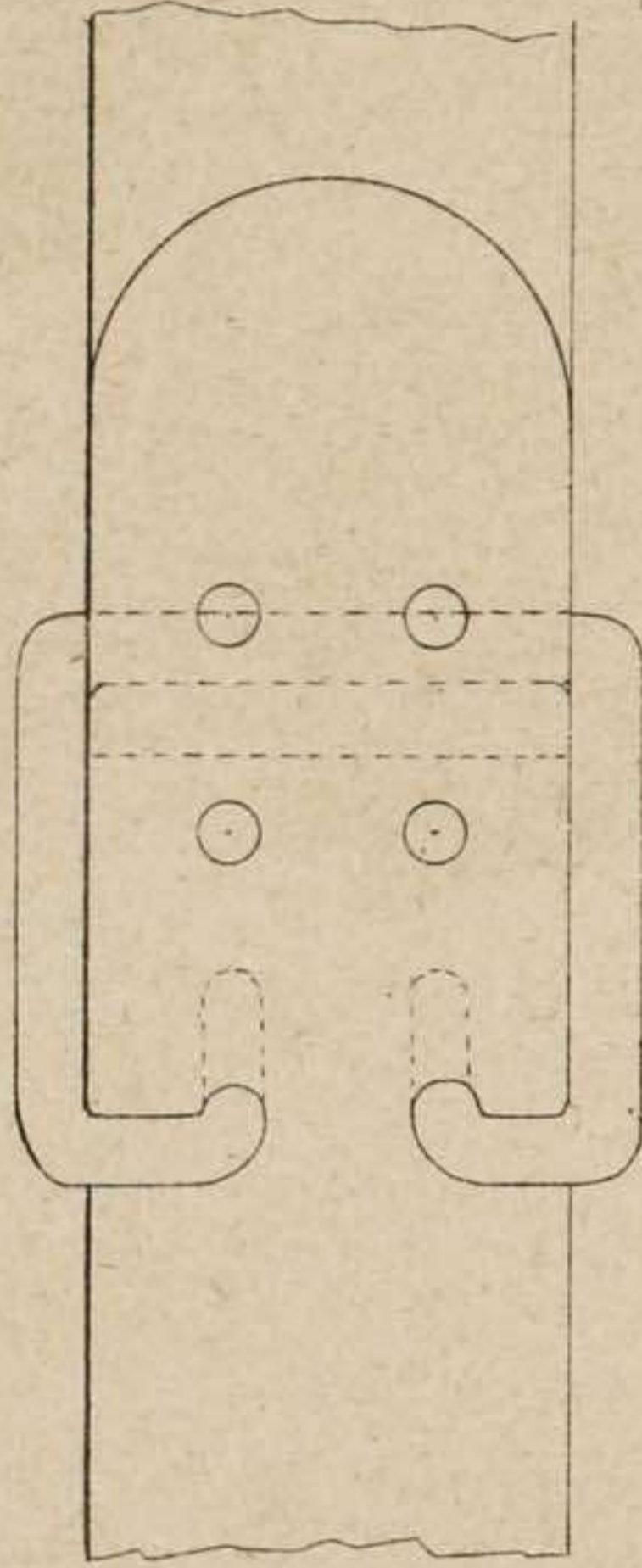


Fig. 75.

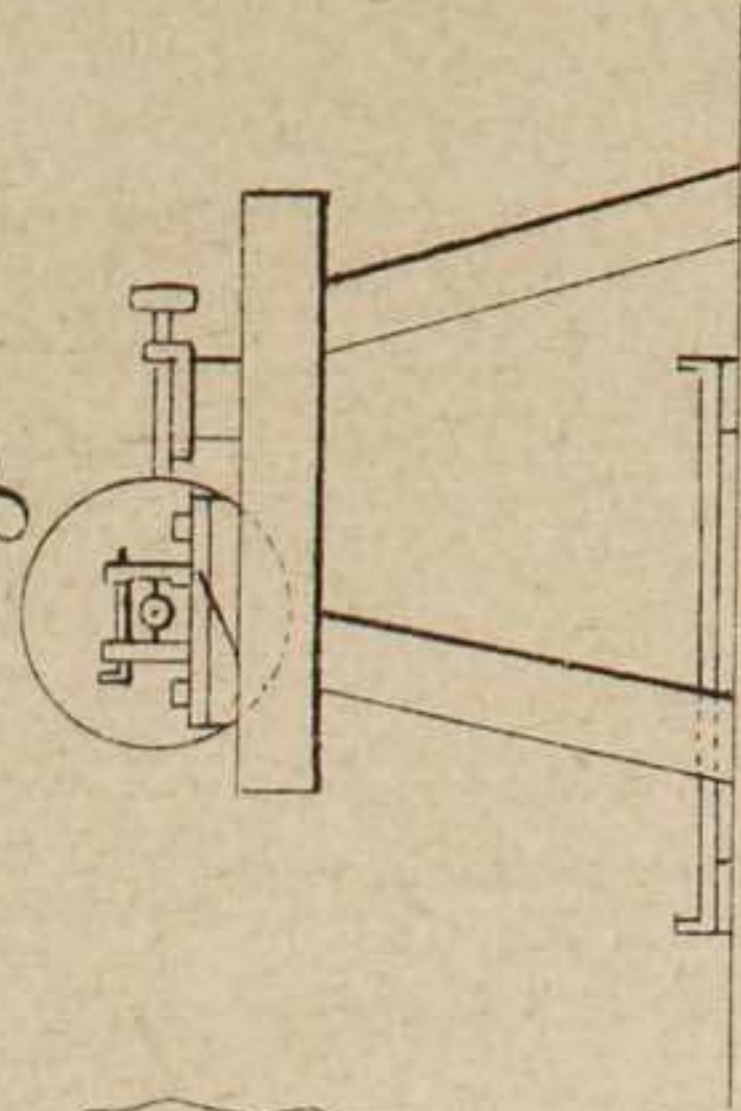


Fig. 74.

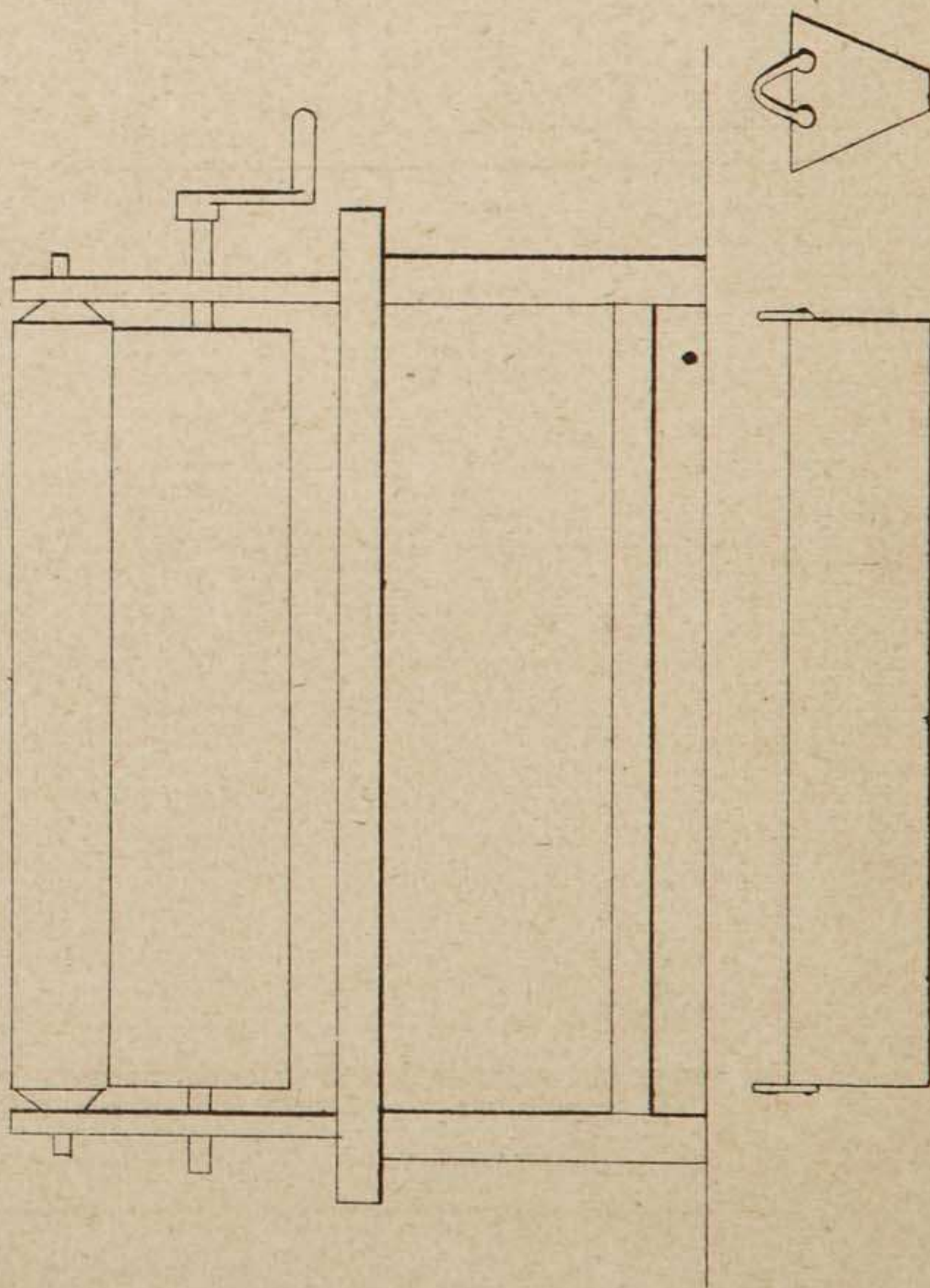
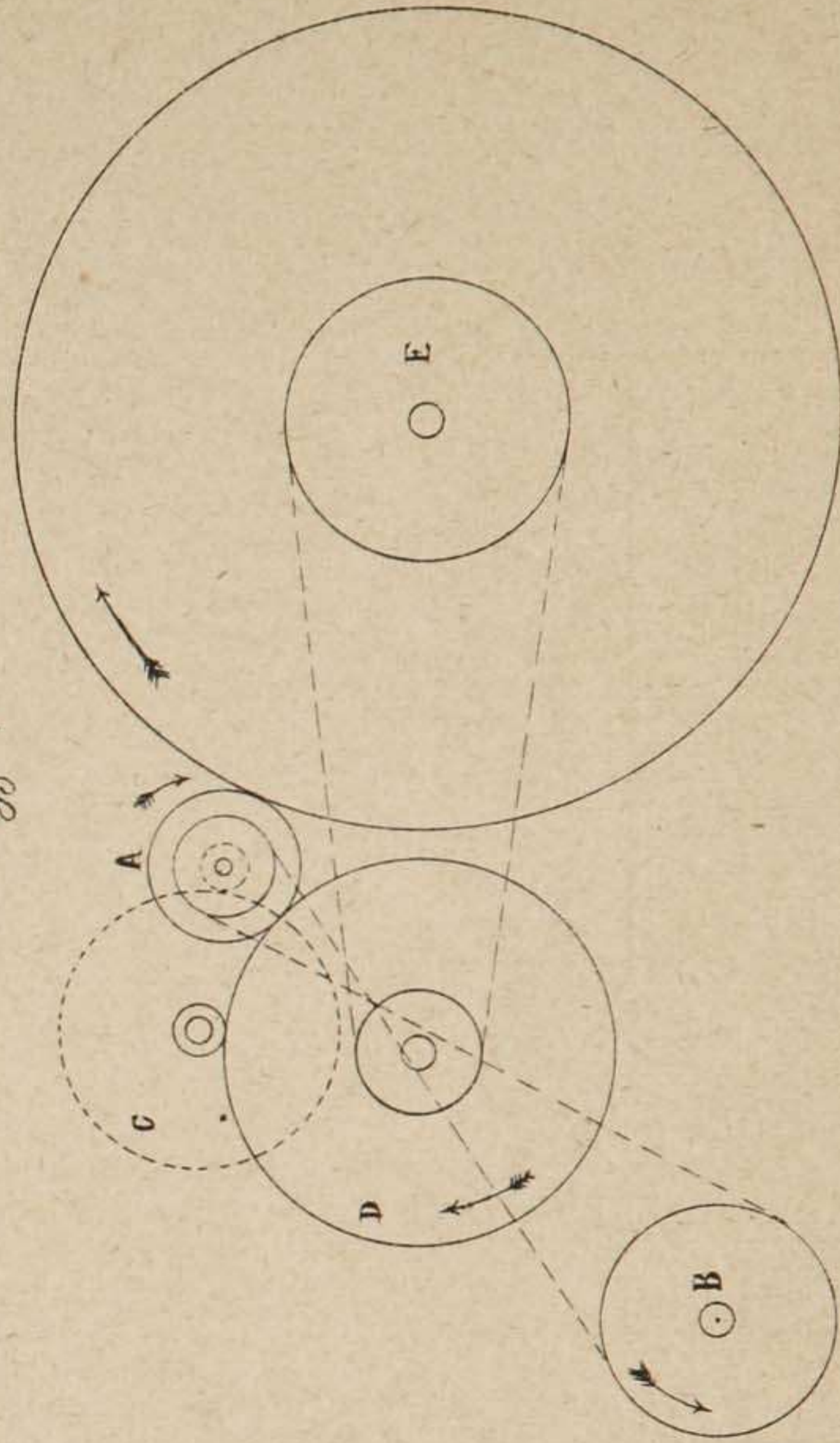


Fig. 71.



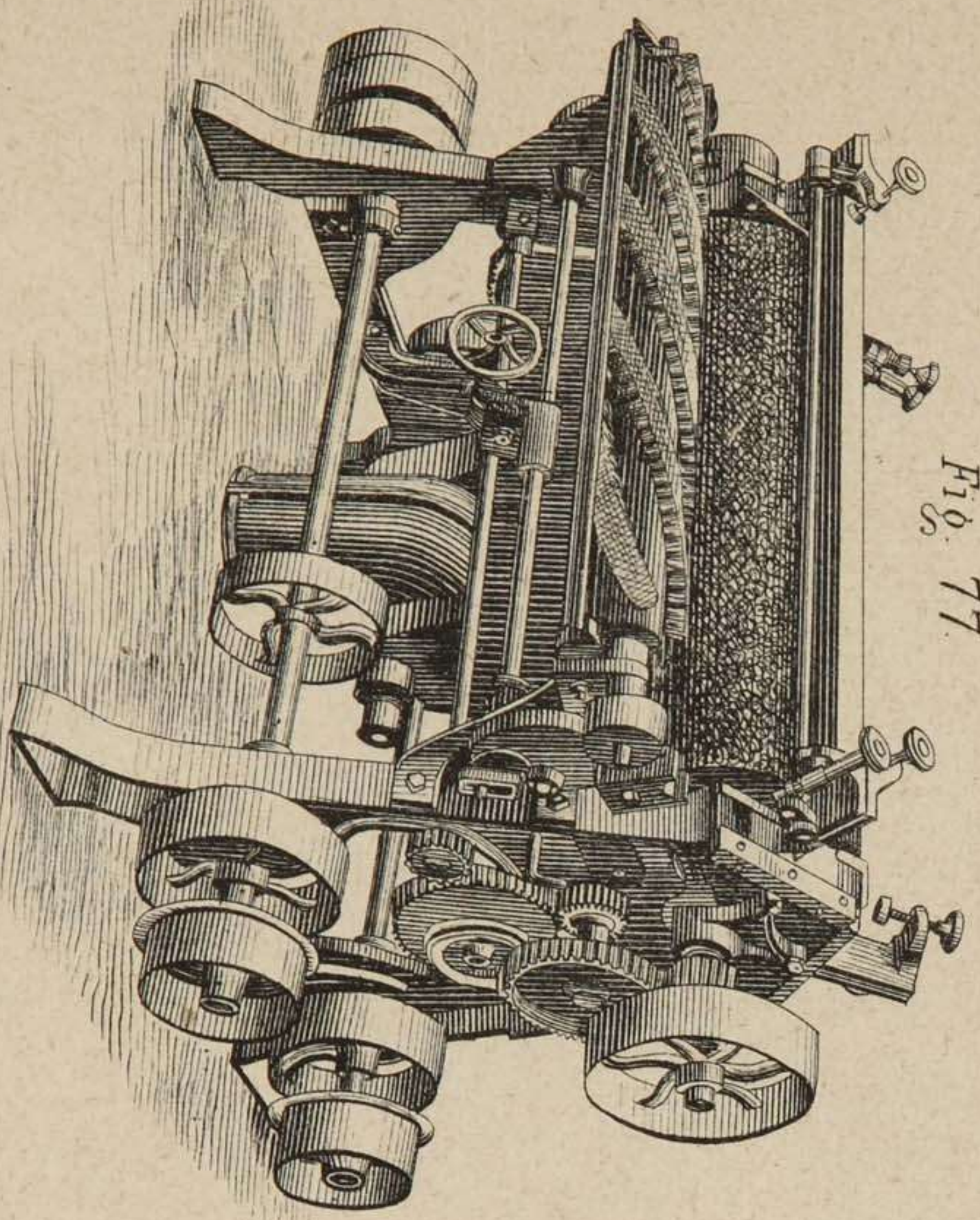


Fig. 77.

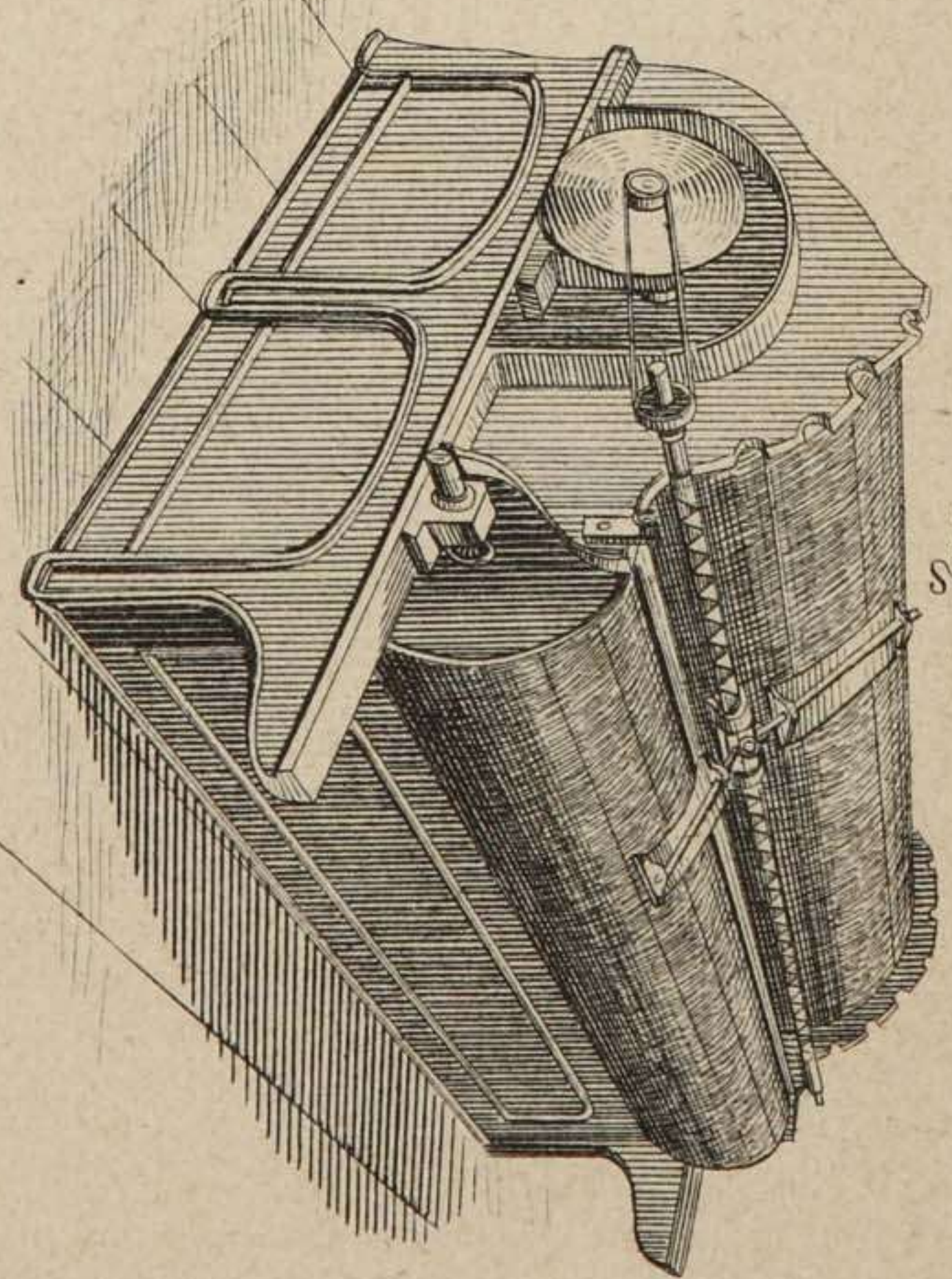


Fig. 80.

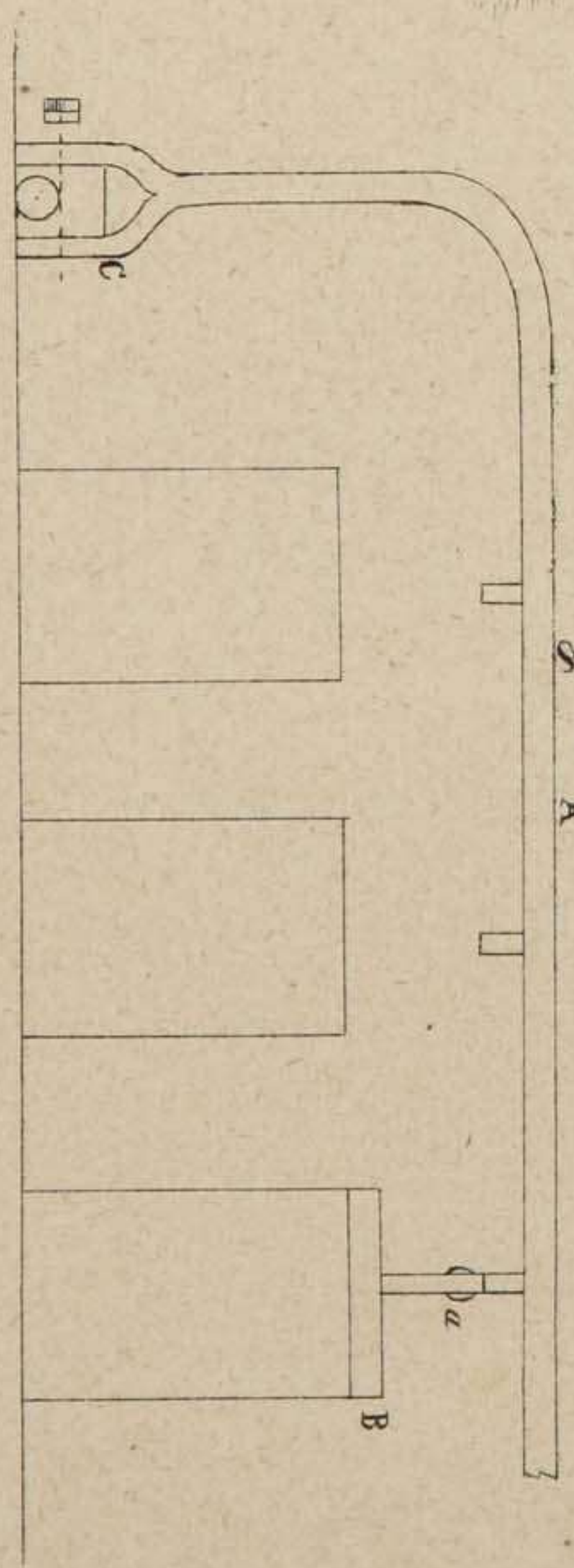


Fig. 81 A

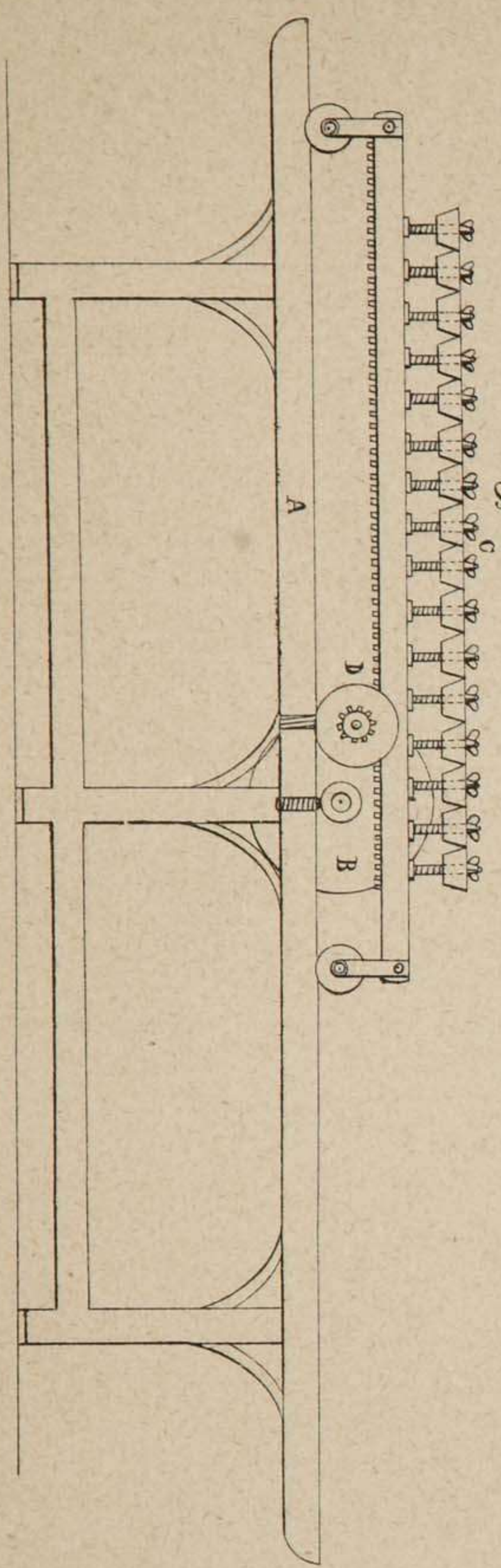


Fig. 78.

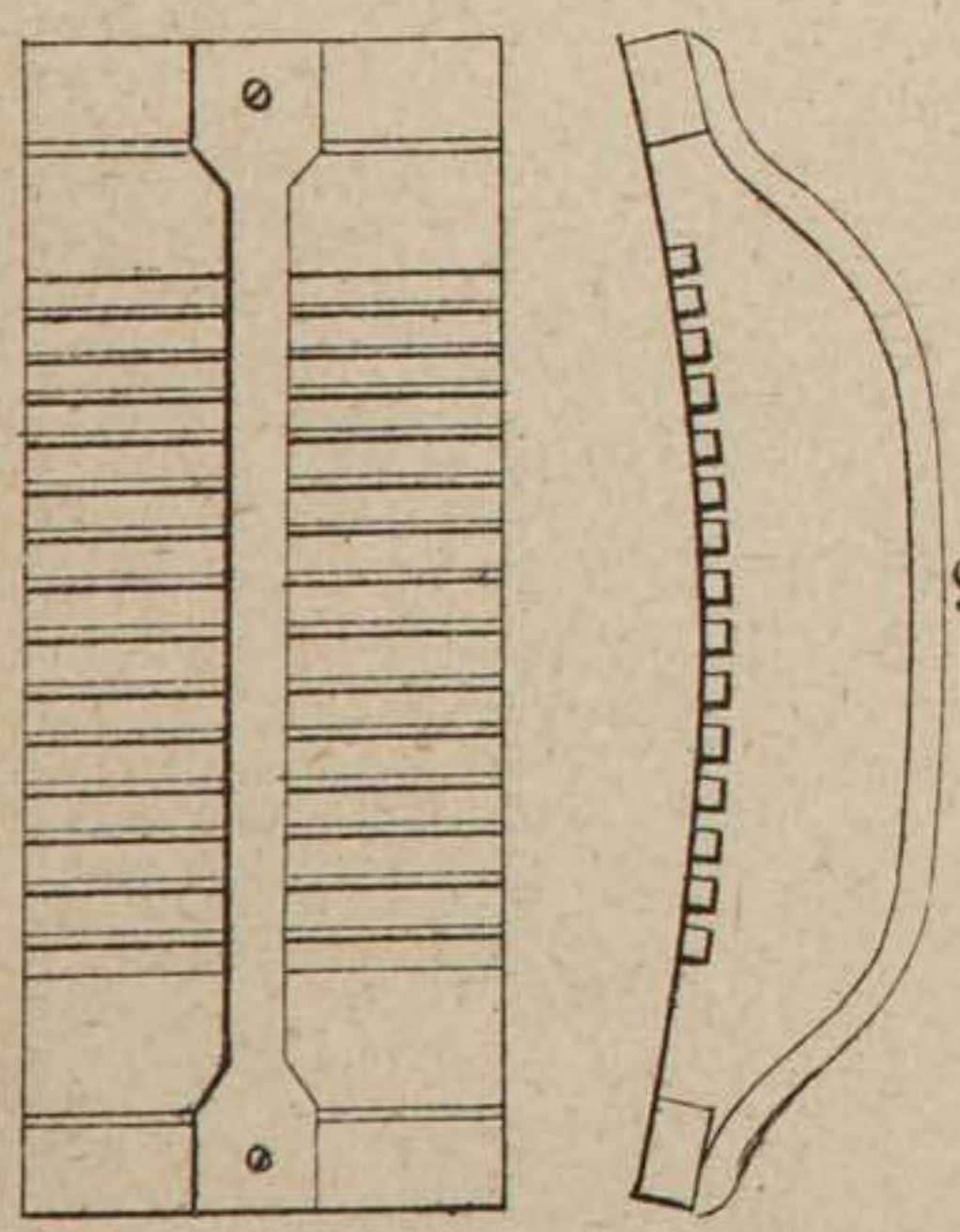


Fig. 79.

828

Fig. 82.

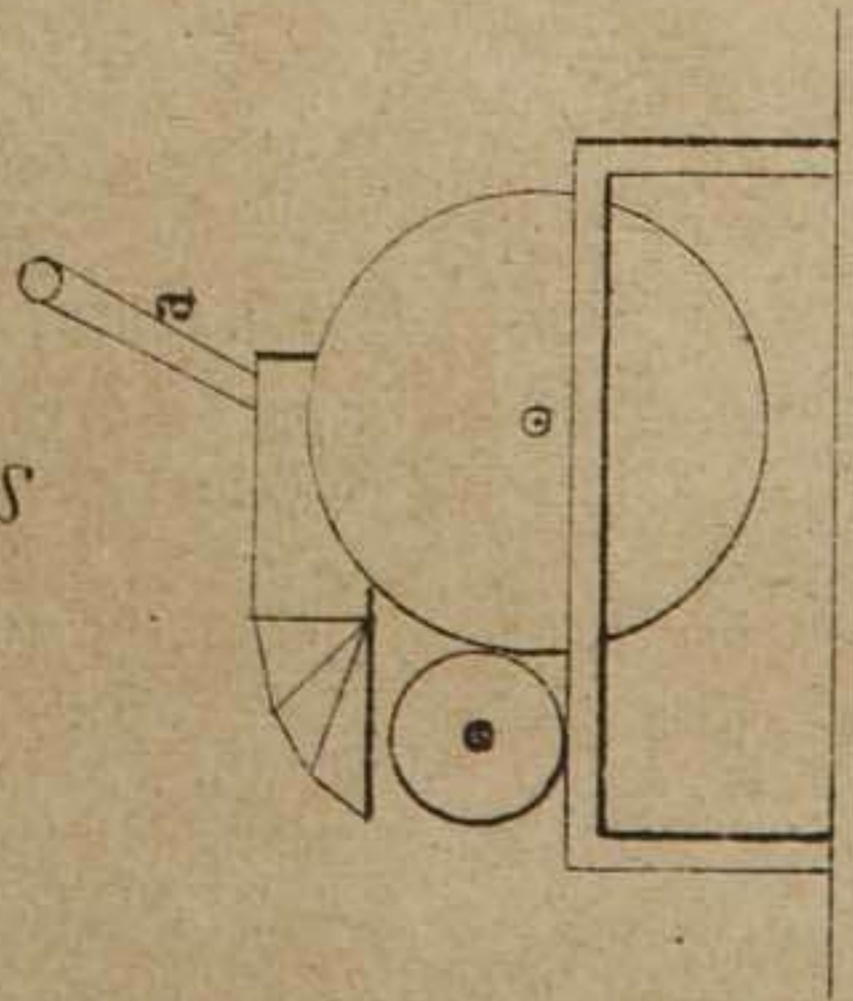


Fig. 83.

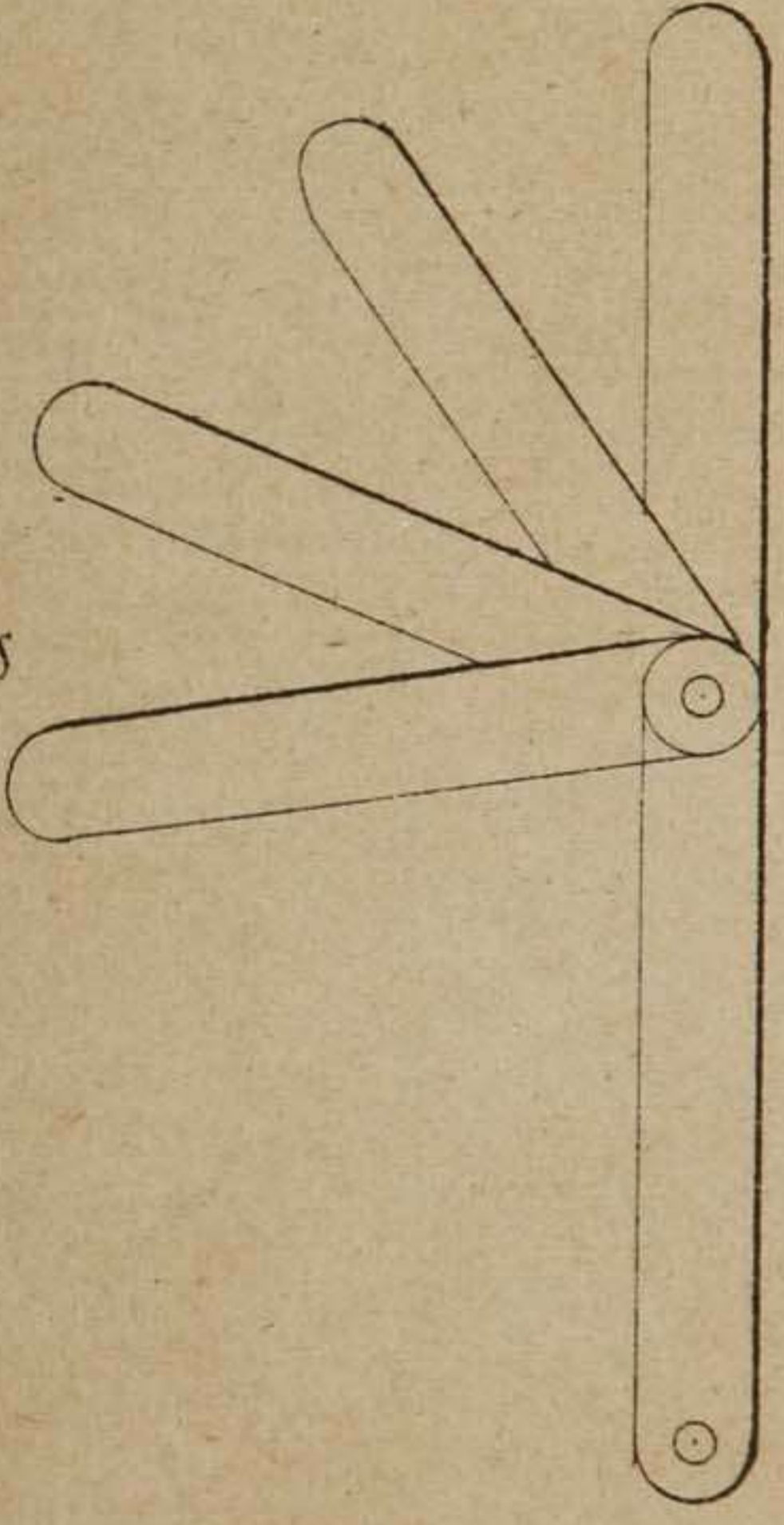


Fig. 84.

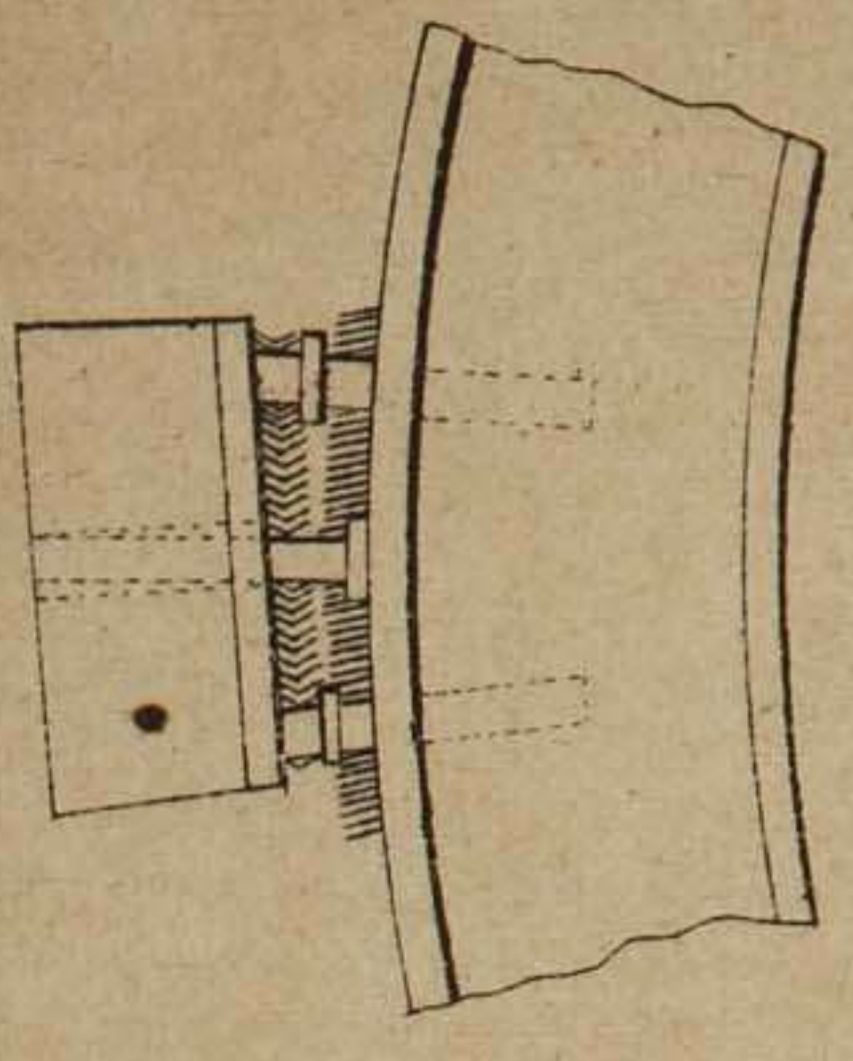


Fig. 86.

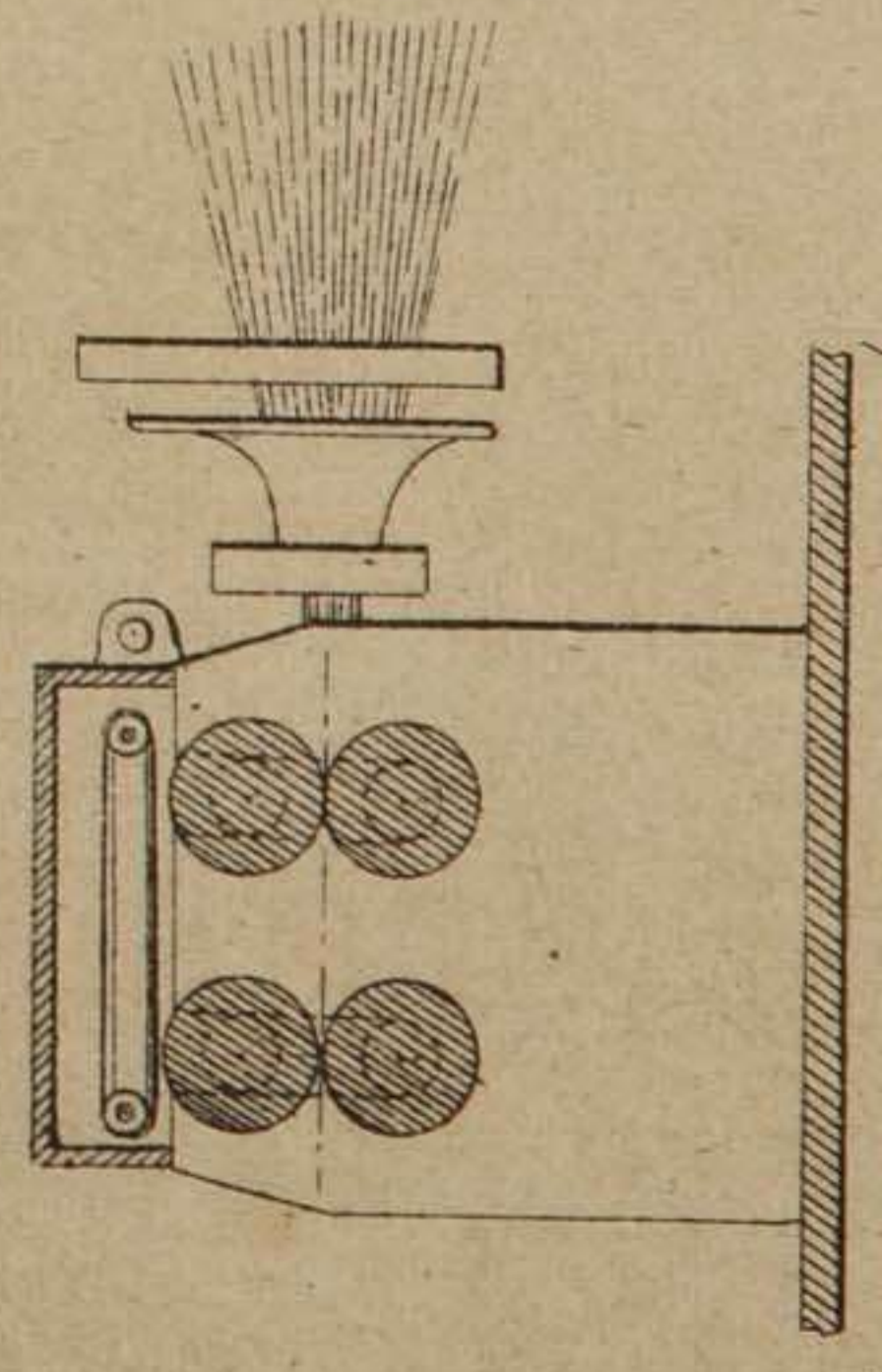


Fig. 87.

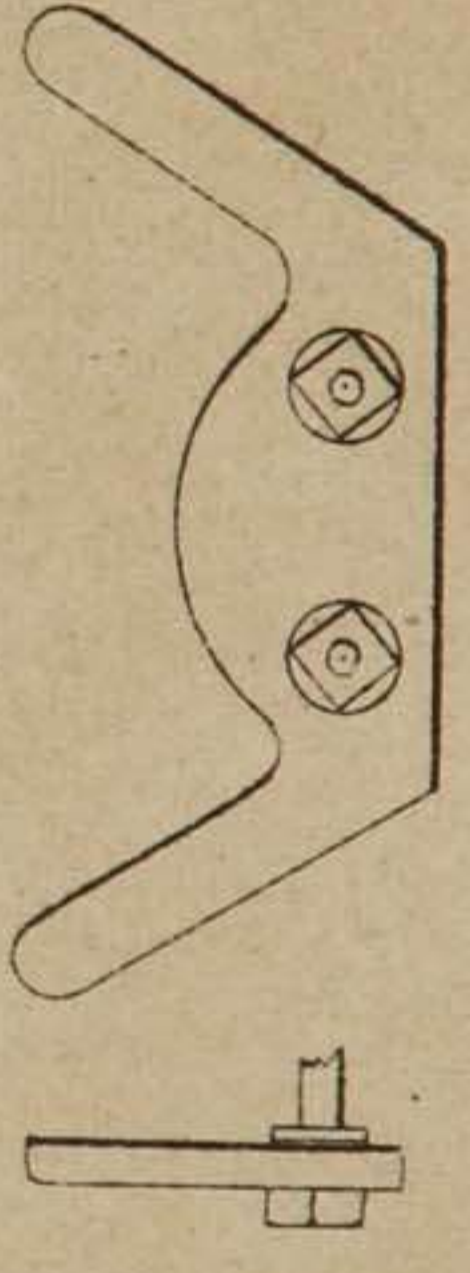


Fig. 85.

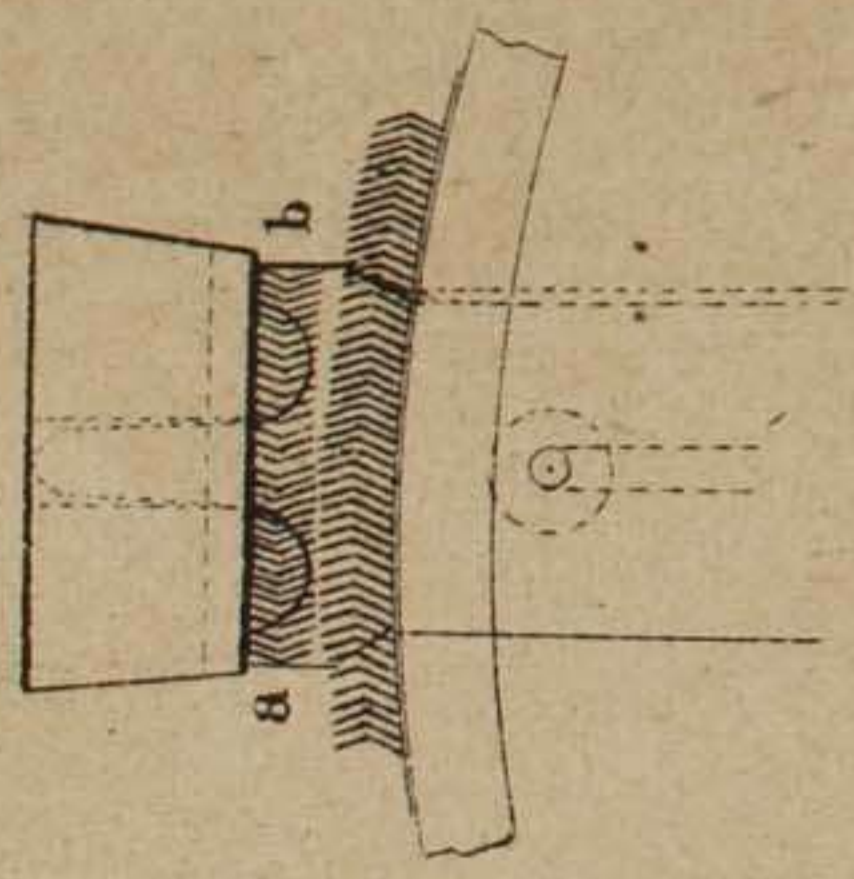
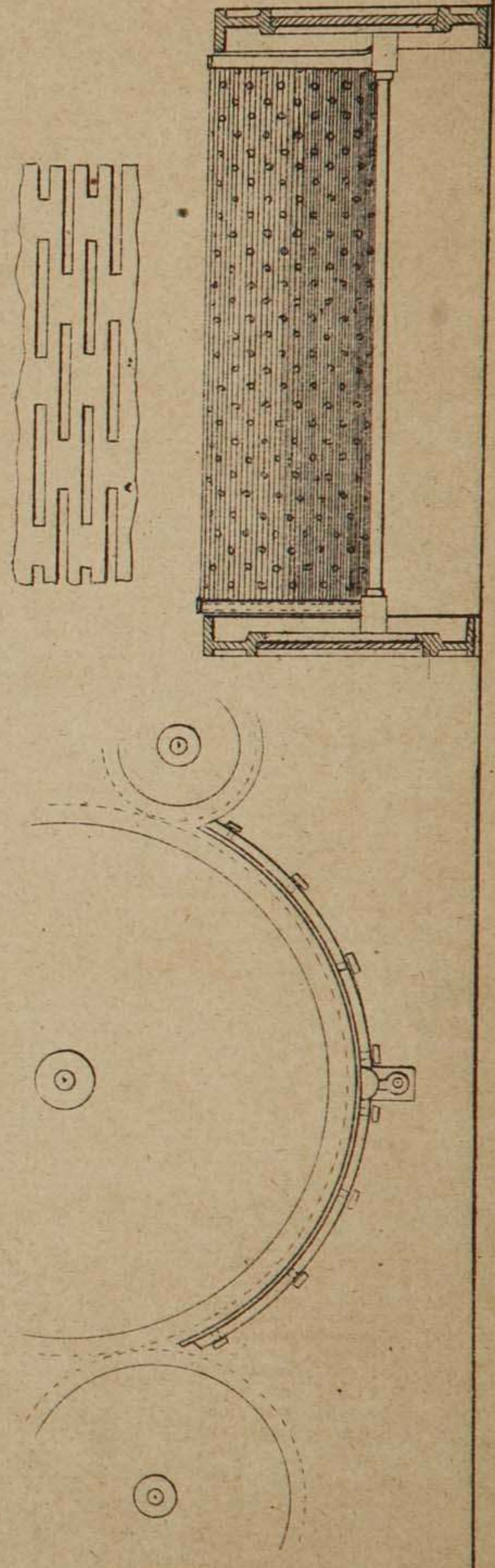


Fig. 88.



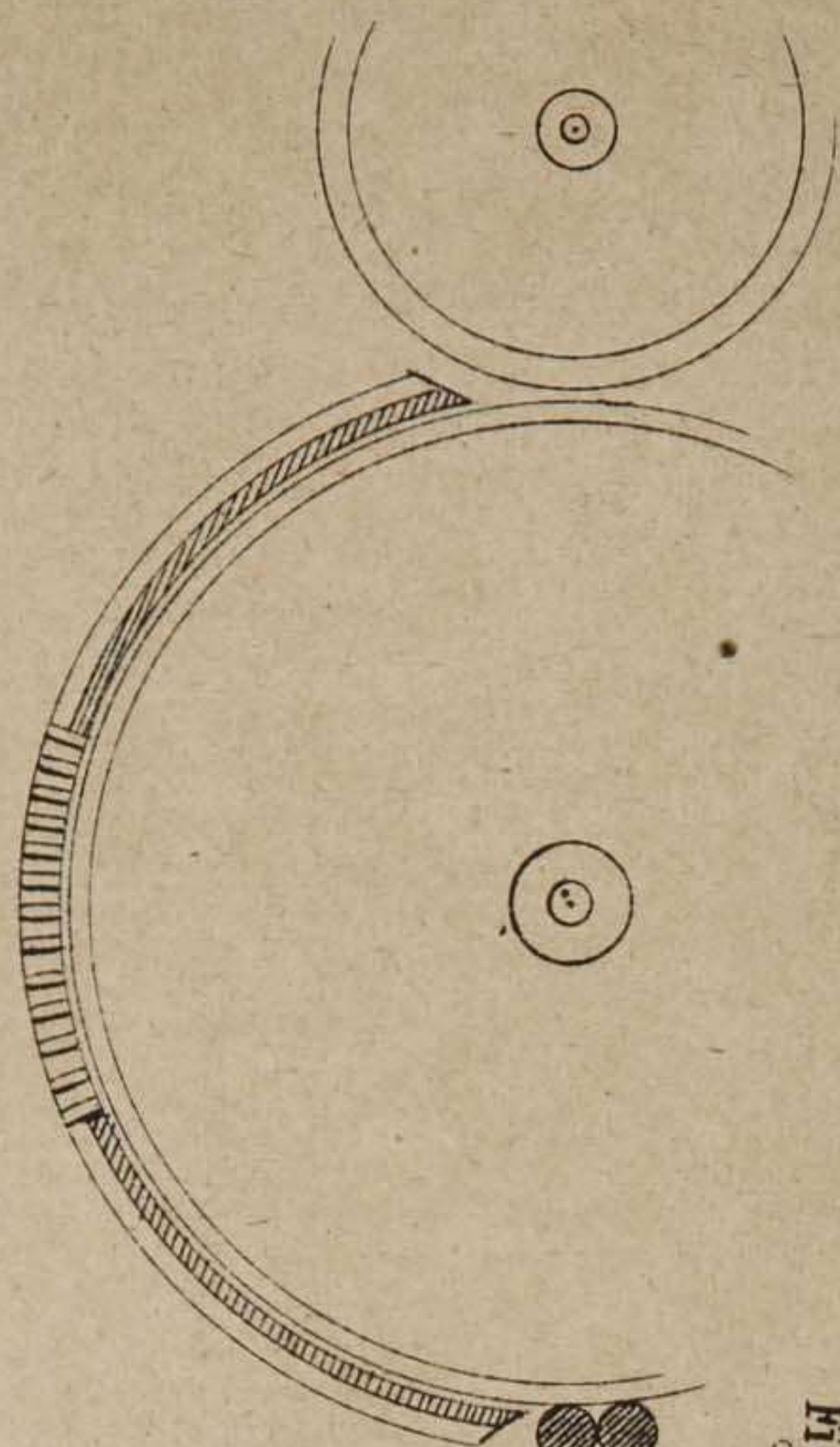


Fig. 89.

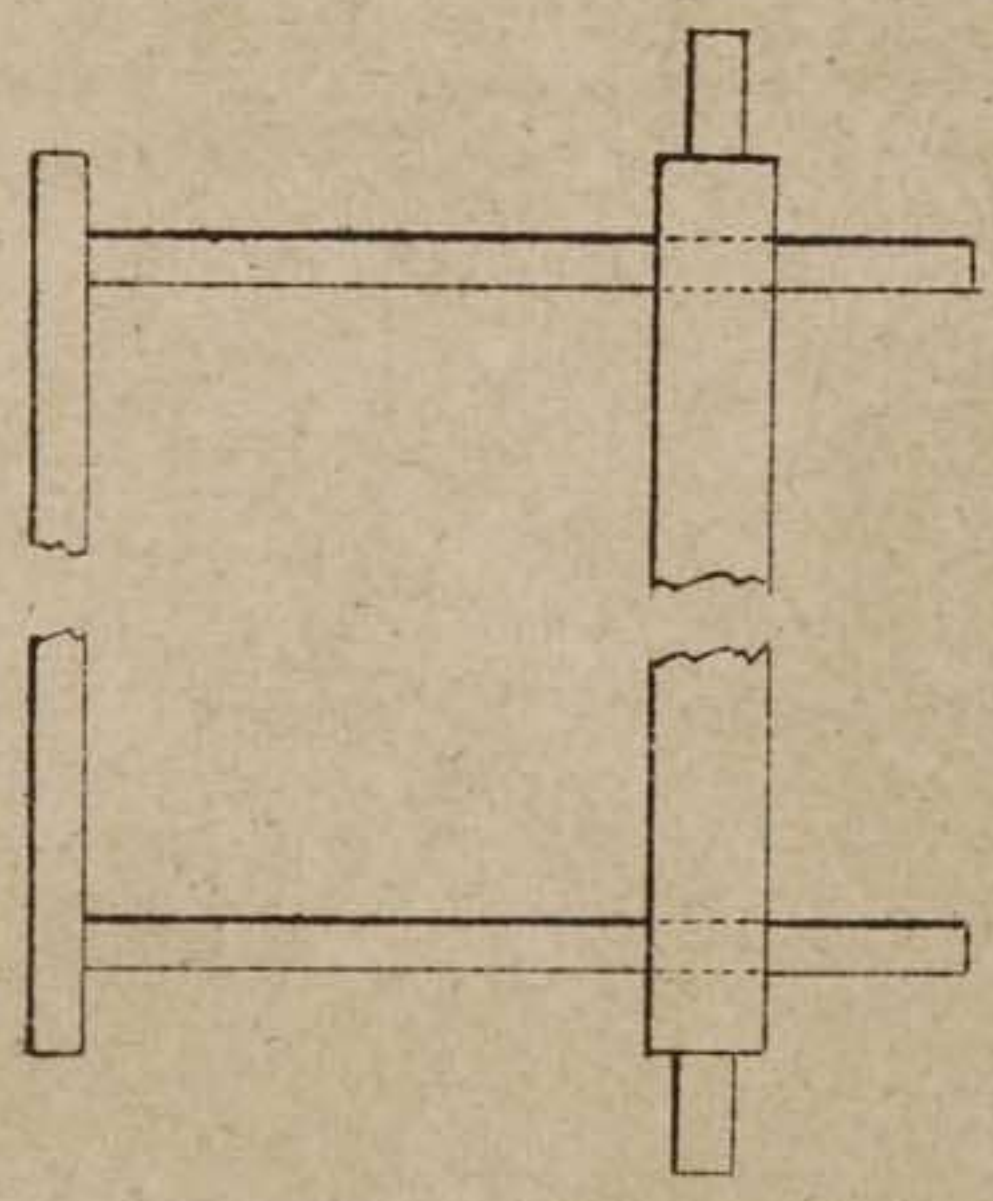


Fig. 90.

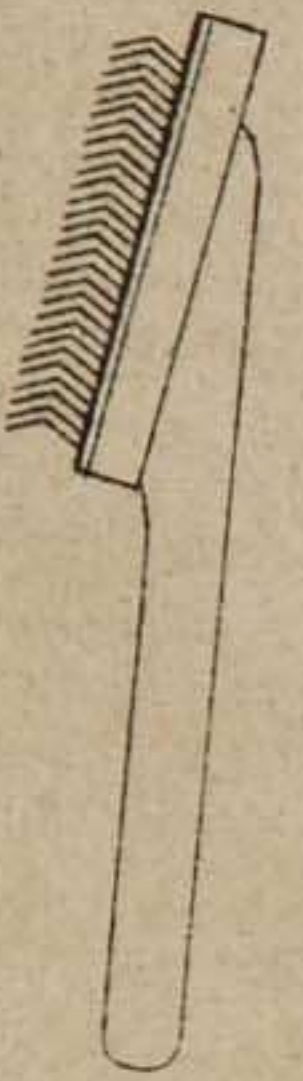


Fig. 91.

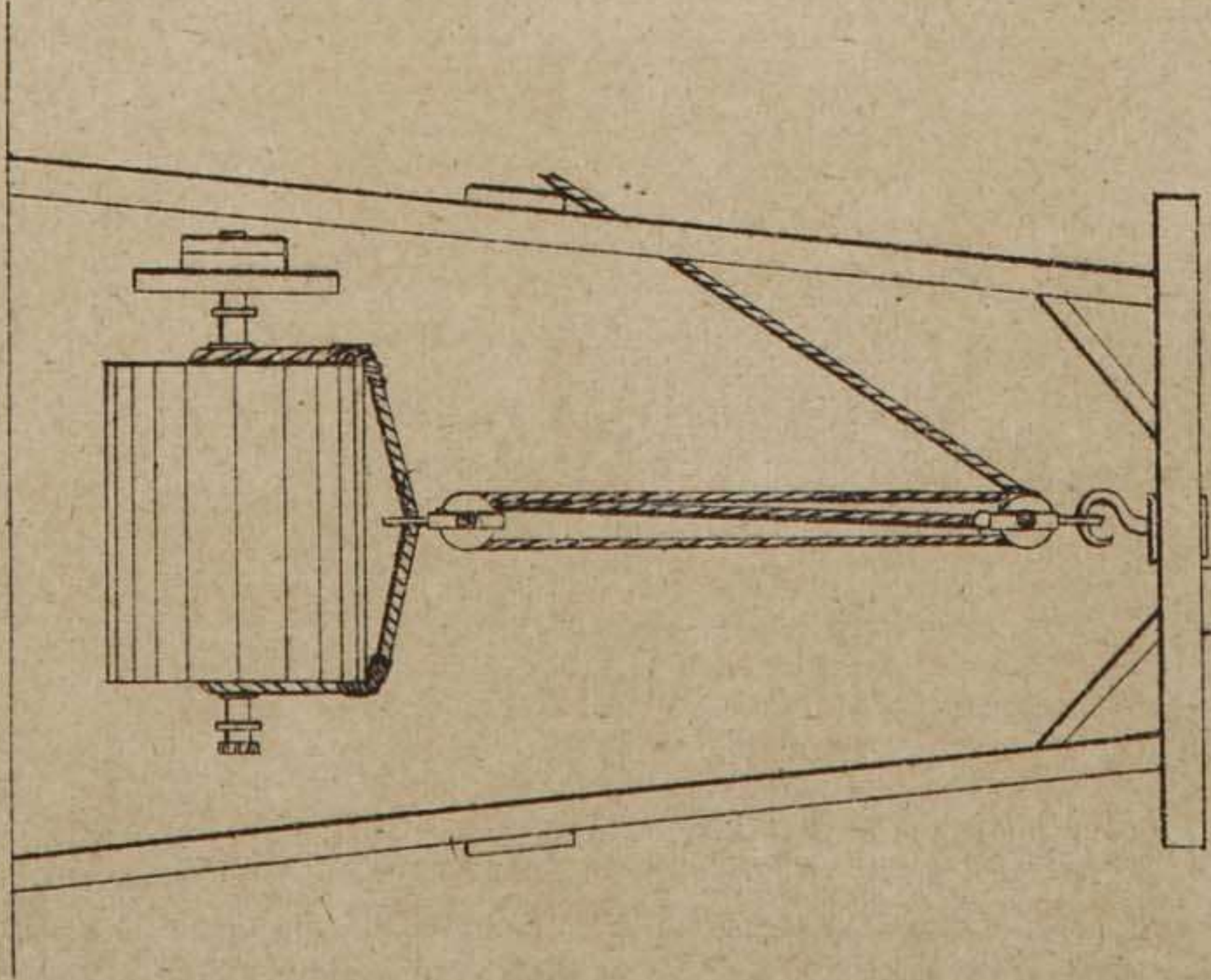


Fig. 92.



Fig. 93.

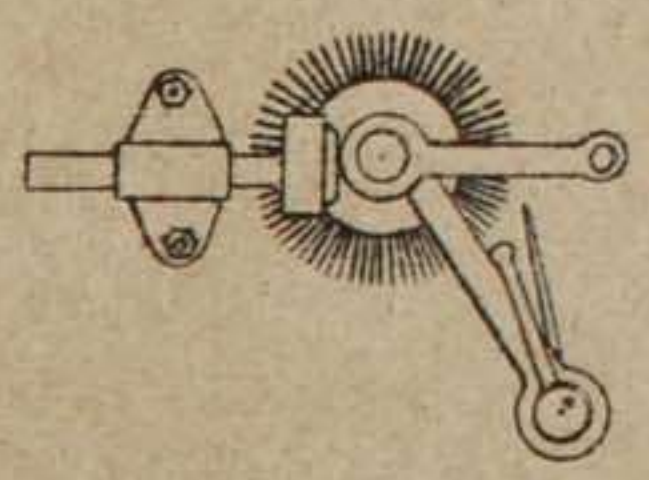


Fig. 94.

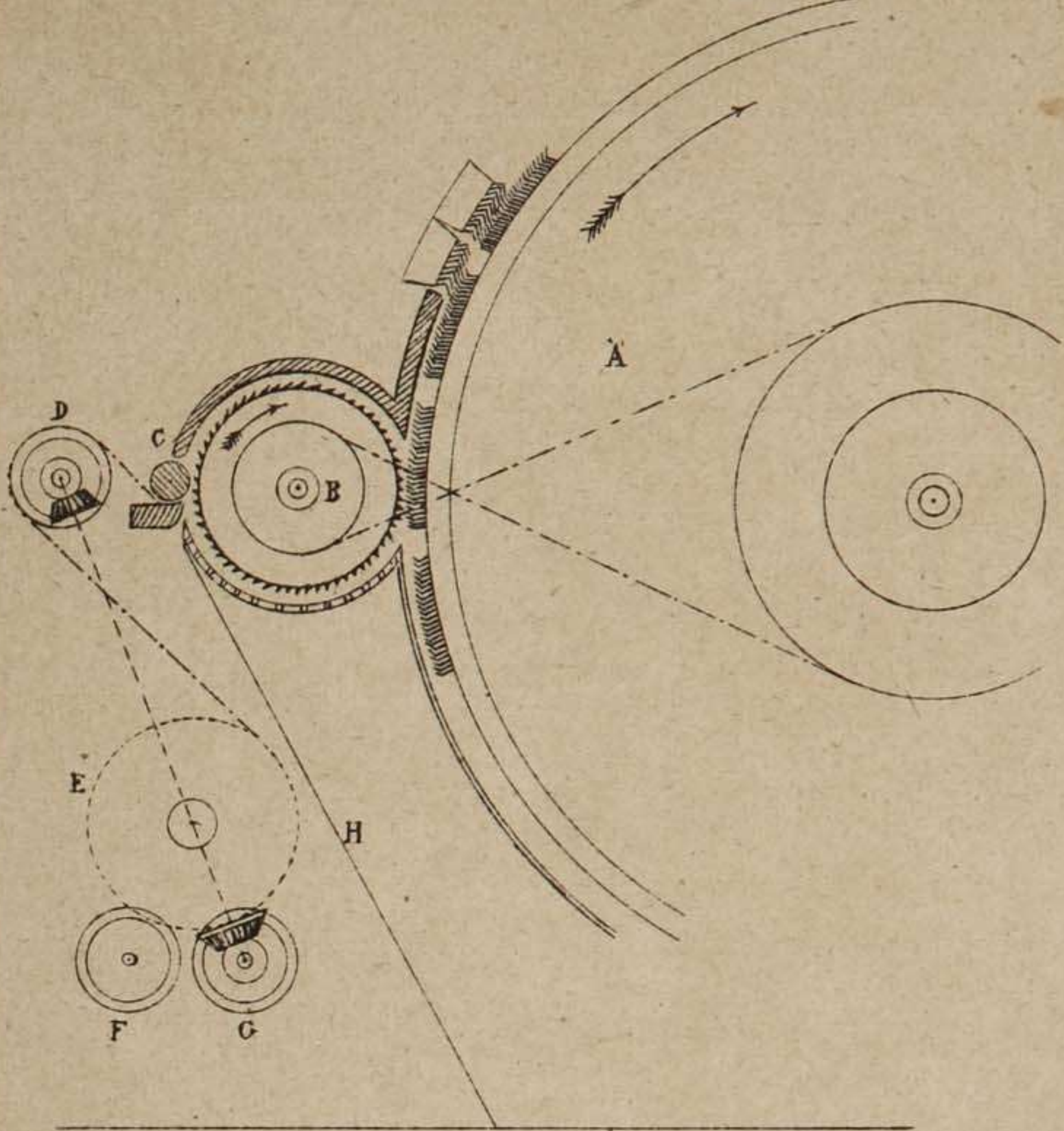


Fig. 95.

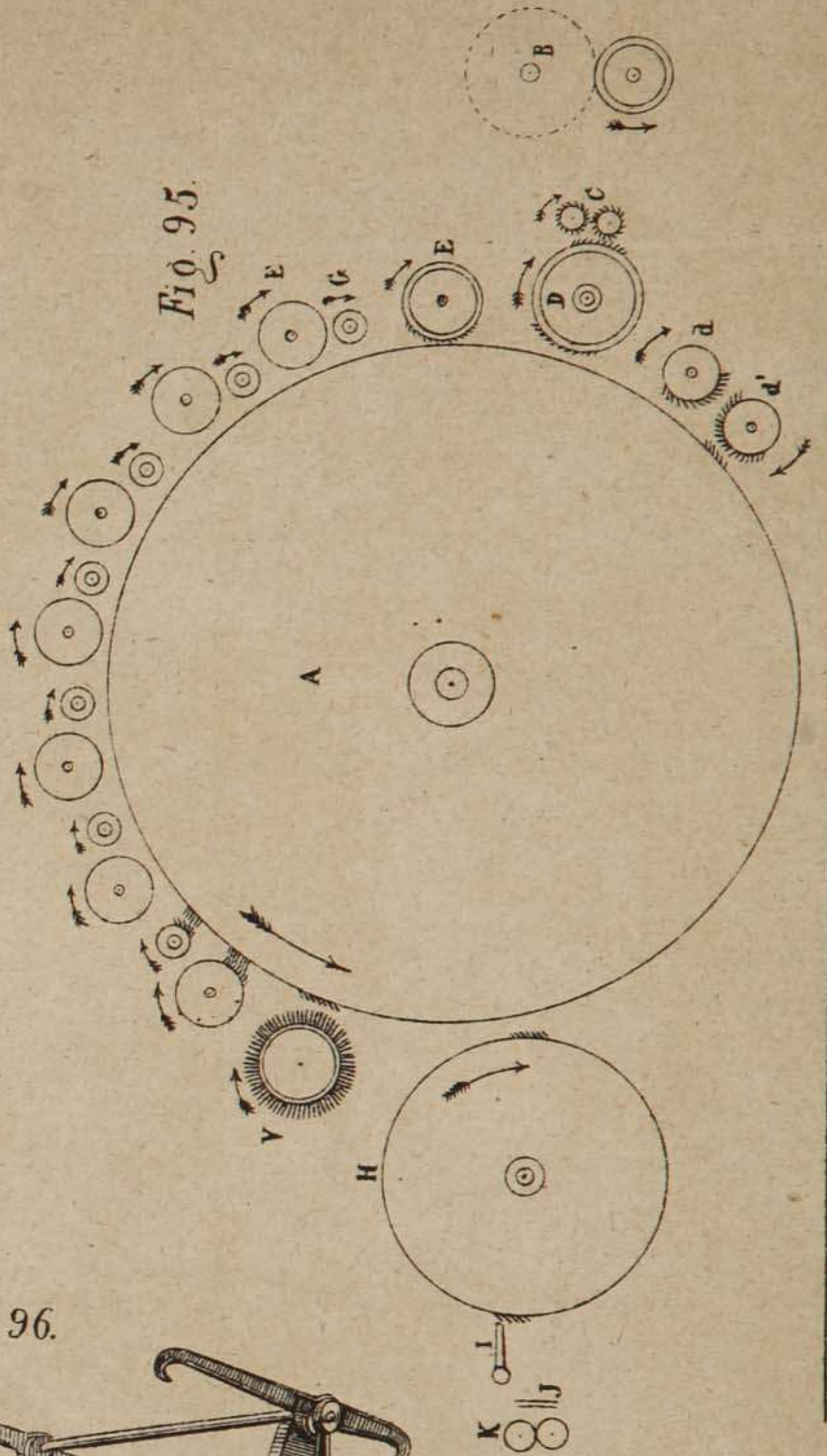
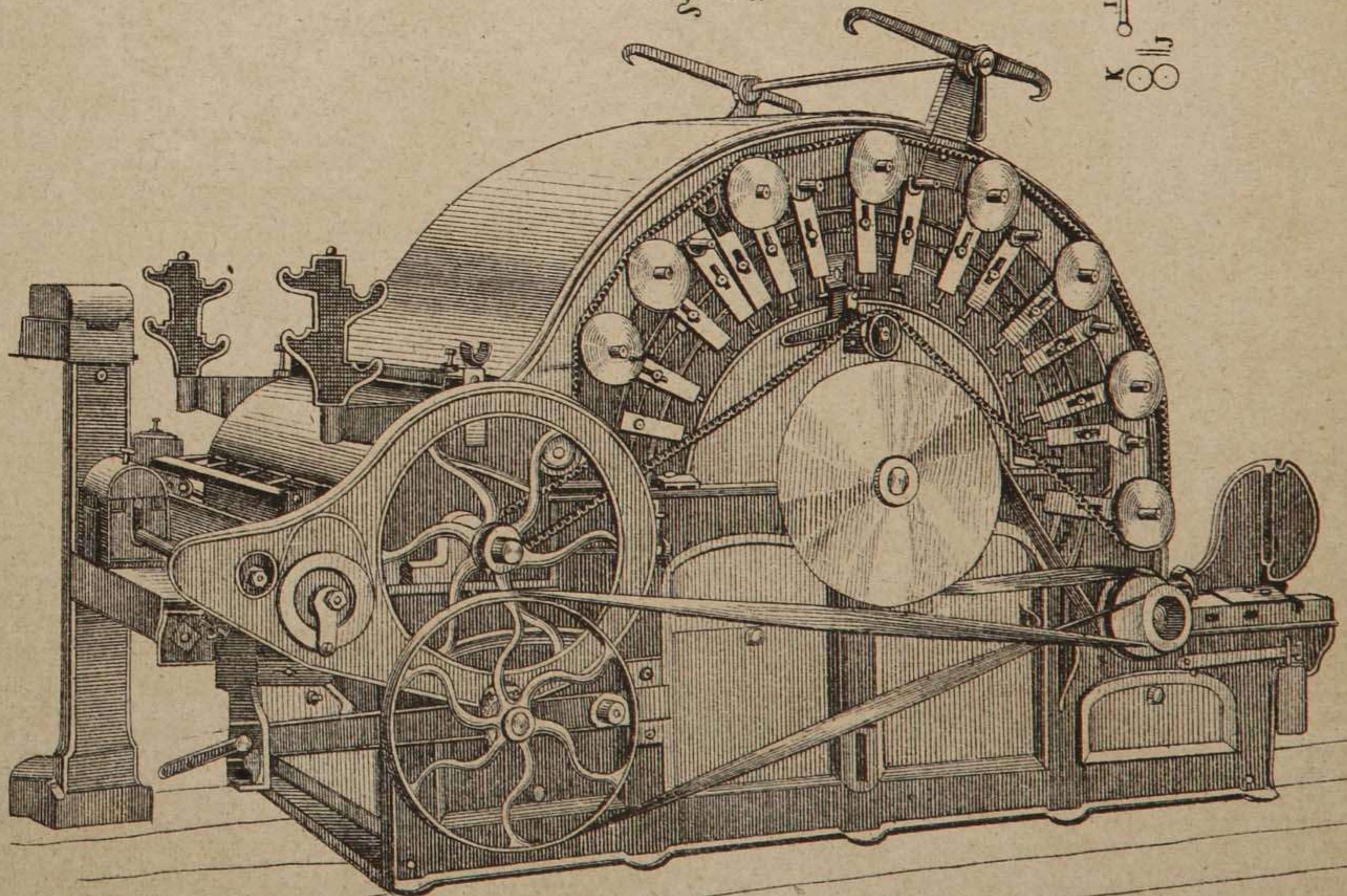
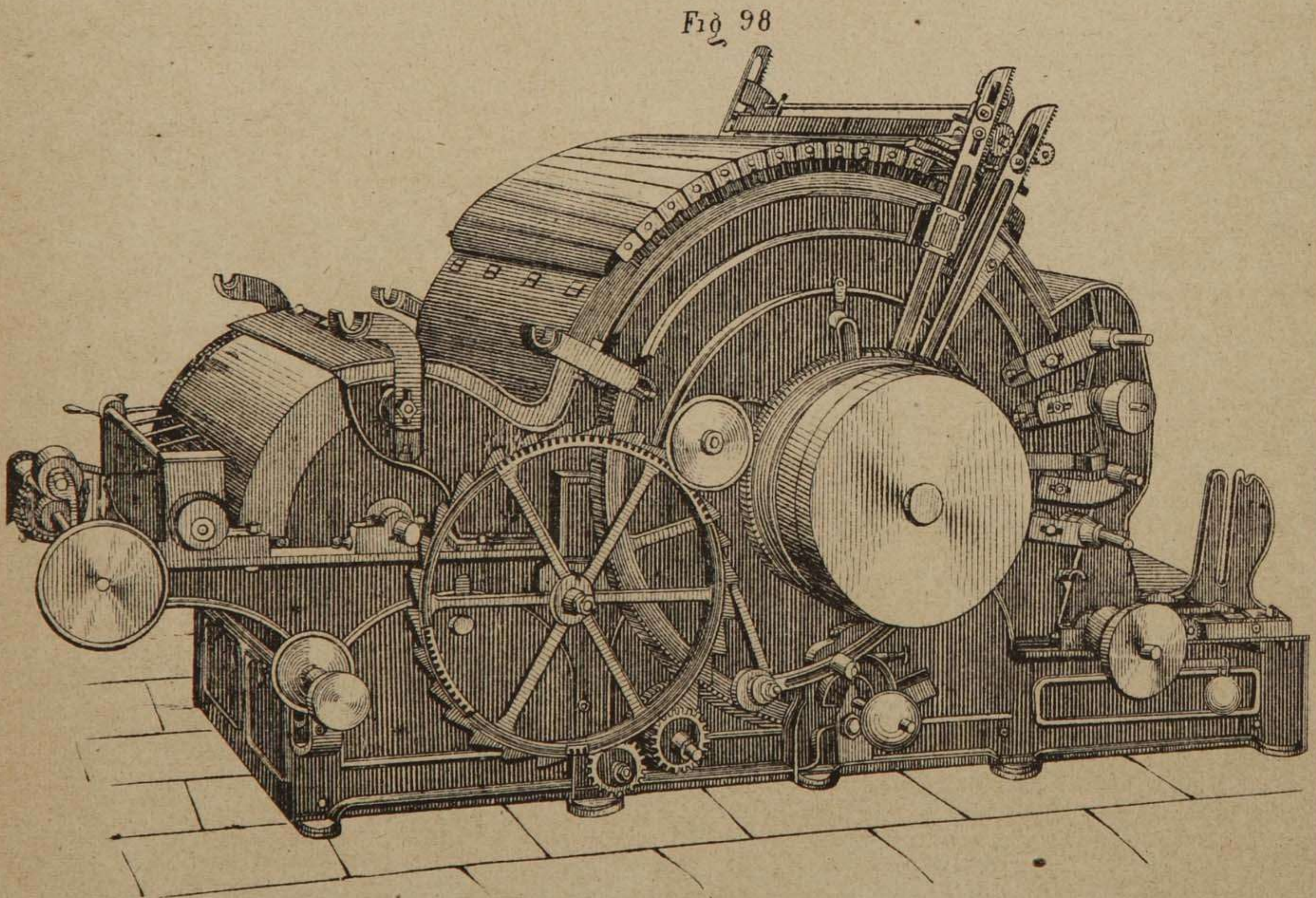
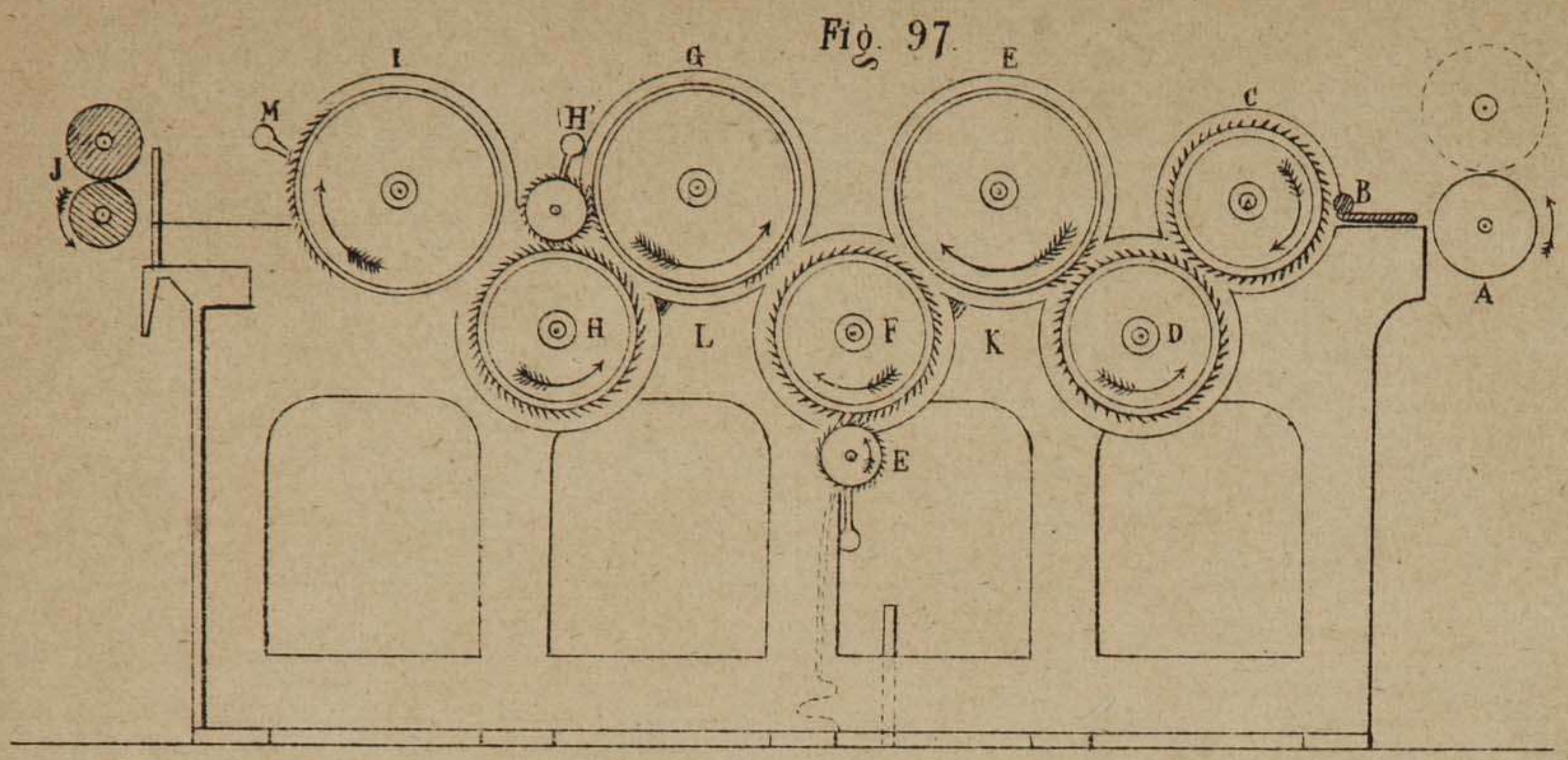


Fig. 96.





AS

Fig. 99

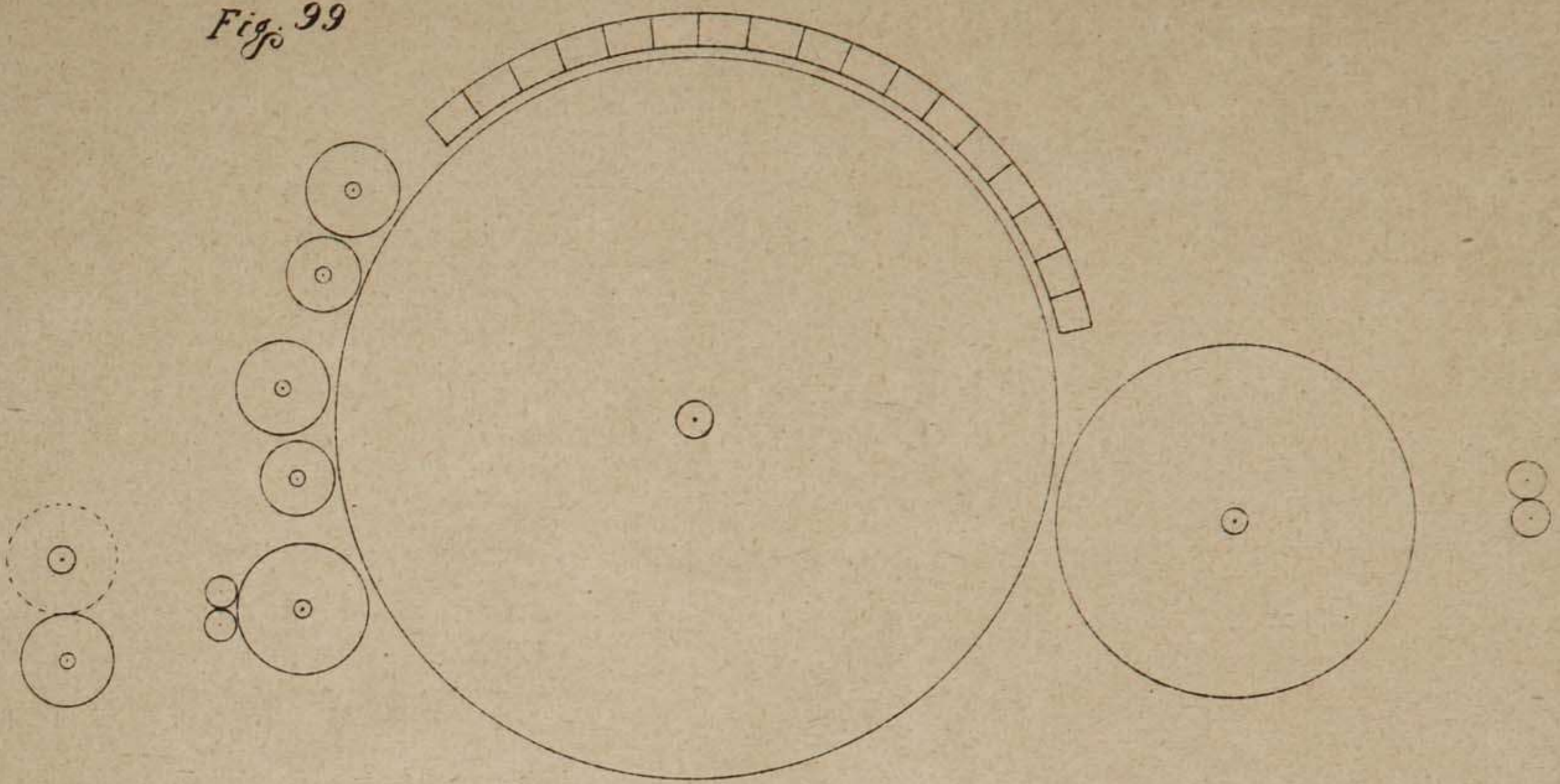


Fig. 100

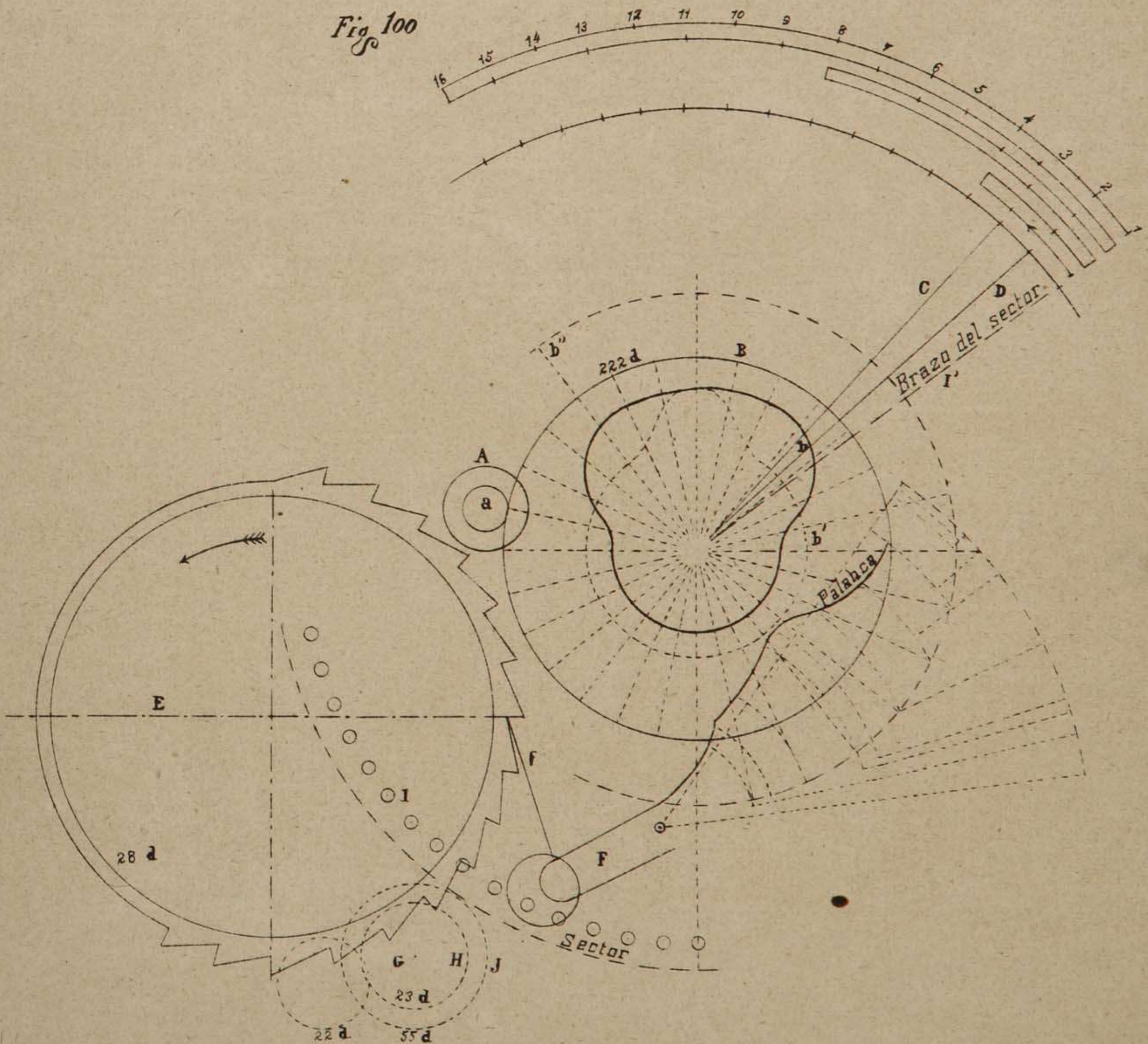


Fig. 102

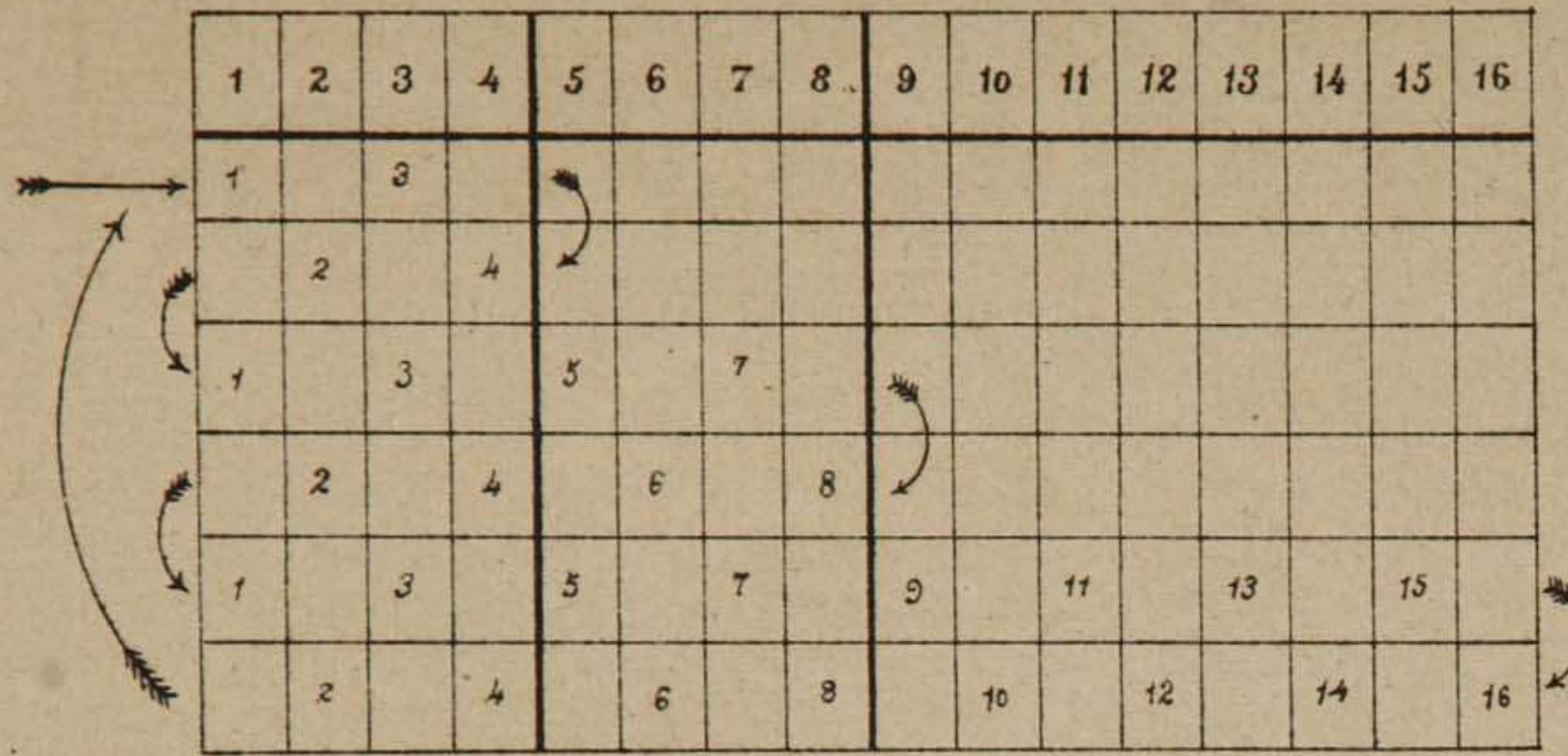


Fig. 103

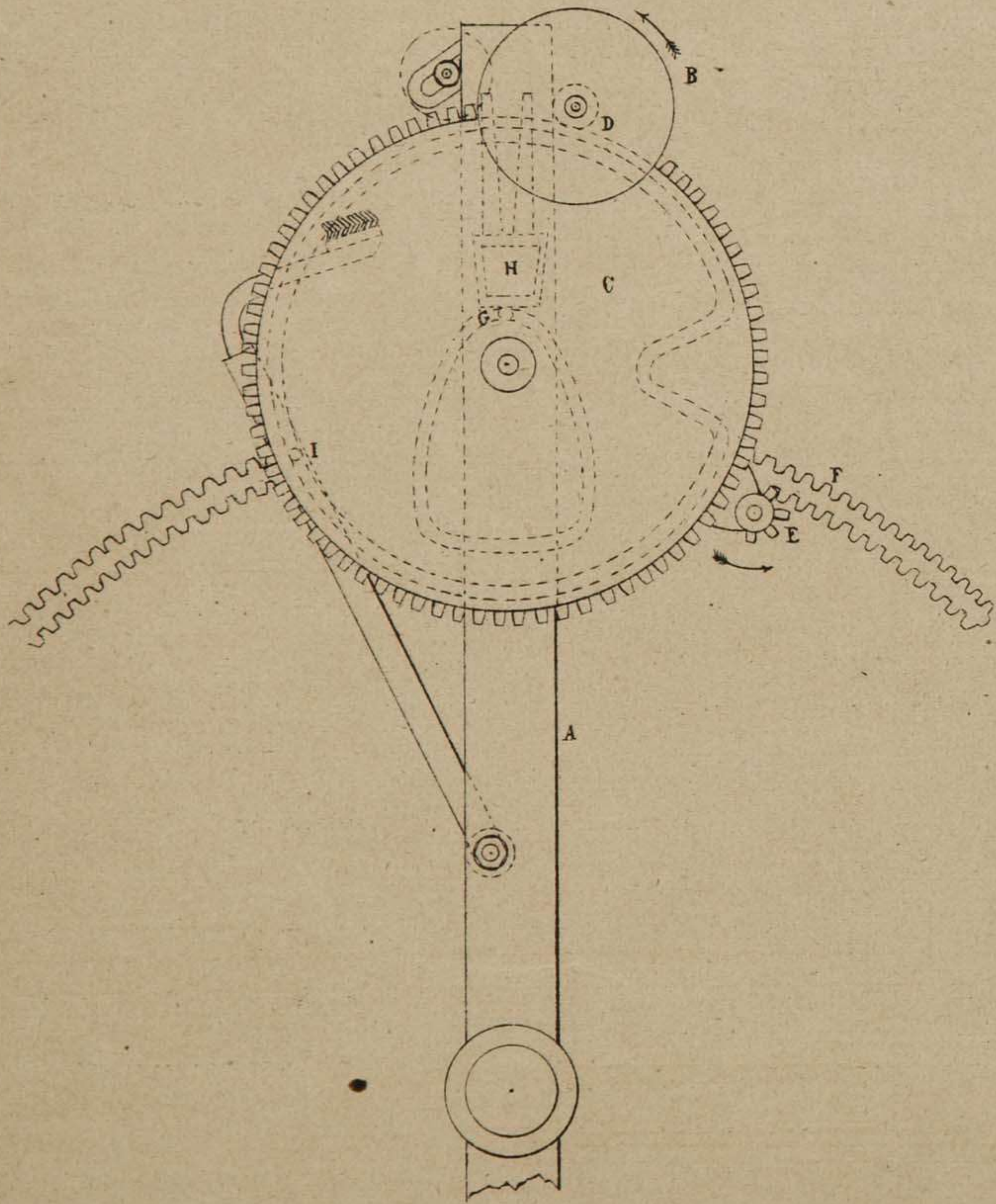


Fig. 101

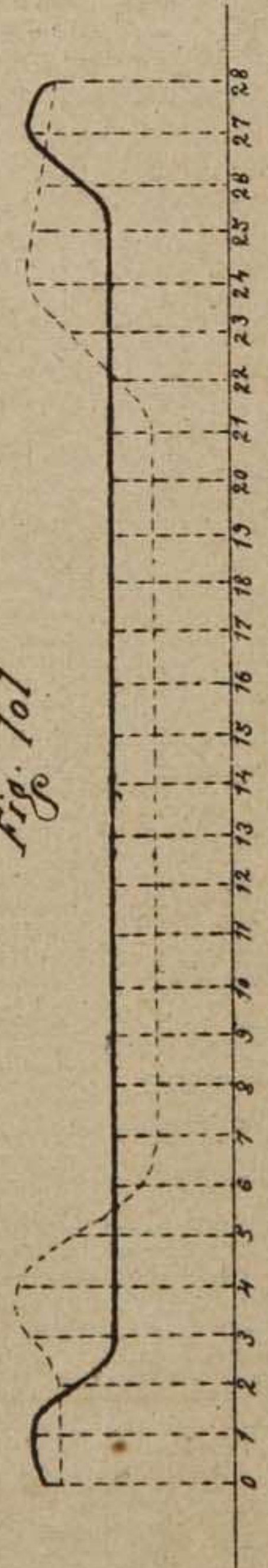


Fig. 104

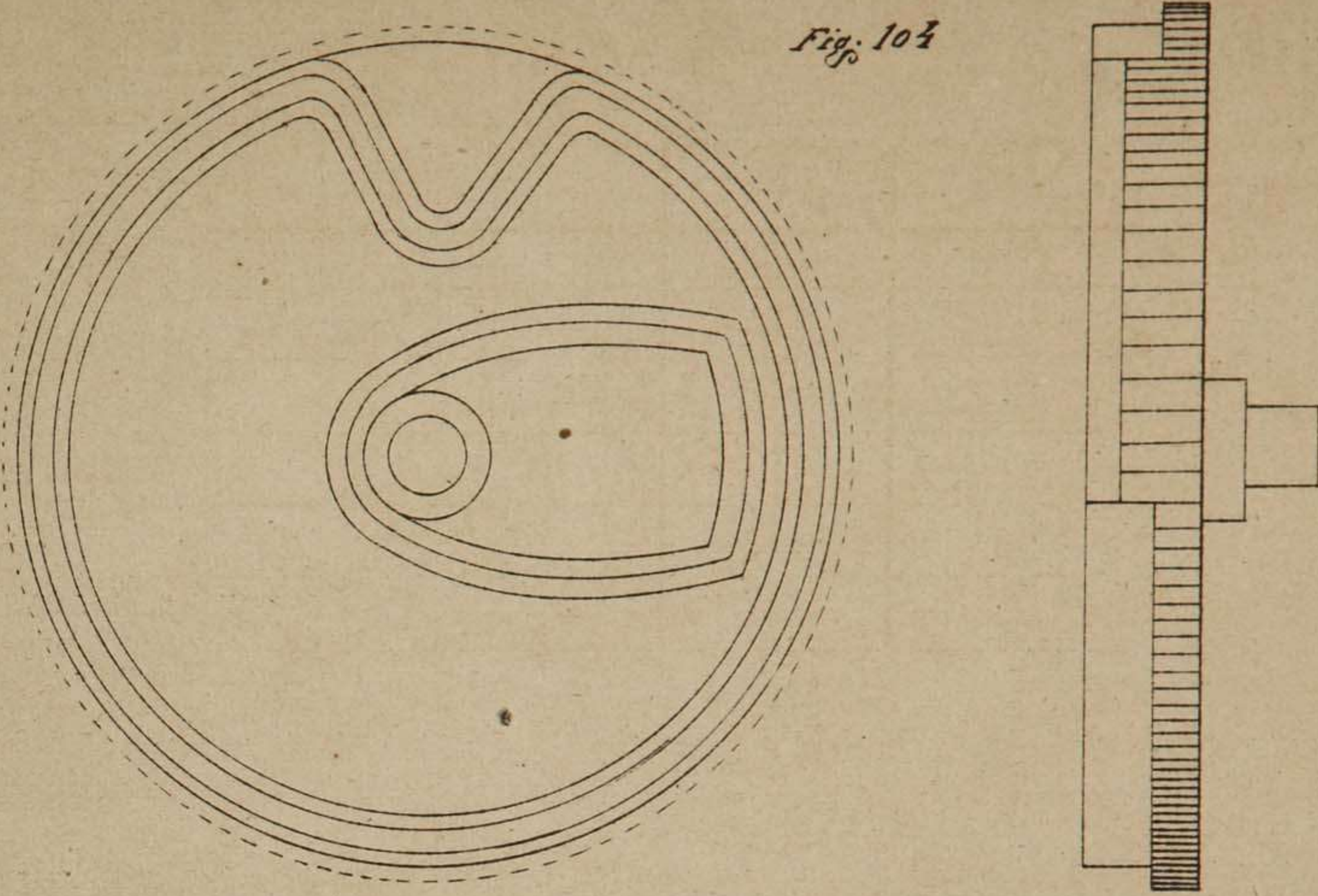


Fig. 106

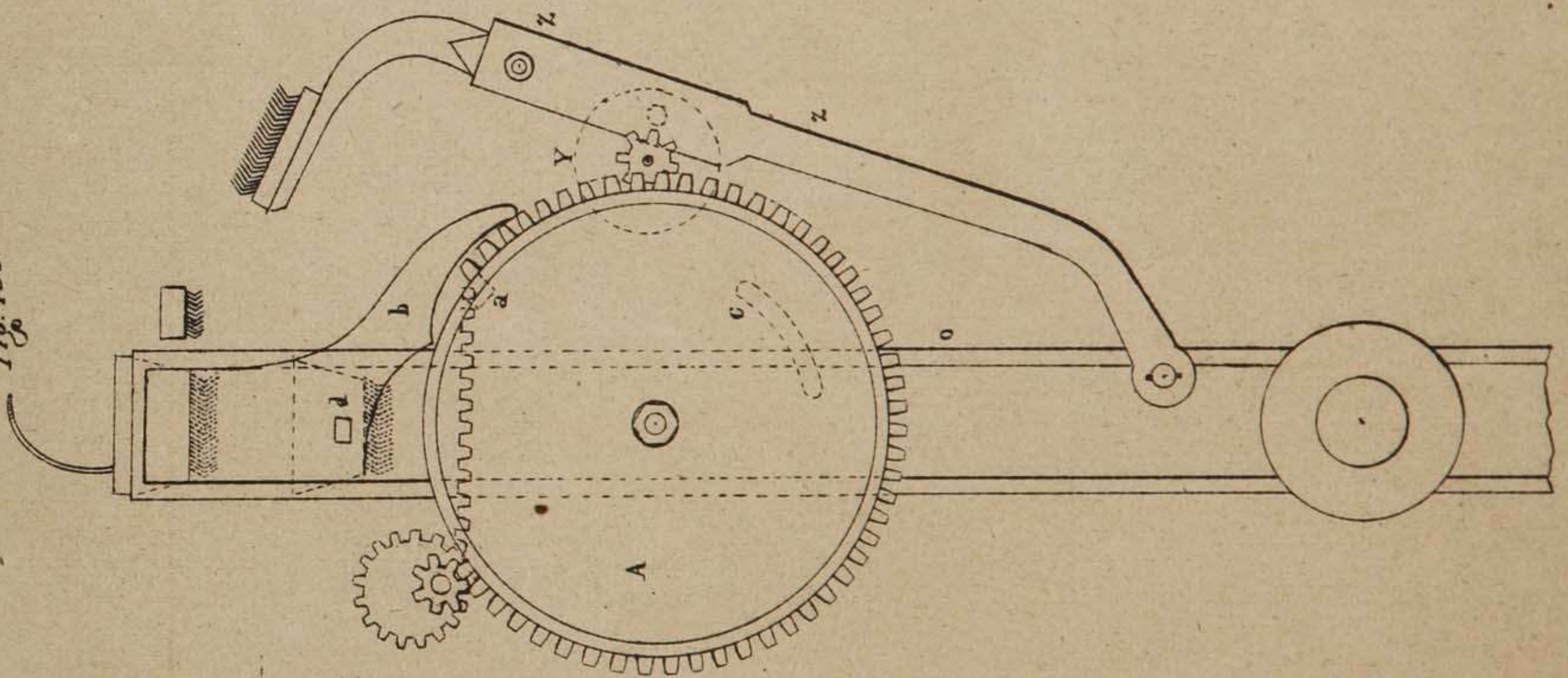


Fig. 105

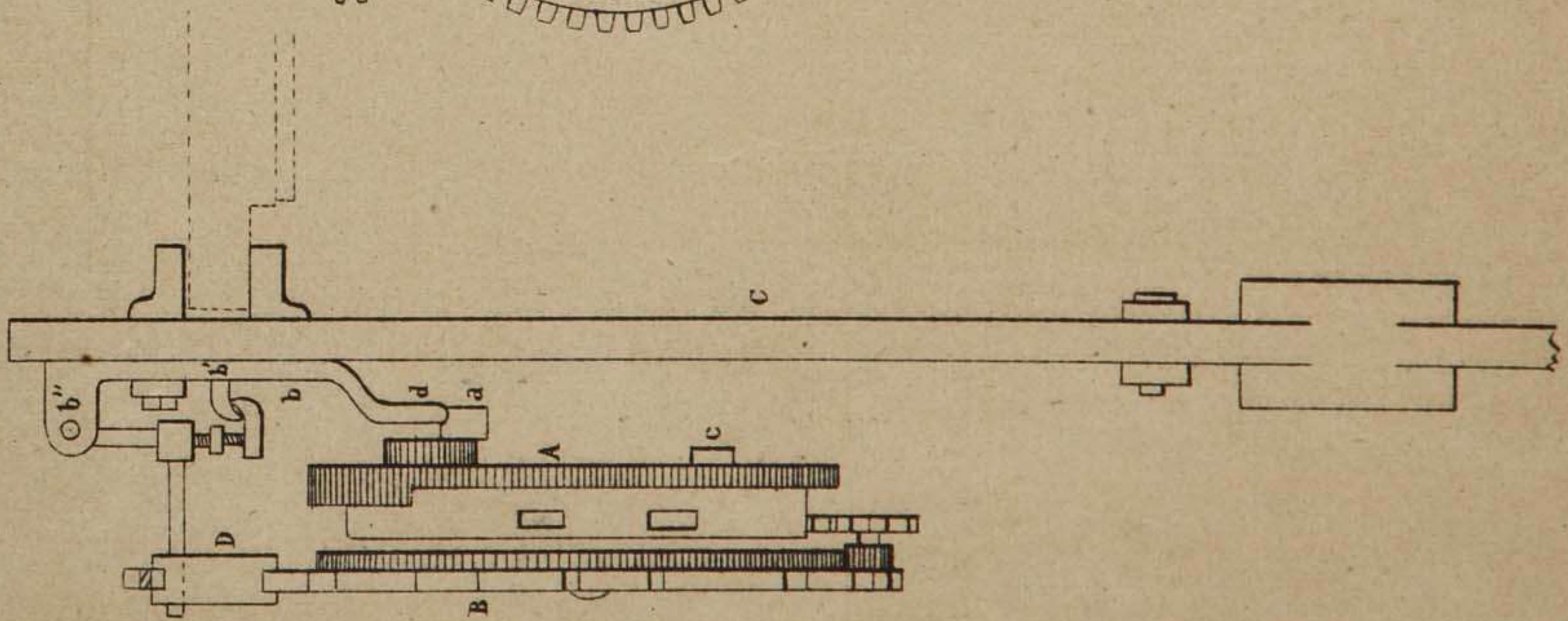


Fig. 107

	1	2	3	4	5	6	7	8	9	10	11	12	13	14	15	16
1			3		5		0		9		11		0		15	
2		2		4		6		0		10		12		0		0
3	1		3		5		7		0		0		13		0	
4		2		4		6		8		0		0		14		0
5	1		3		5		7		9		11		0		0	
6		2		4		6		8		10		0		0		16

Fig. 108

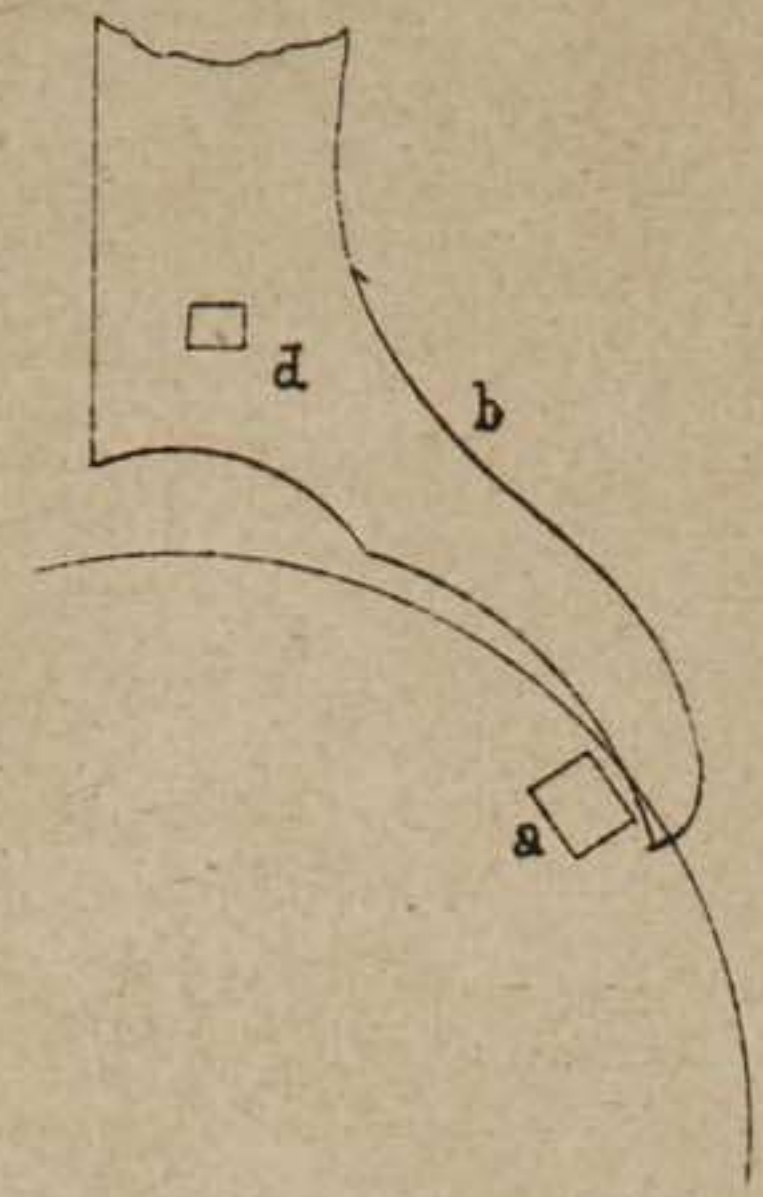


Fig. 109

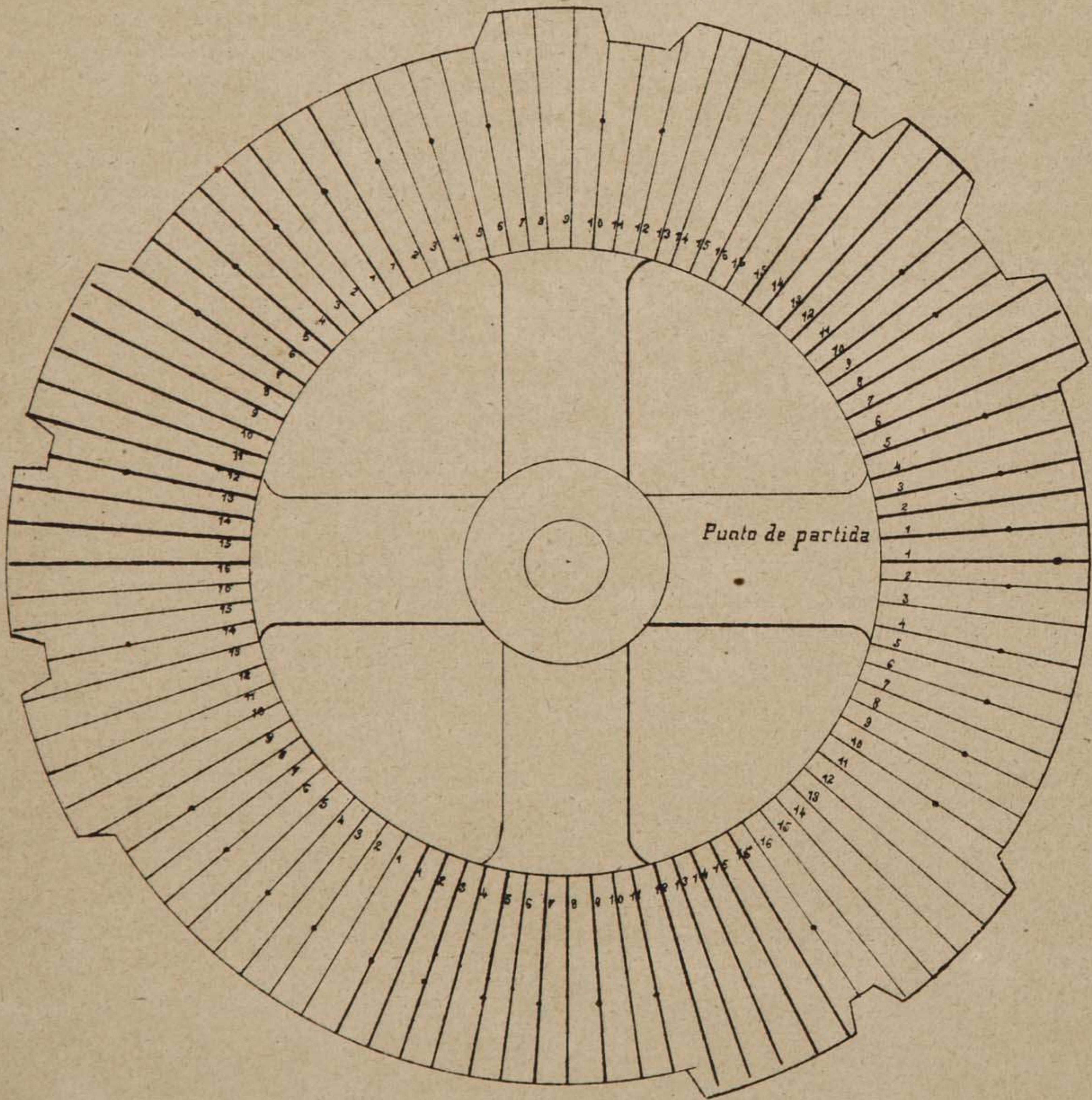


Fig. 110

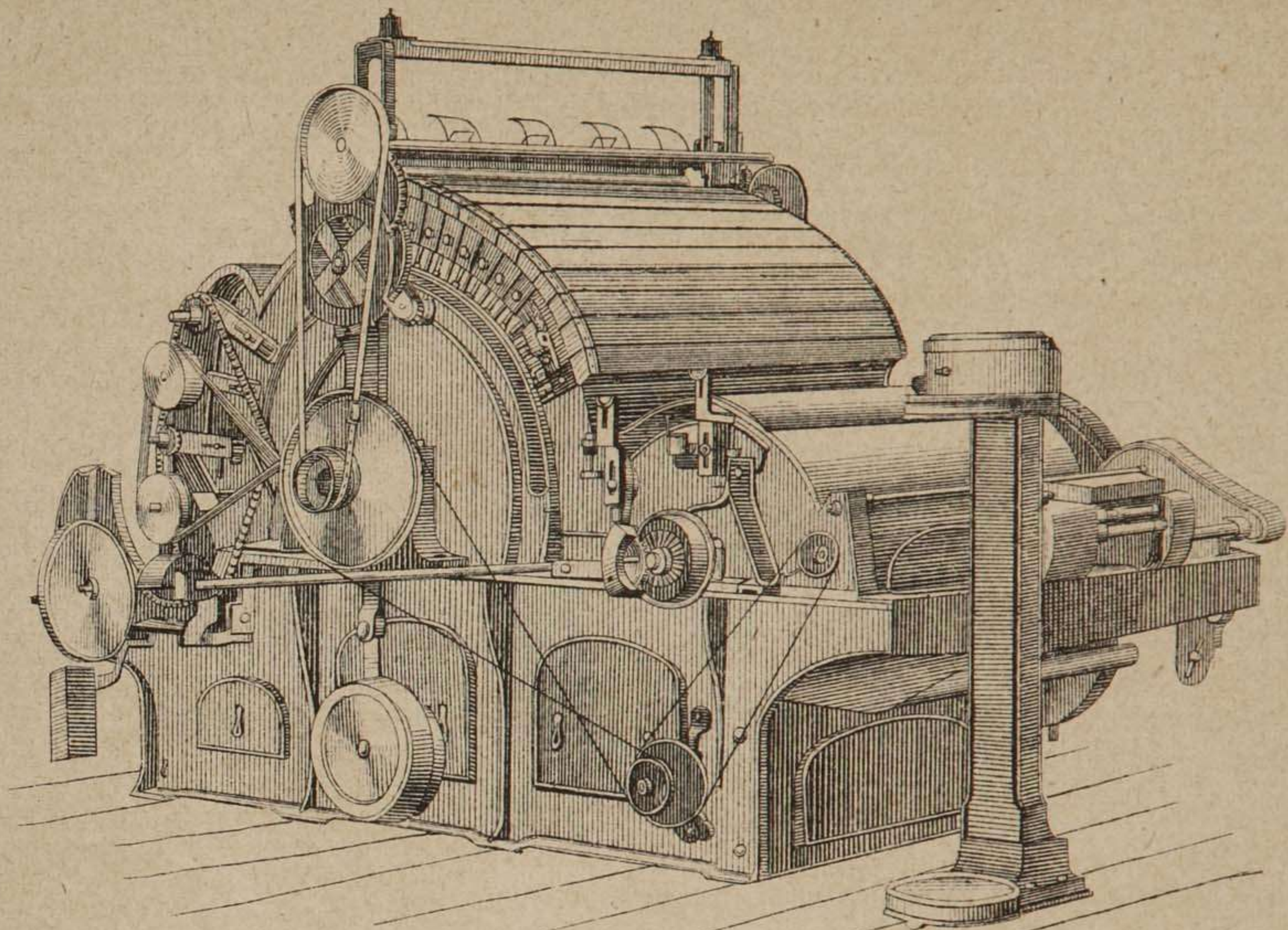


Fig. 111

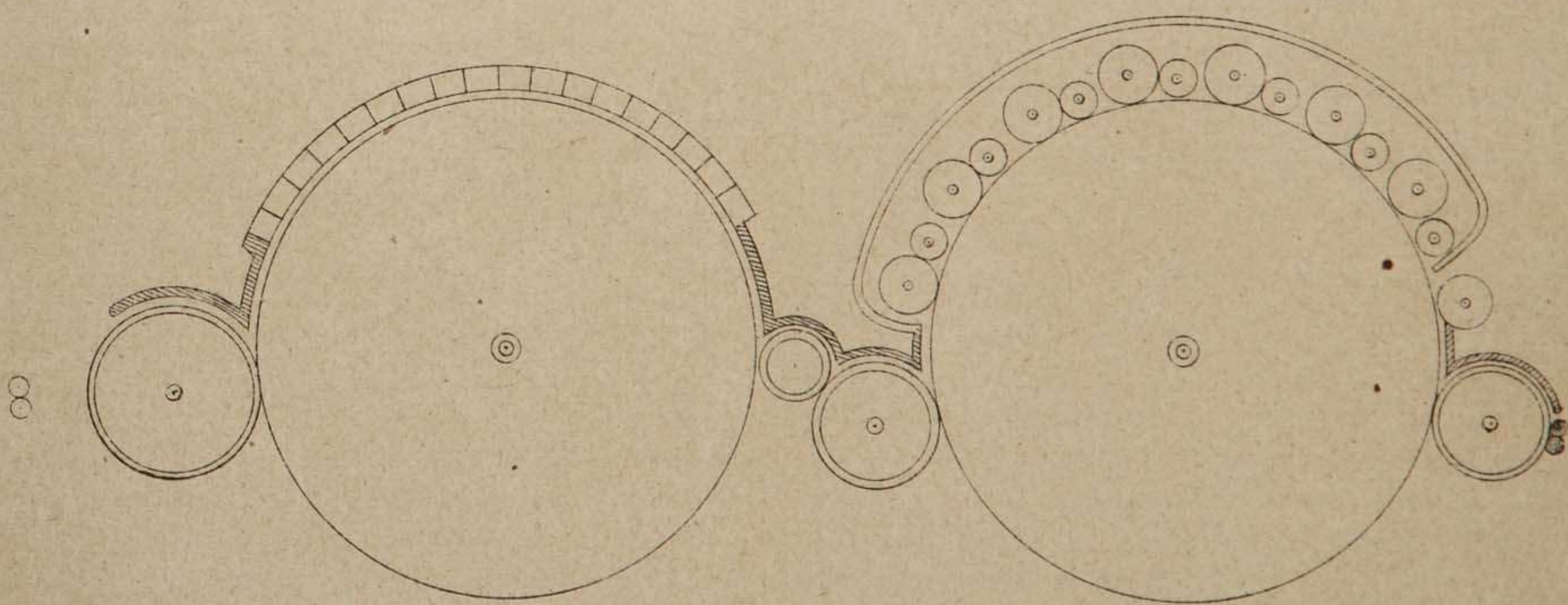


Fig. 112

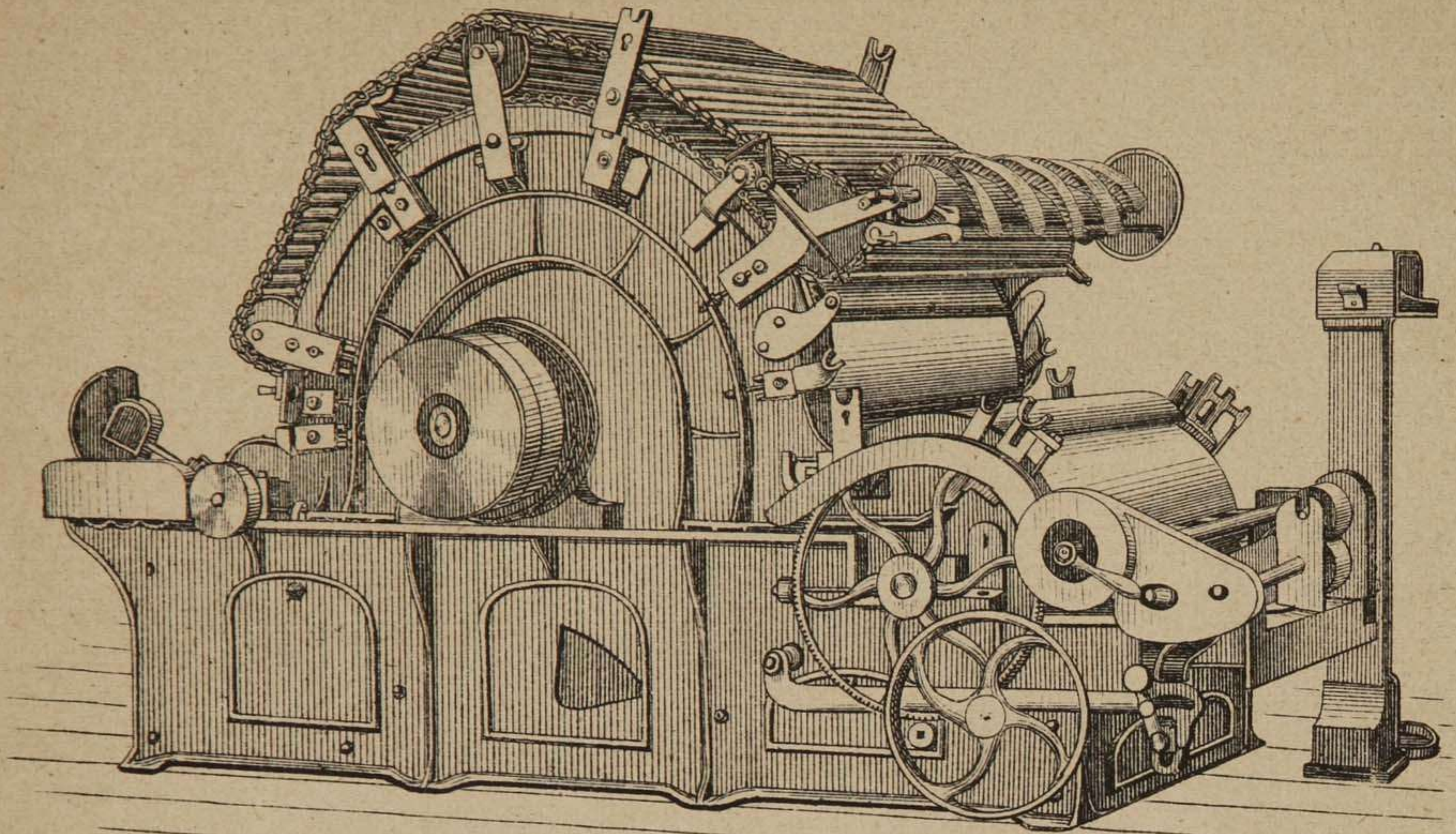


Fig. 113

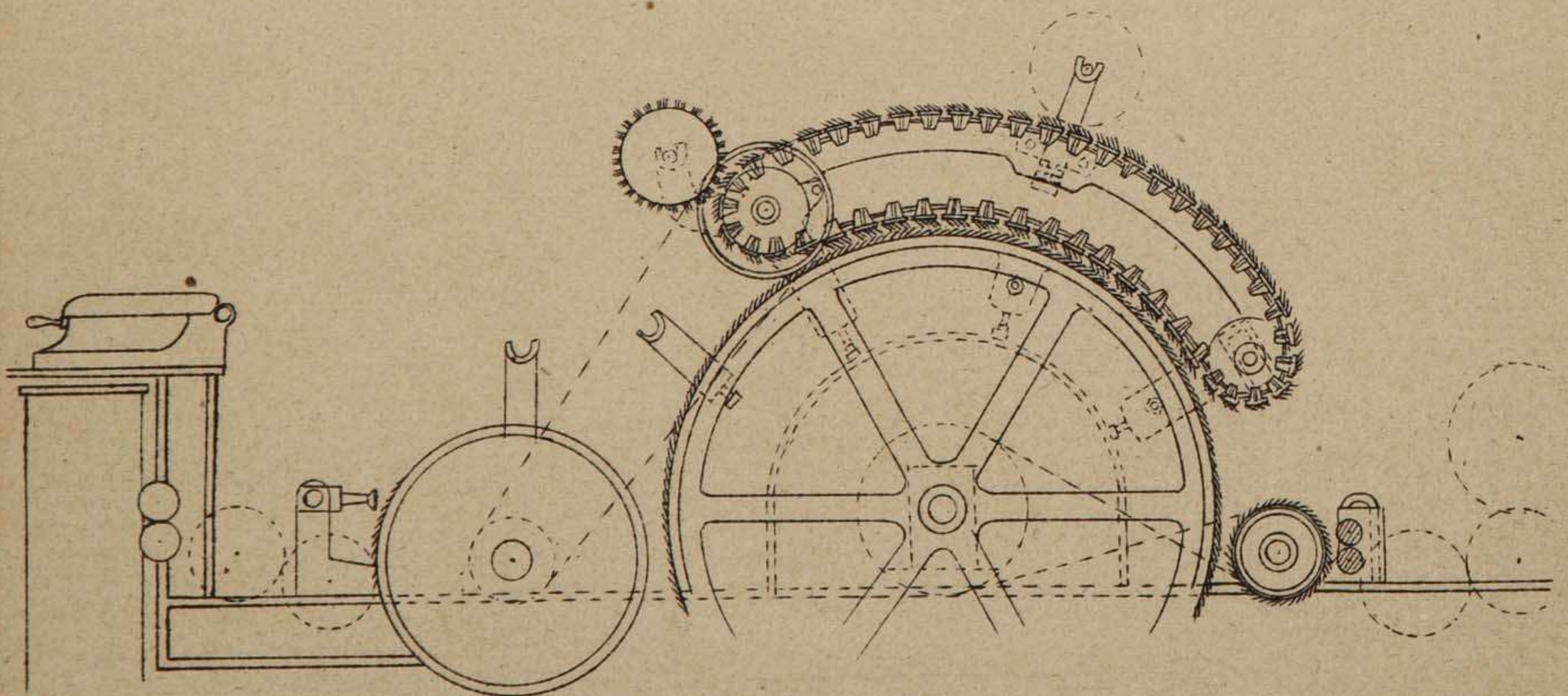


Fig. 114

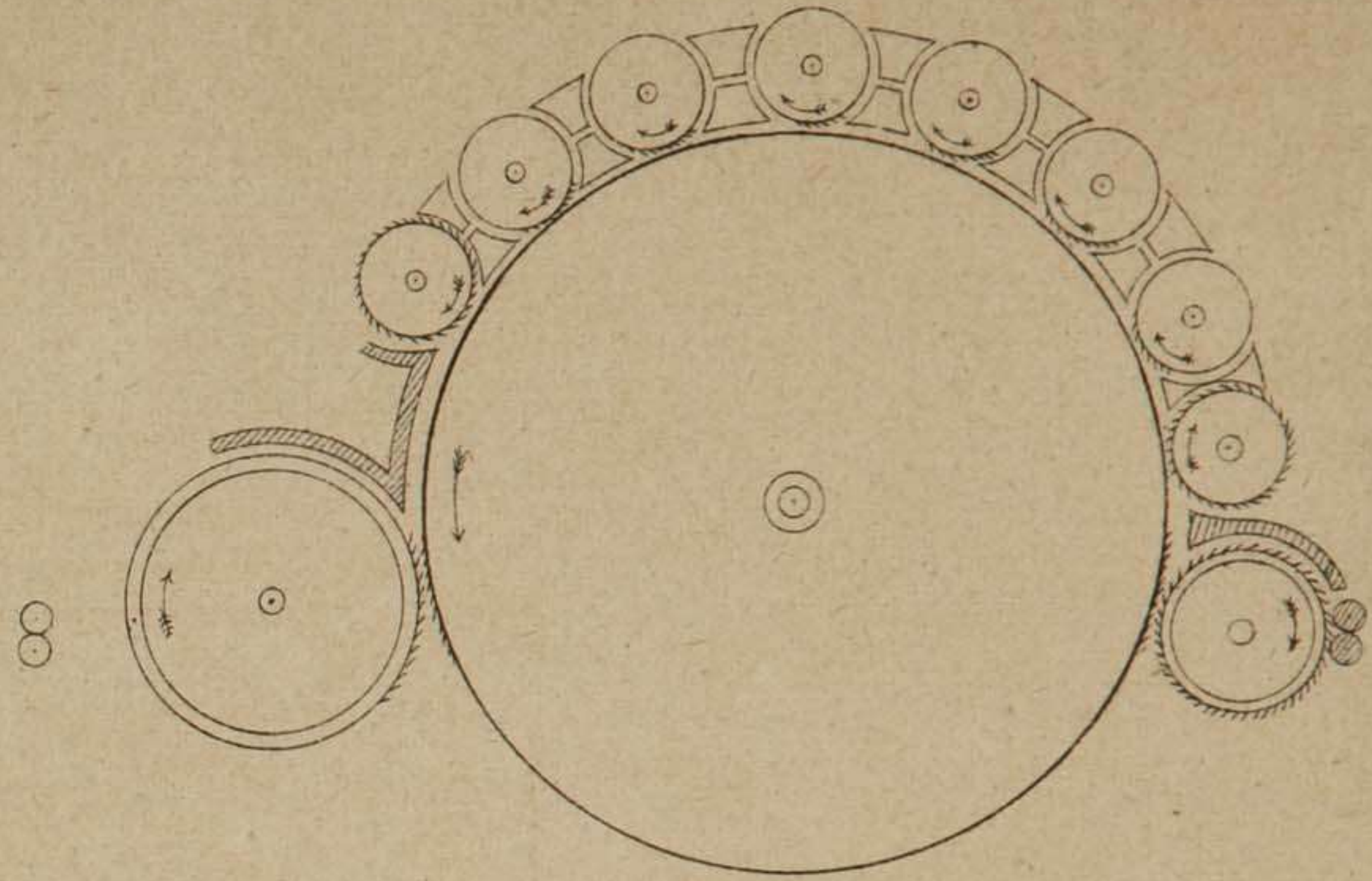


Fig. 115

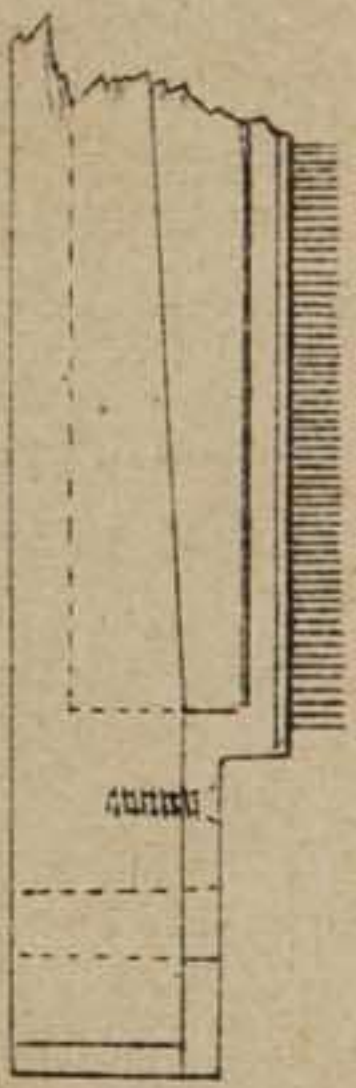
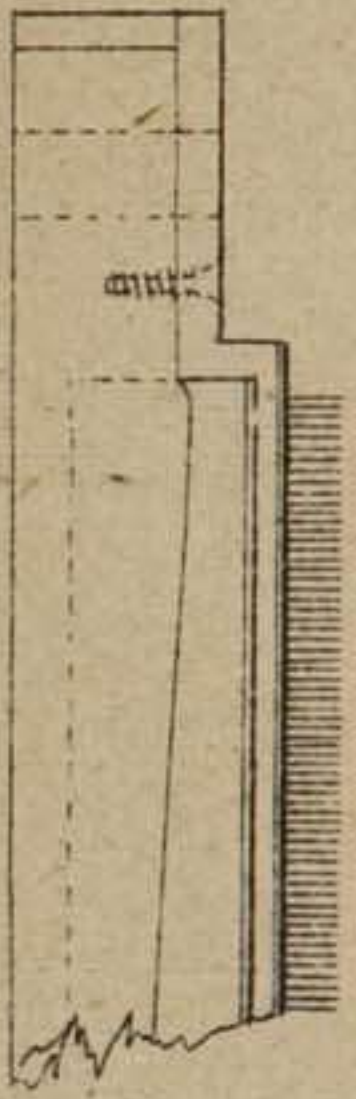
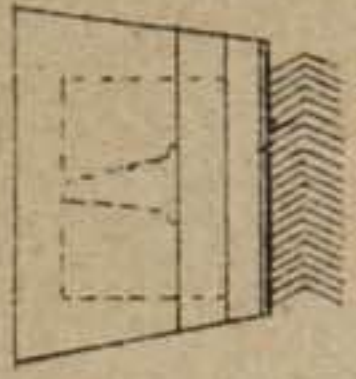


Fig. 116

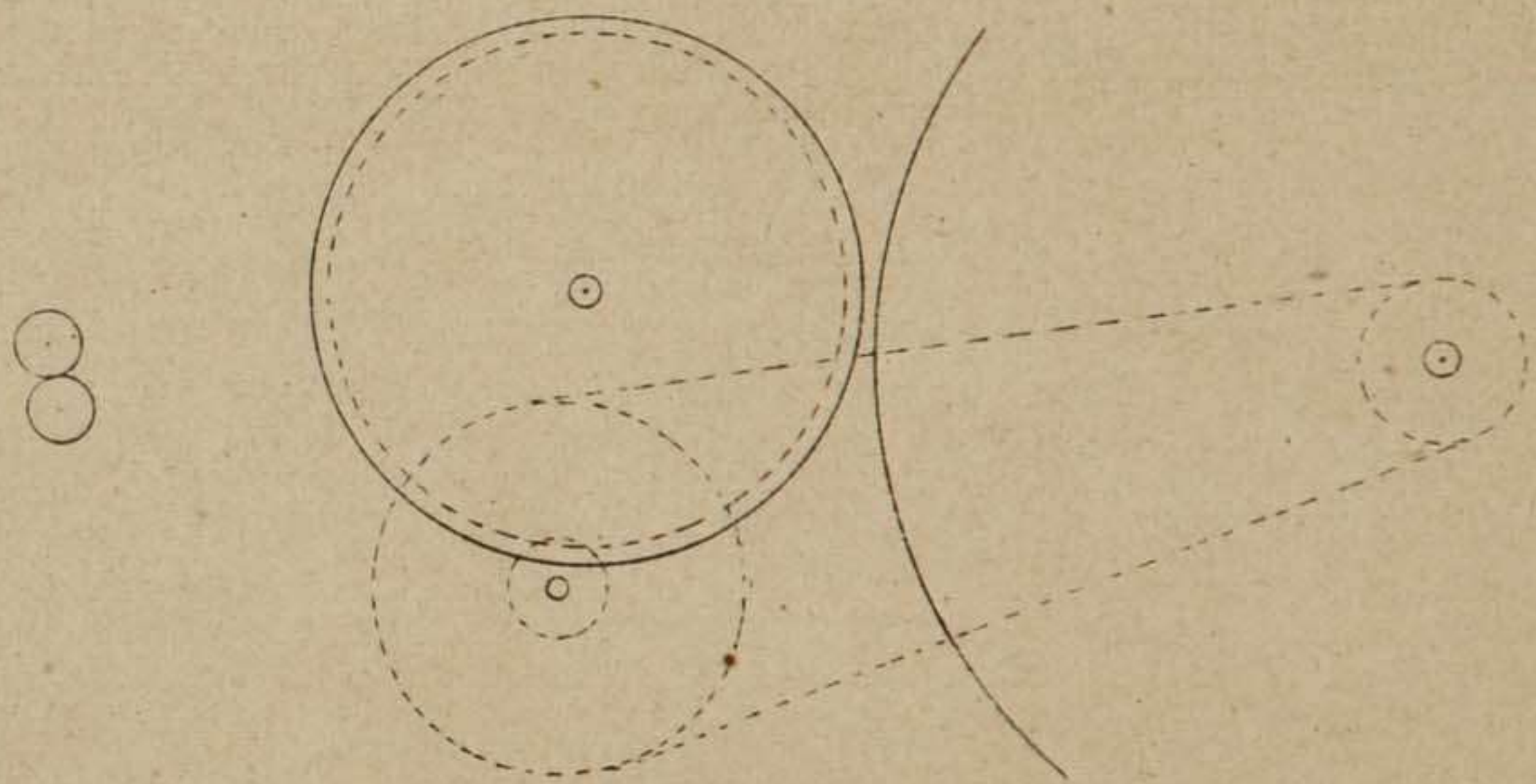


Fig. 117

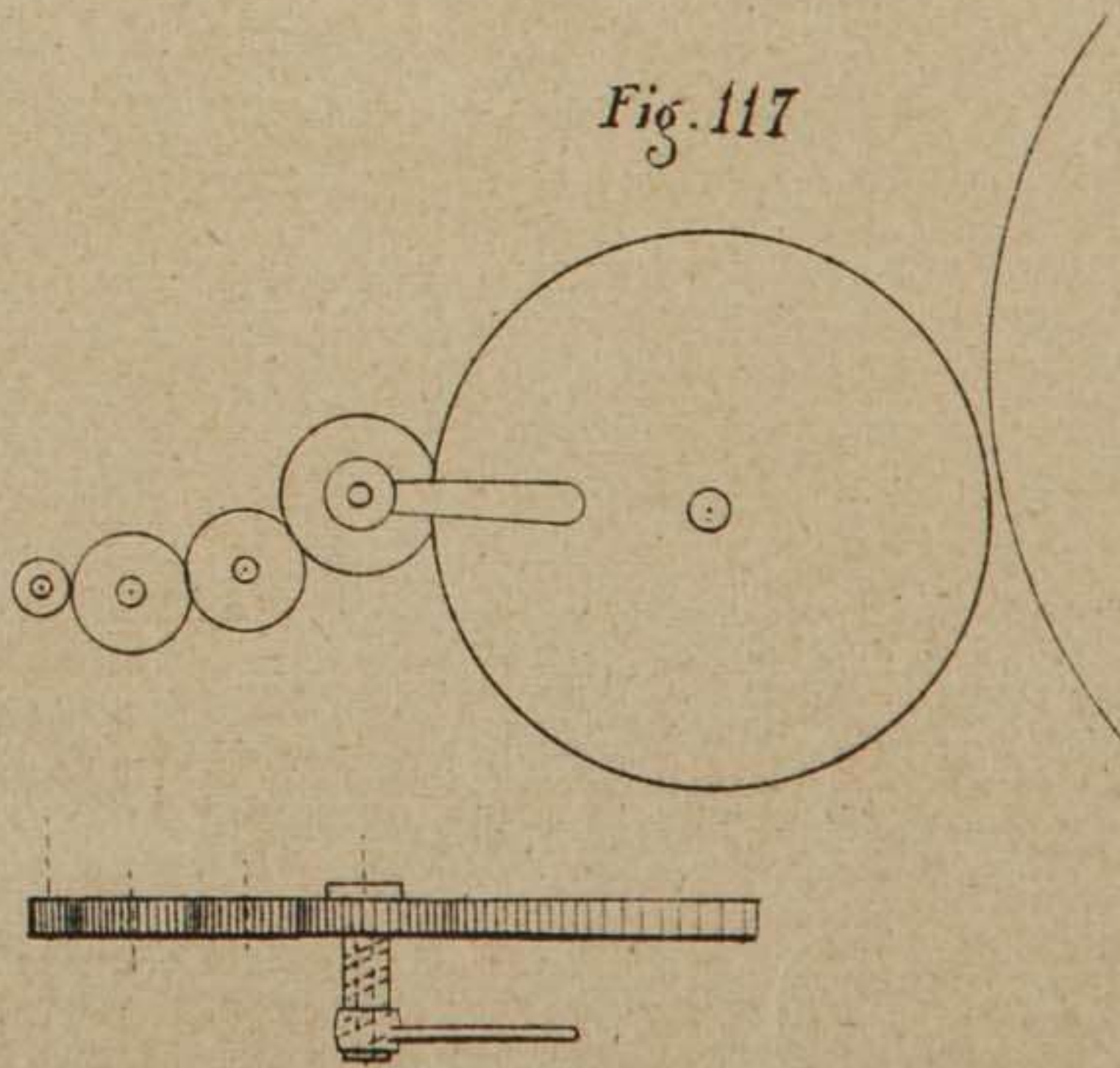


Fig. 118

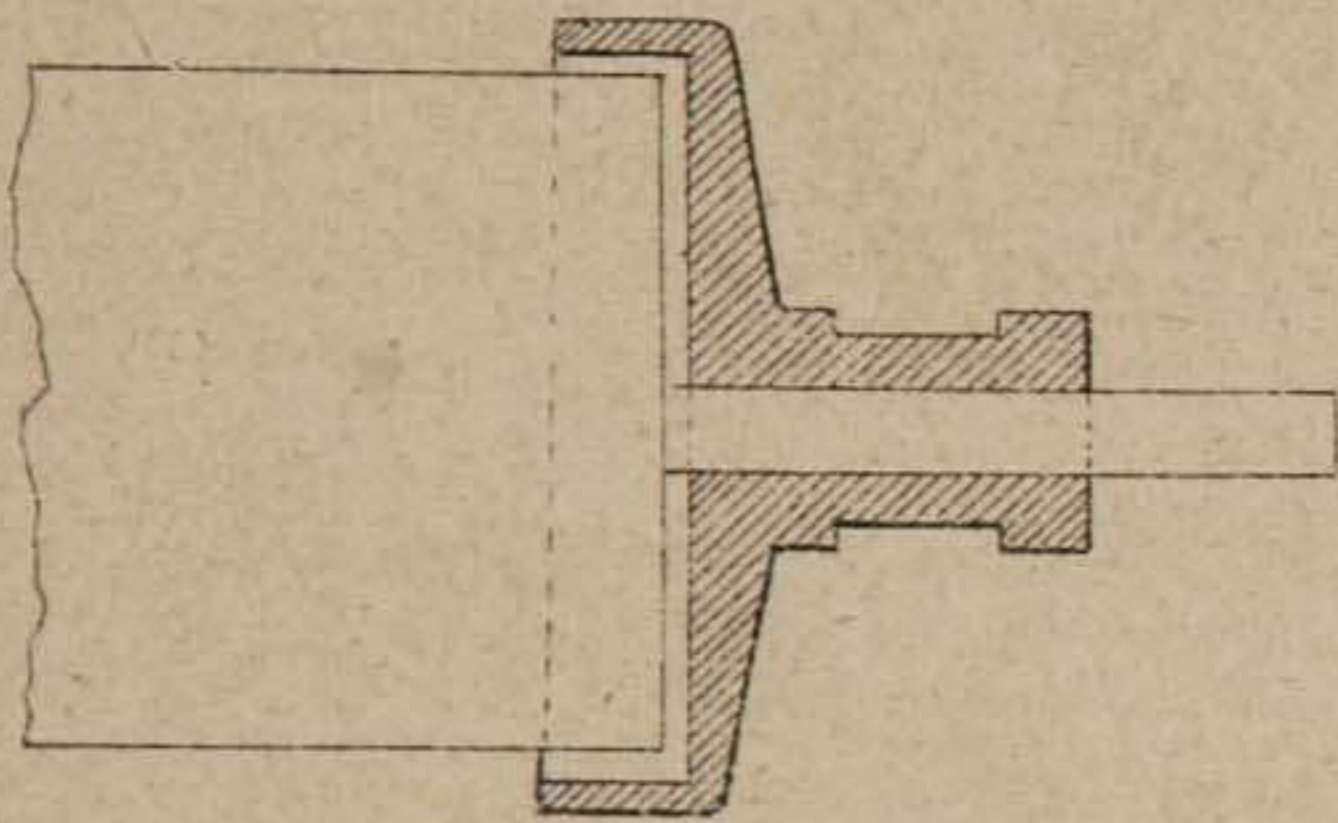


Fig. 119

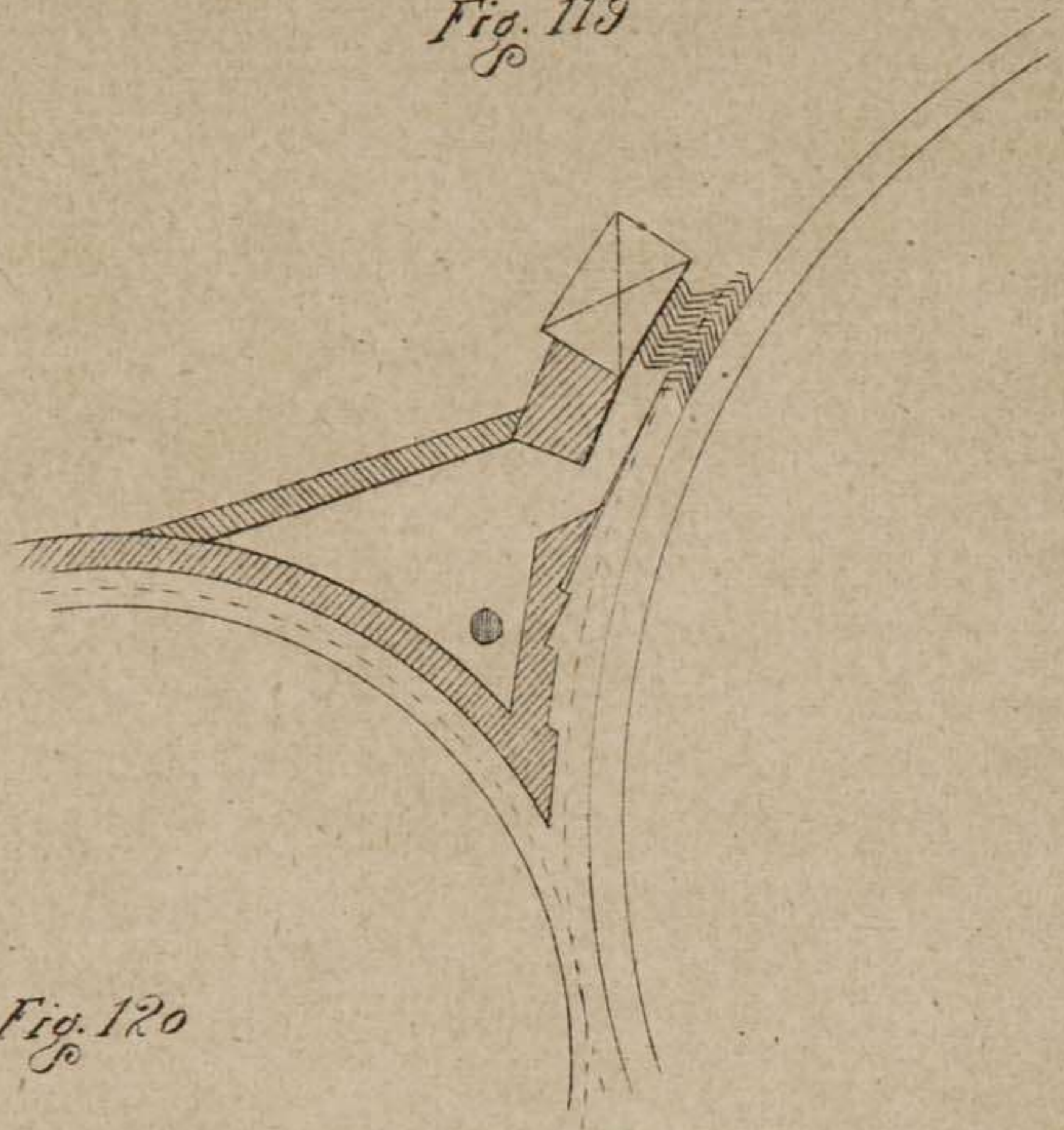
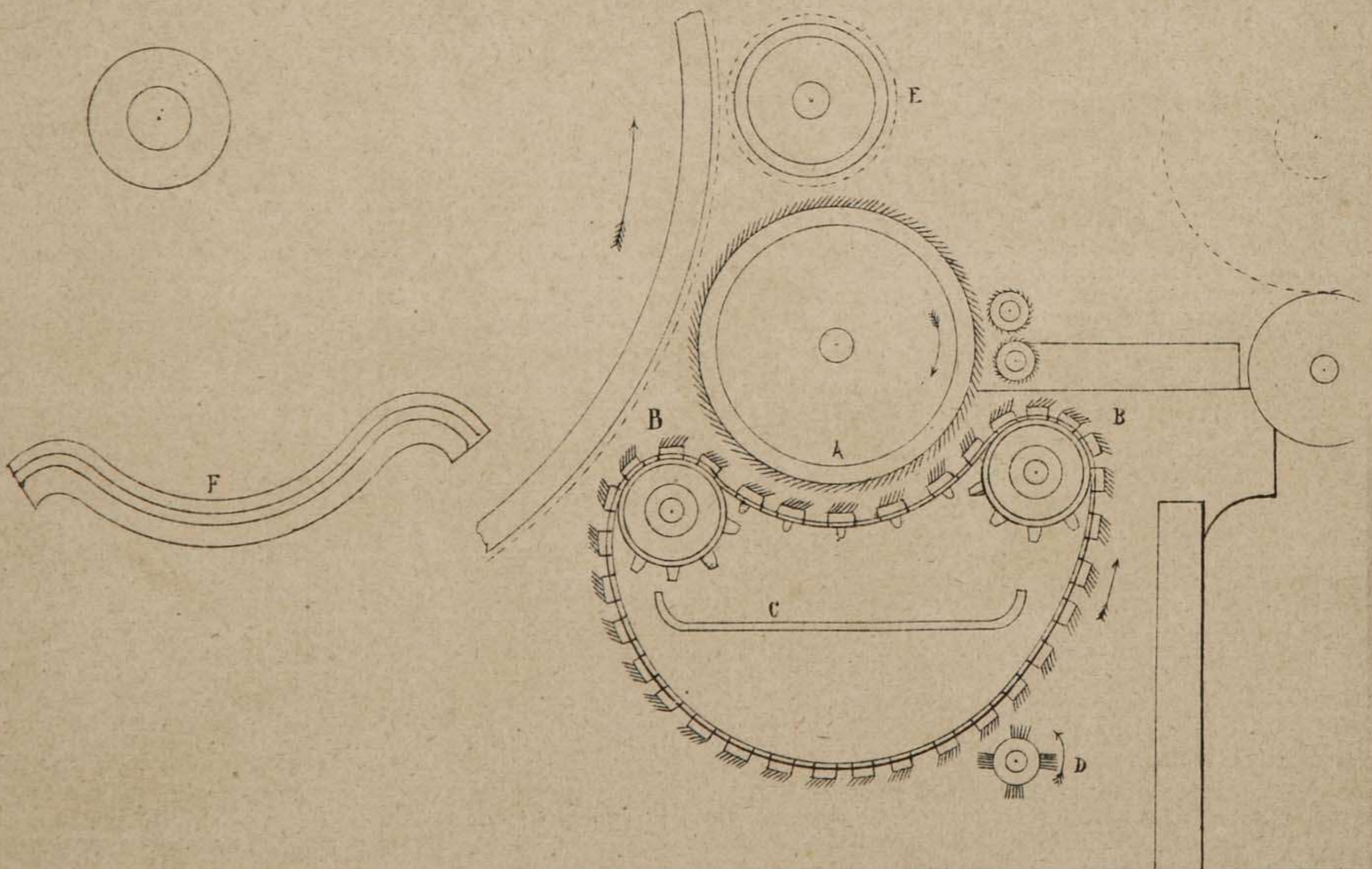


Fig. 120



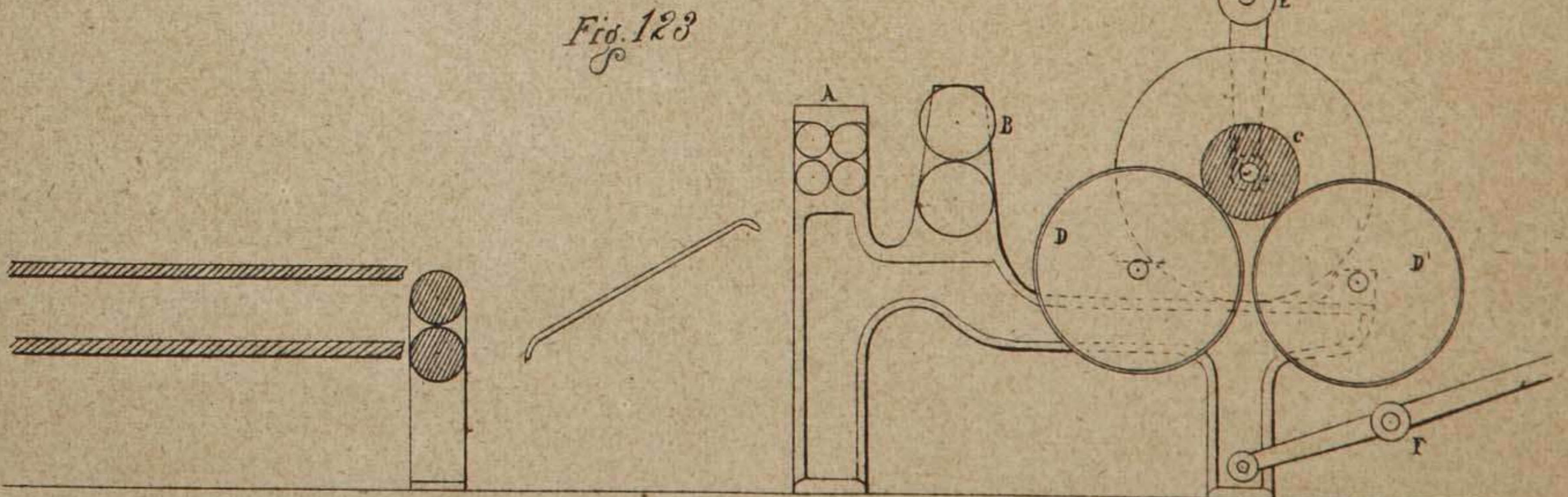
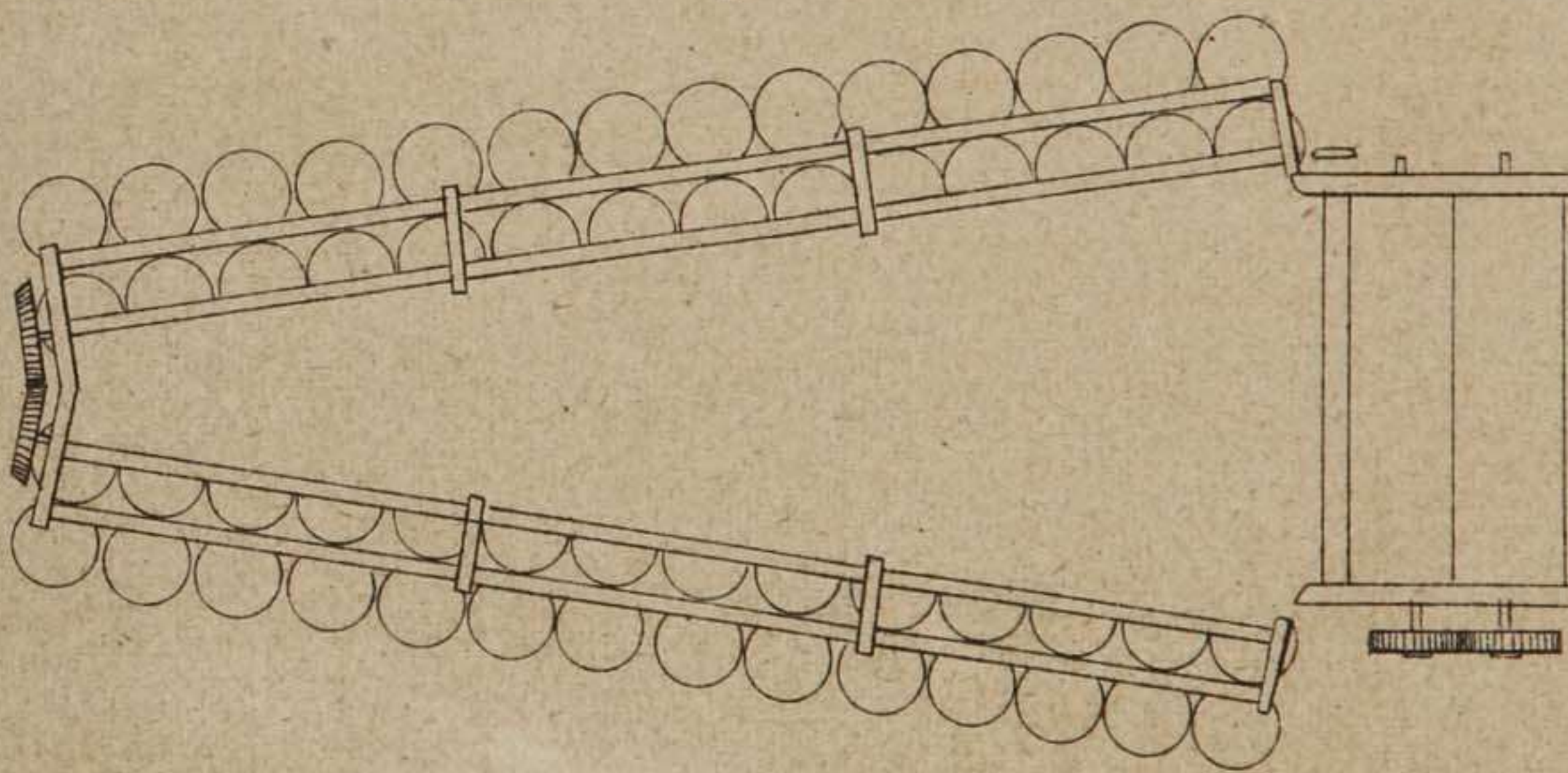
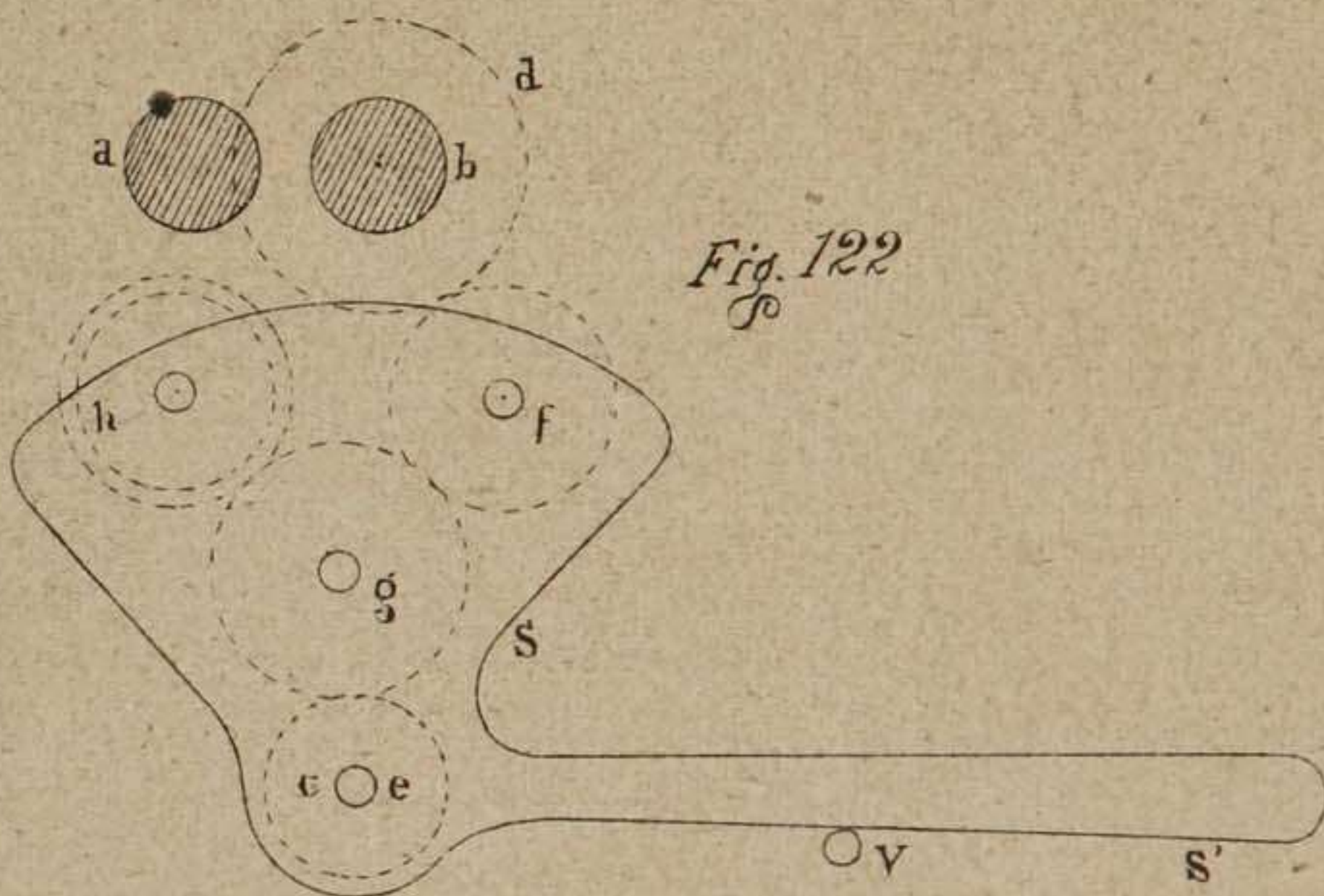
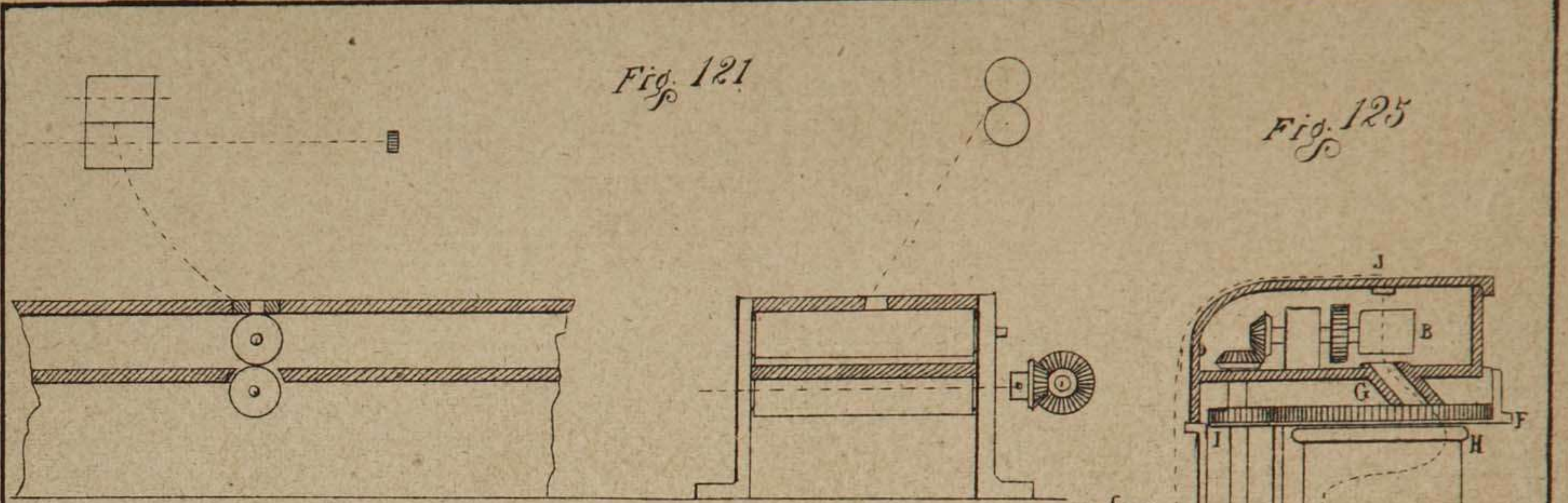


Fig. 126

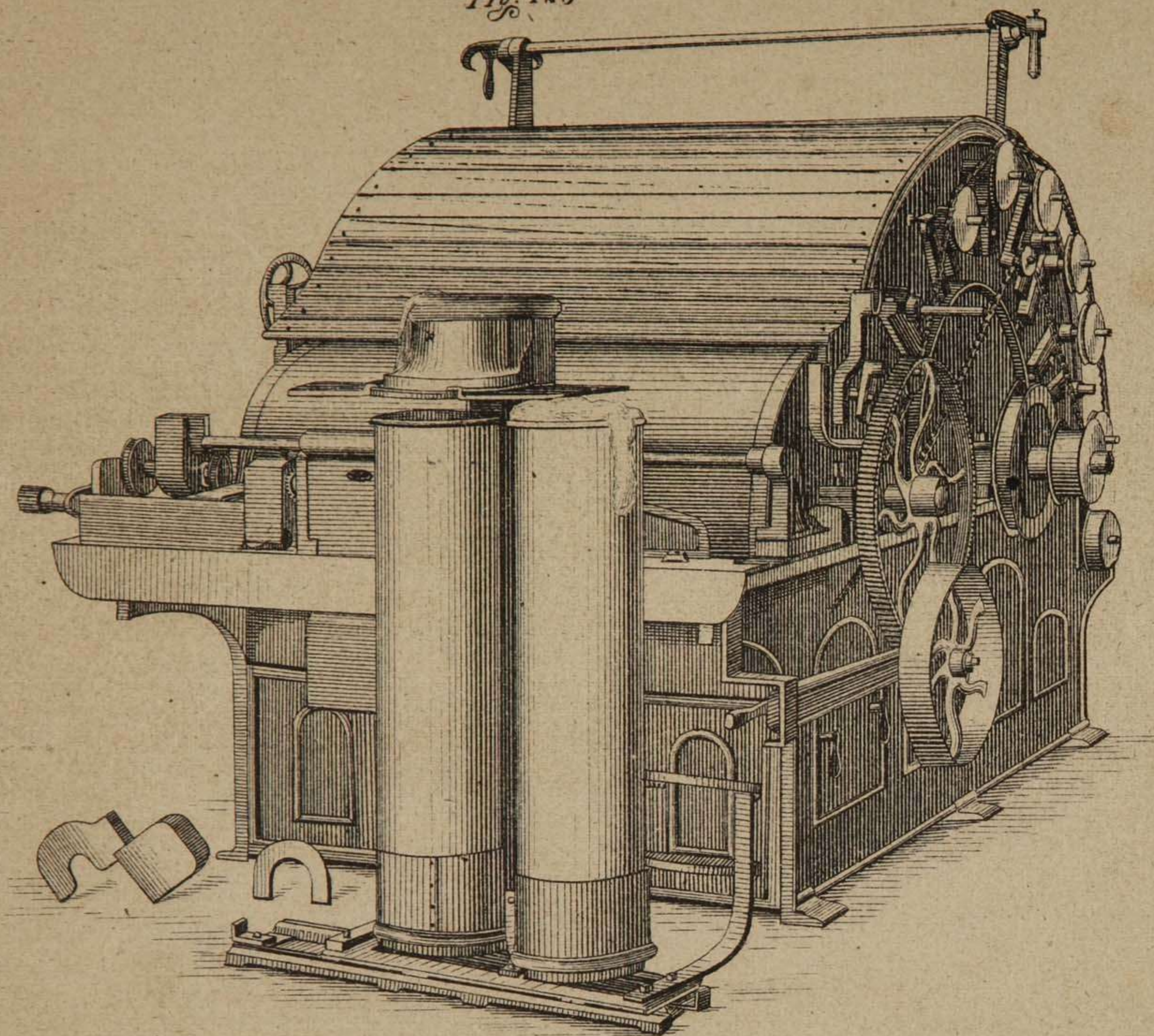
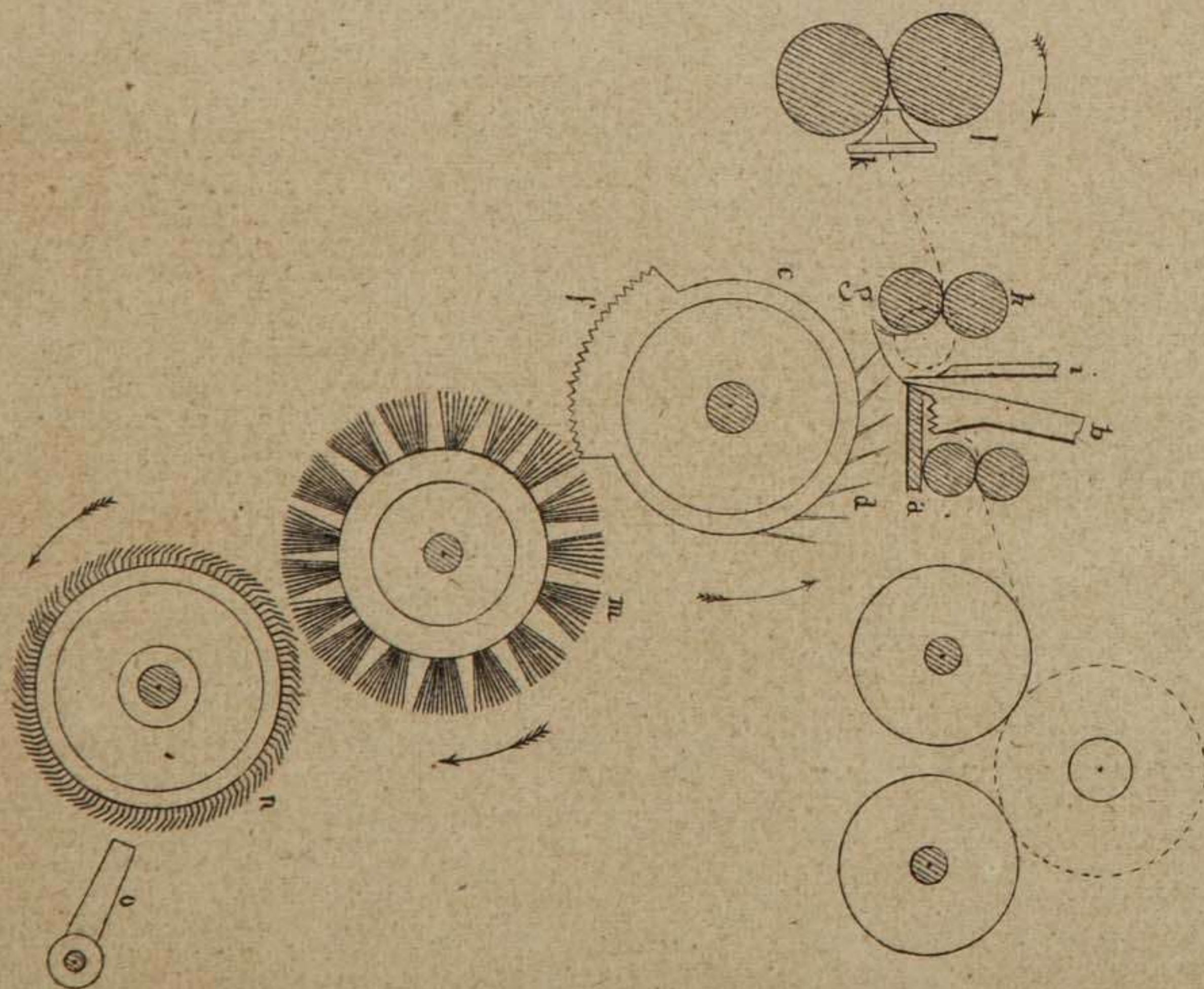


Fig. 127



8

Fig. 129

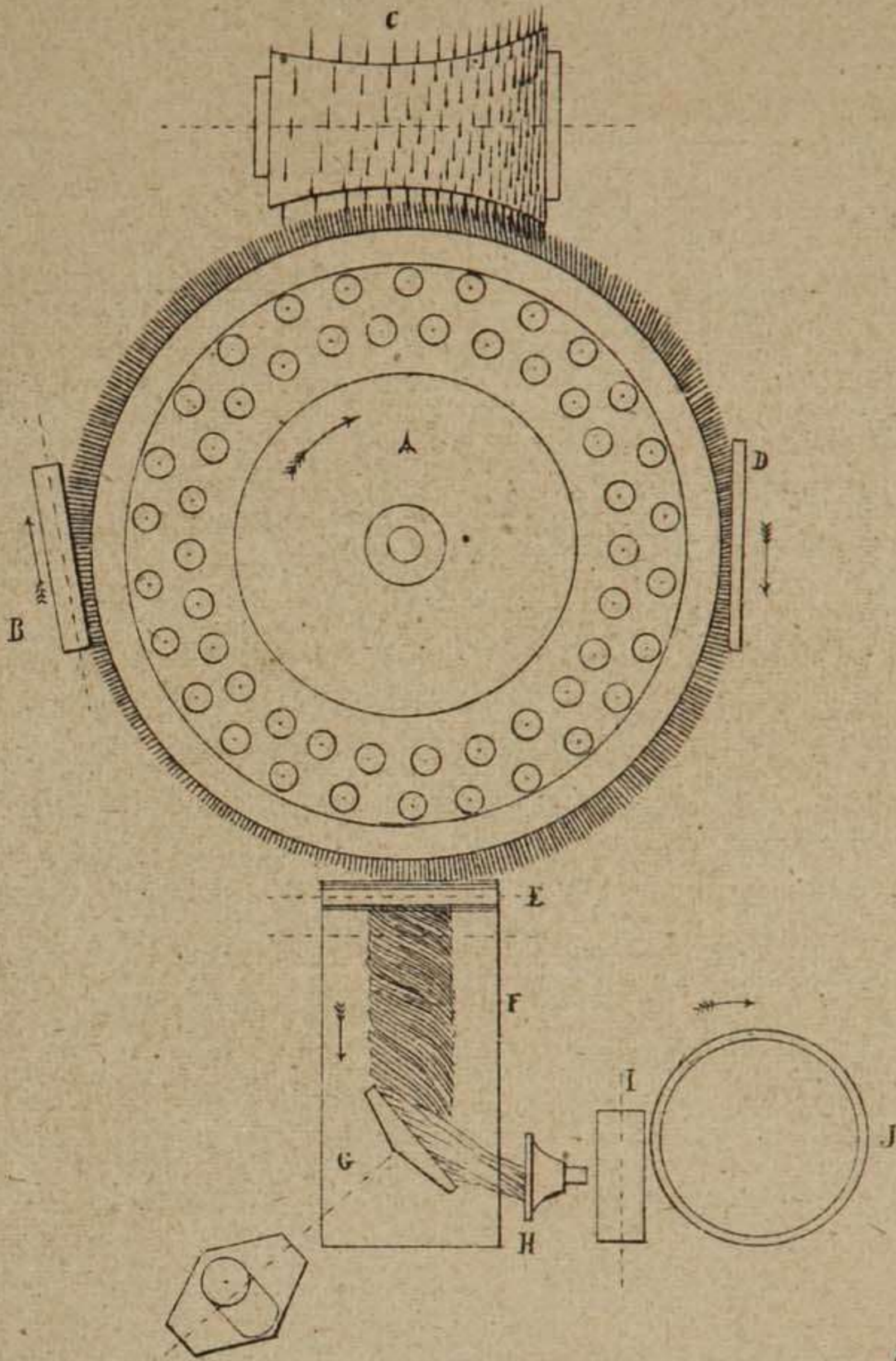


Fig. 130

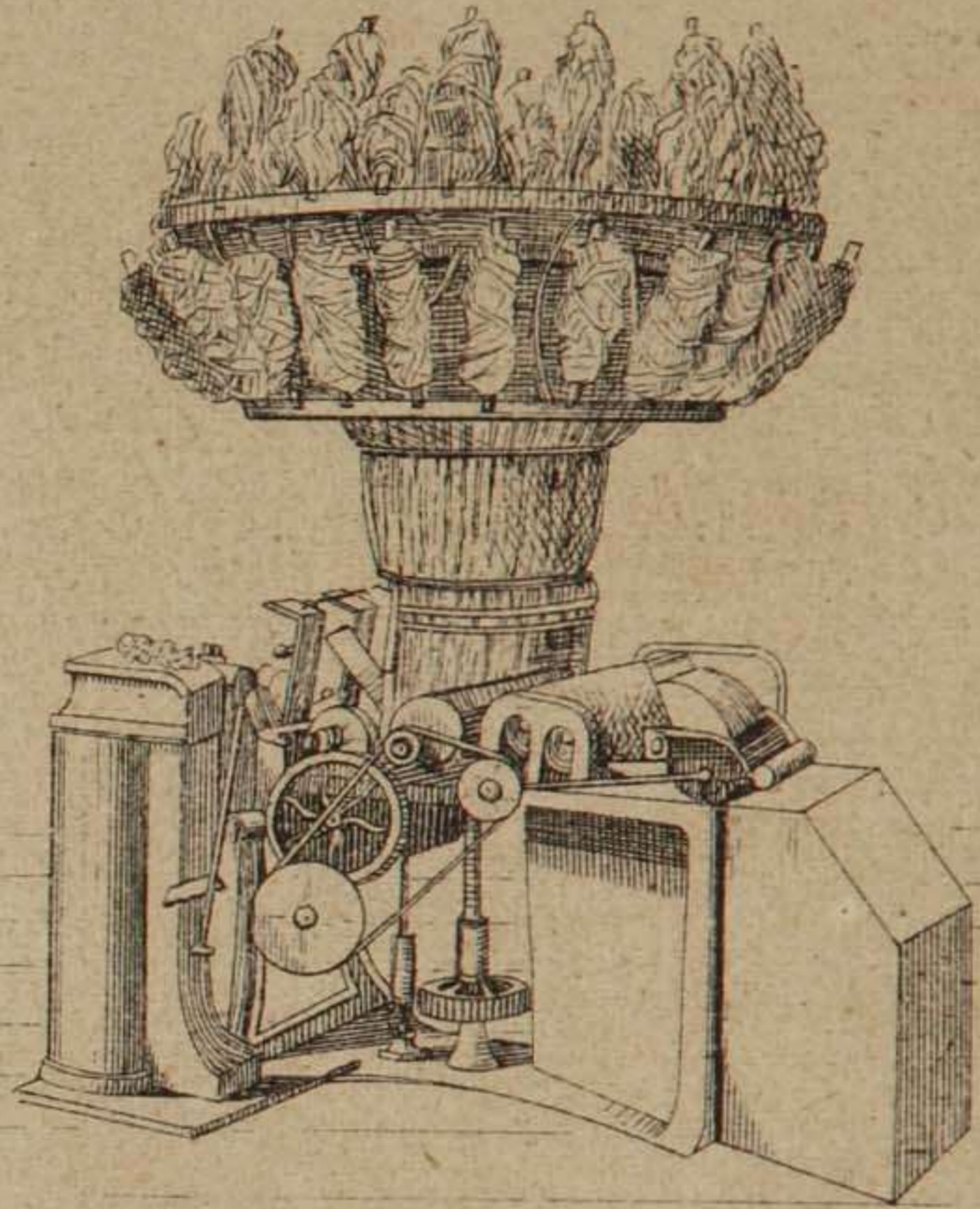


Fig. 128

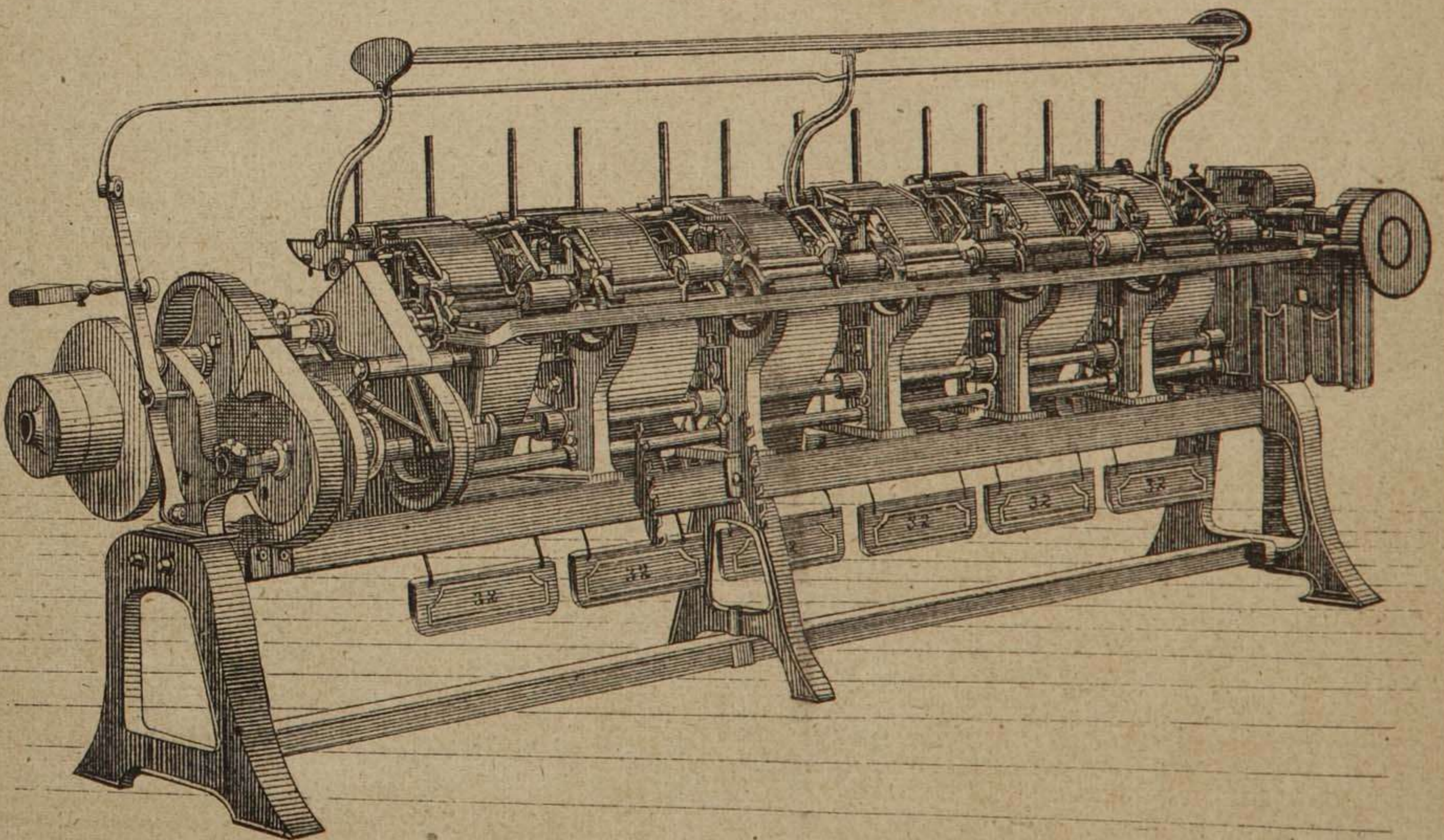


Fig. 131

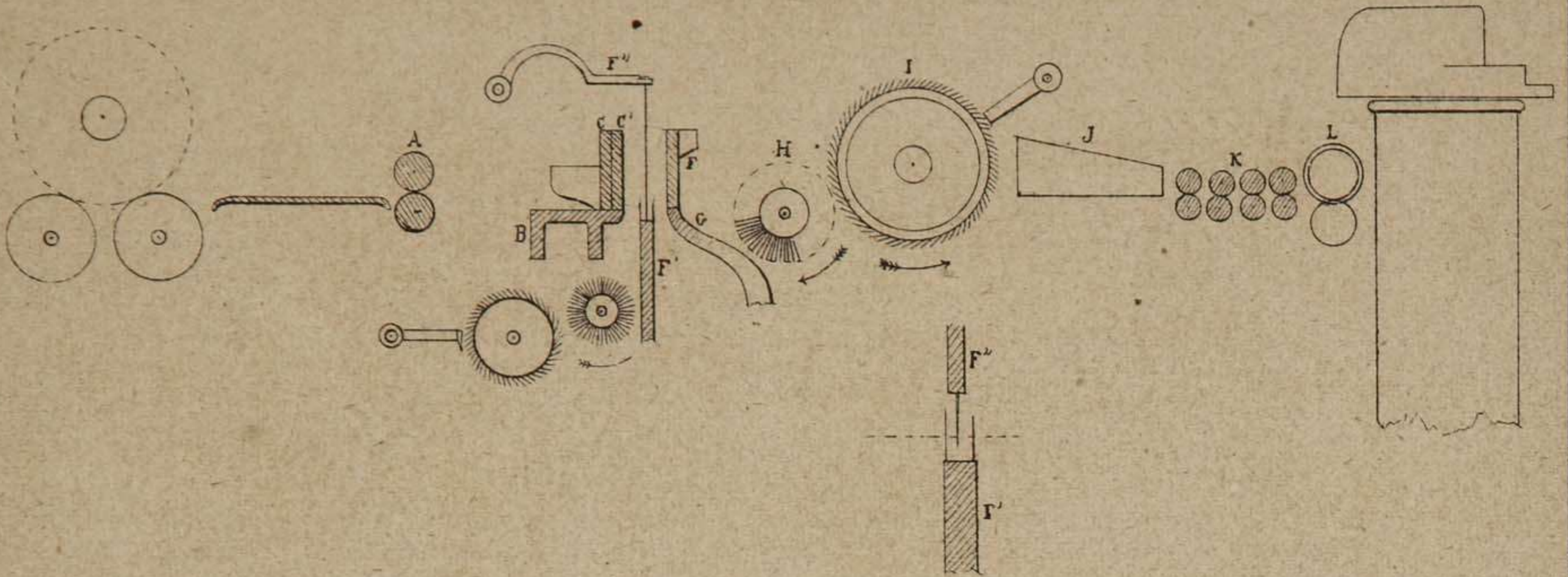


Fig. 132

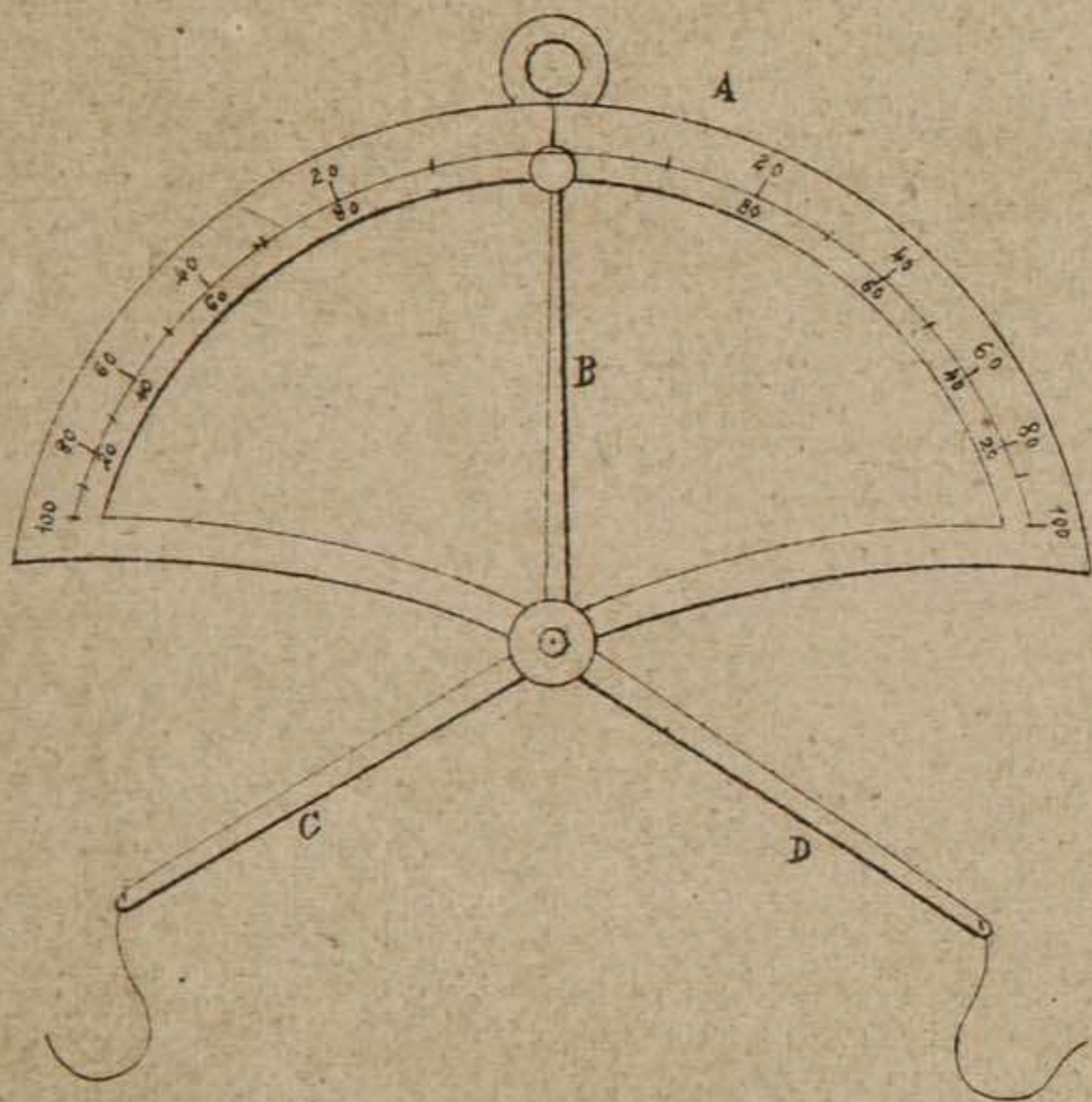


Fig. 134



Fig. 133

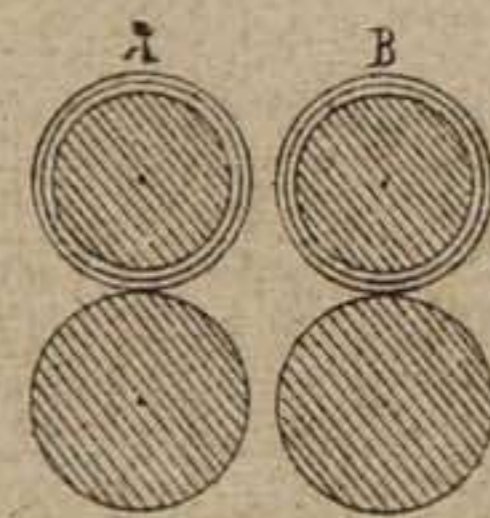


Fig. 135

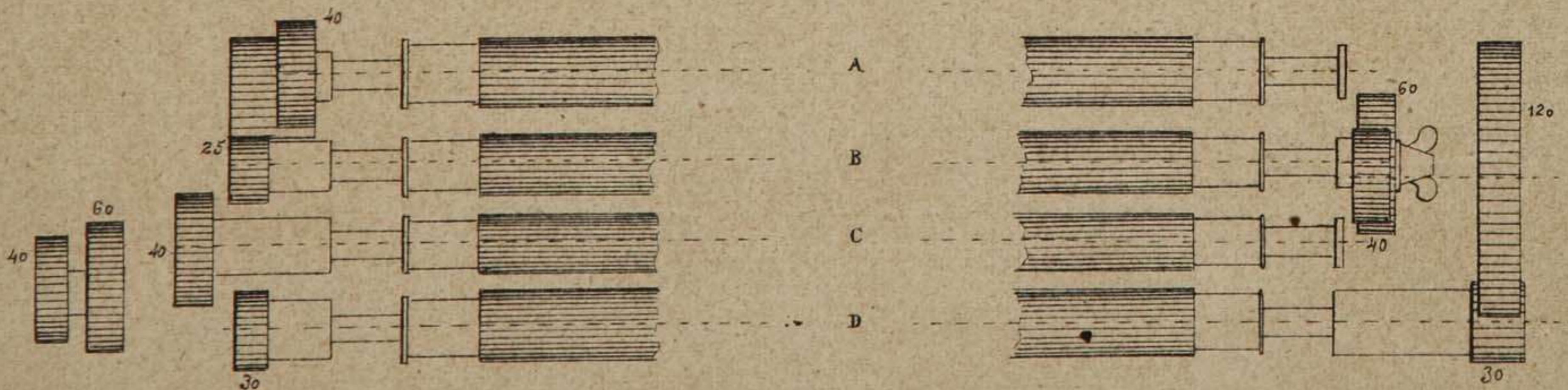


Fig. 136

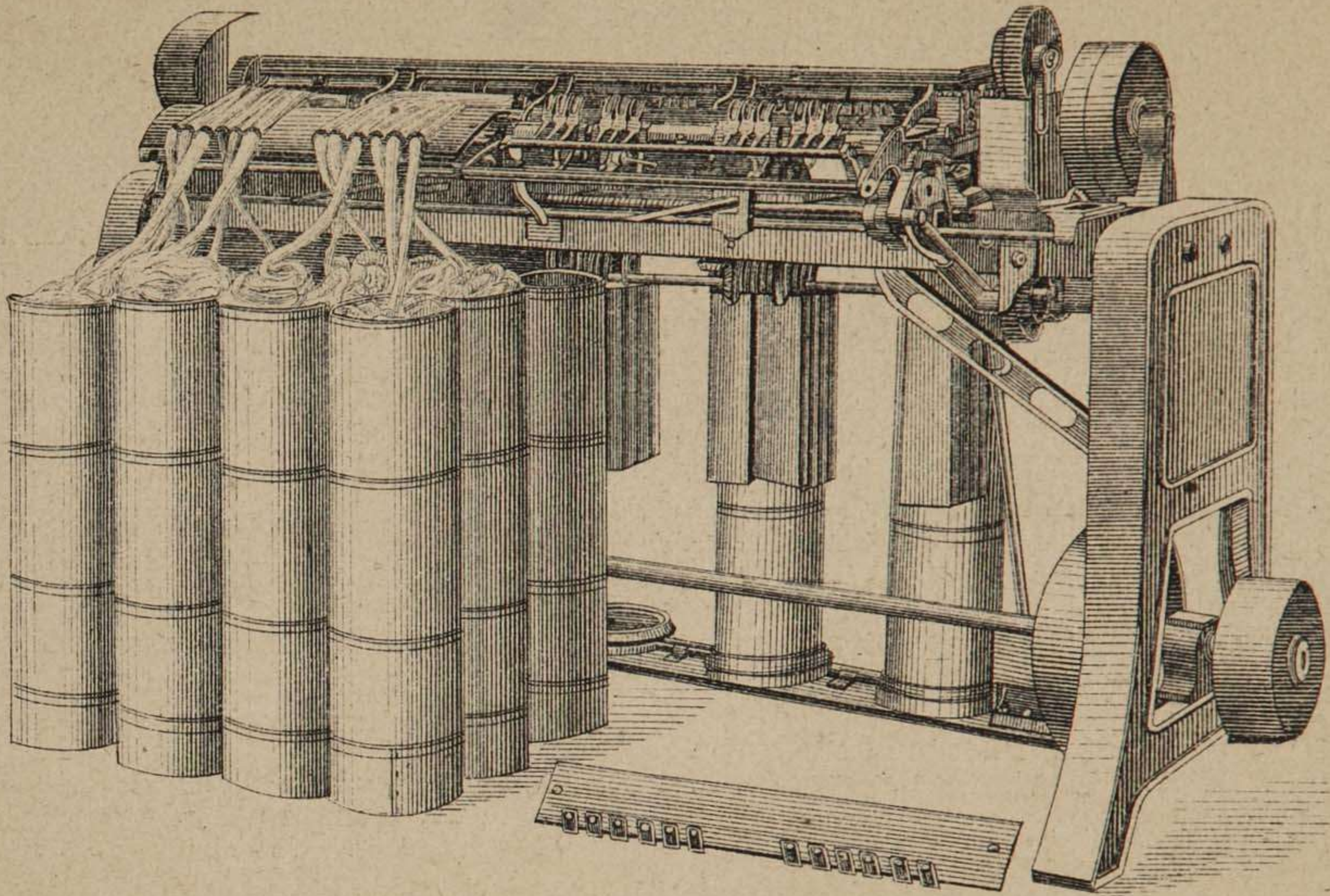


Fig. 137

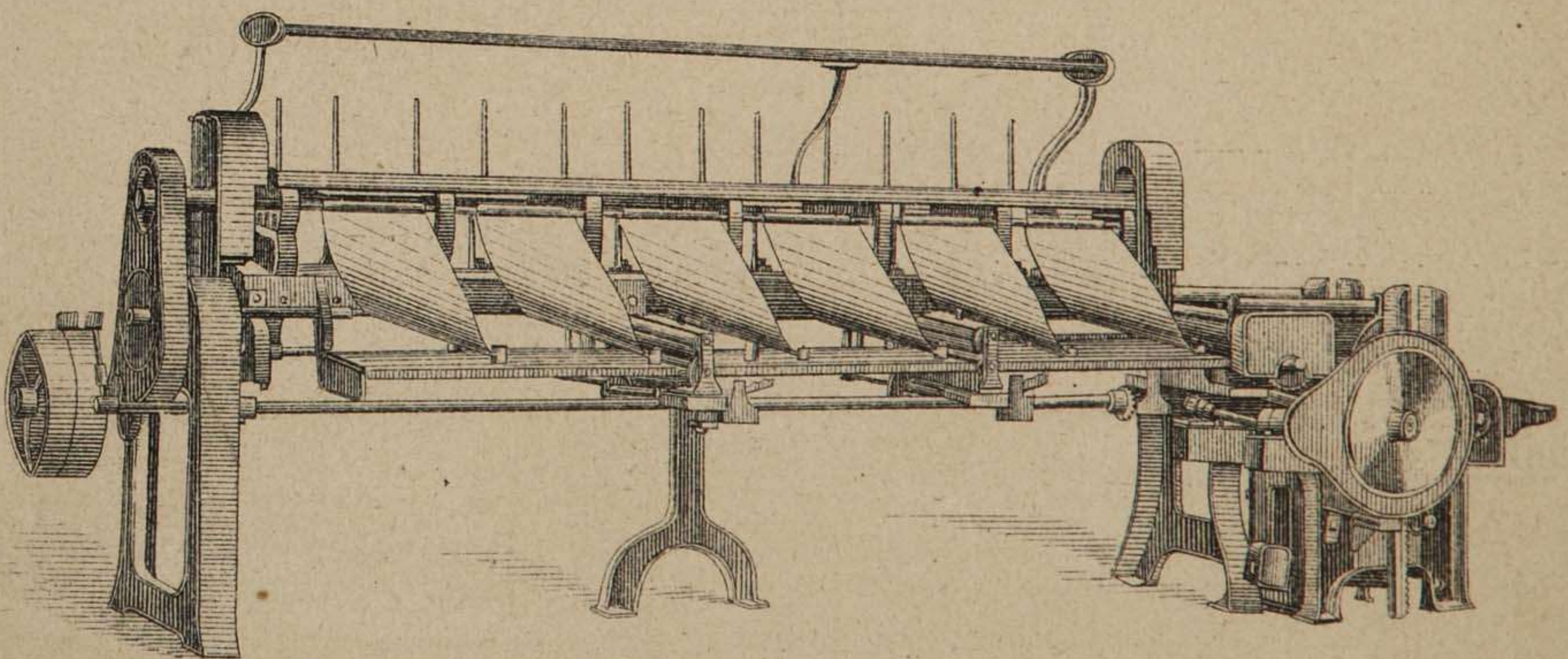


Fig. 138.

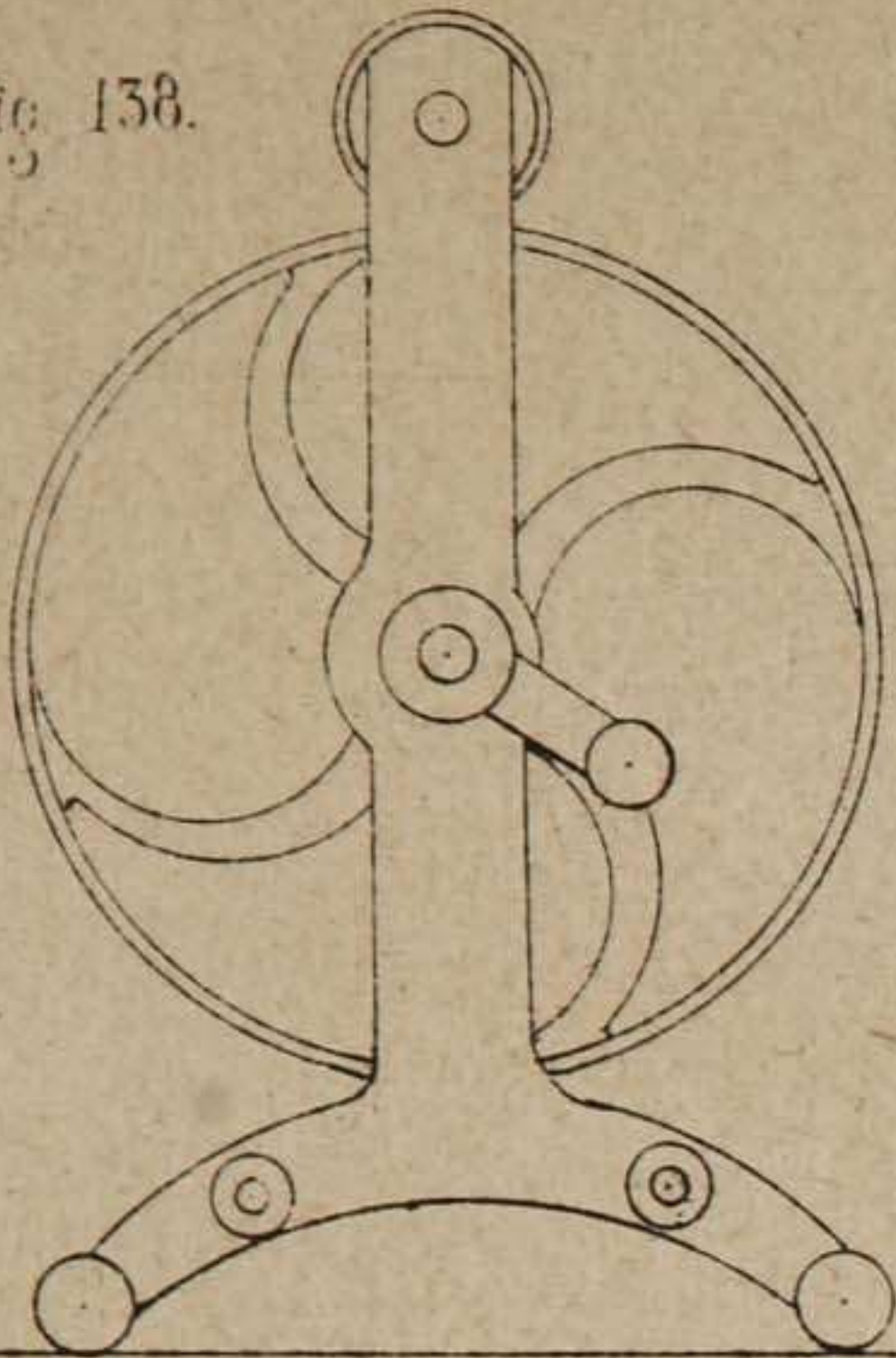


Fig. 139.

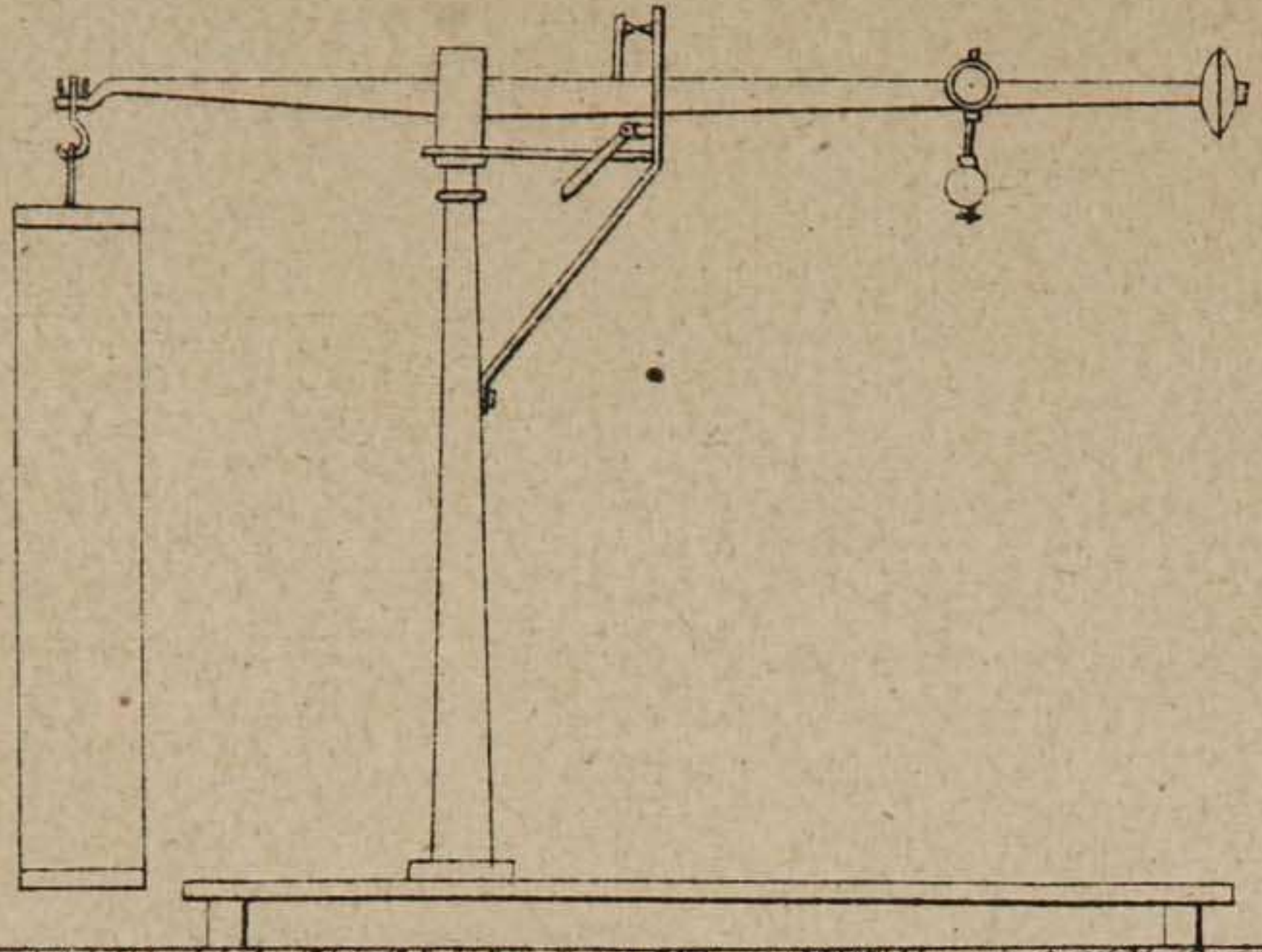


Fig. 140.

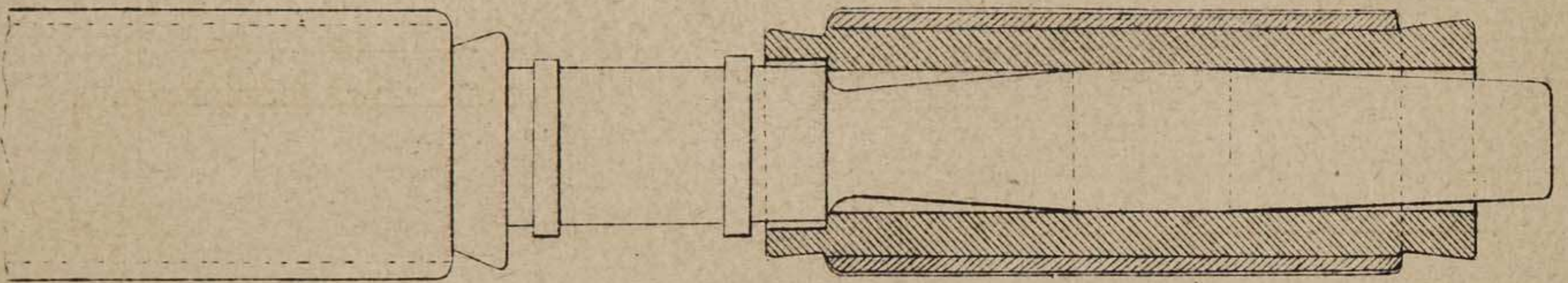


Fig. 141.

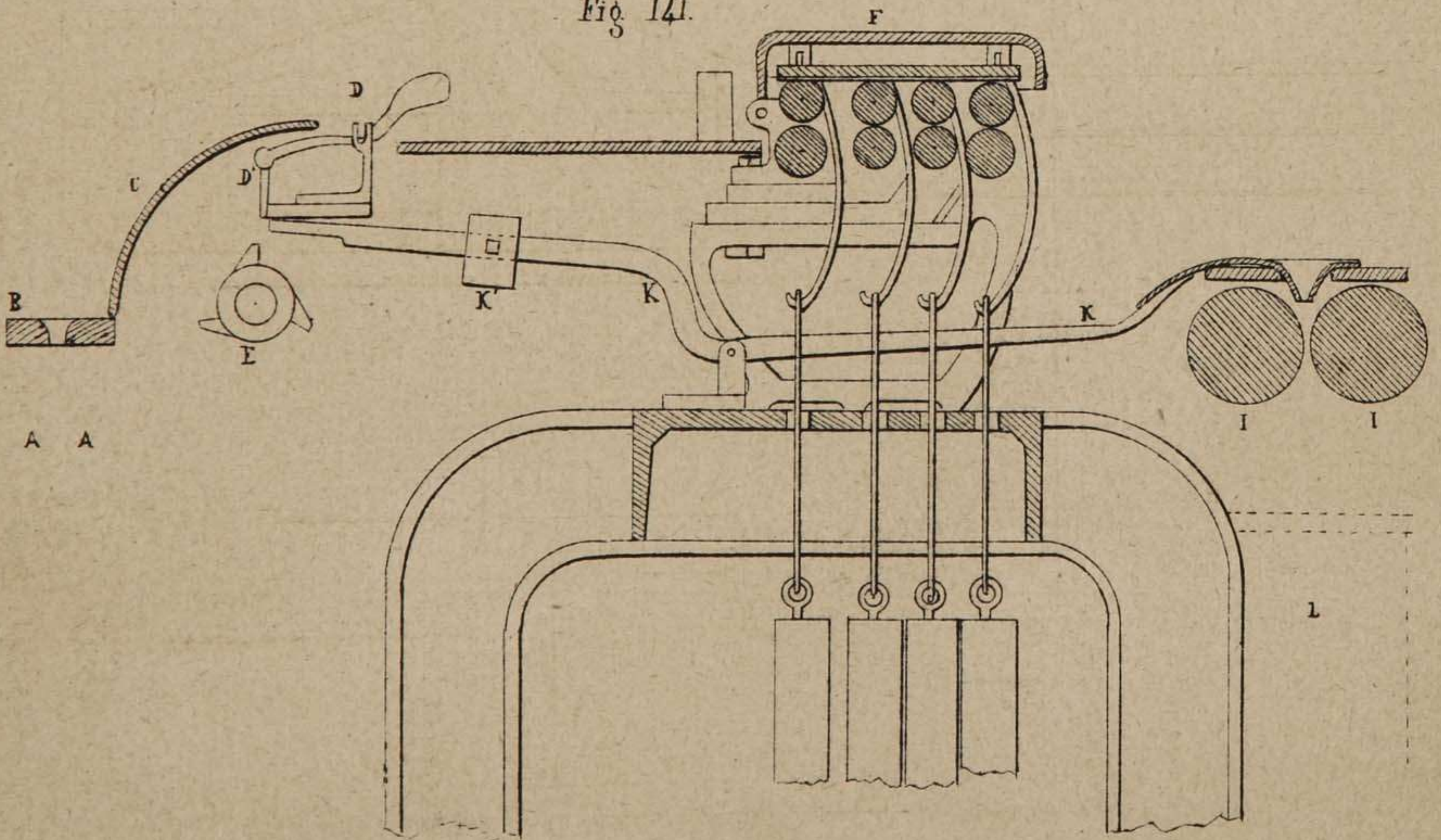


Fig. 143.

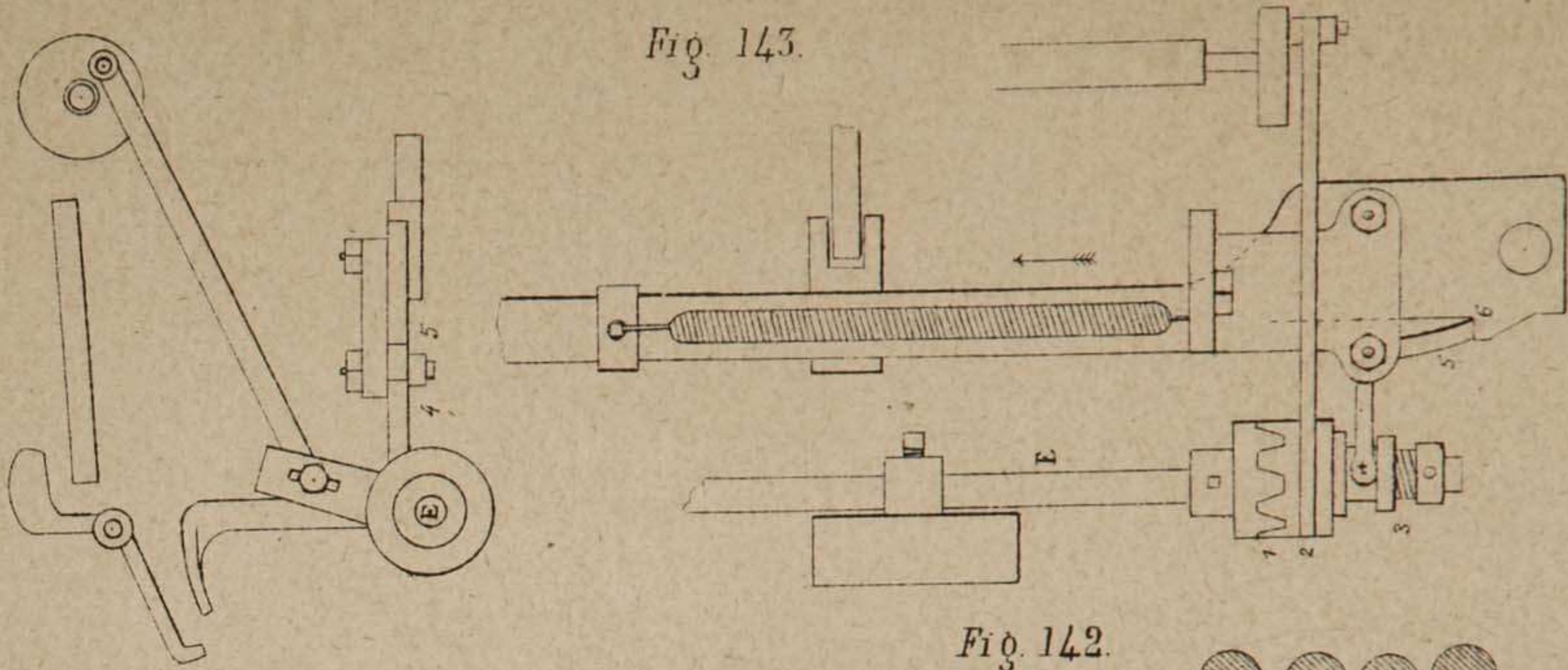


Fig. 142.

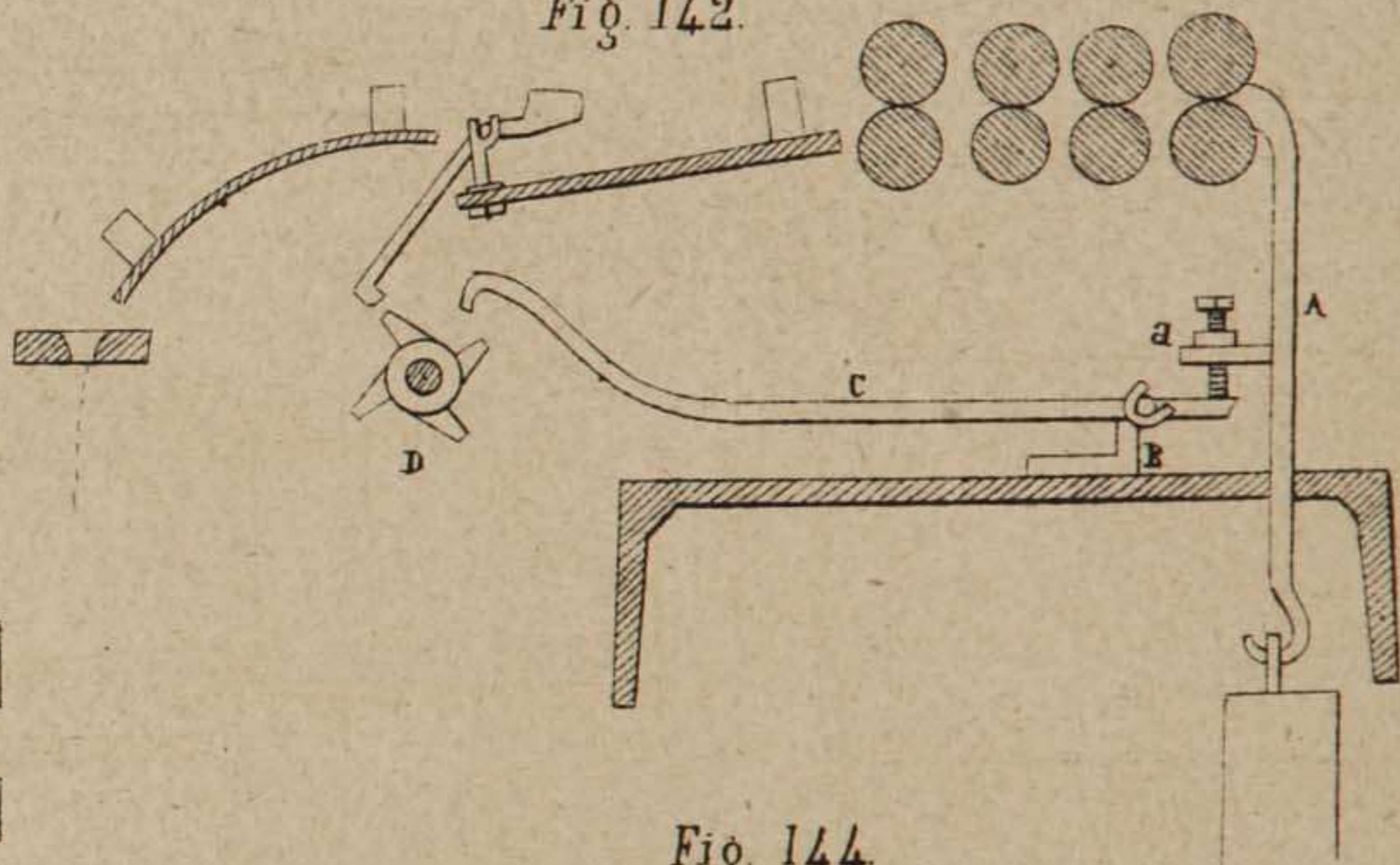


Fig. 145.

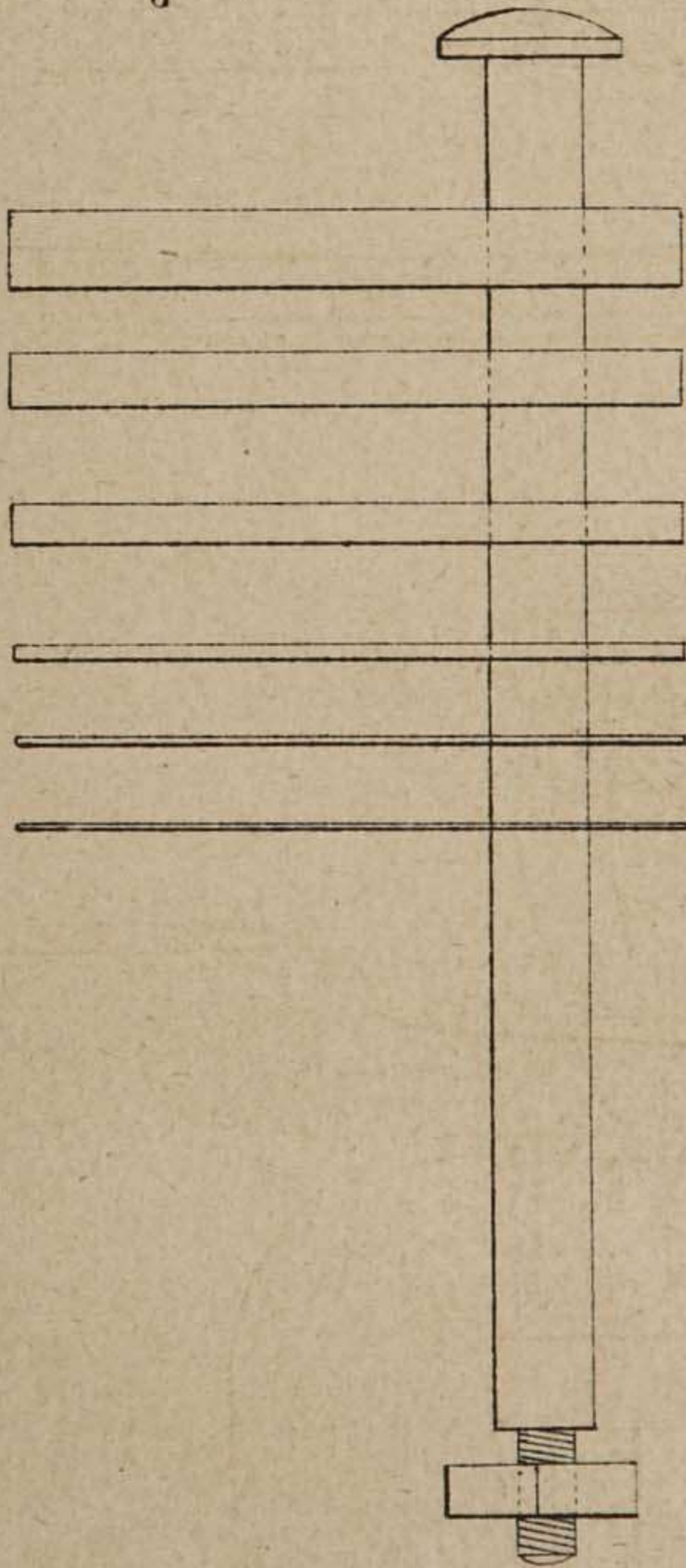


Fig. 144.

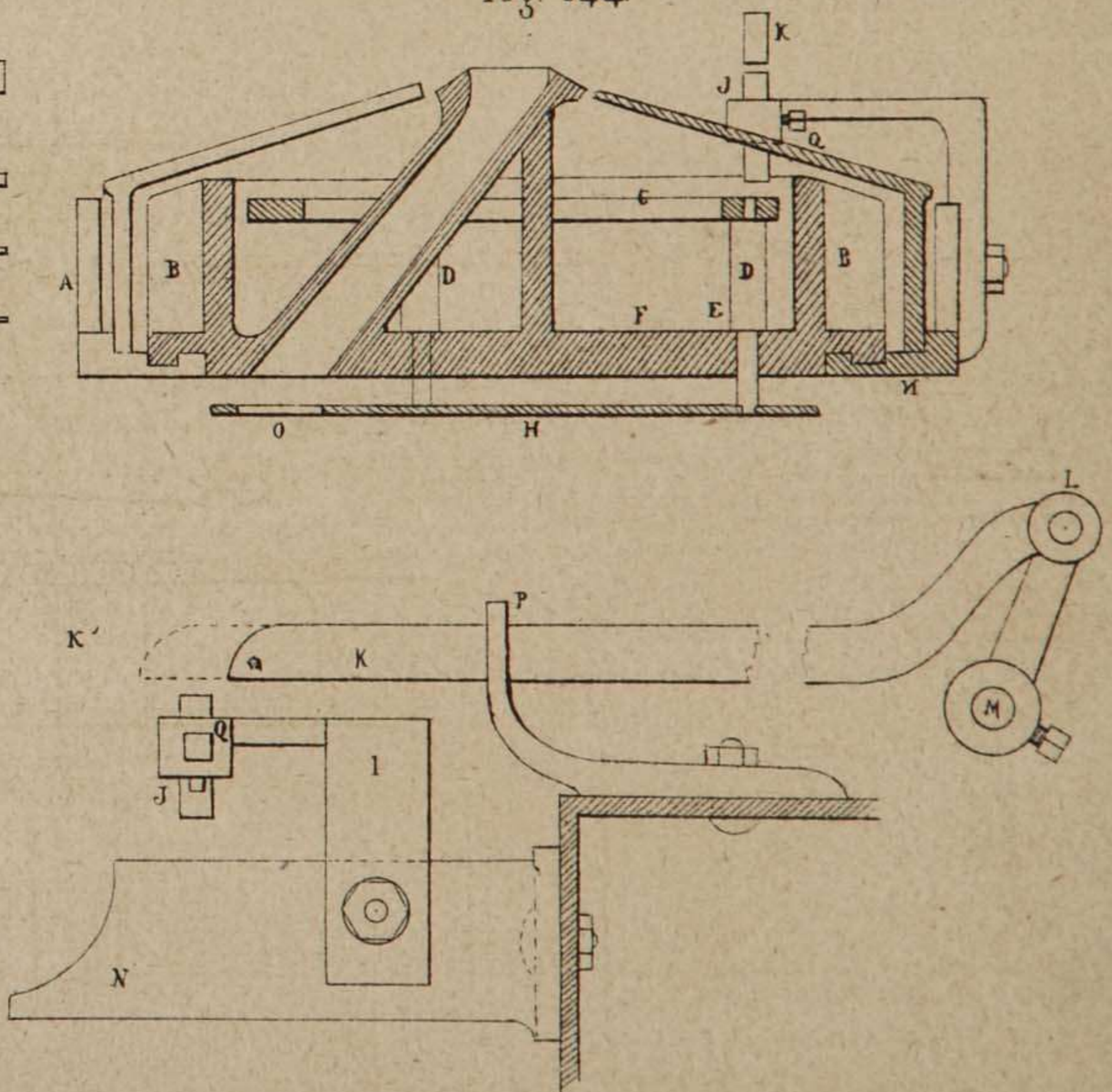


Fig. 148.

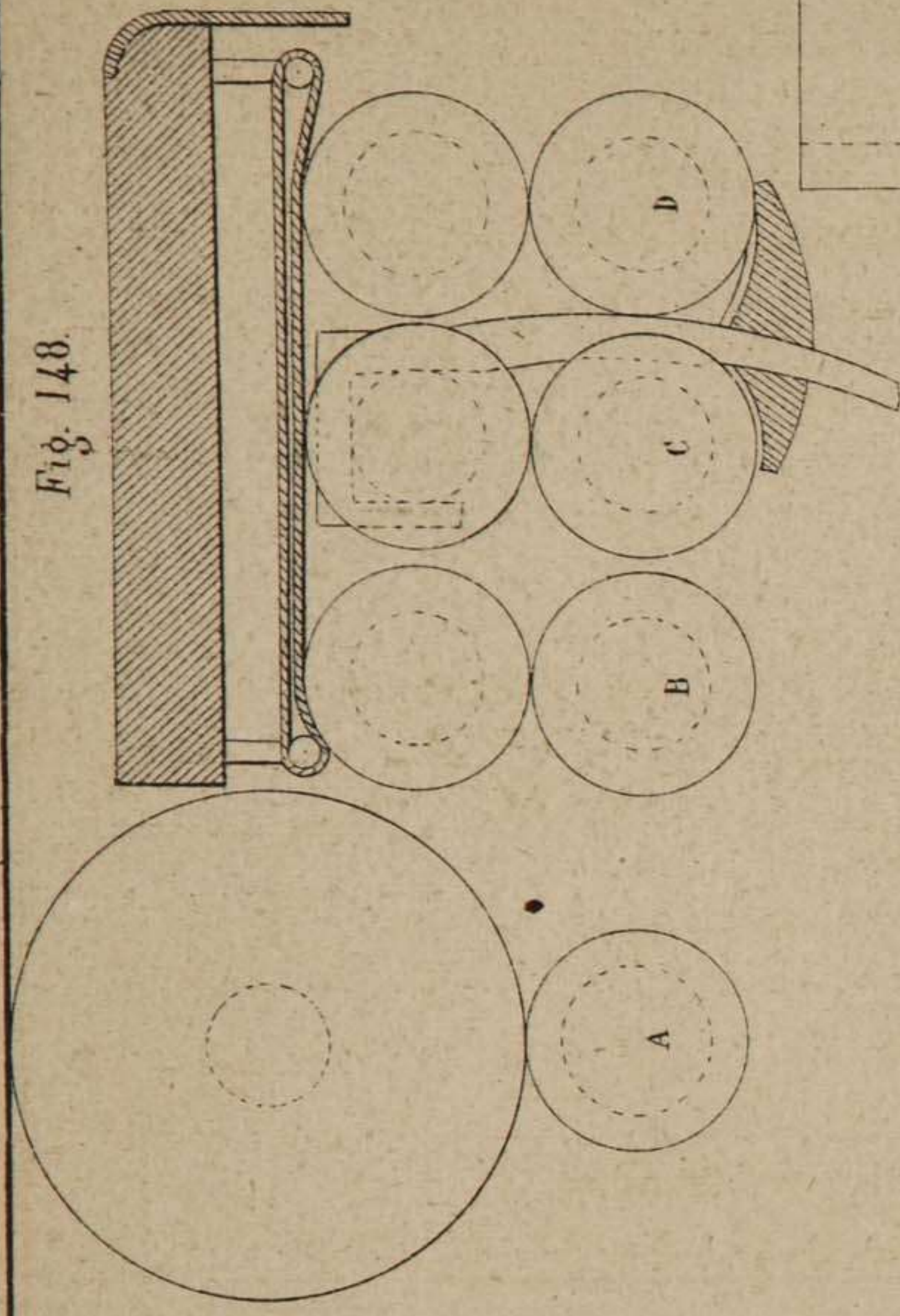


Fig. 146.

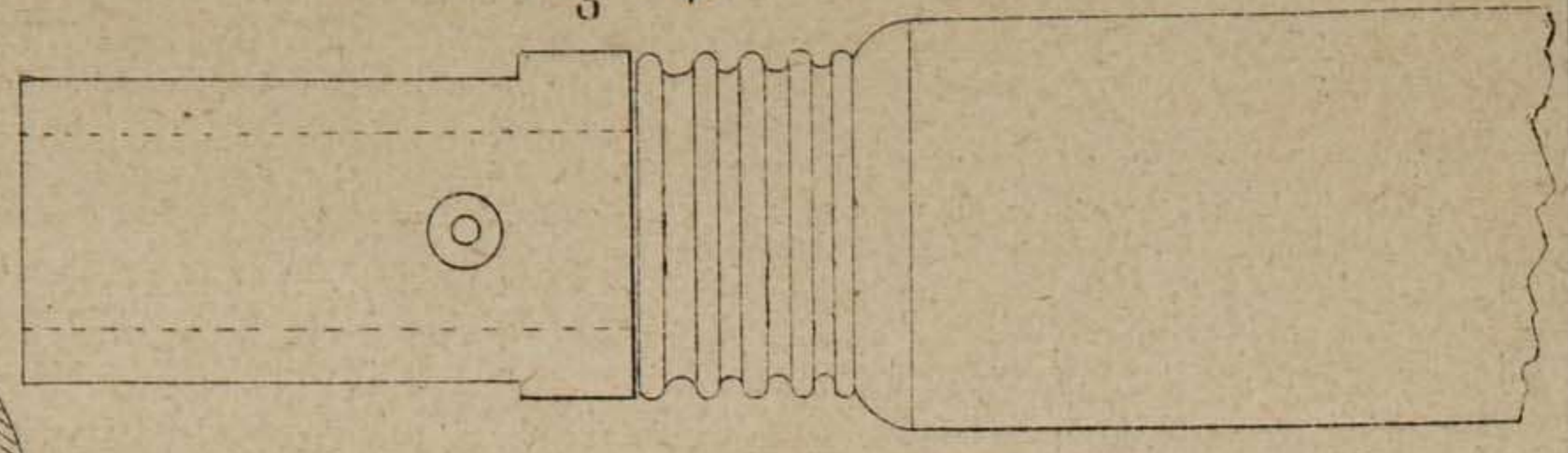


Fig. 150.

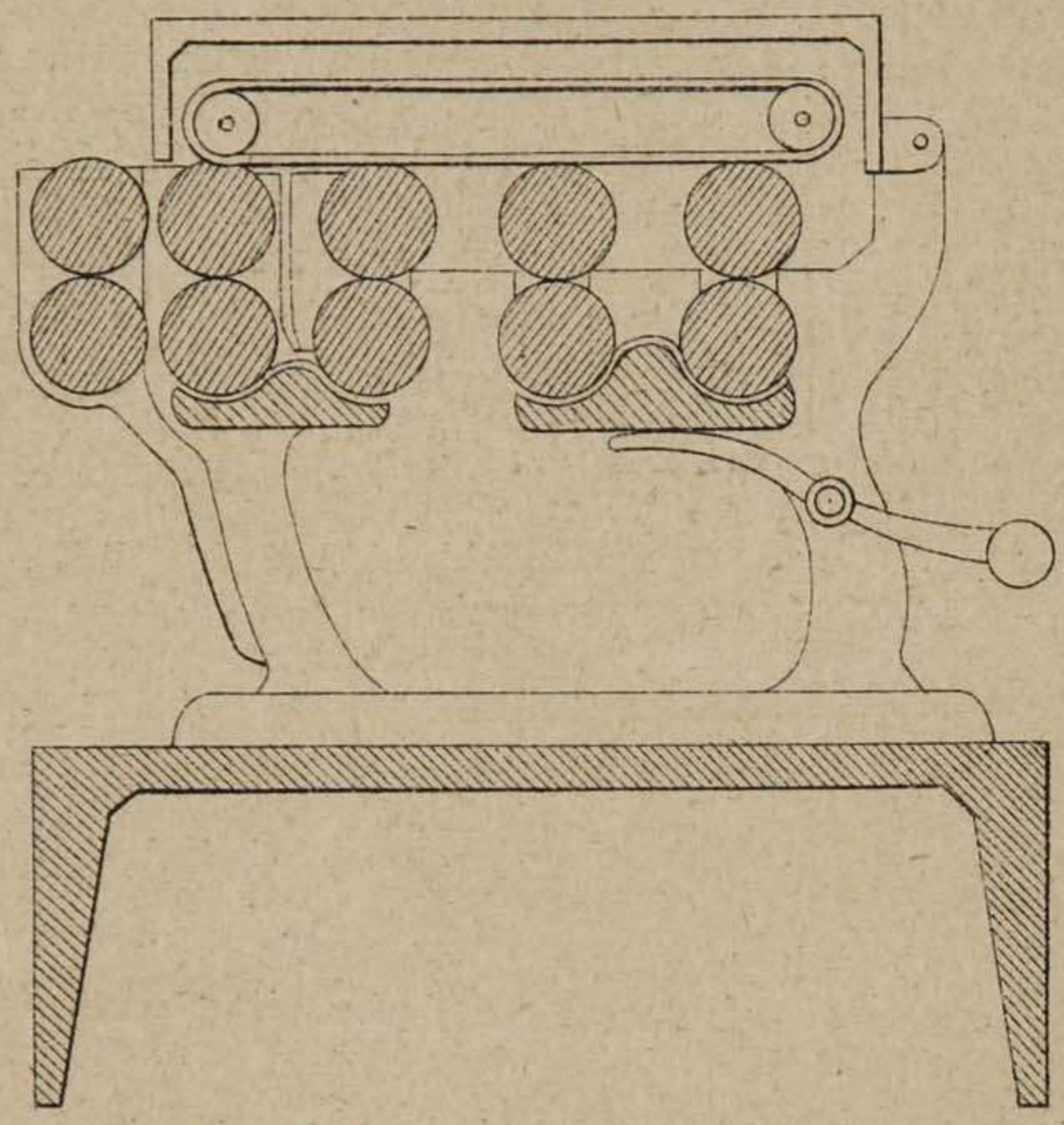


Fig. 147.

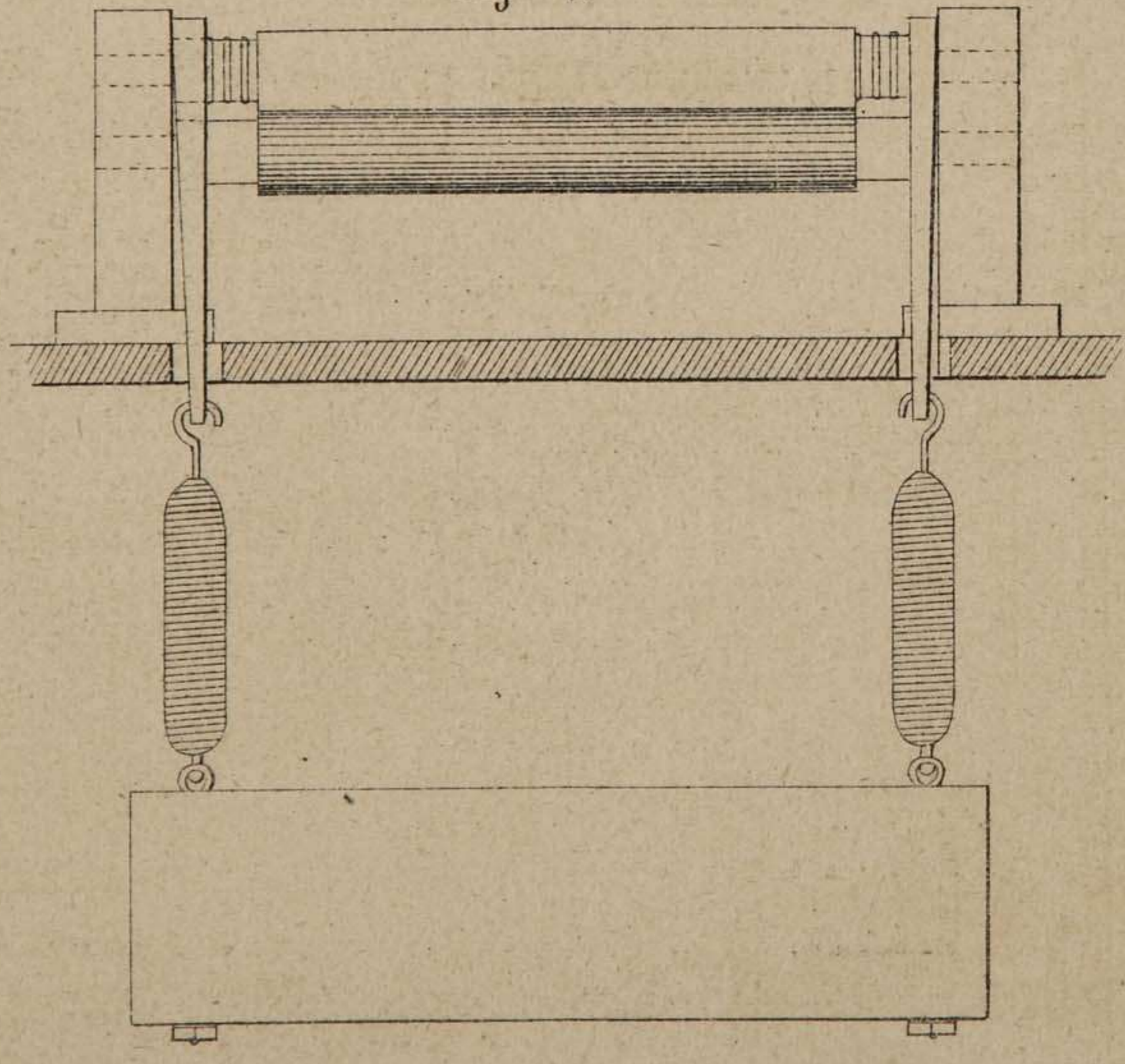


Fig. 149.

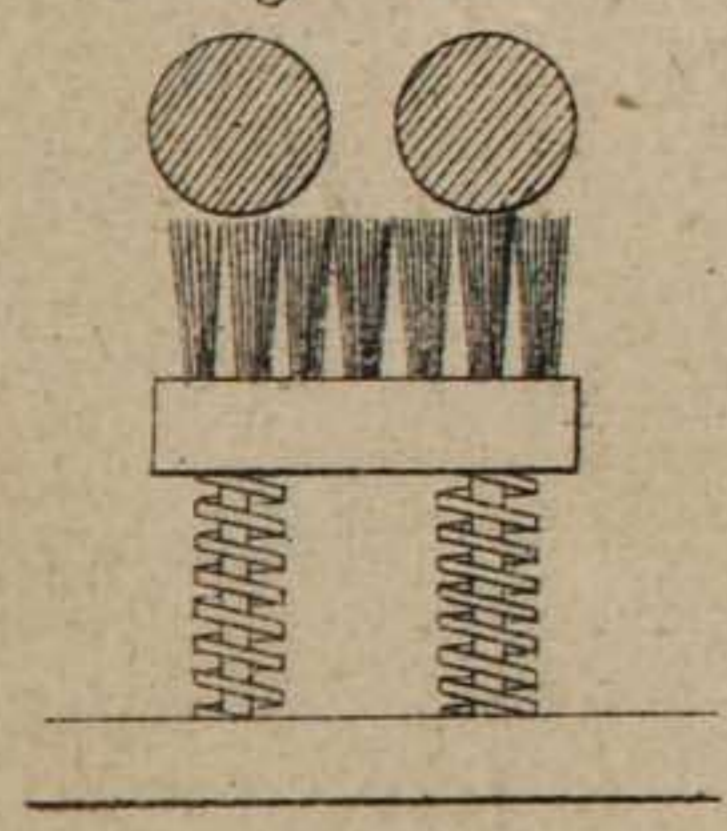


Fig. 151

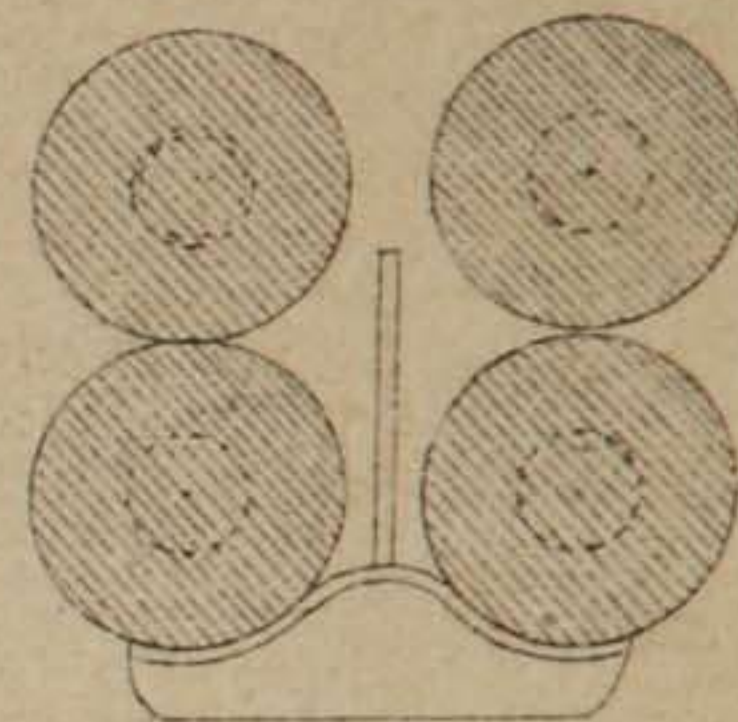
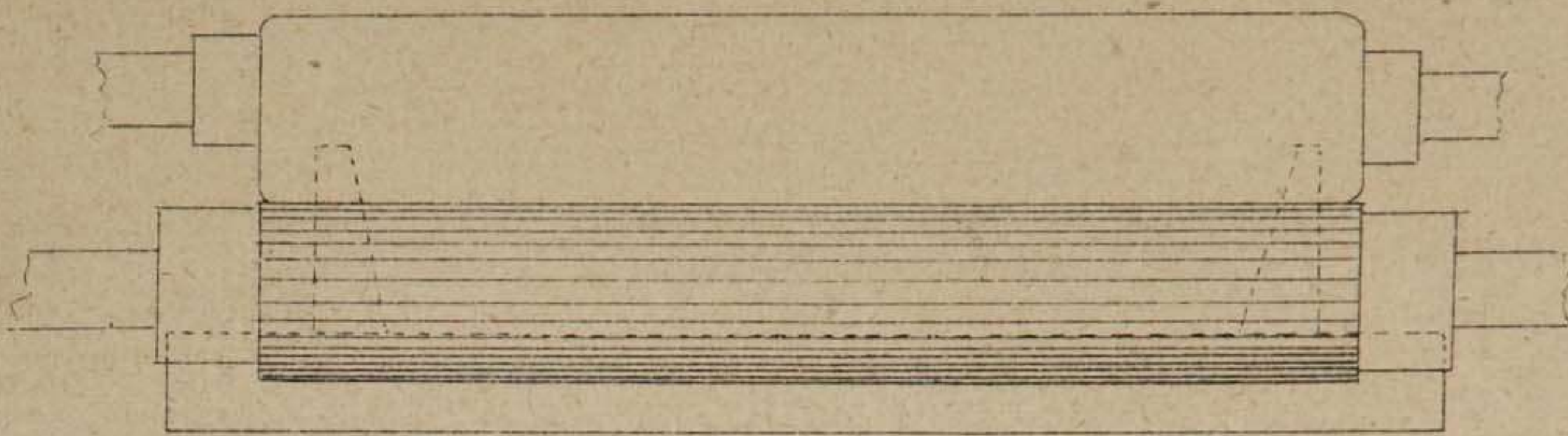


Fig. 153

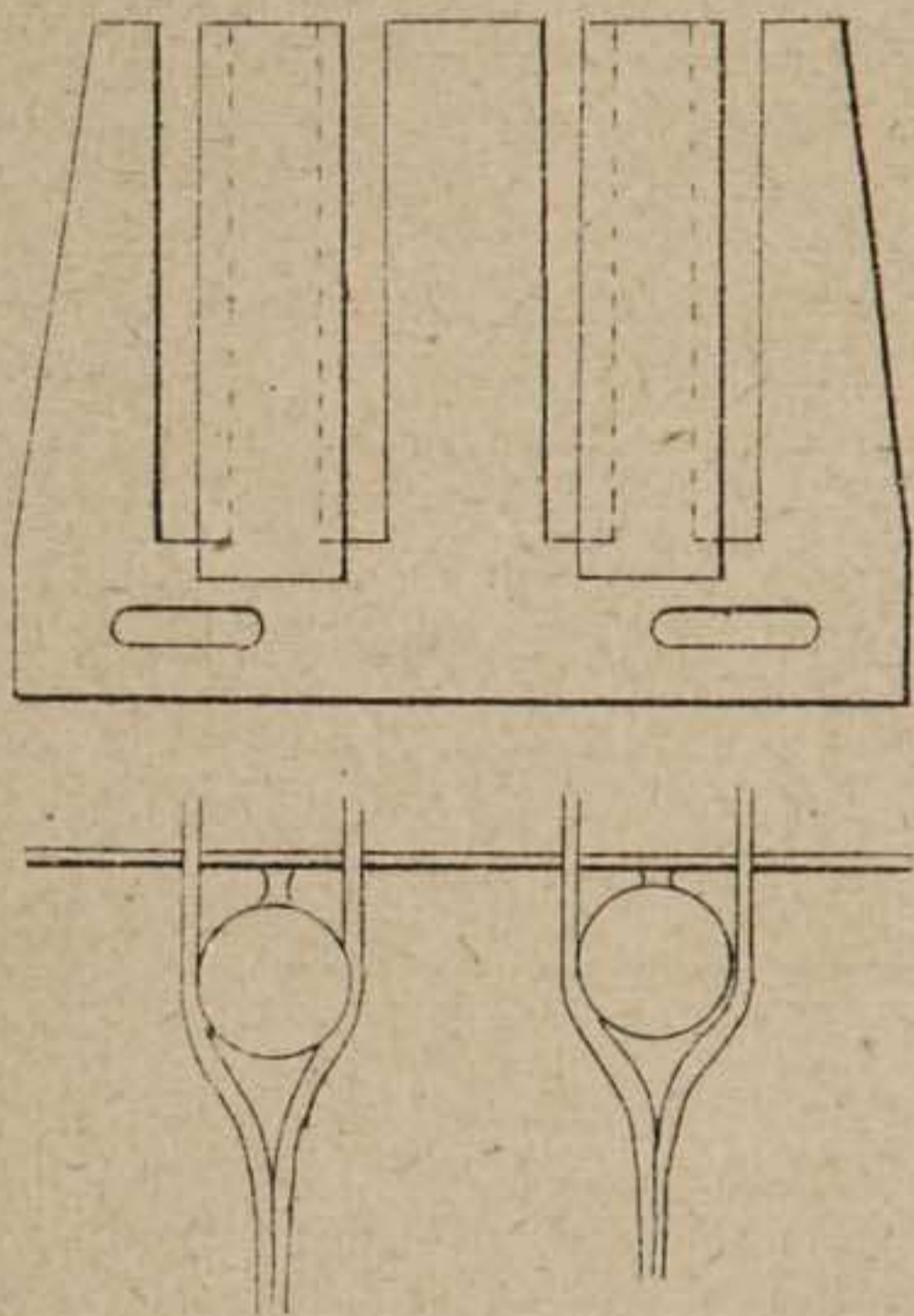


Fig. 152

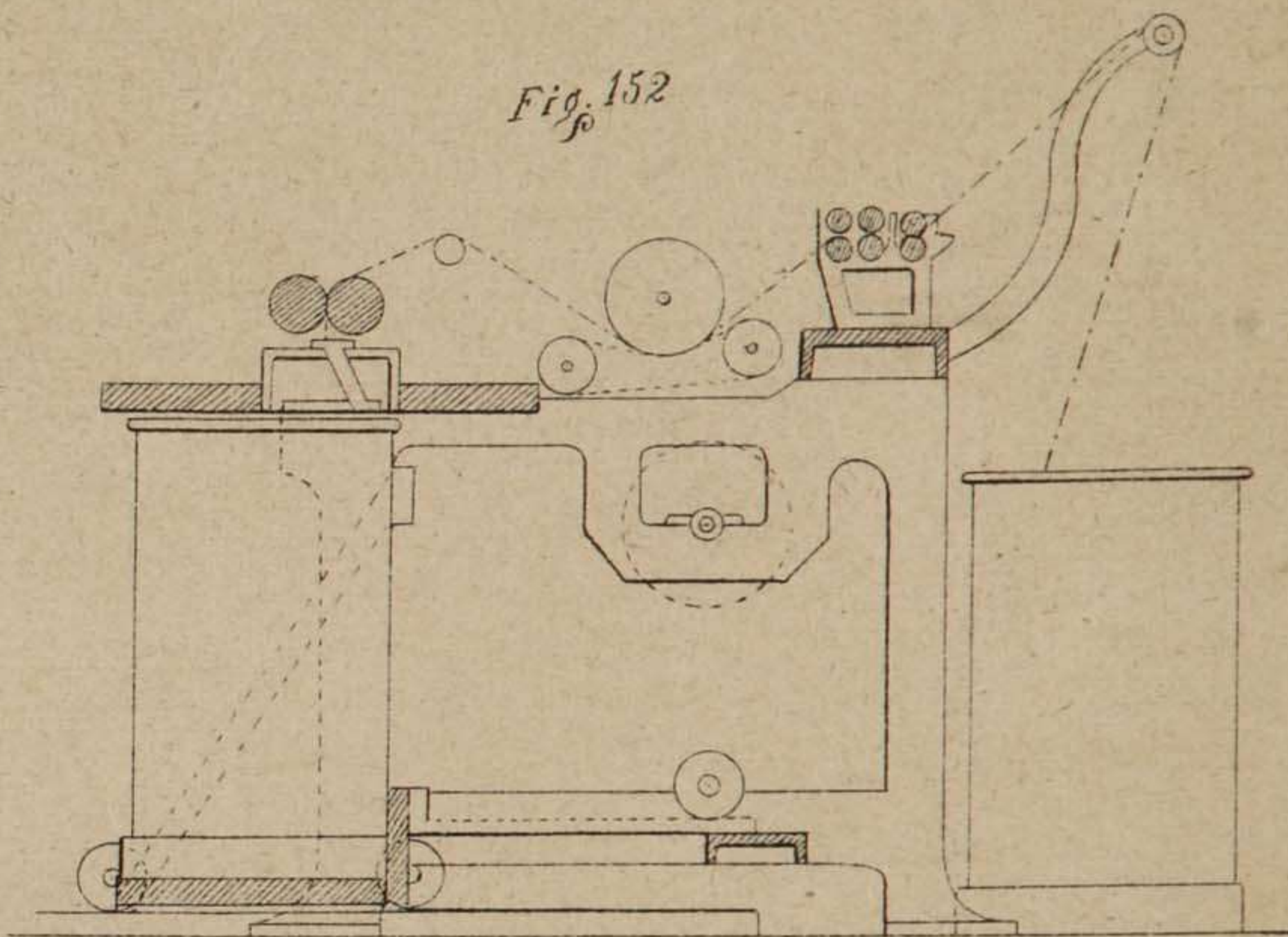


Fig. 154

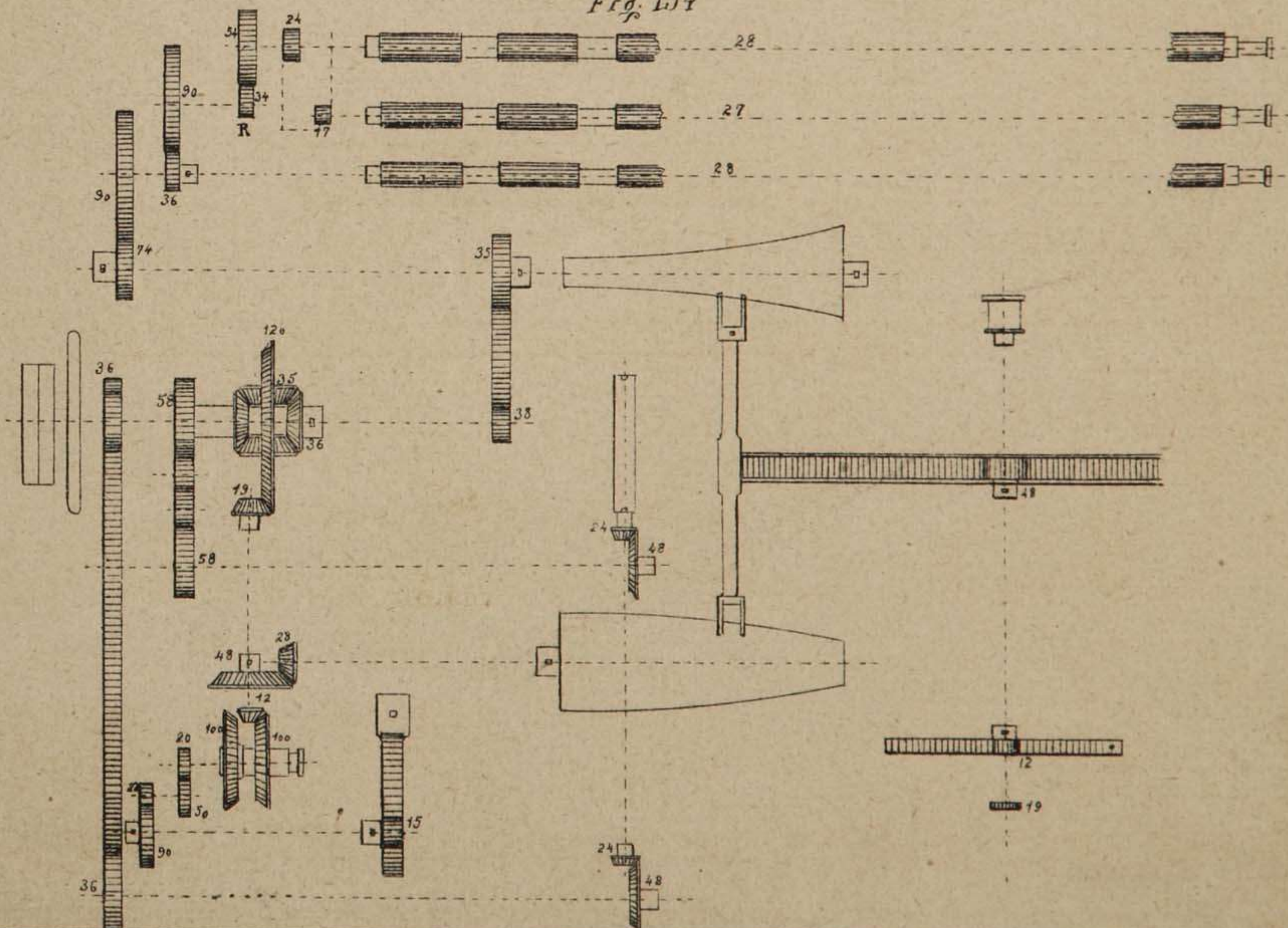


Fig. 155

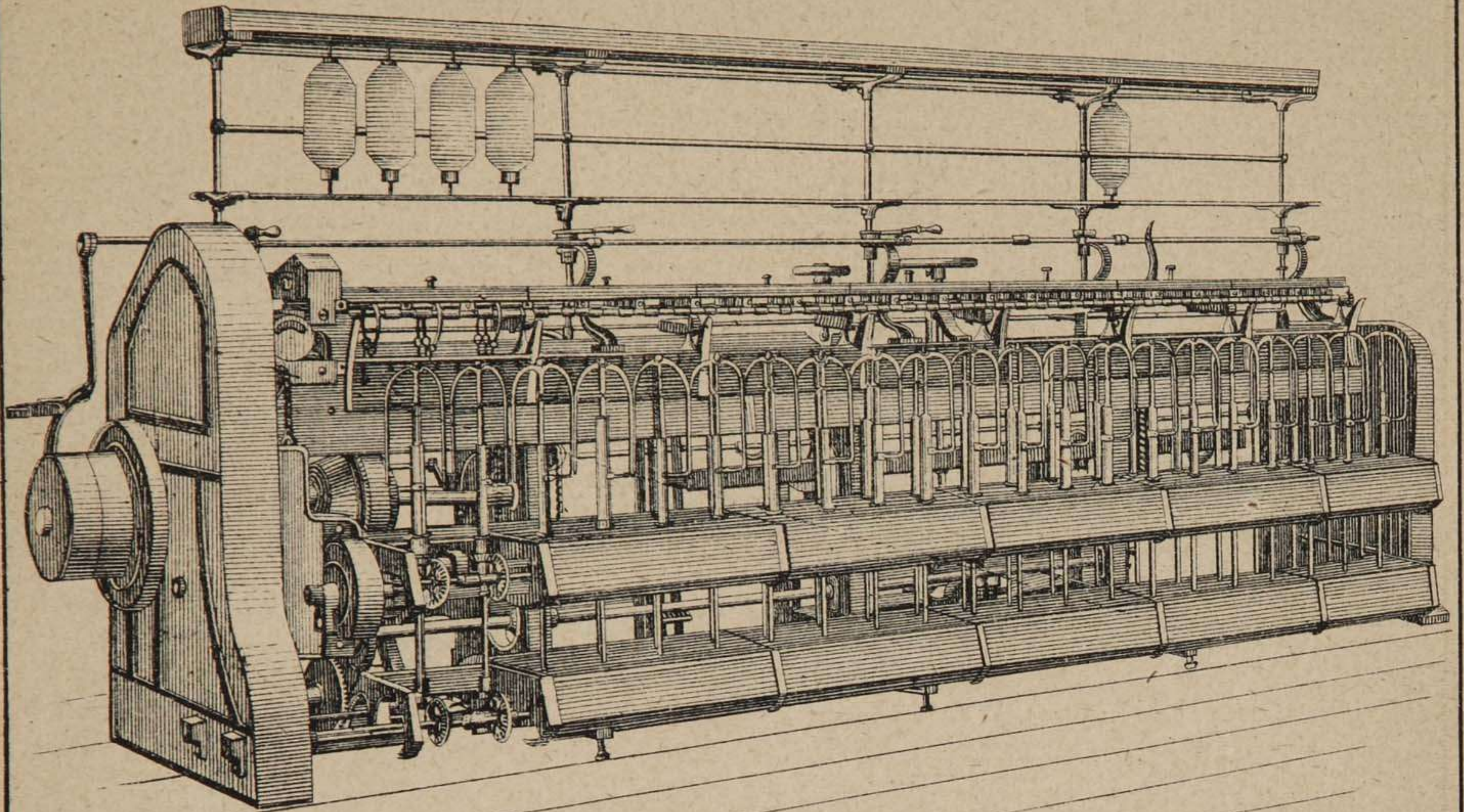


Fig. 156

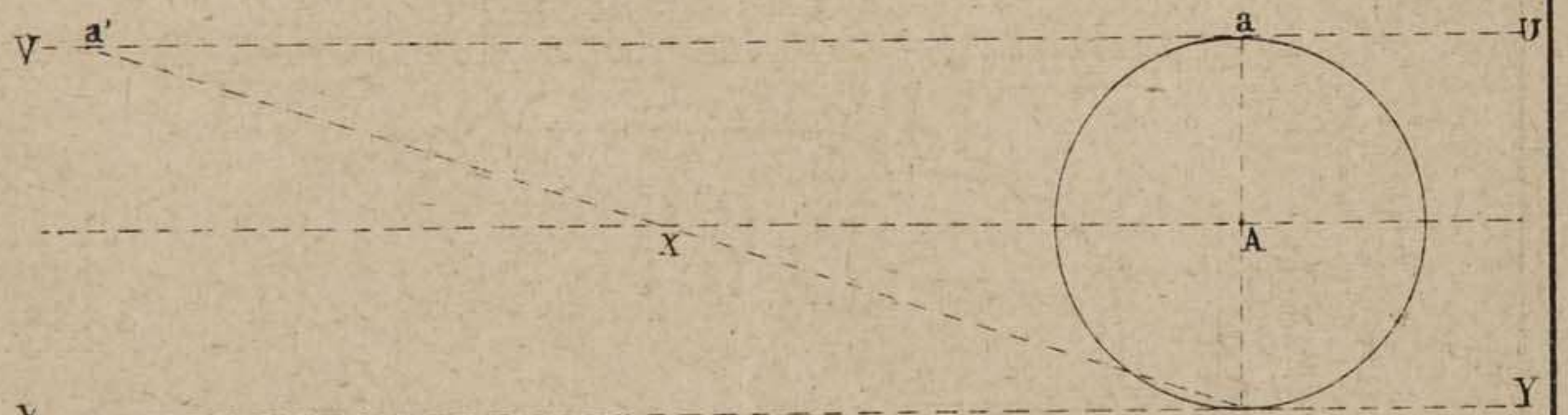


Fig. 157

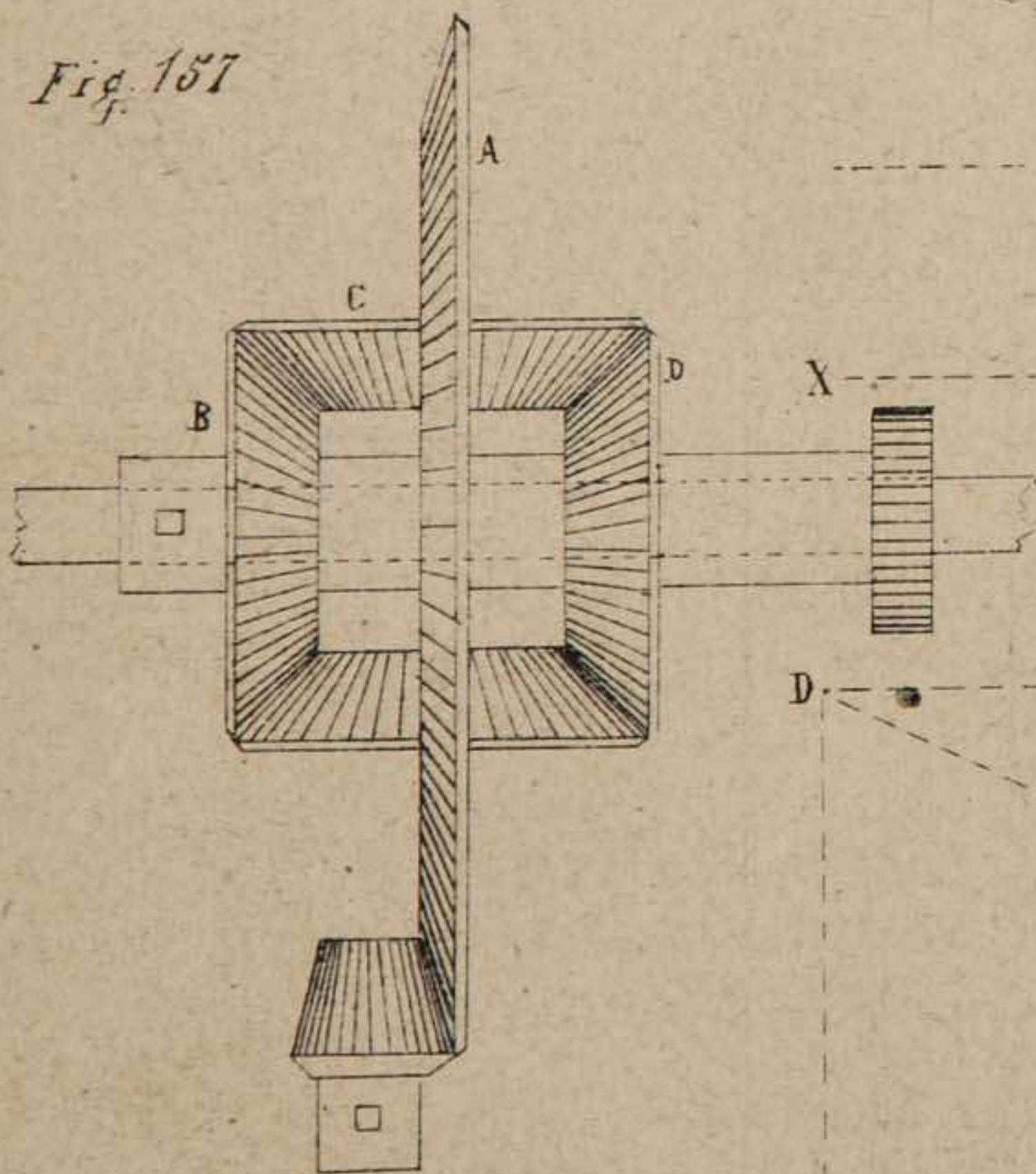
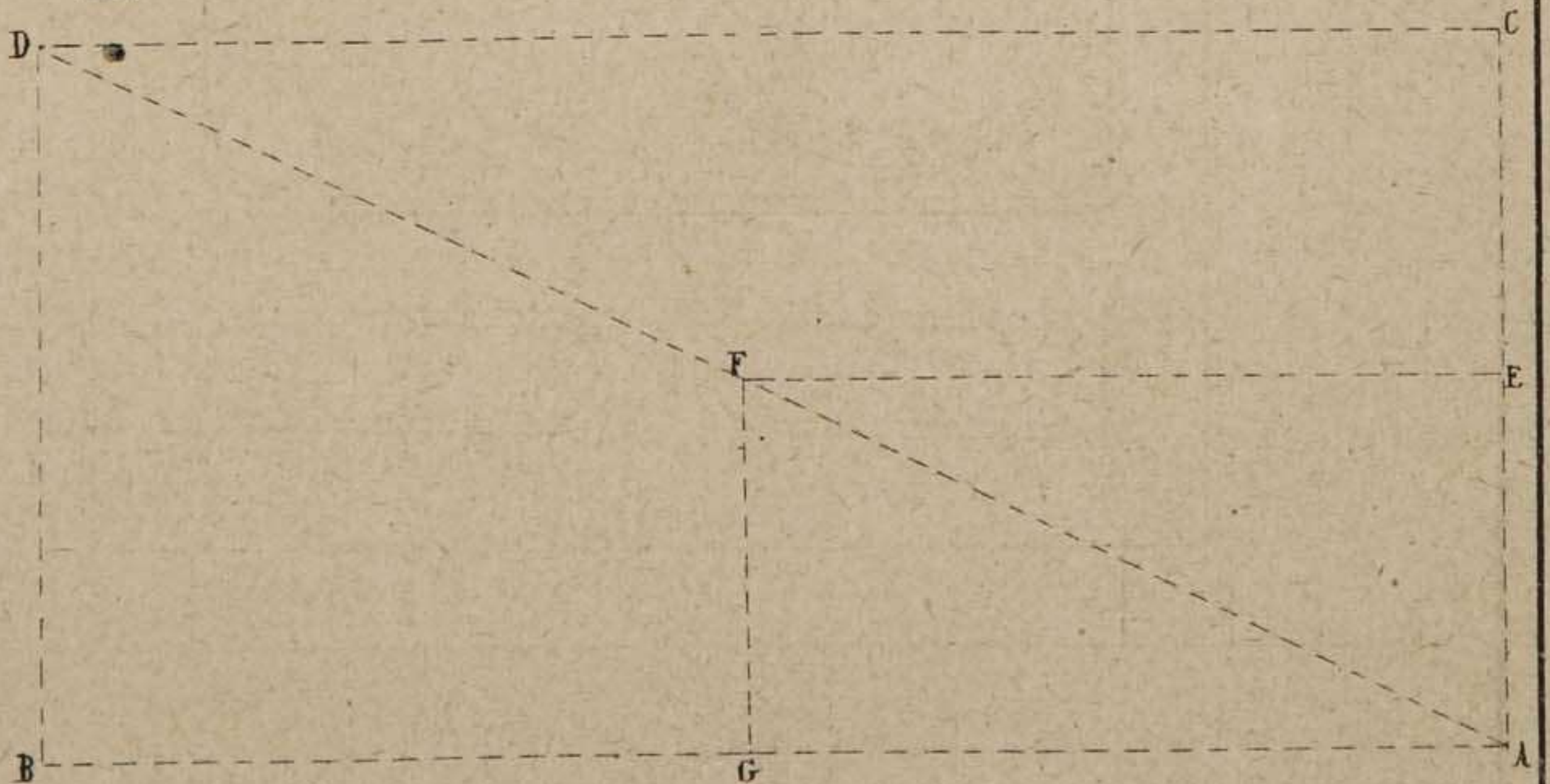


Fig. 158



A

Fig. 159

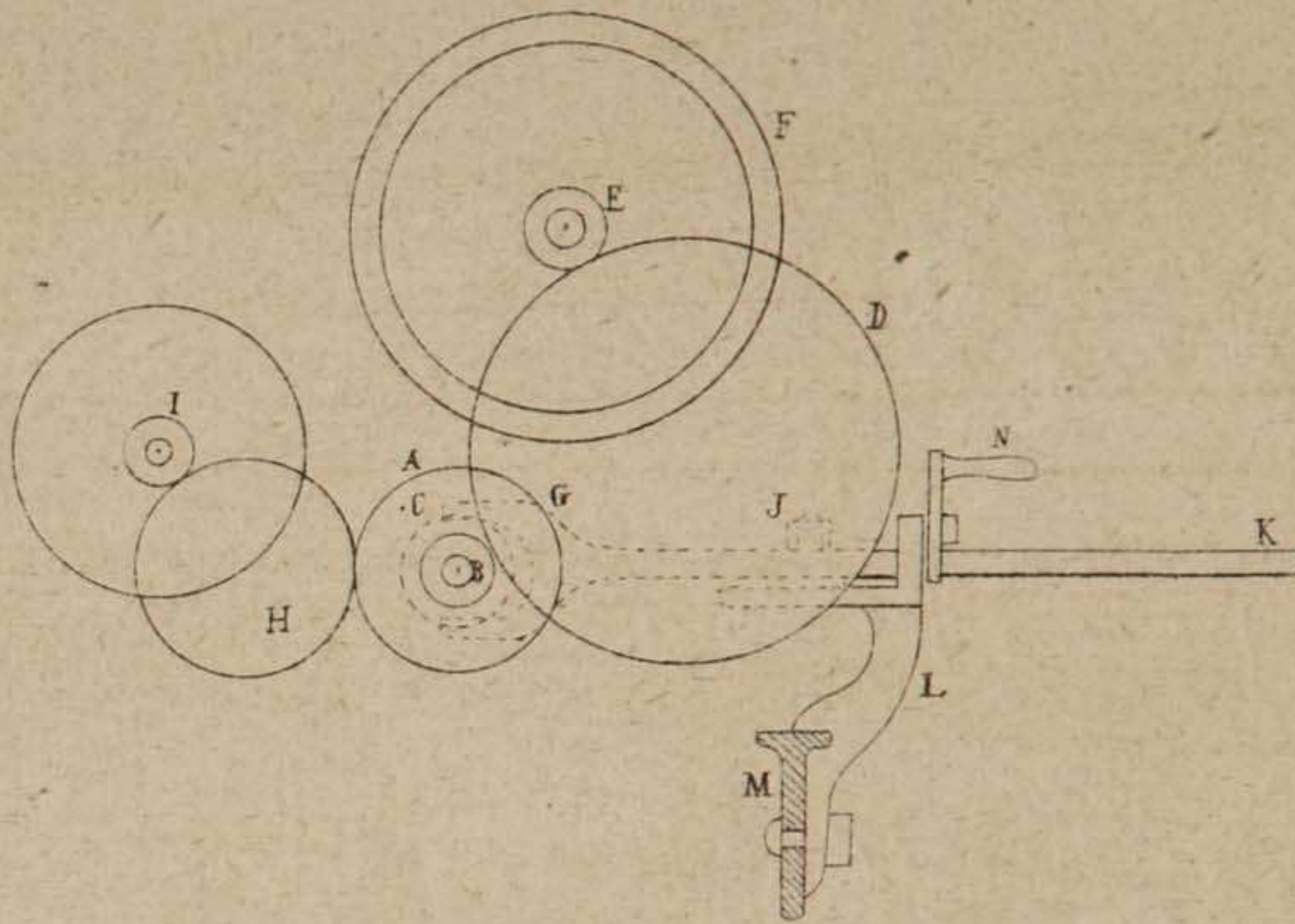


Fig. 161

Fig. 160

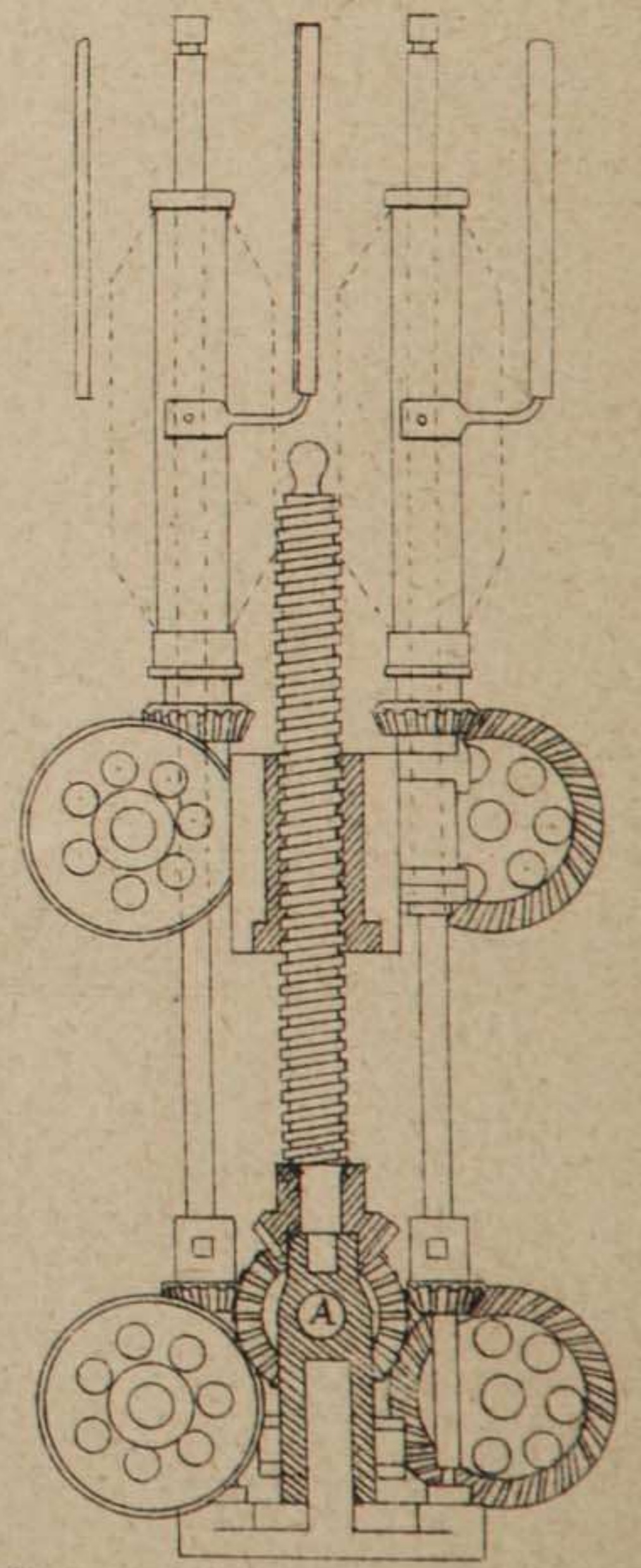
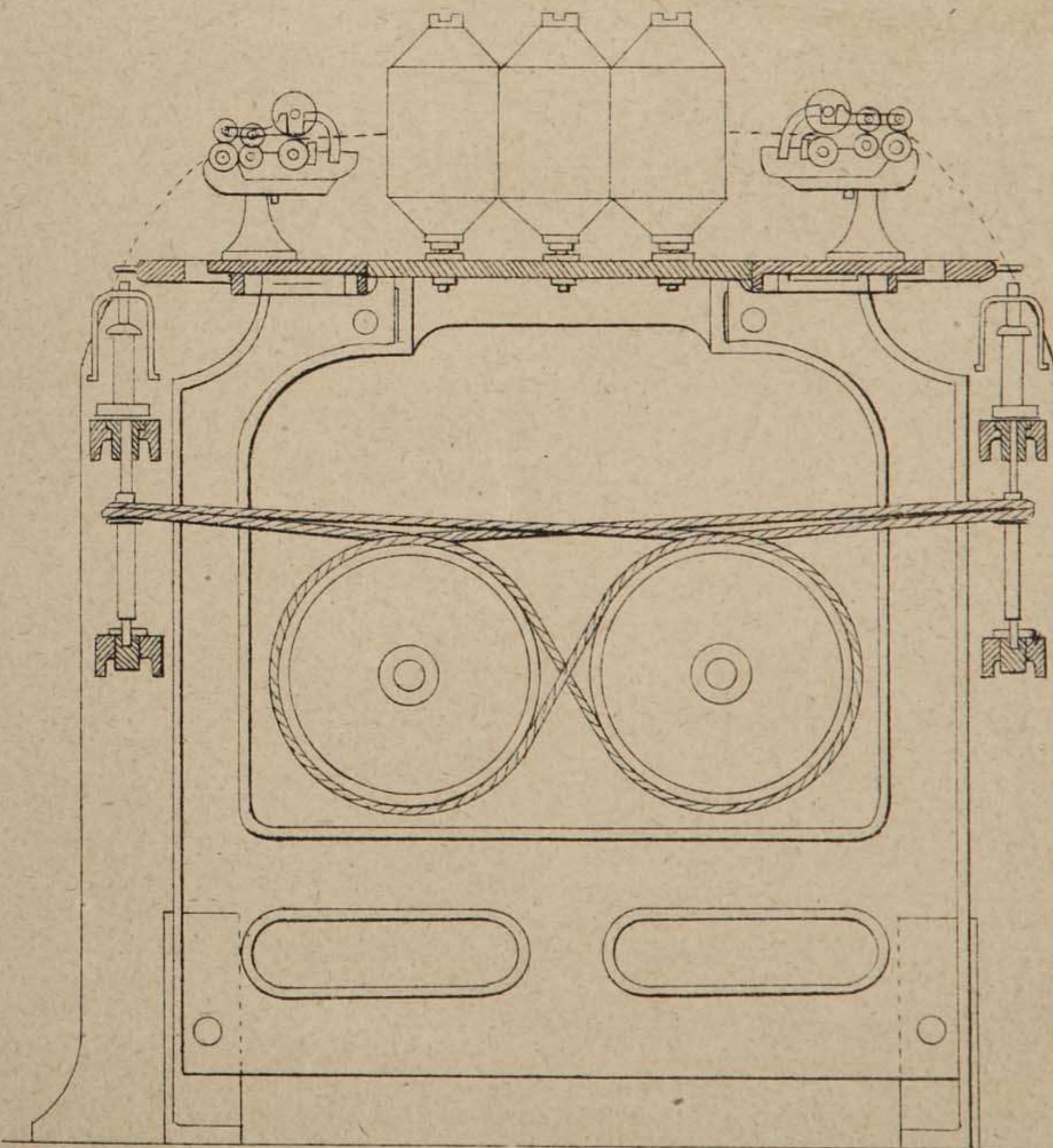


Fig. 162

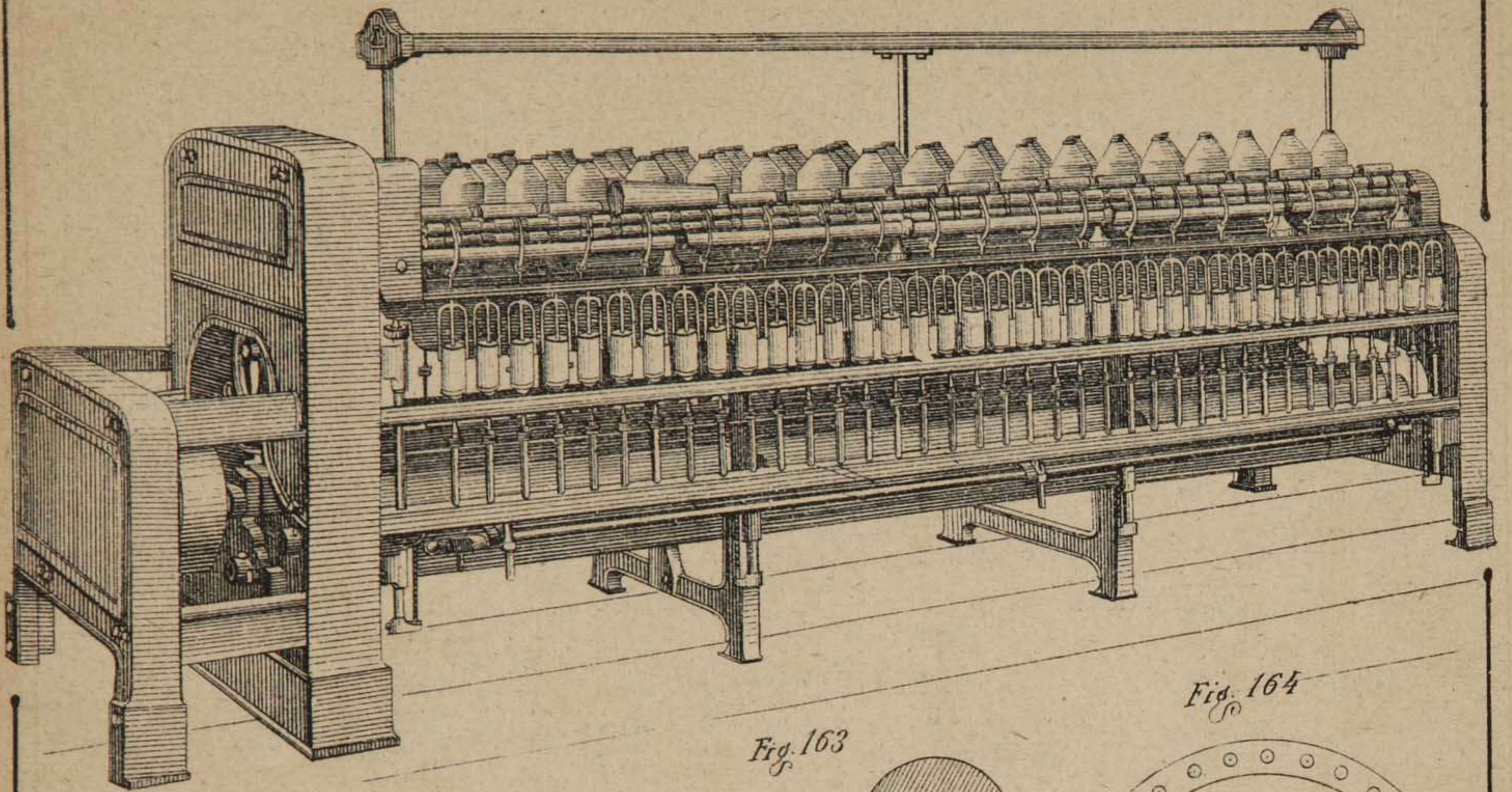


Fig. 164

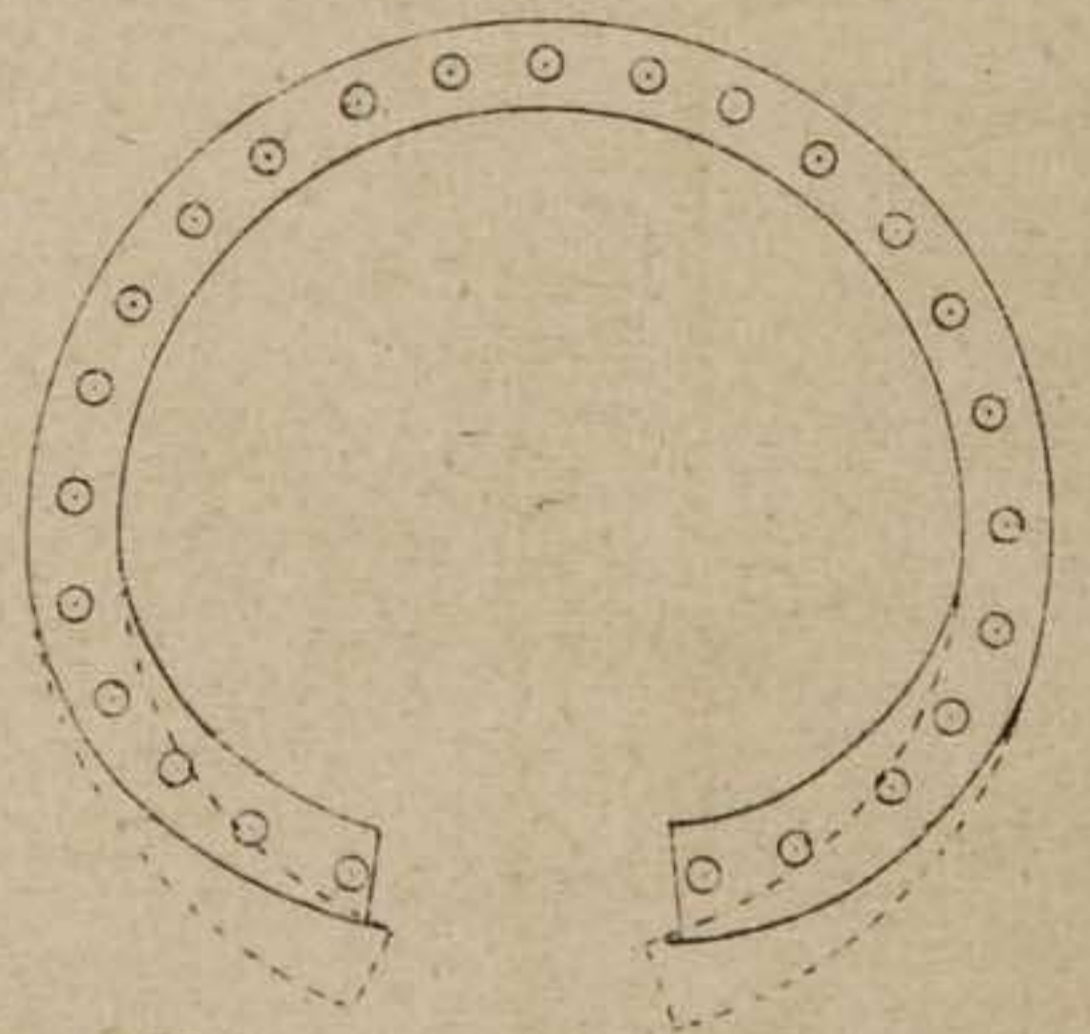


Fig. 163

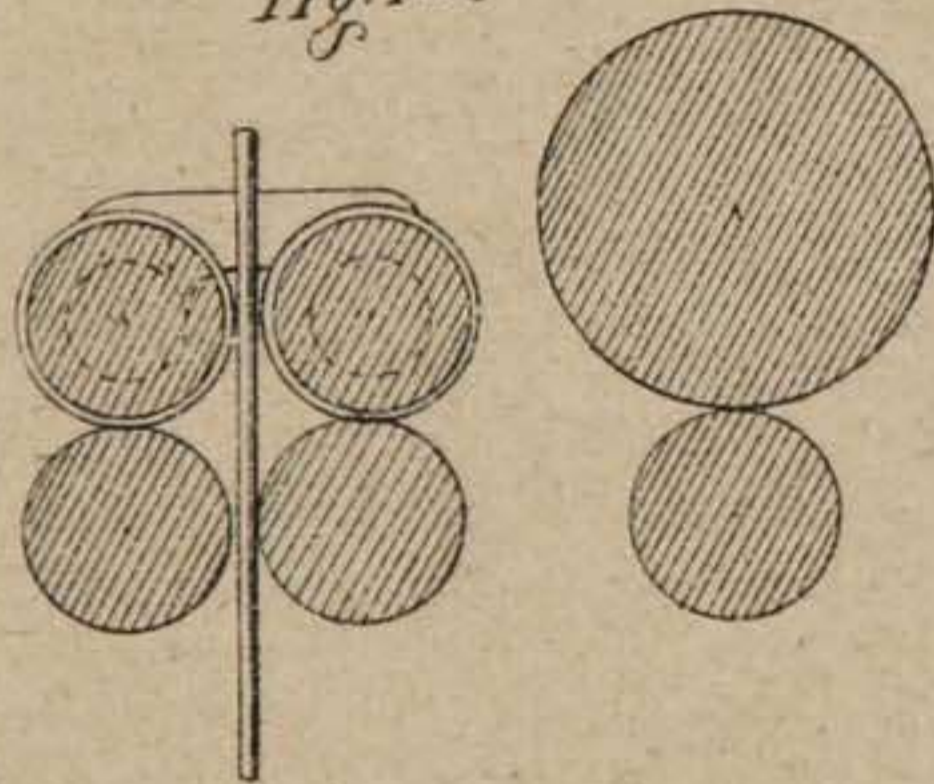


Fig. 166

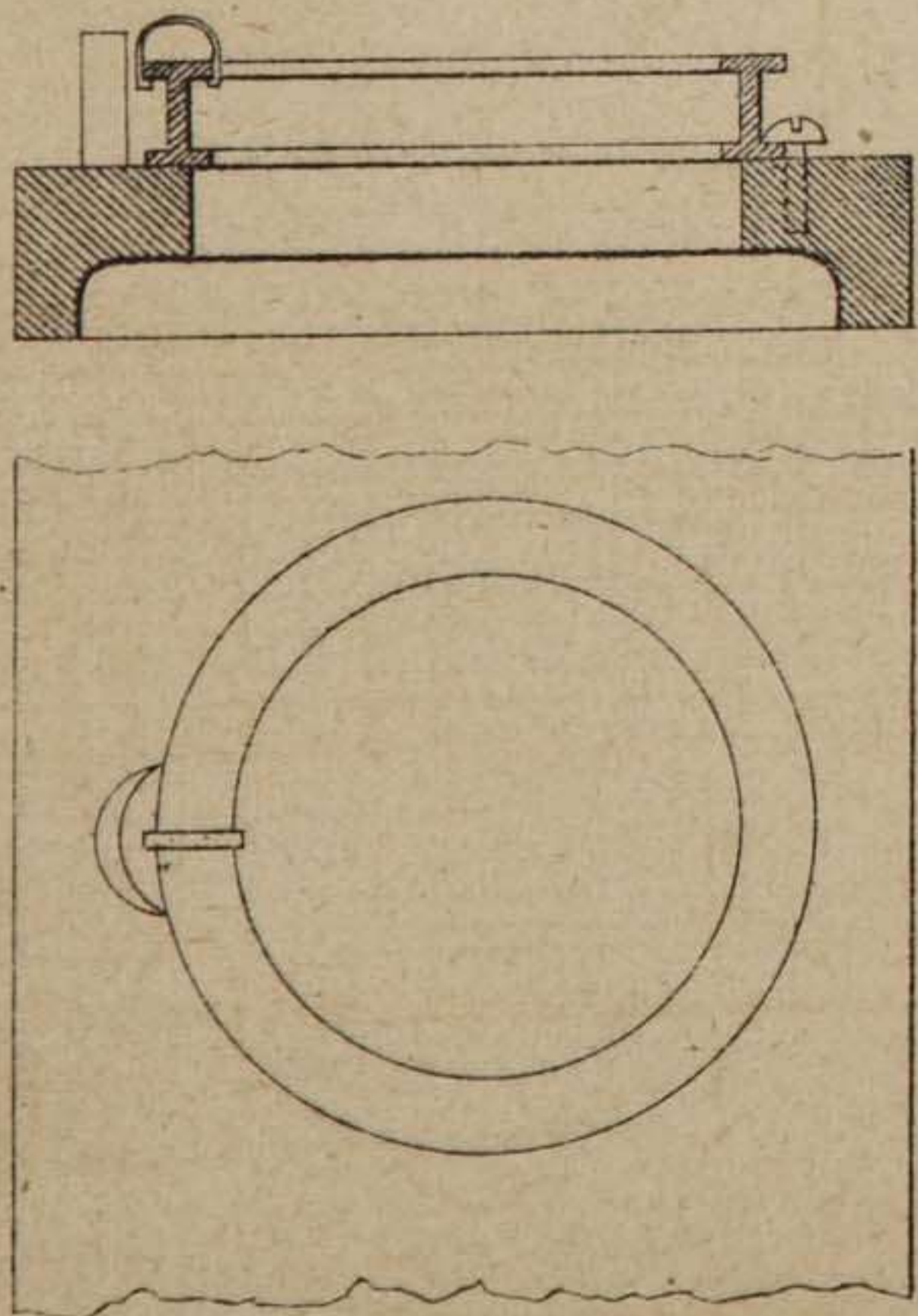
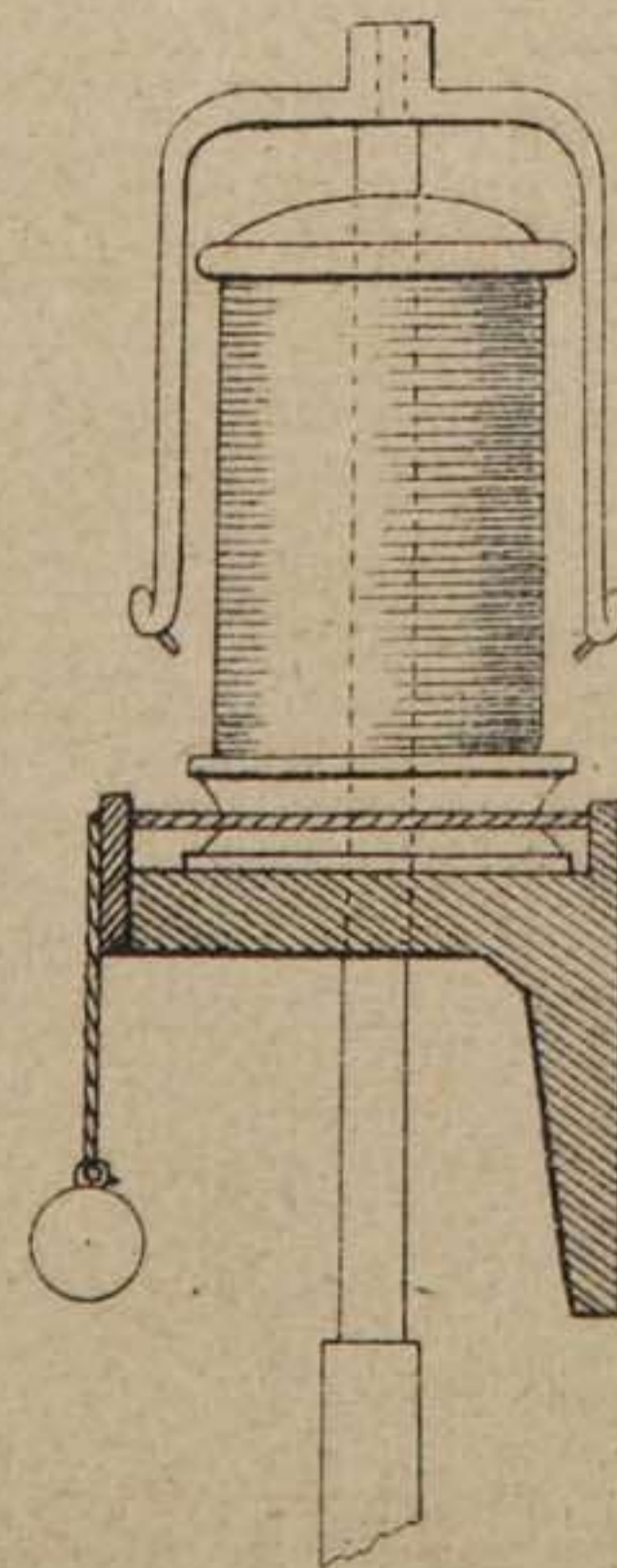


Fig. 165



D

Fig. 168

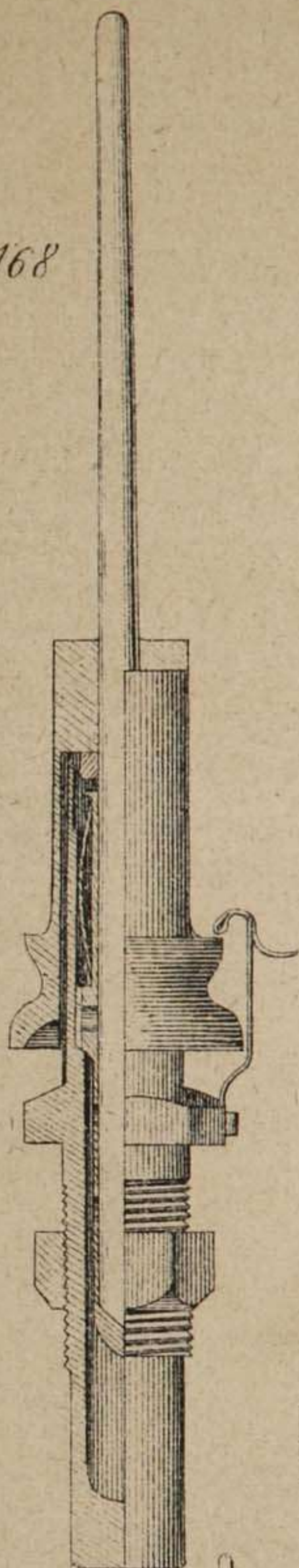


Fig. 167

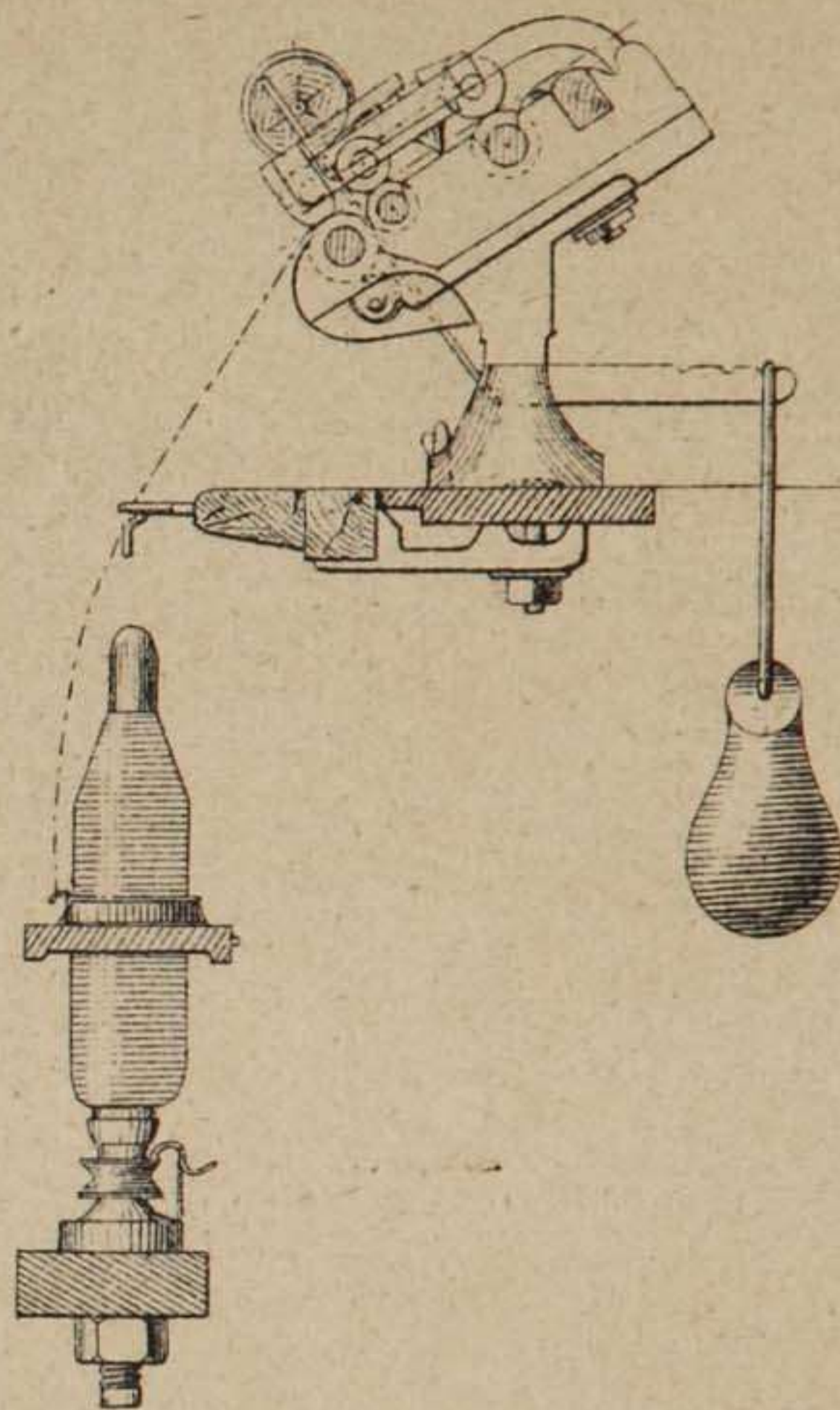


Fig. 169

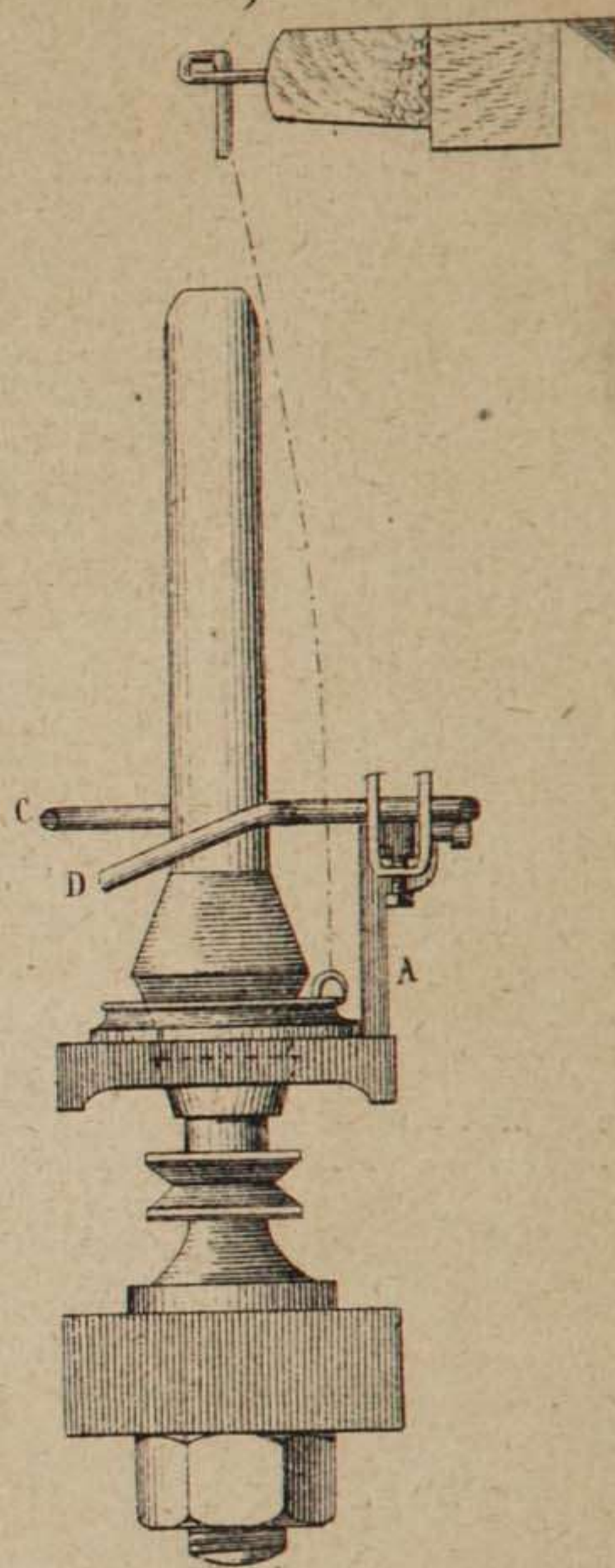


Fig. 170

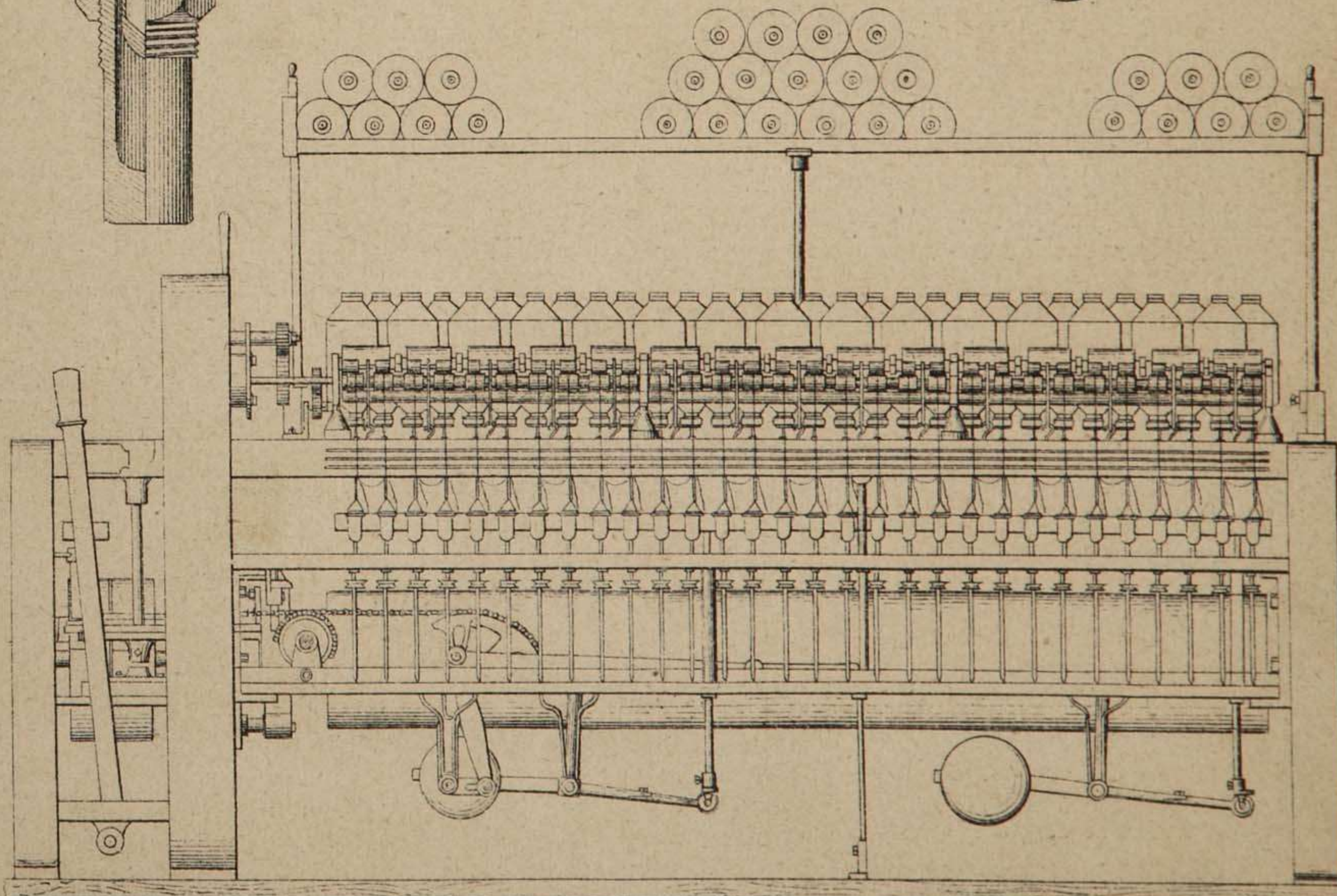


Fig. 171

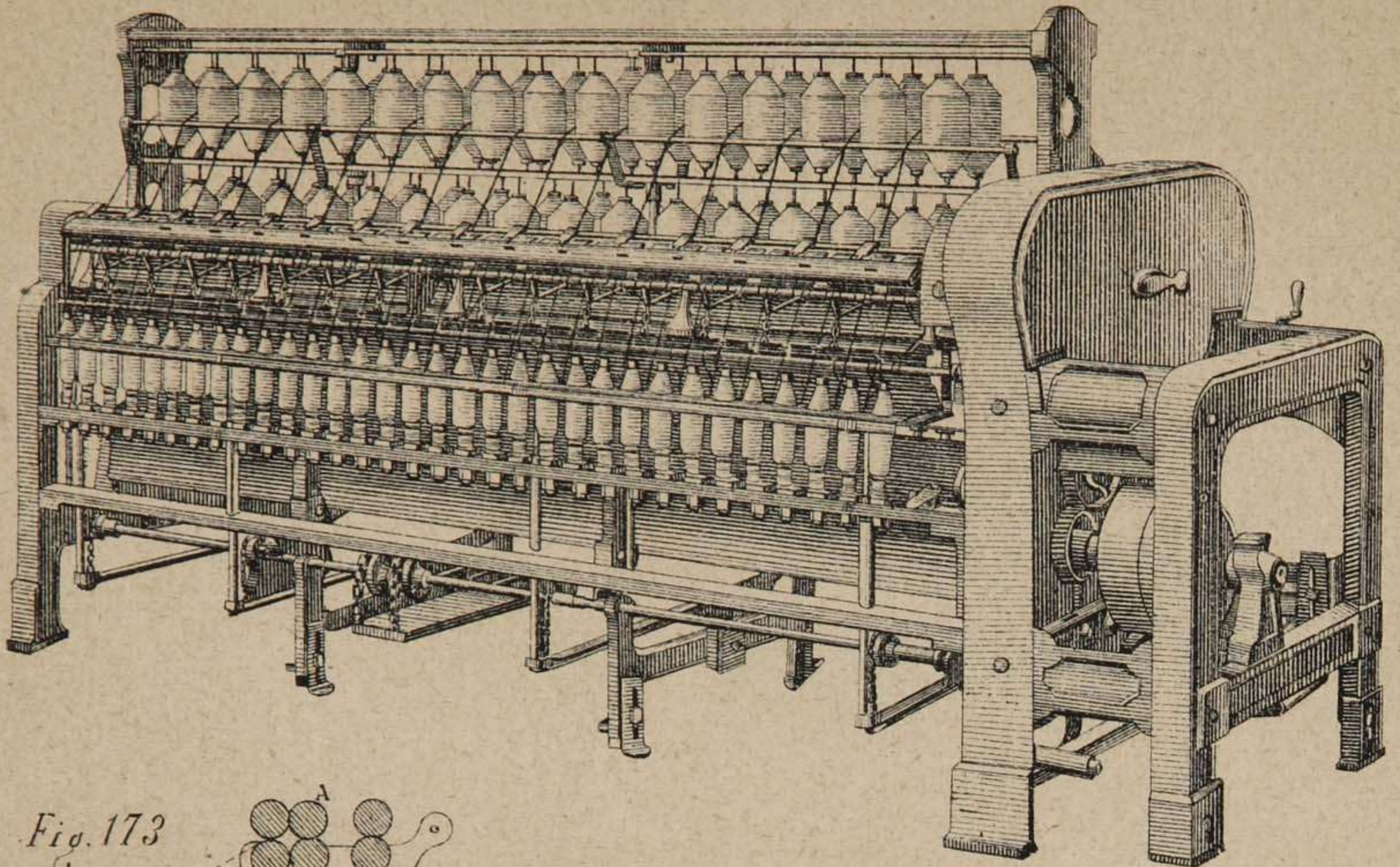


Fig. 173

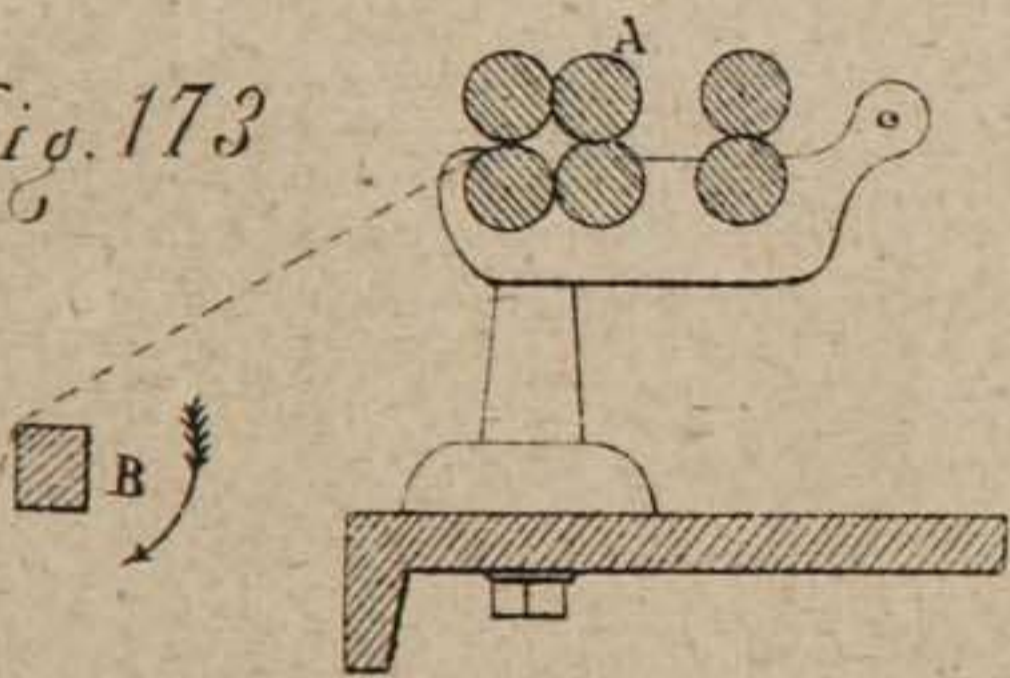


Fig. 172

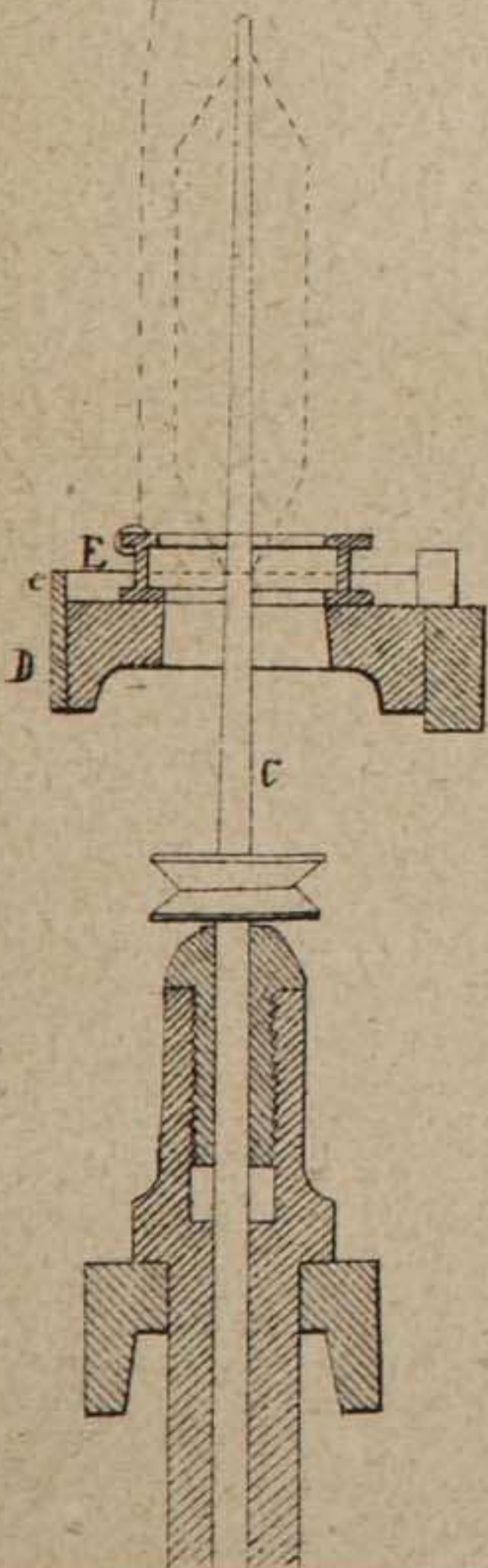
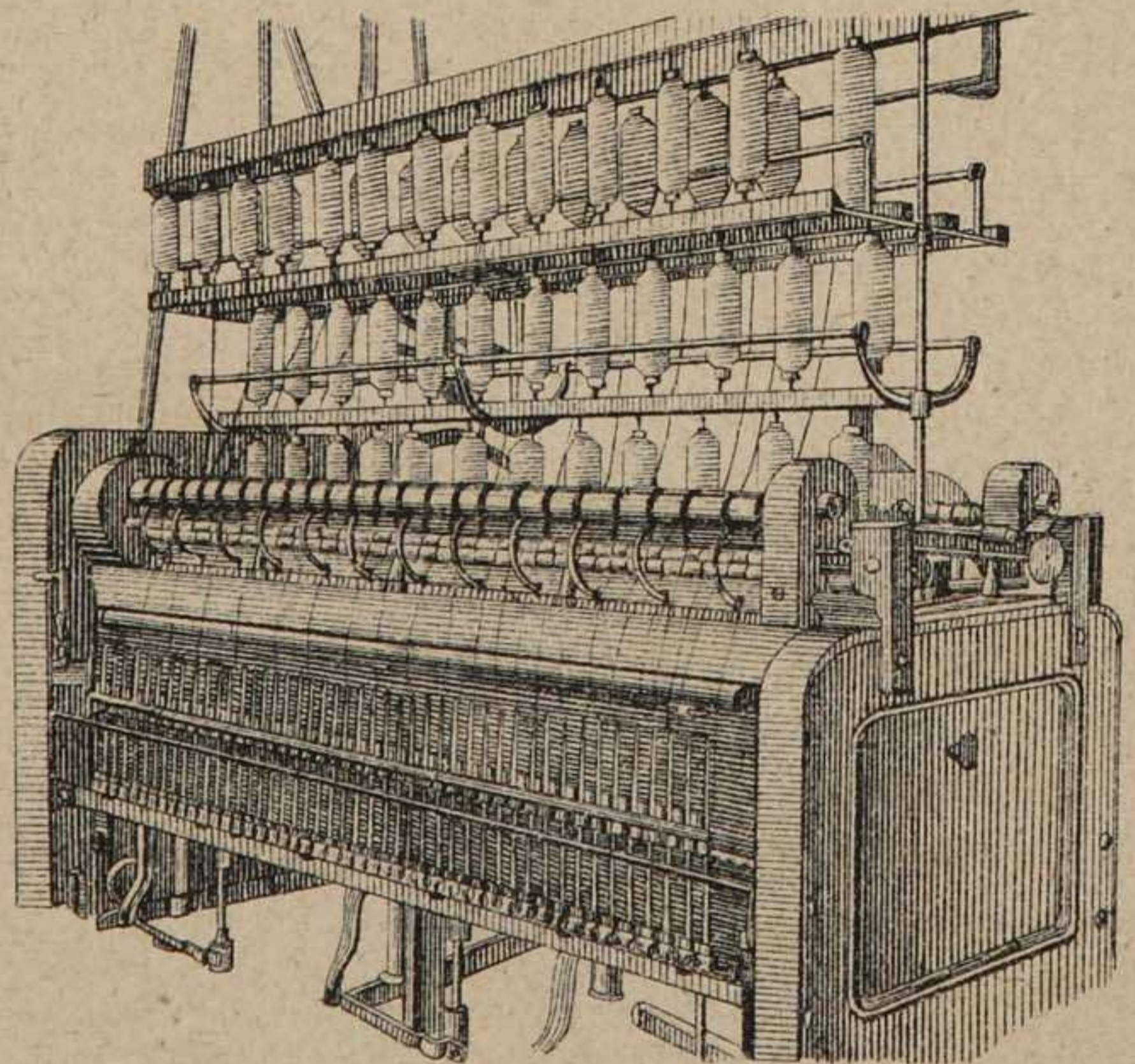


Fig. 174

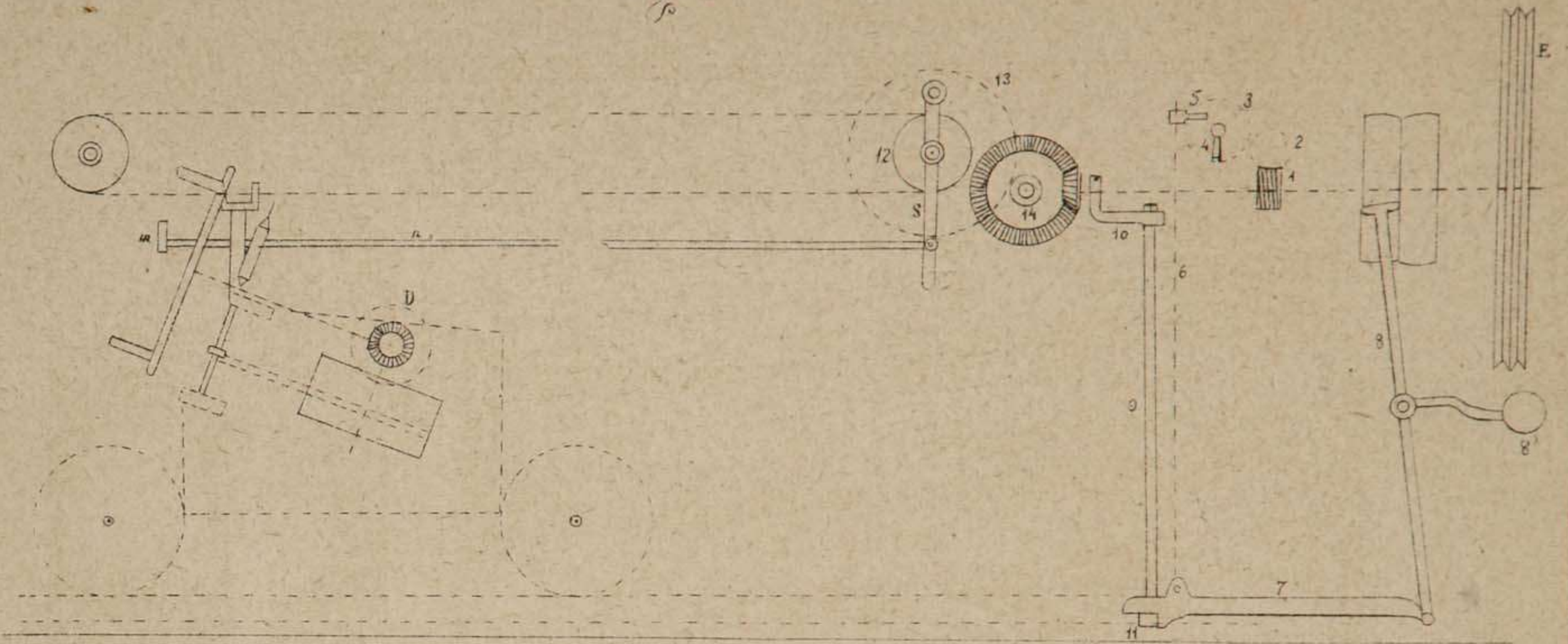


Fig. 175

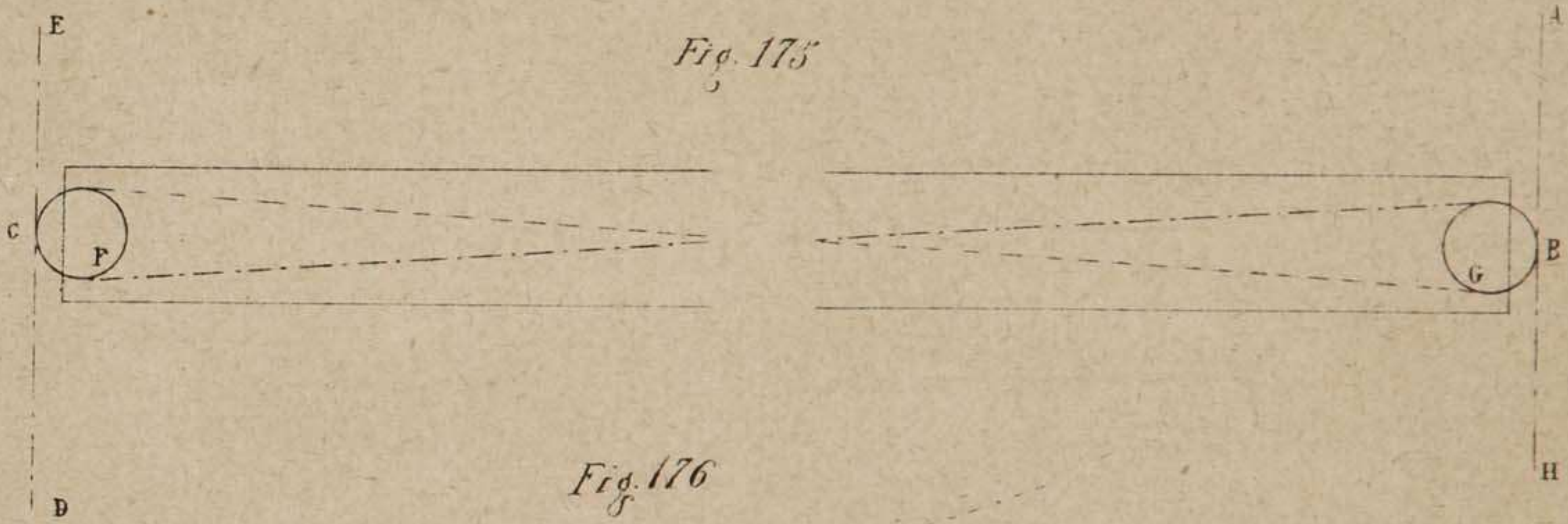


Fig. 176

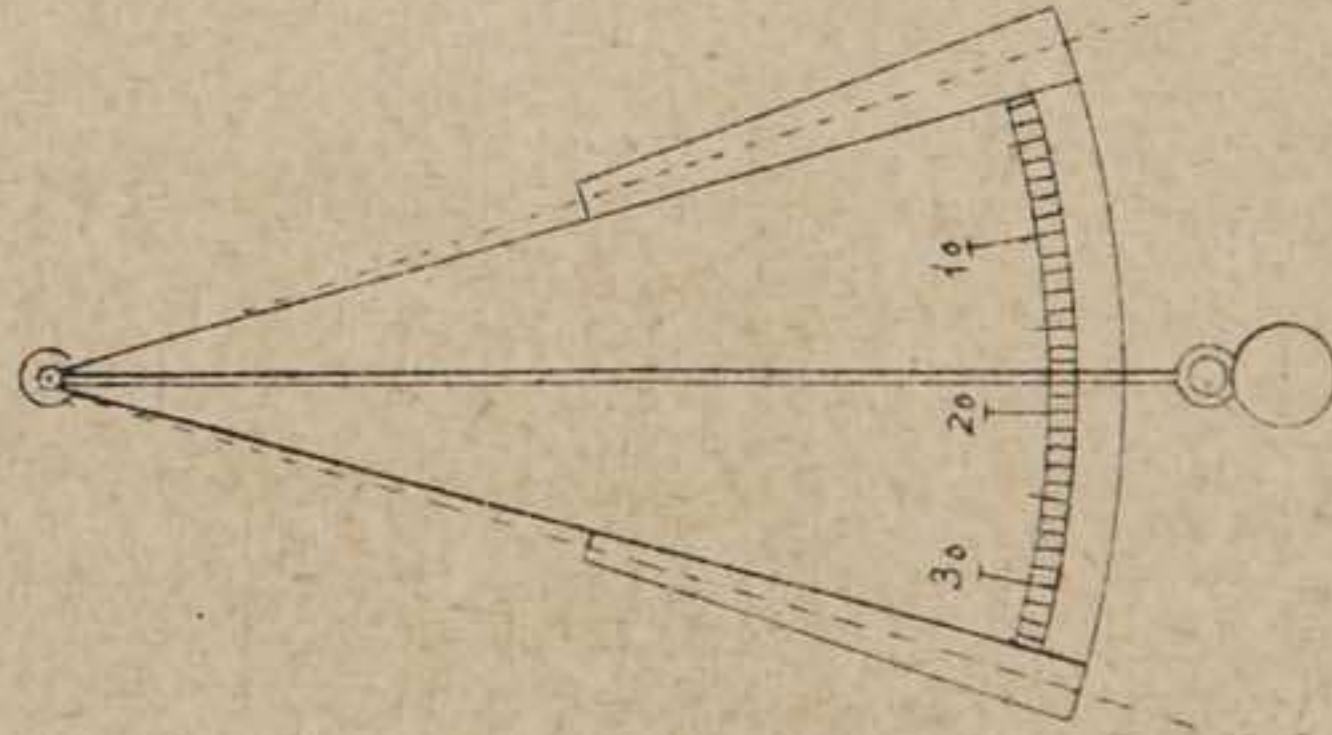


Fig. 177

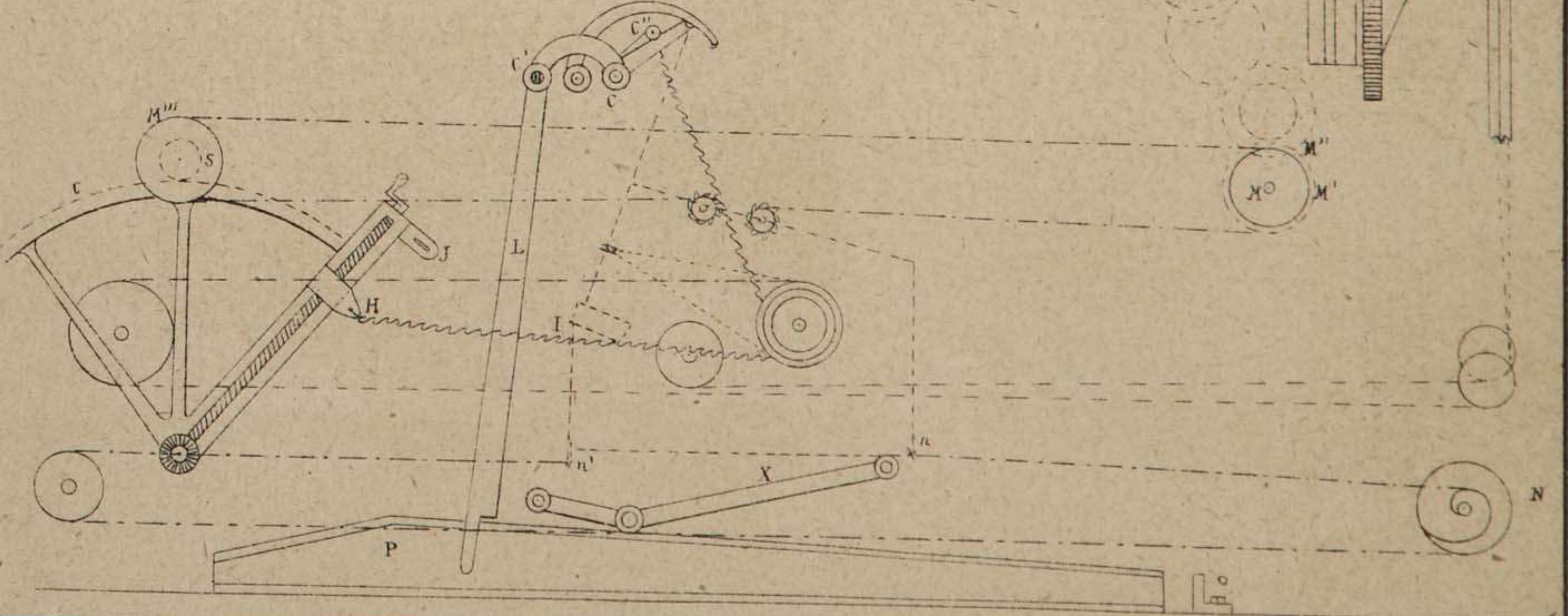


Fig. 178

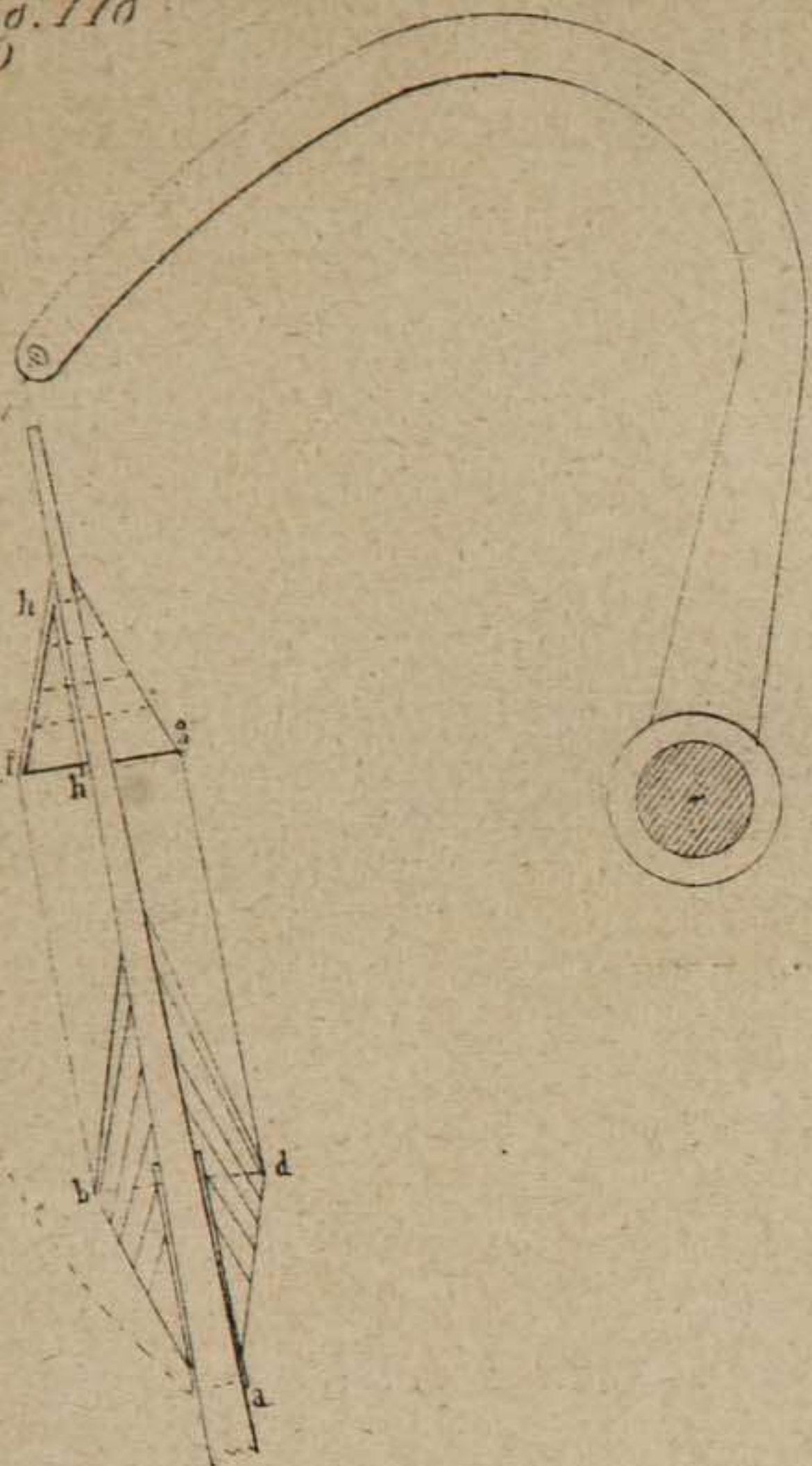


Fig. 180

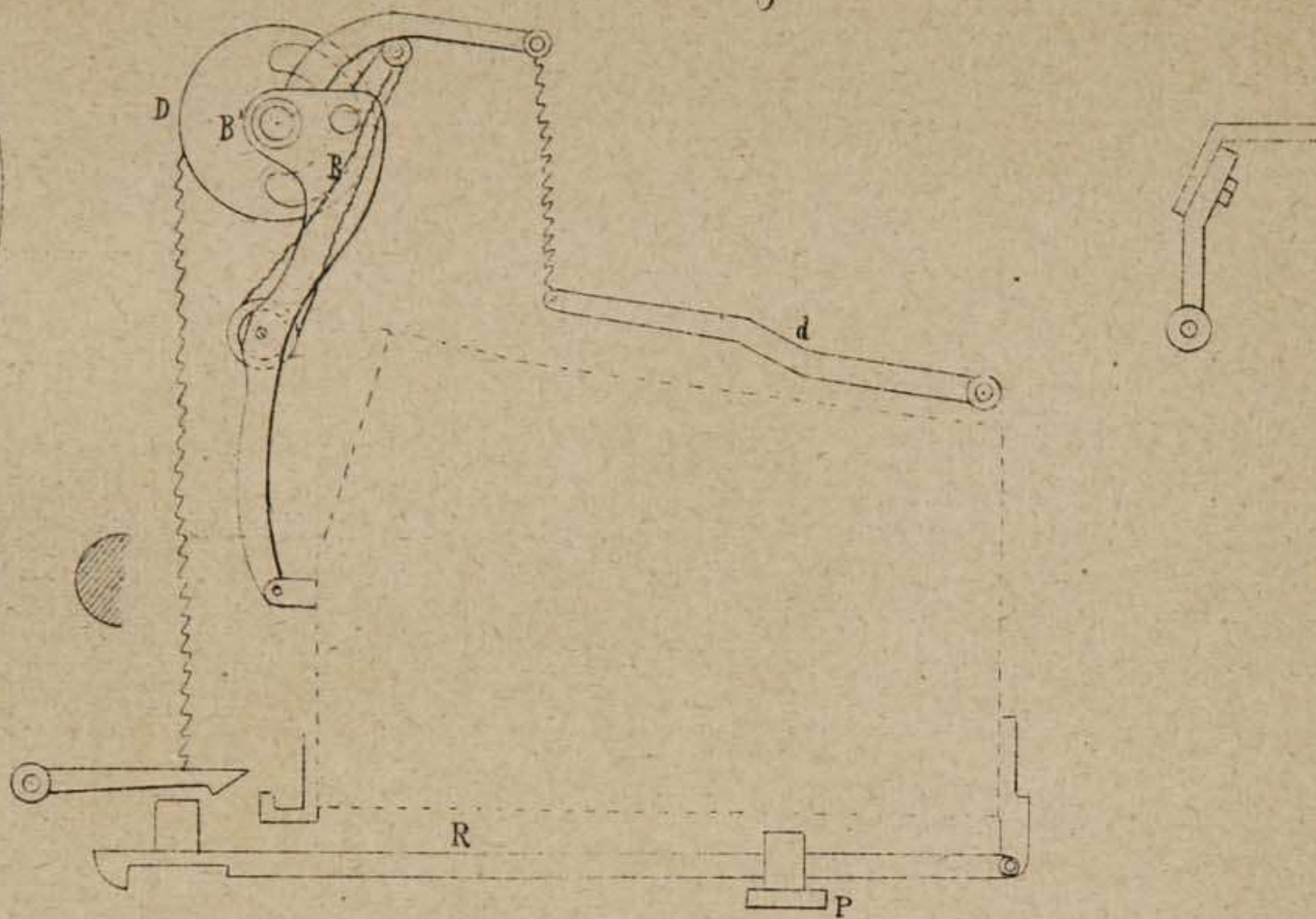


Fig. 181

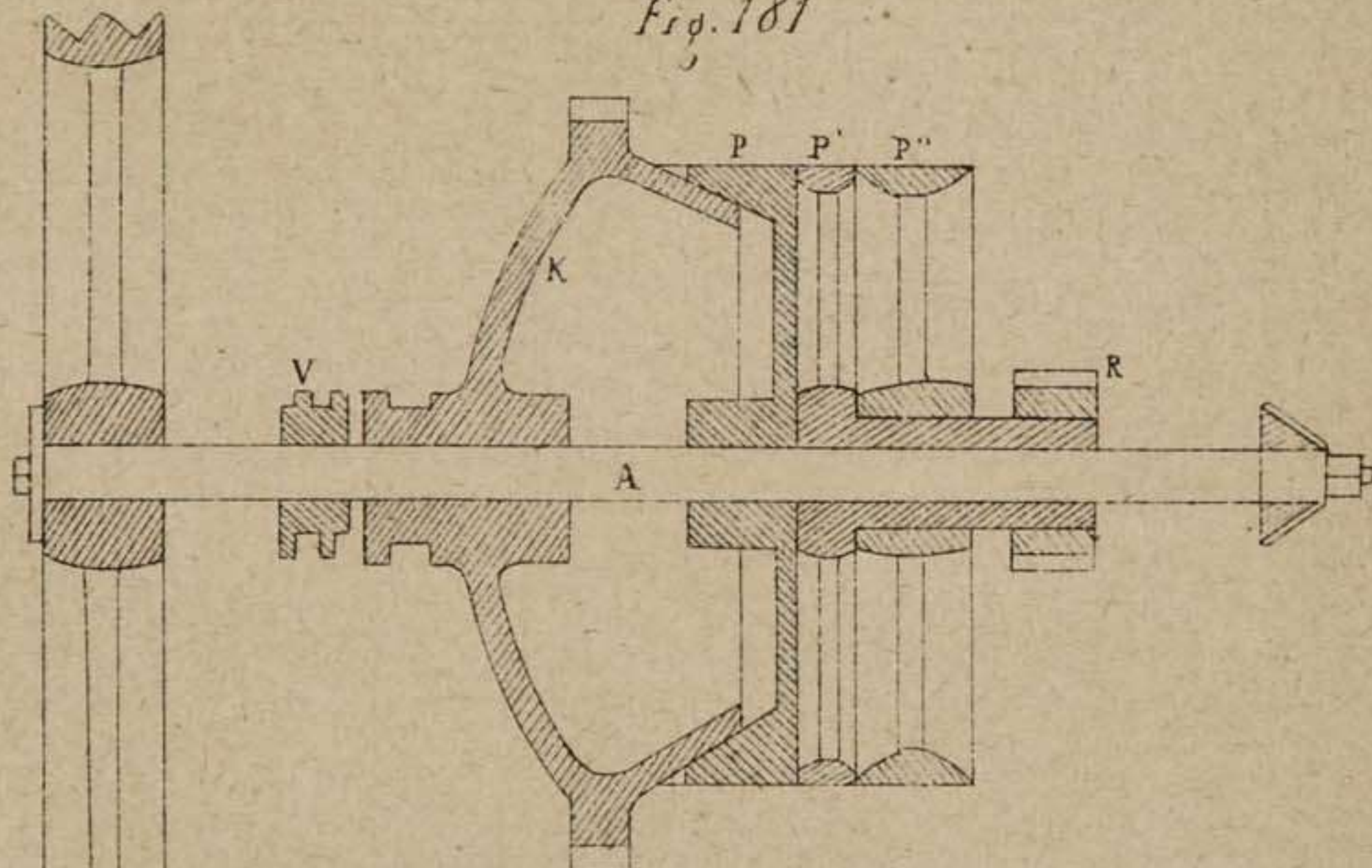


Fig. 182

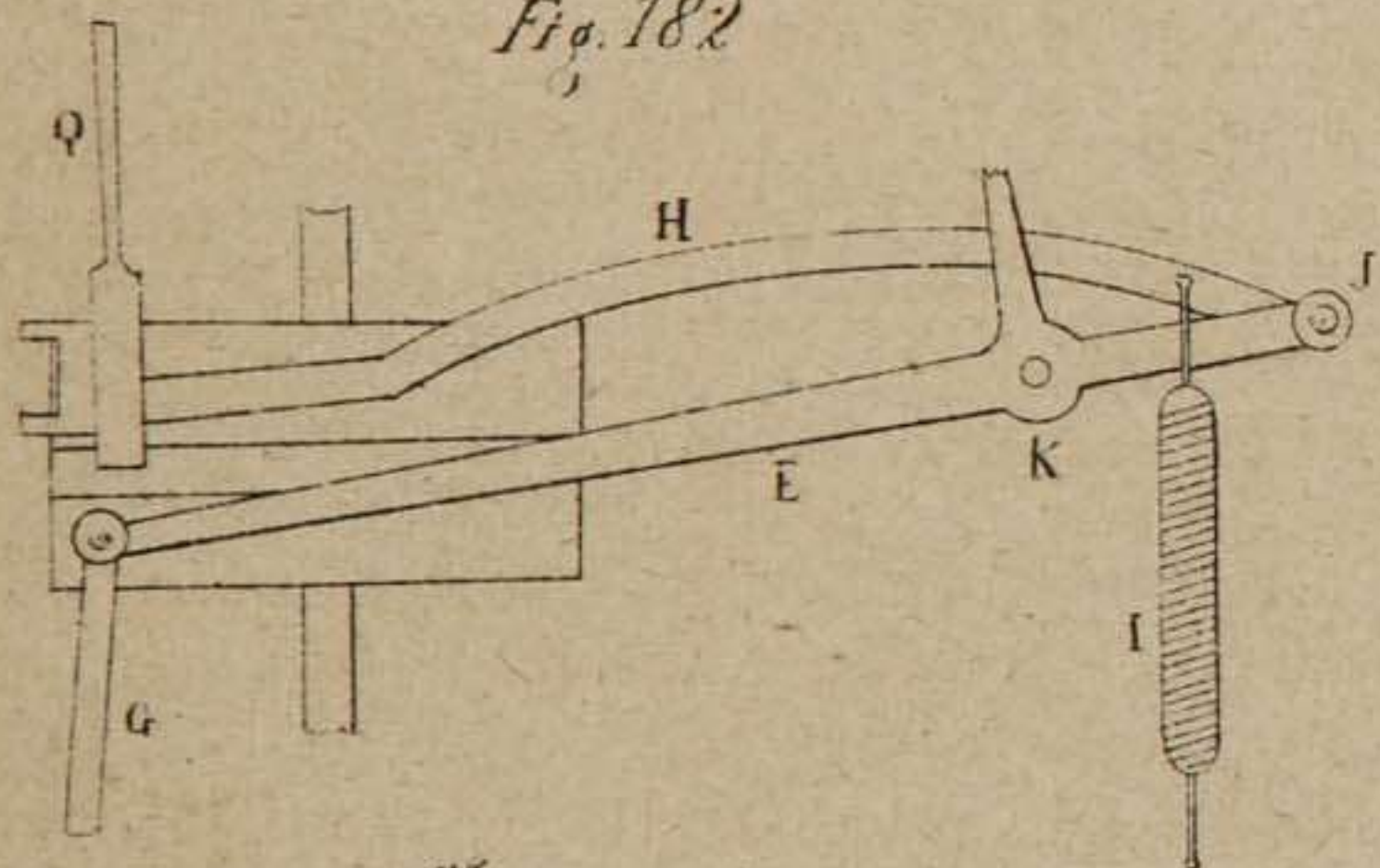
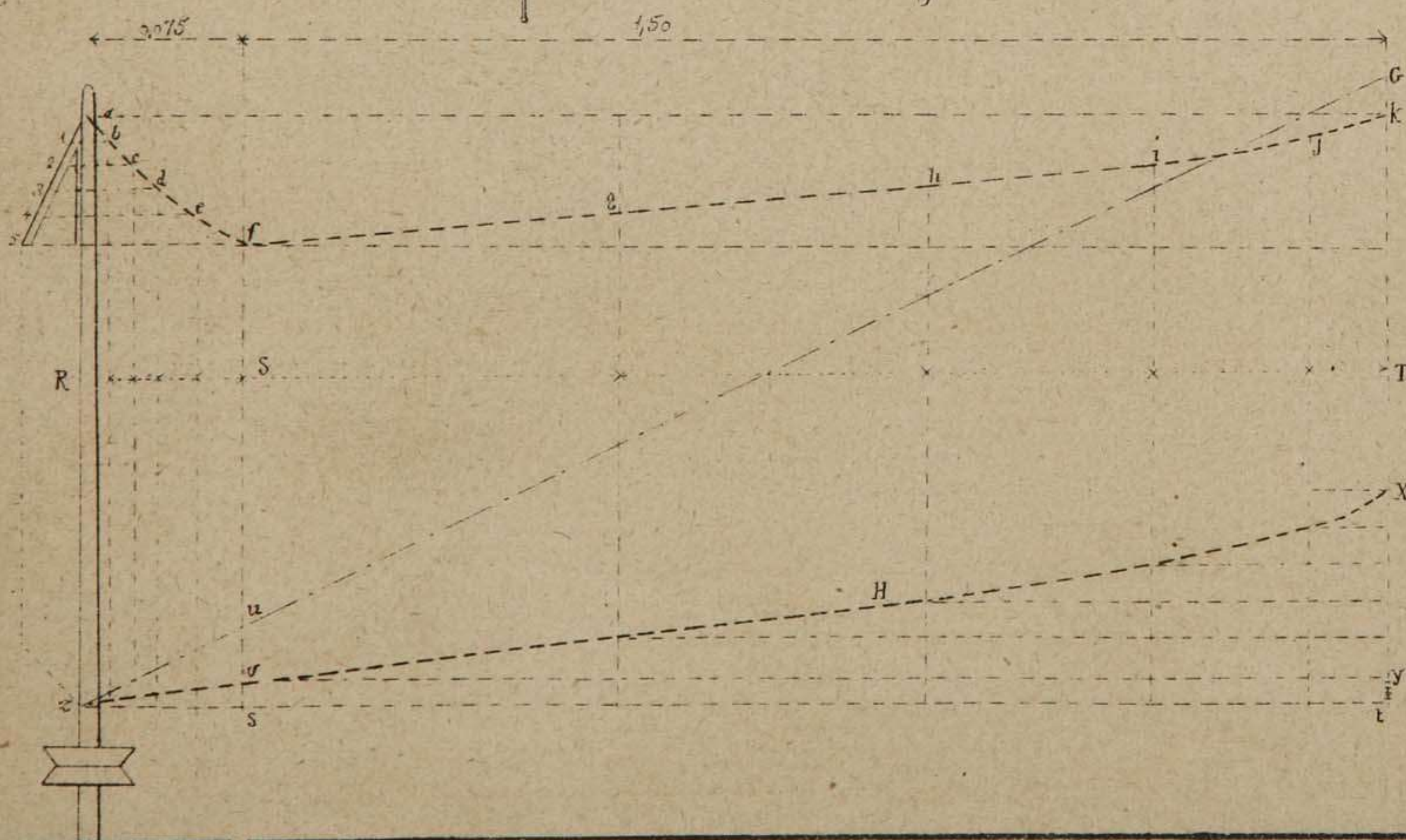


Fig. 179



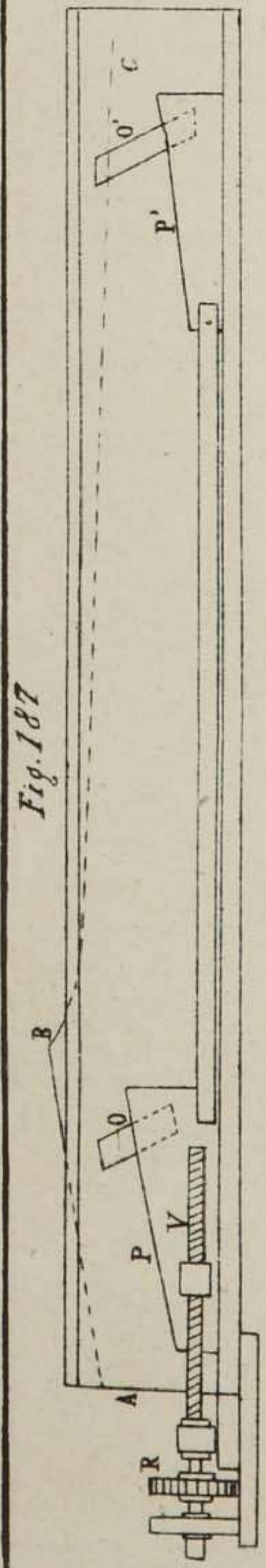


Fig. 187

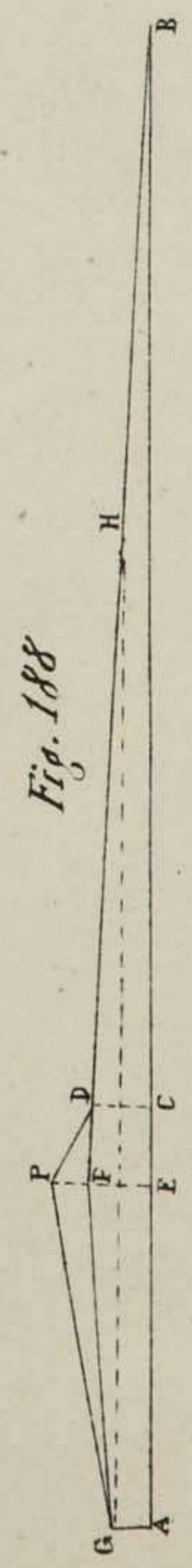


Fig. 188

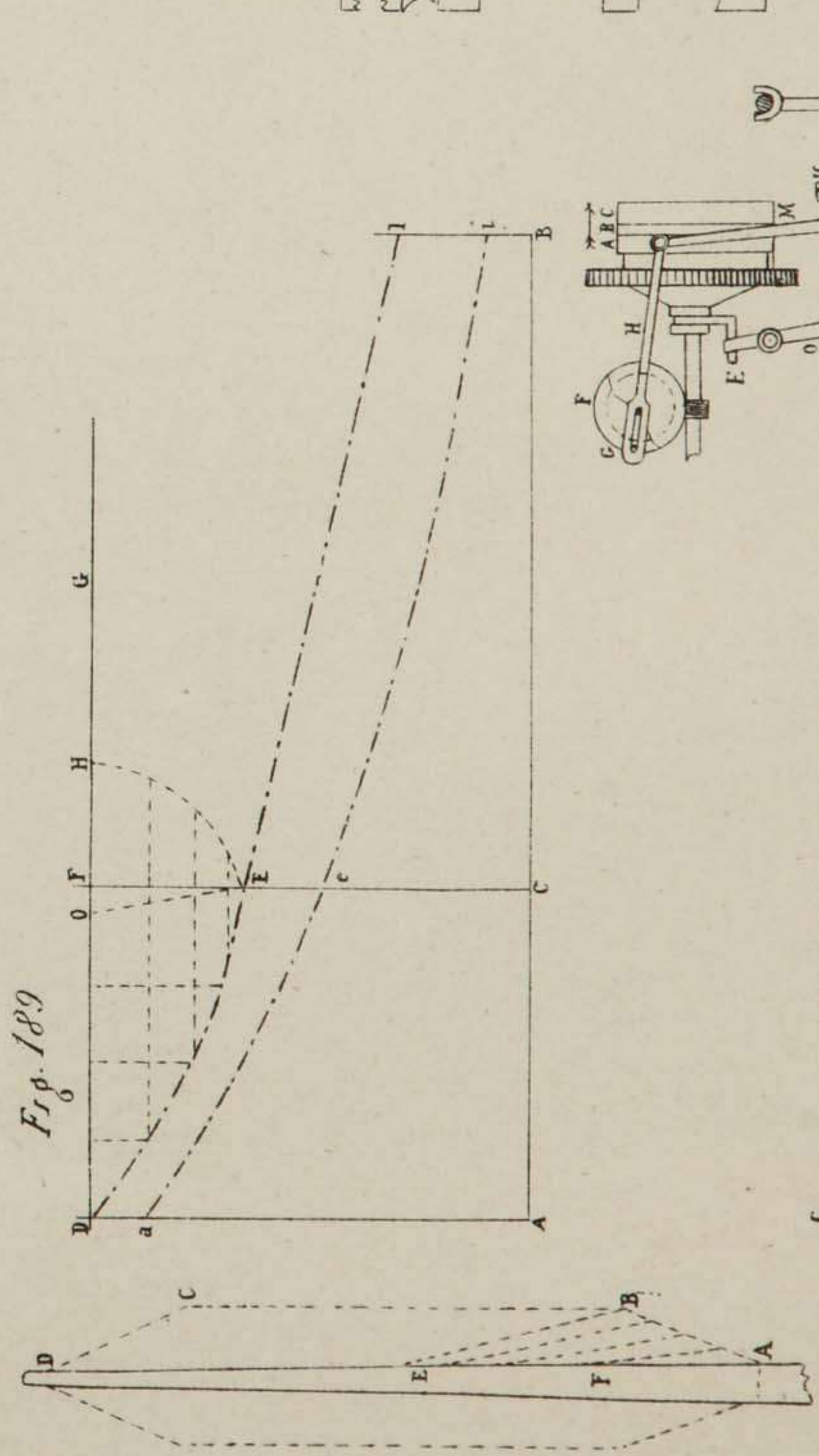


Fig. 189

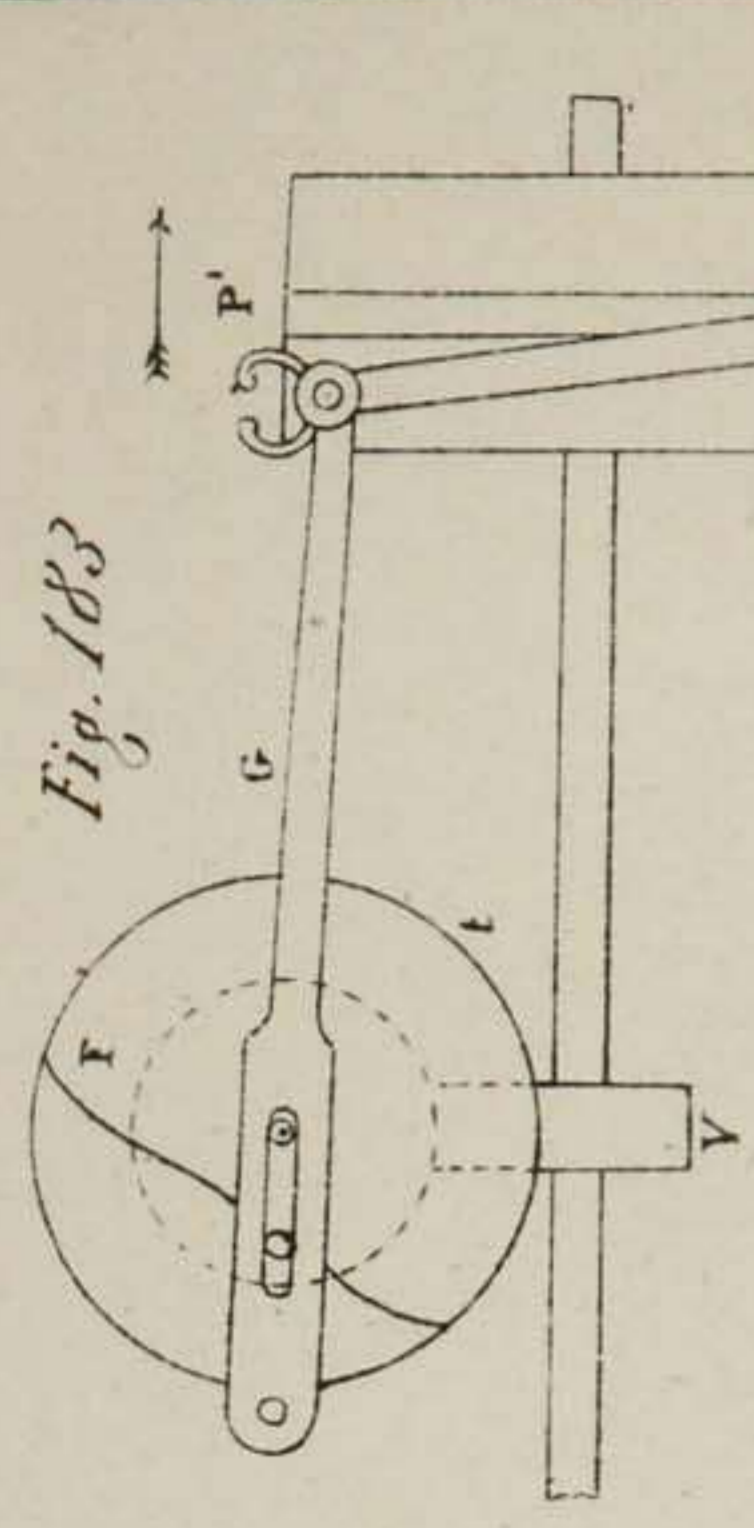


Fig. 183

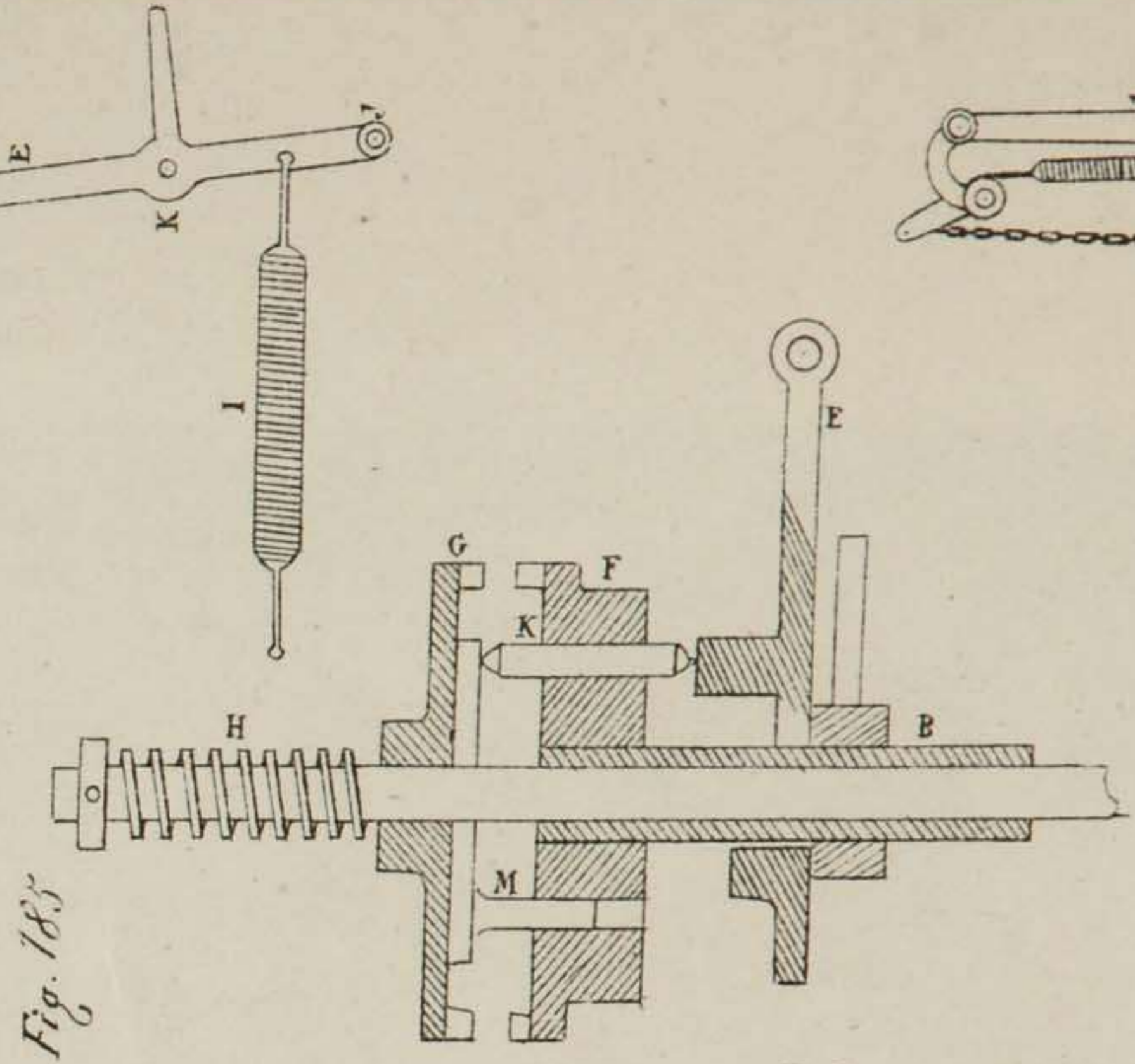


Fig. 185

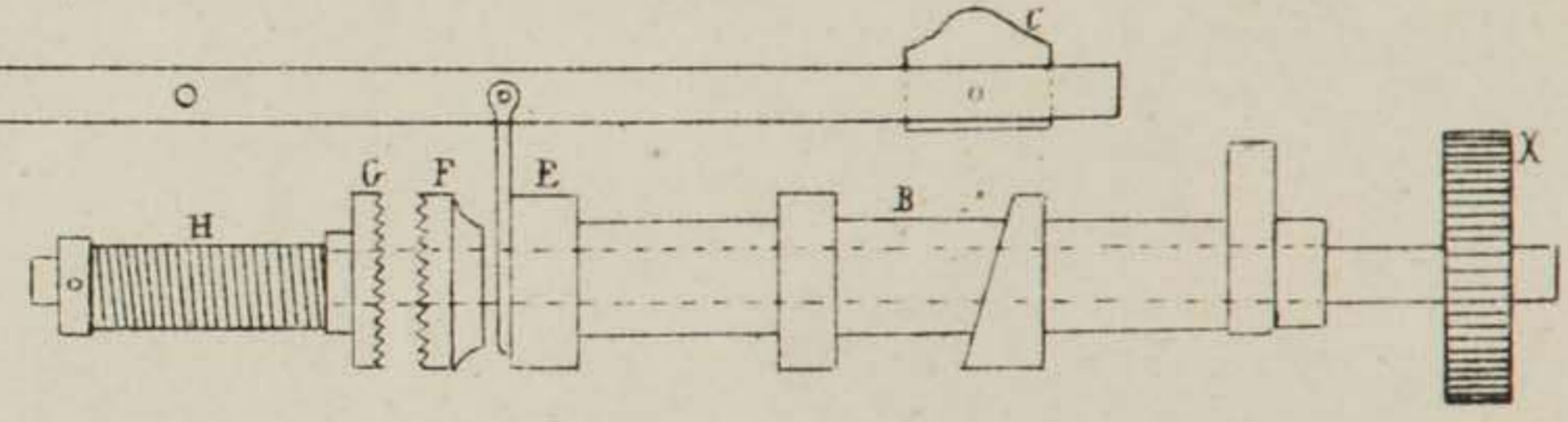


Fig. 184

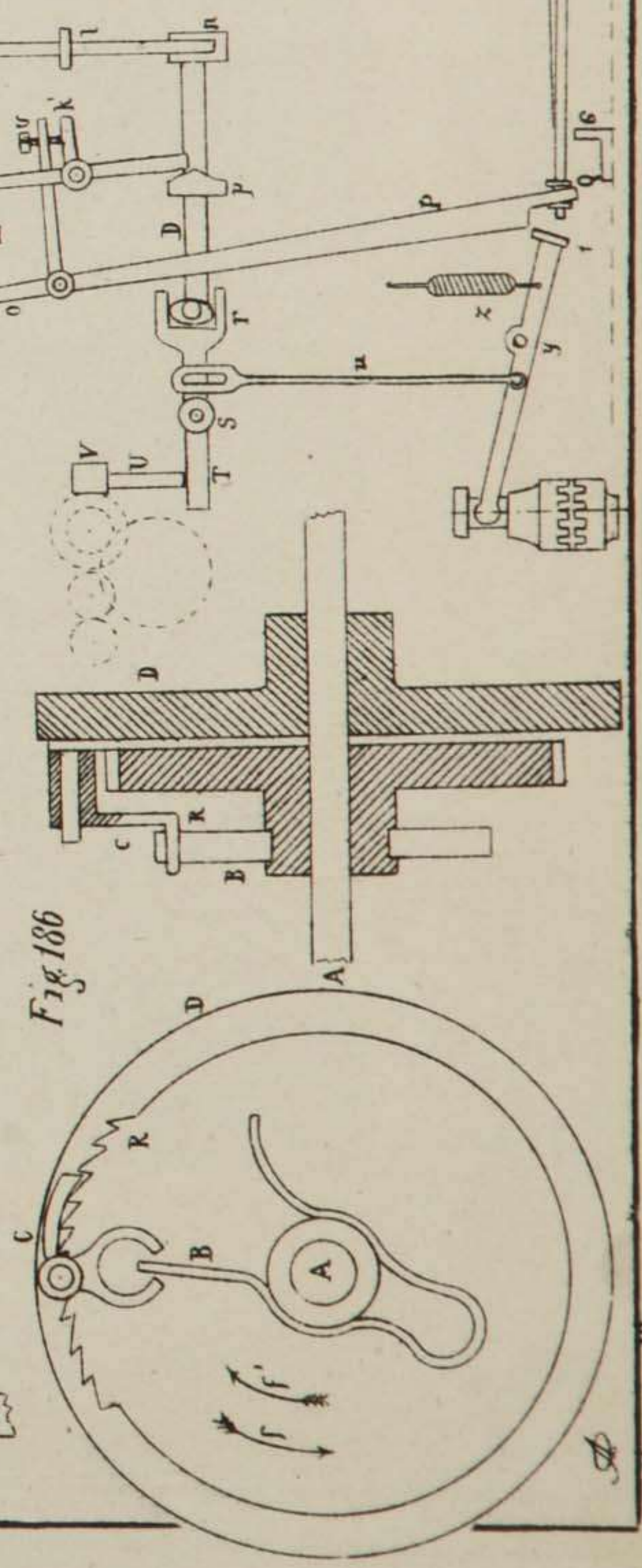
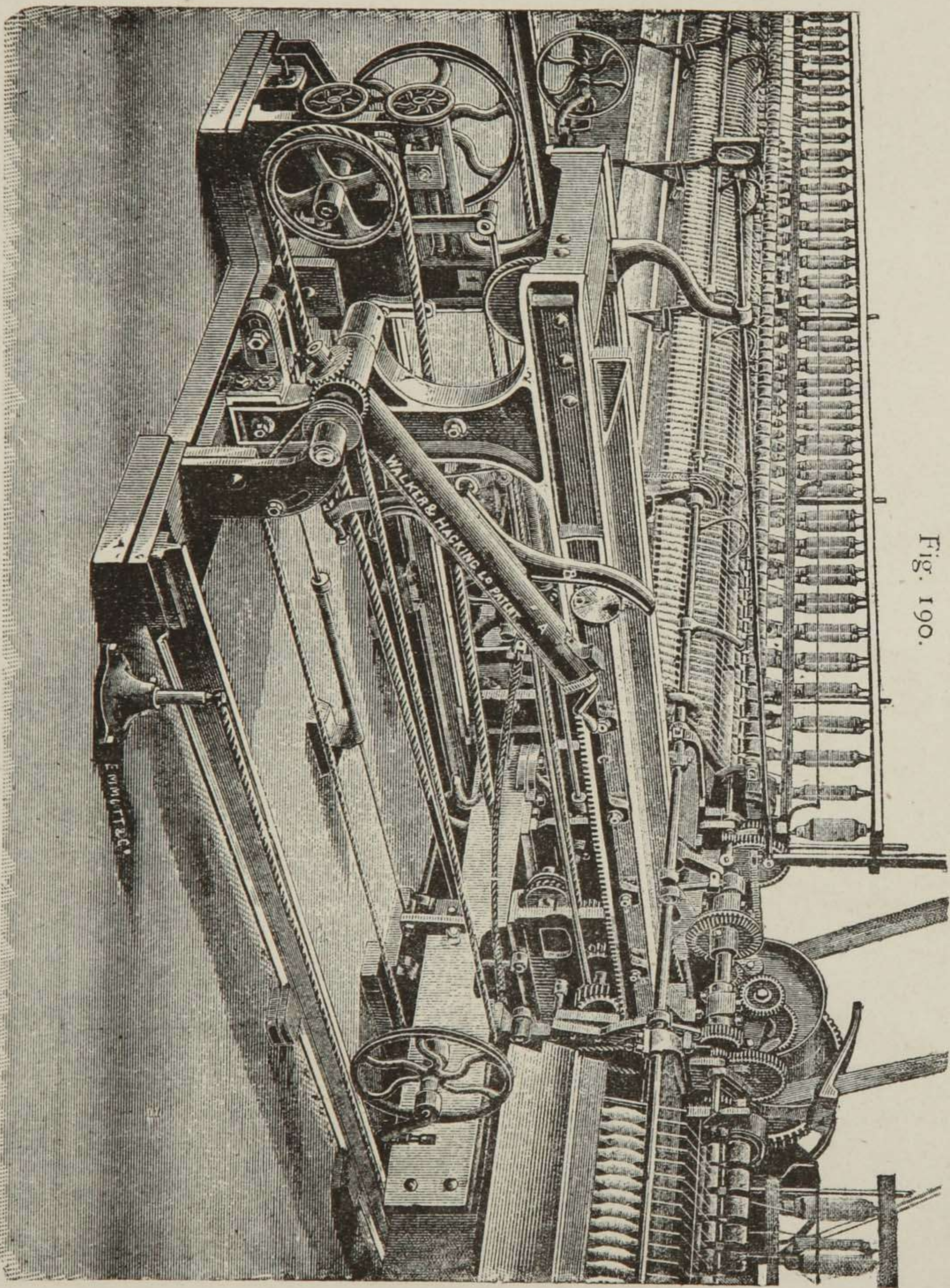


Fig. 186

Fig. 190.



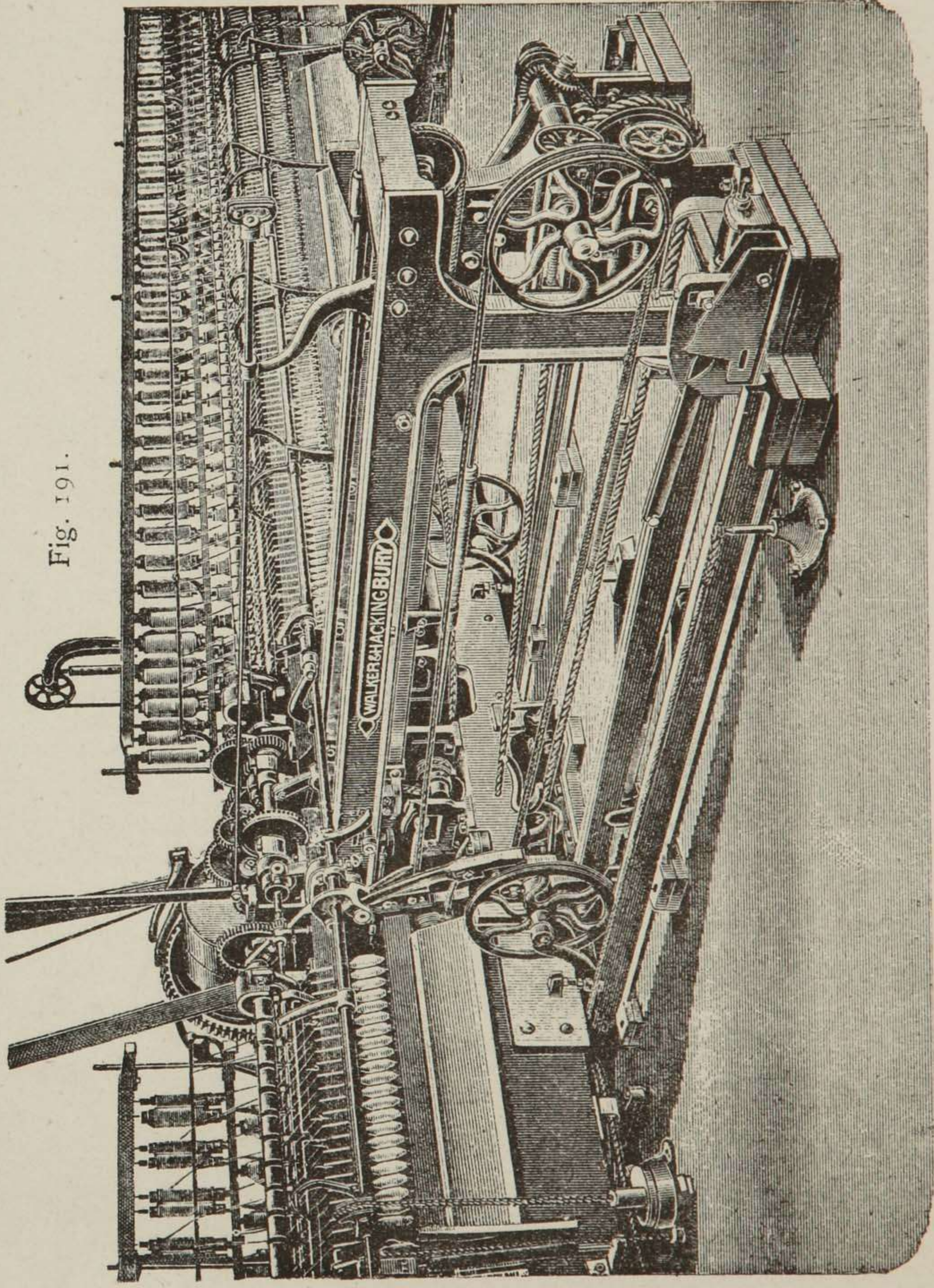


Fig. 191.

Fig. 192

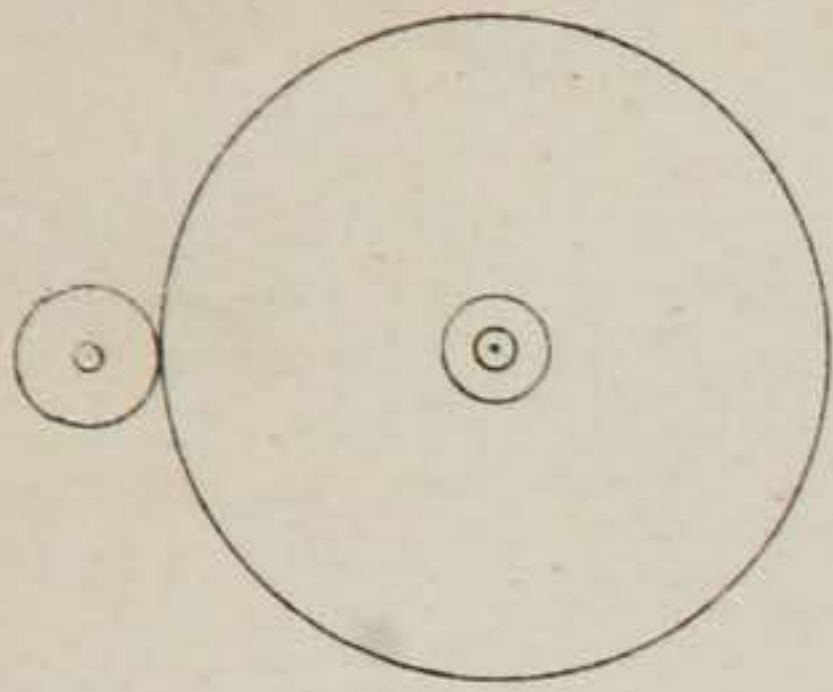


Fig. 198'

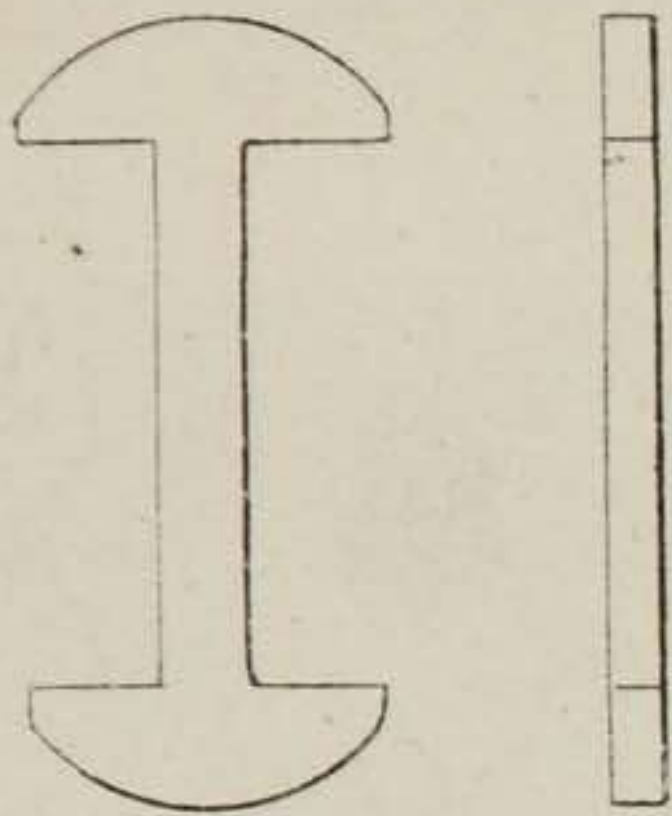


Fig. 191

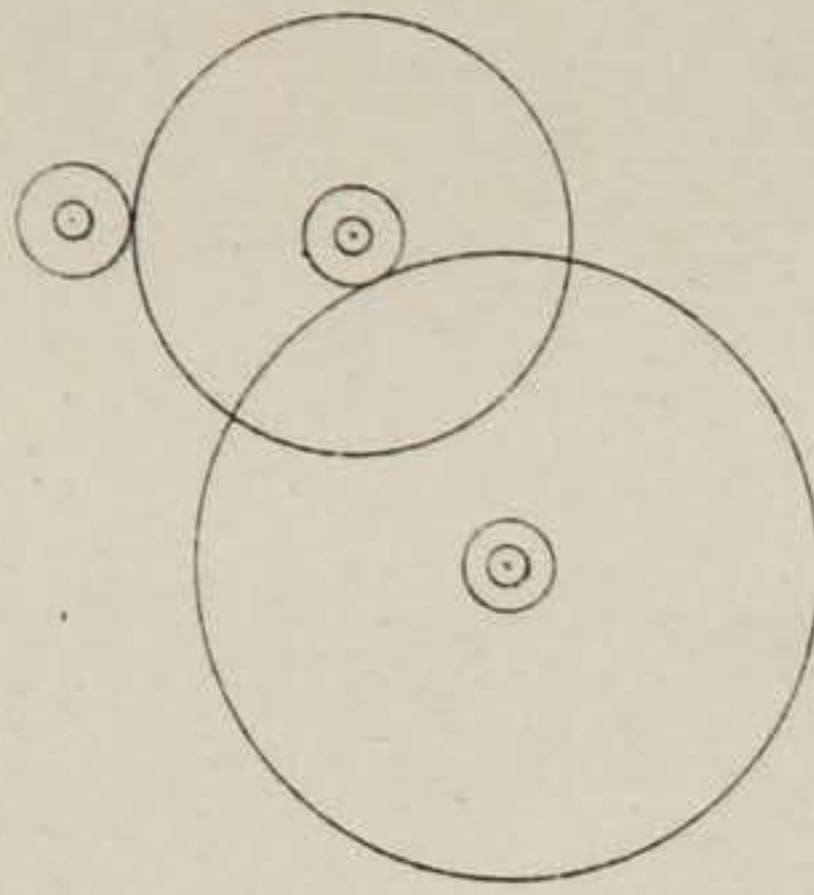


Fig. 193

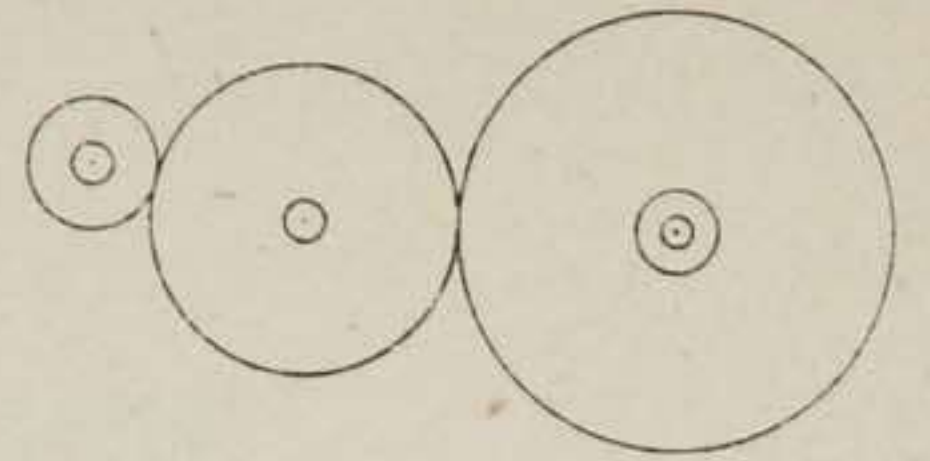


Fig. 195

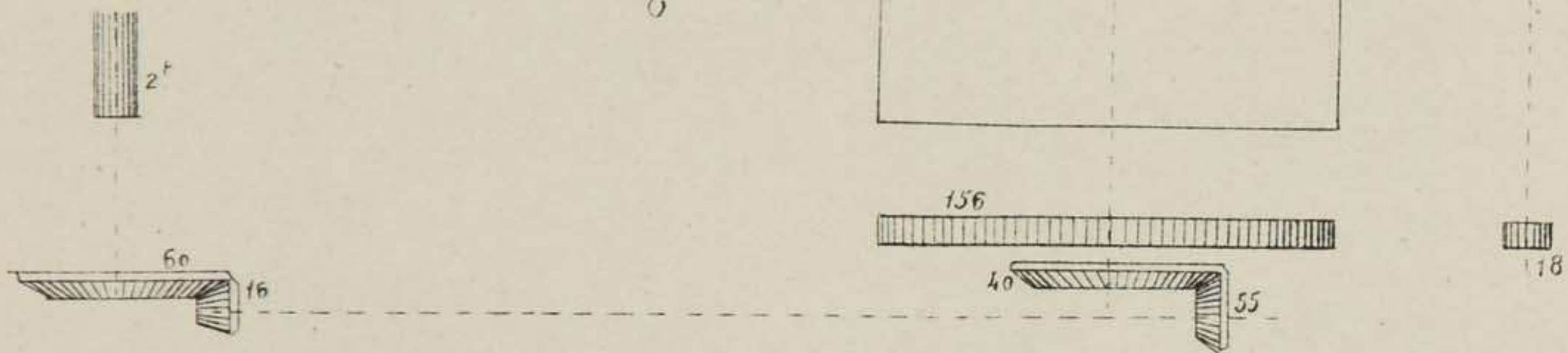


Fig. 196

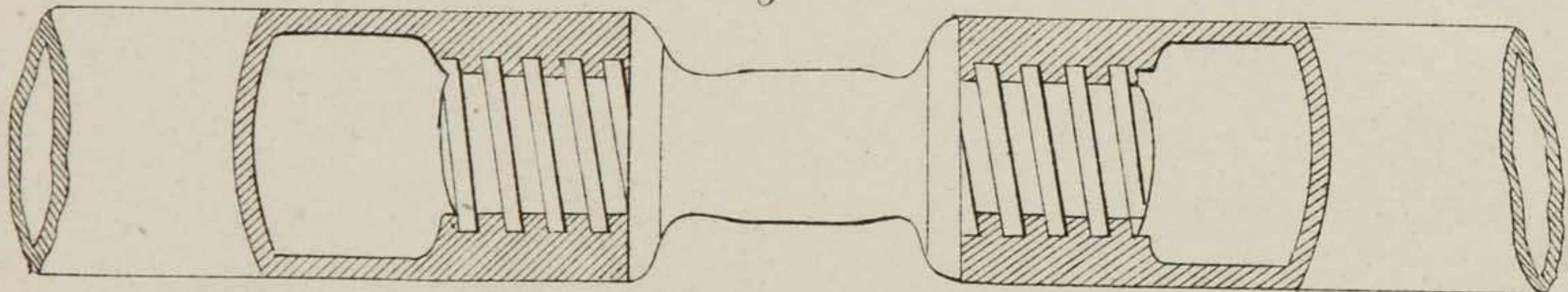


Fig. 199

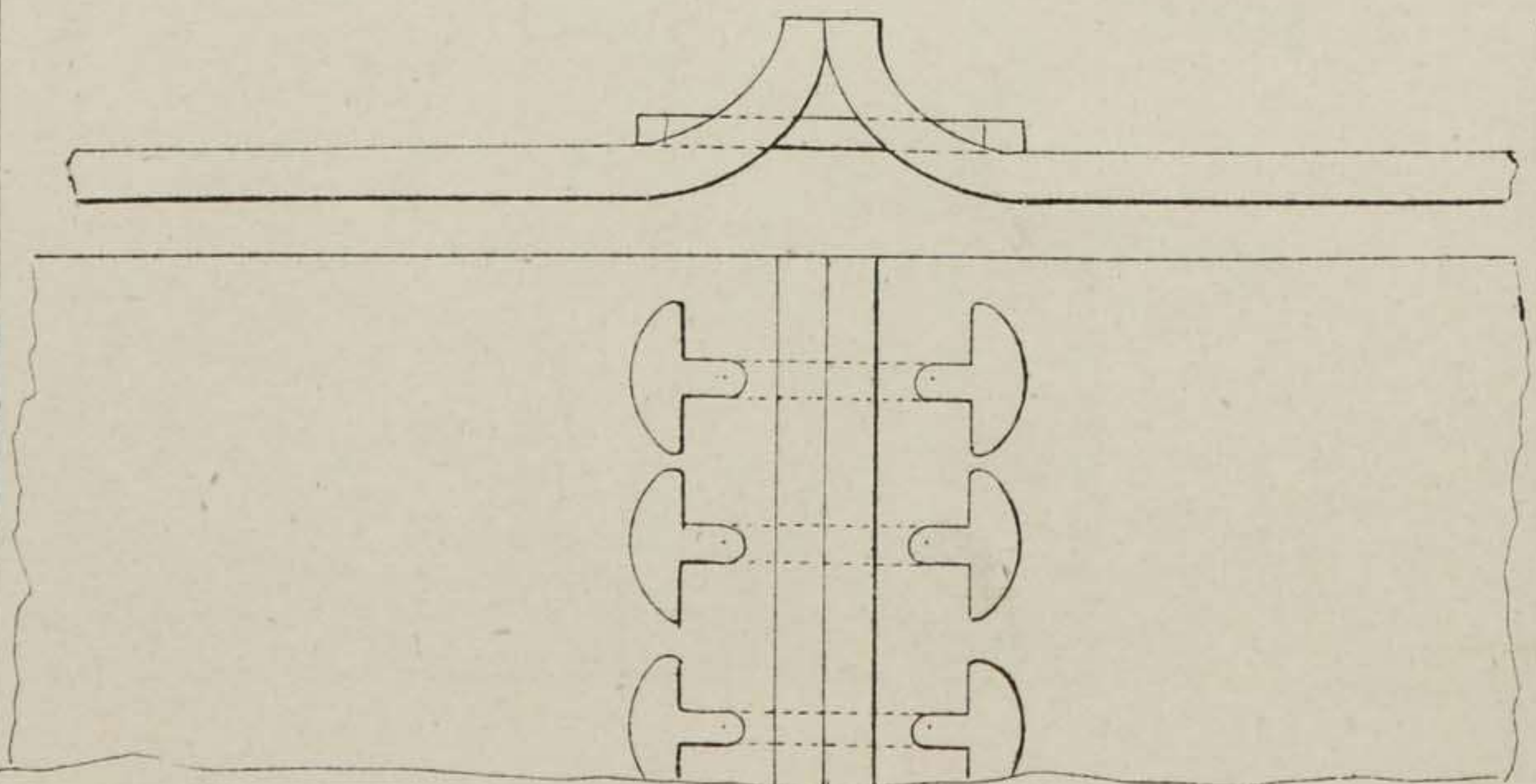
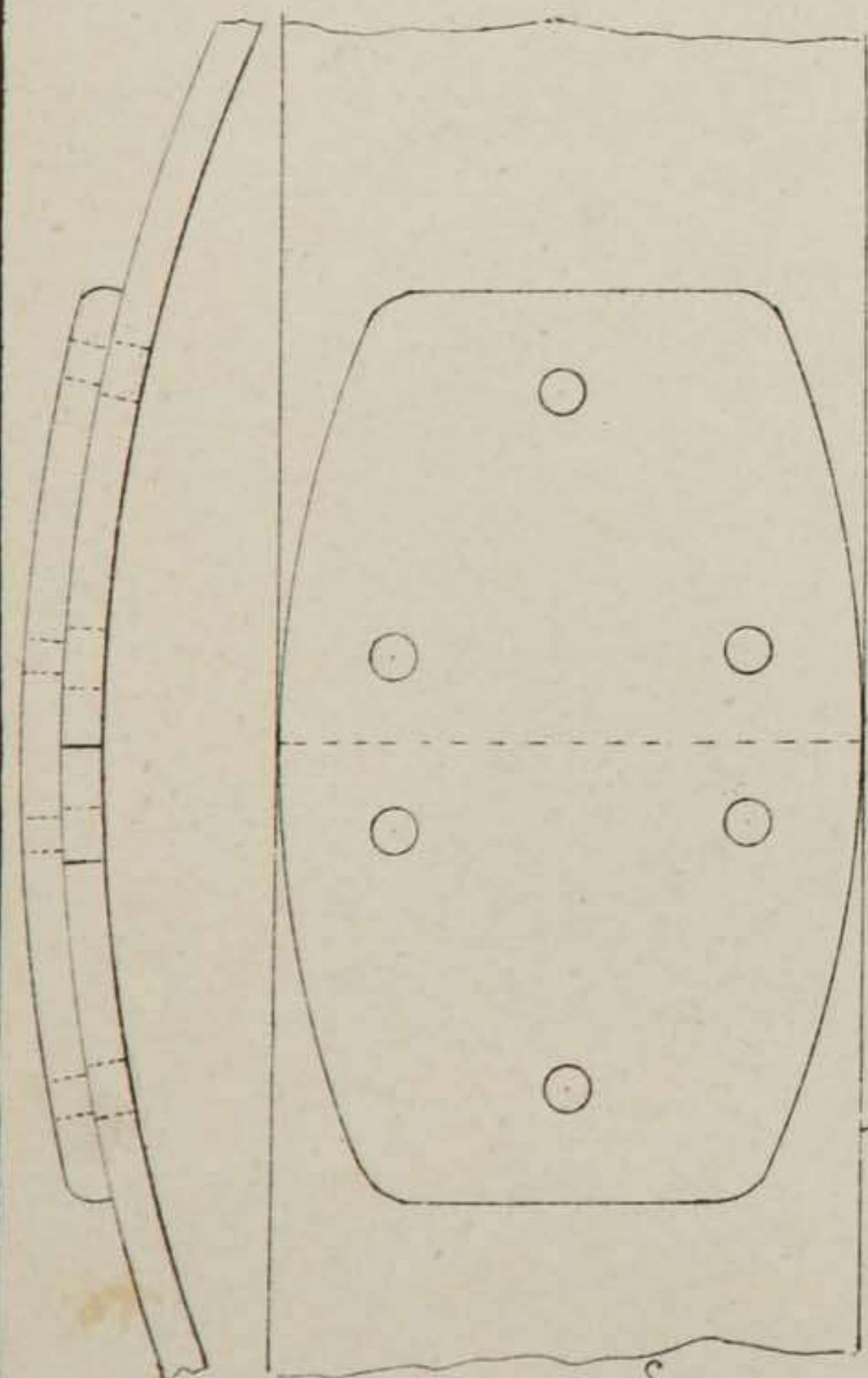


Fig. 197



At

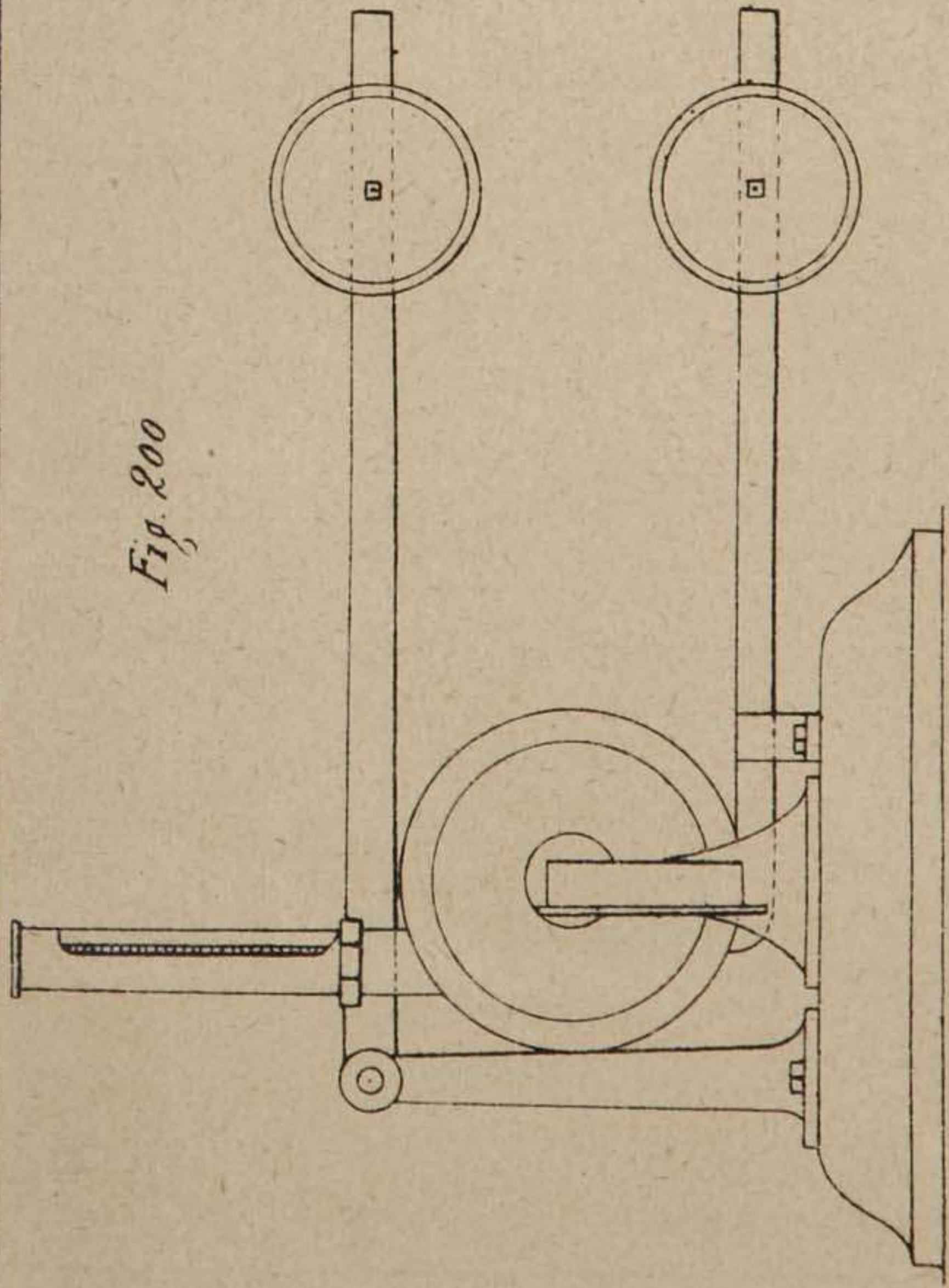


Fig. 200

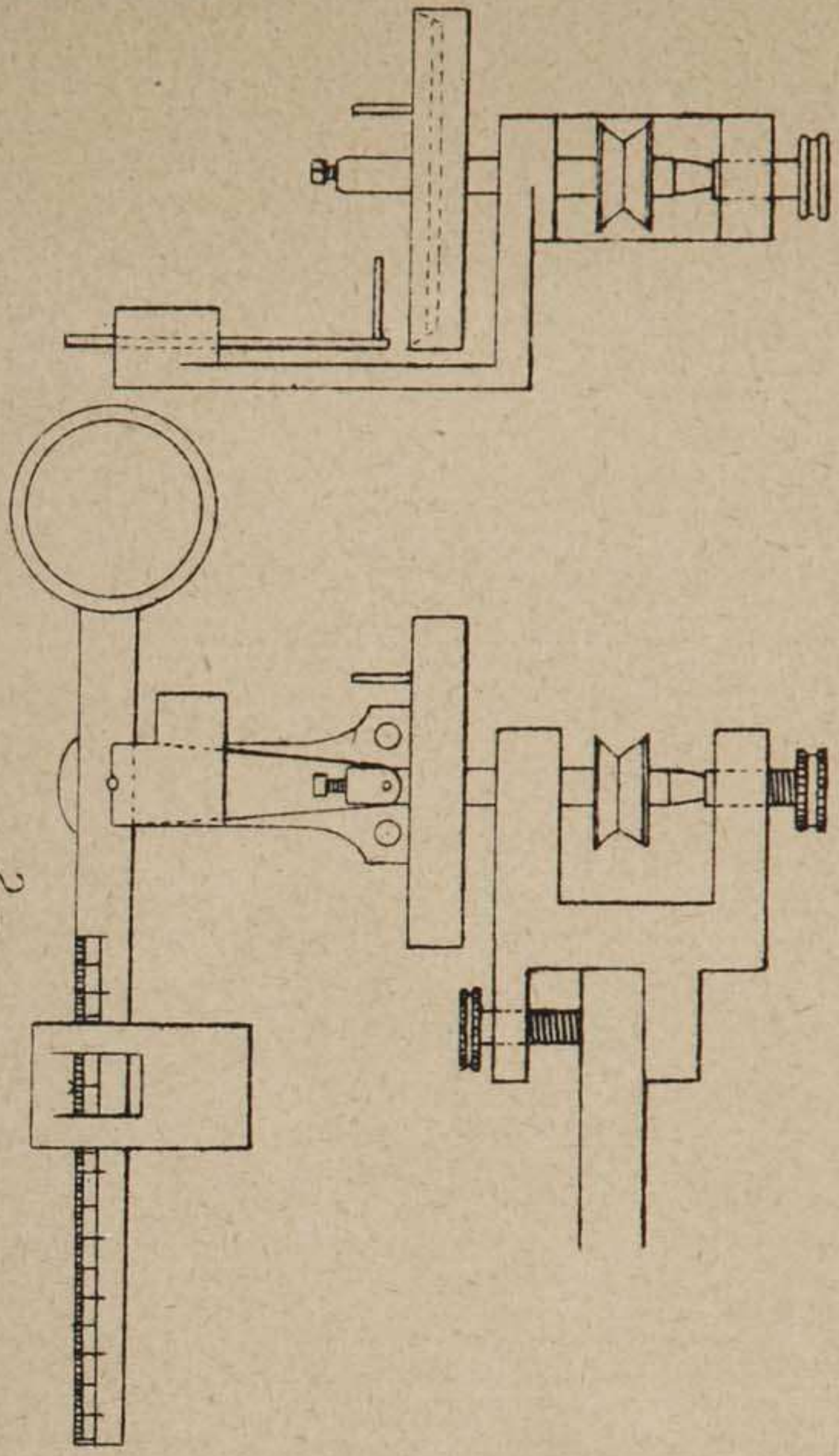


Fig. 201

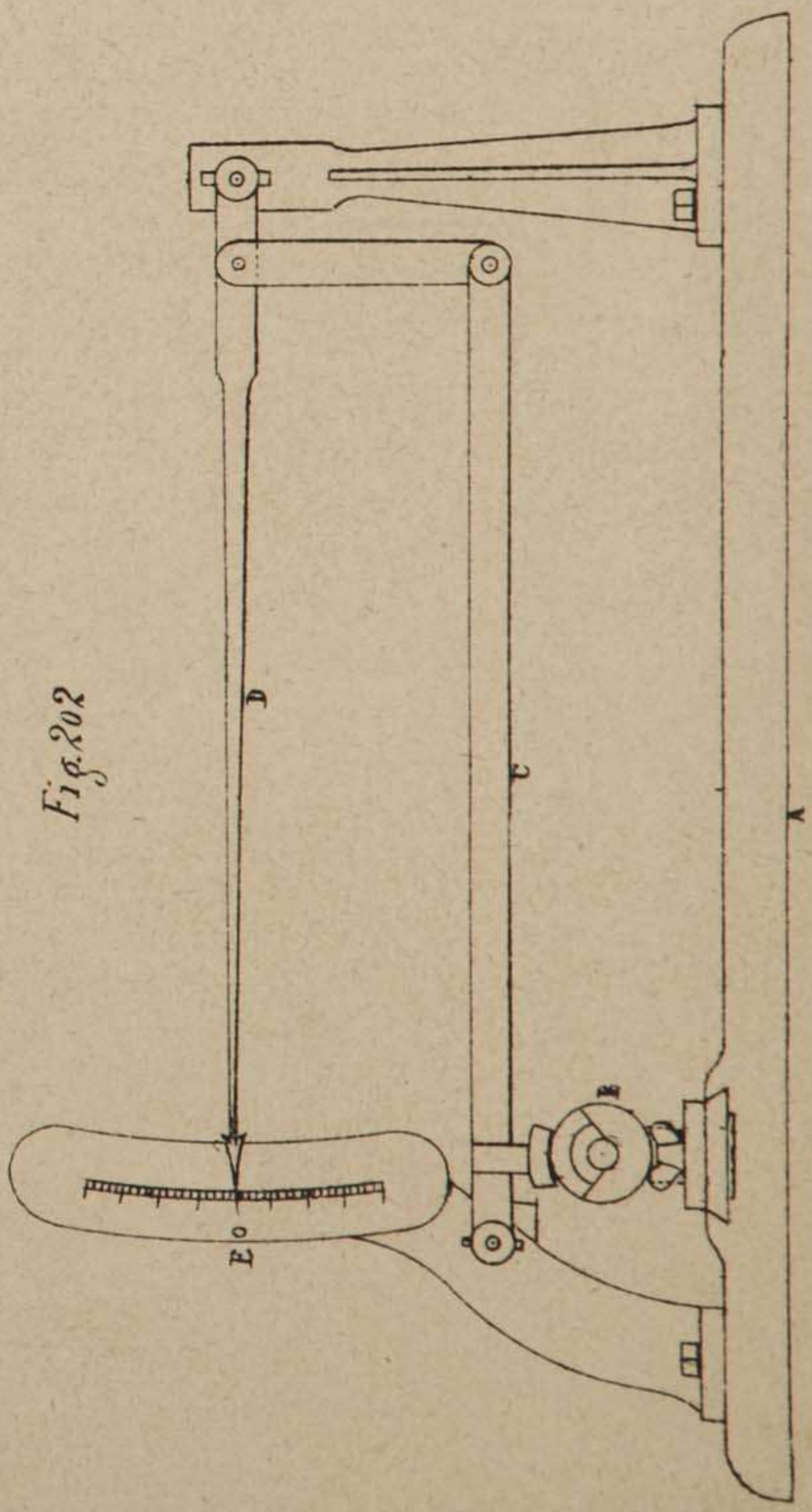


Fig. 202

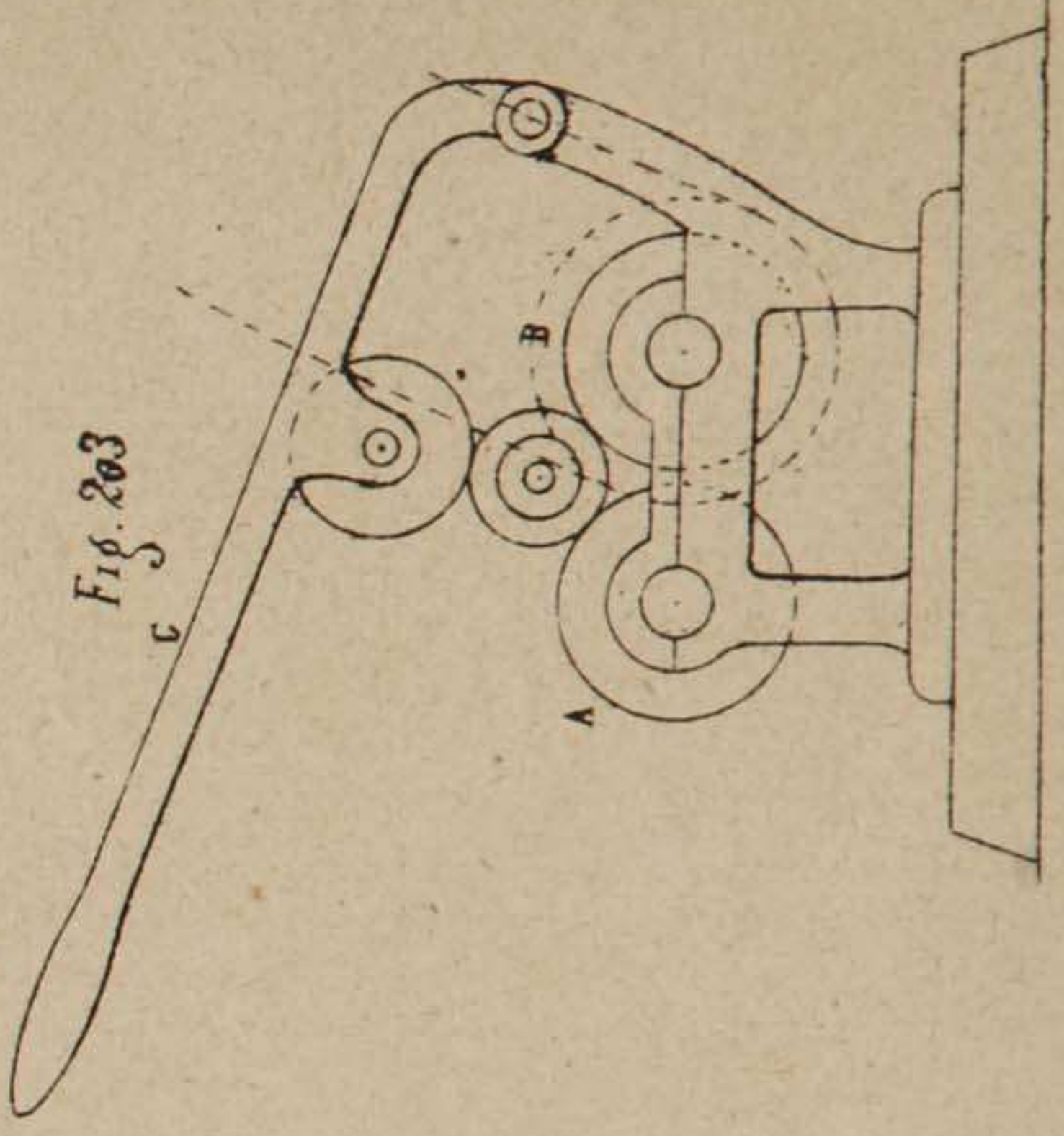
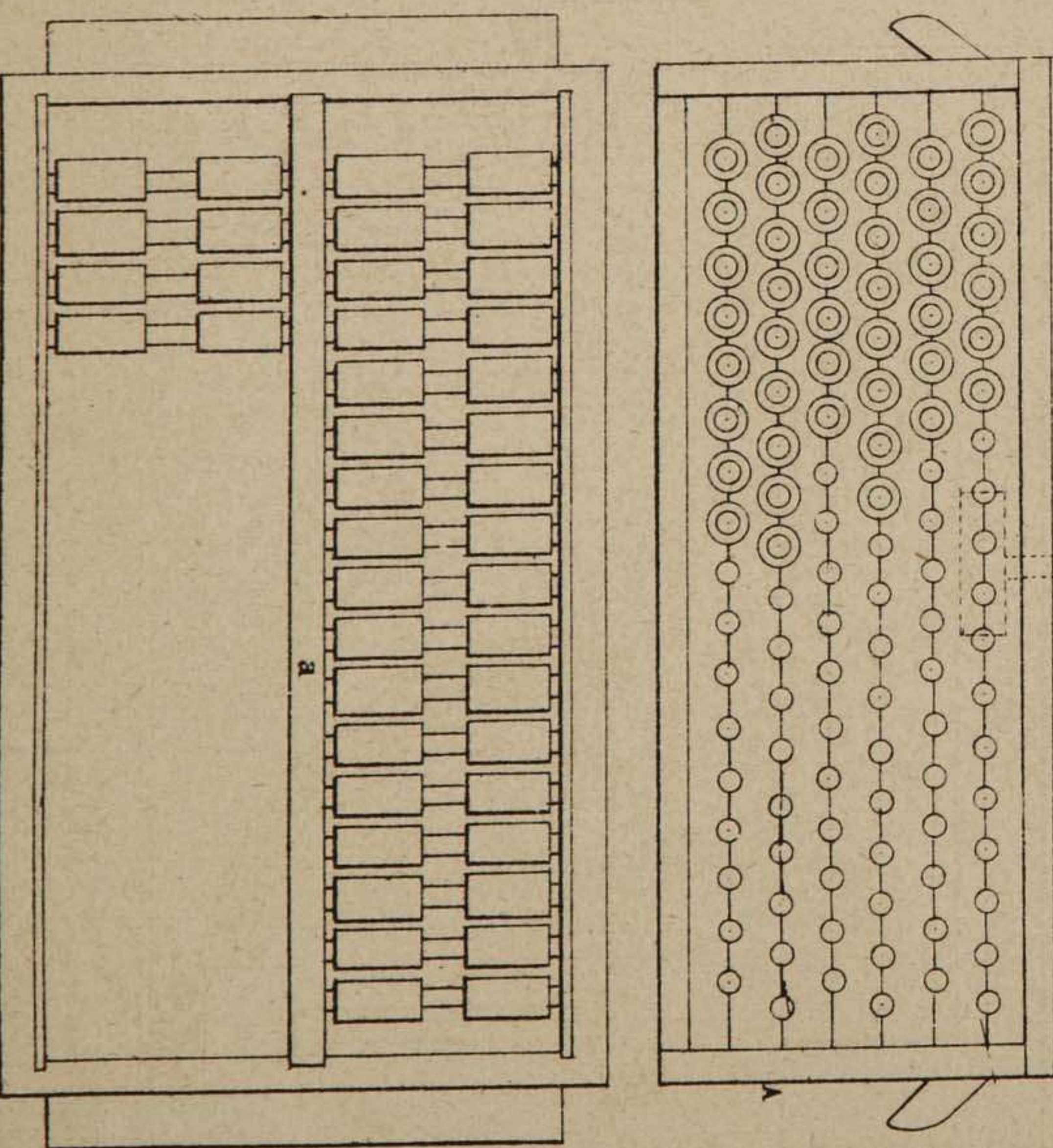
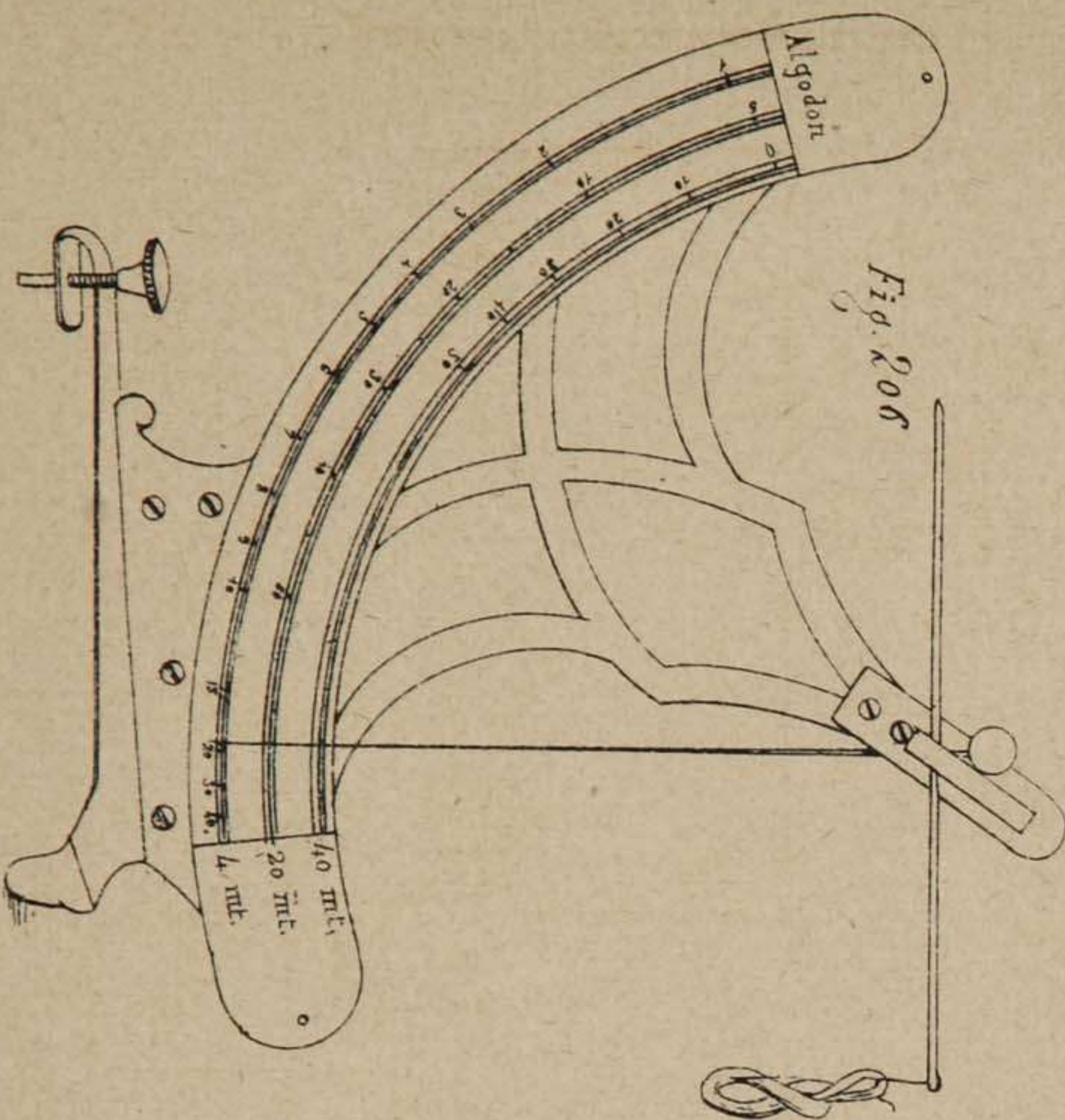
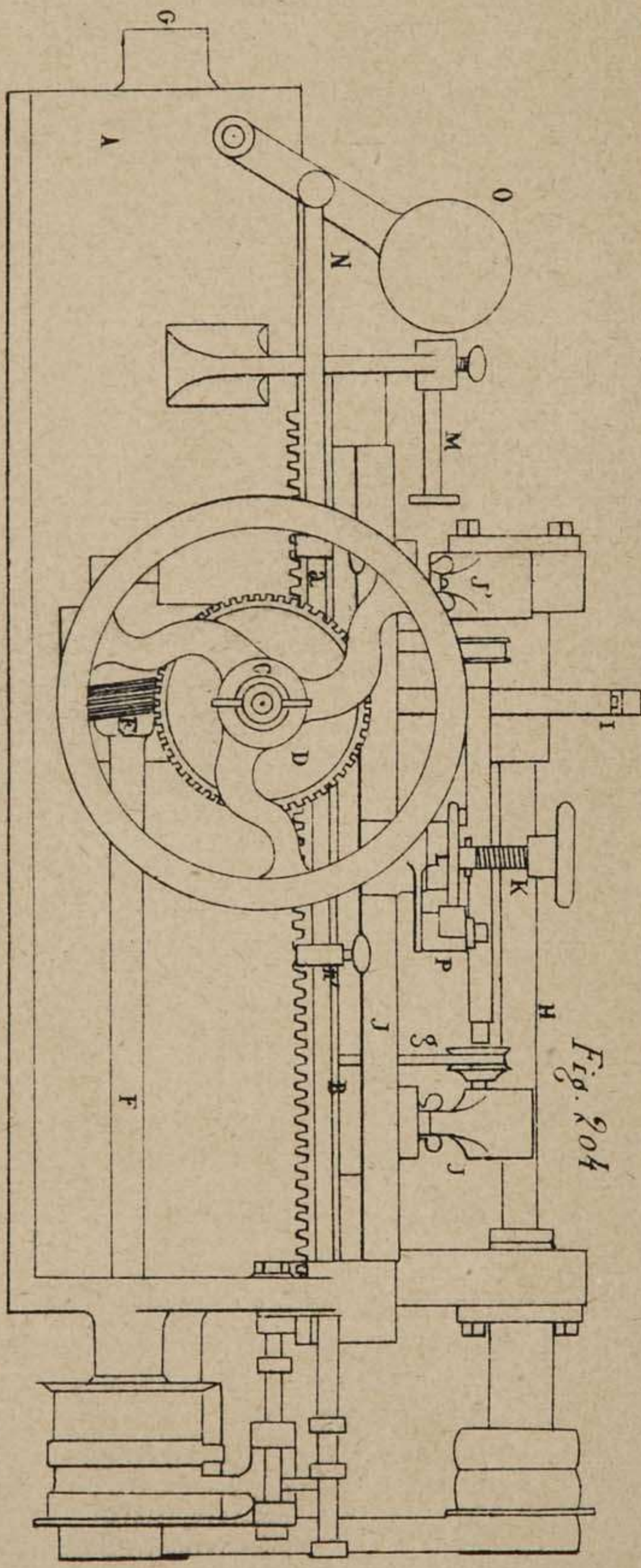
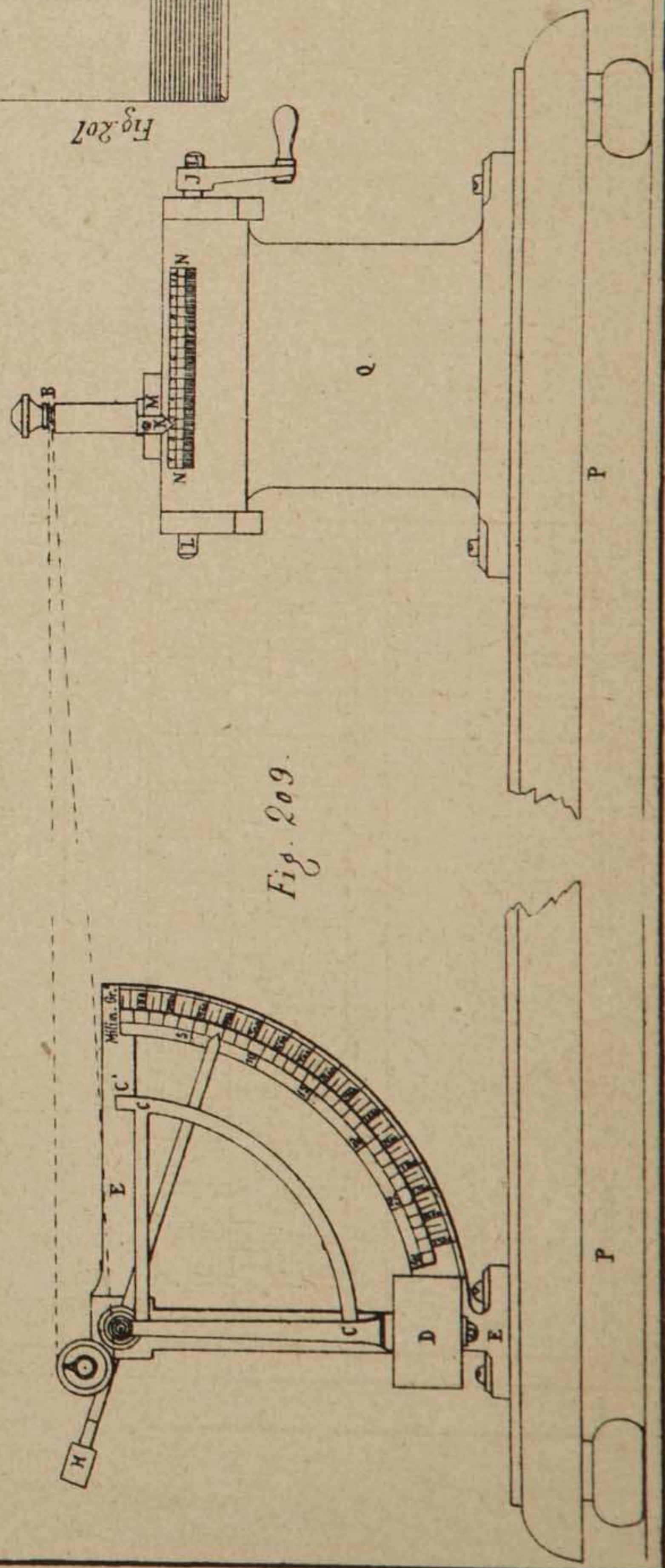
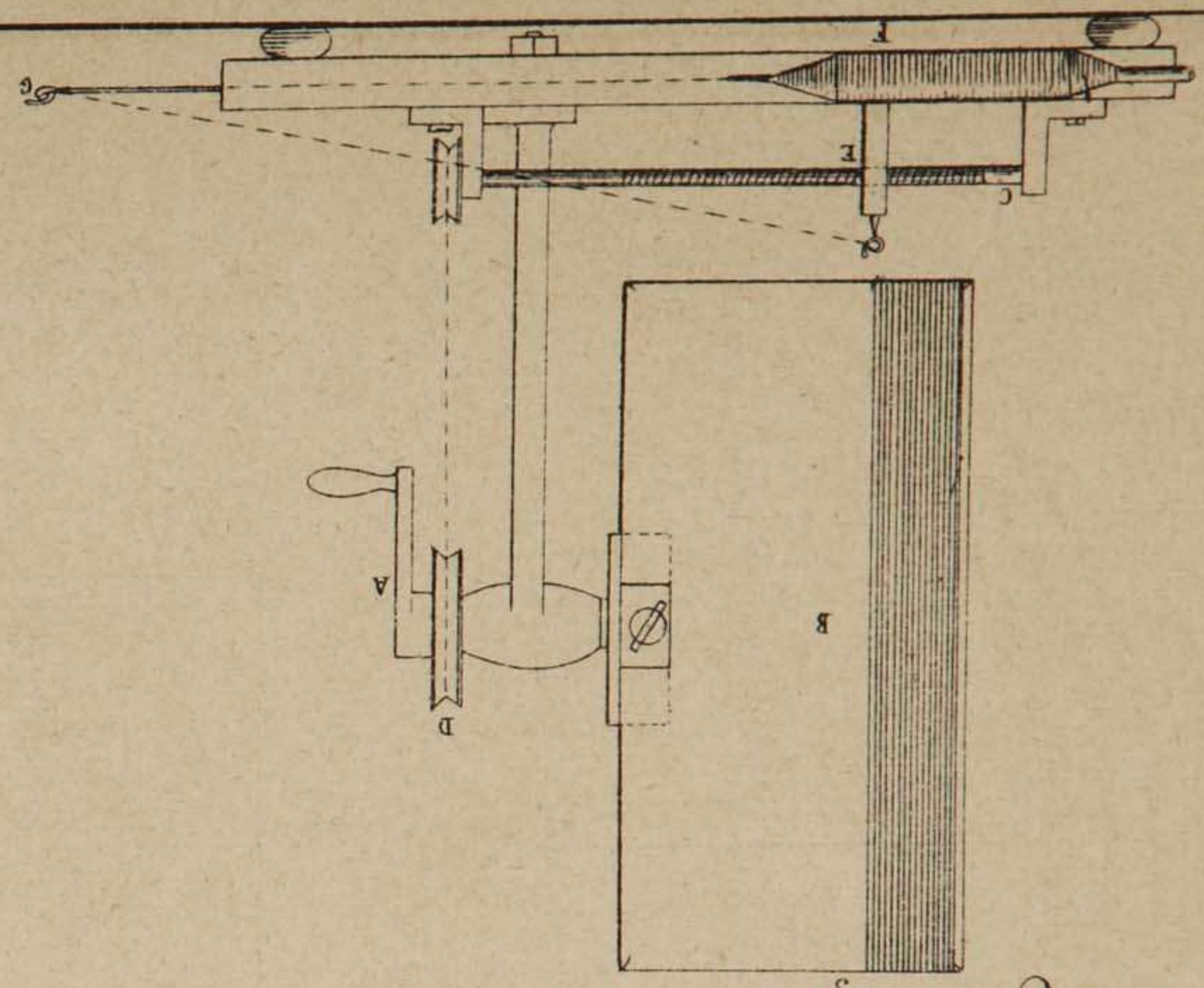
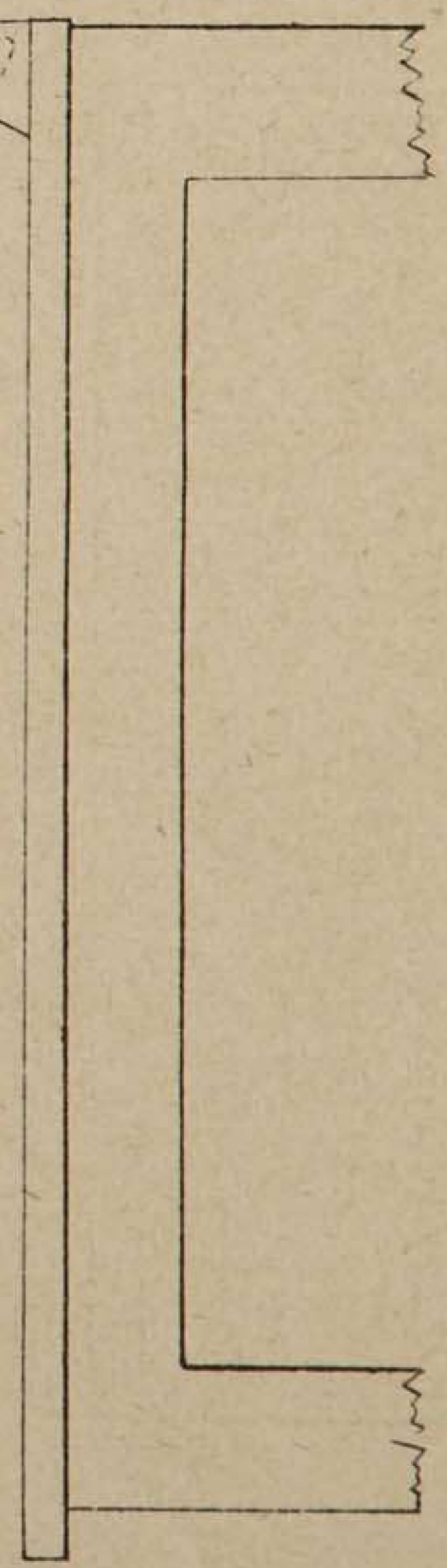
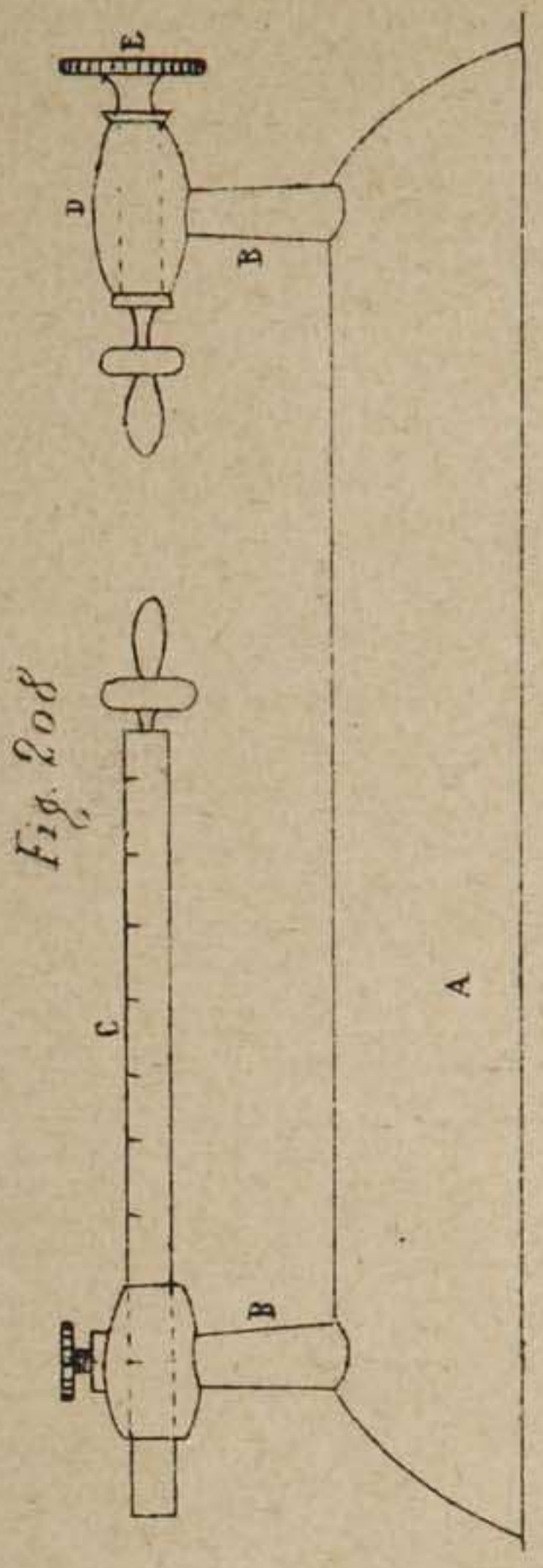
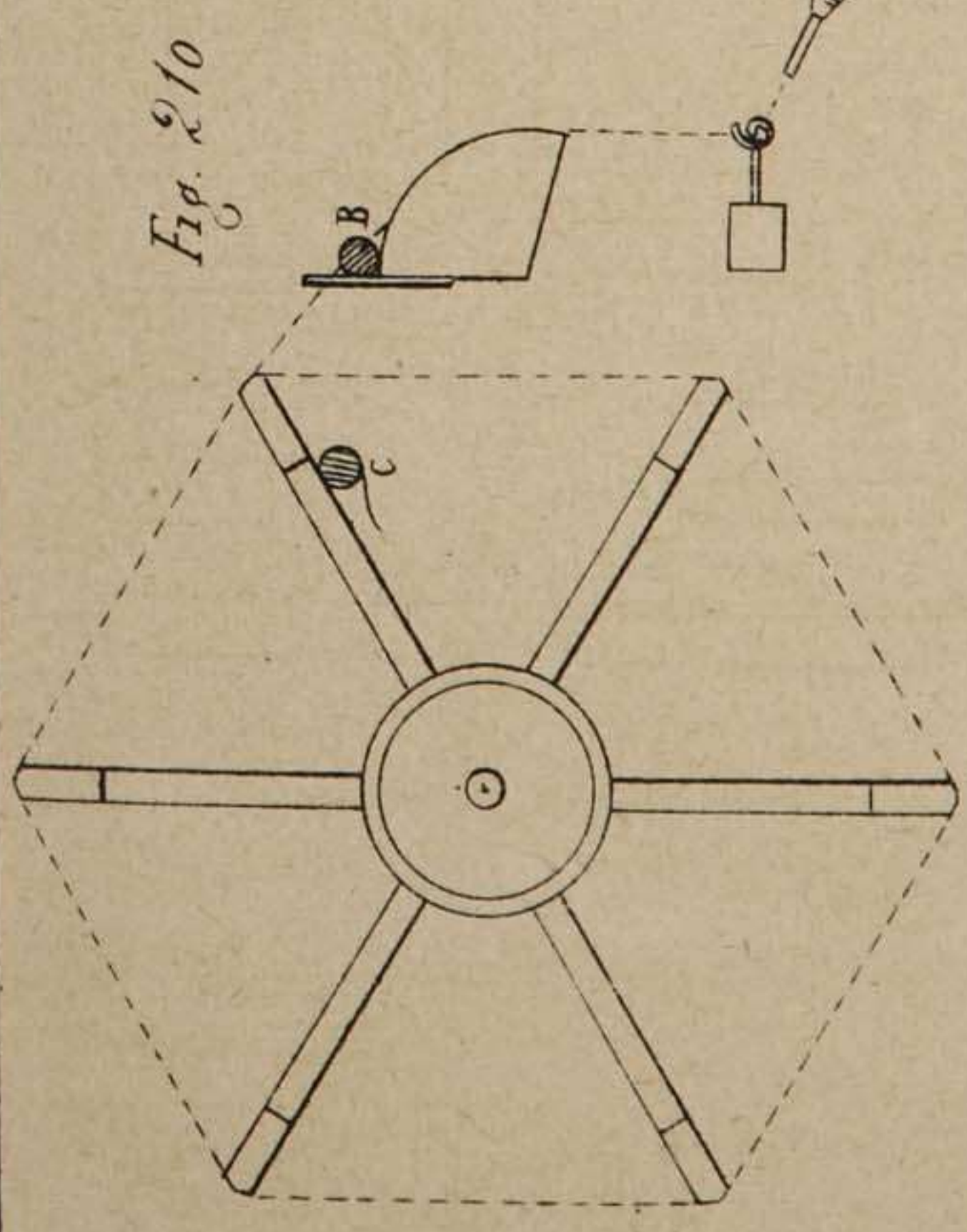


Fig. 203





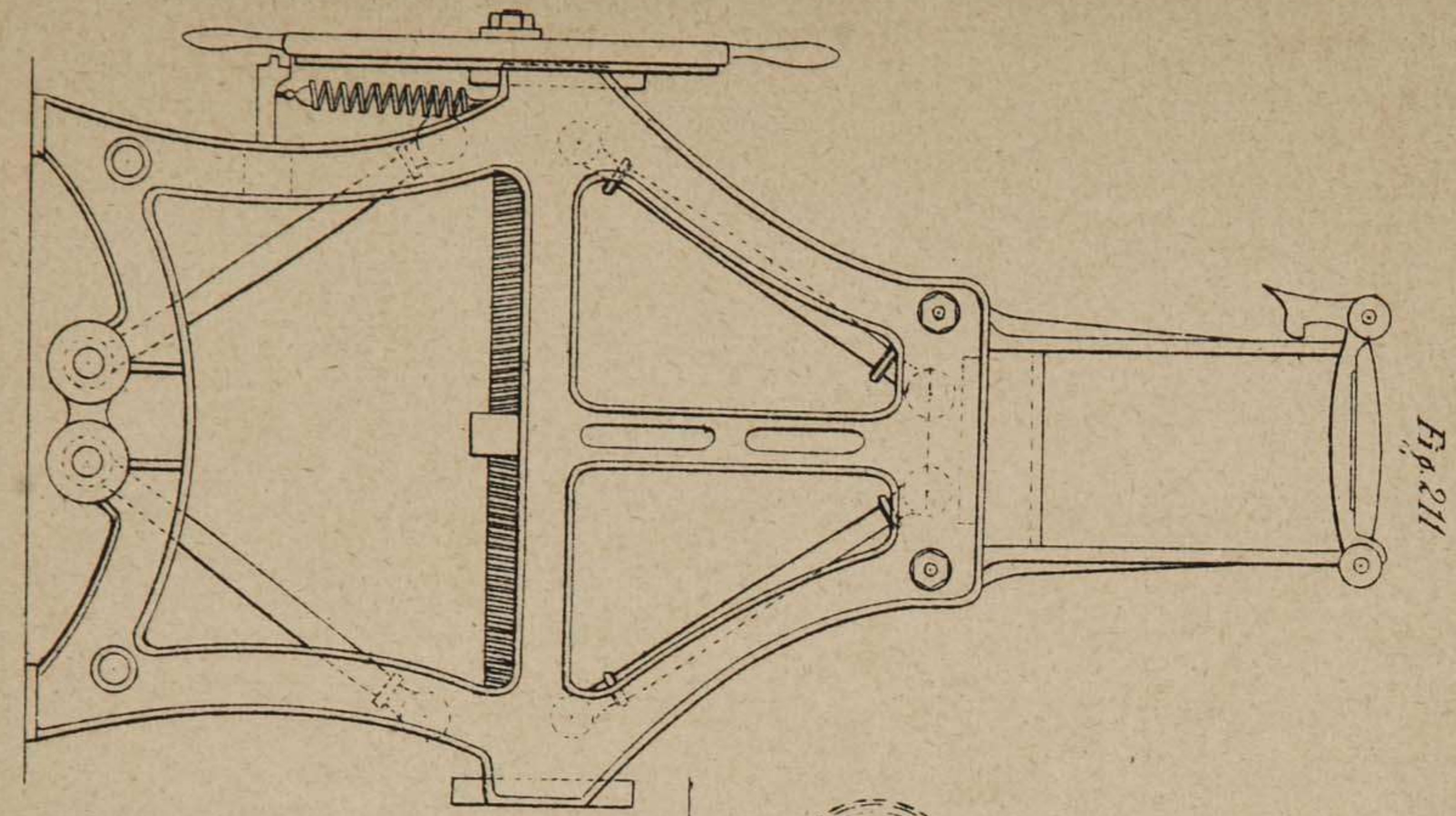


Fig. 211

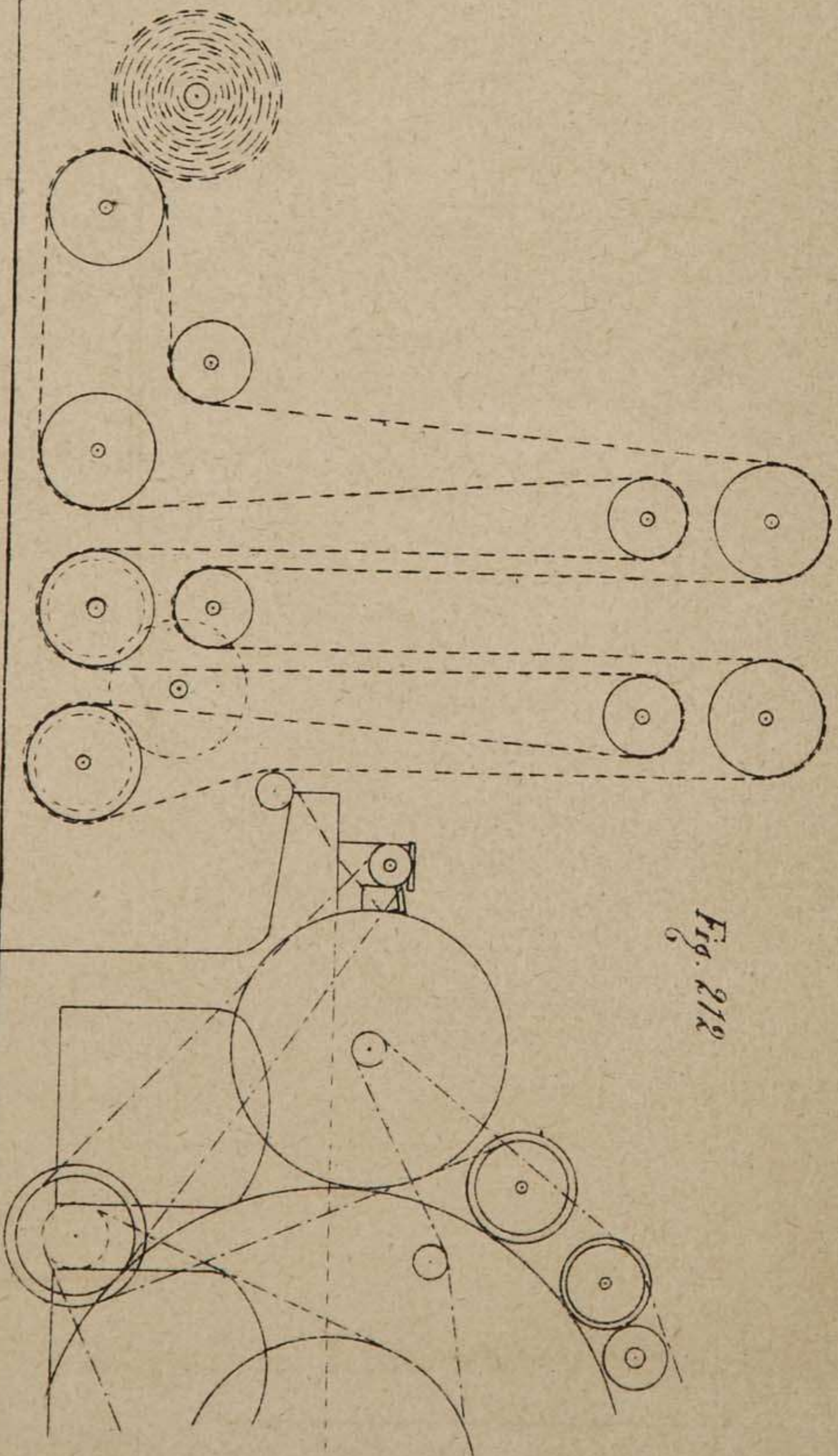


Fig. 212

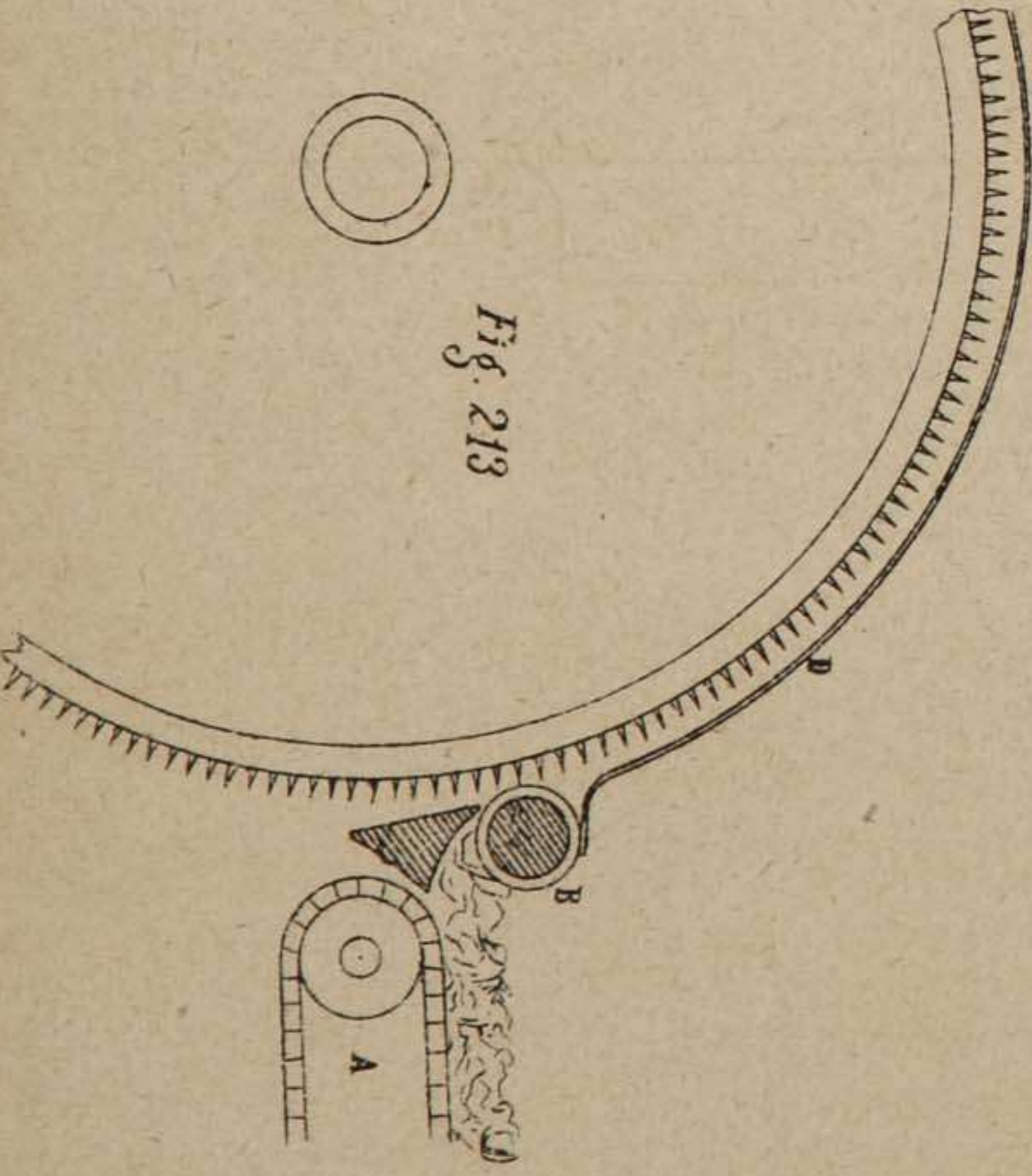


Fig. 213

Ricetti, editor.

Paseo de Gracia, 149.

Fig. 217.

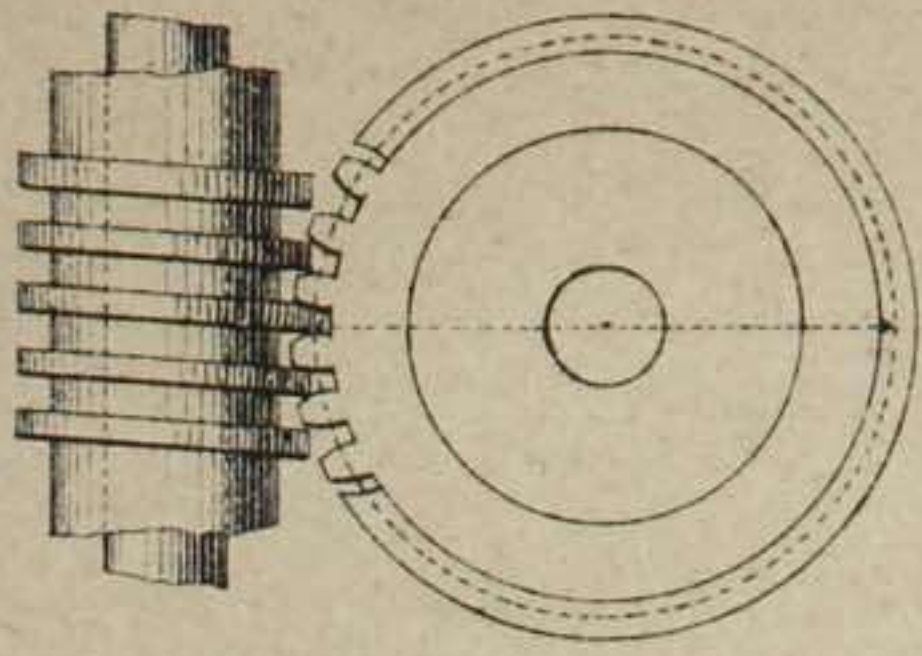


Fig. 215.

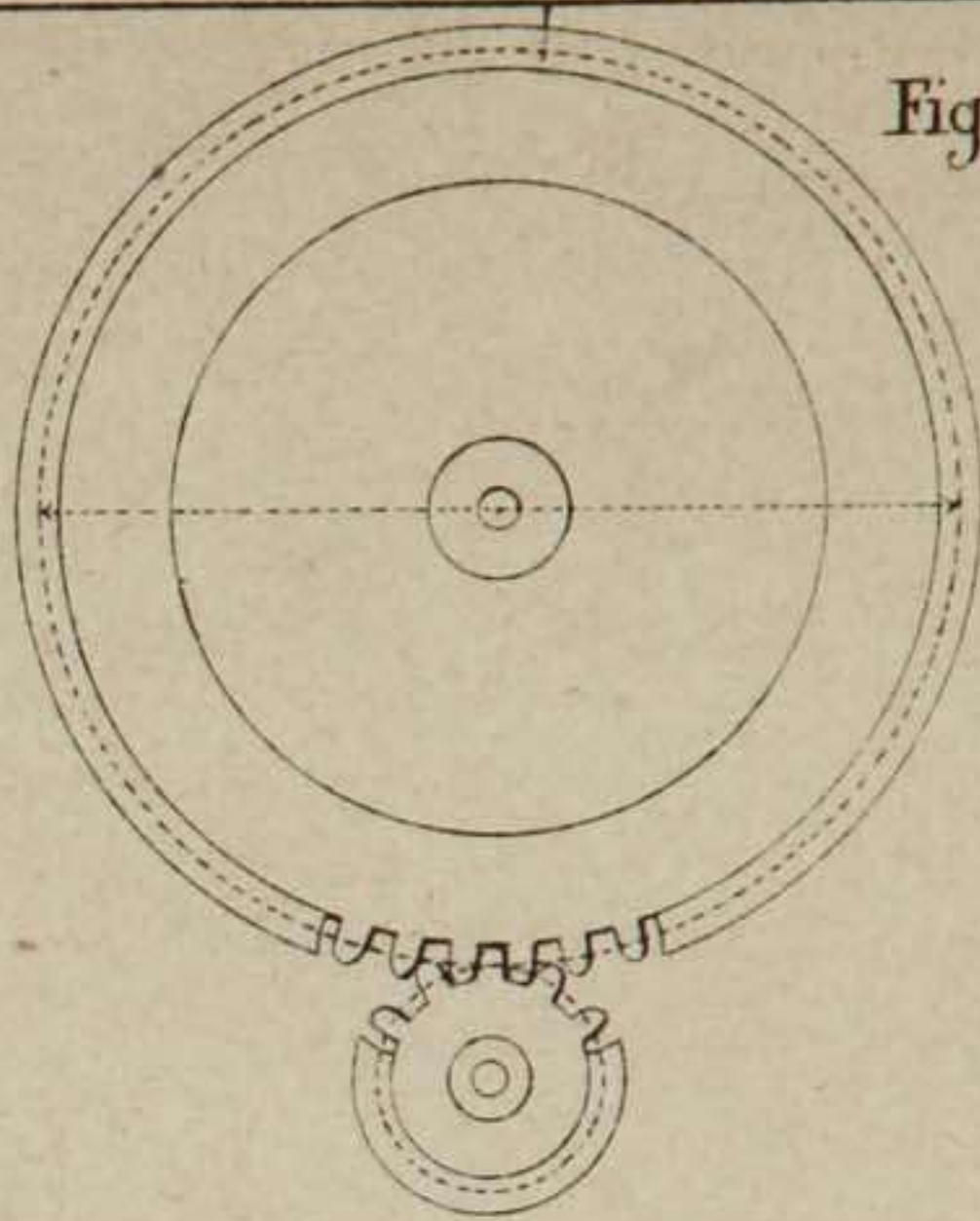


Fig. 216.

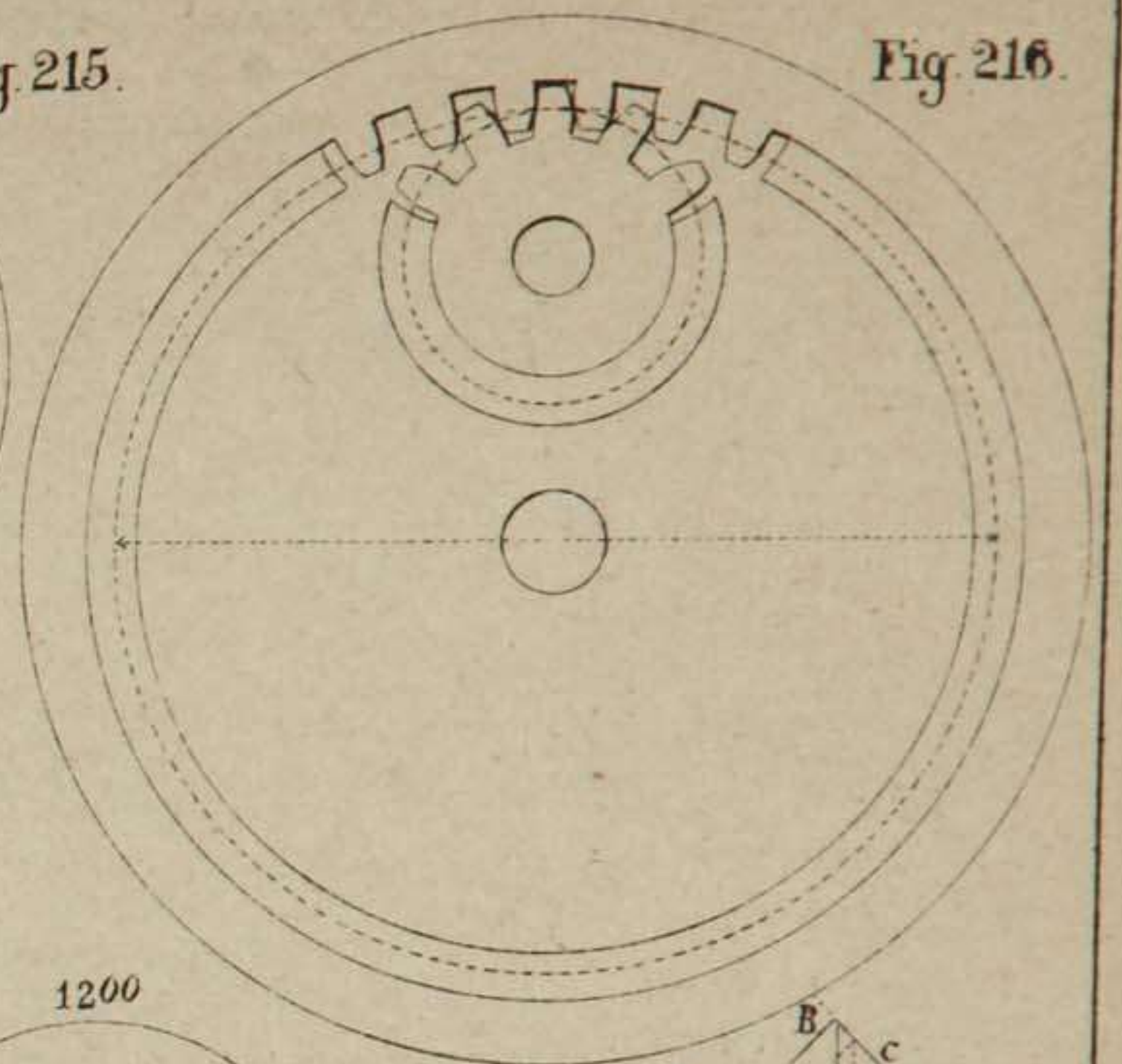


Fig. 214.

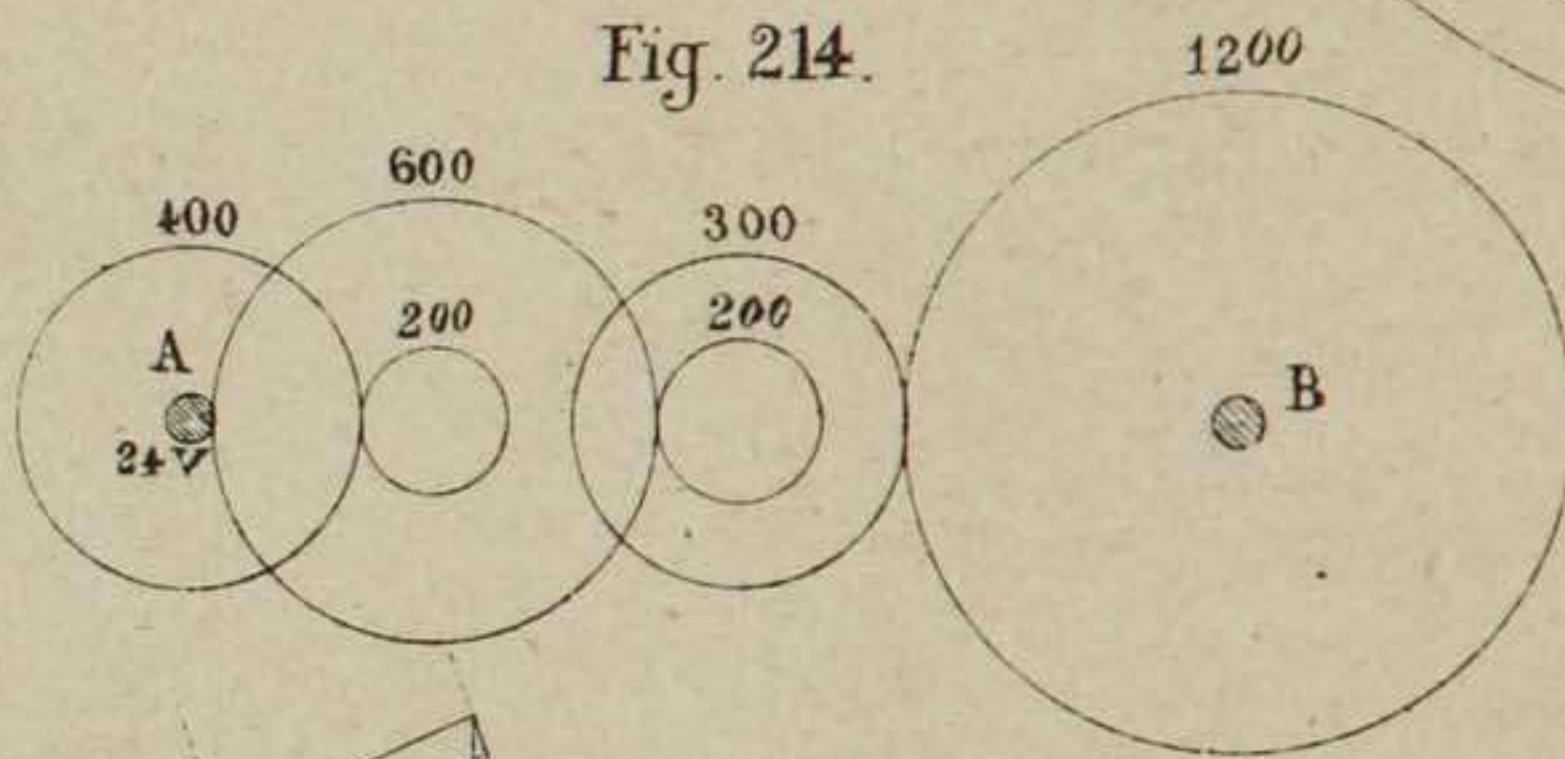


Fig. 219.

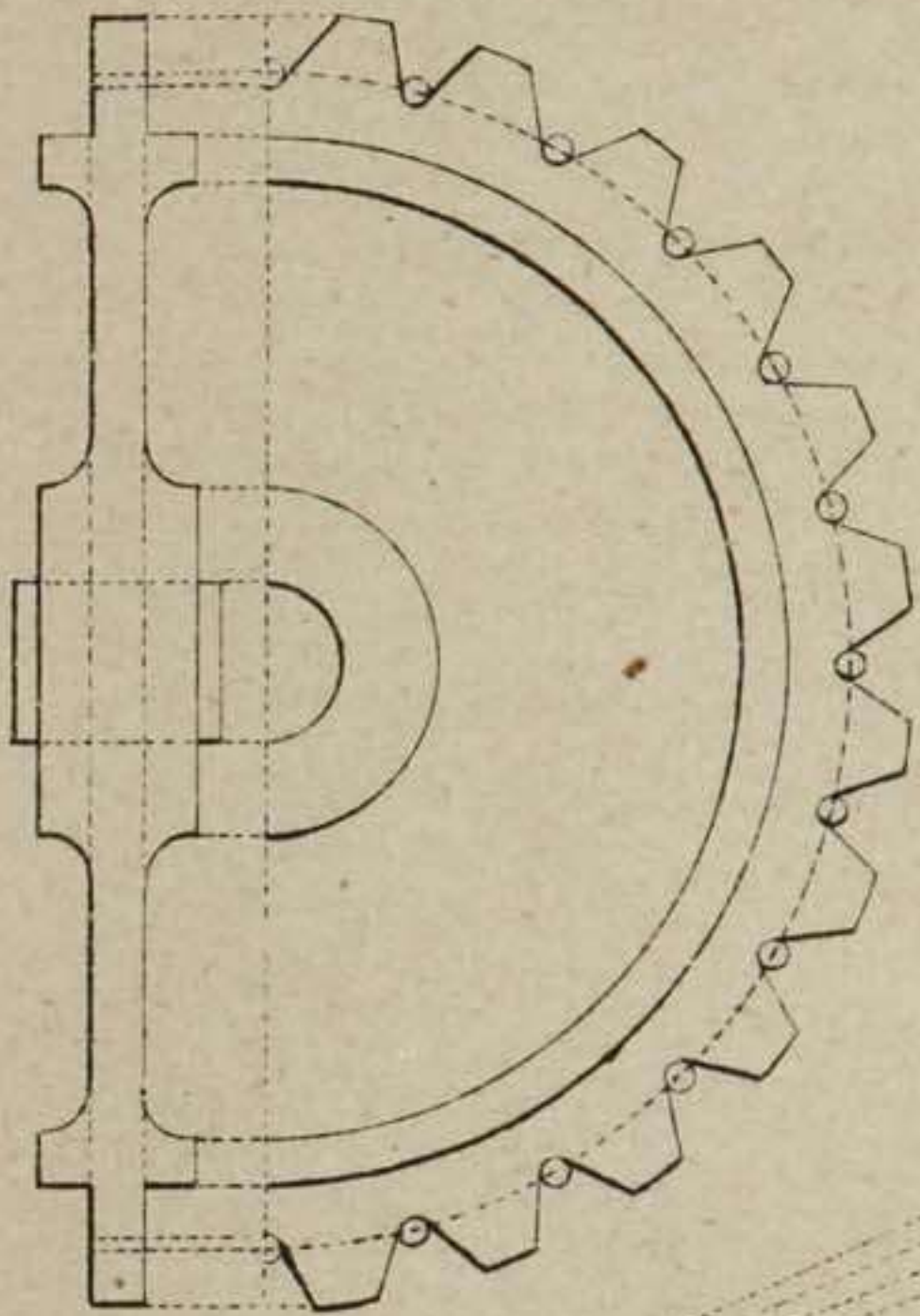


Fig. 220.

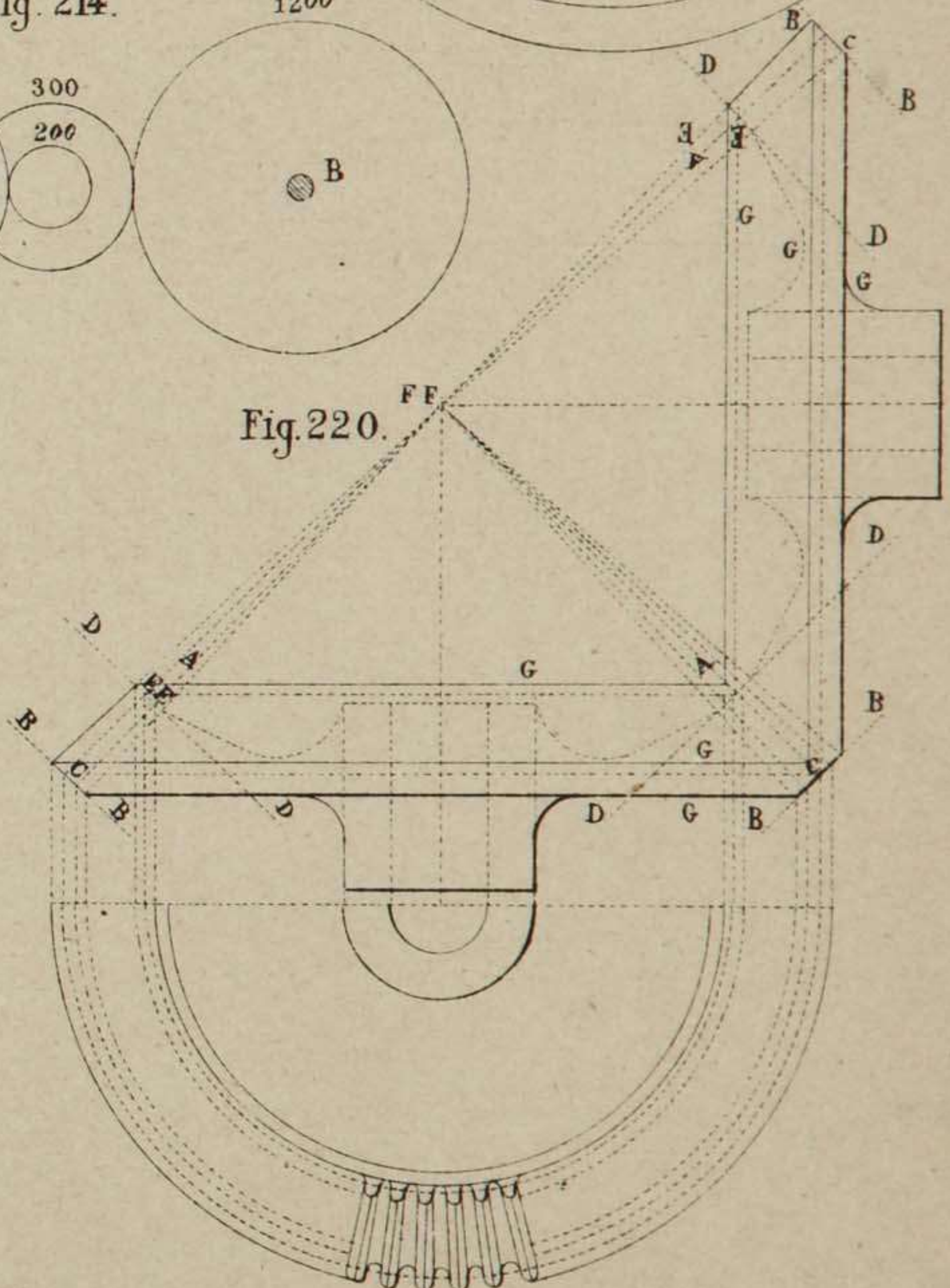


Fig. 222.

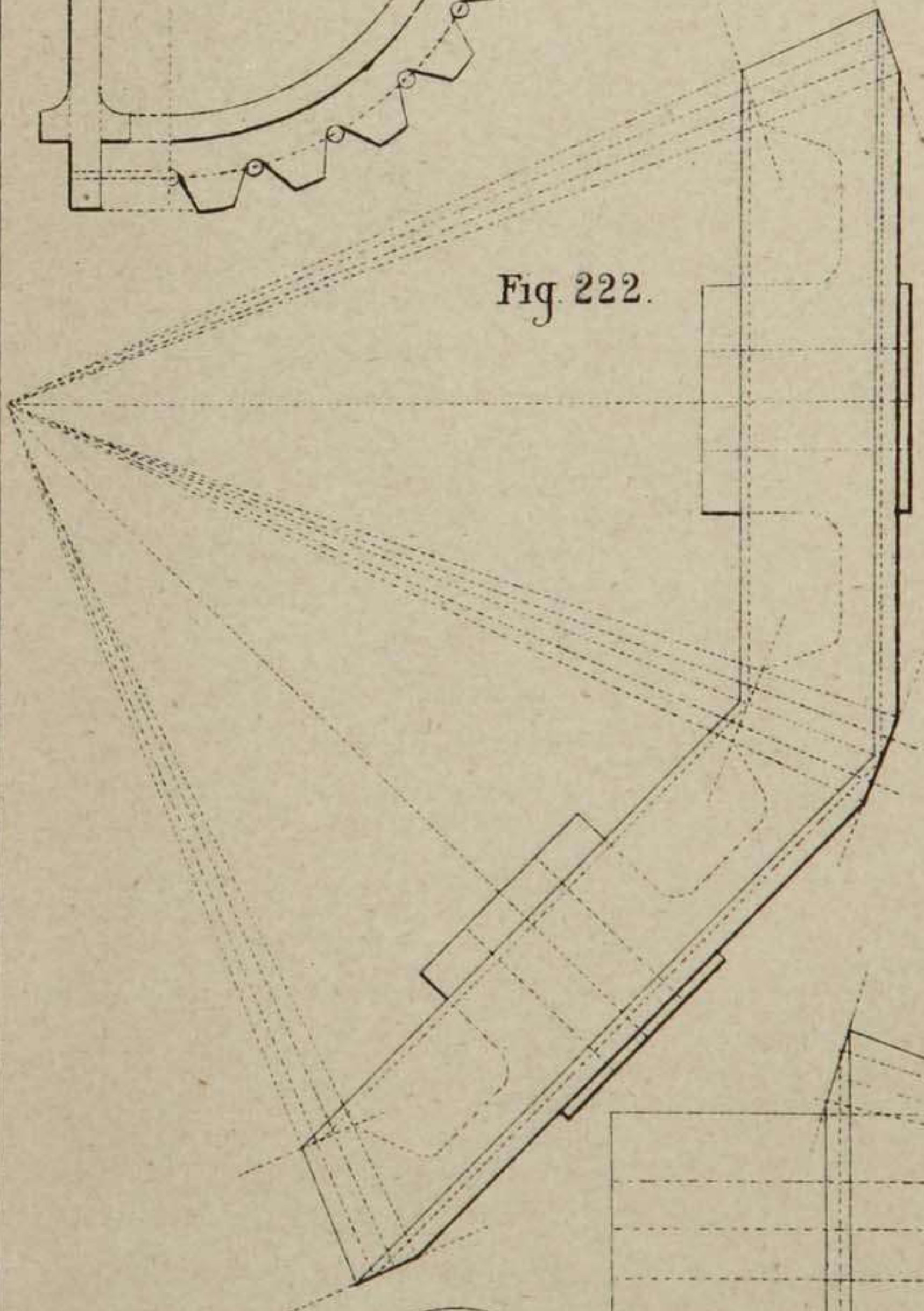


Fig. 221.

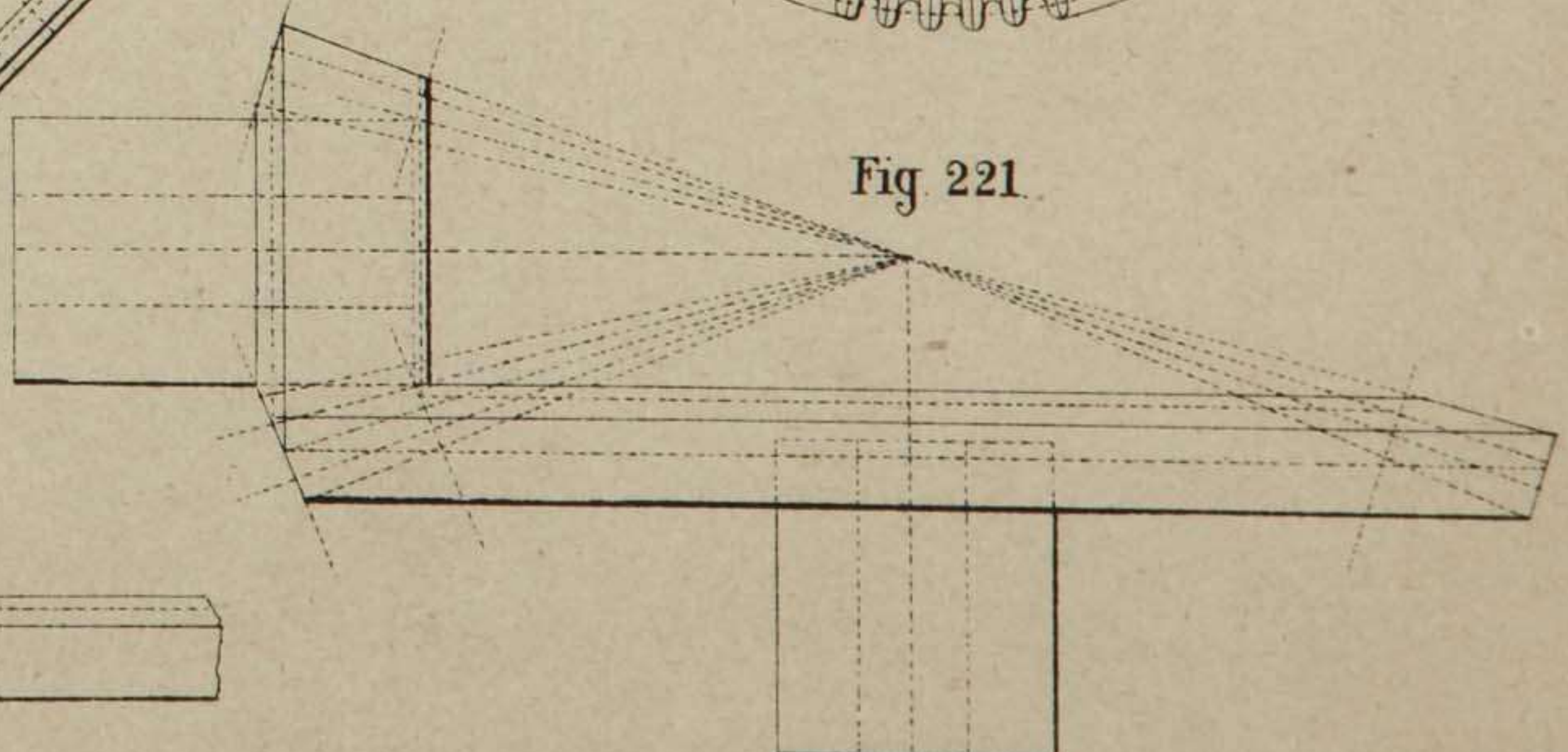
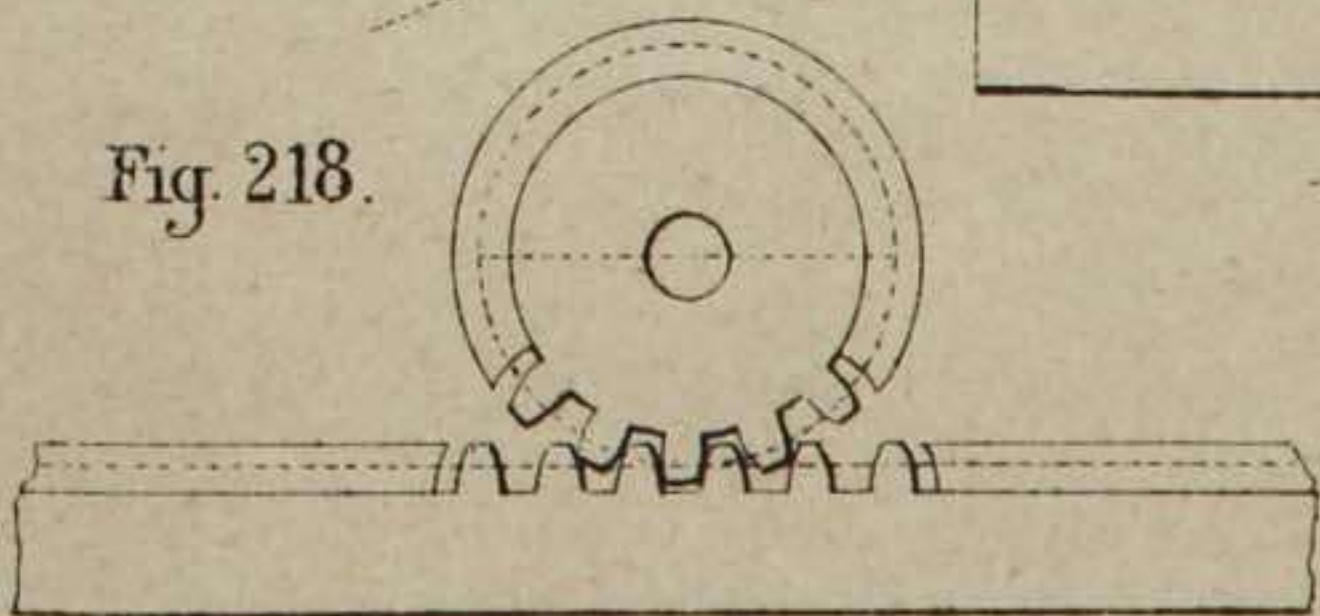
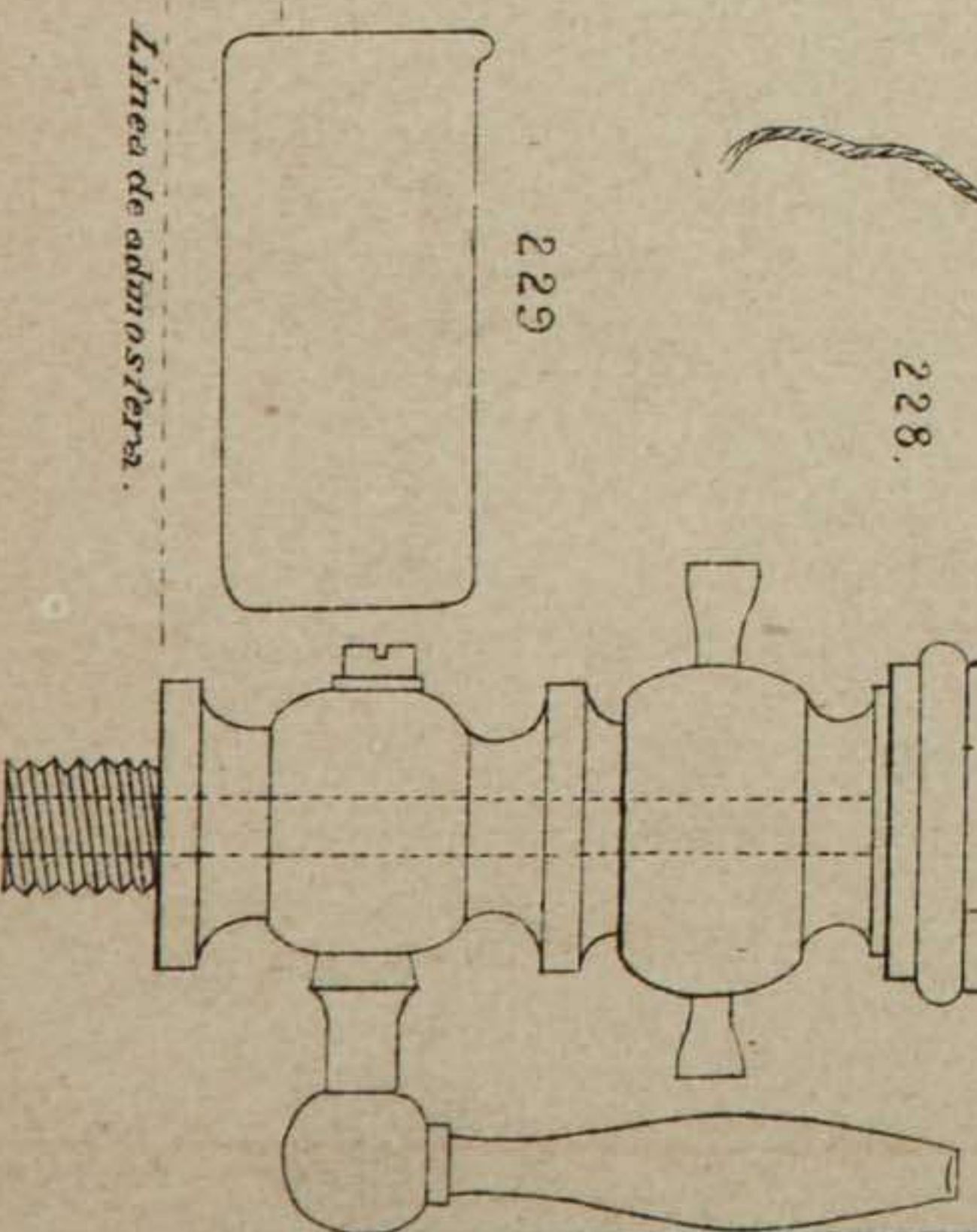
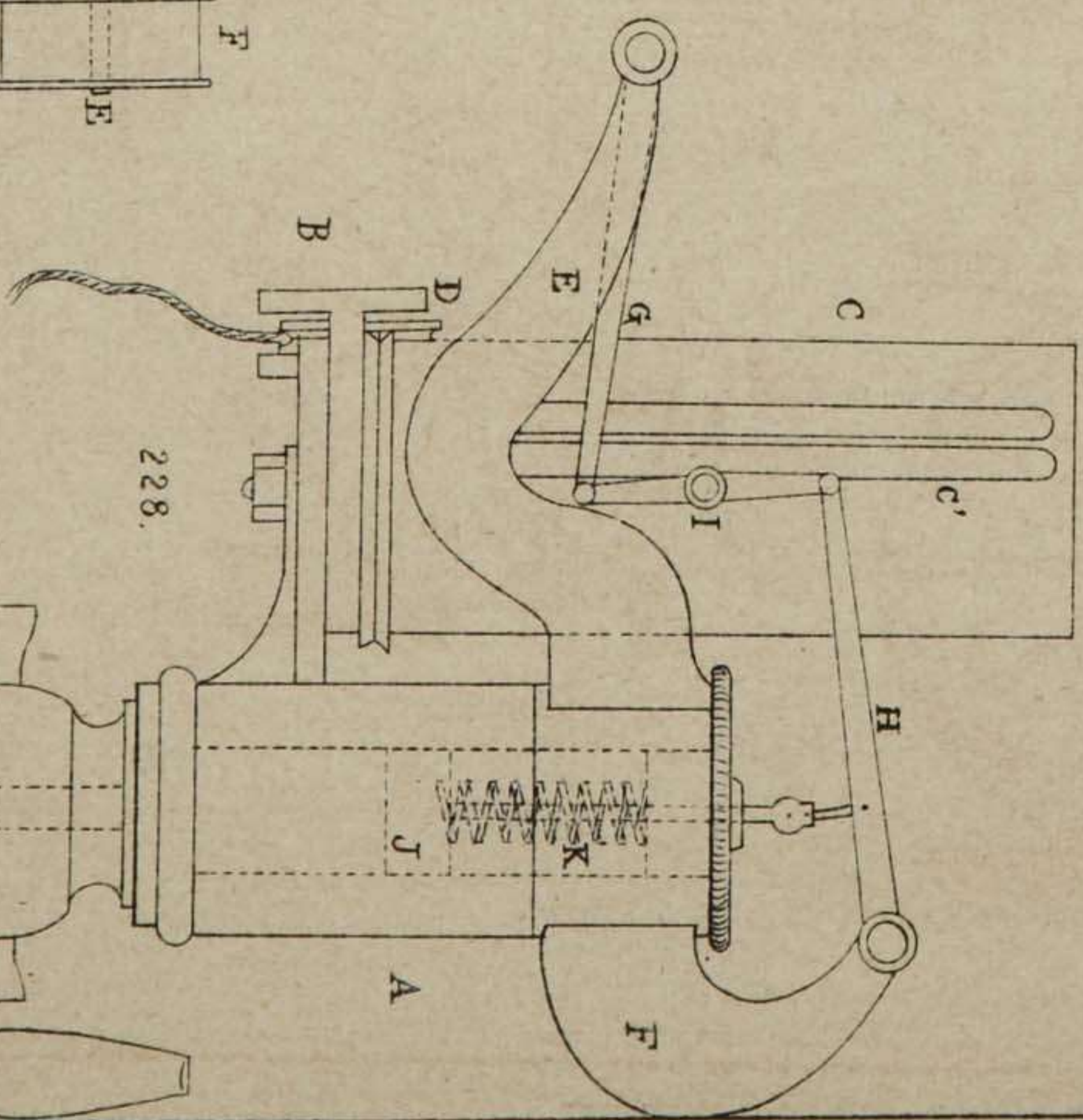
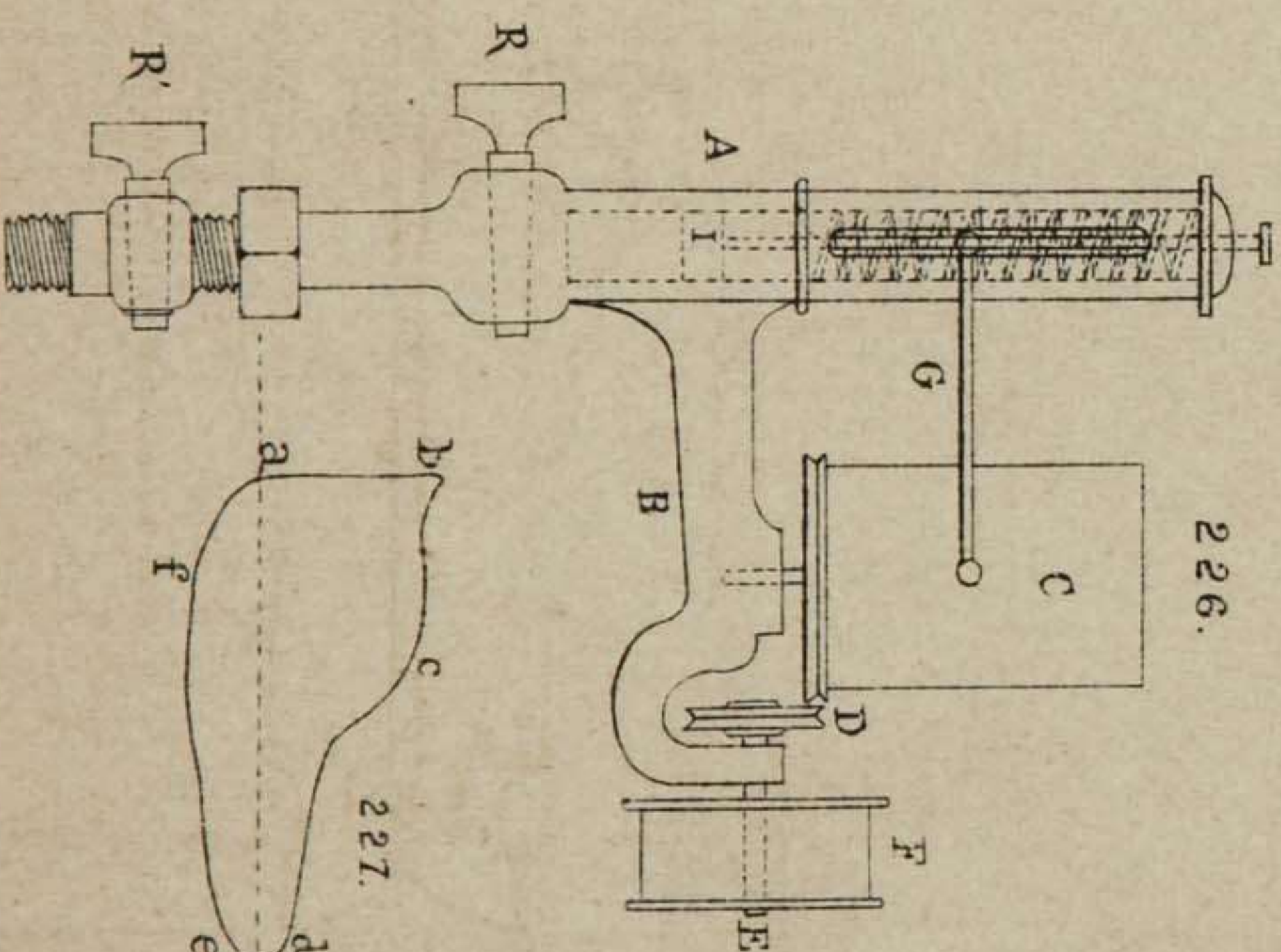
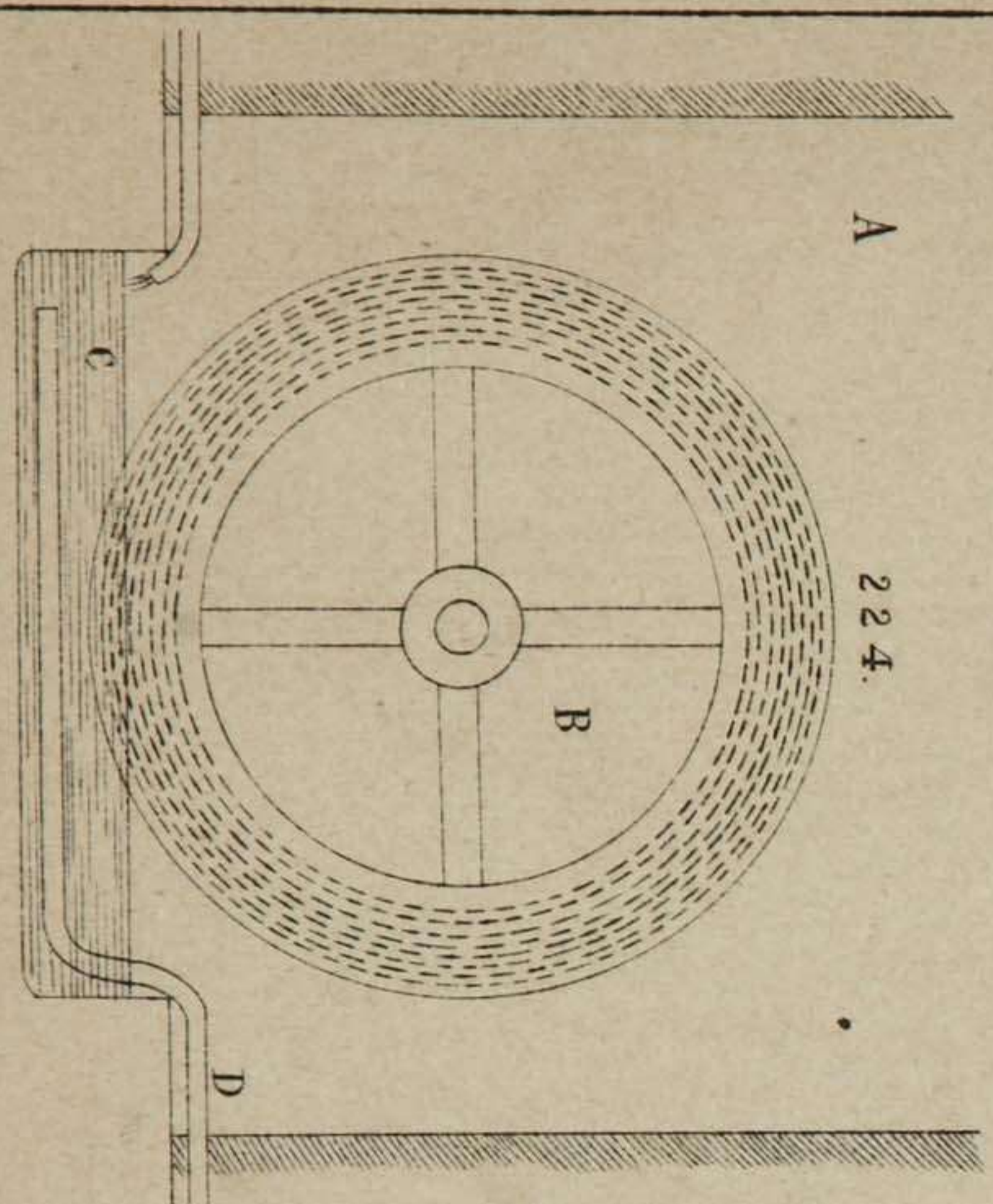
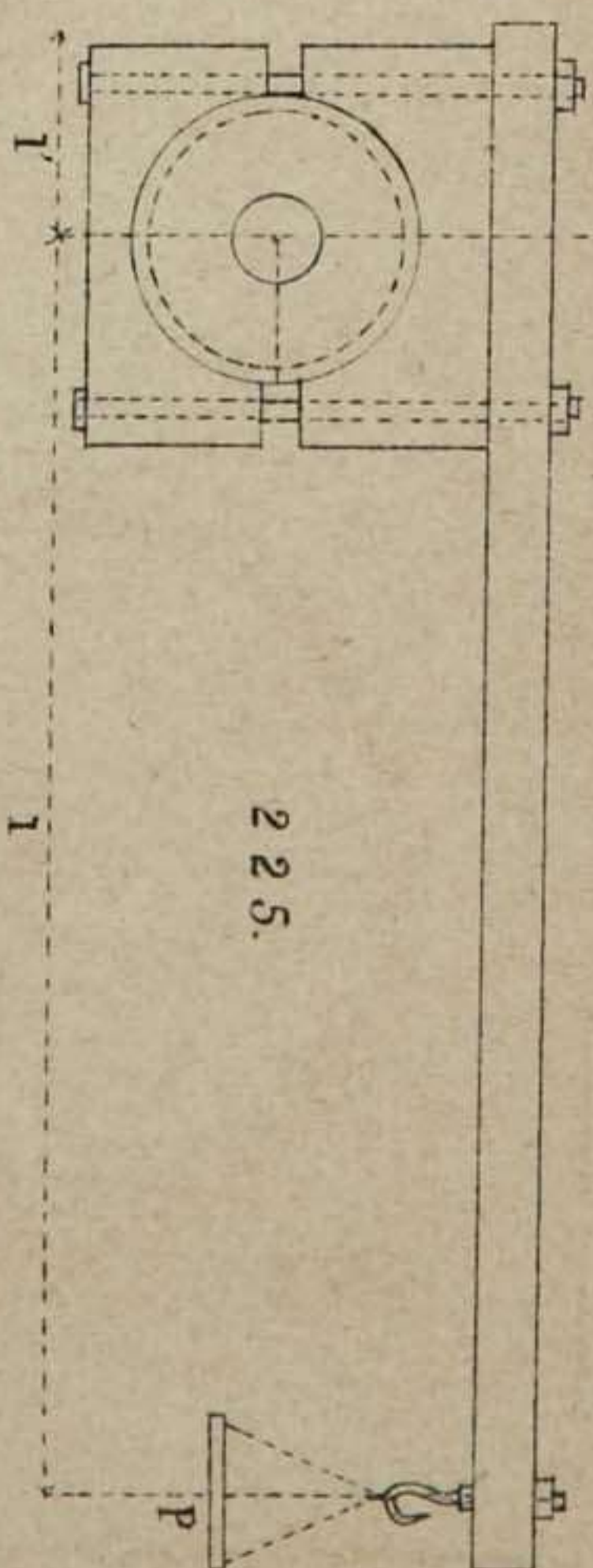
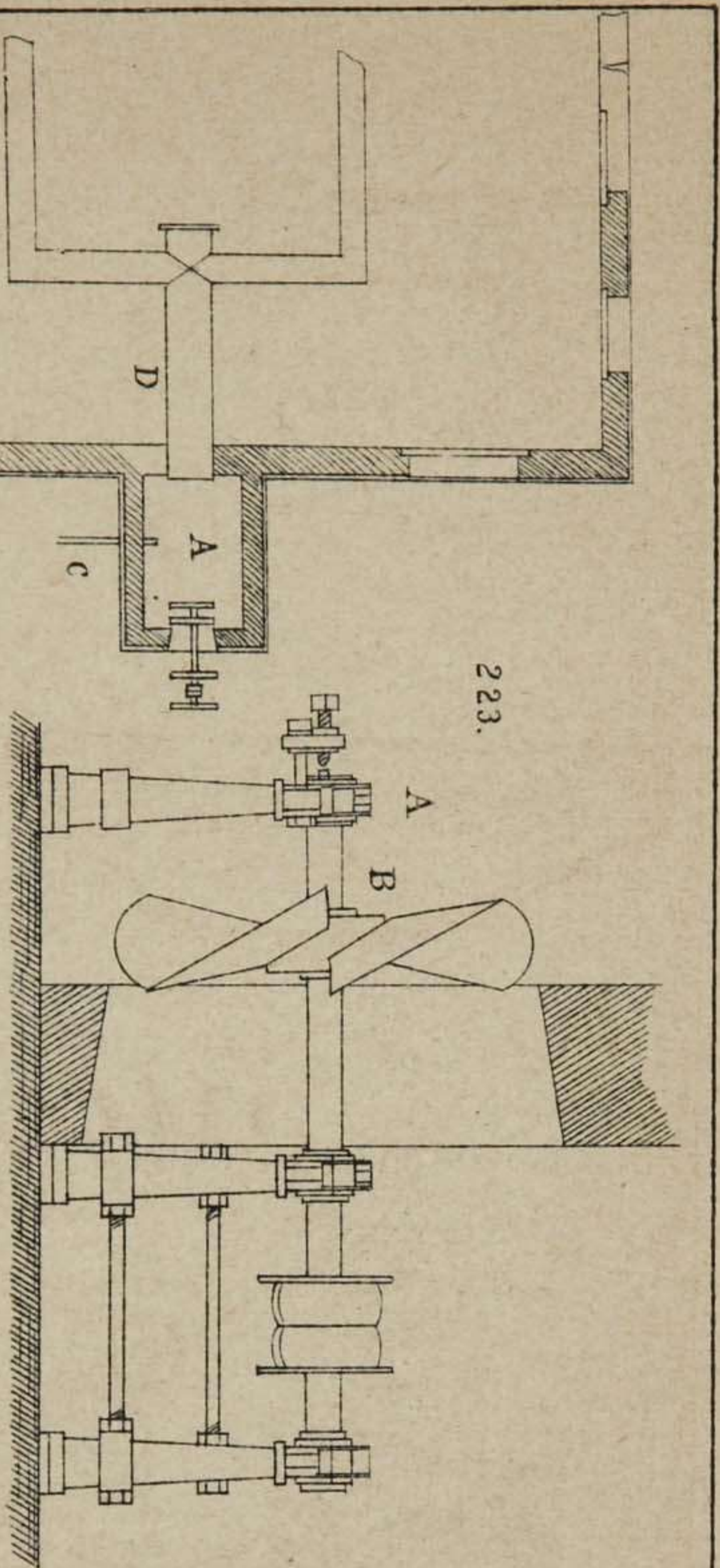
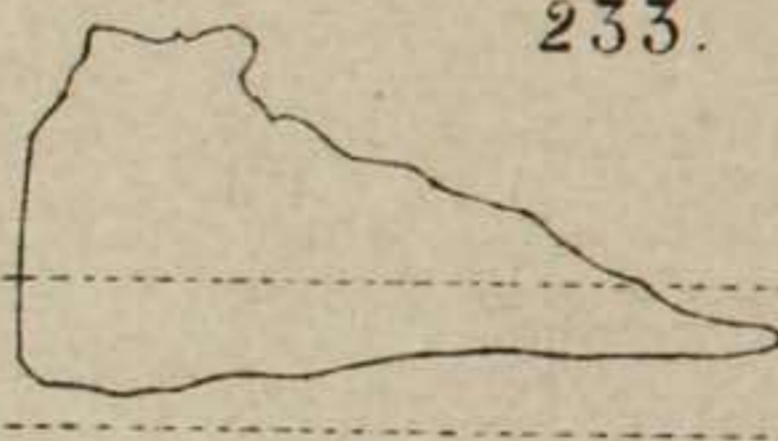
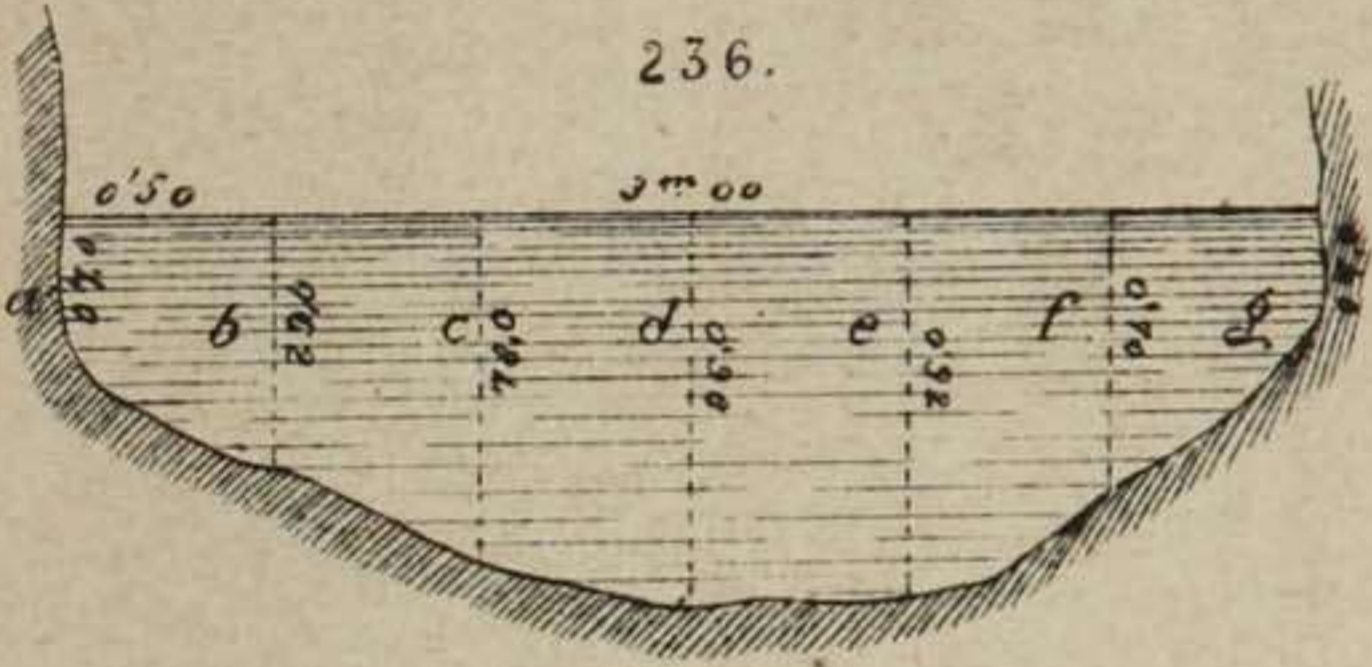
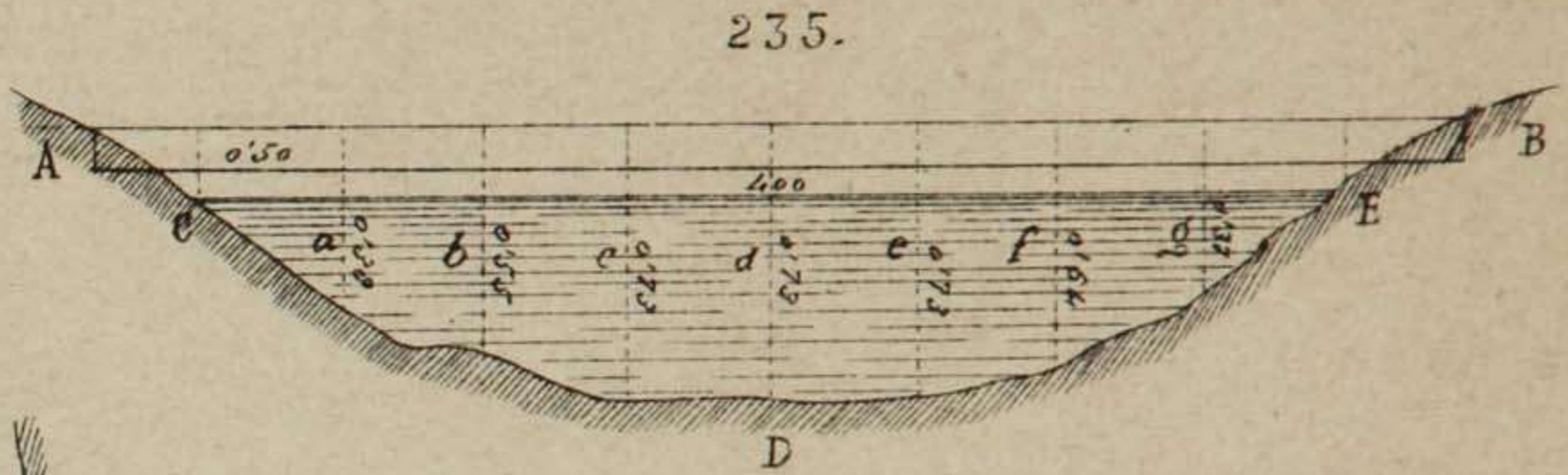
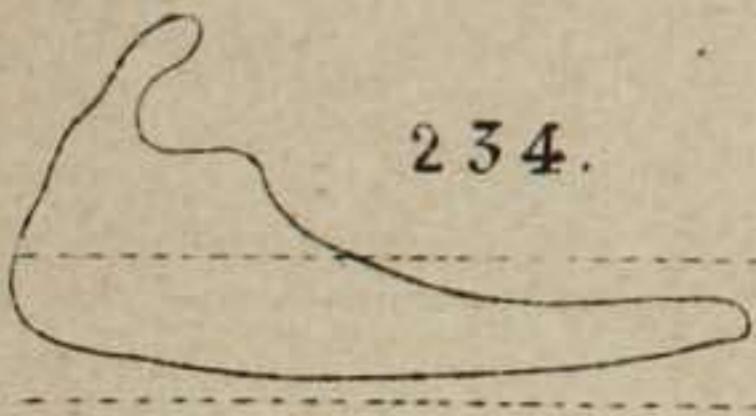
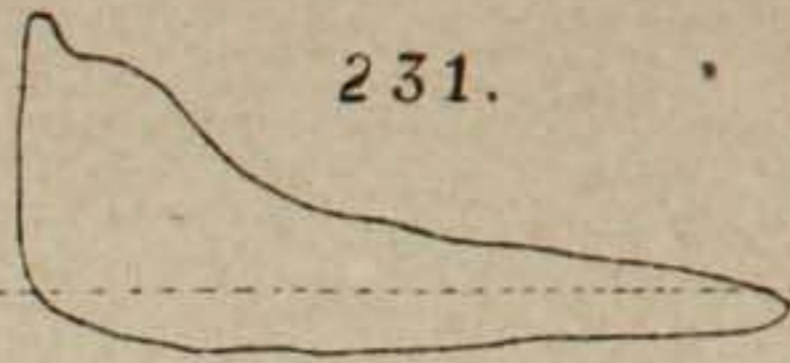
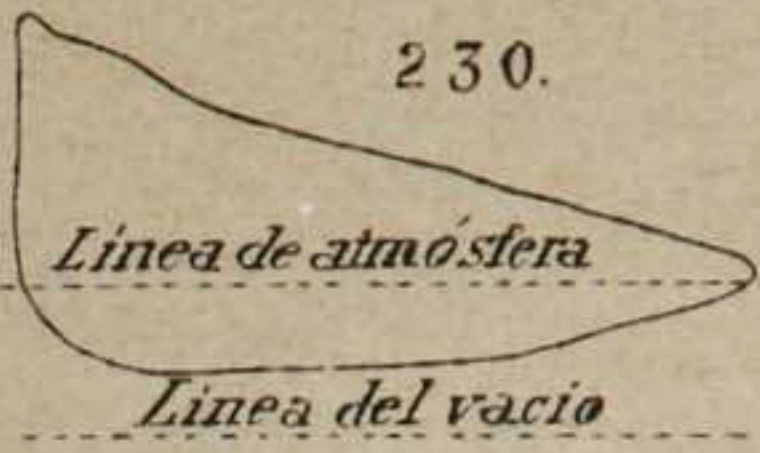


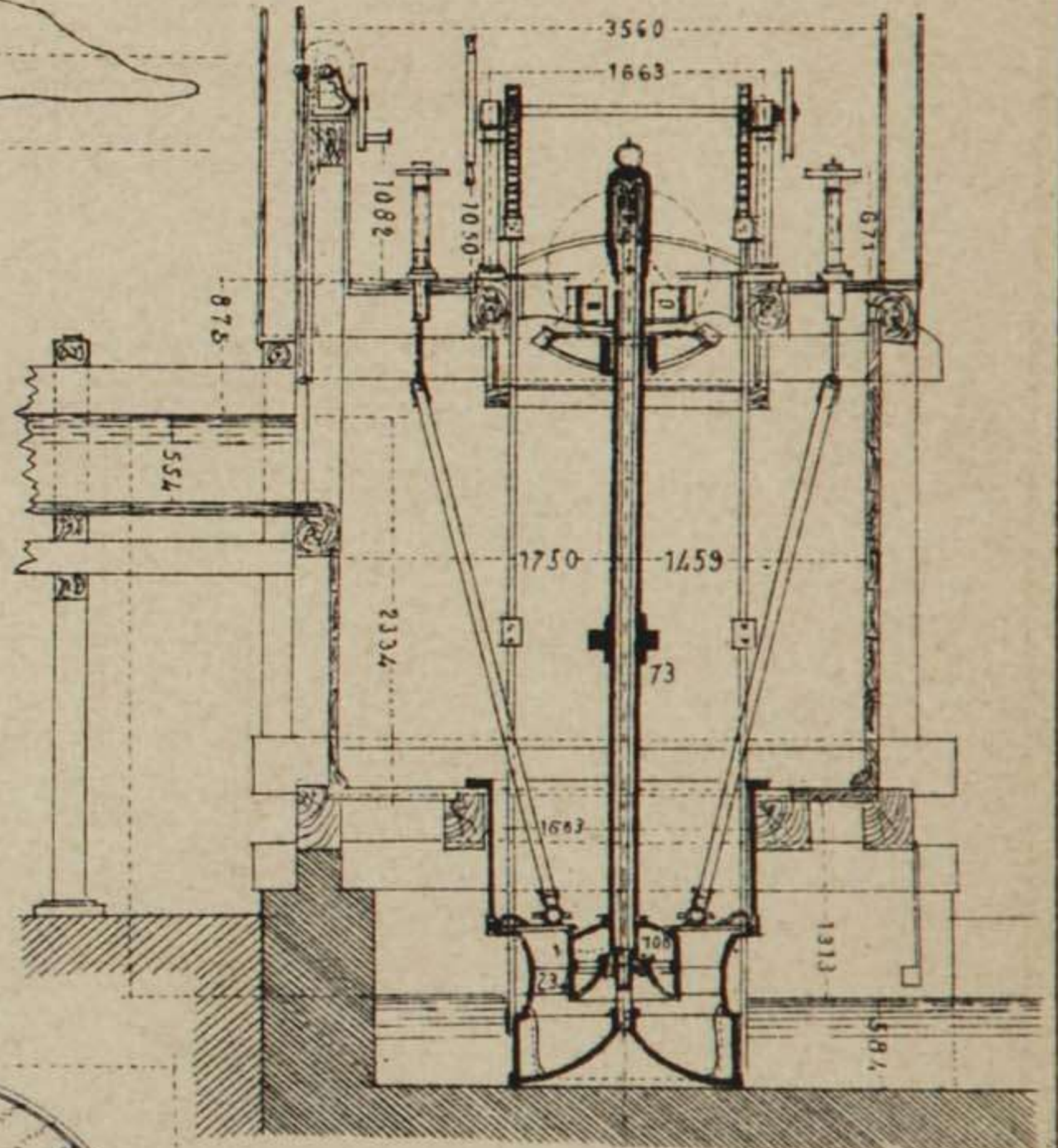
Fig. 218.



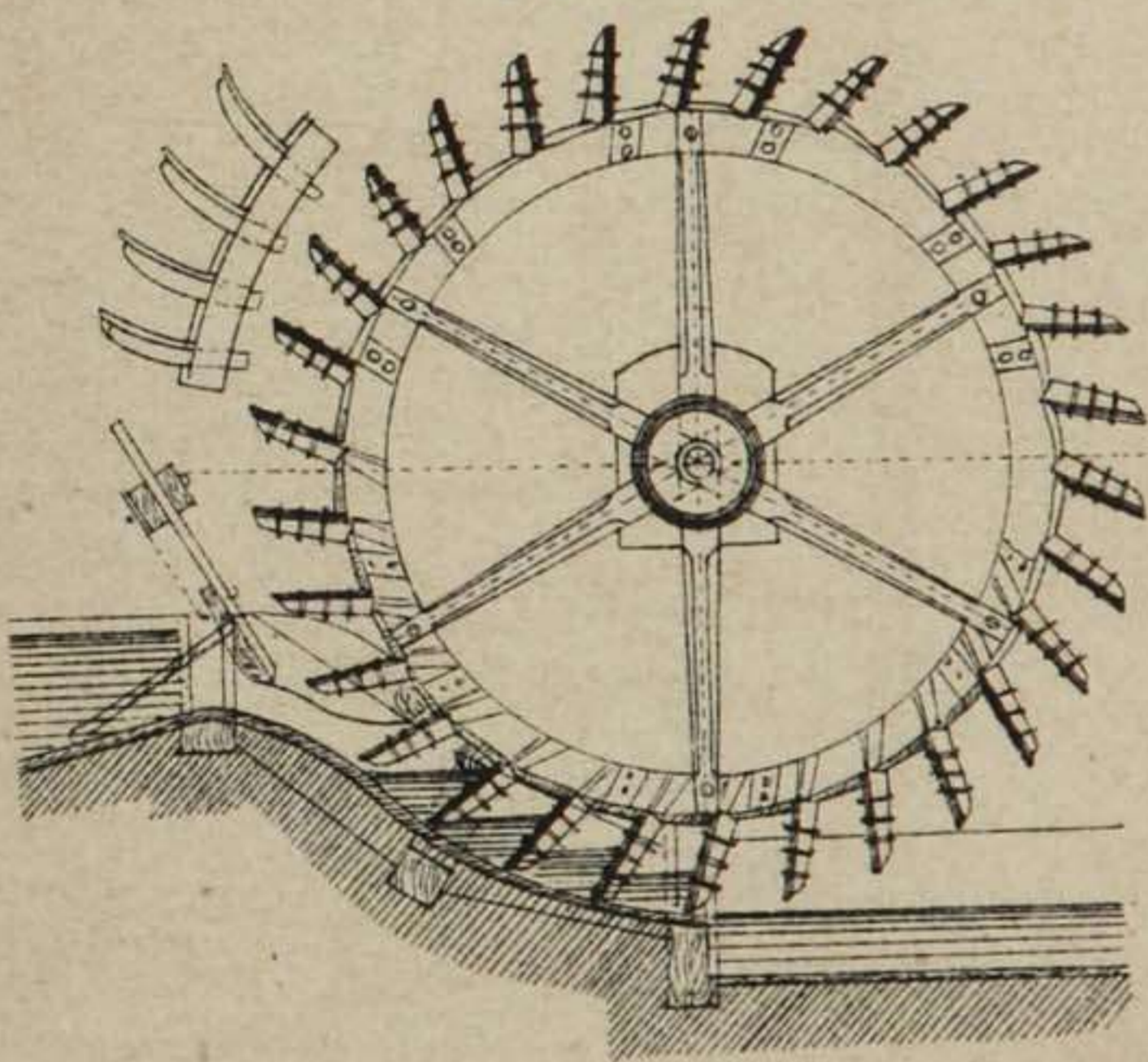




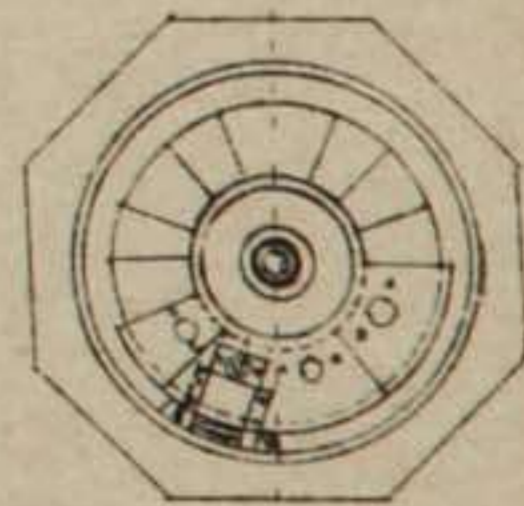
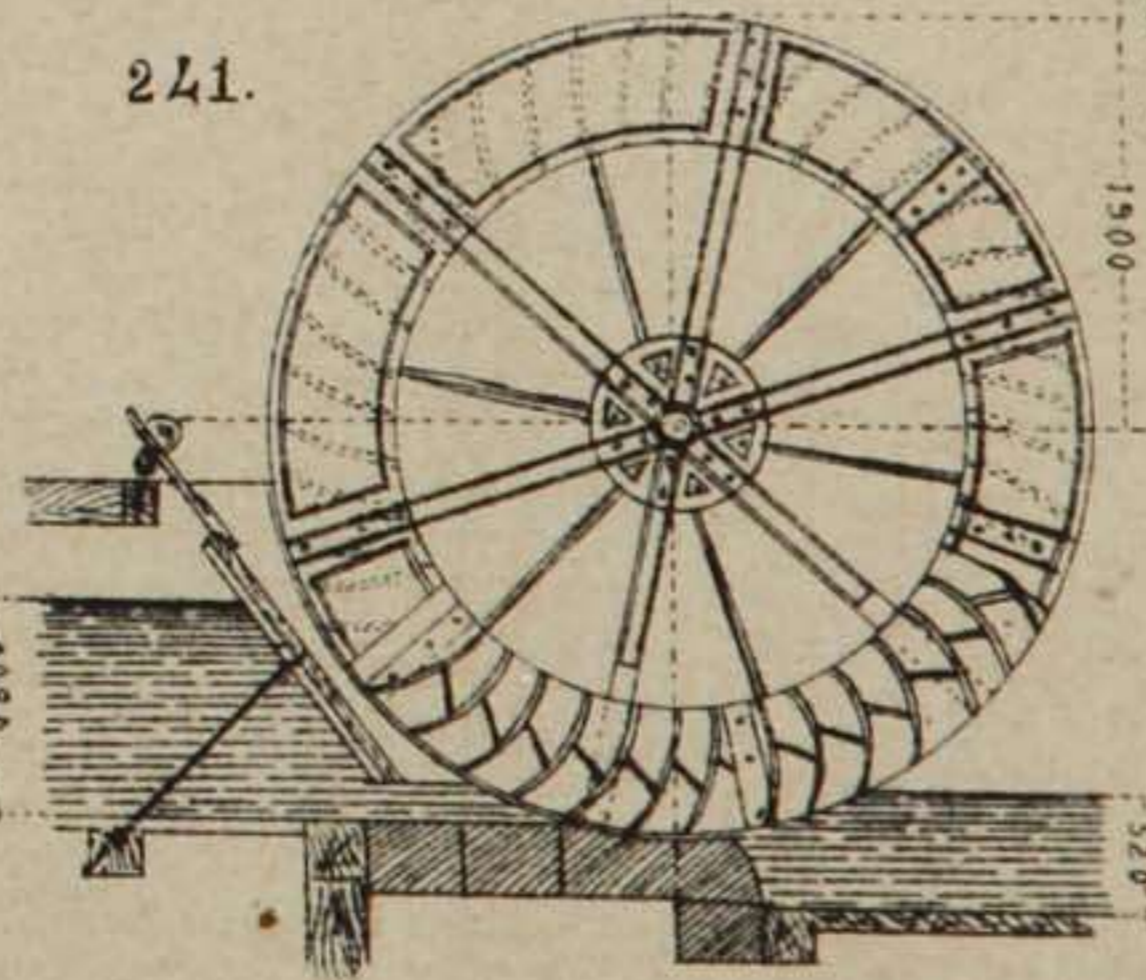
242.



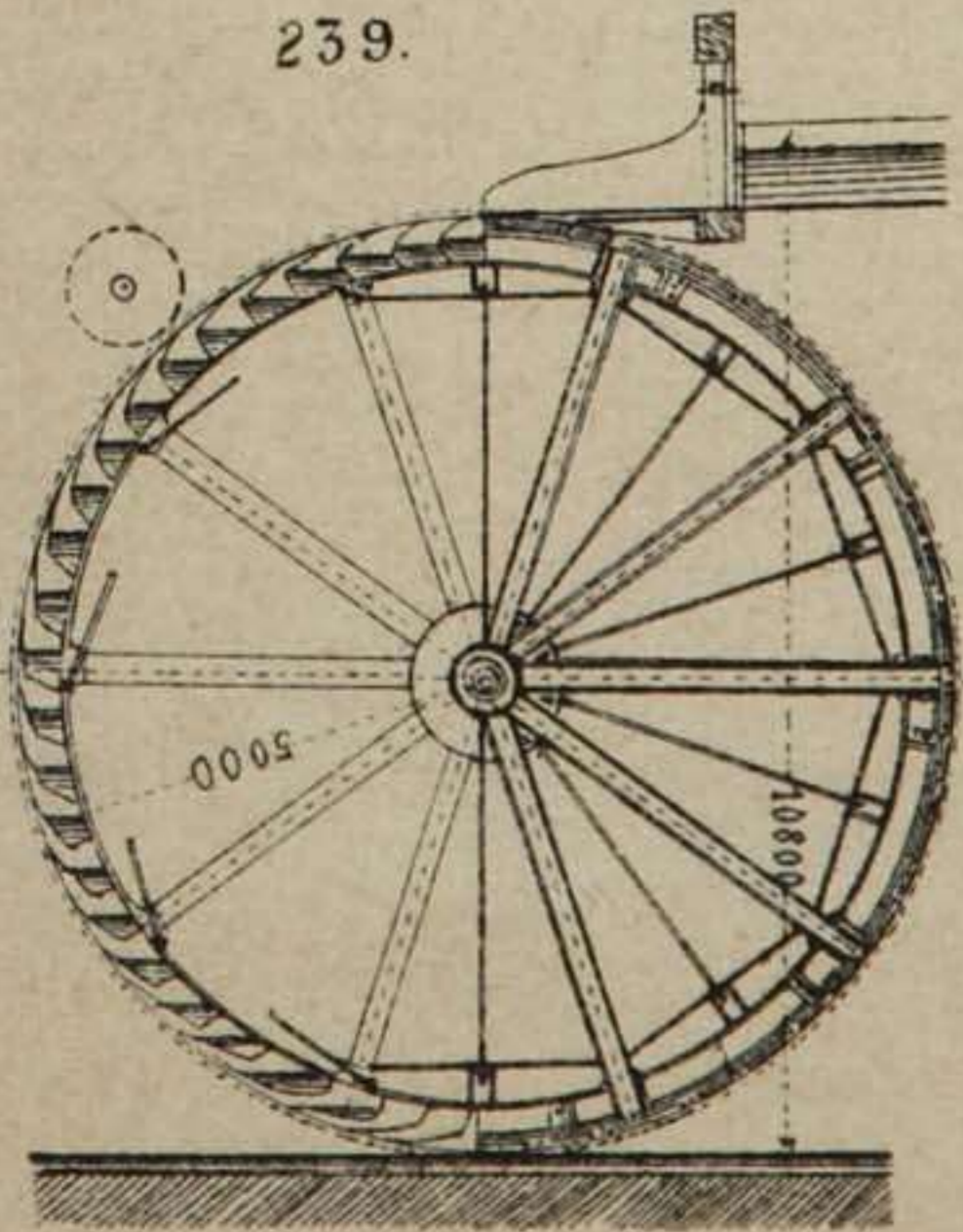
240.



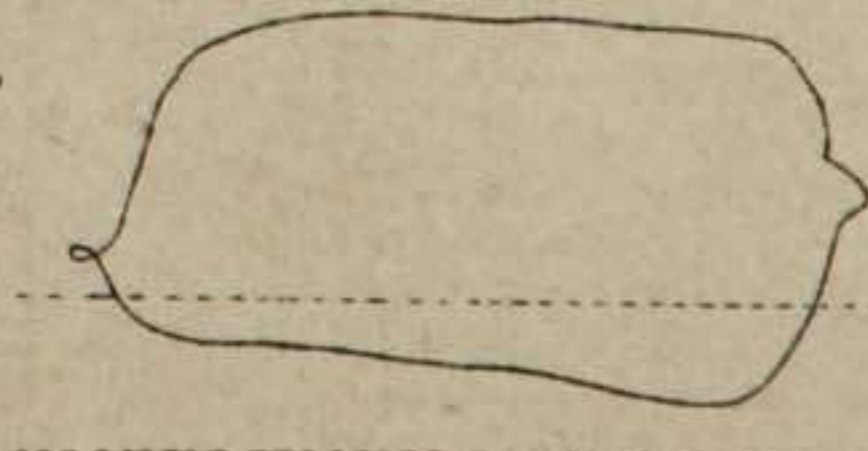
241.



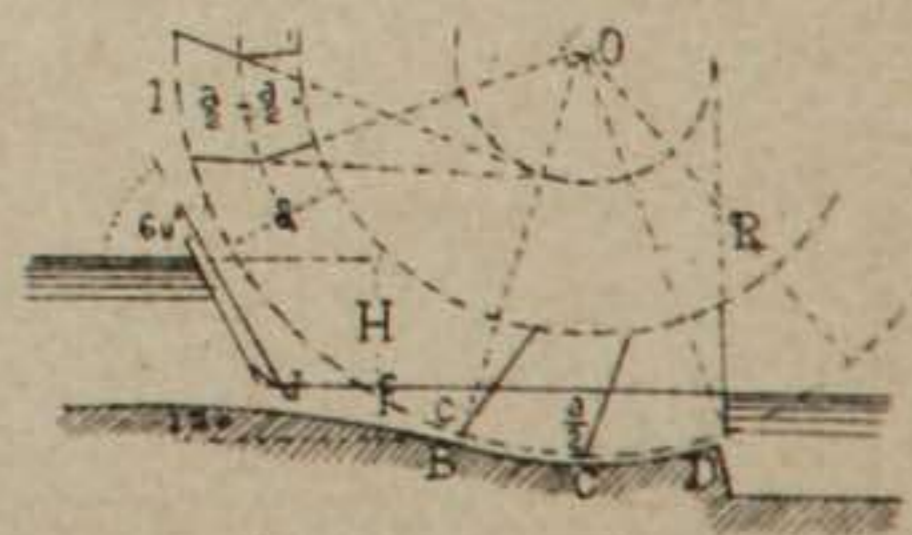
239.

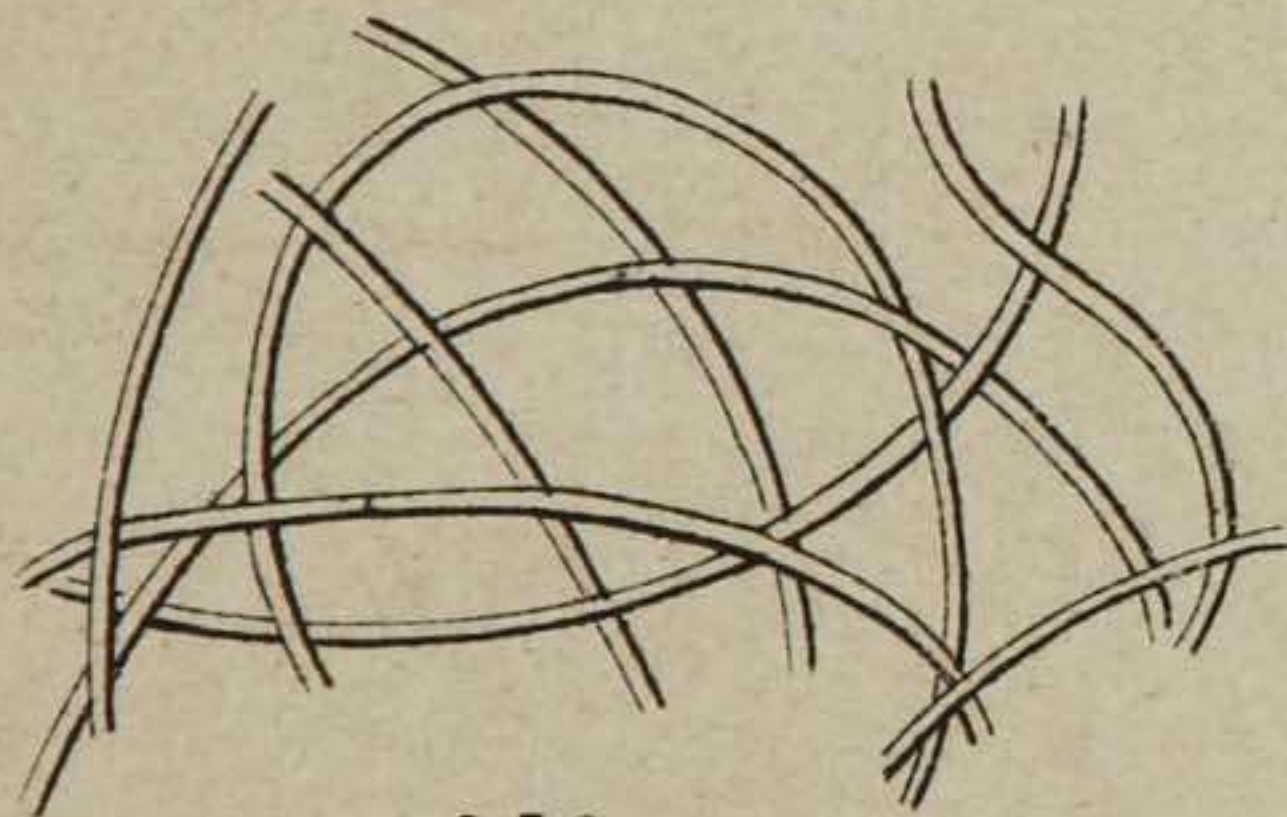
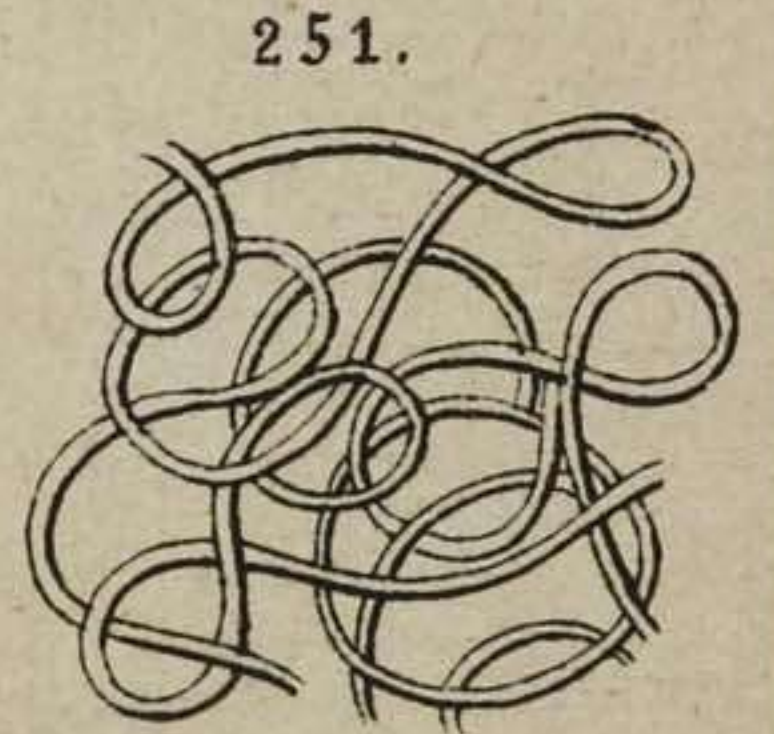
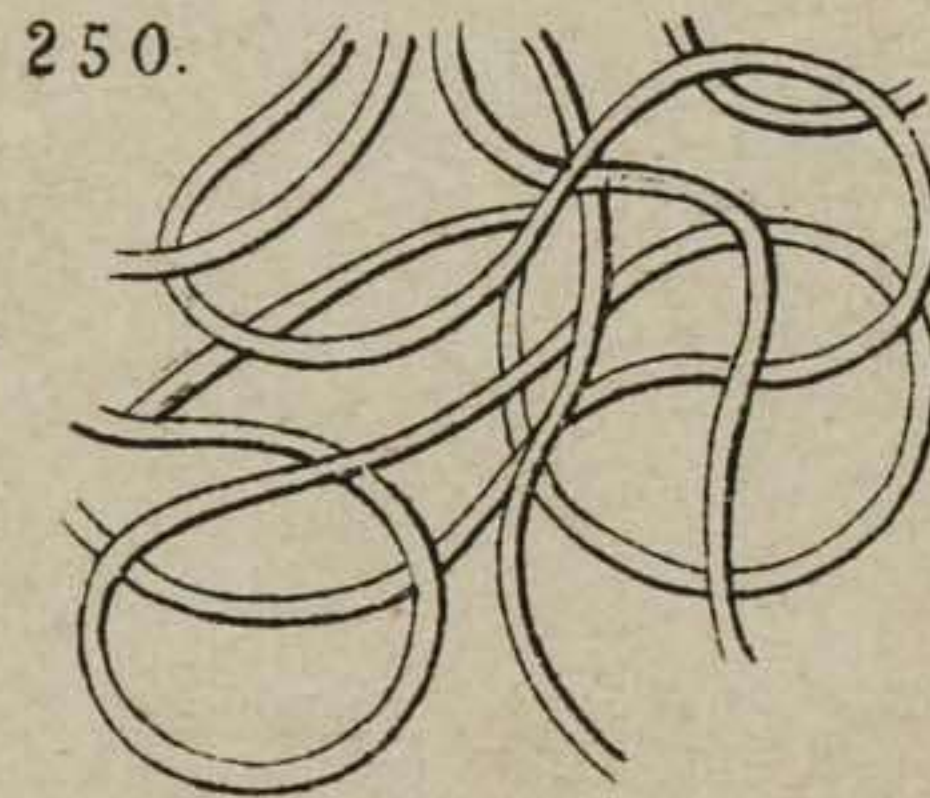
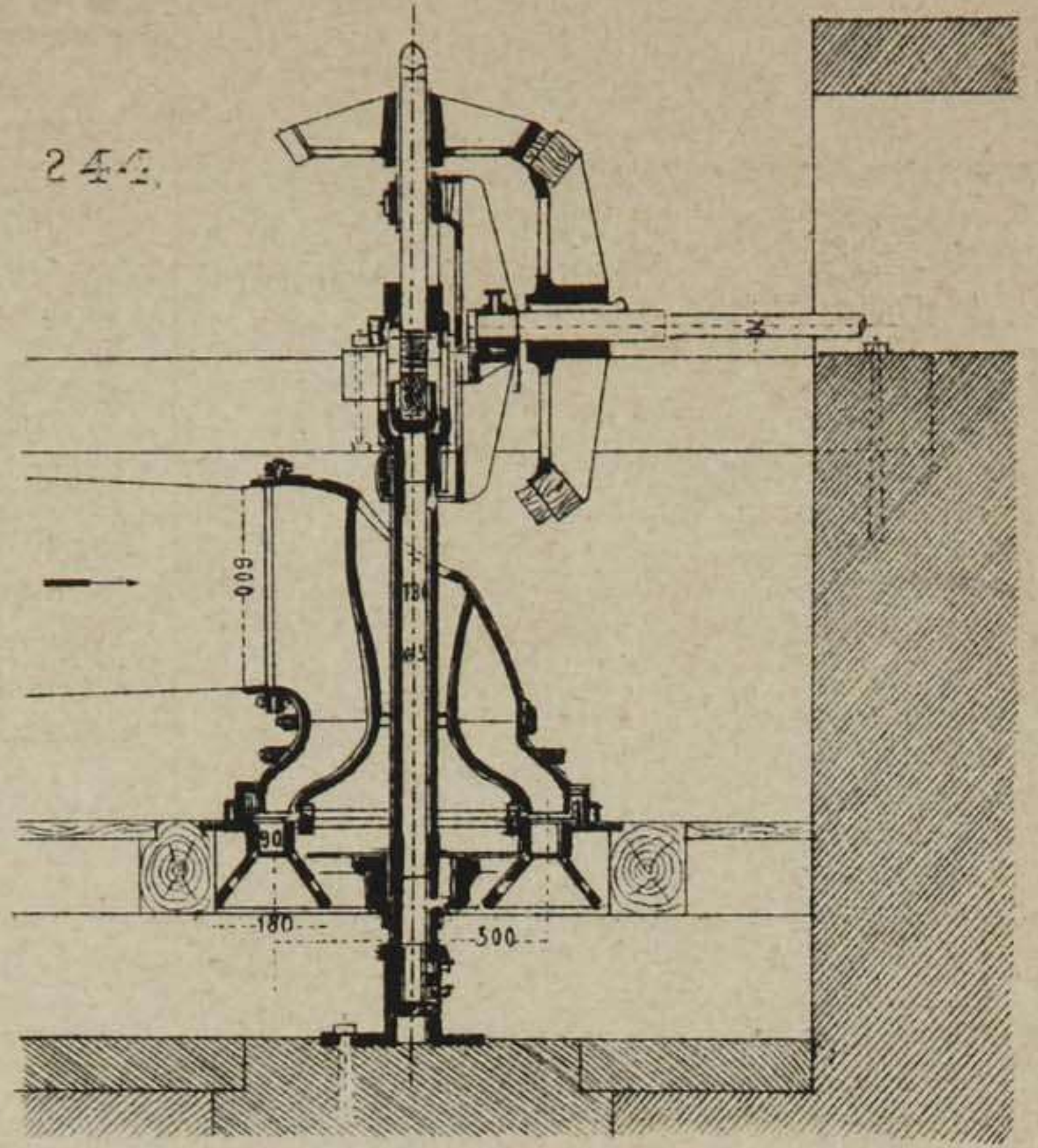
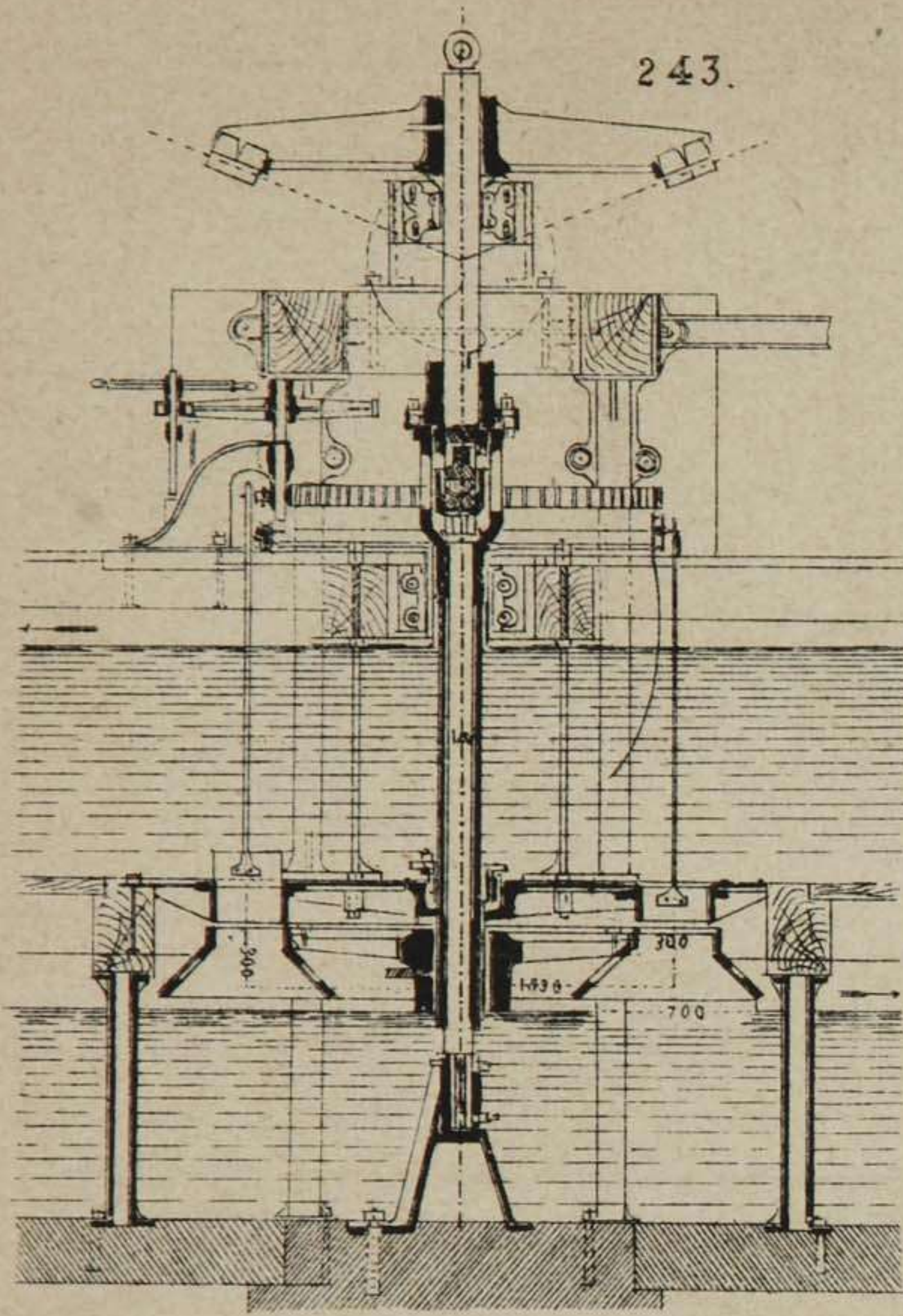


232.

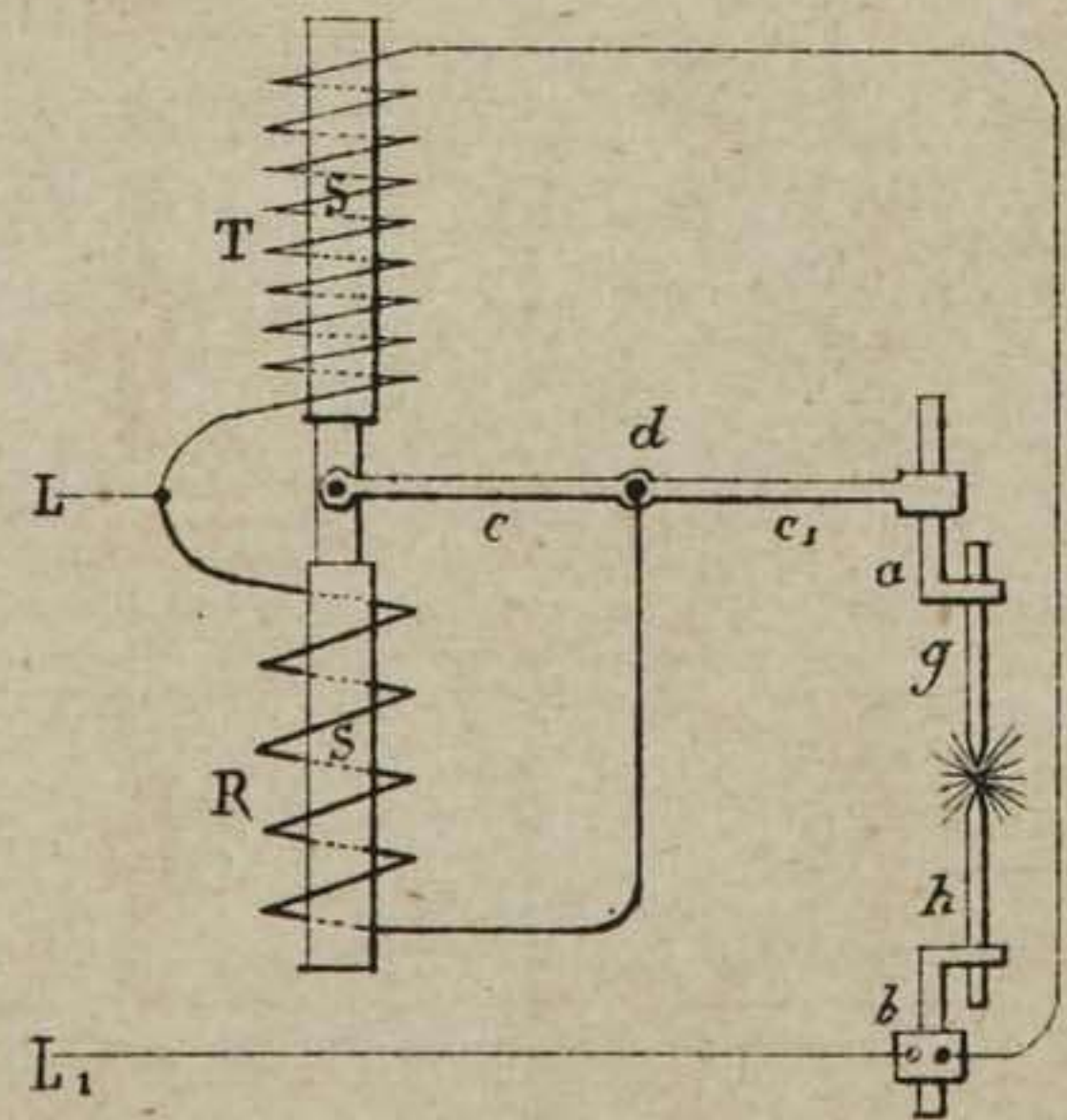


238.

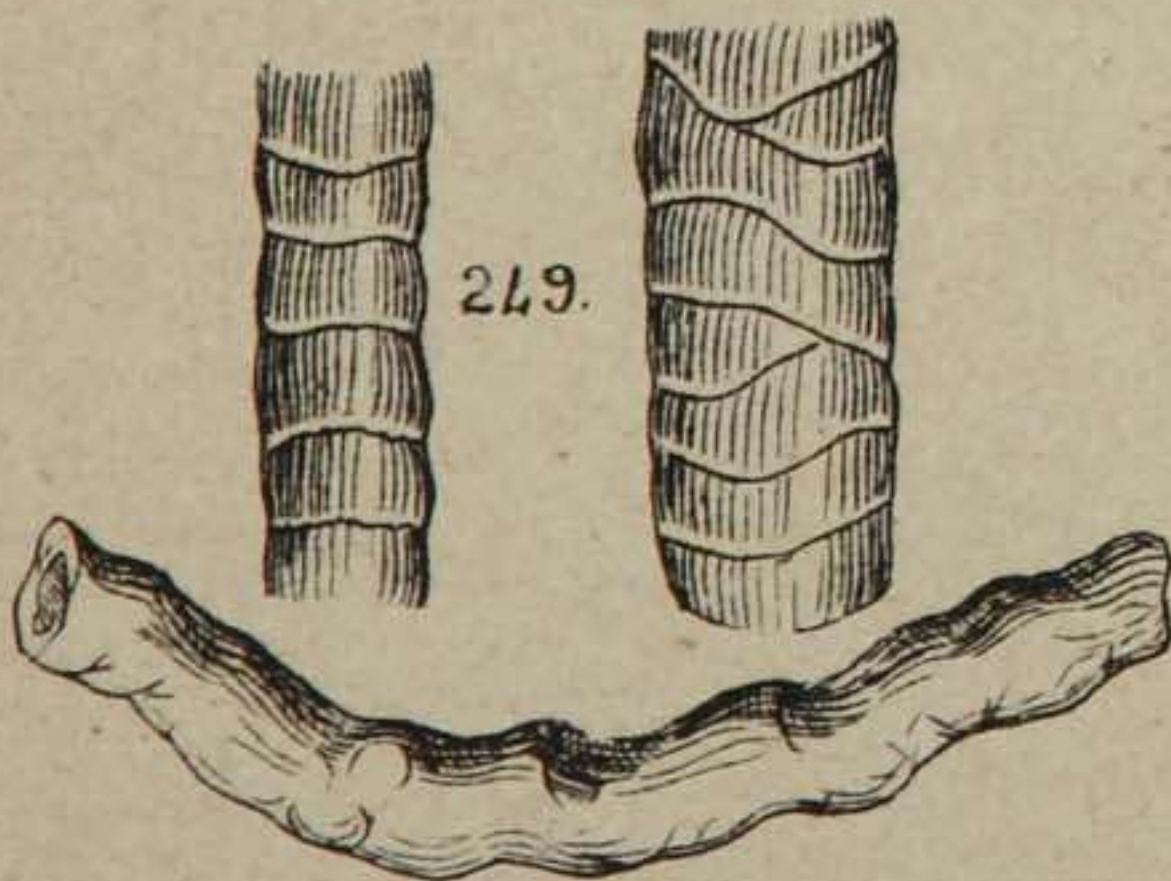
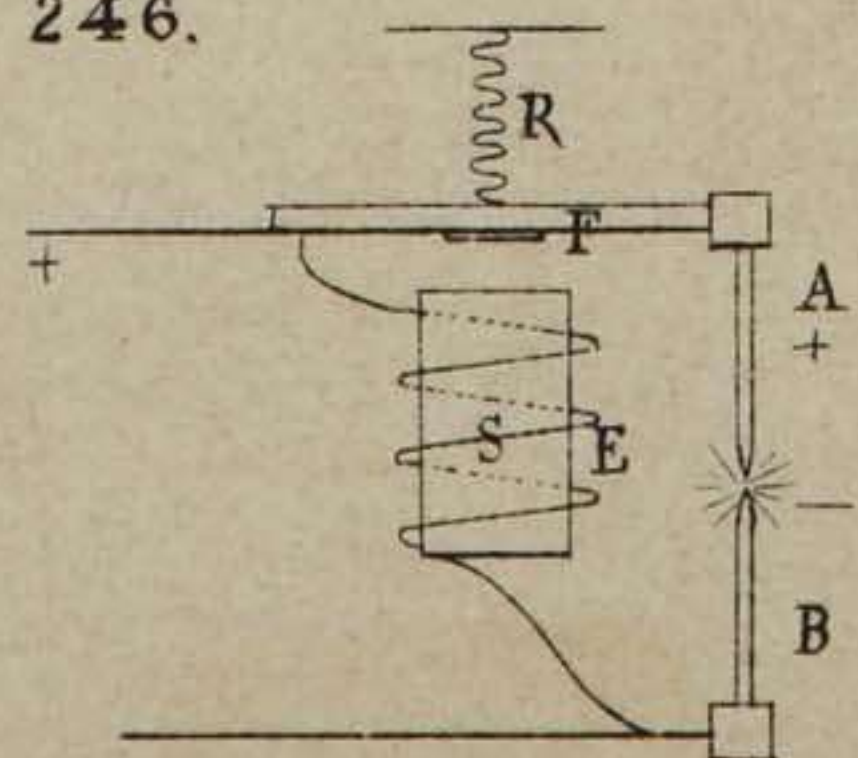


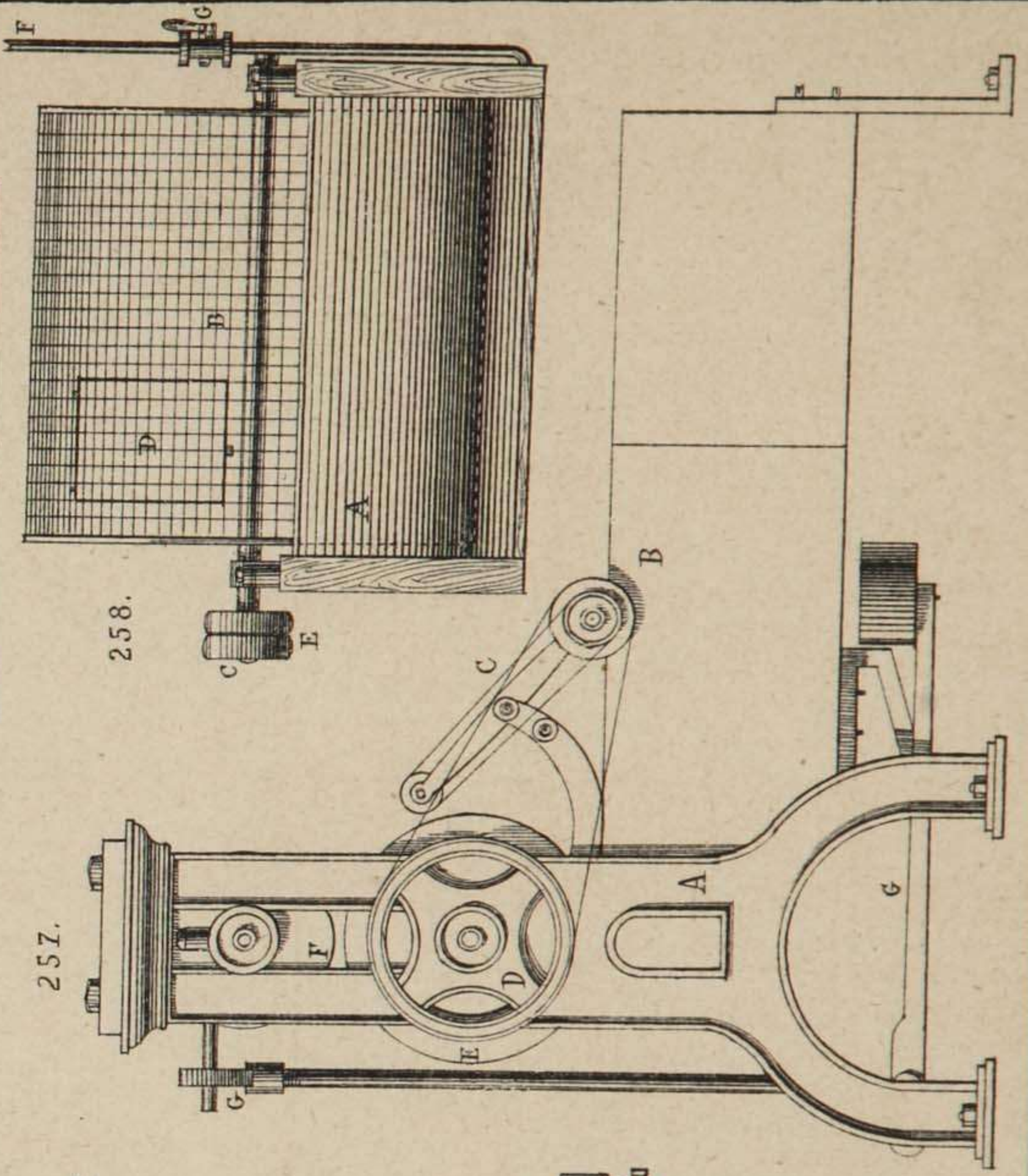
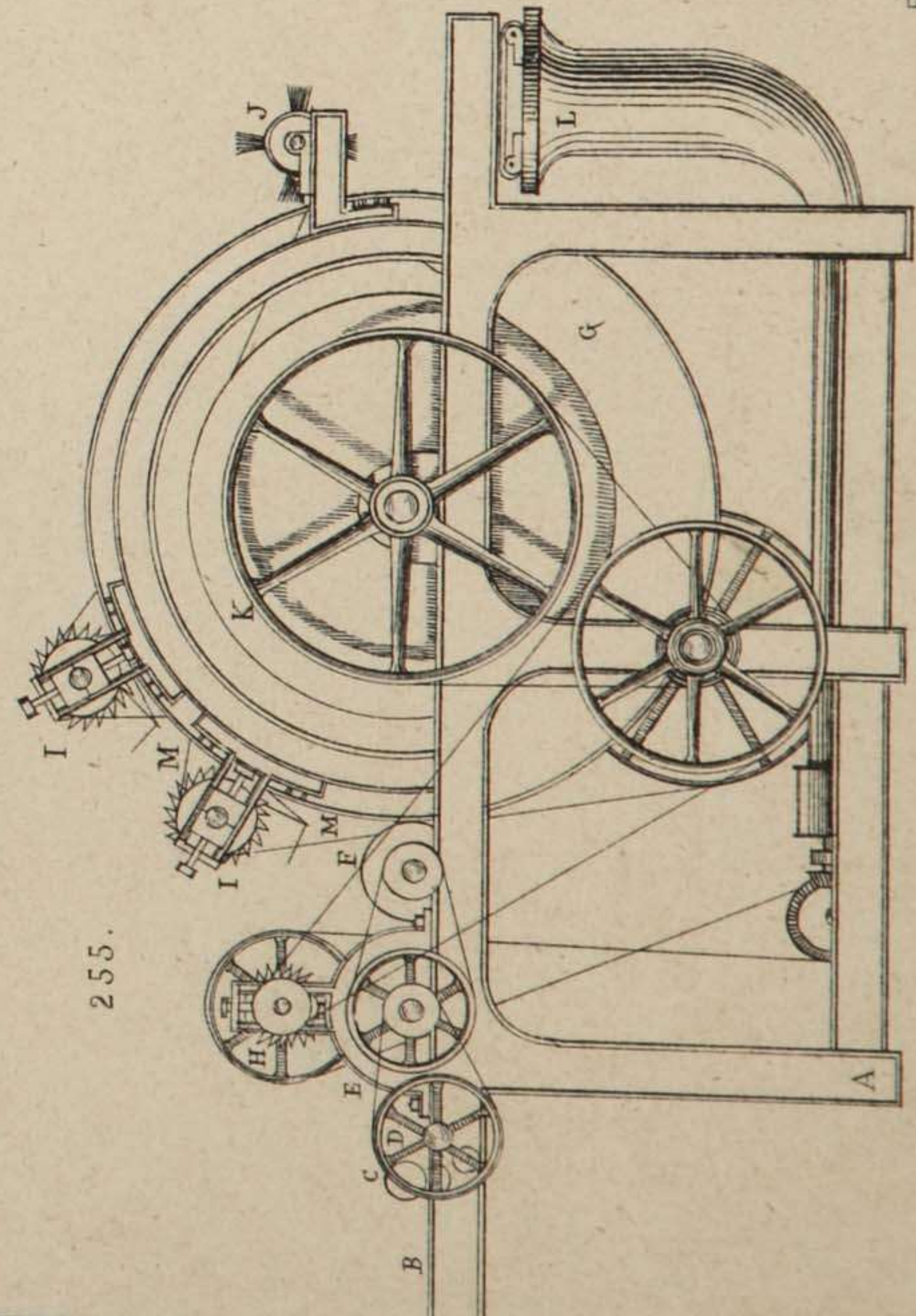
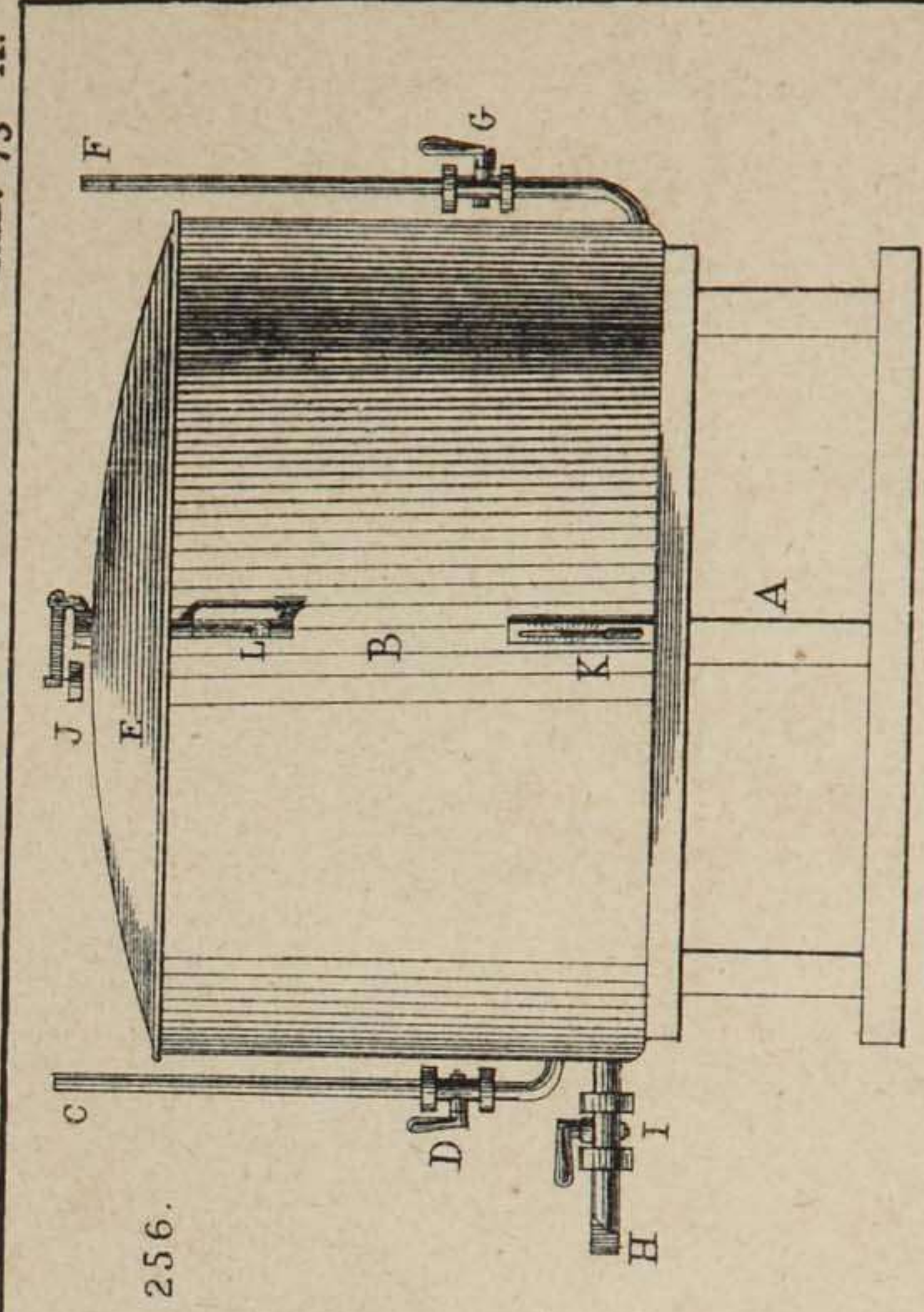
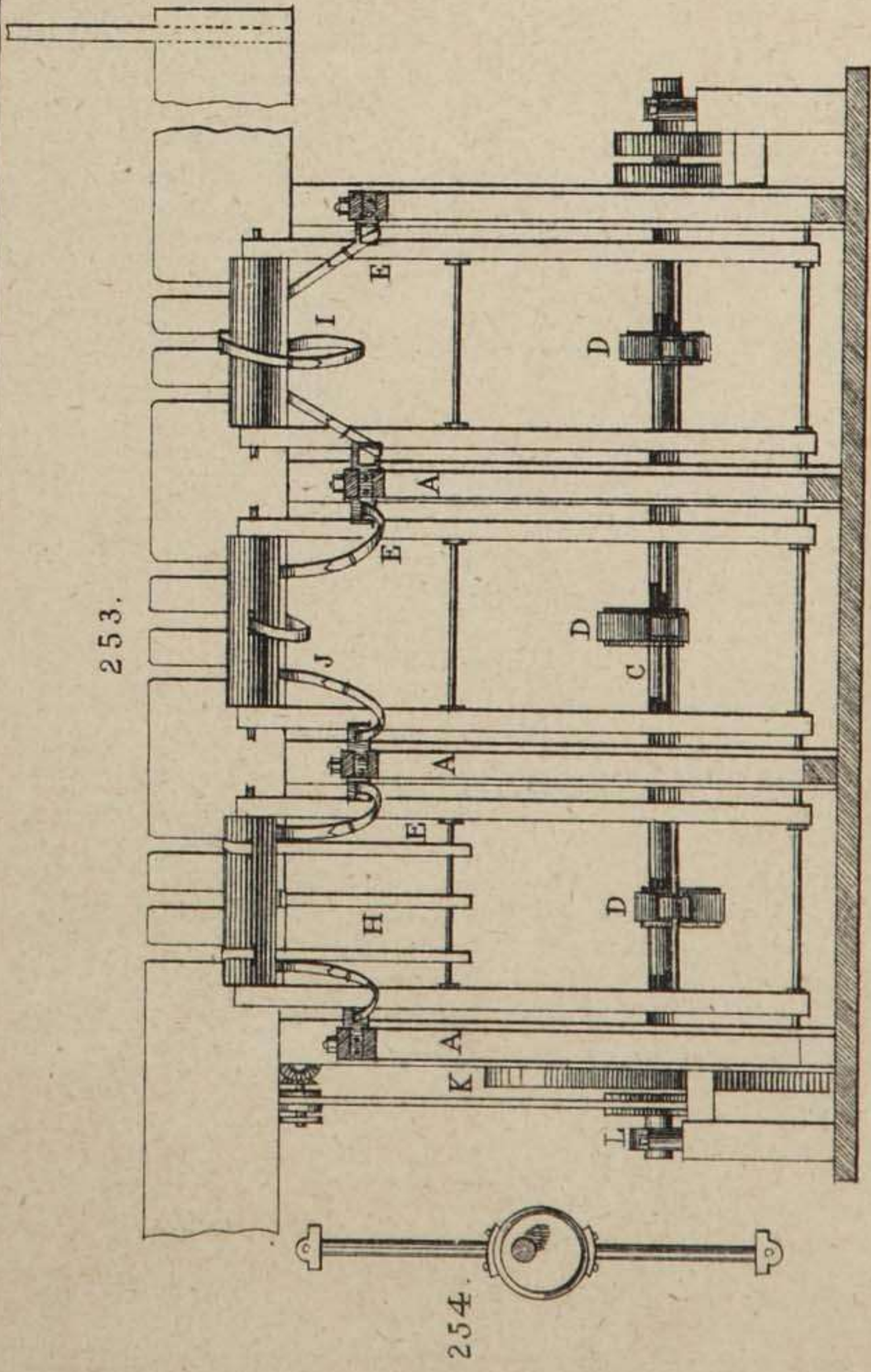


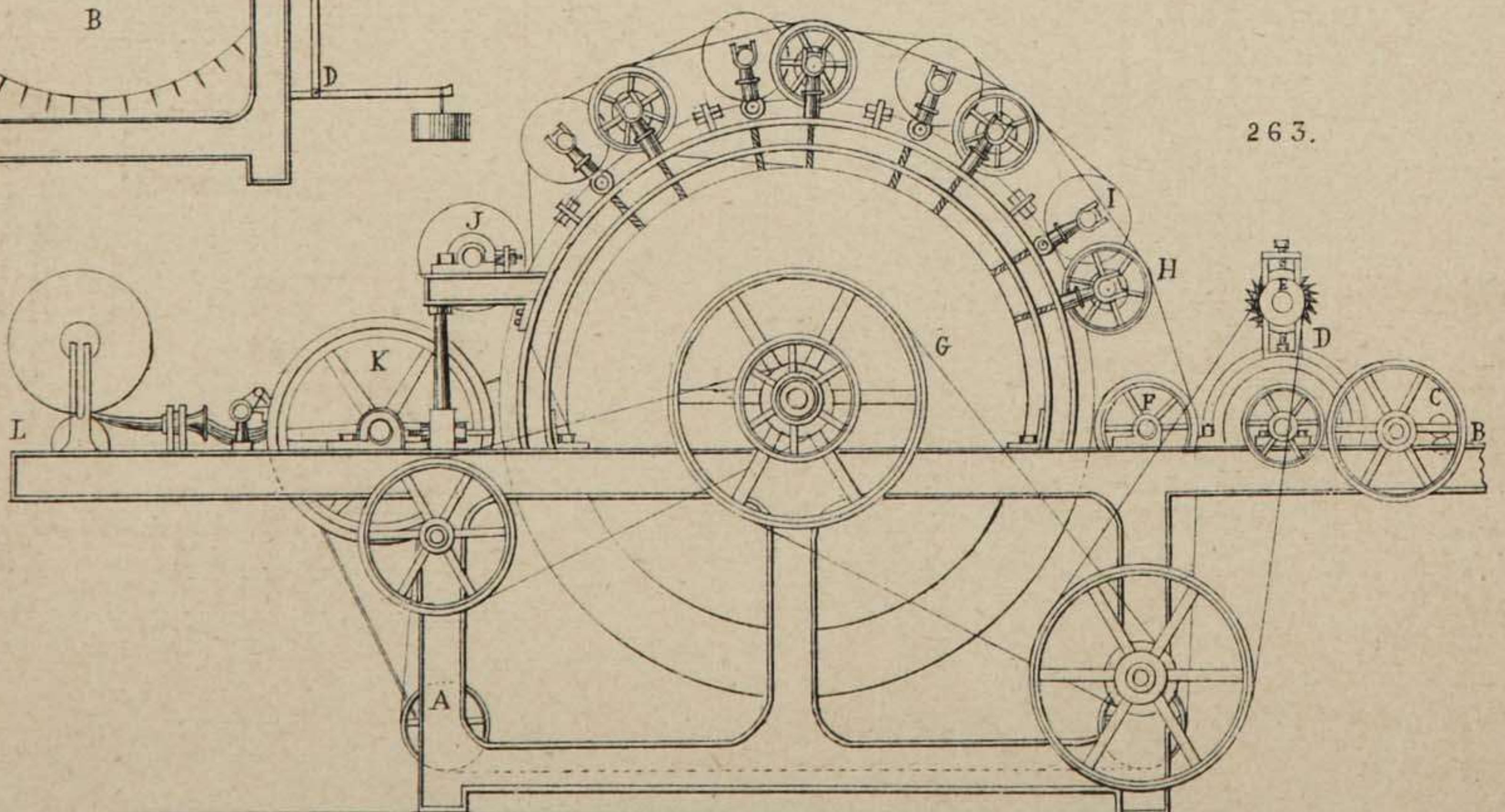
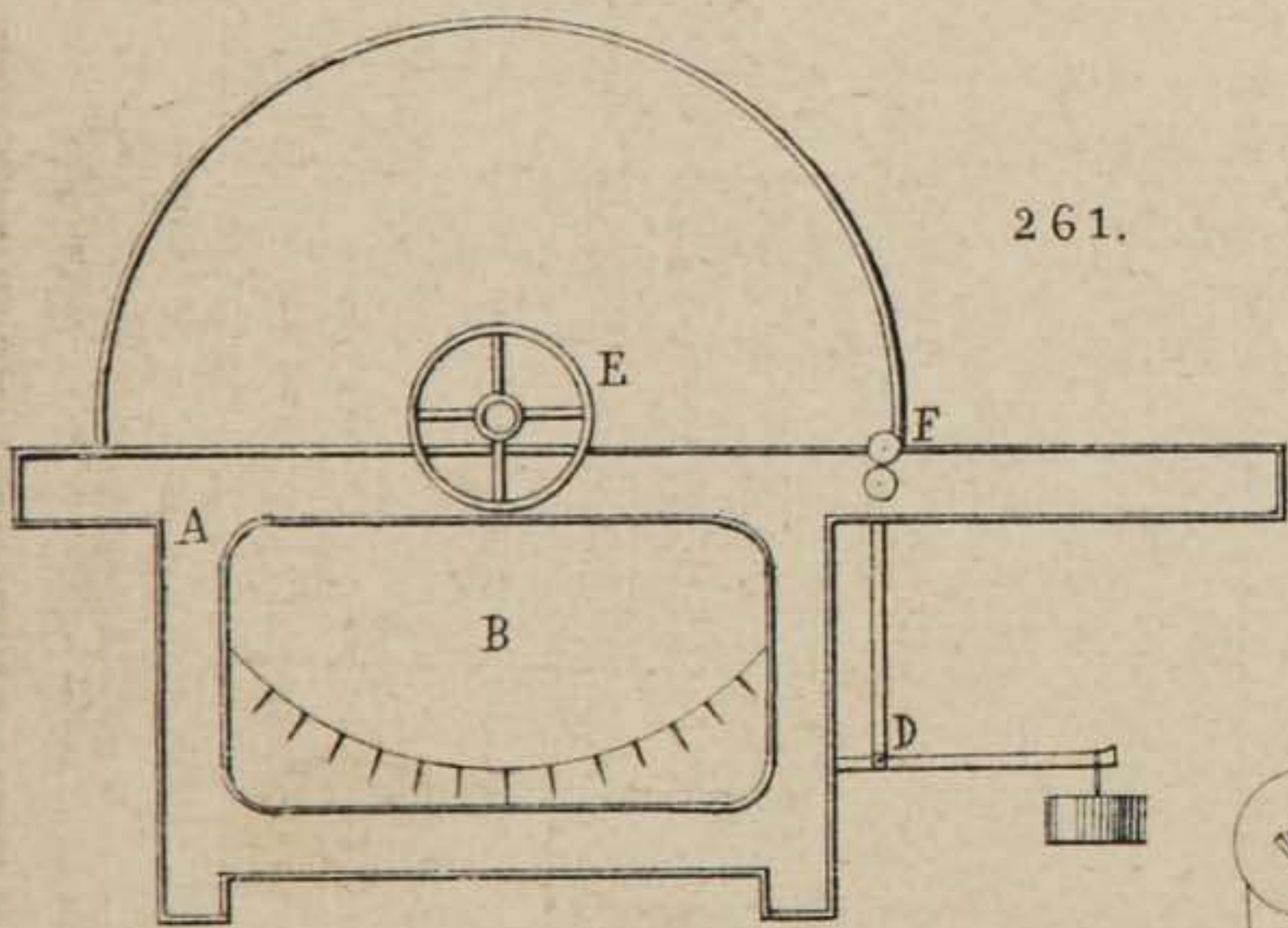
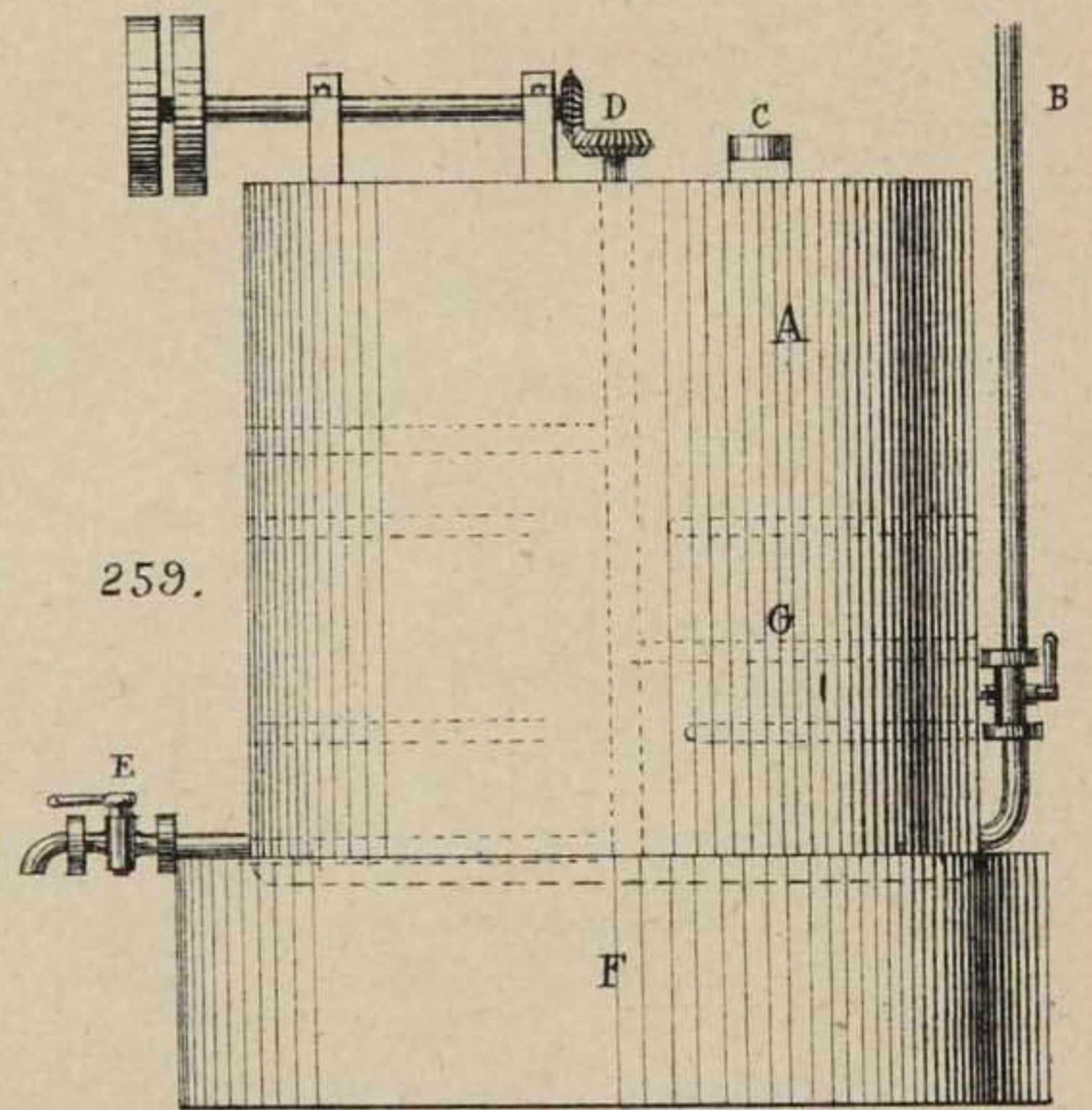
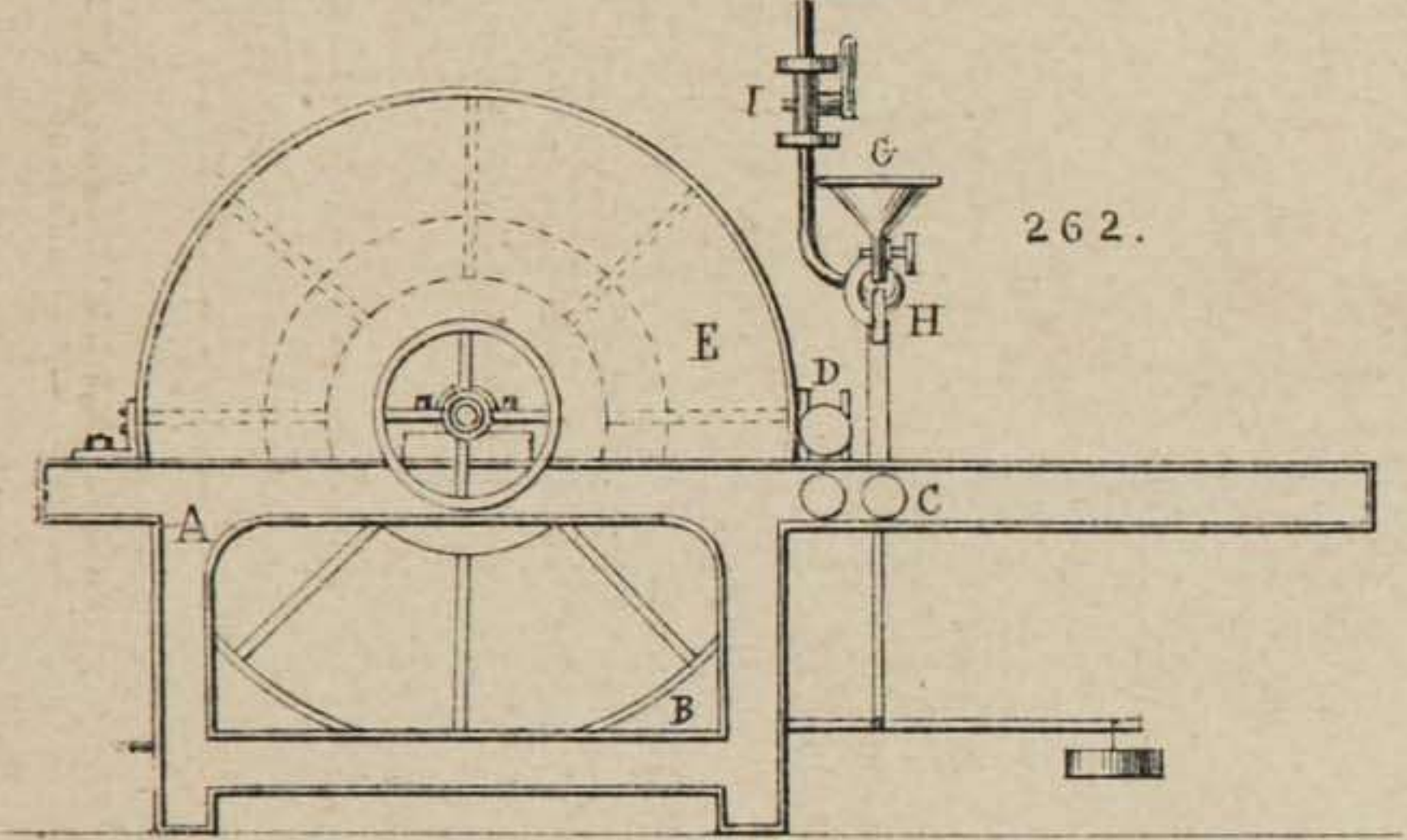
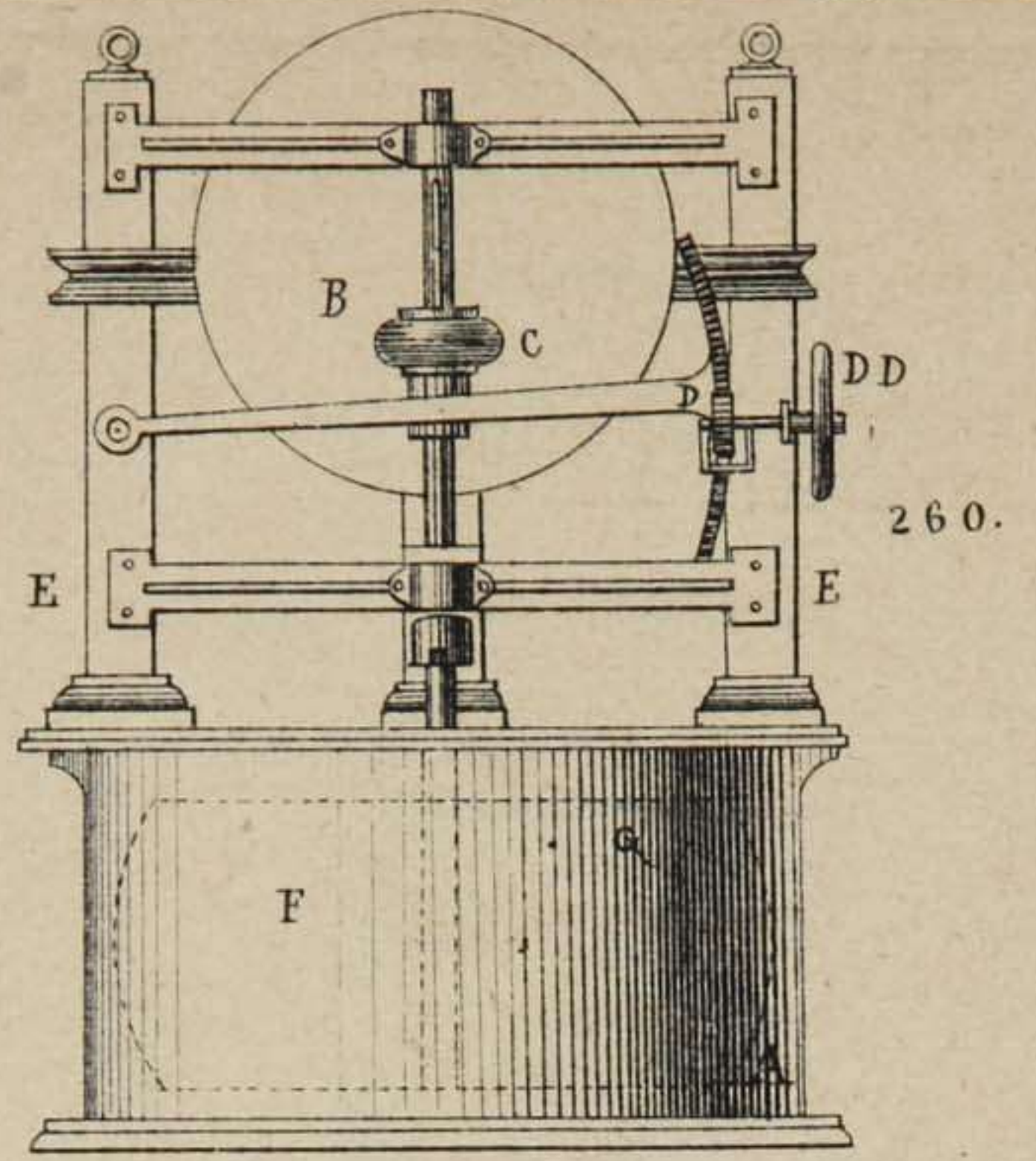
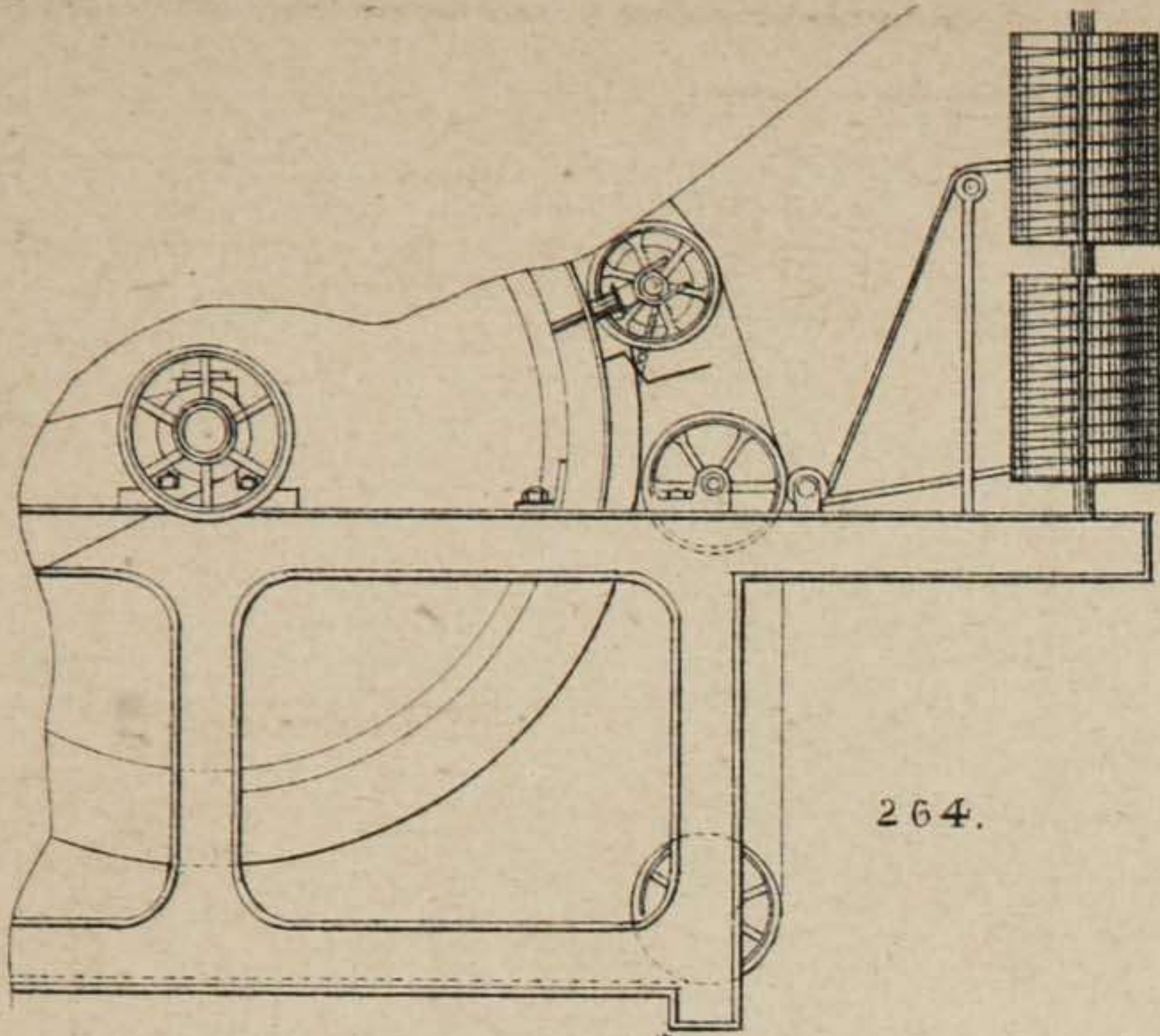
248.

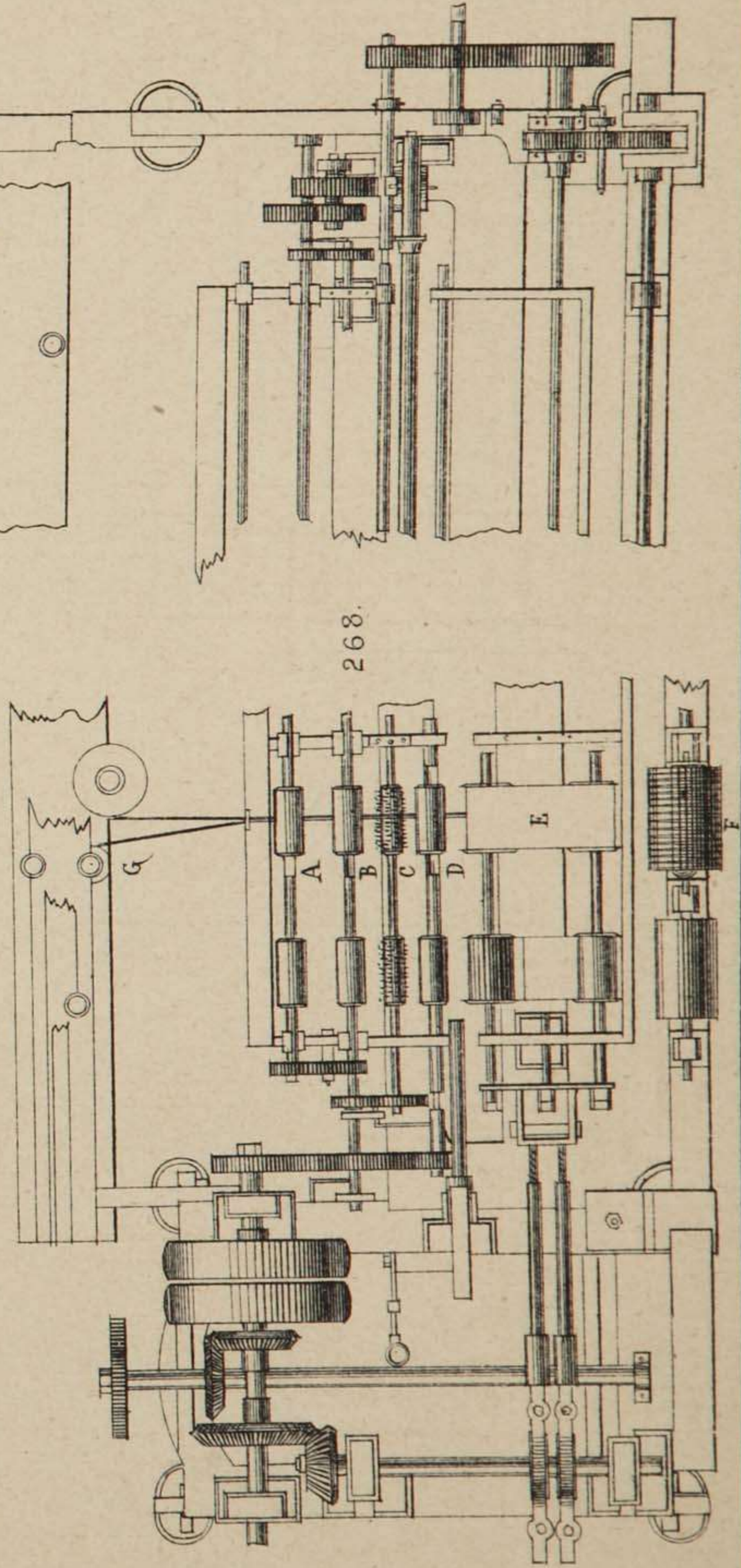
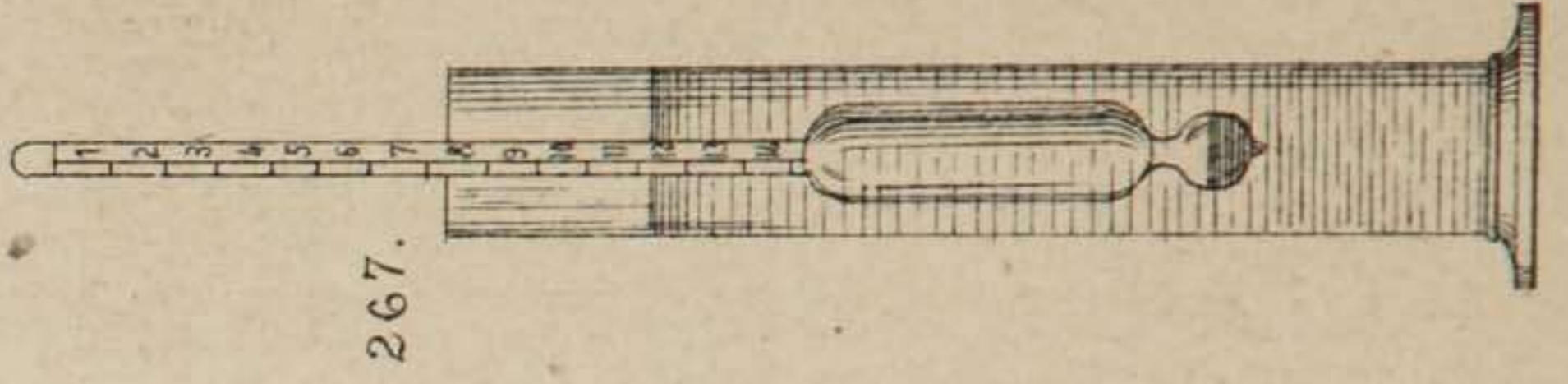
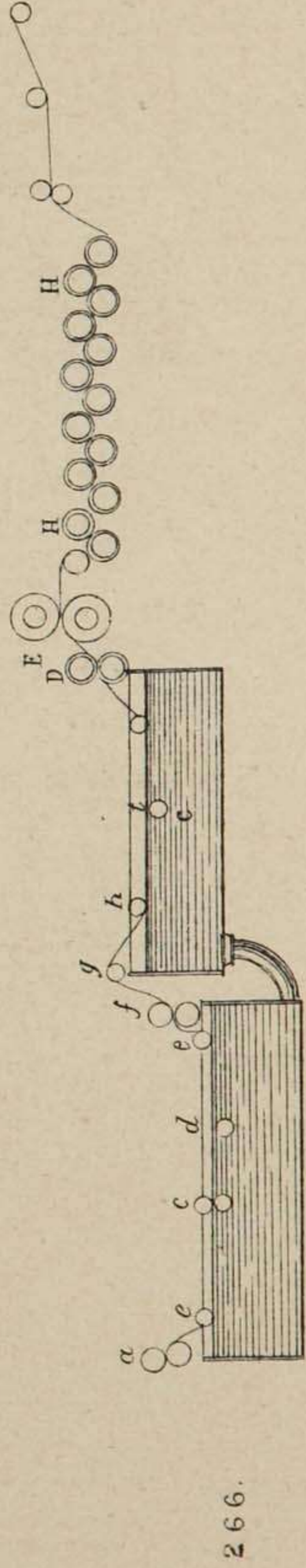
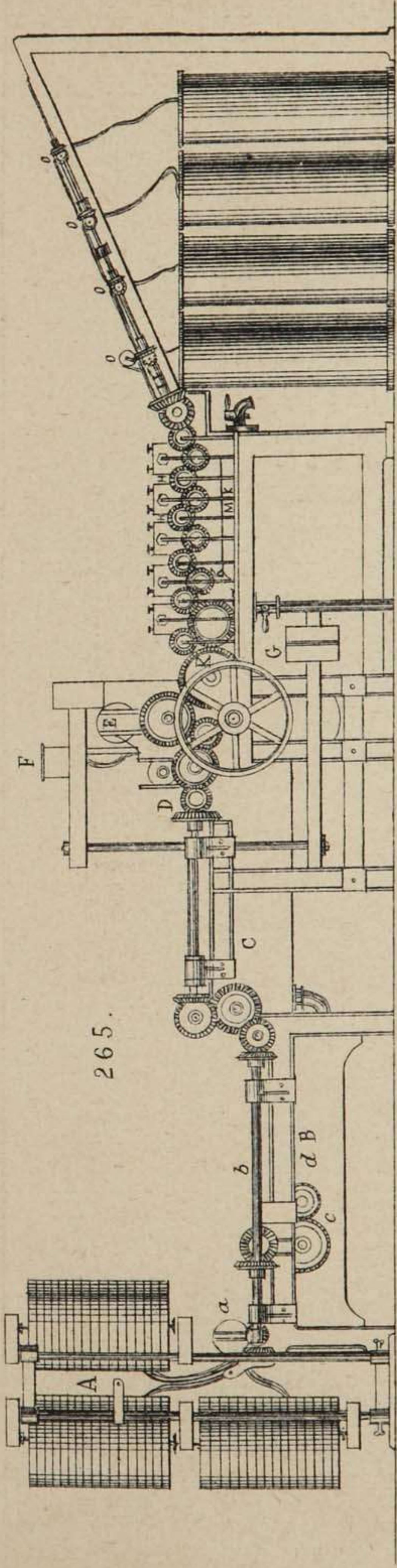


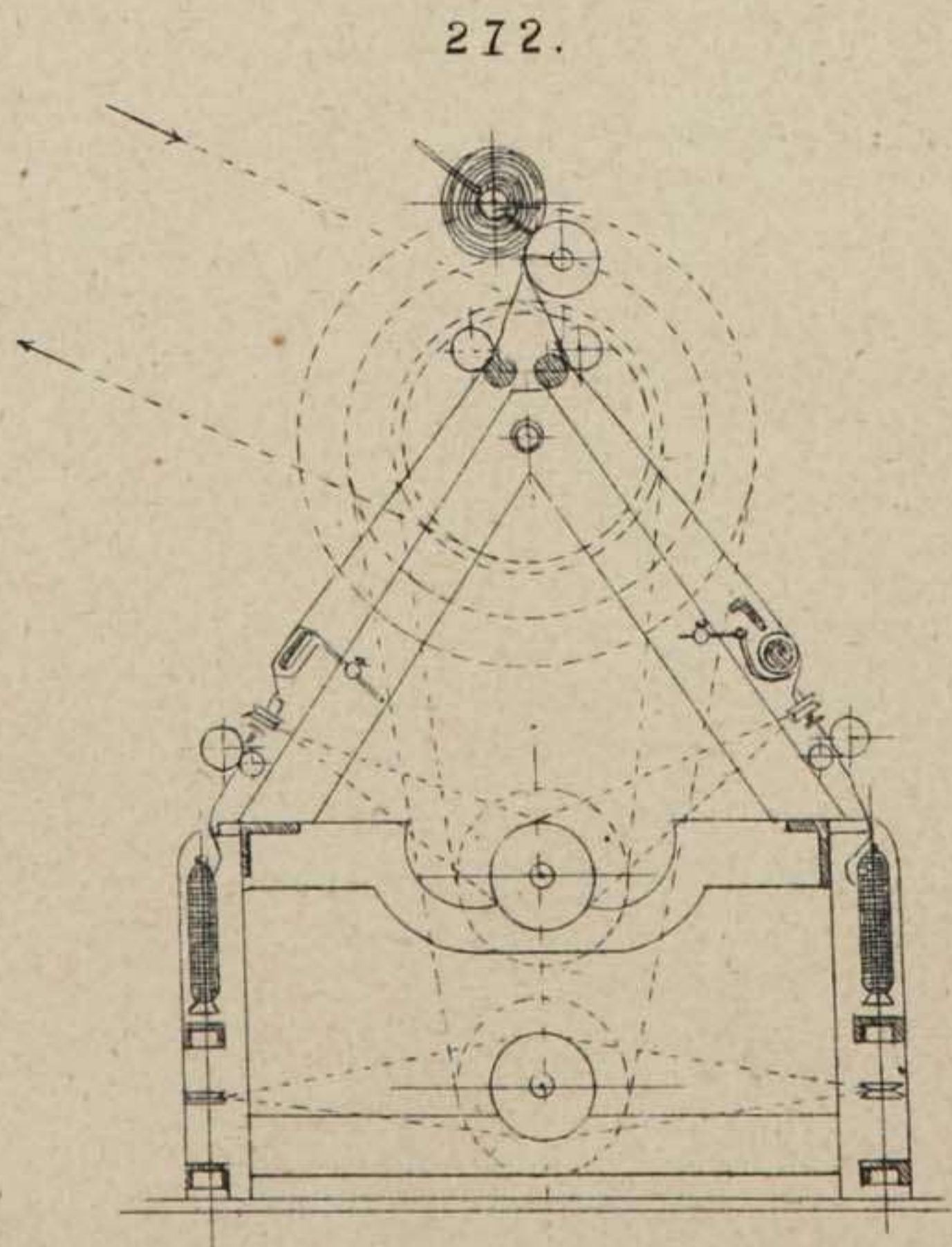
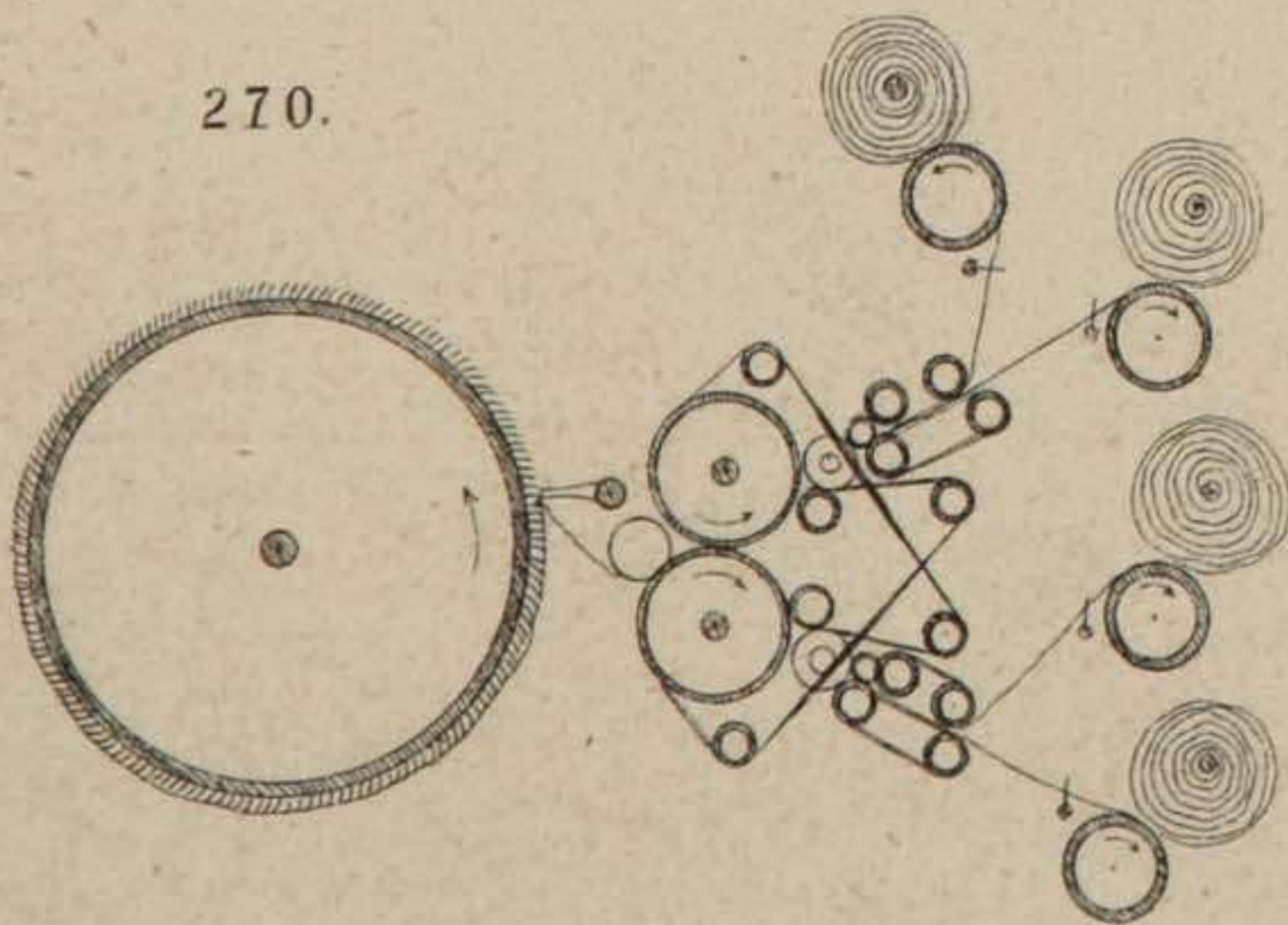
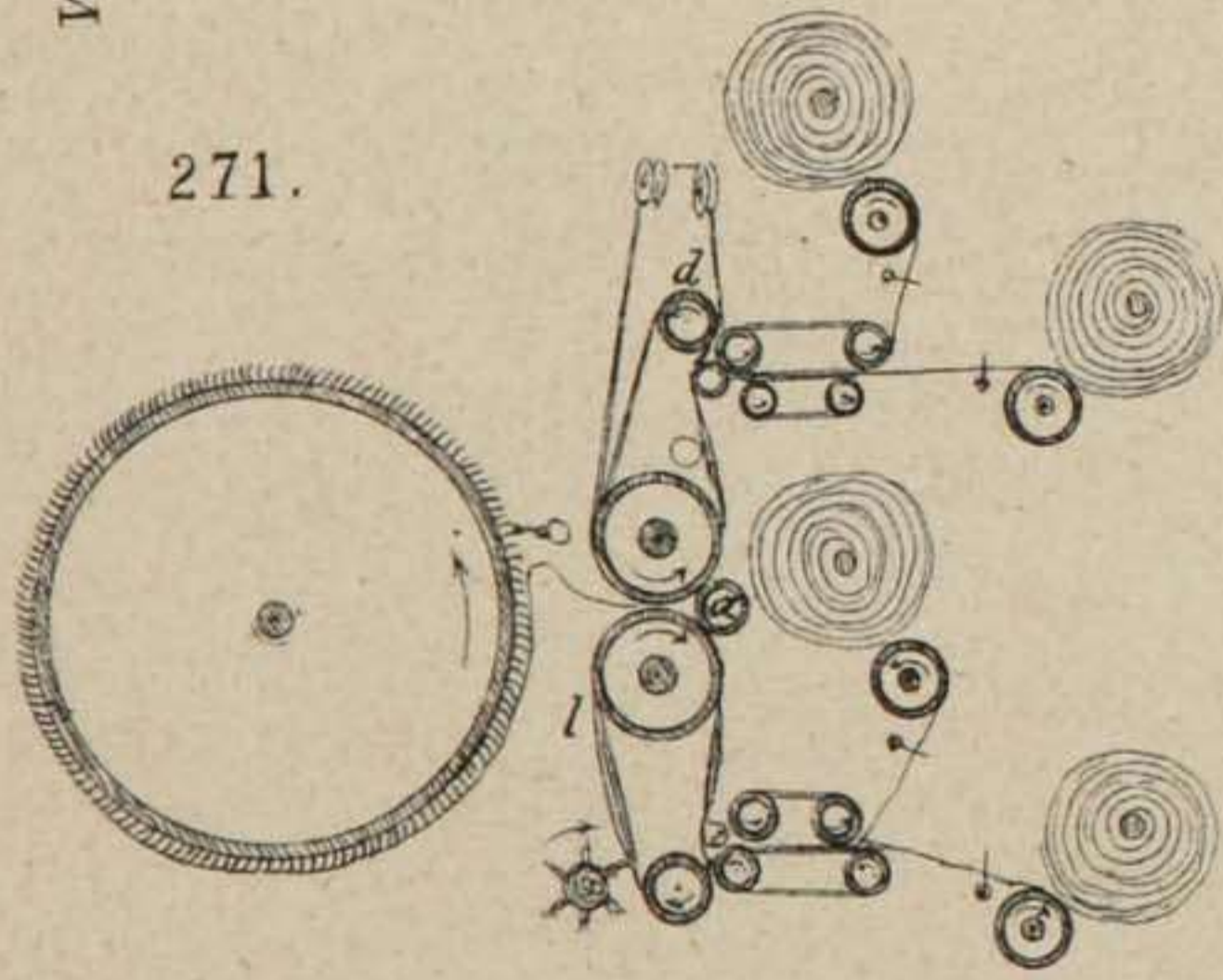
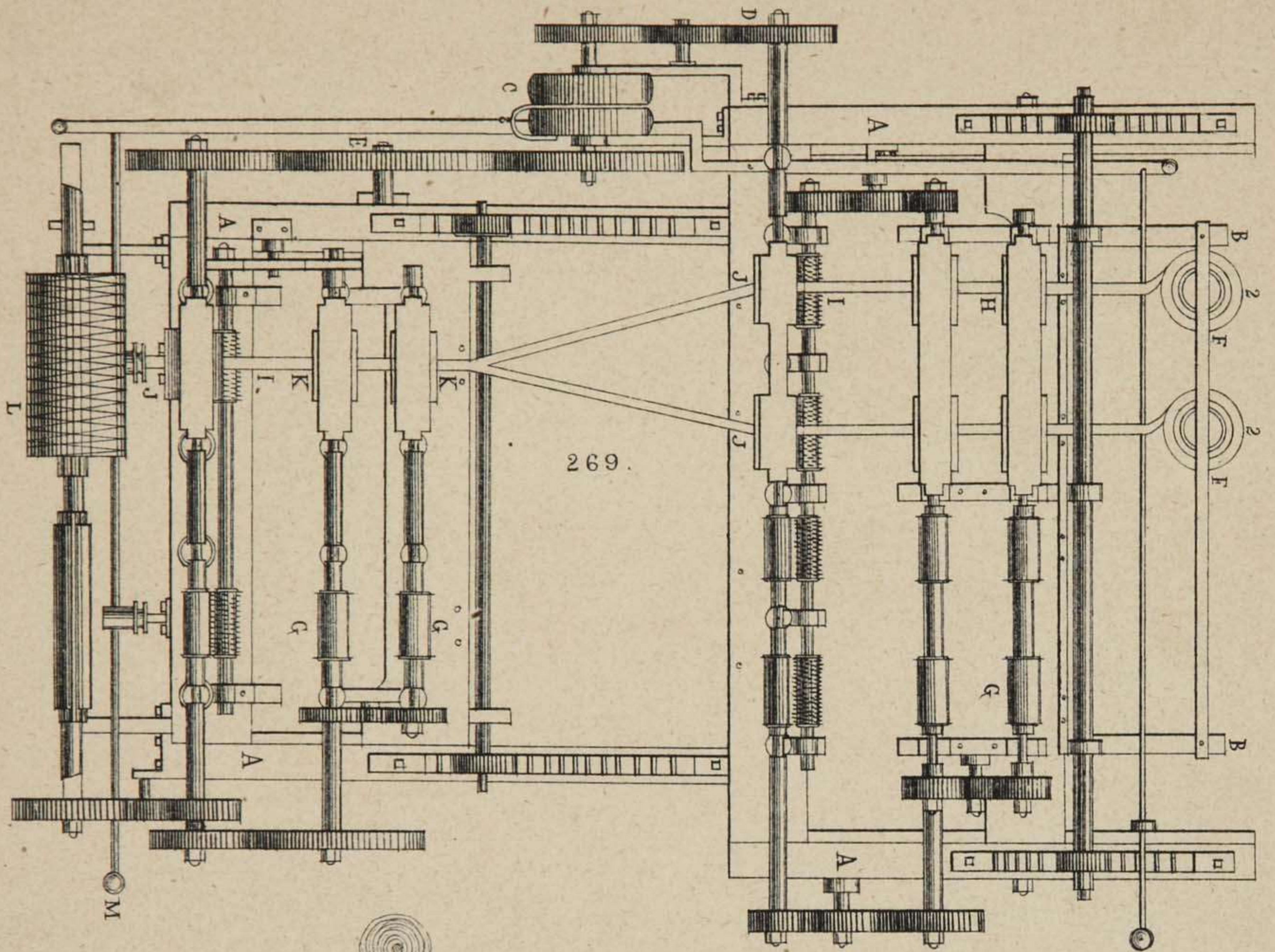
246.

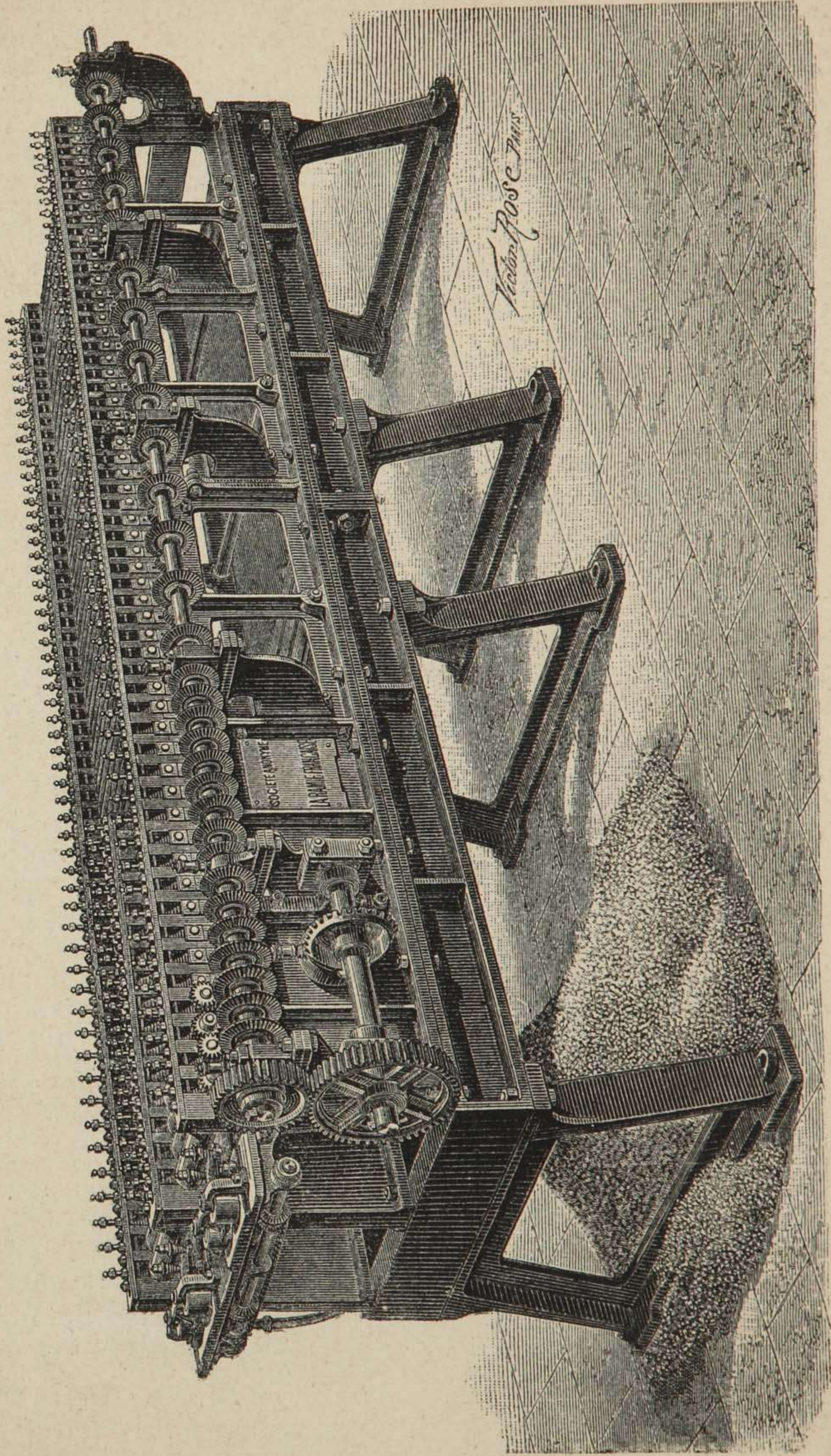


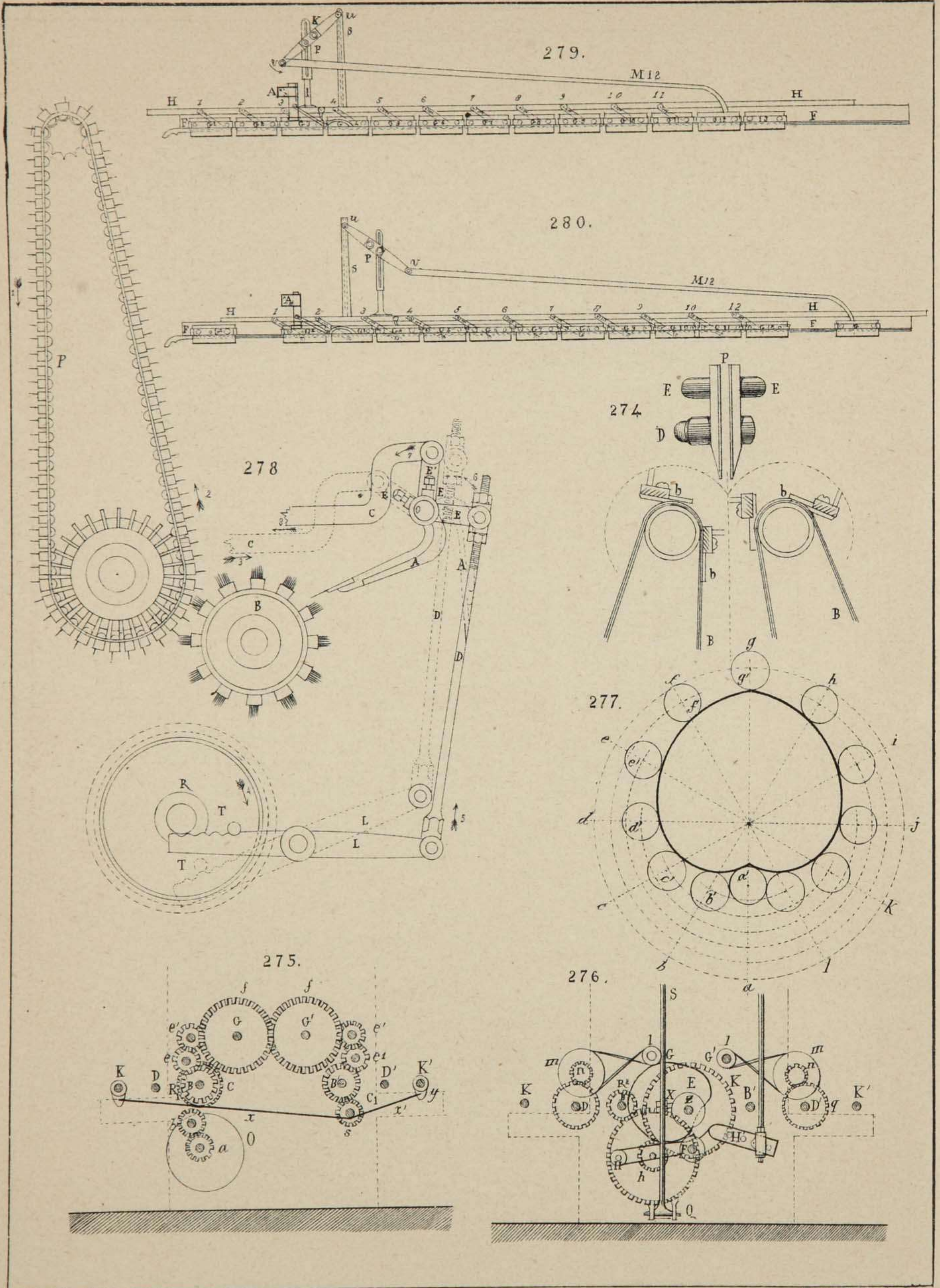


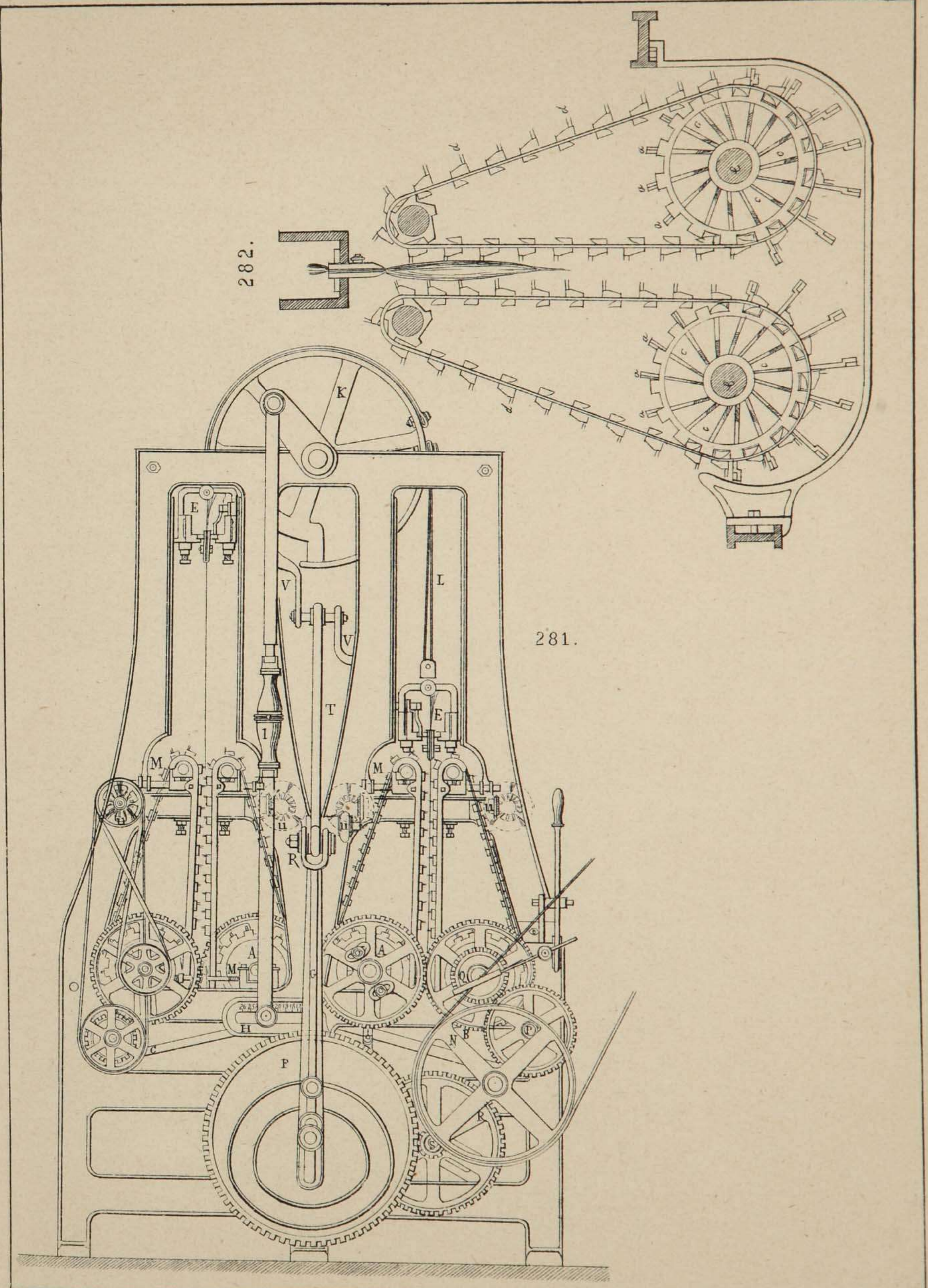


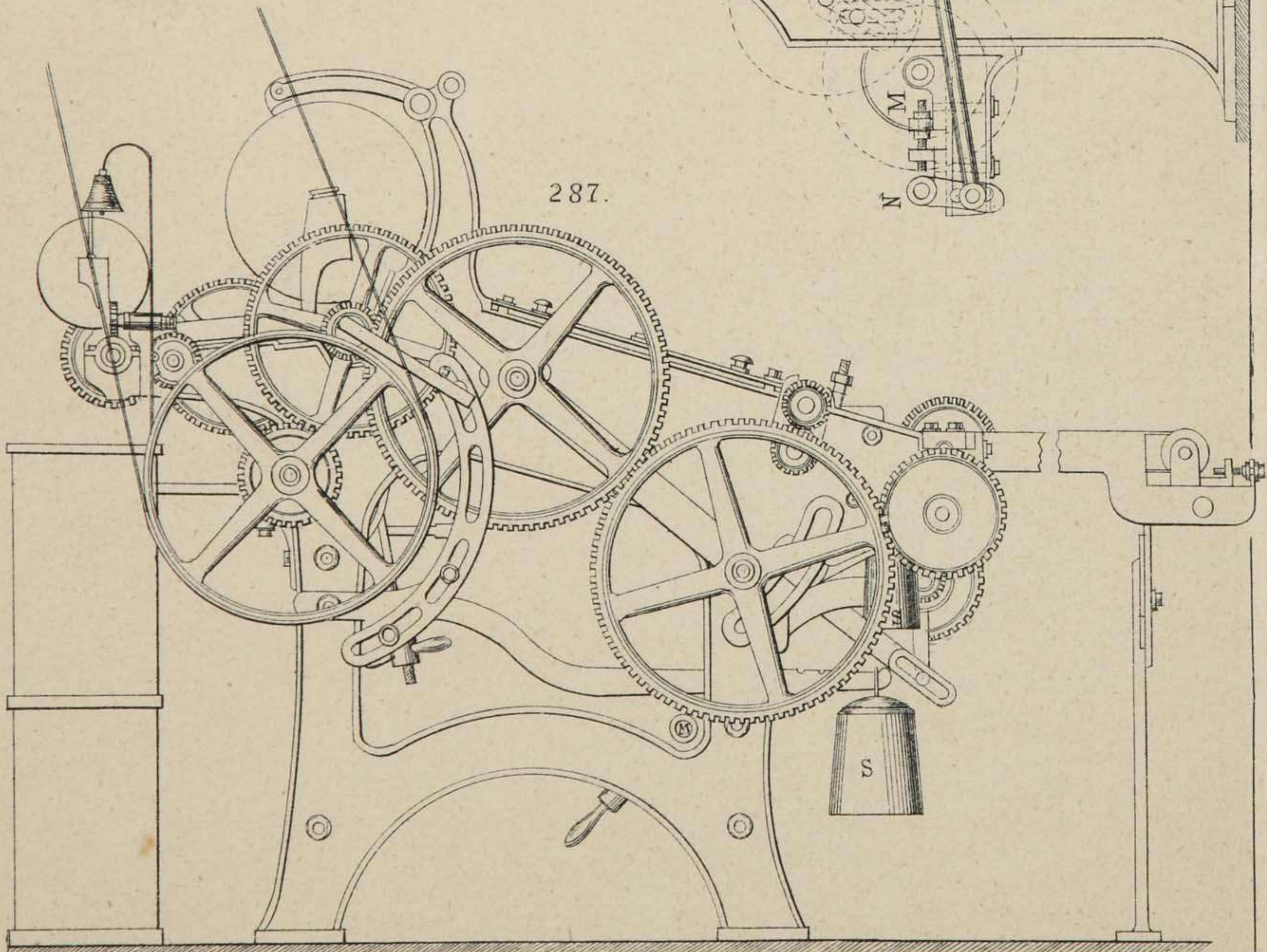
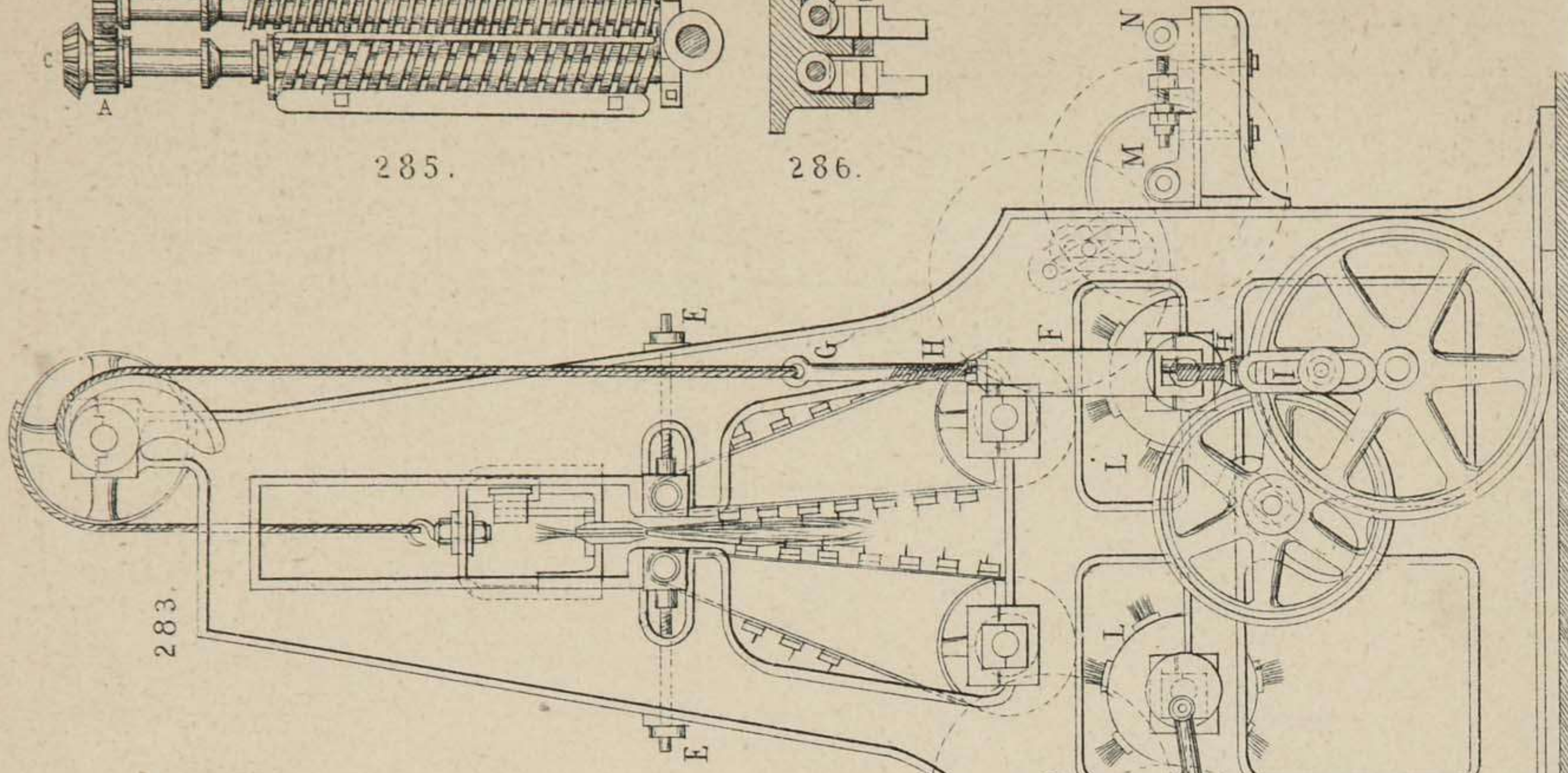
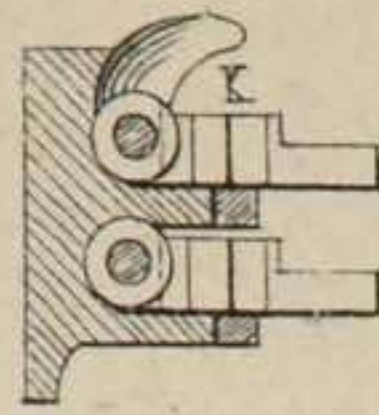
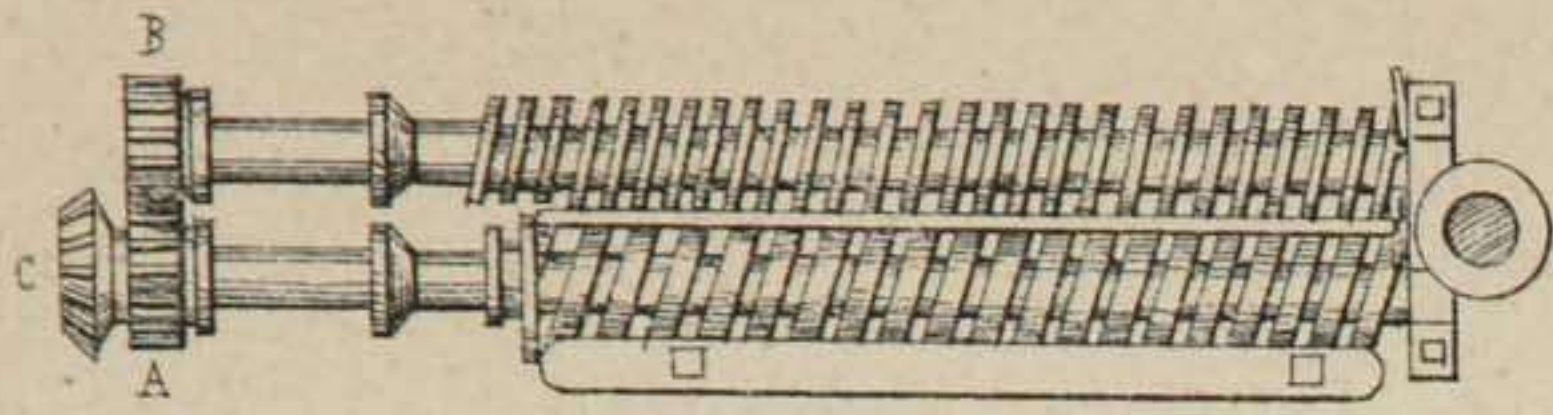




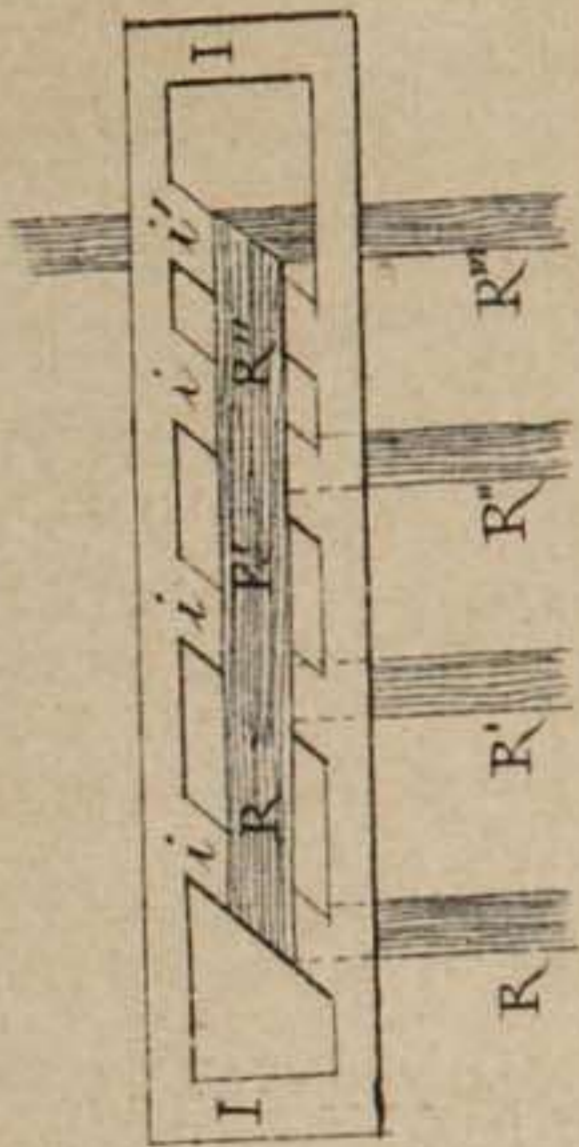




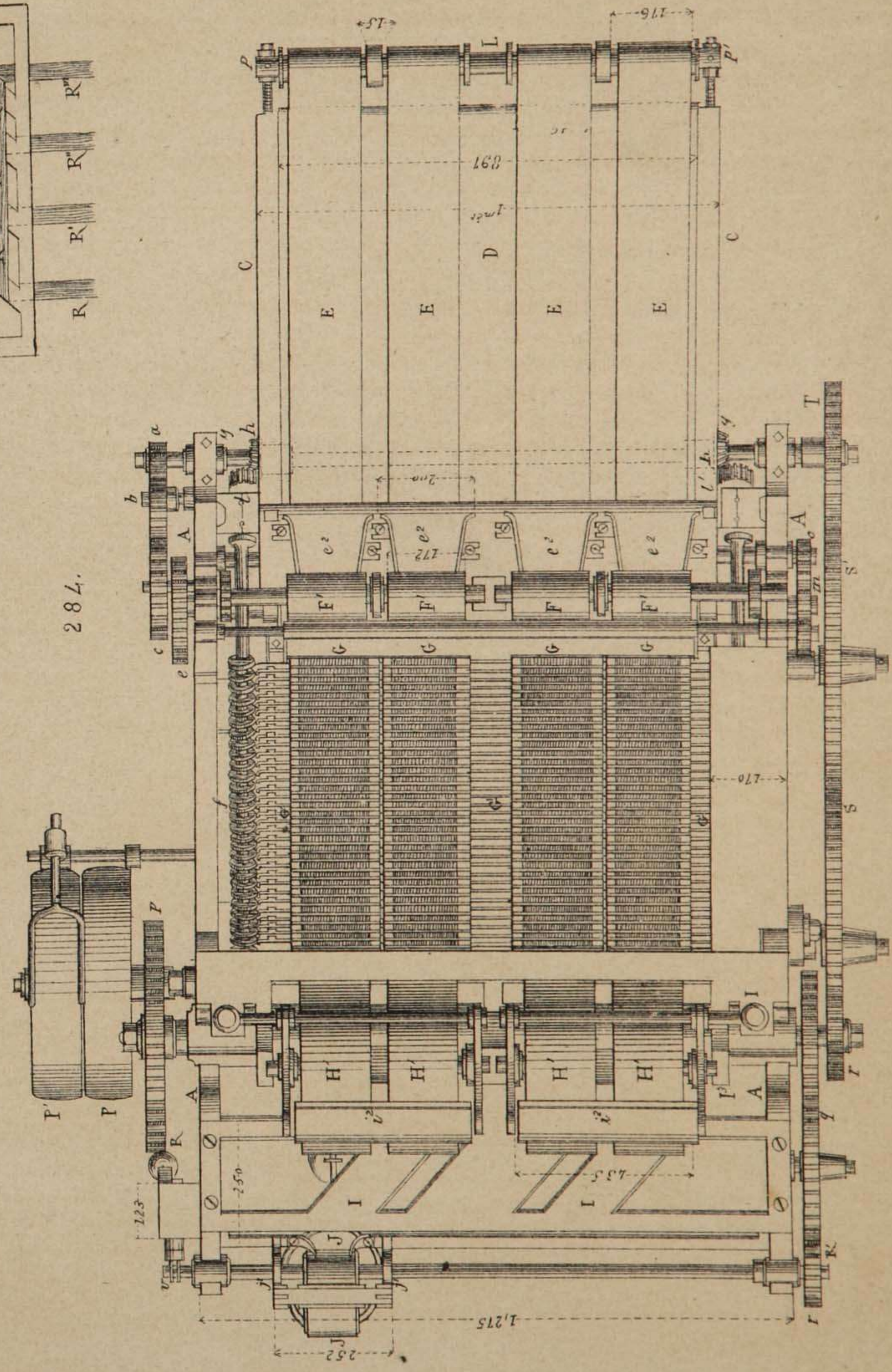


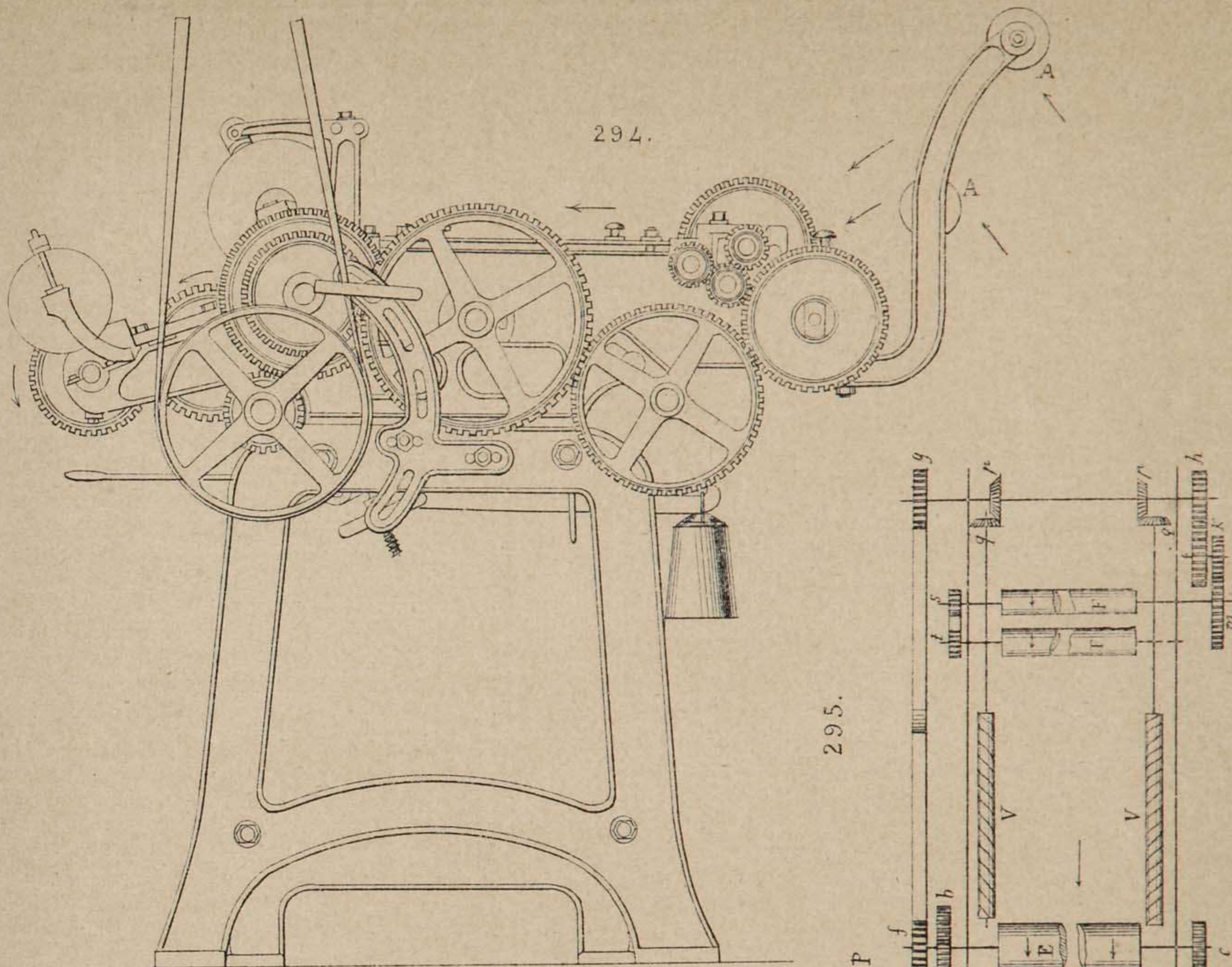


288.

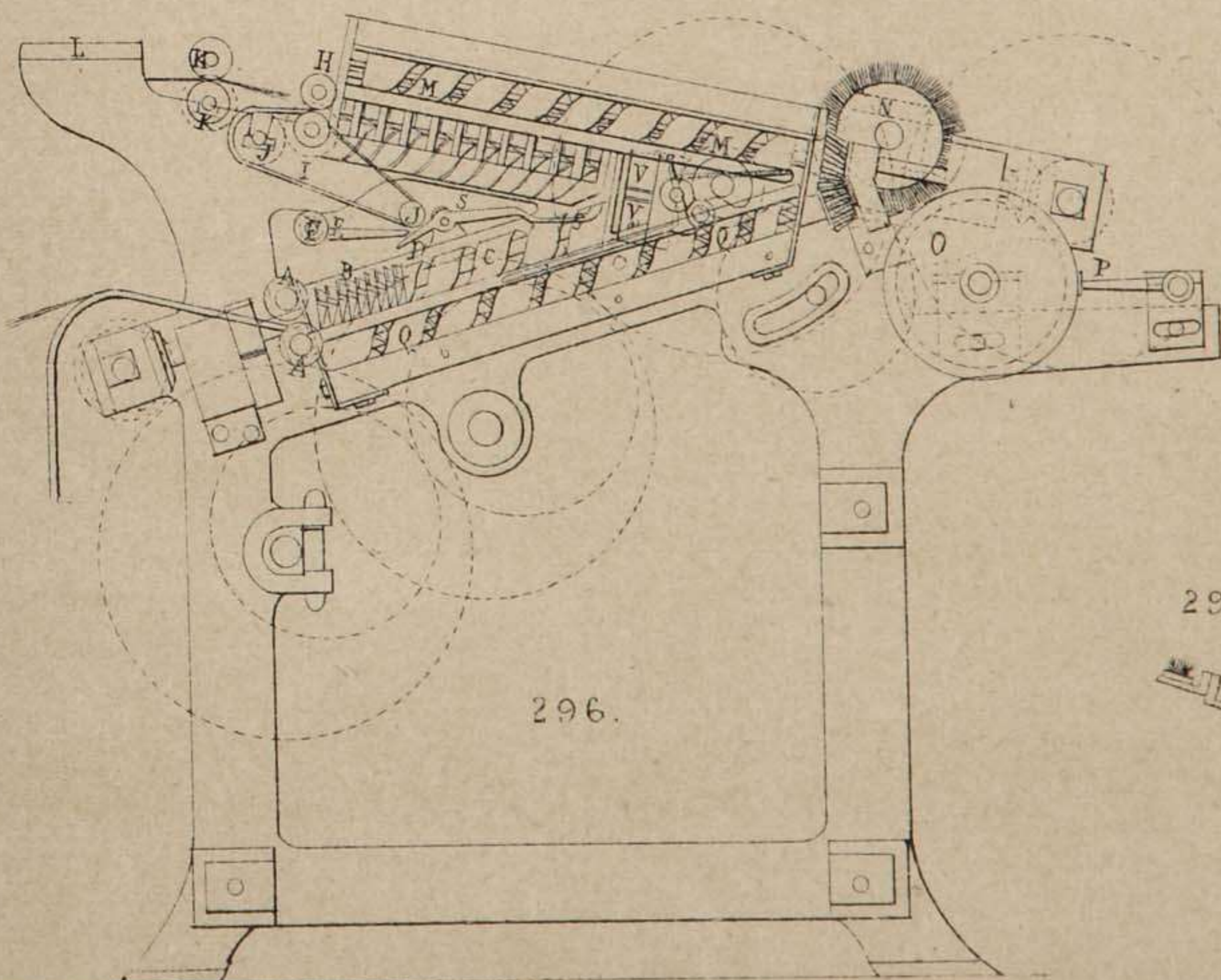
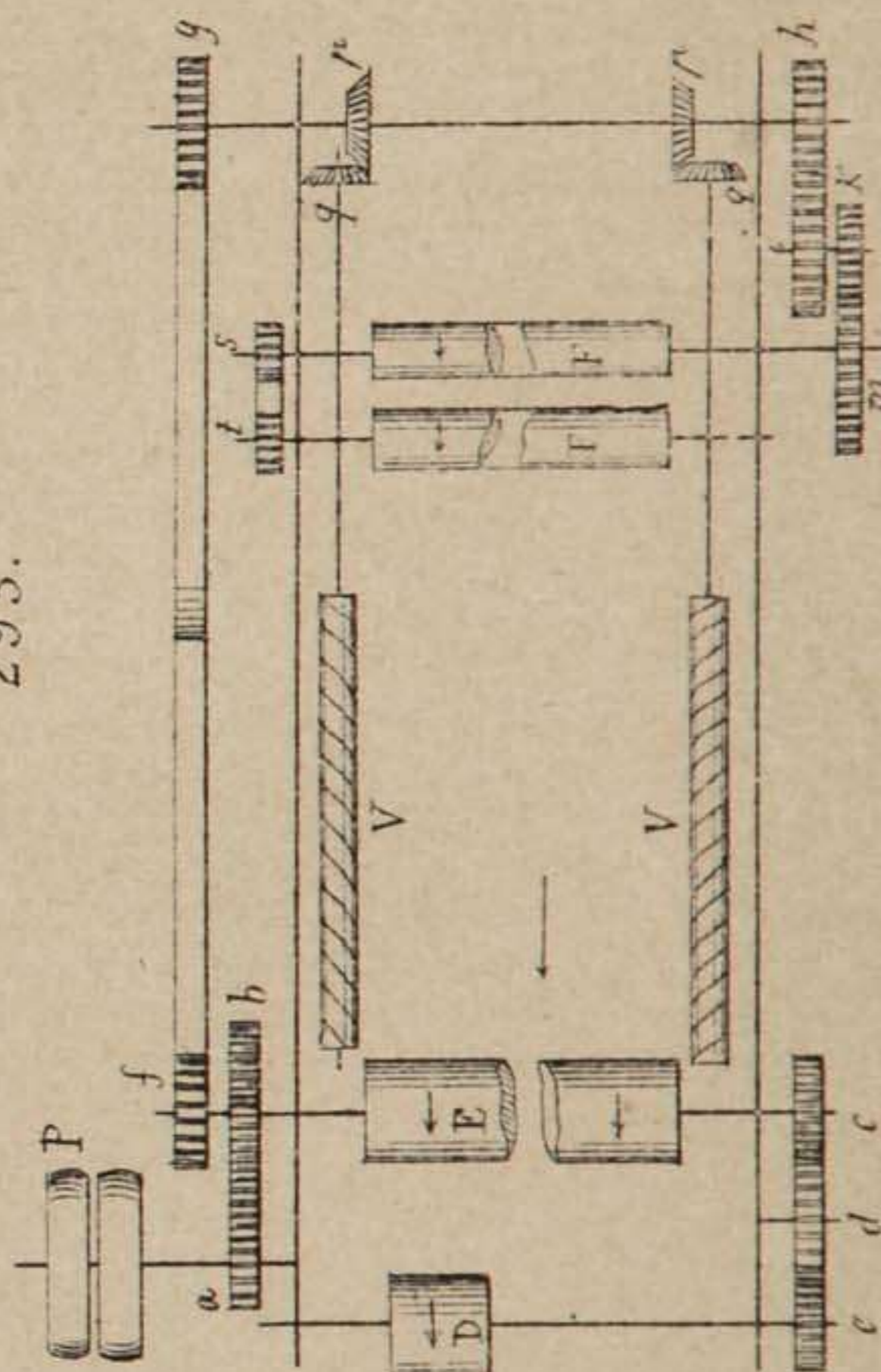


284.

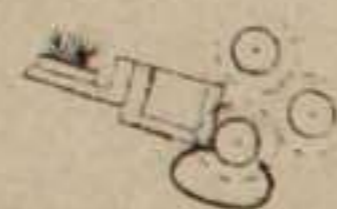




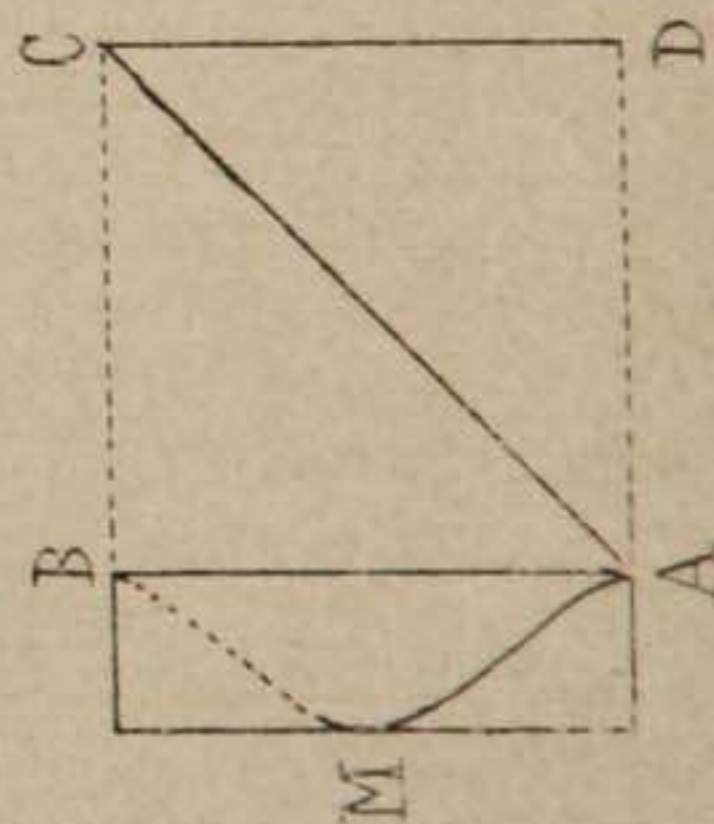
295.



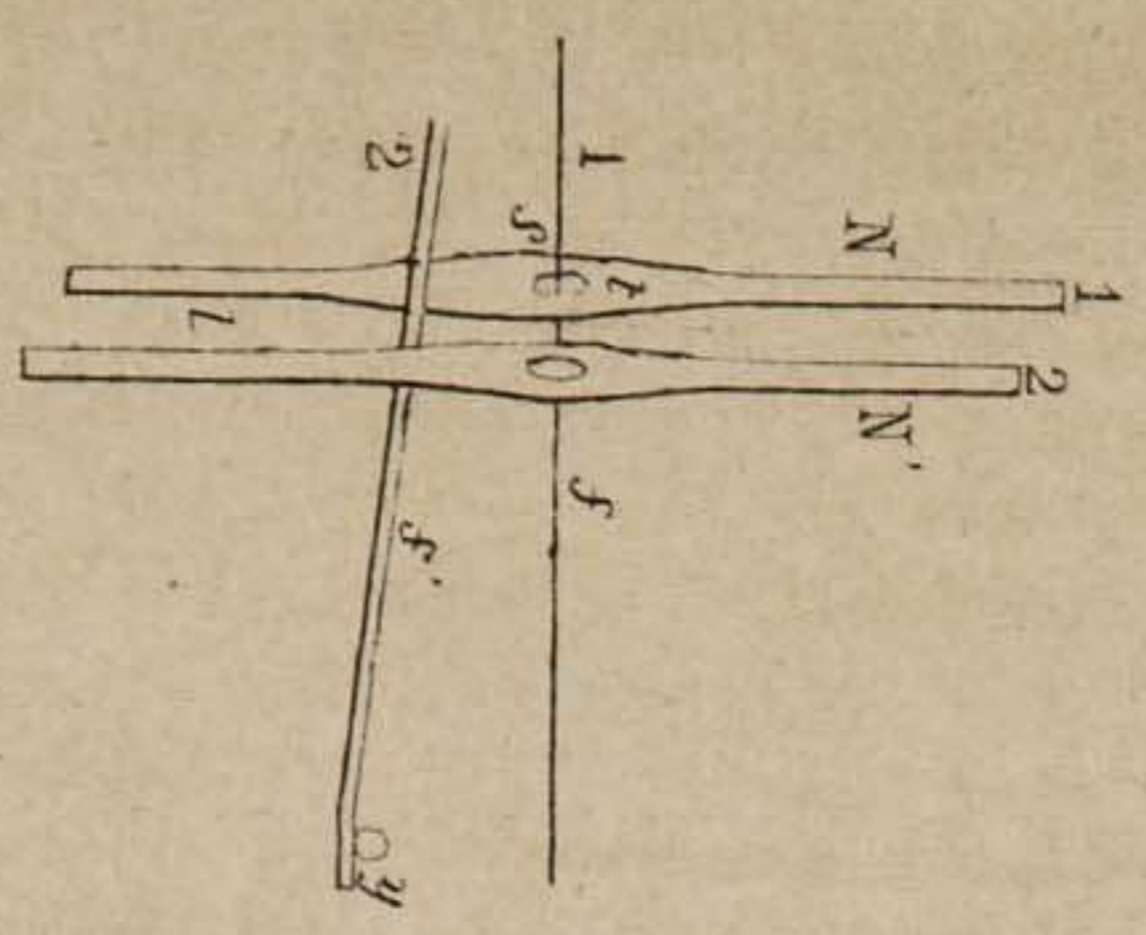
297.



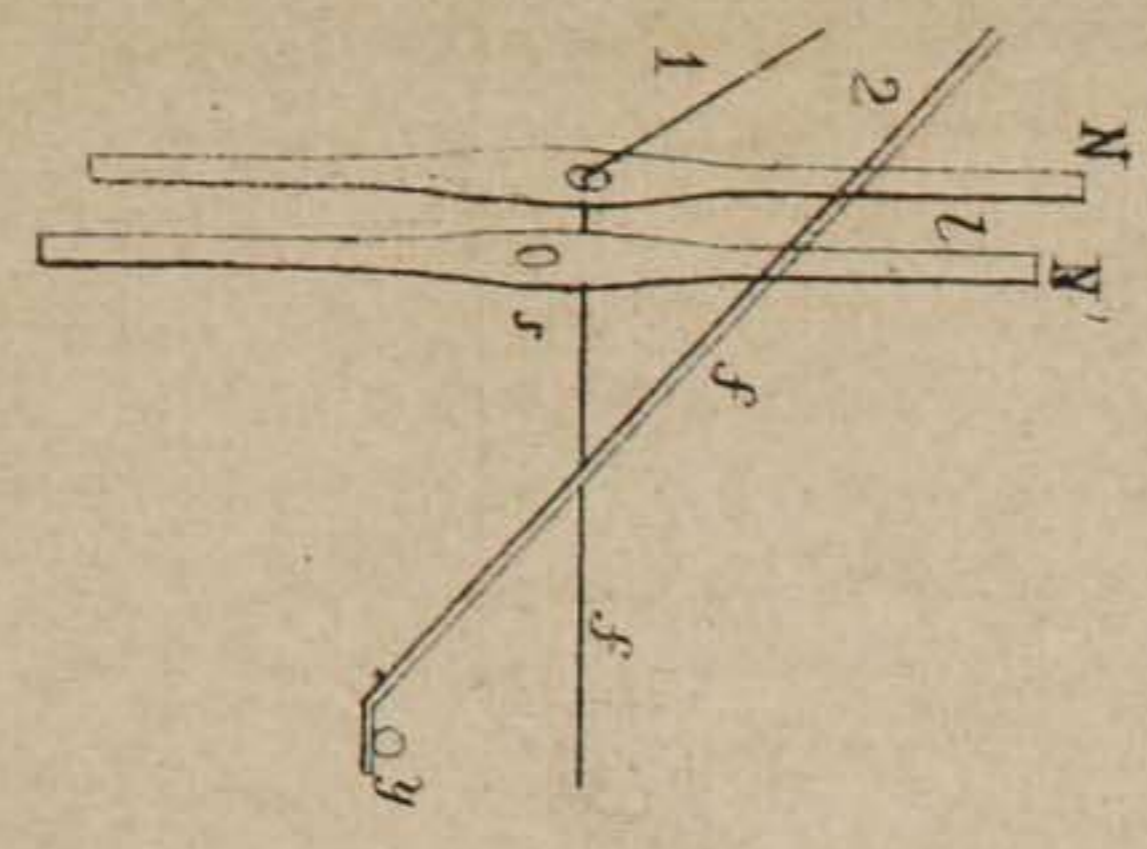
298.



304.



305.



303.

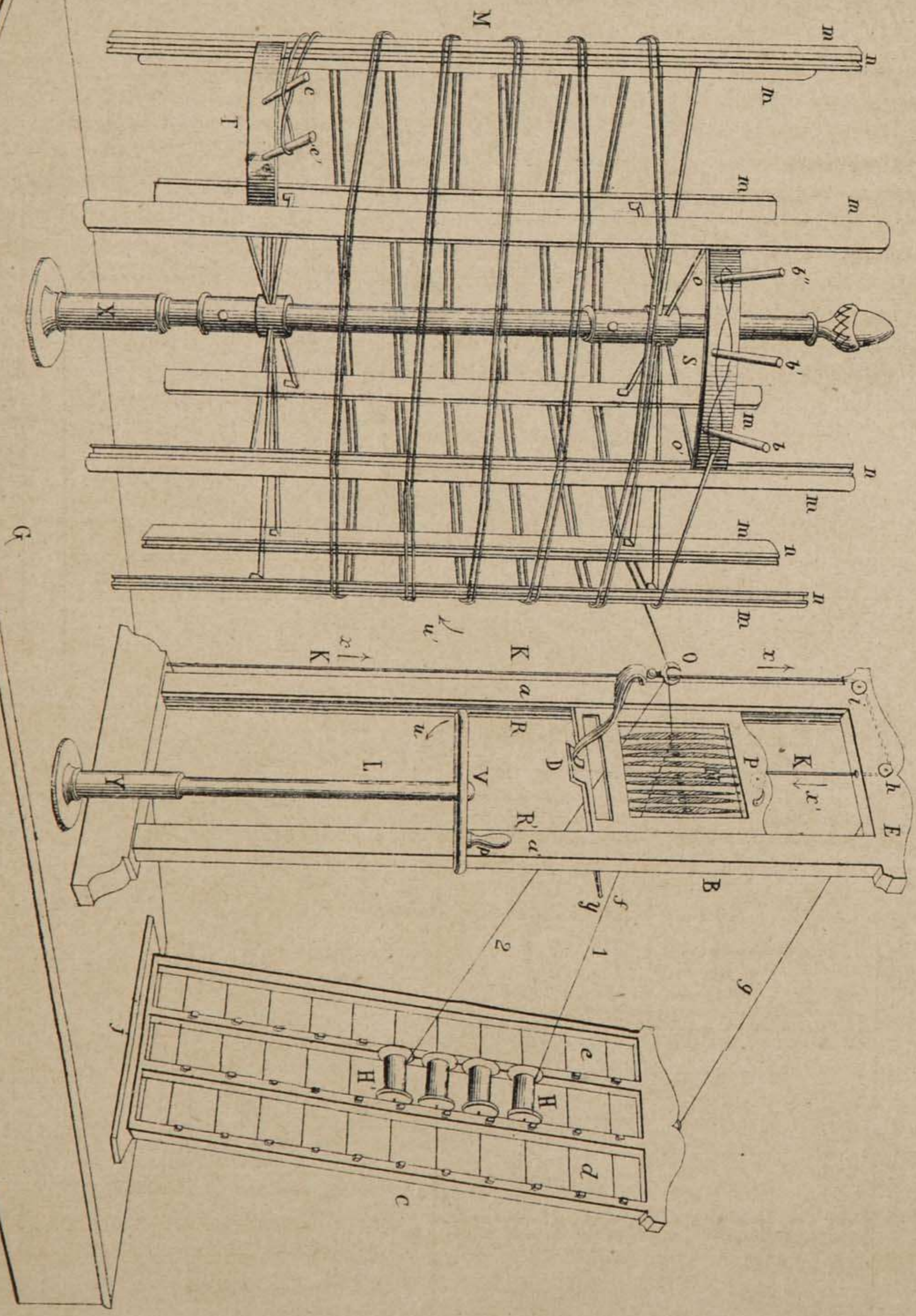


Fig. 309

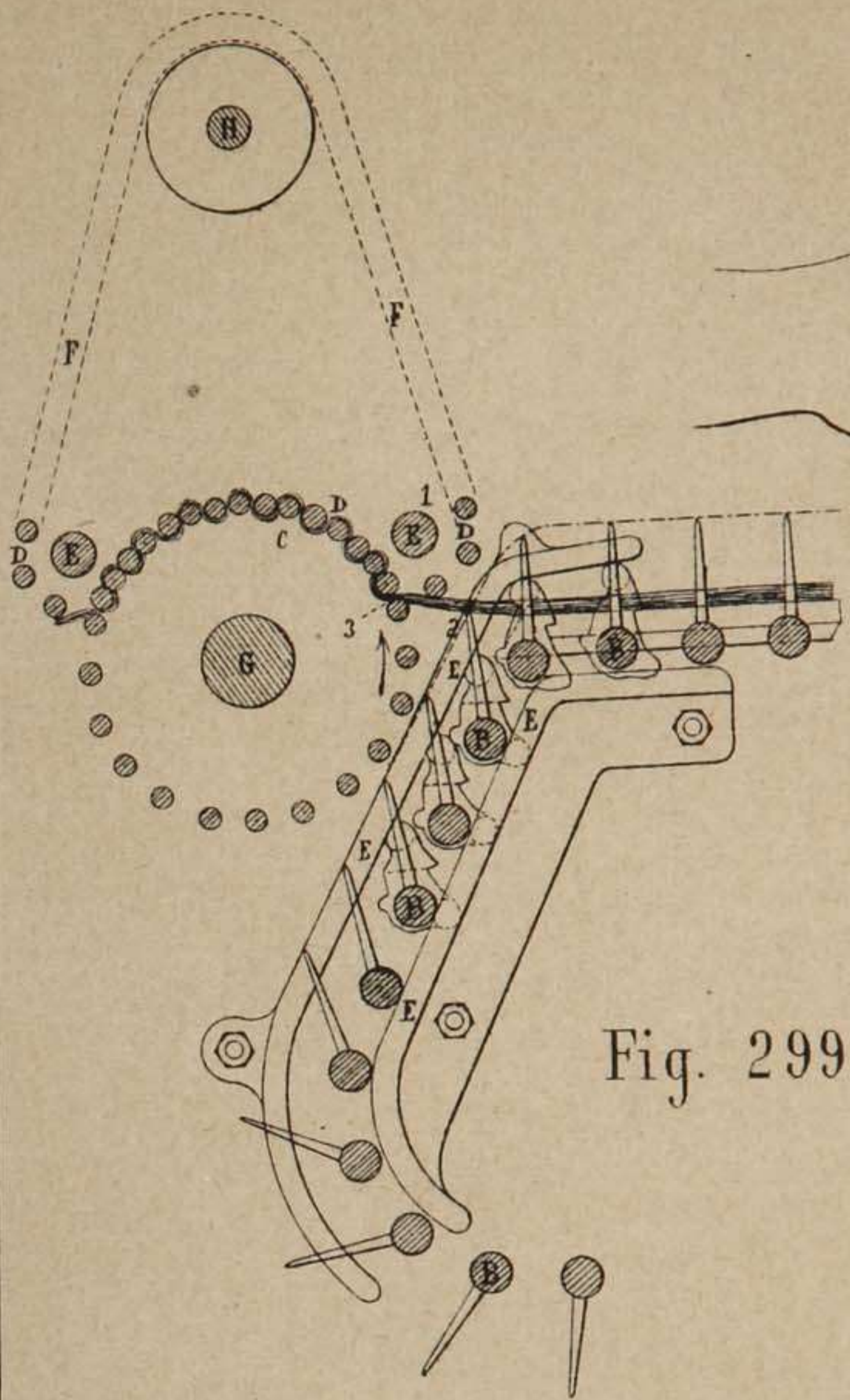
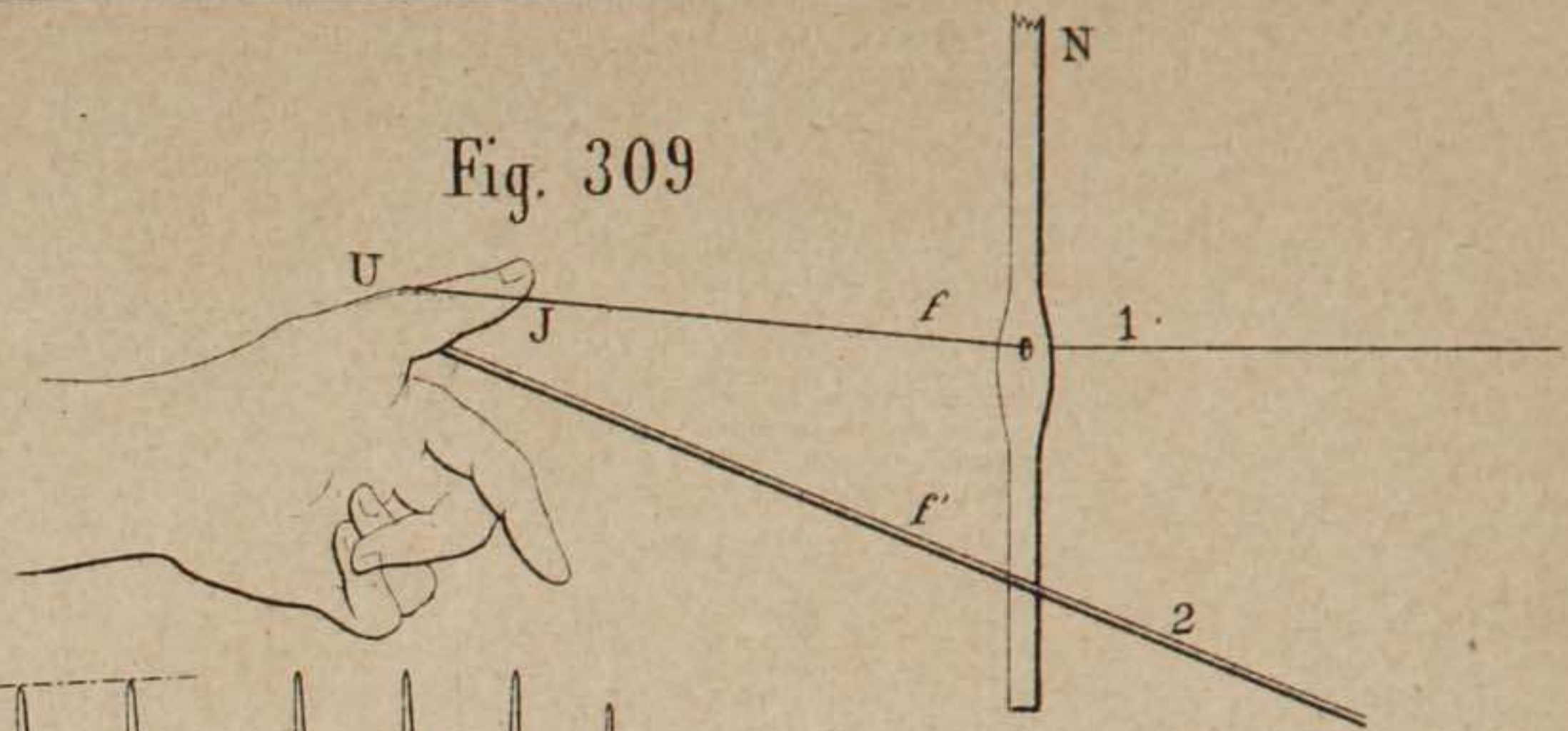


Fig. 299

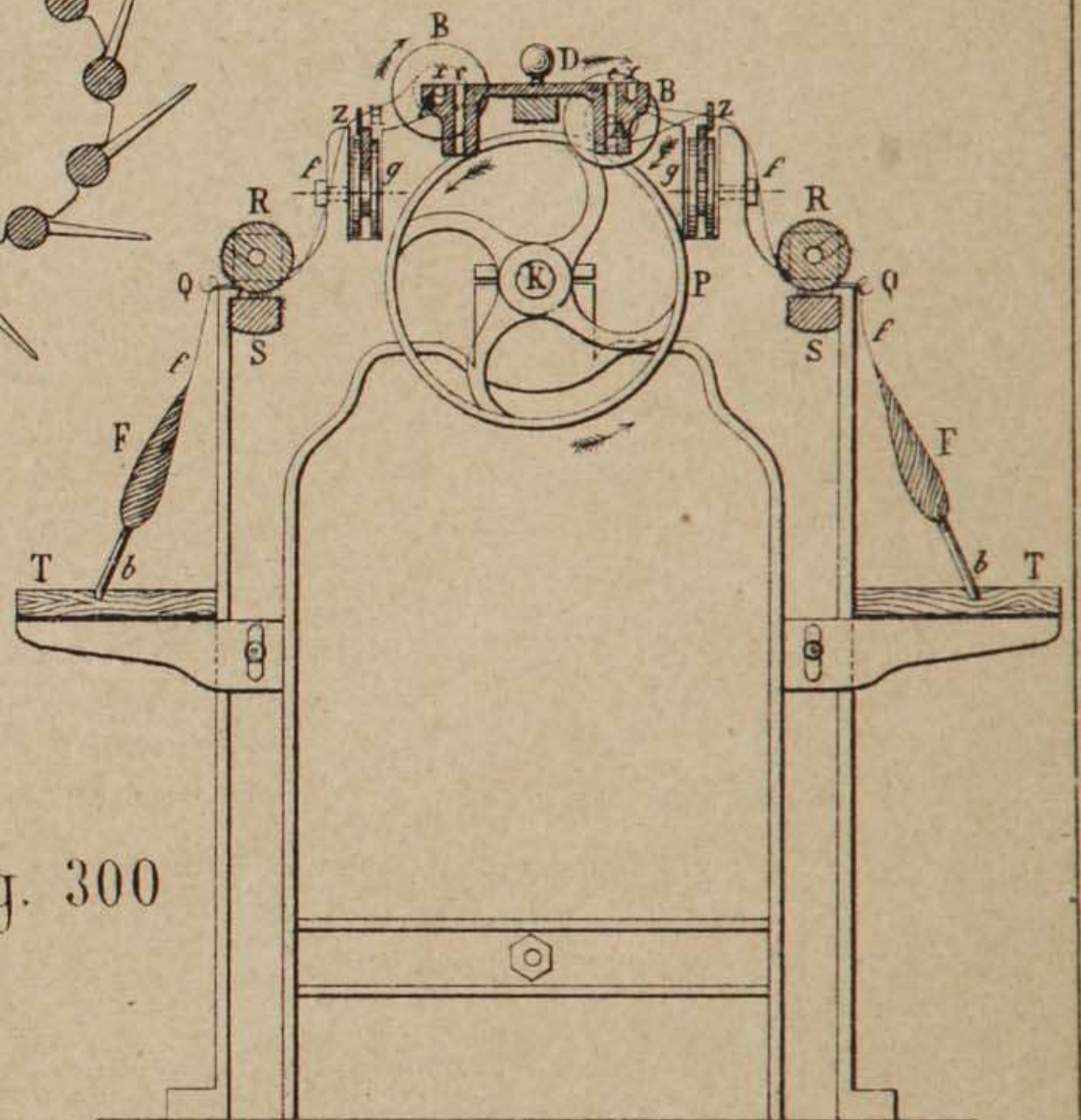
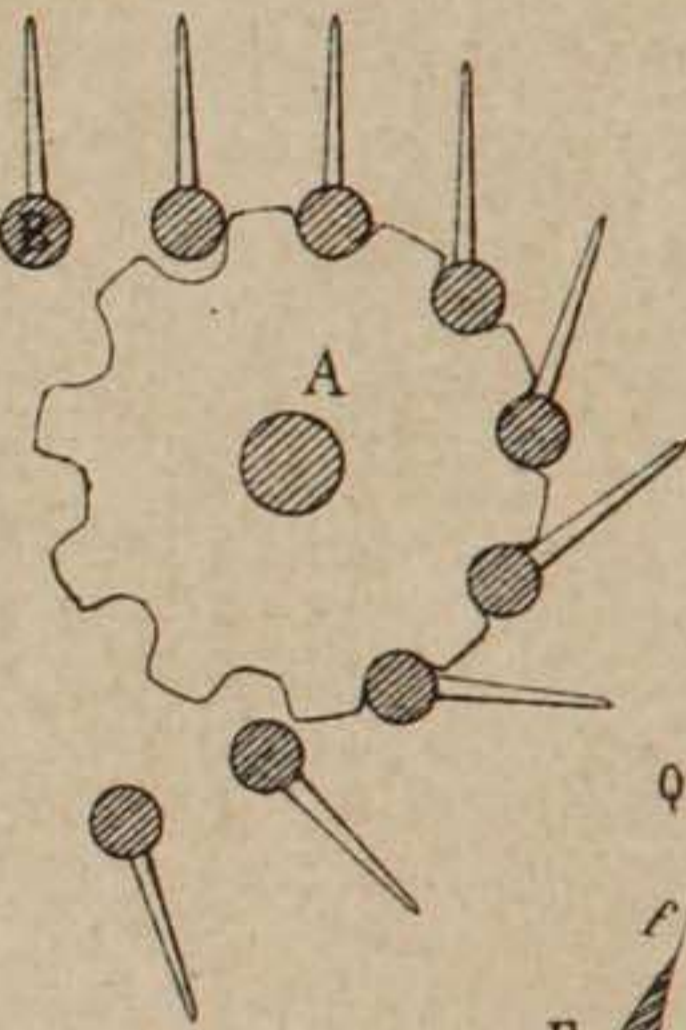


Fig. 300

Fig. 306

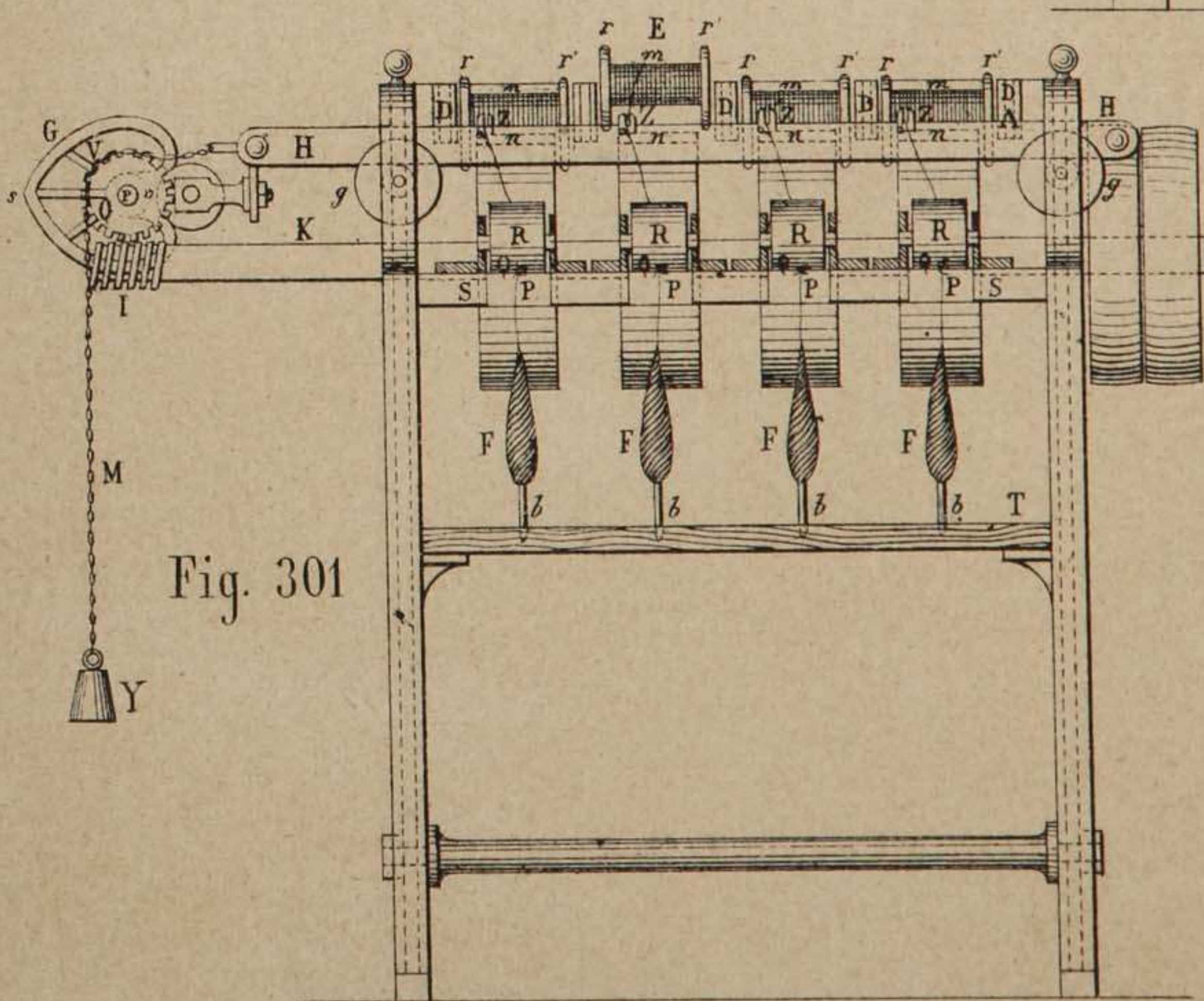
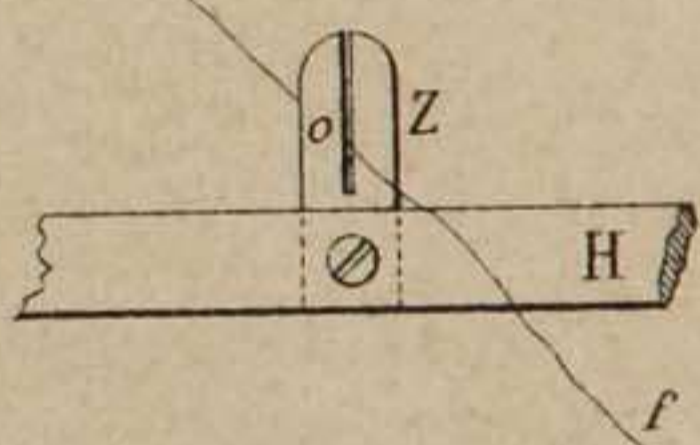


Fig. 301

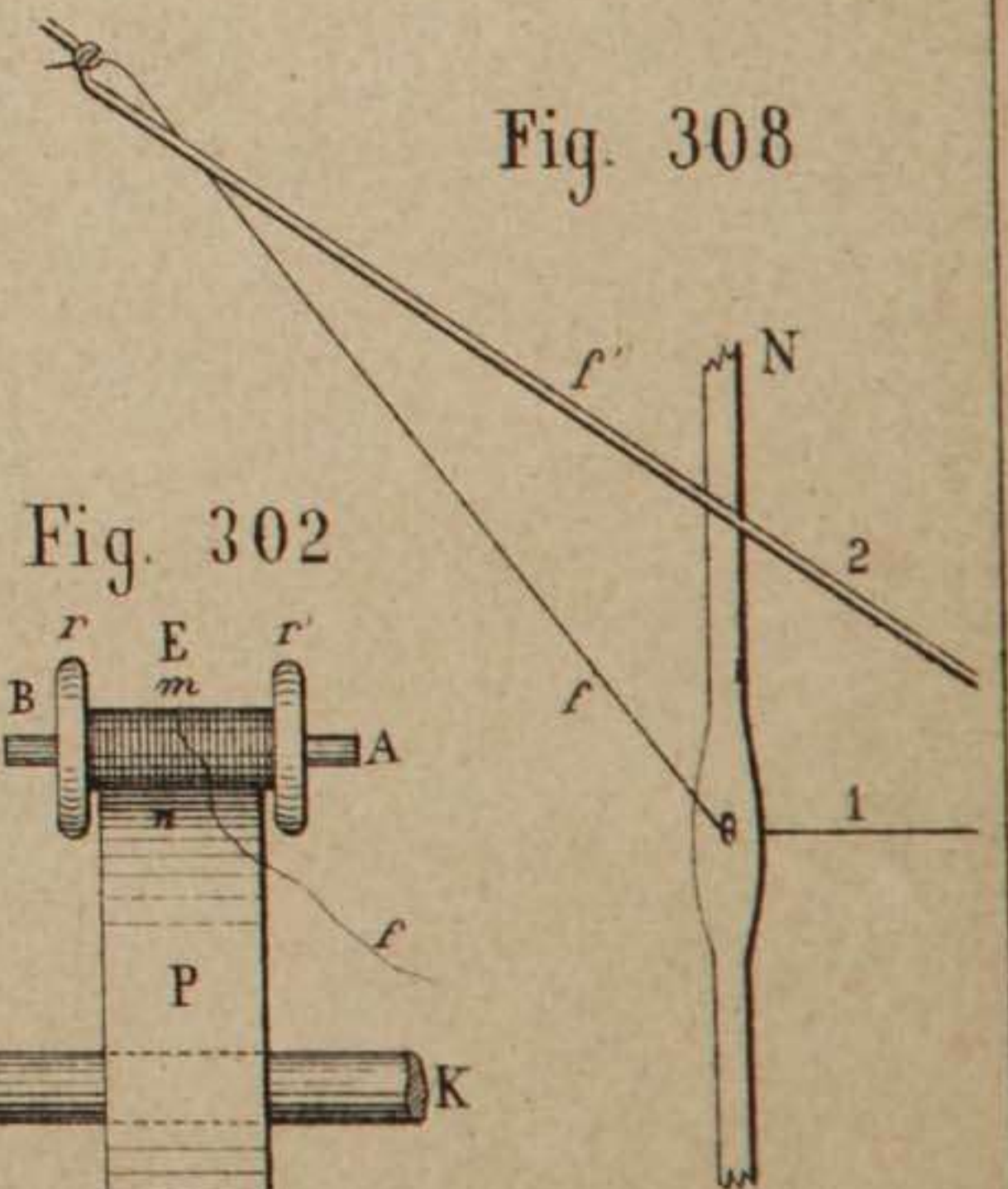


Fig. 308

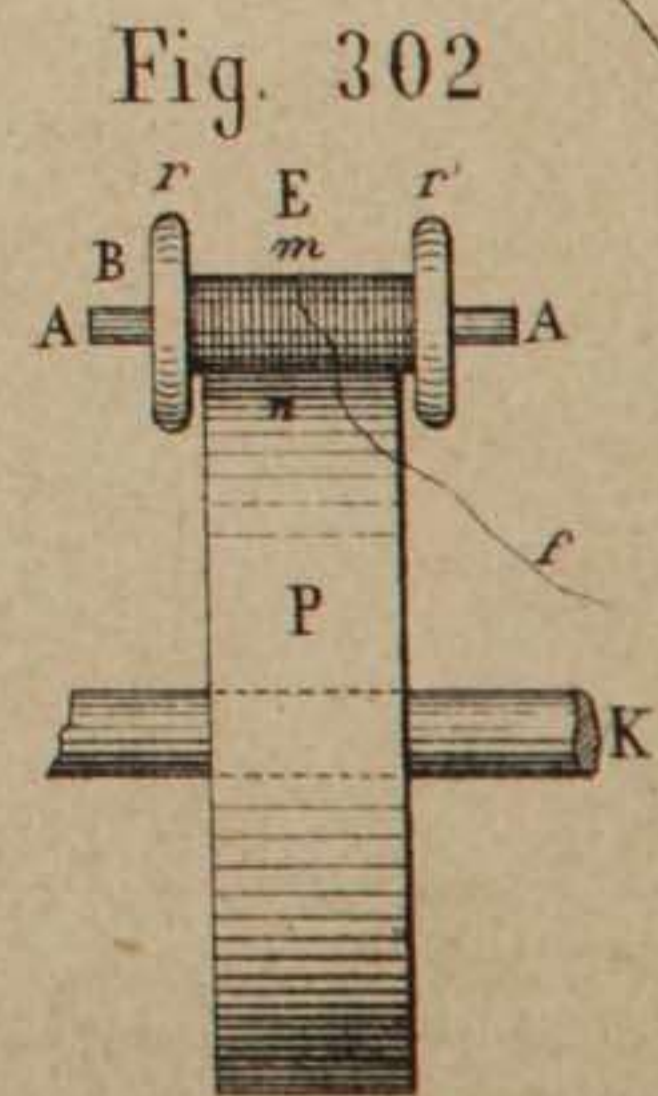


Fig. 302

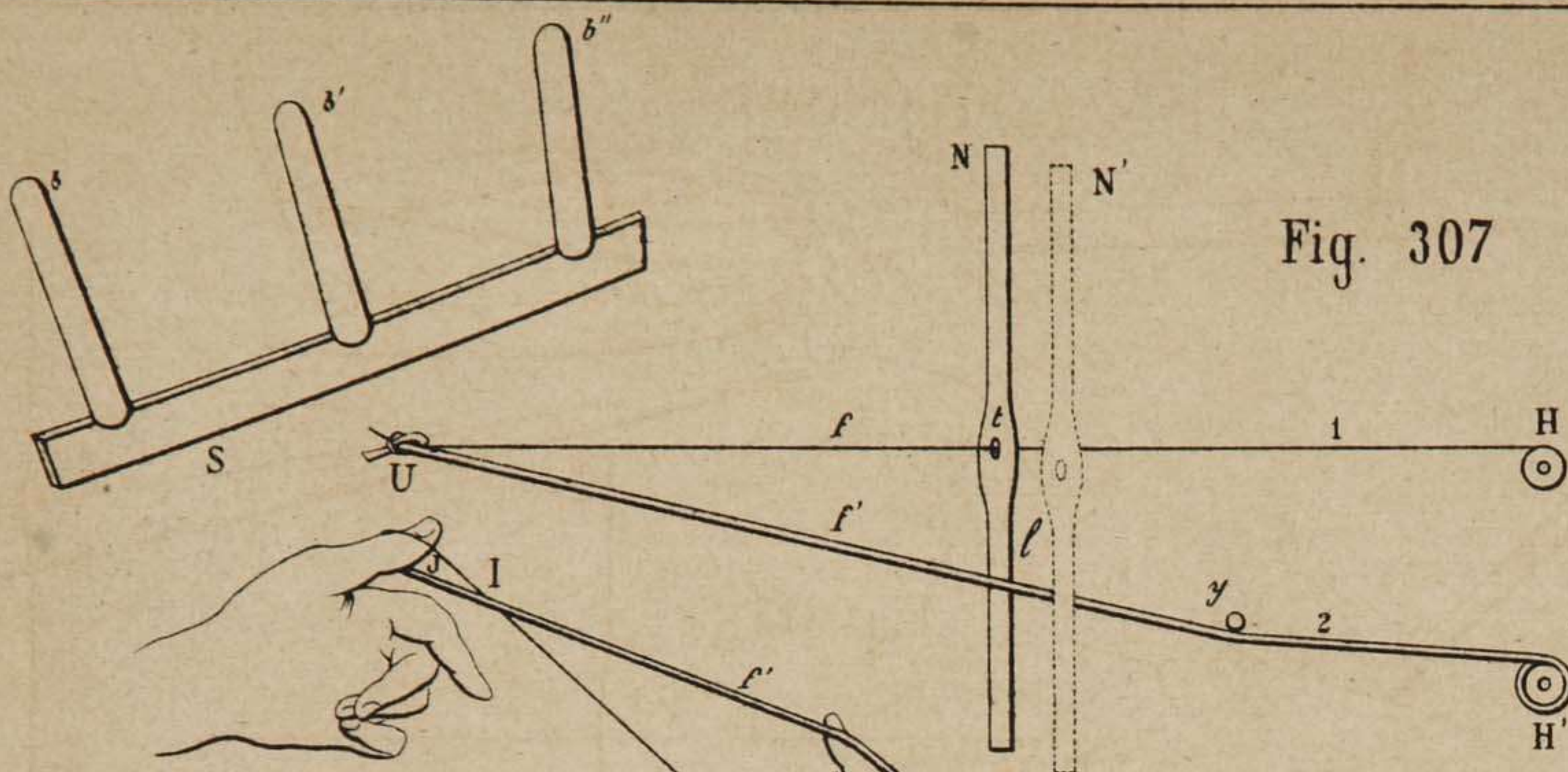


Fig. 310

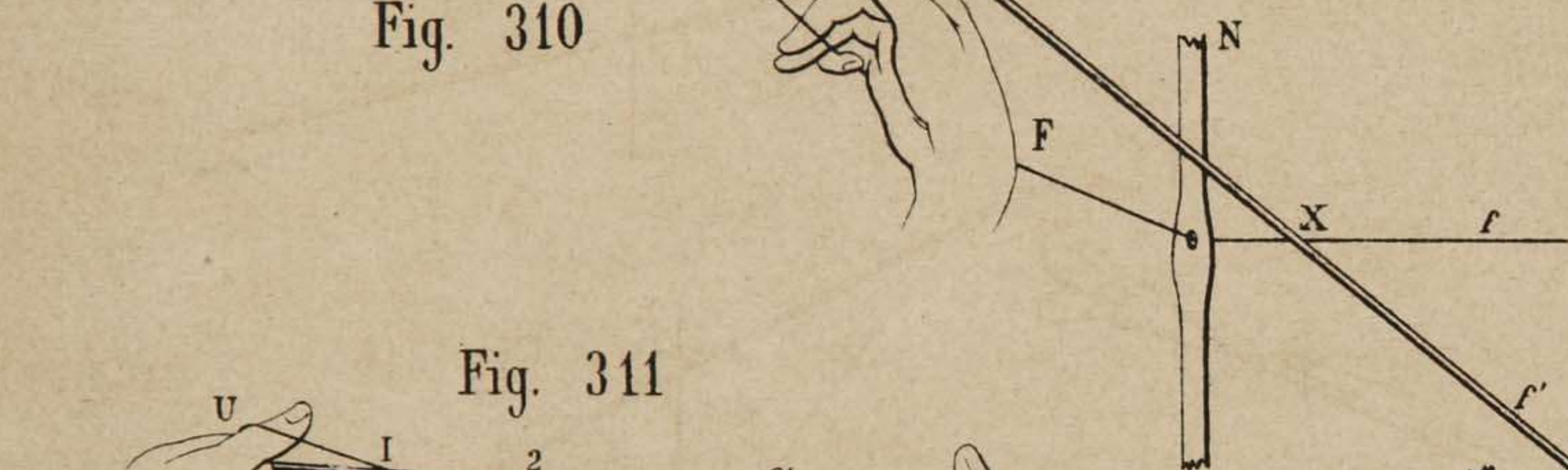


Fig. 311

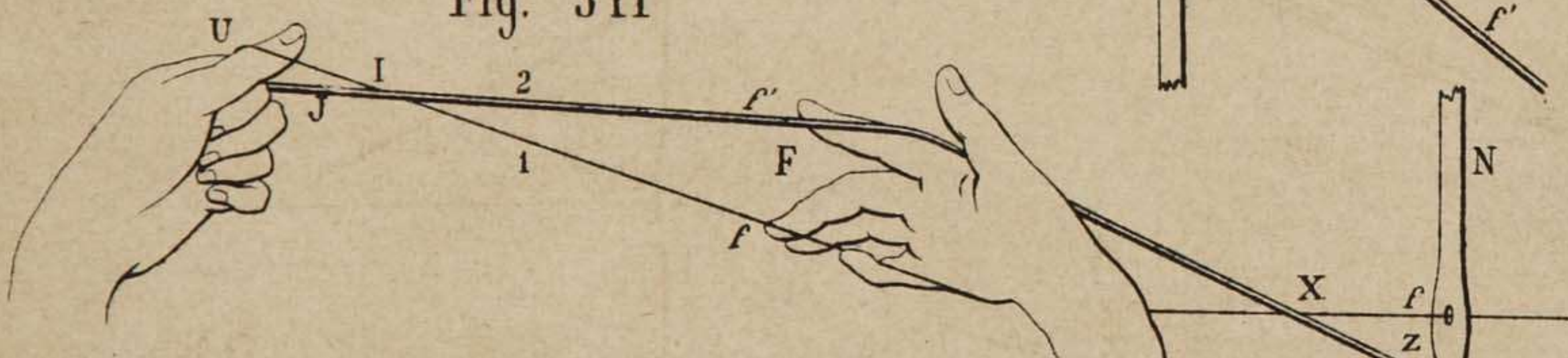


Fig. 312

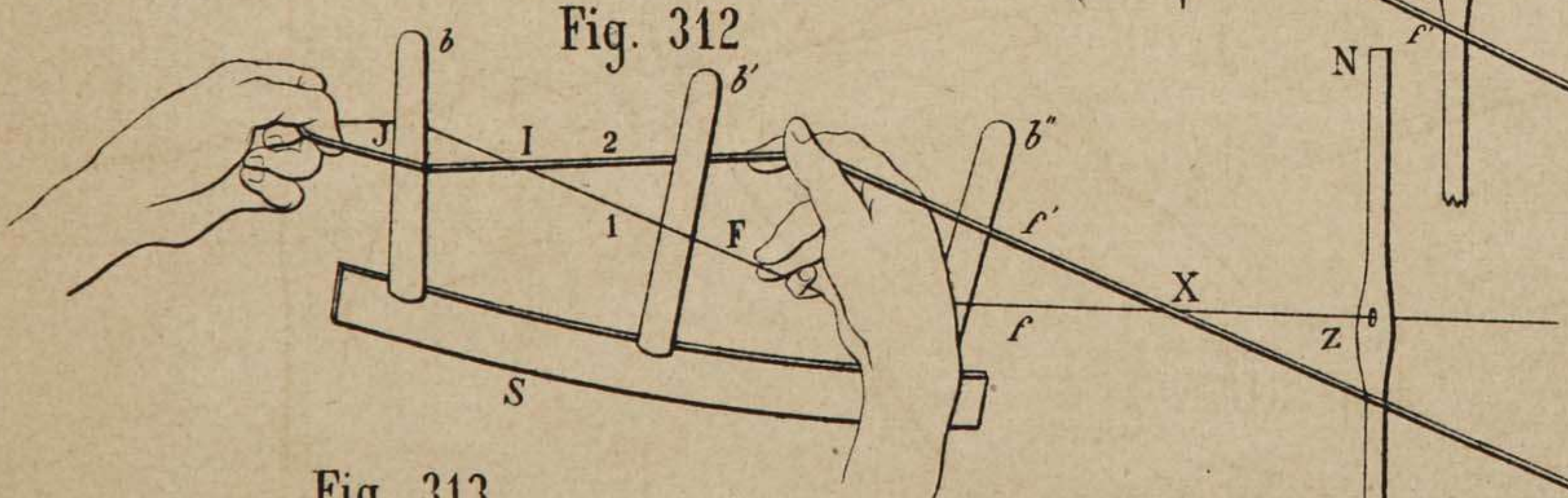


Fig. 313

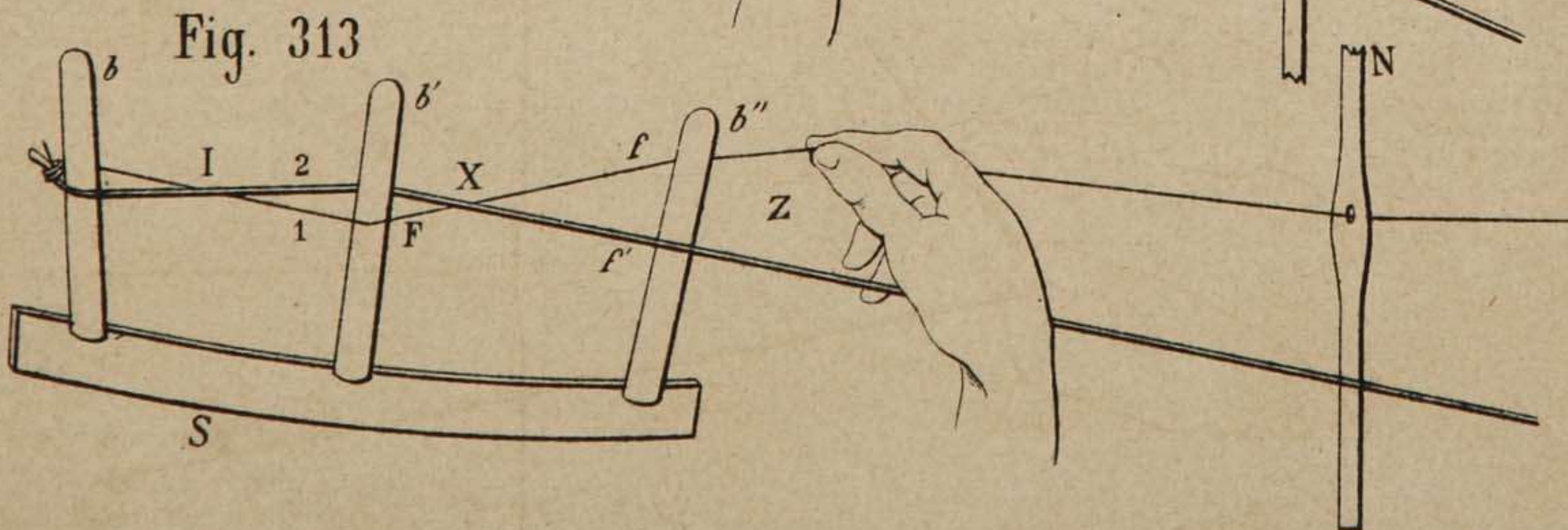


Fig. 314

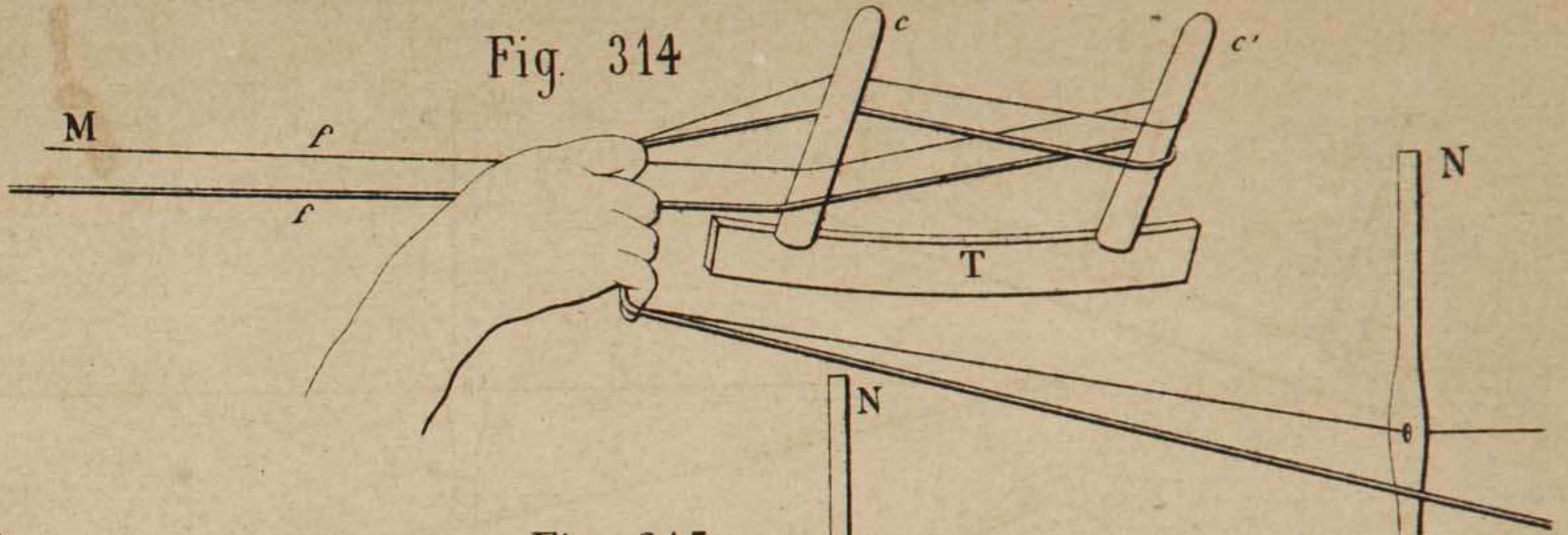


Fig. 315

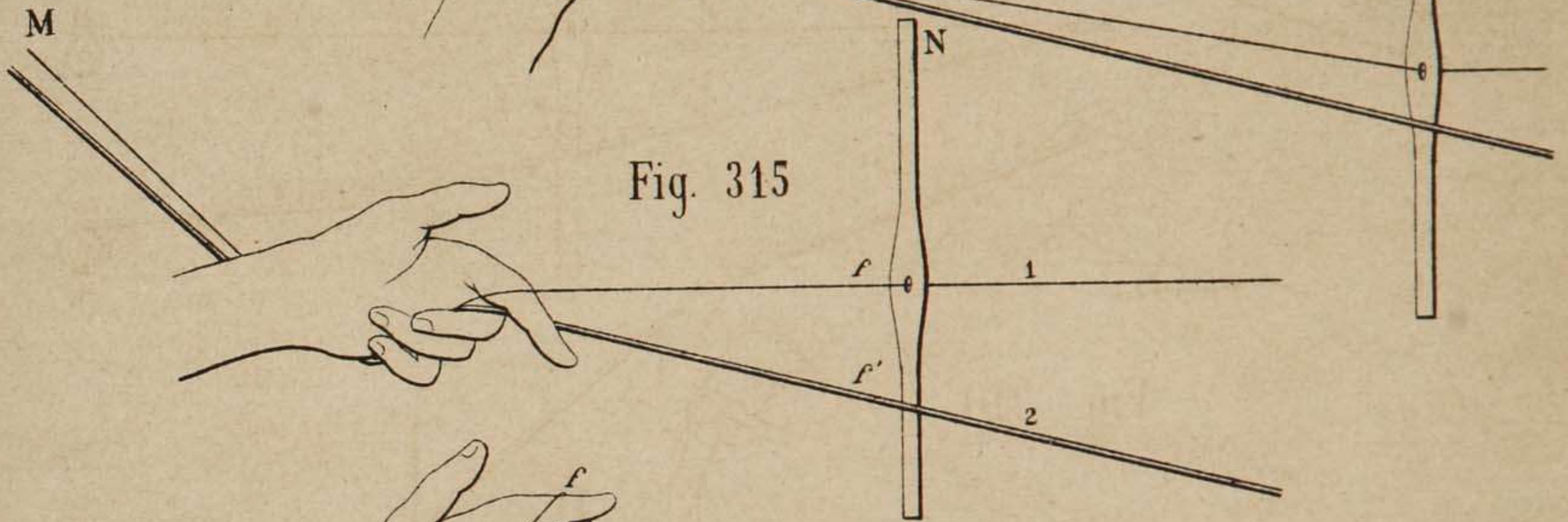


Fig. 316

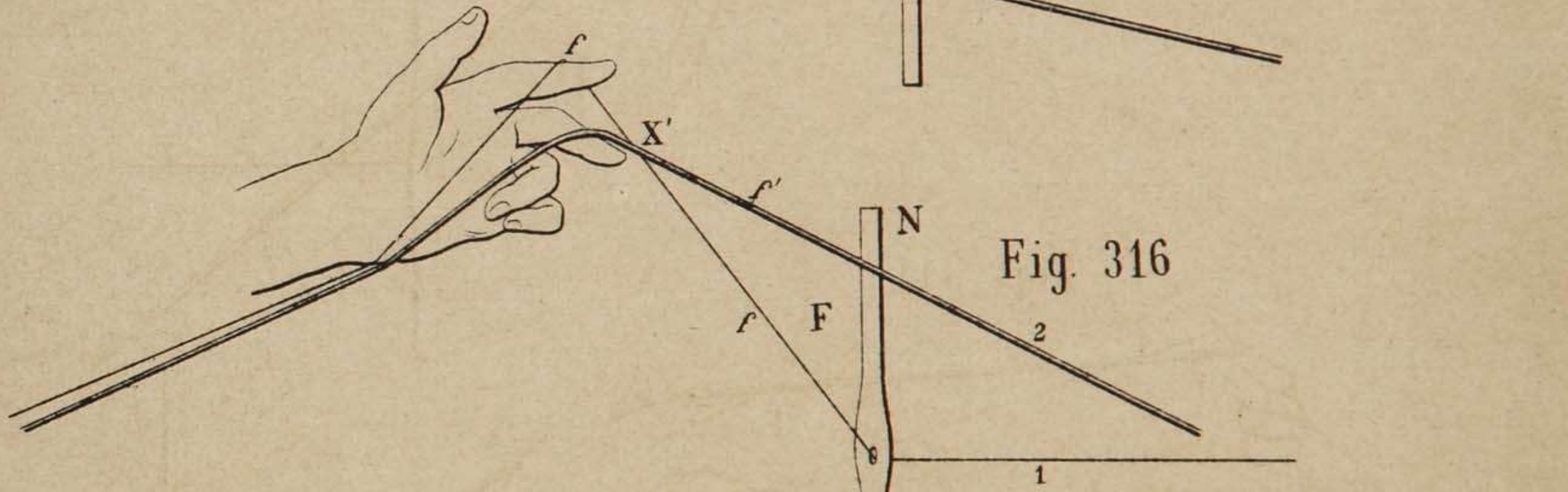


Fig. 317

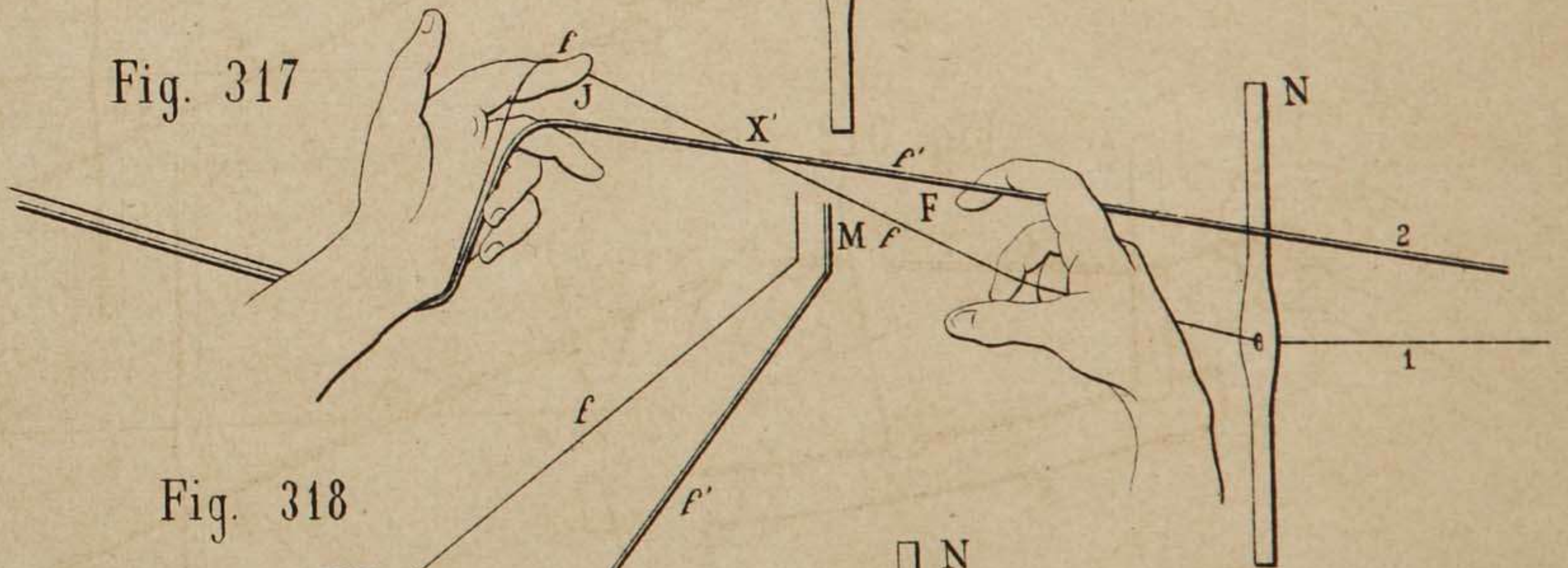
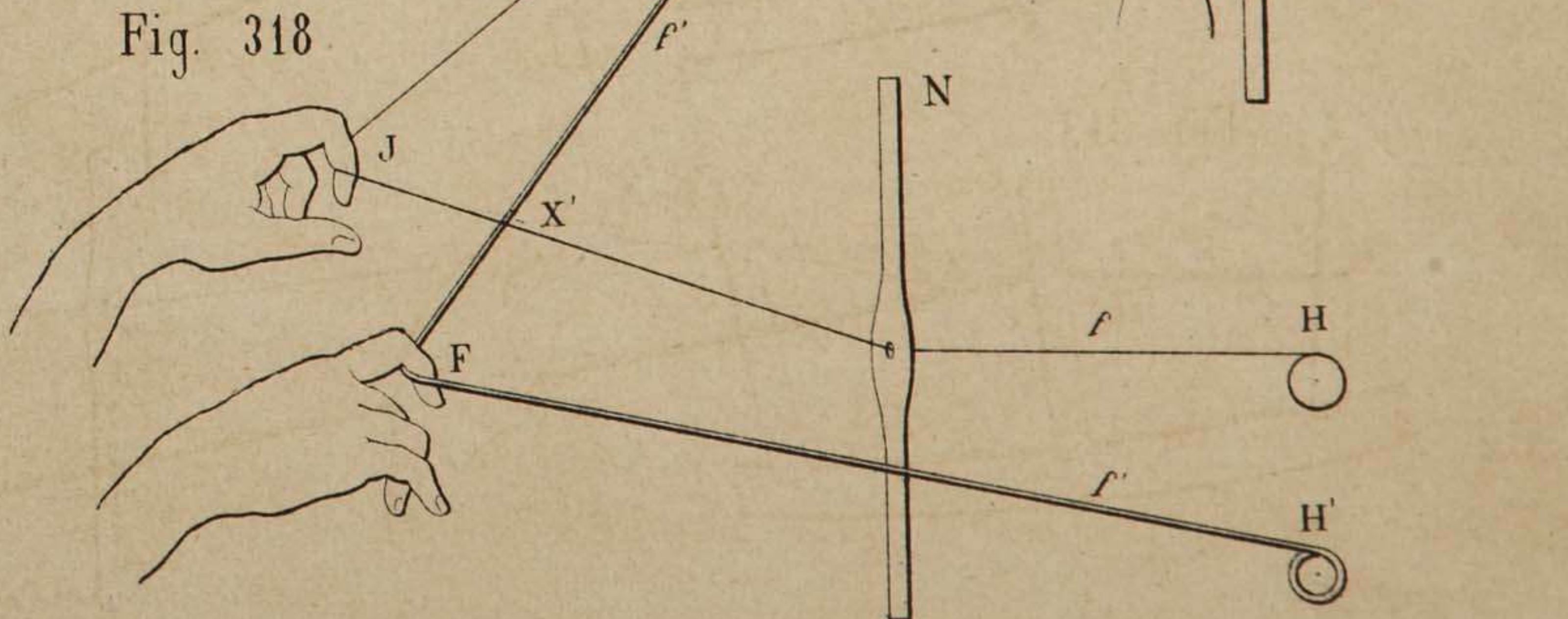


Fig. 318



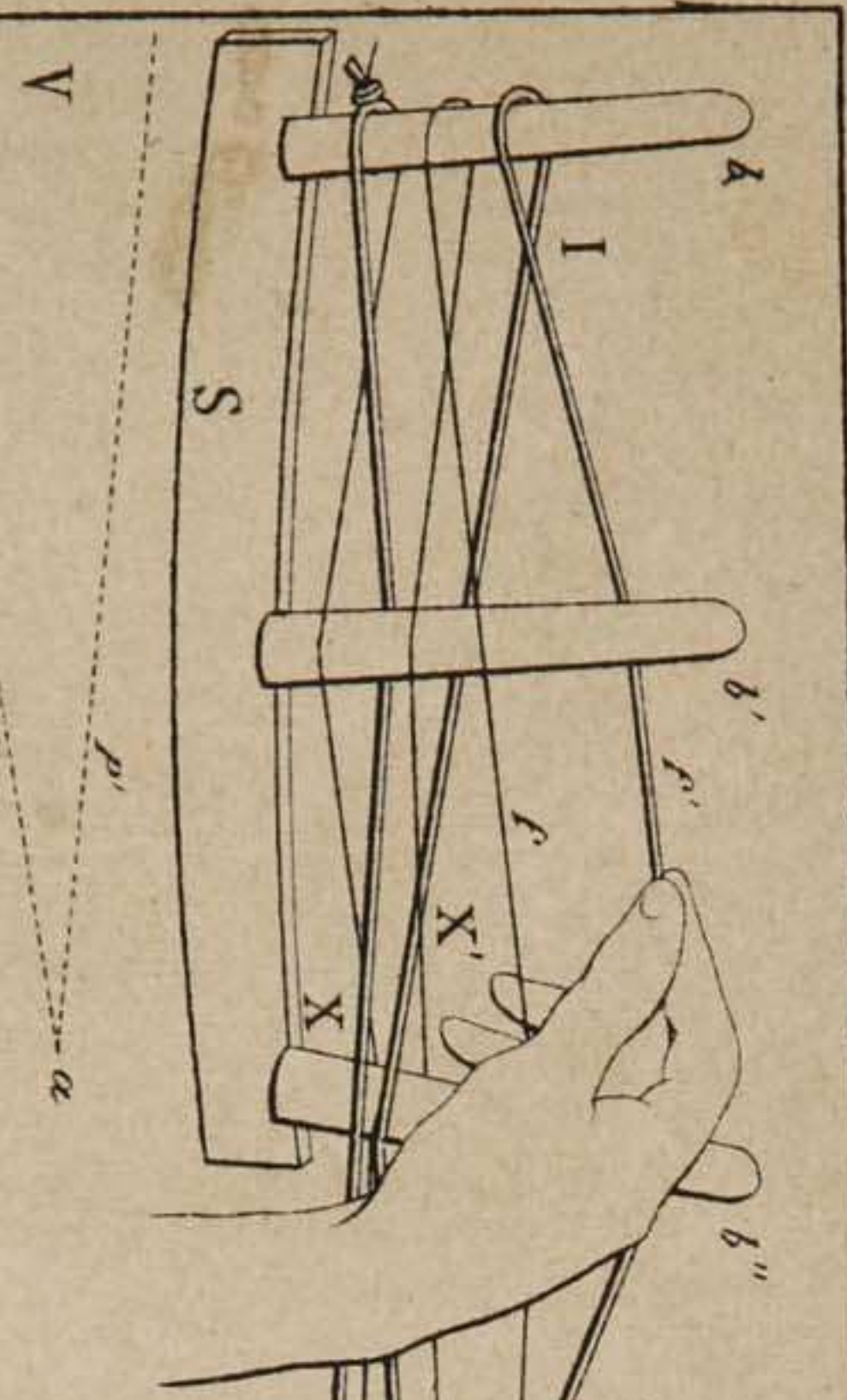


Fig. 320

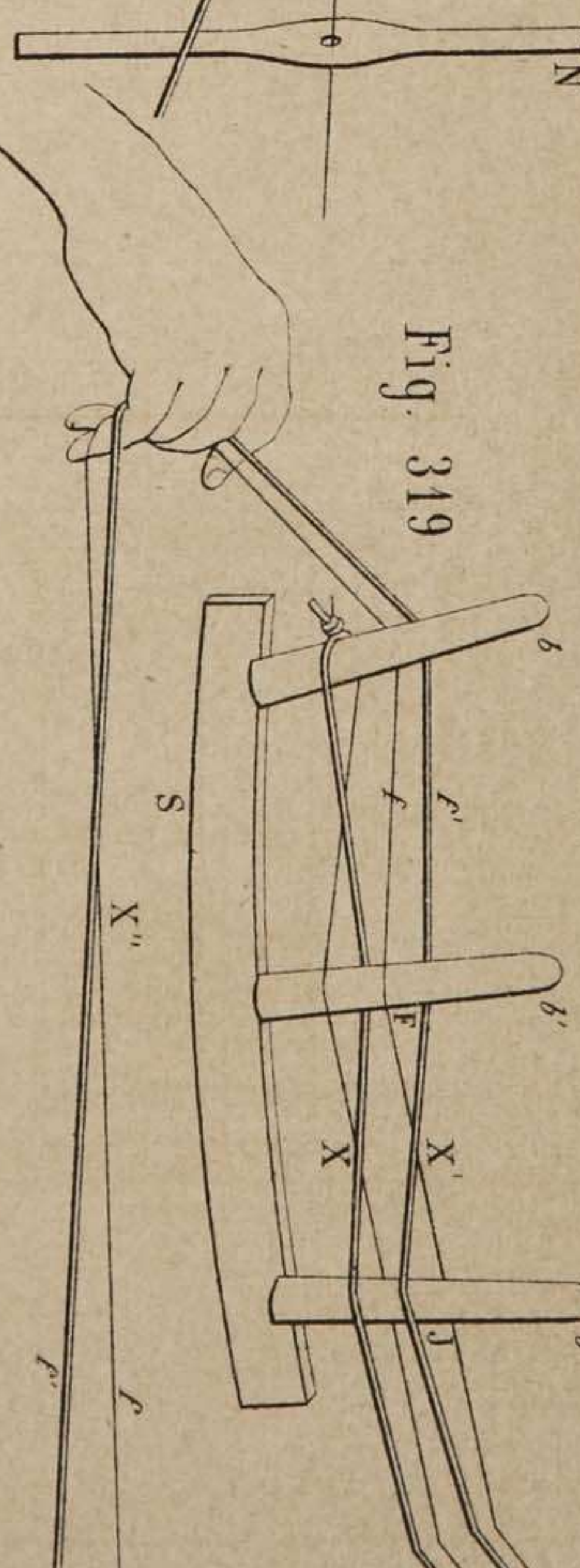


Fig. 319

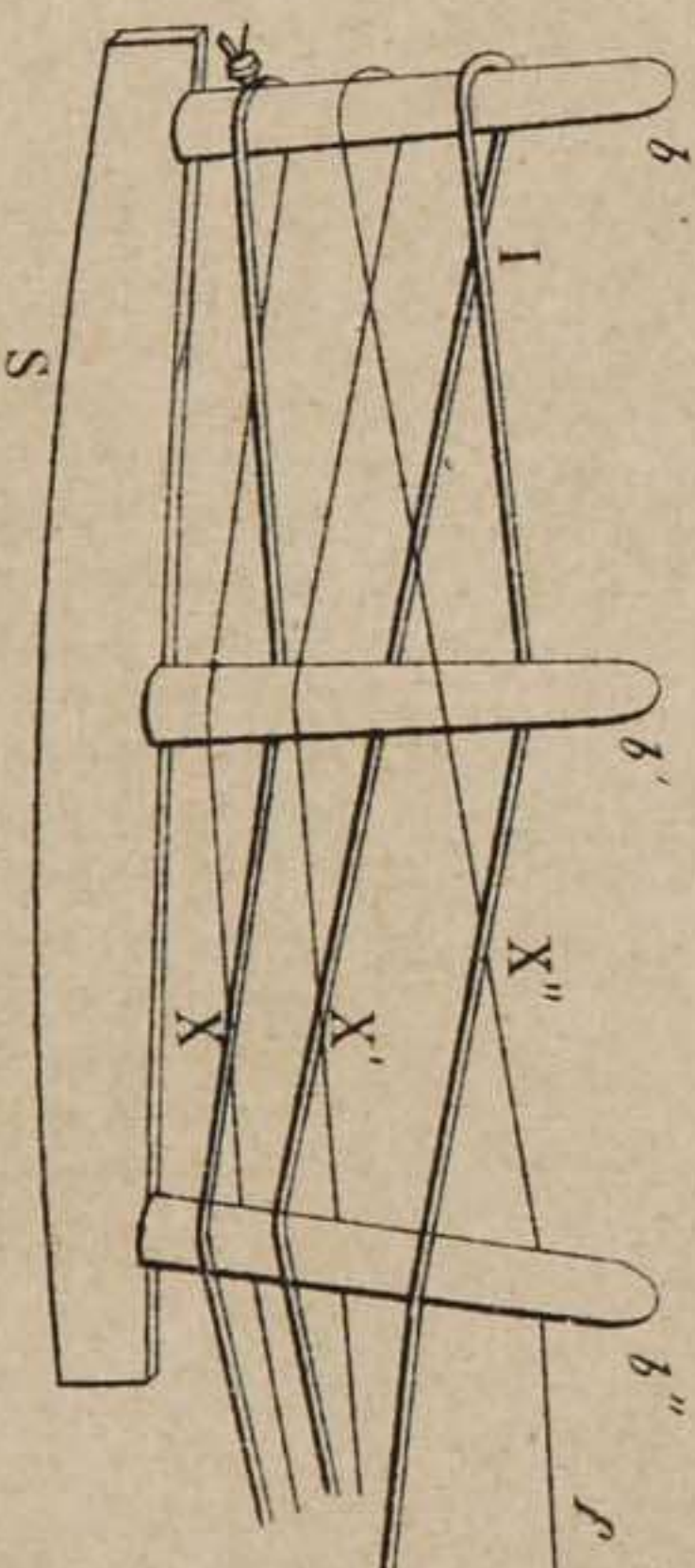


Fig. 321

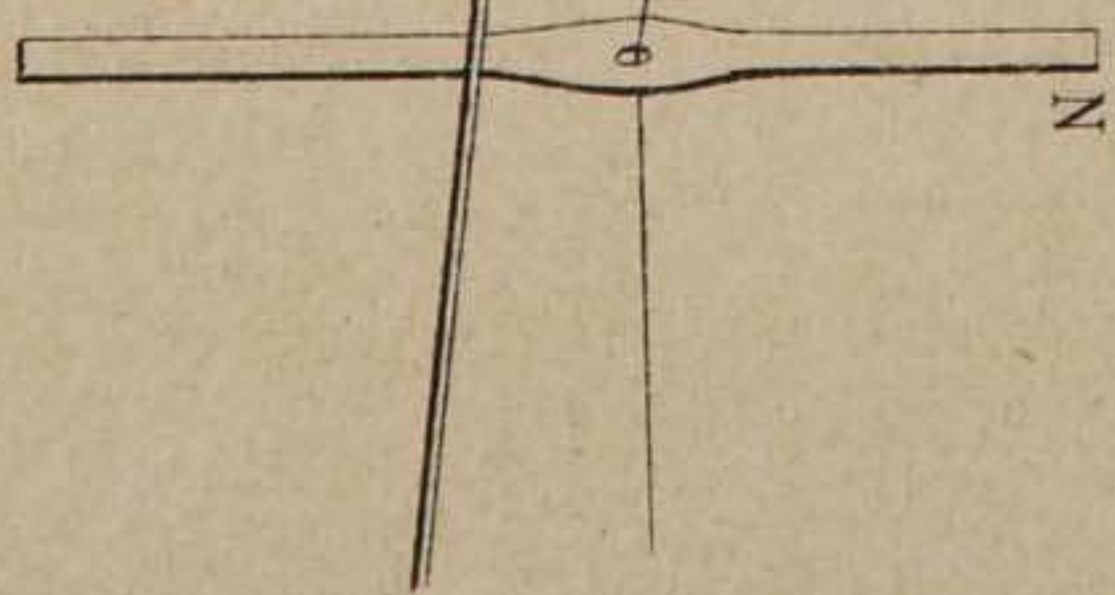


Fig. 323

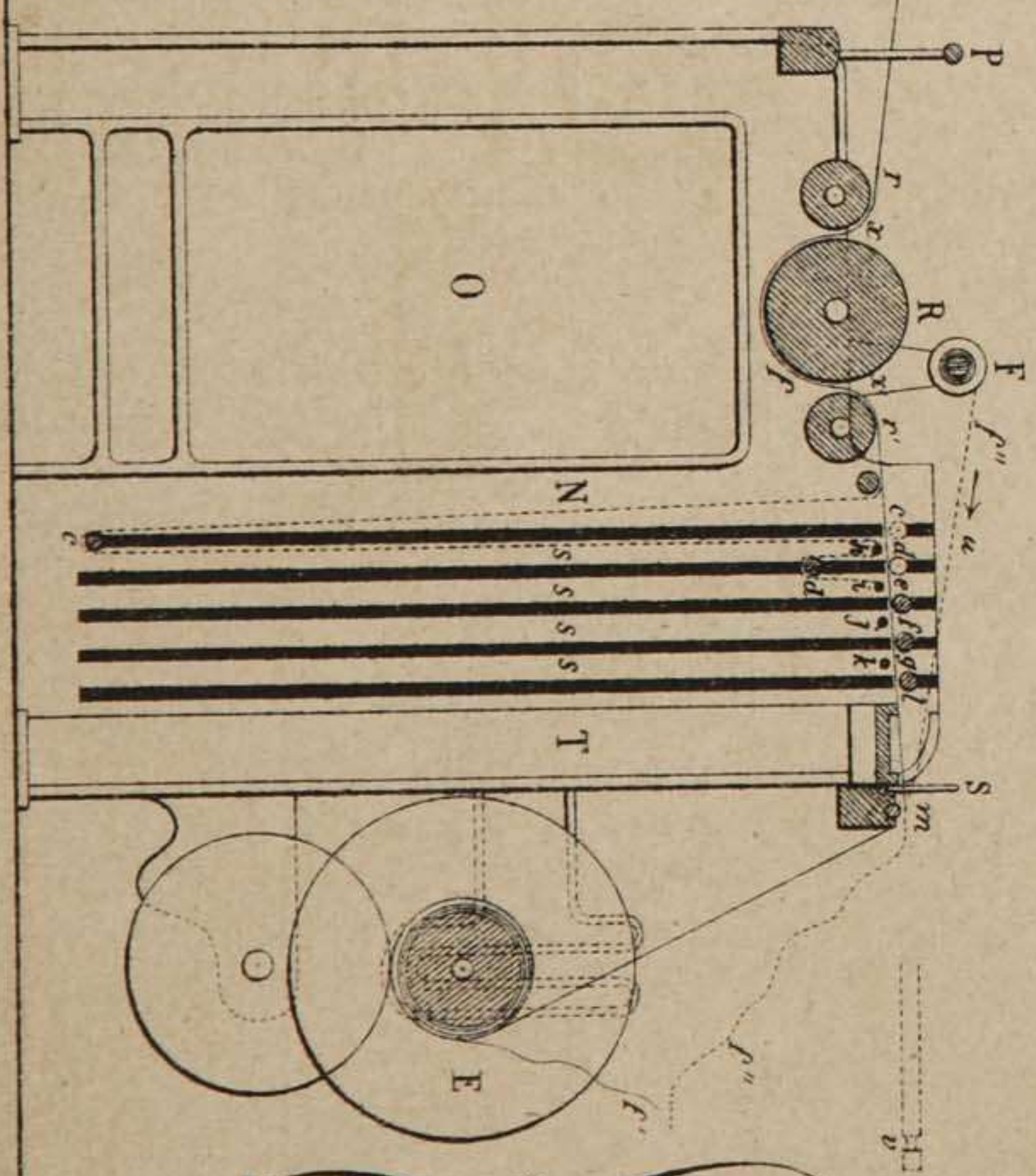


Fig. 328

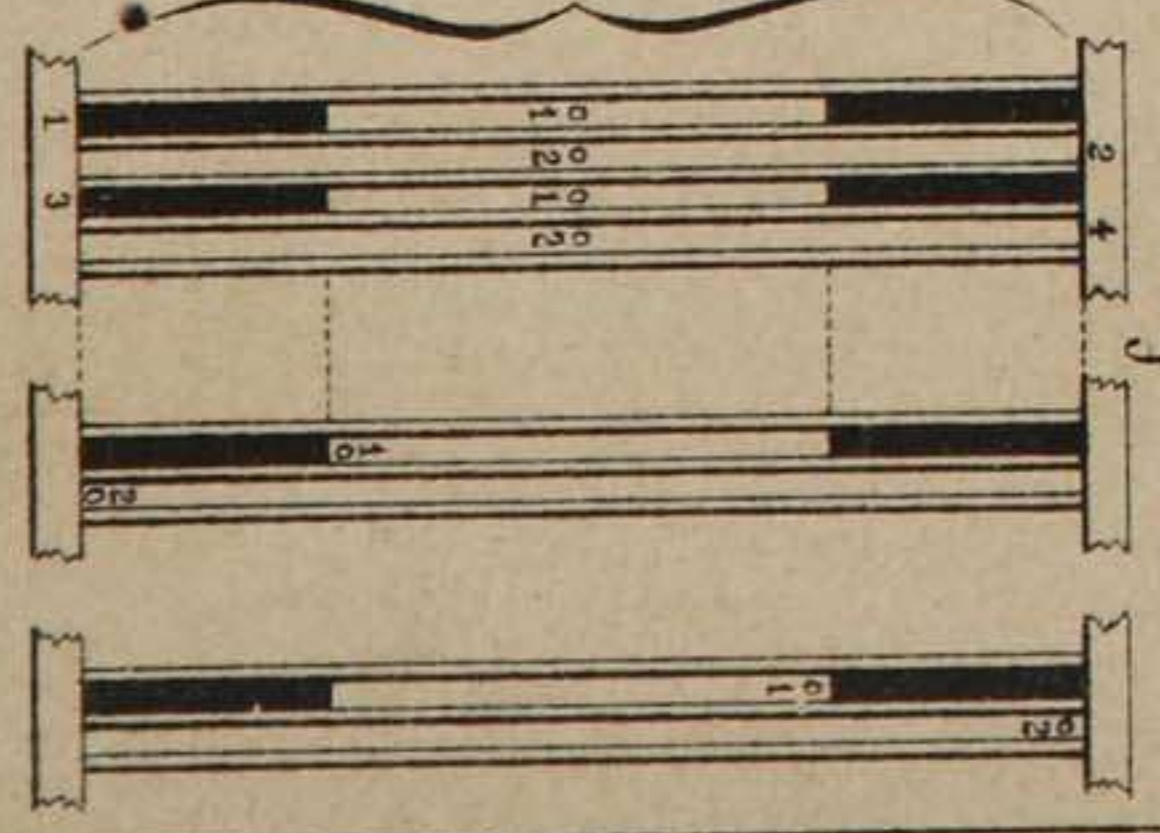


Fig. 322

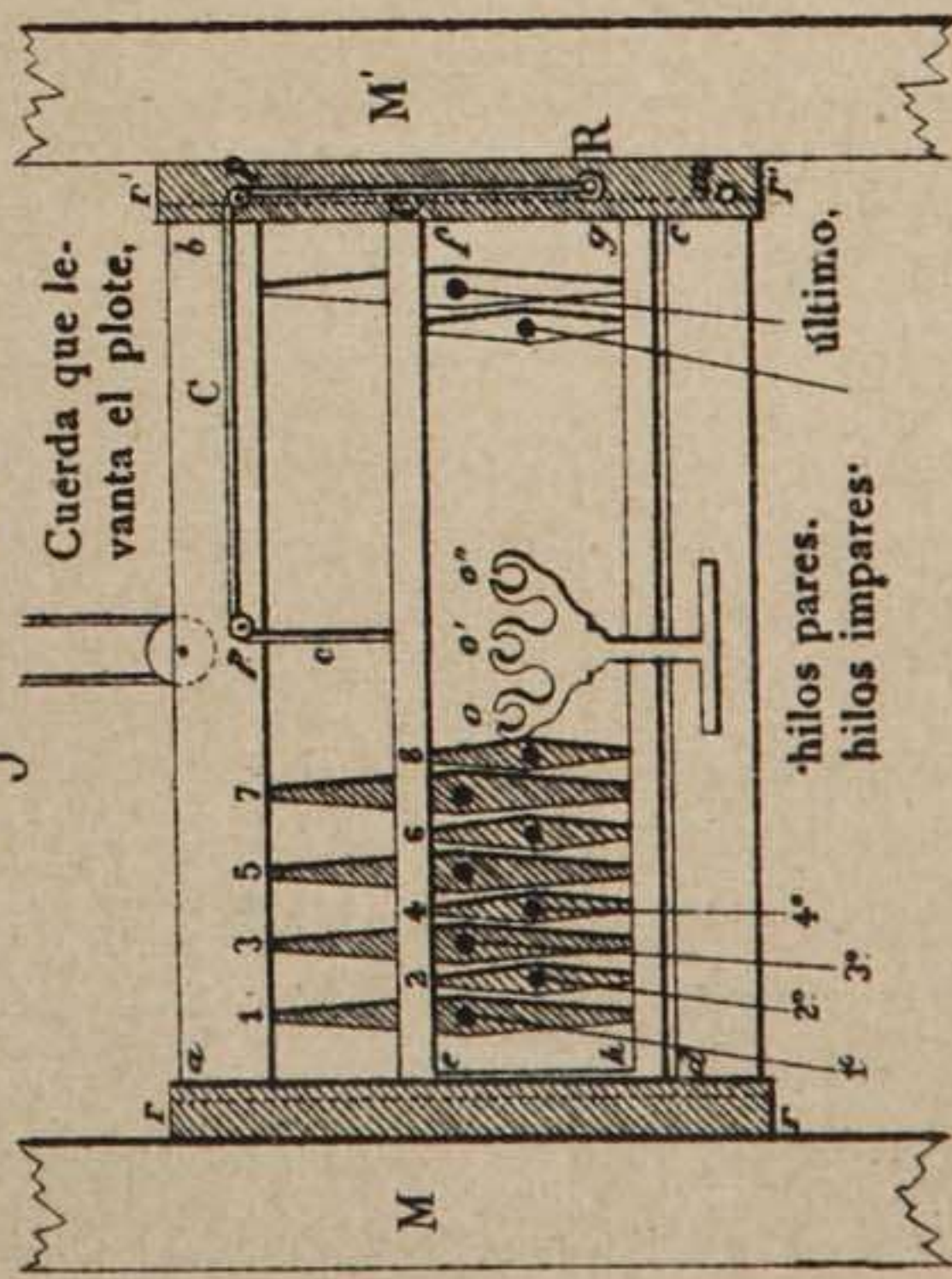


Fig. 326

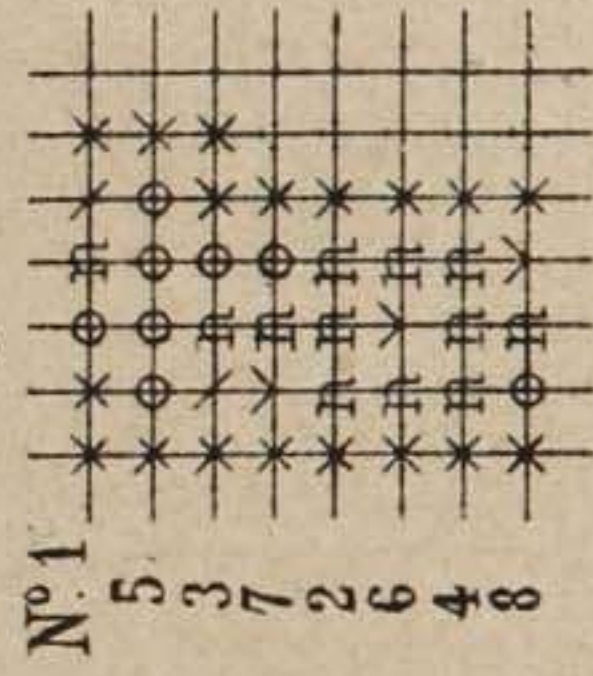


Fig. 324

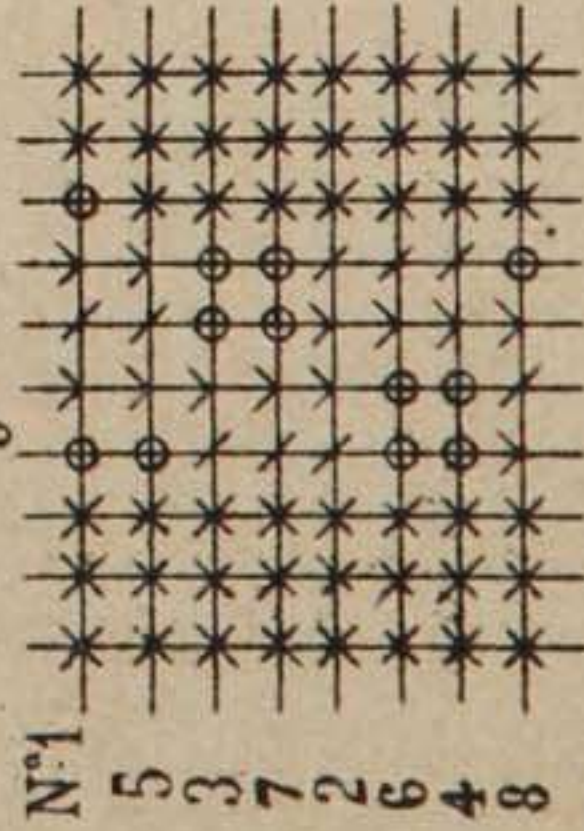


Fig. 325

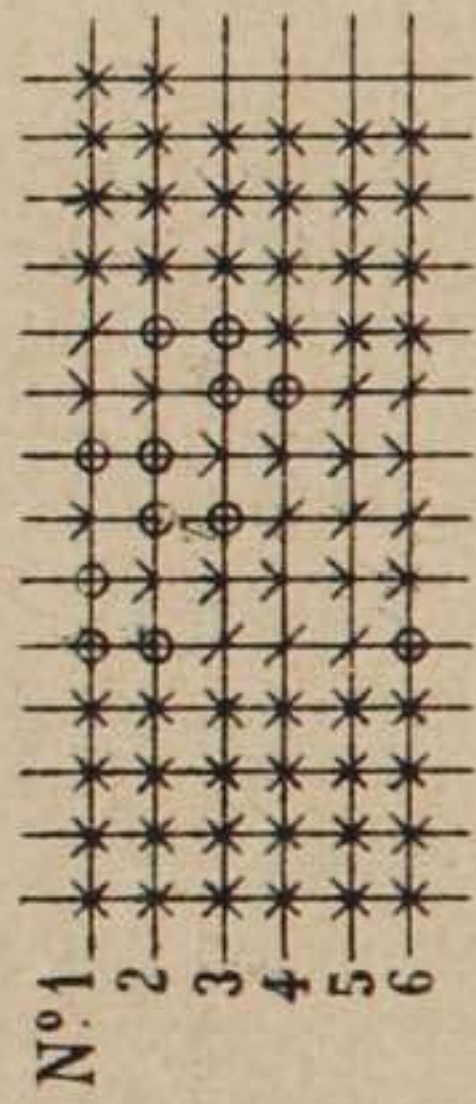


Fig. 329

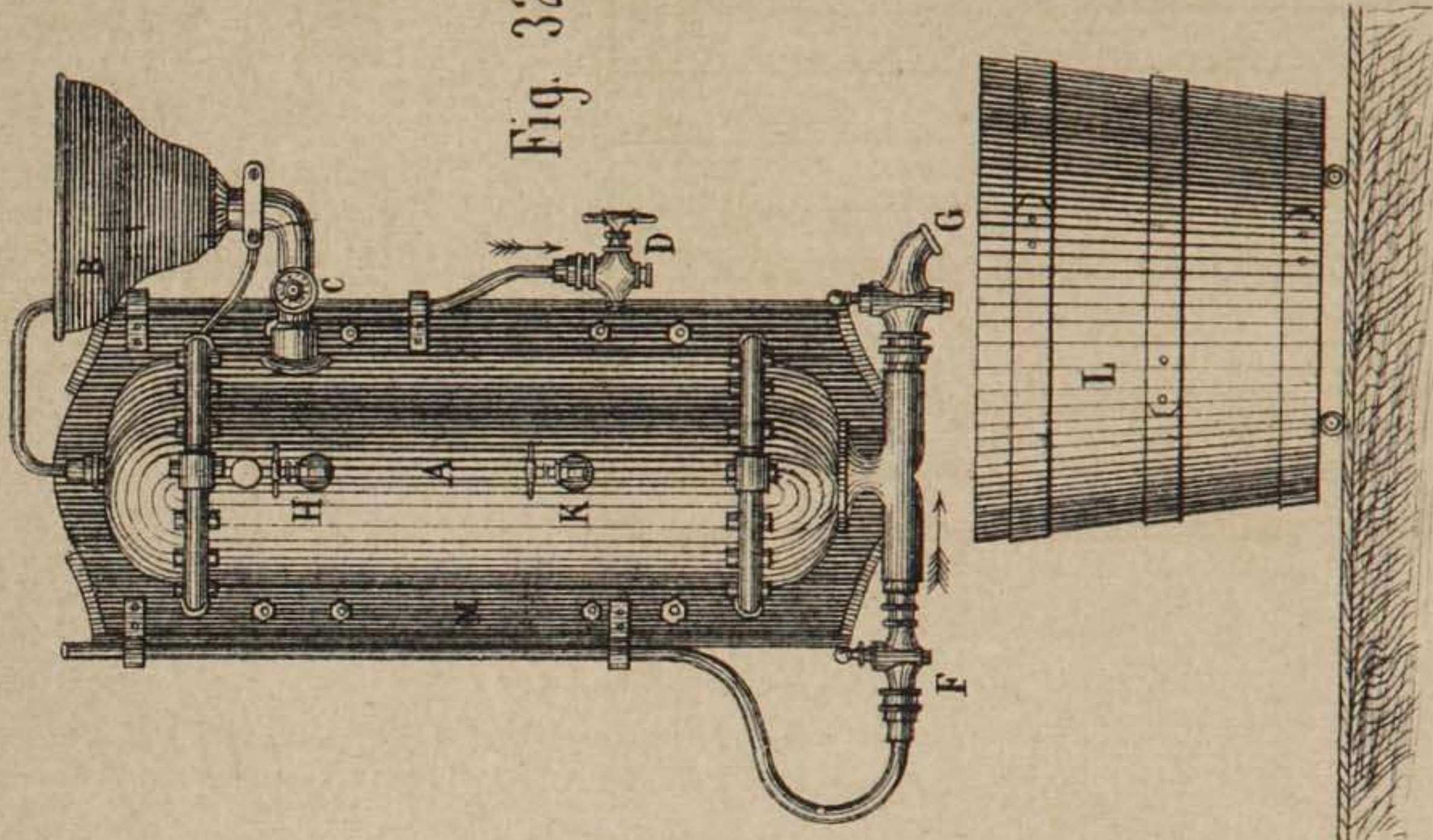
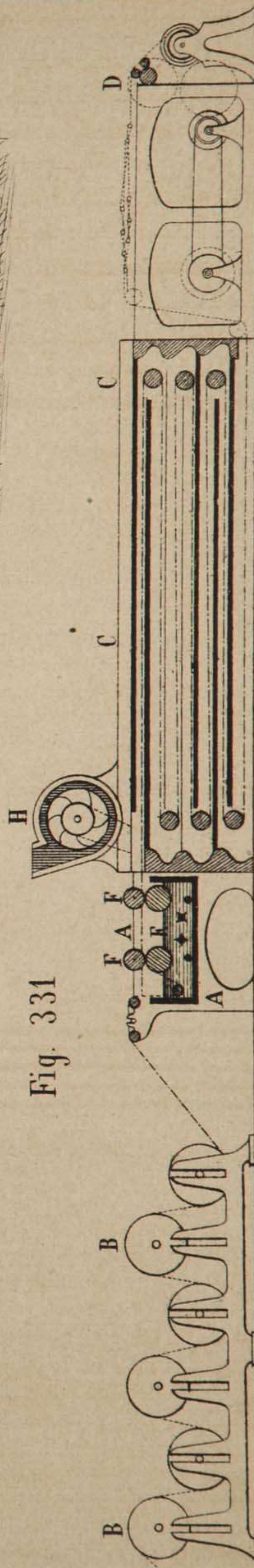


Fig. 331



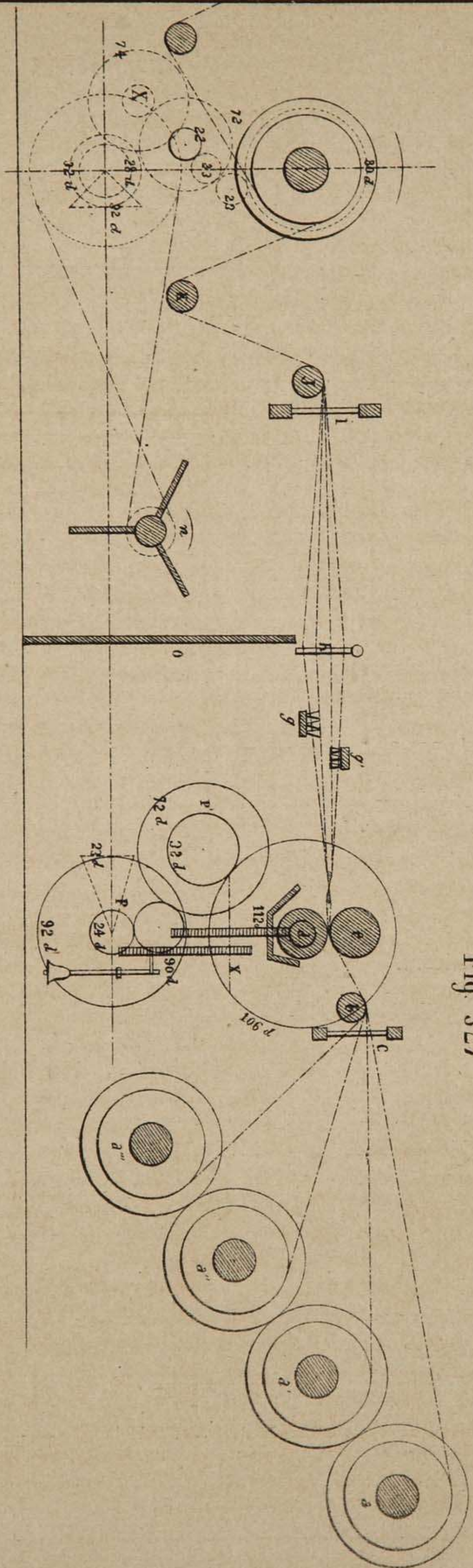


Fig. 327

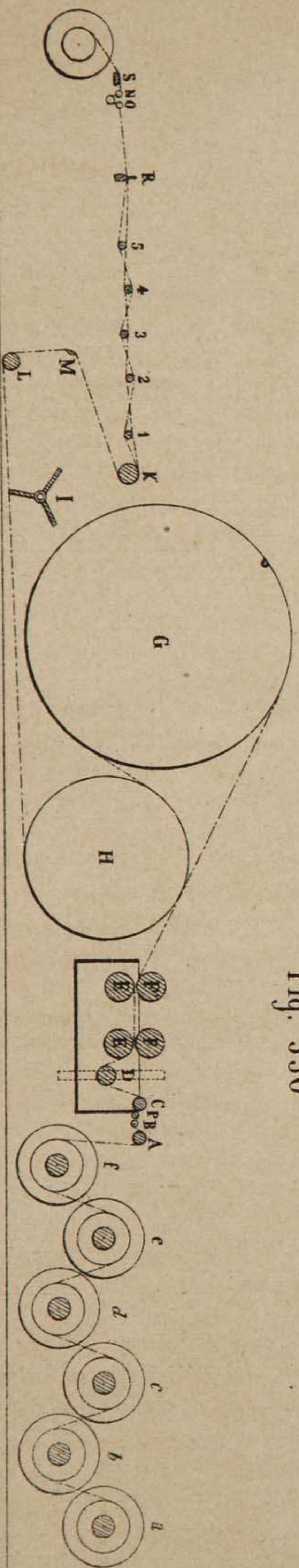


Fig. 330

Fig. 215.

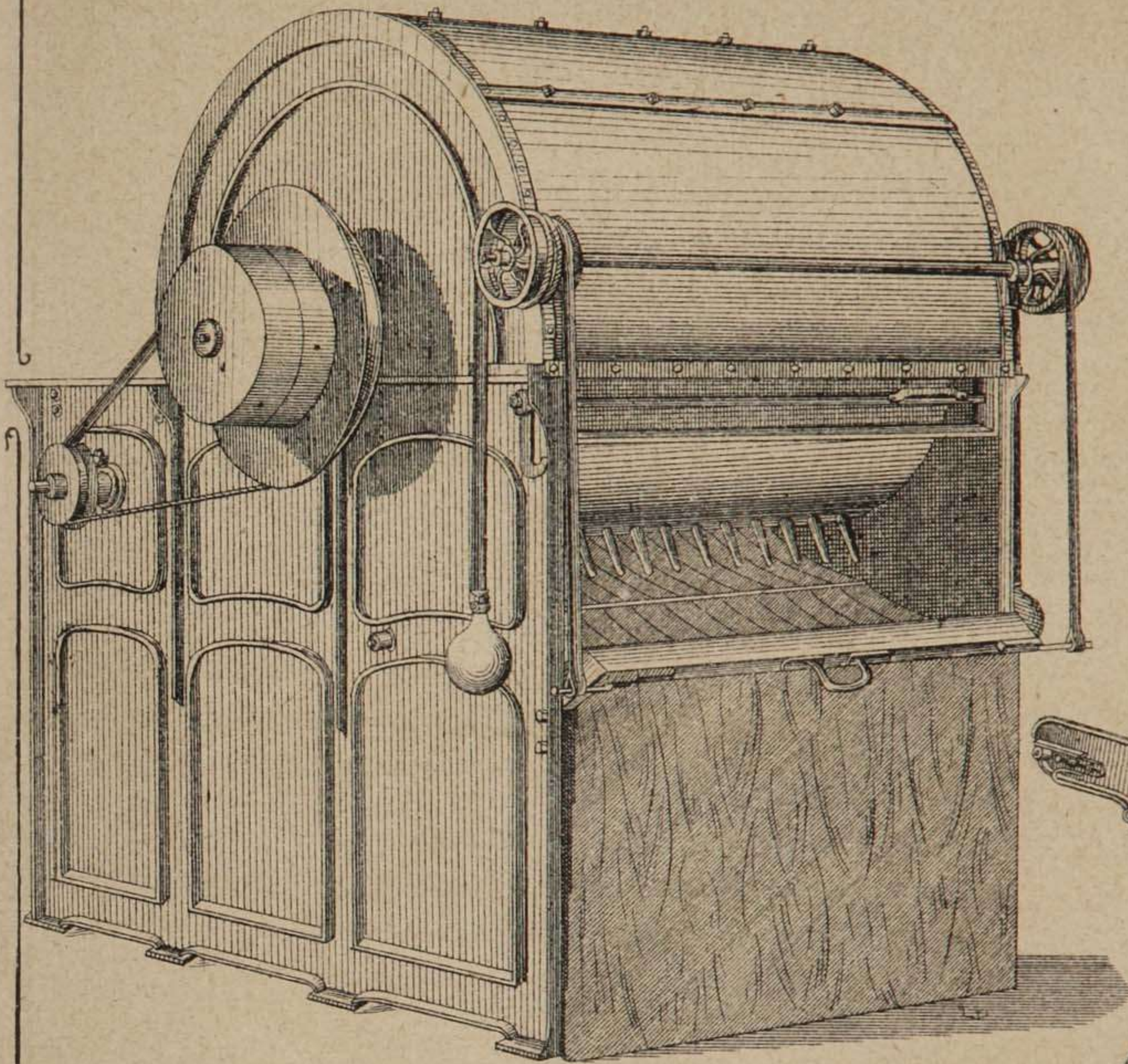


Fig. 217.

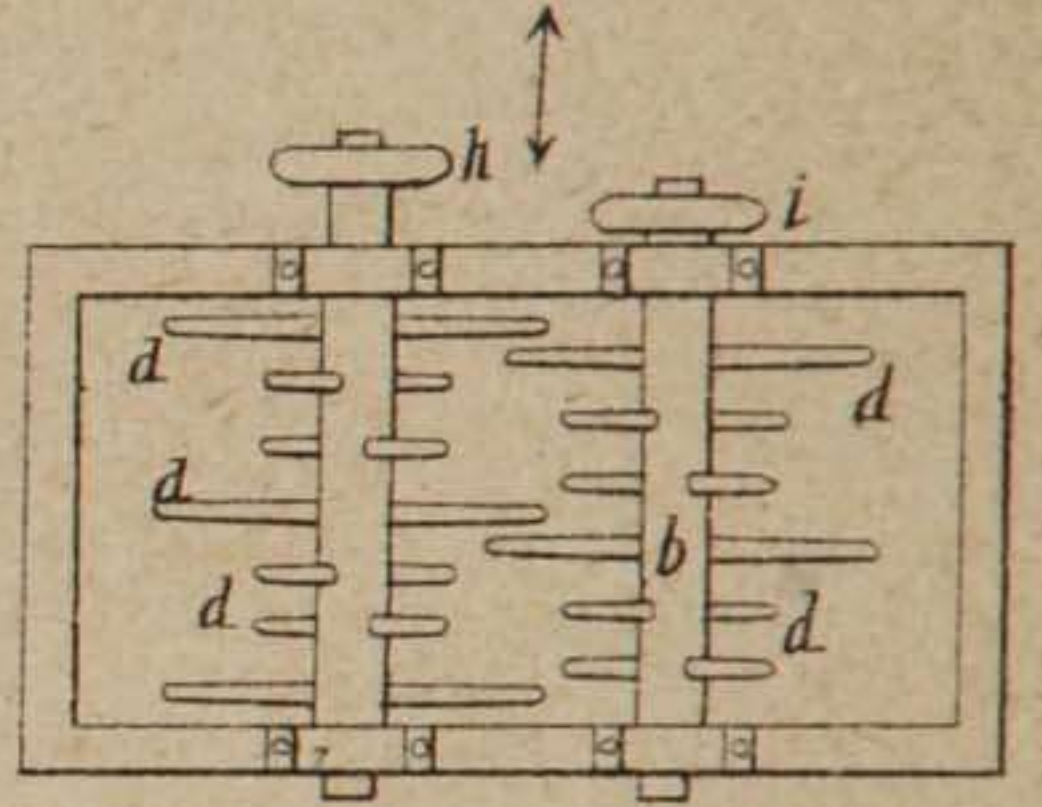
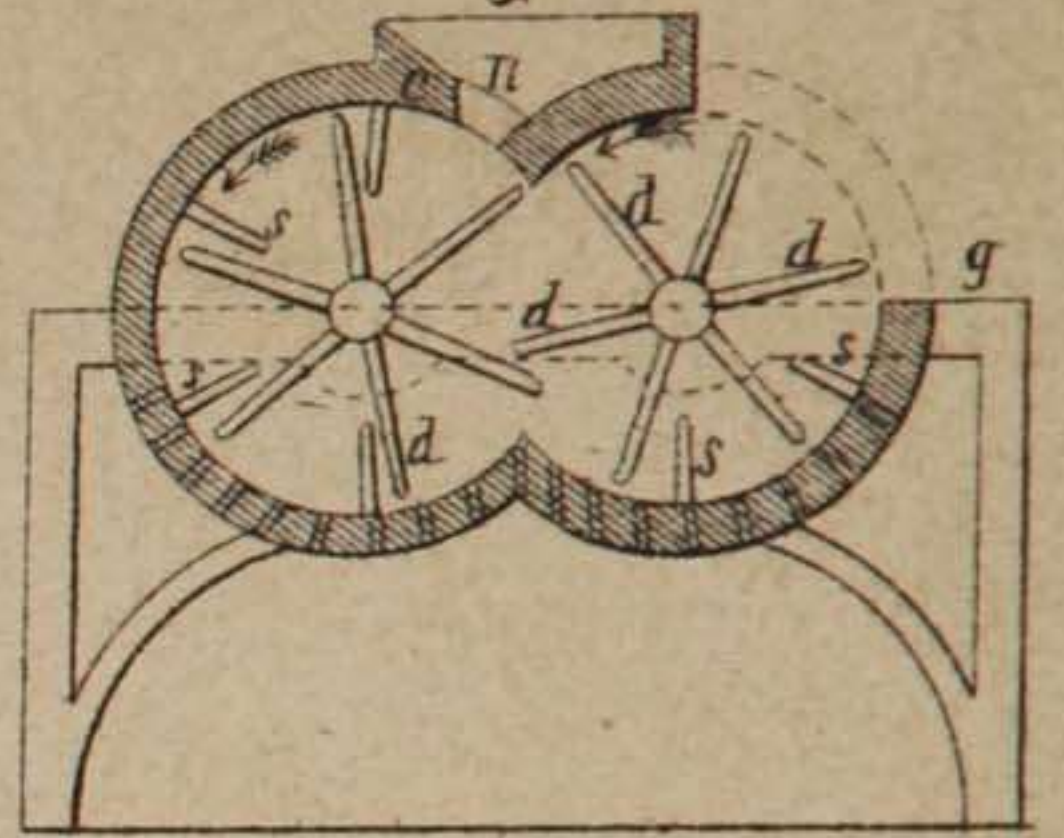


Fig. 214.

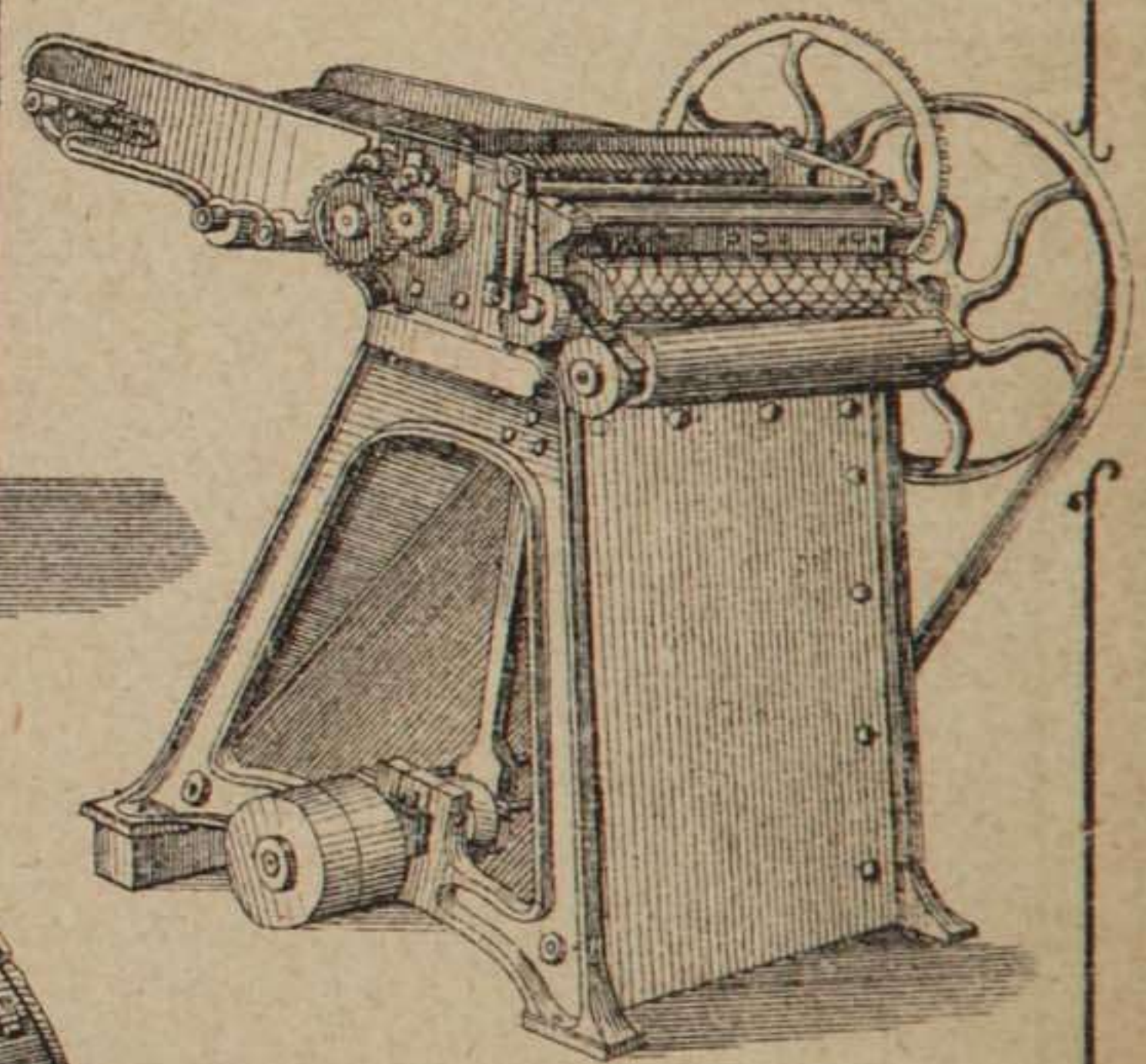


Fig. 216.

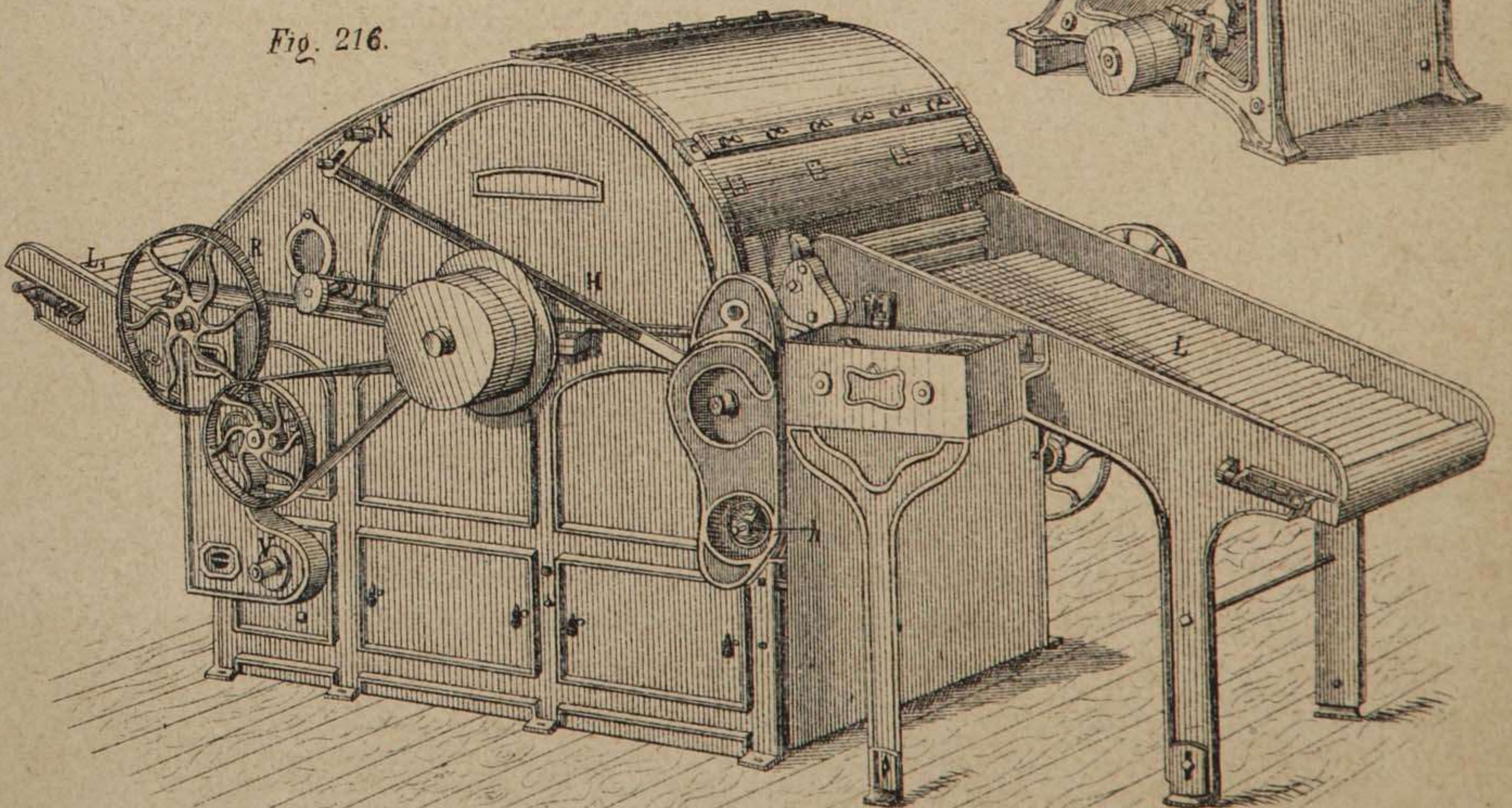


Fig. 218.

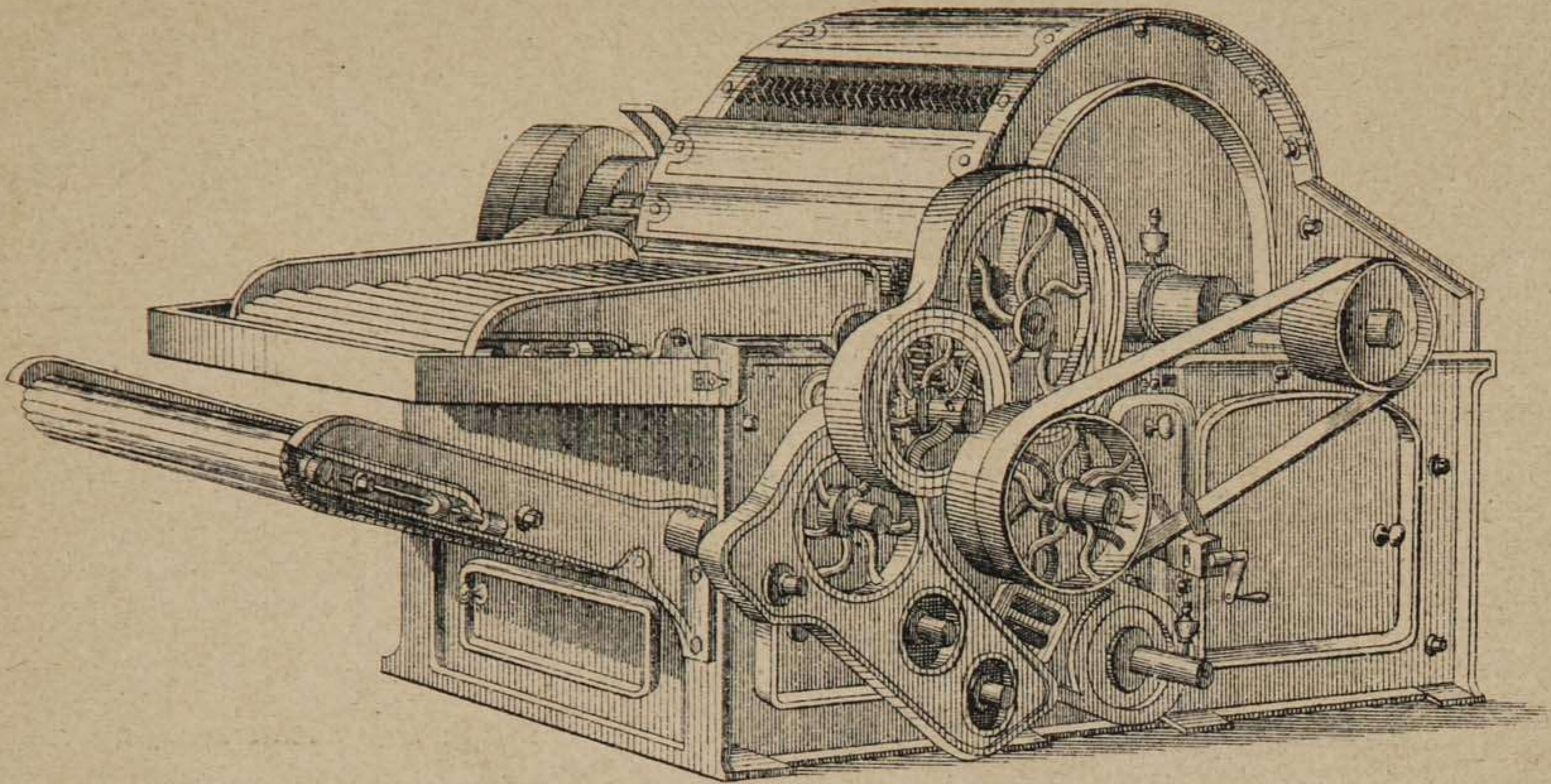


Fig. 220.

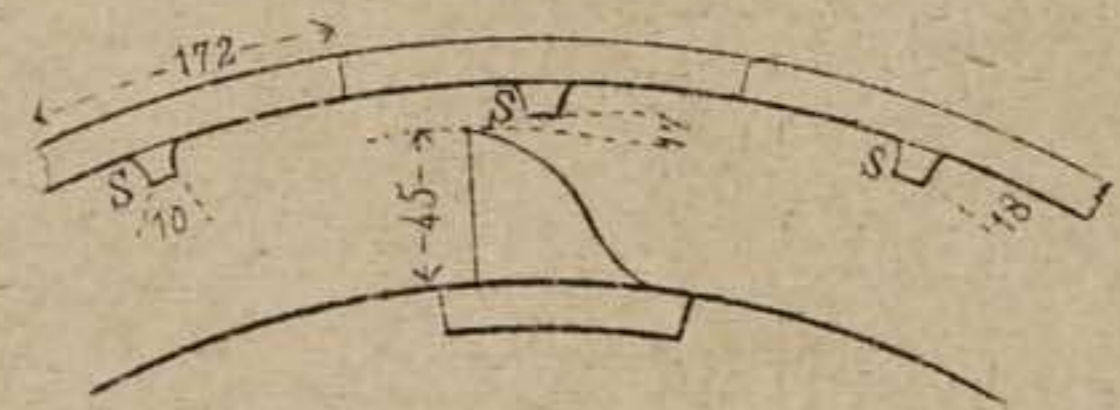


Fig. 219.

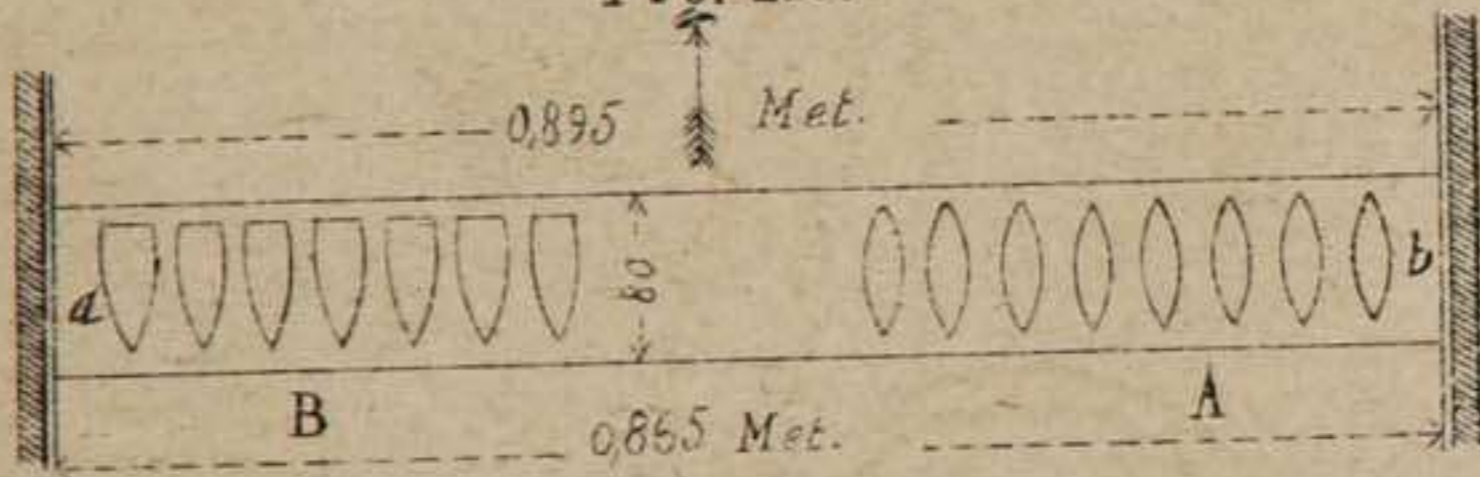


Fig. 221.

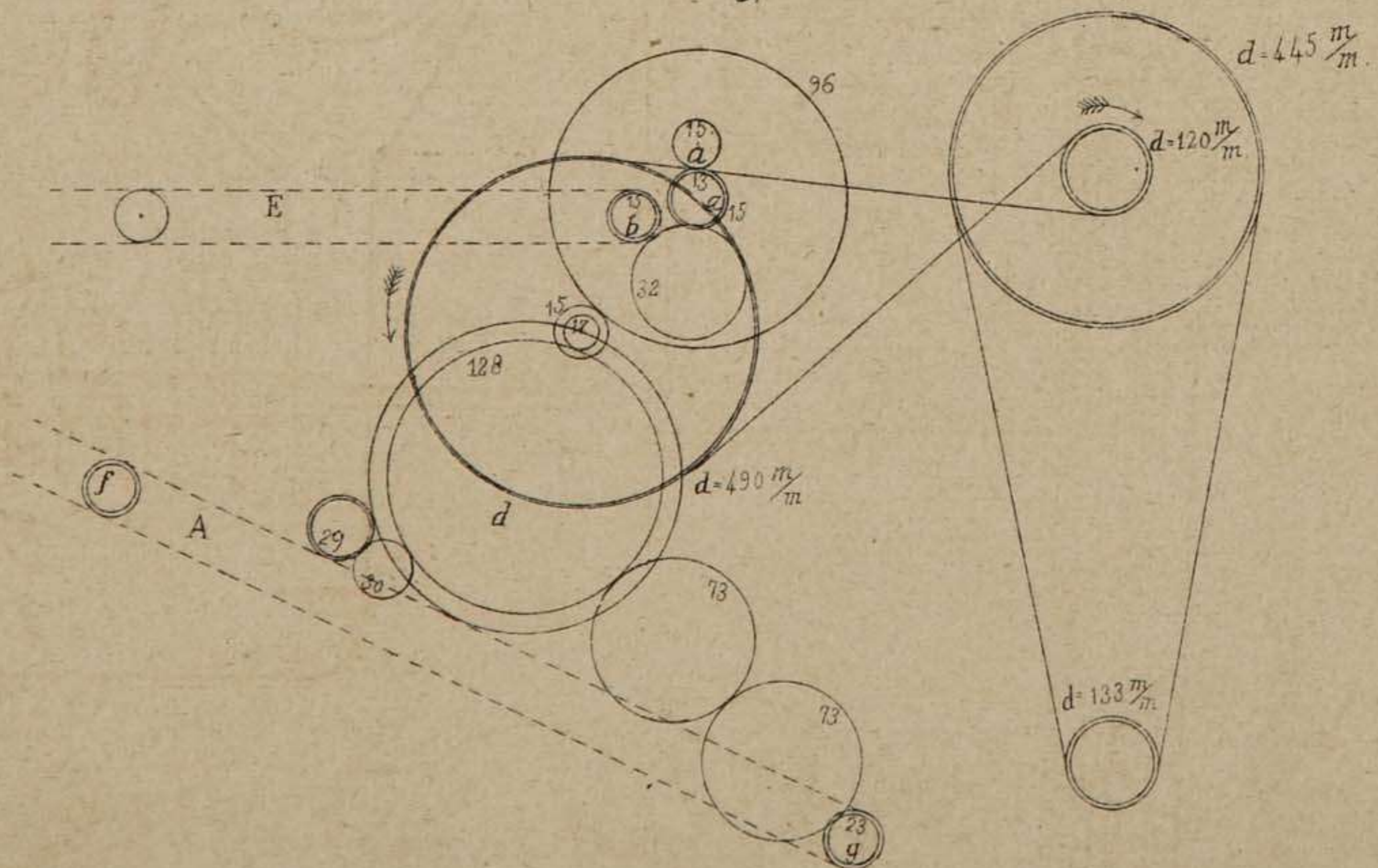


Fig. 222.

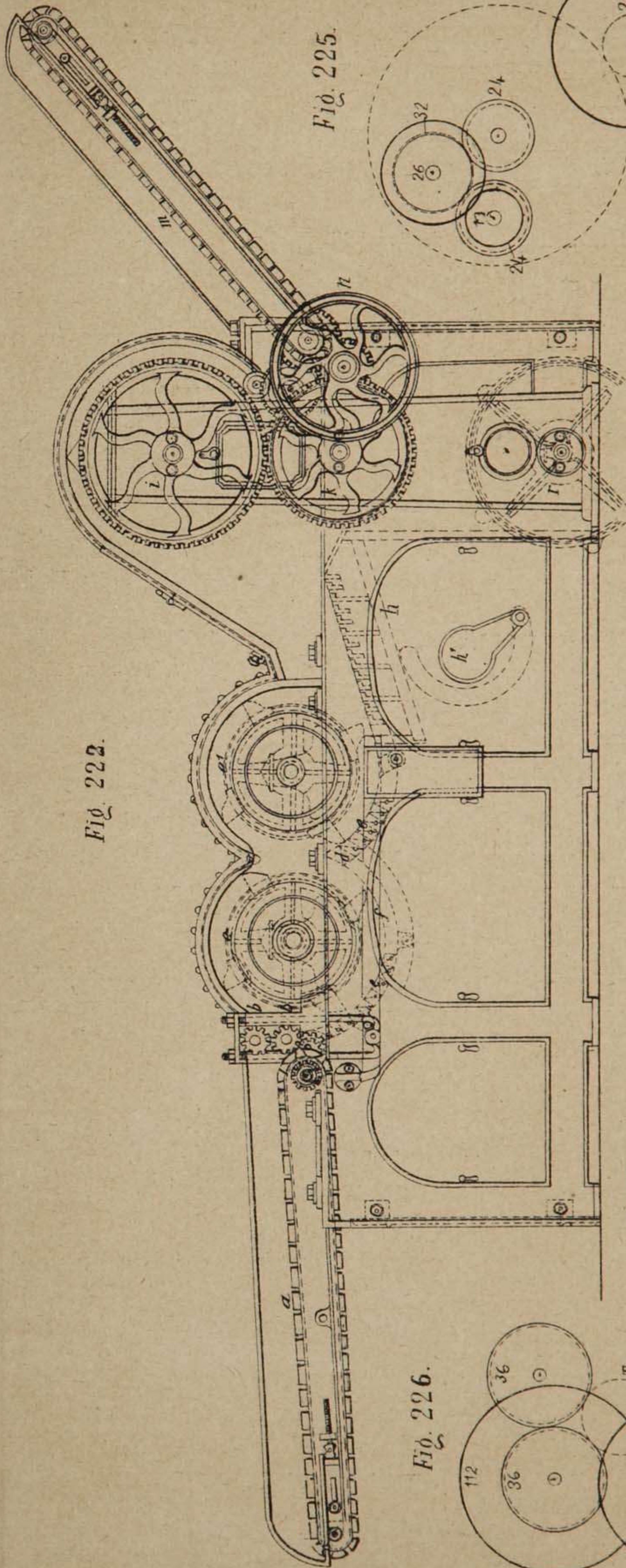


Fig. 225.

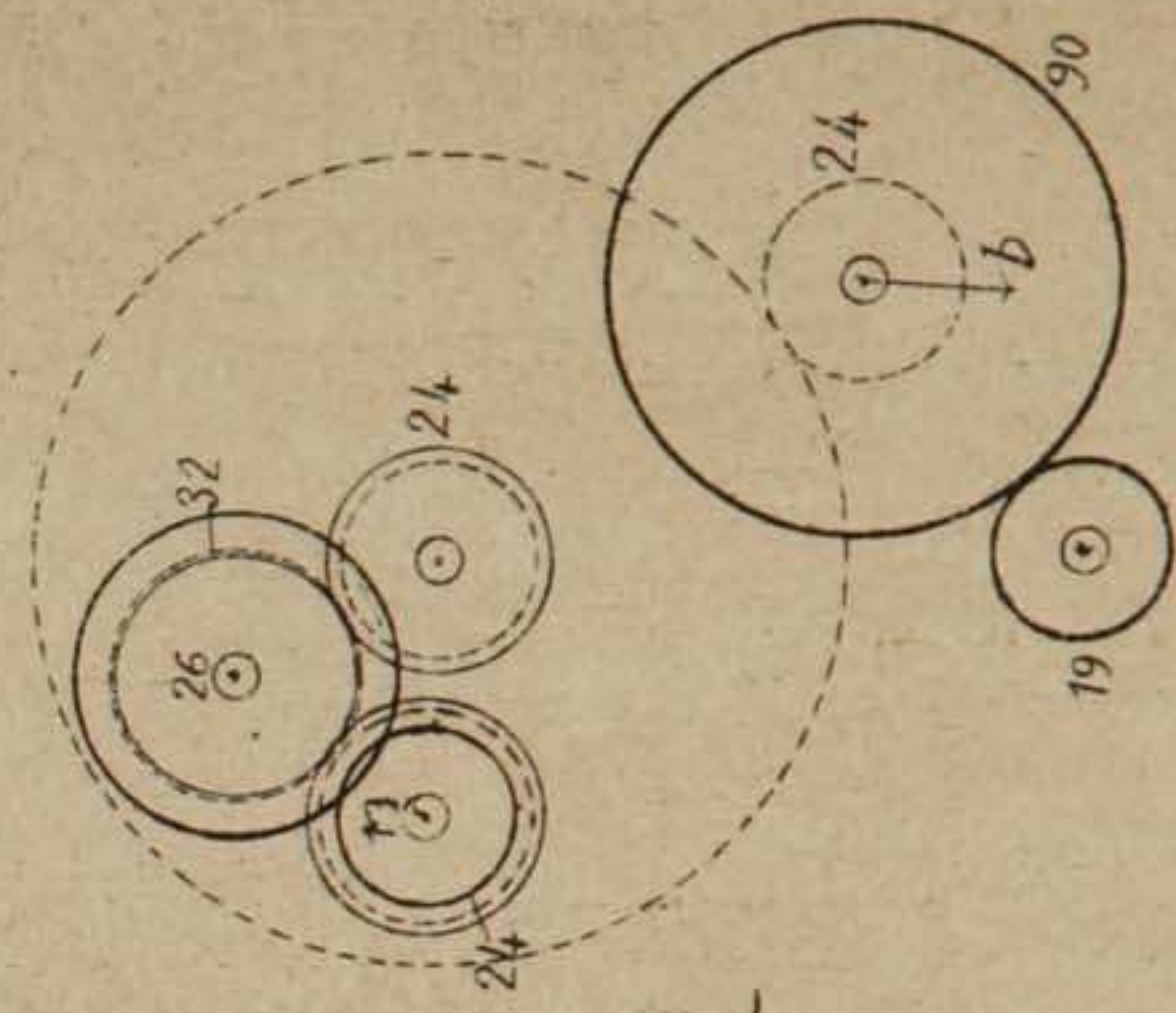


Fig. 224.

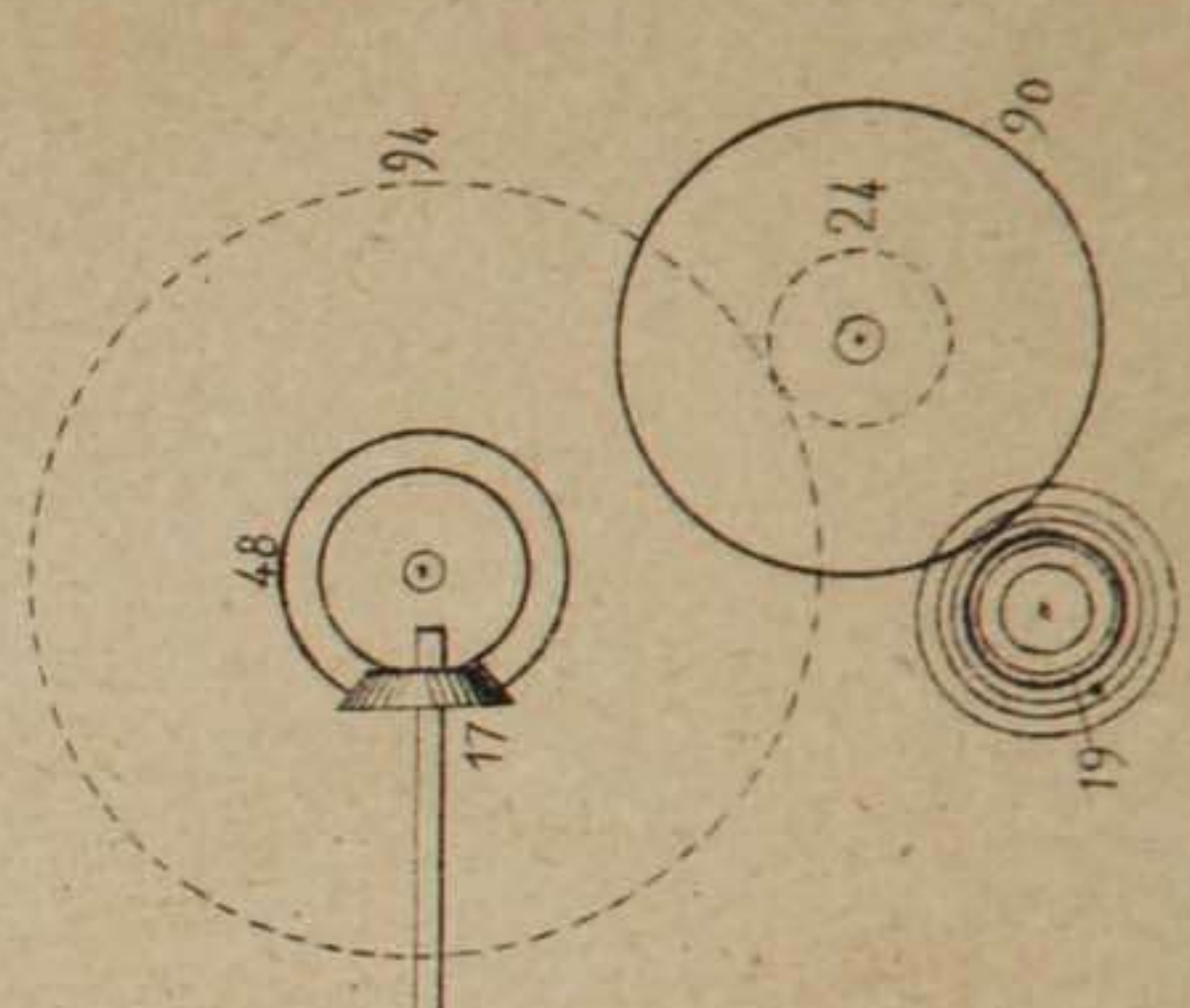


Fig. 223.

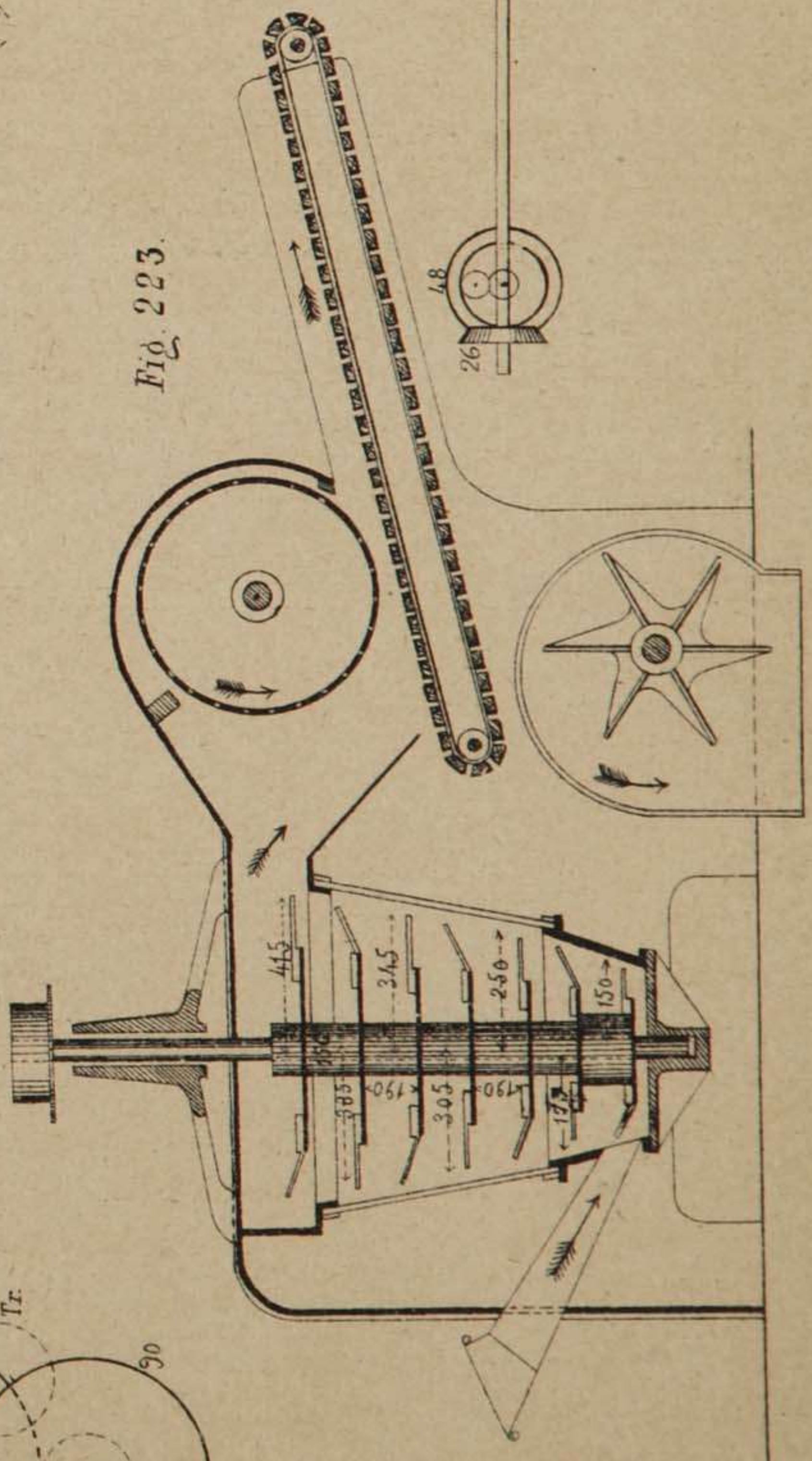
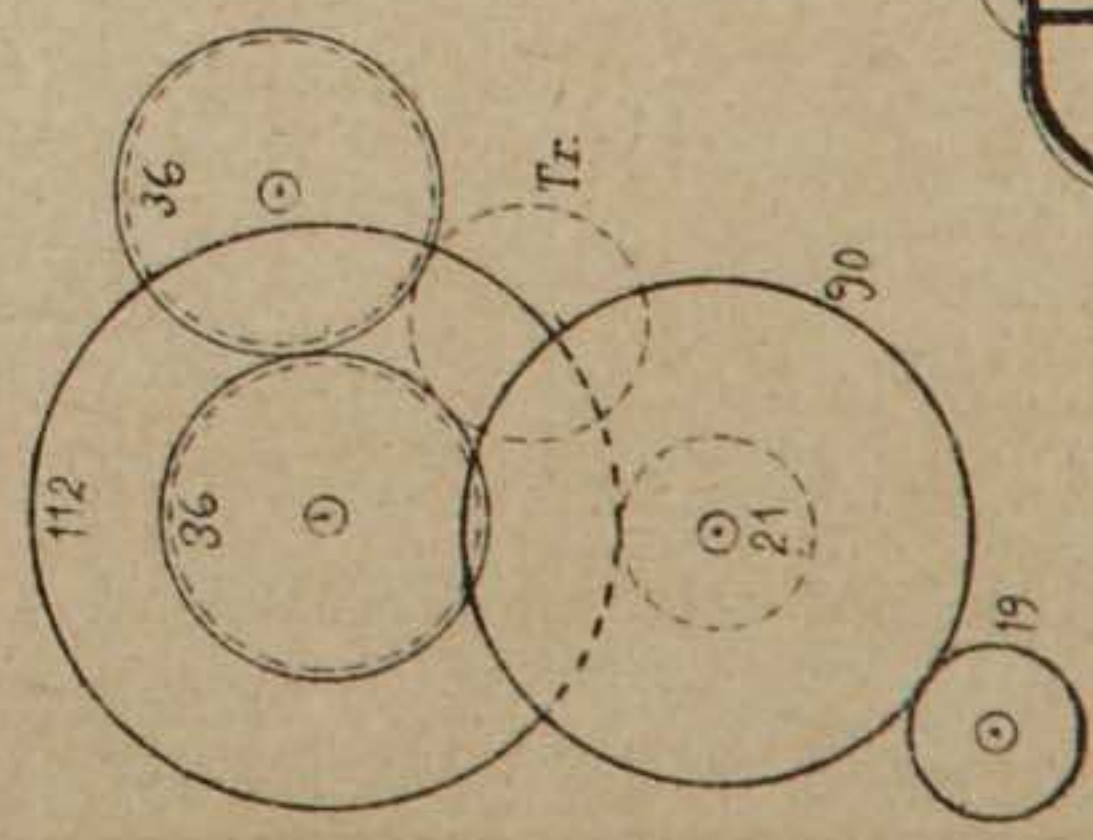


Fig. 226.



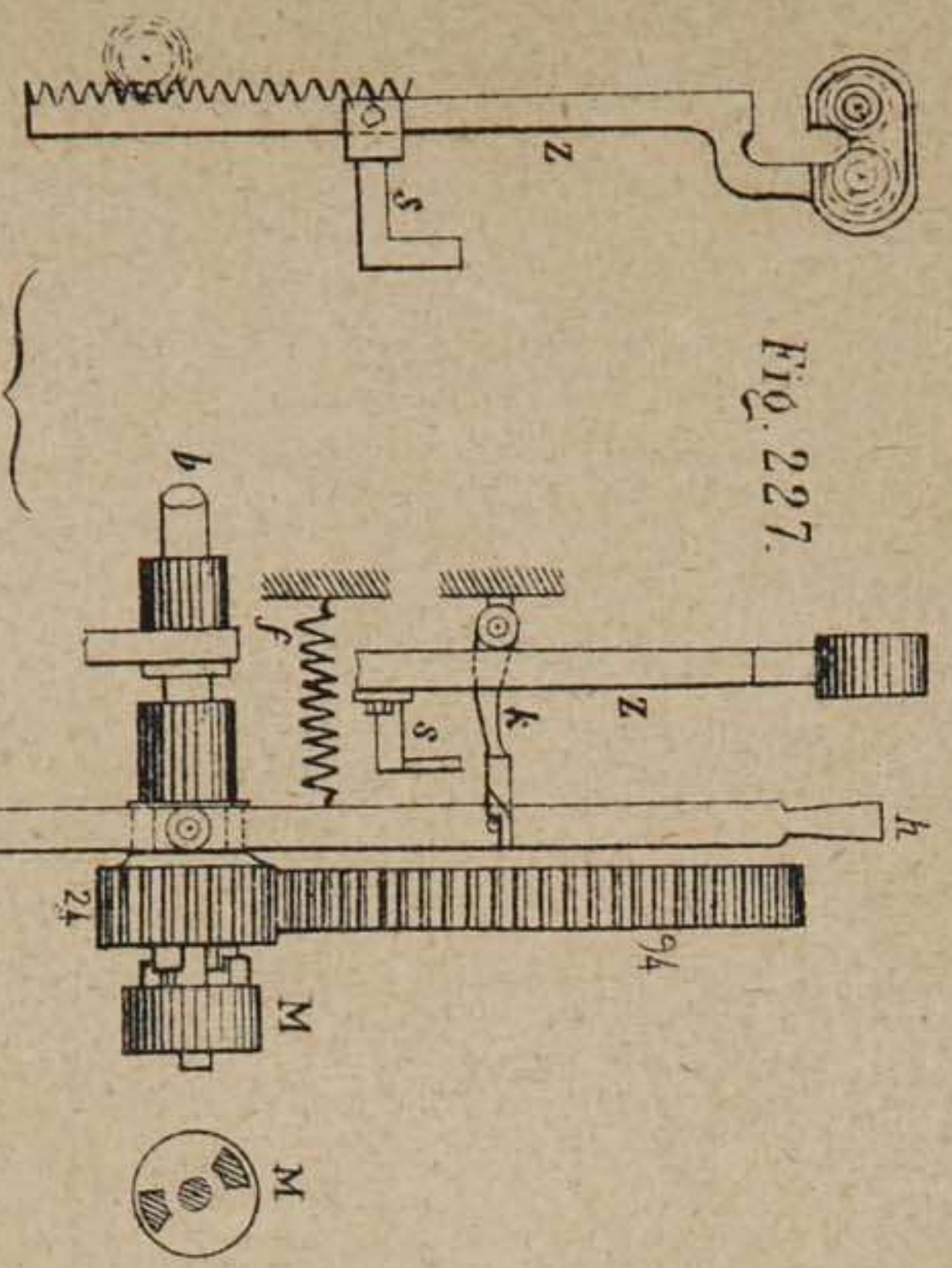


Fig. 227.

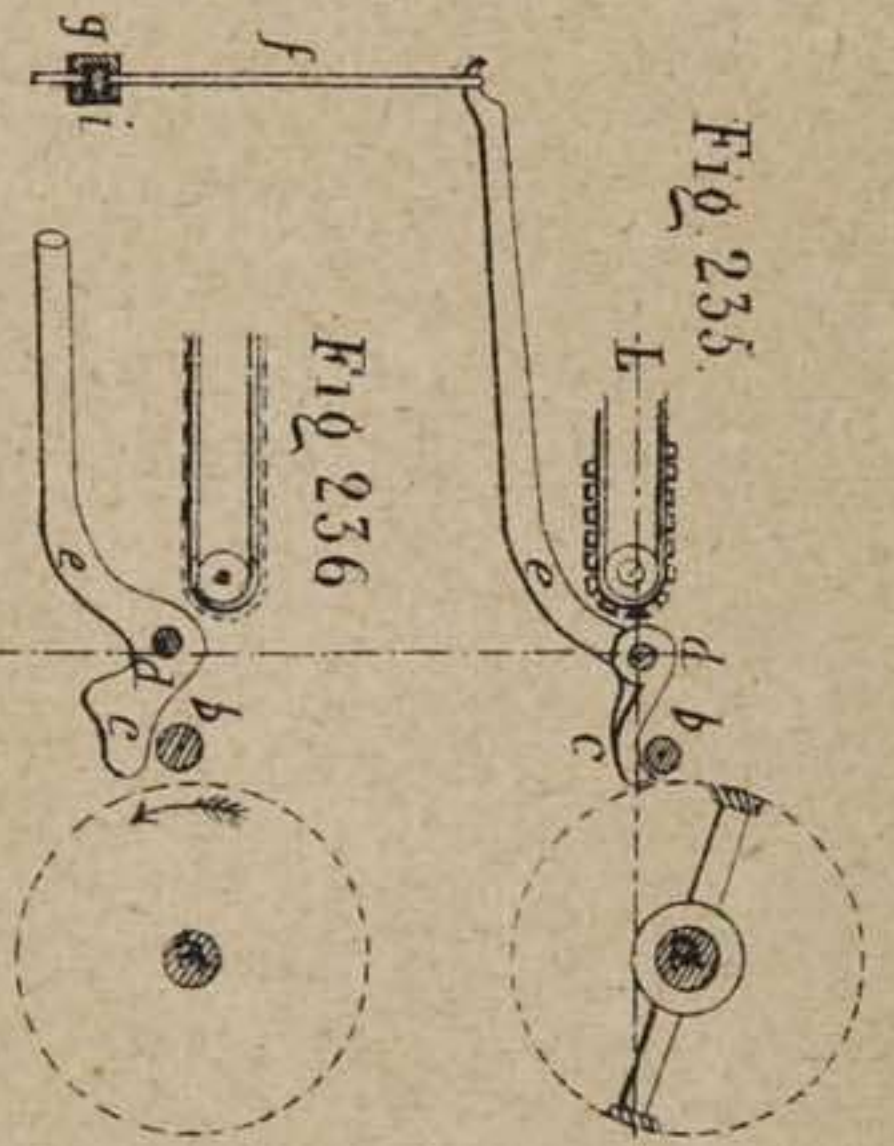


Fig. 235.

Fig. 236.

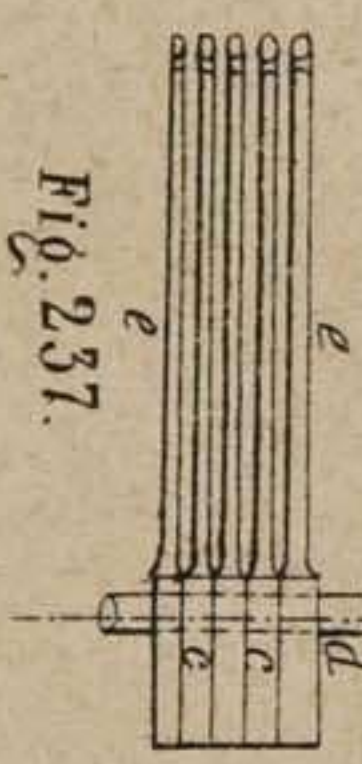


Fig. 237.

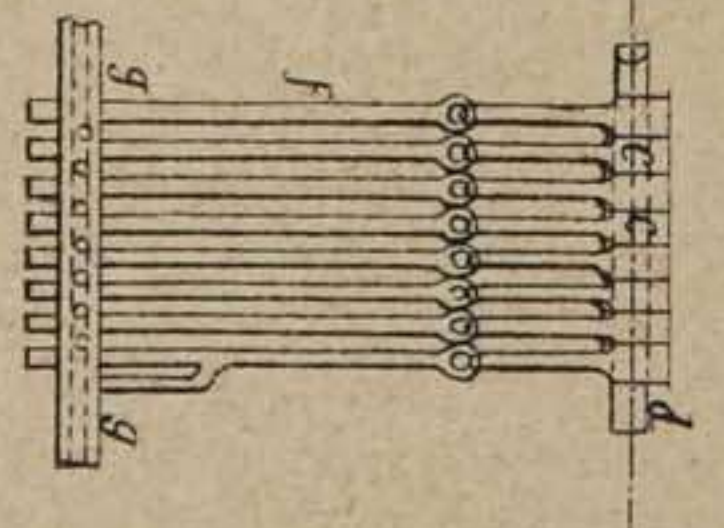


Fig. 238.

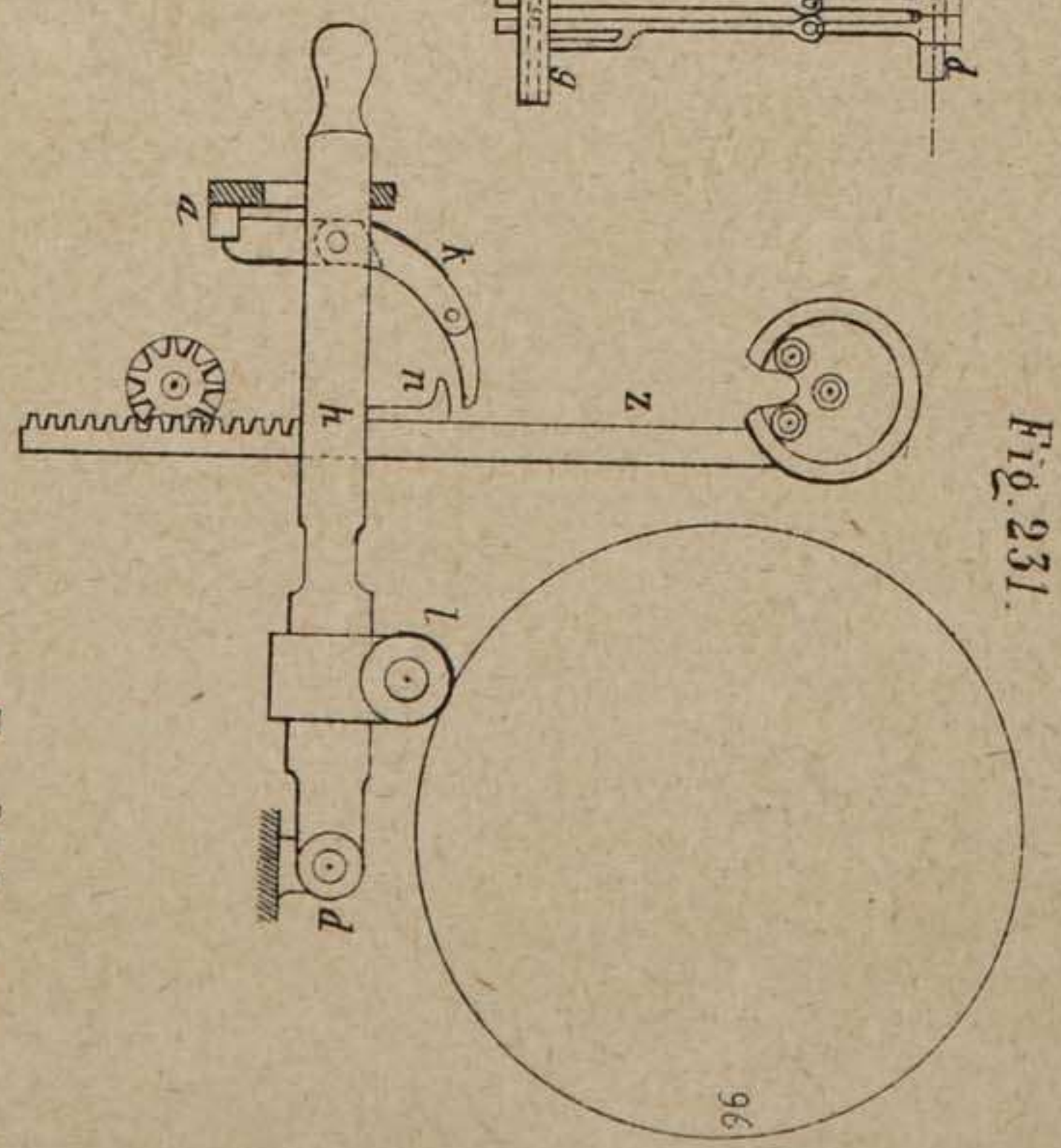


Fig. 231.

Fig. 230.

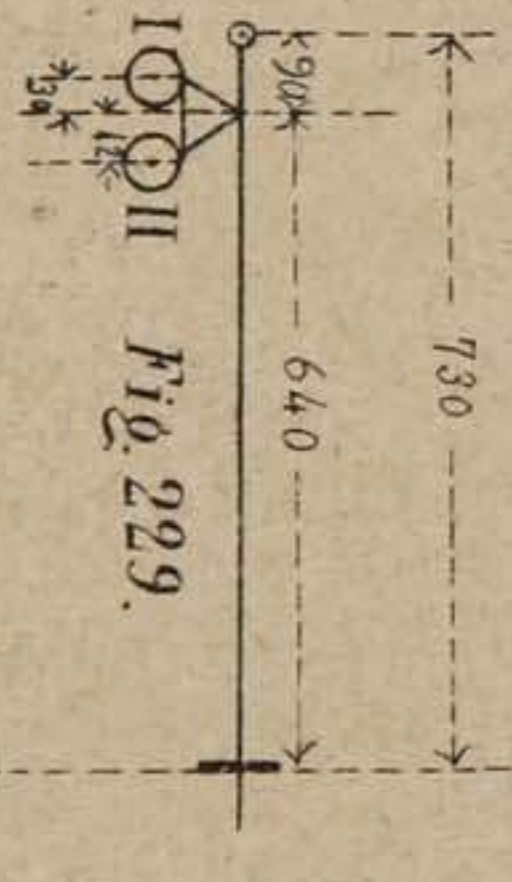
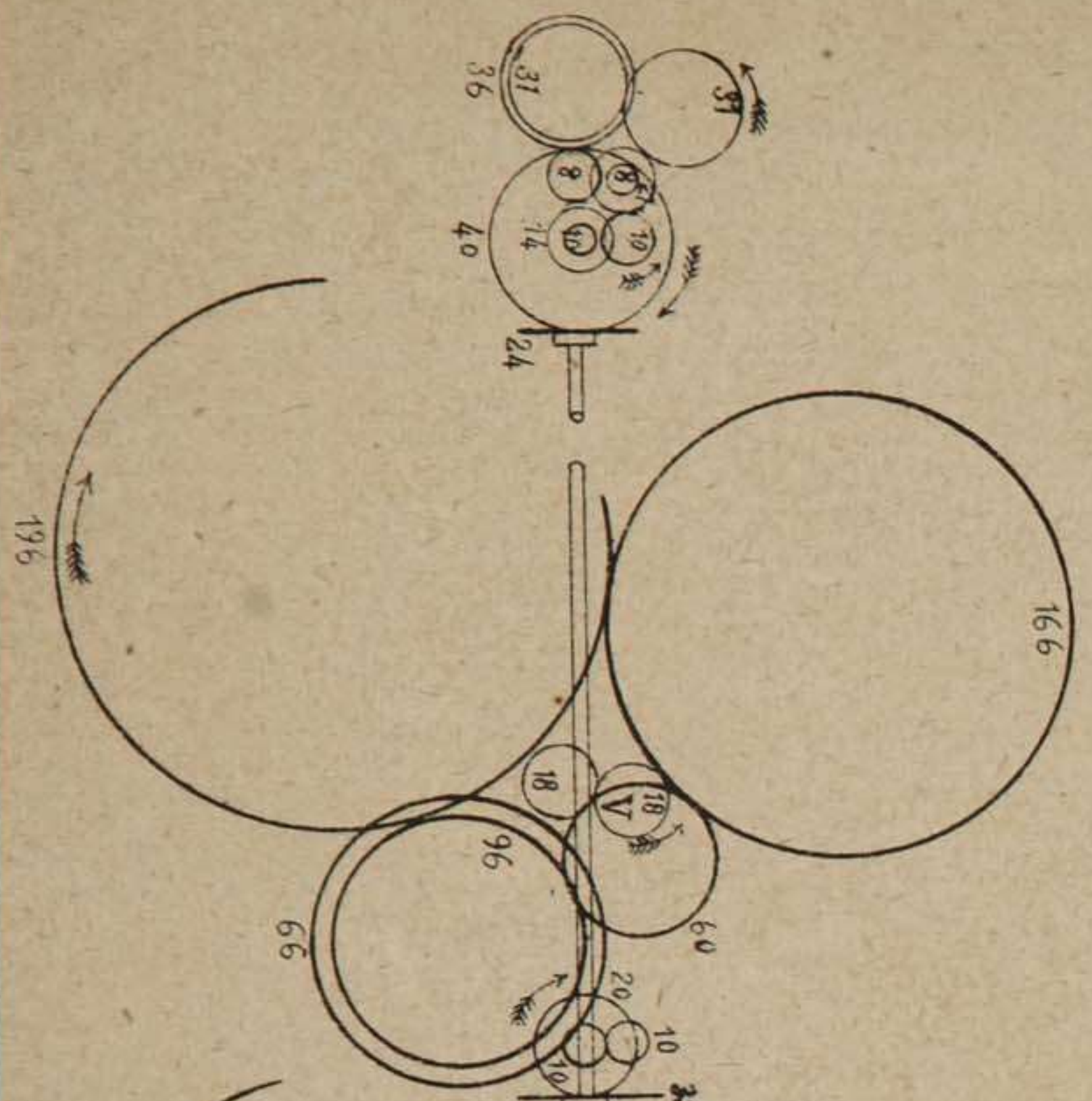


Fig. 229.

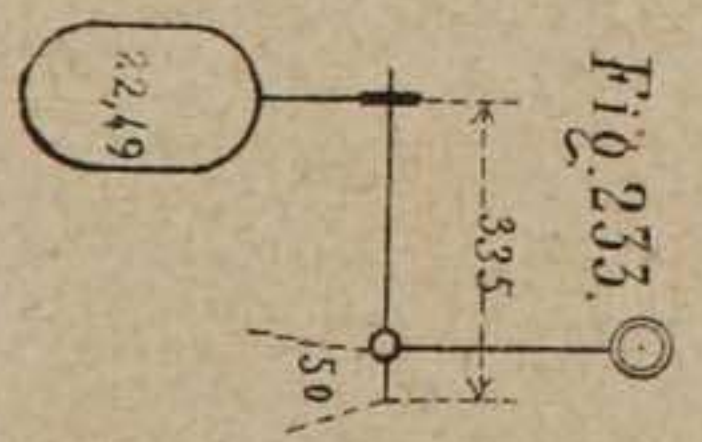


Fig. 233.

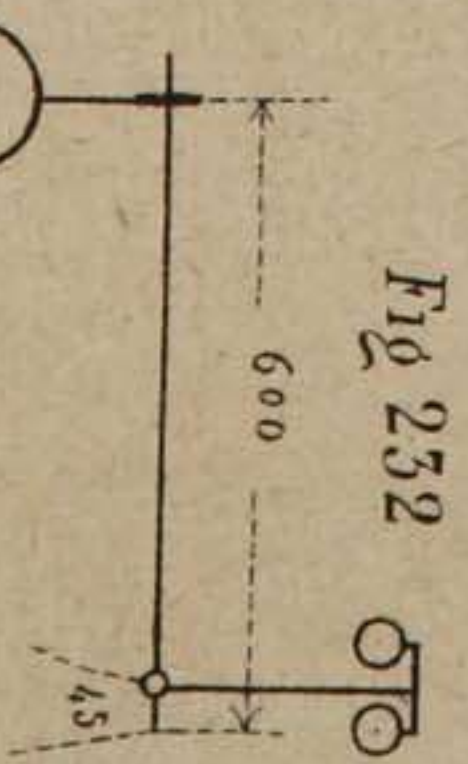


Fig. 232.

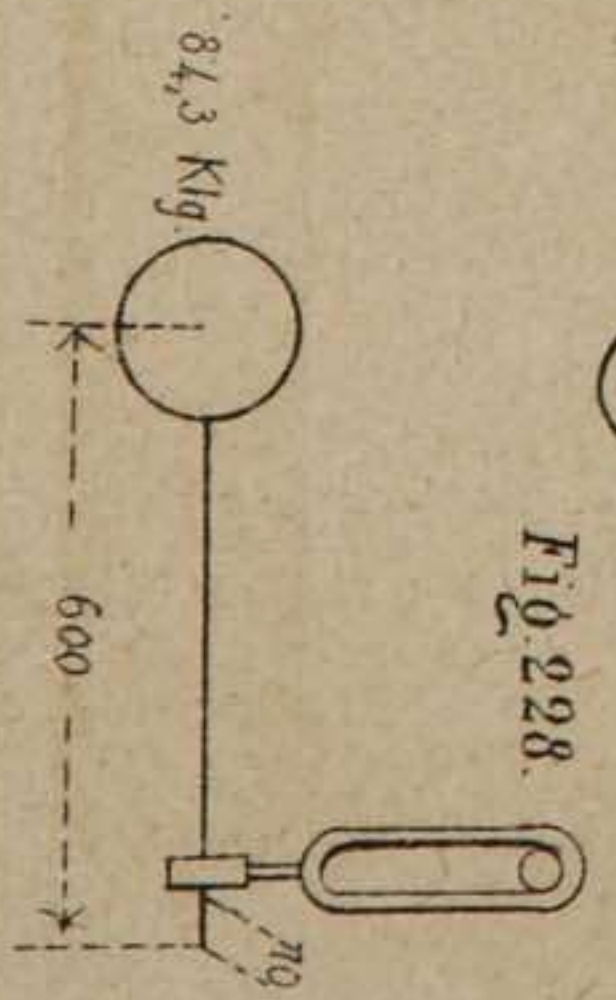


Fig. 228.

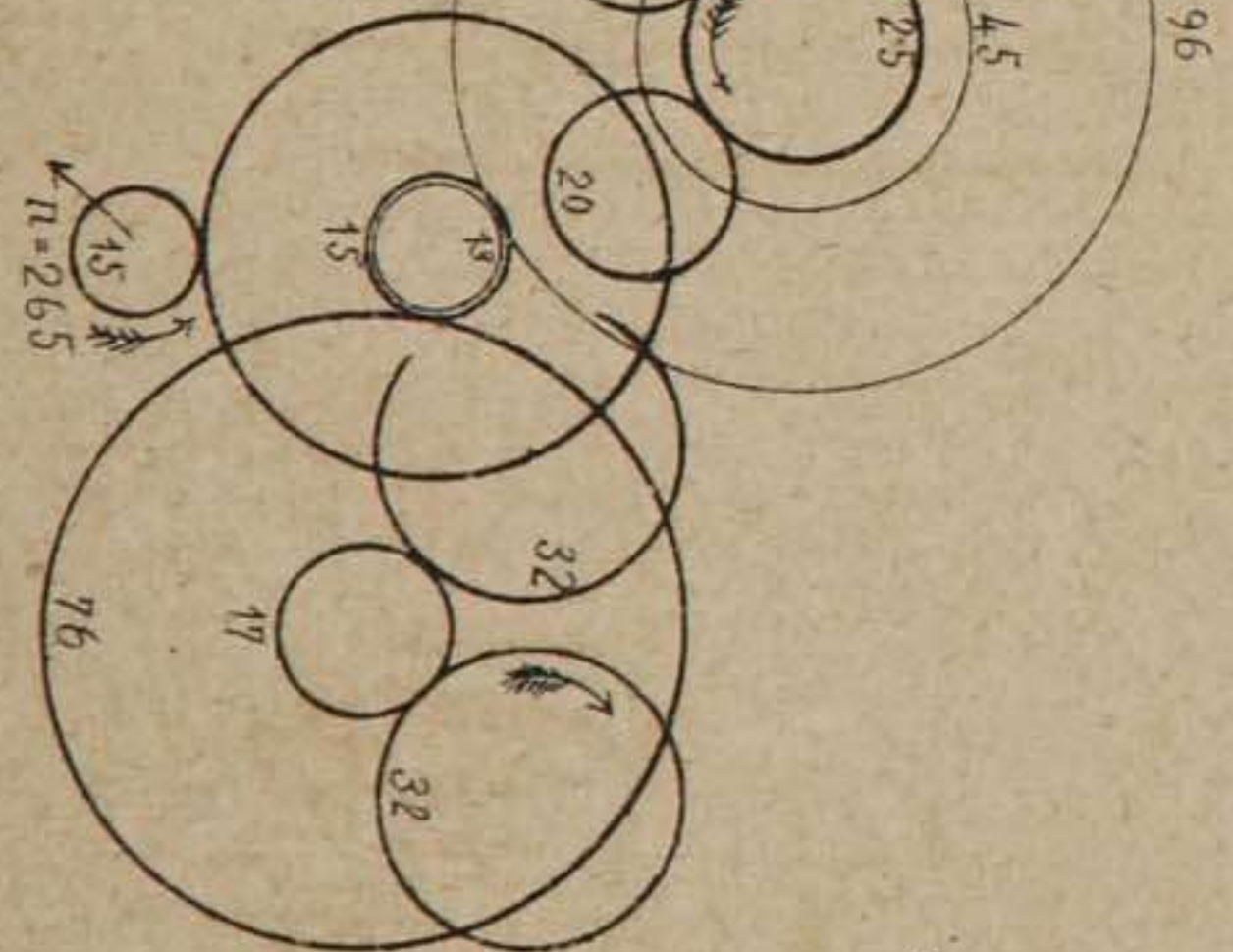
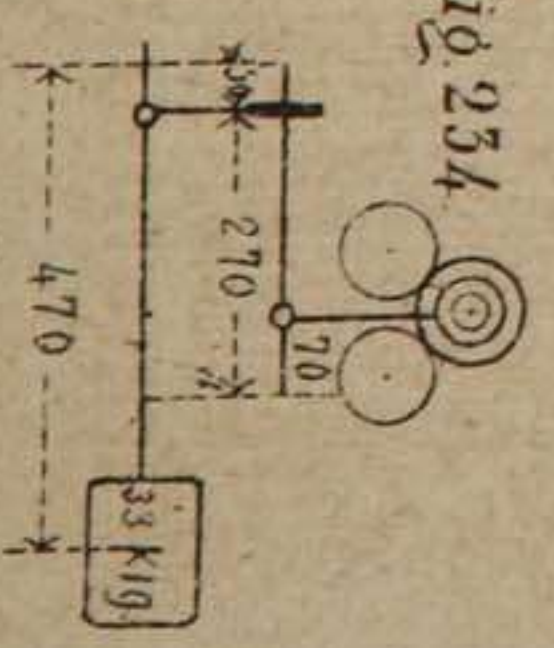


Fig. 234.



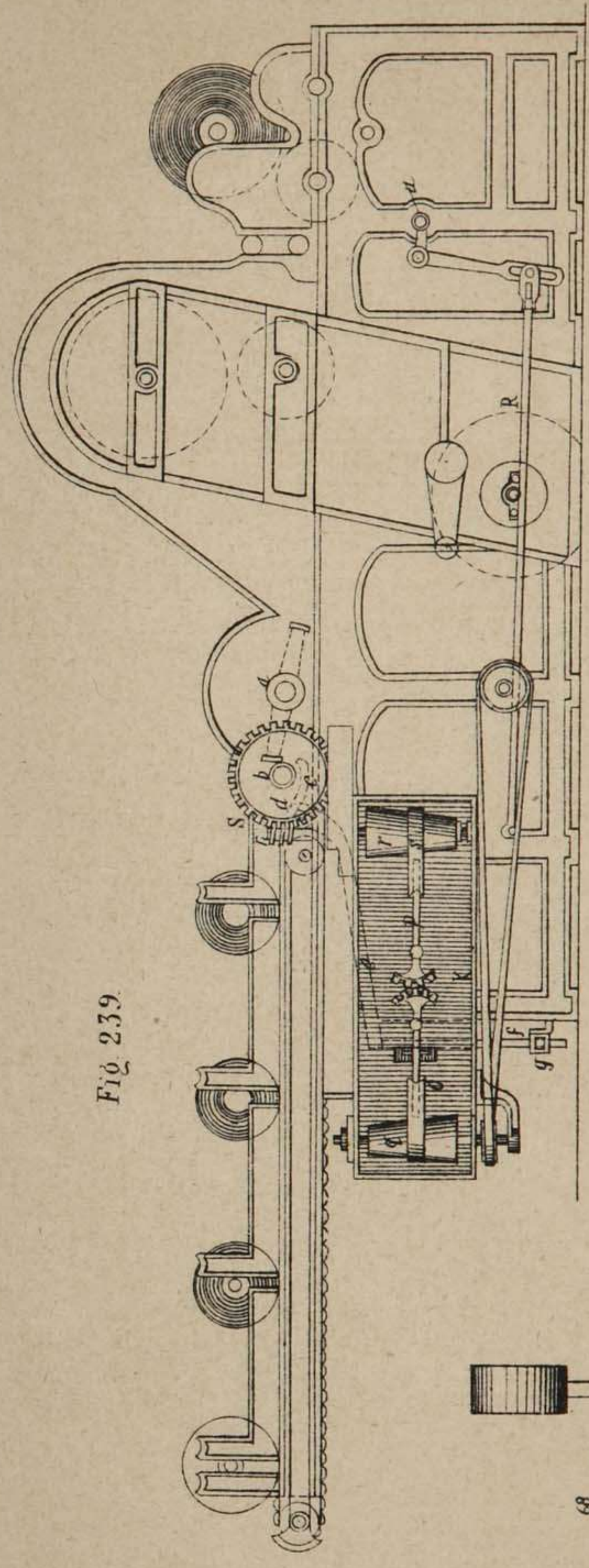


Fig. 239.

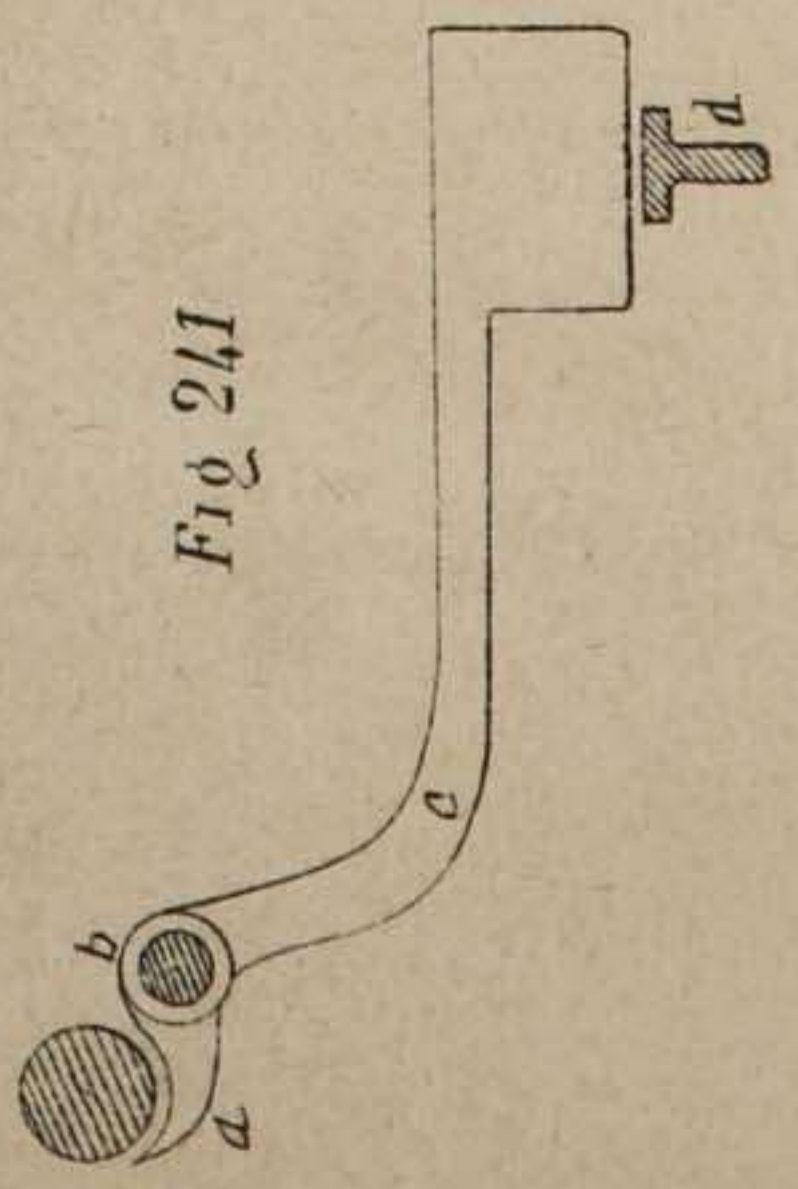


Fig. 241

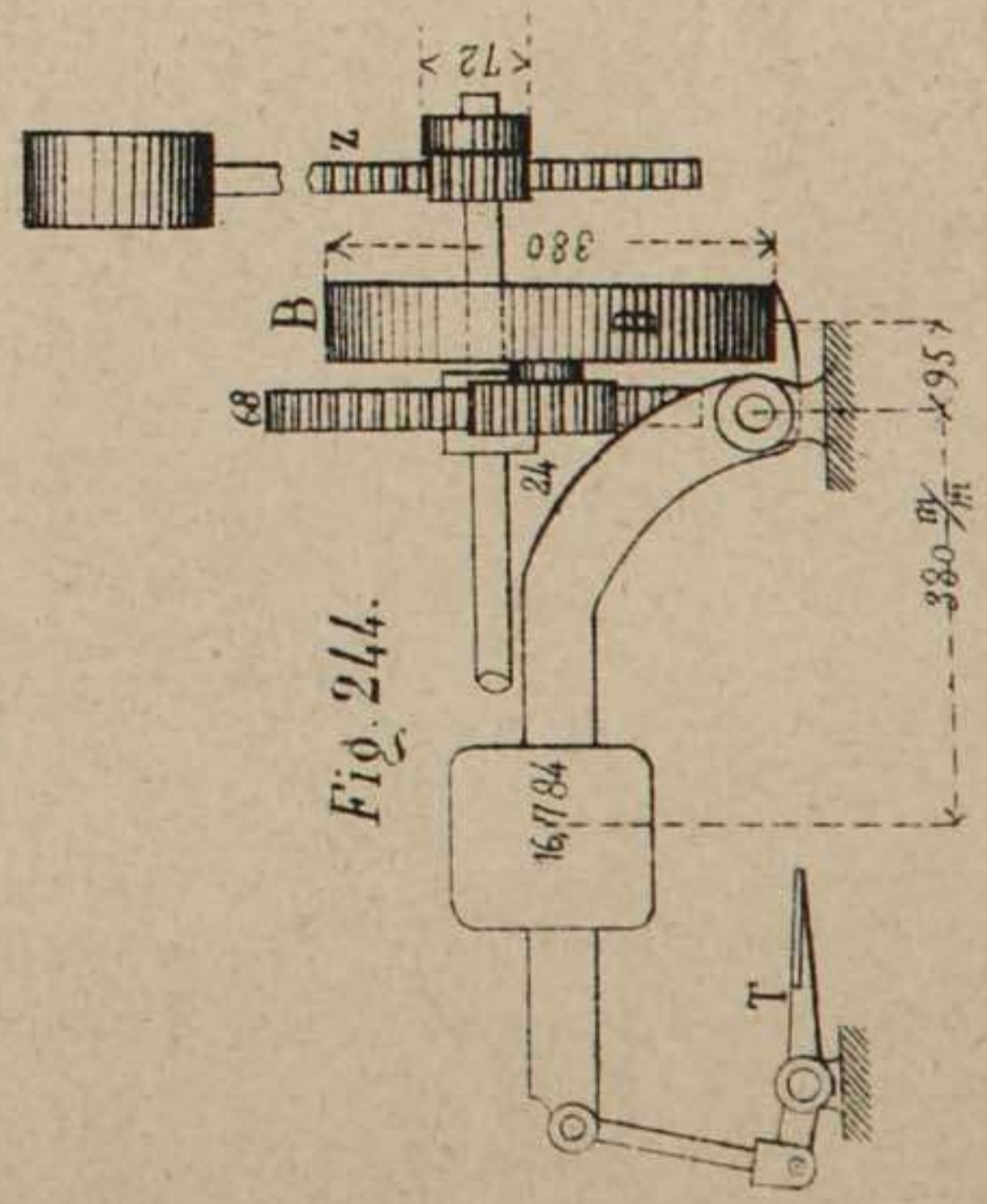


Fig. 244.

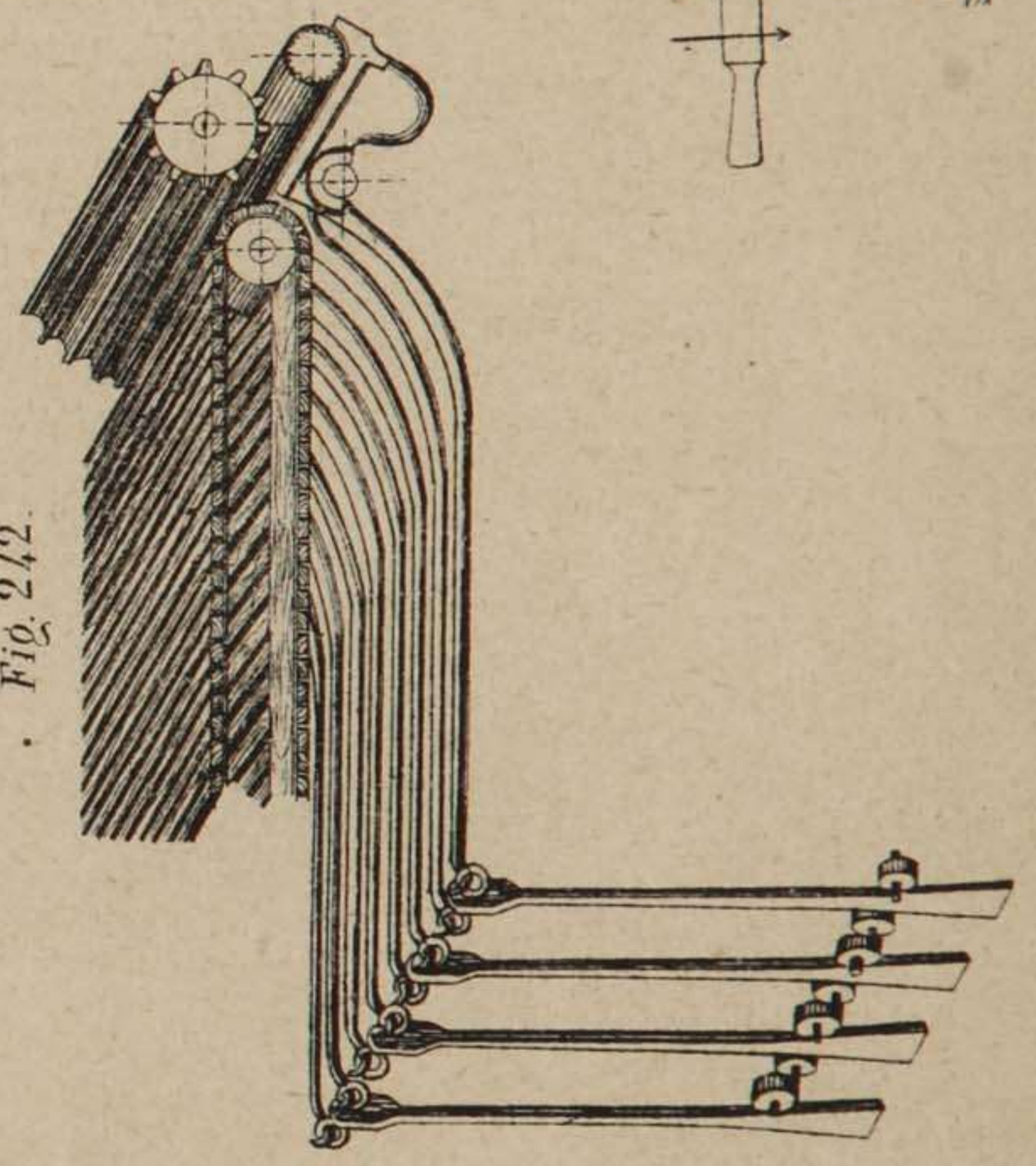


Fig. 242.

Fig. 243.

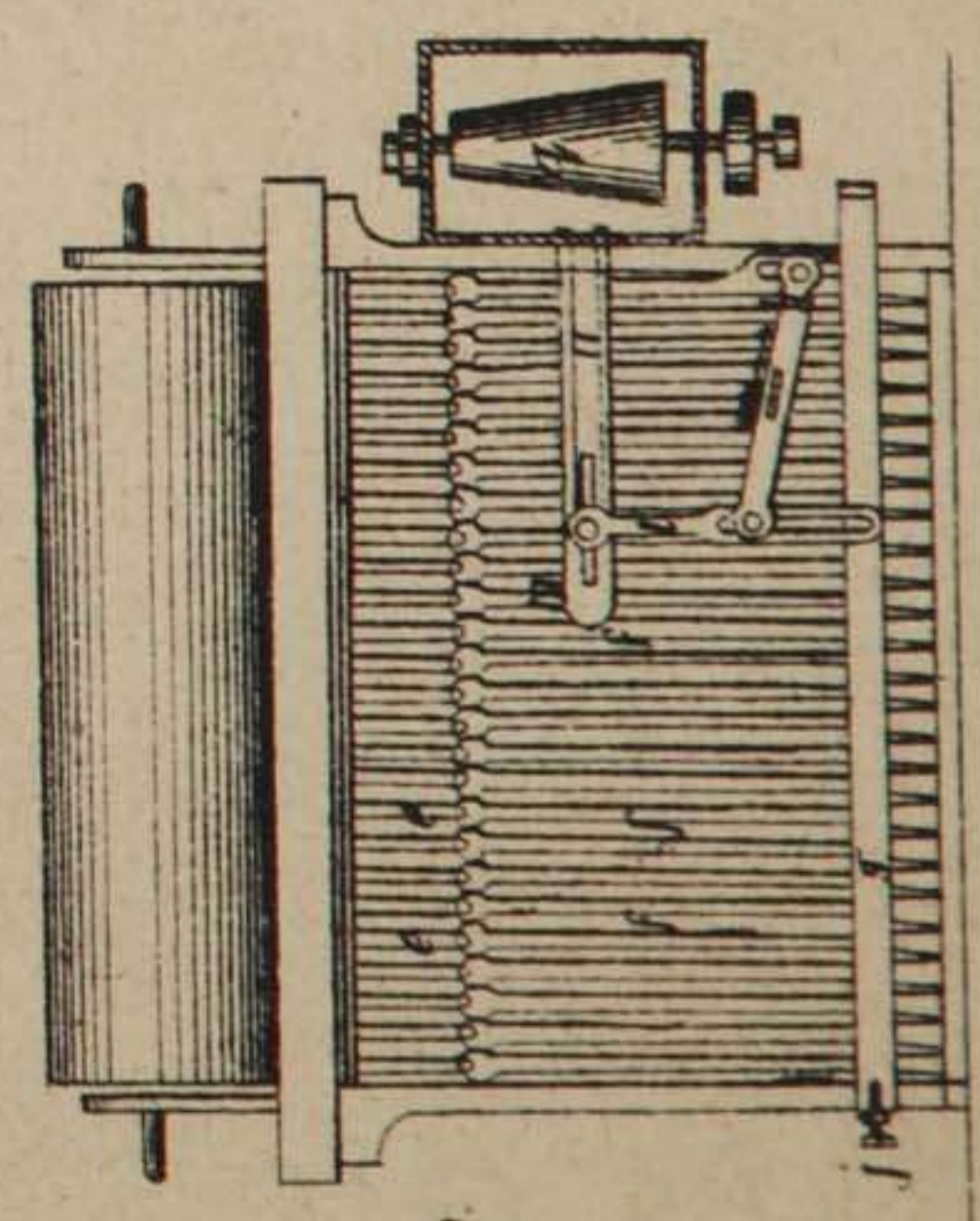
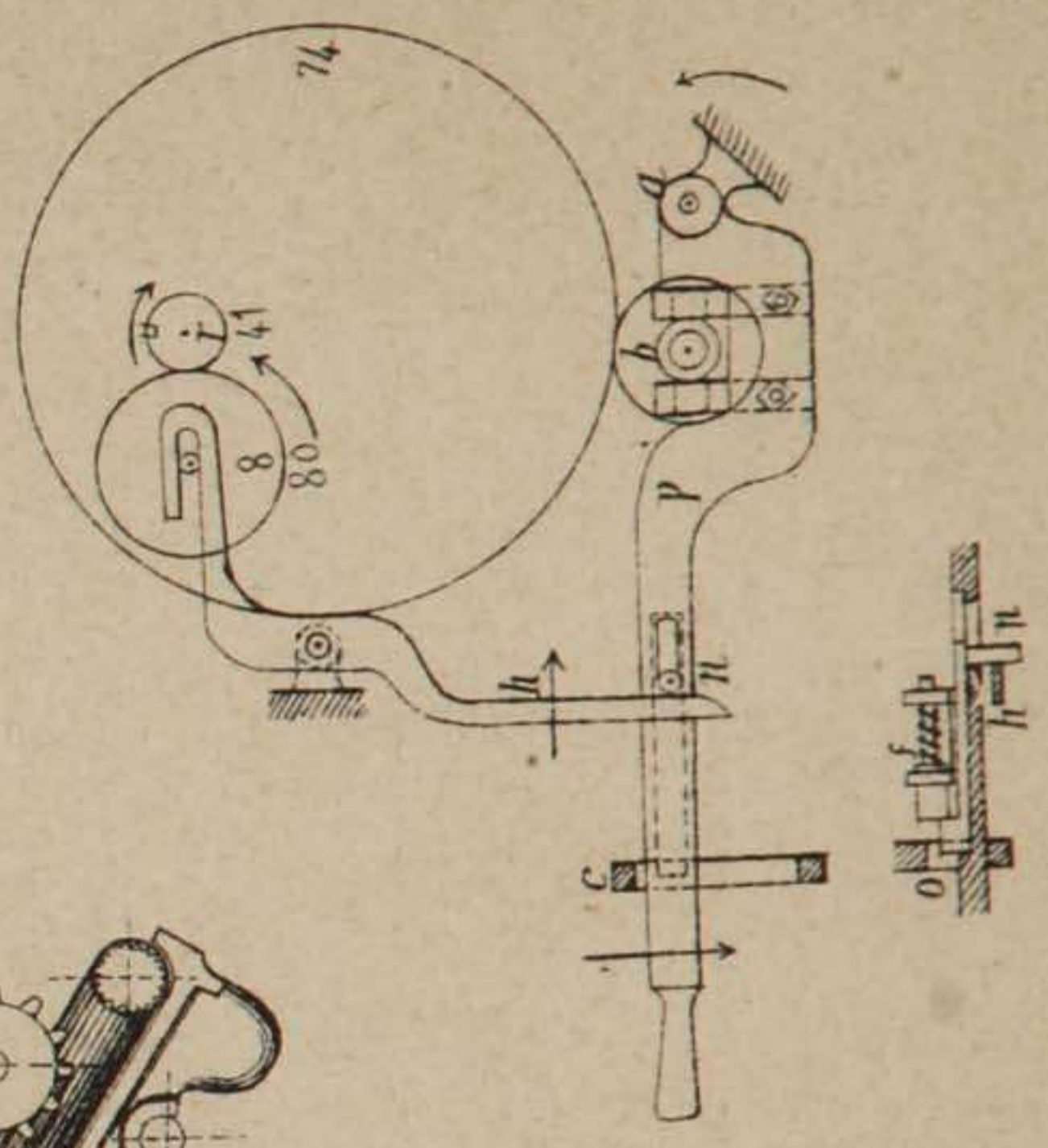


Fig. 240.

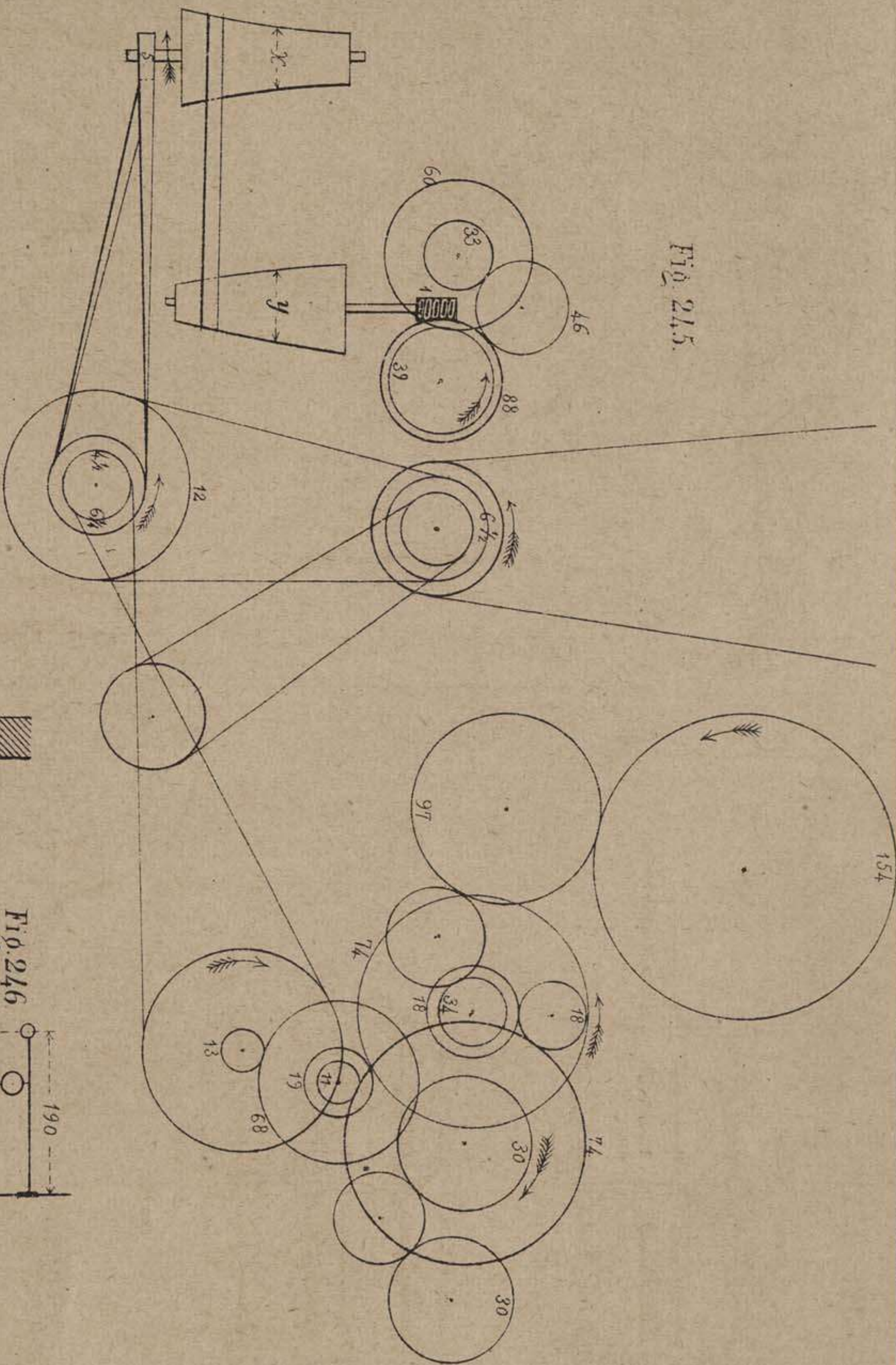


Fig. 245.

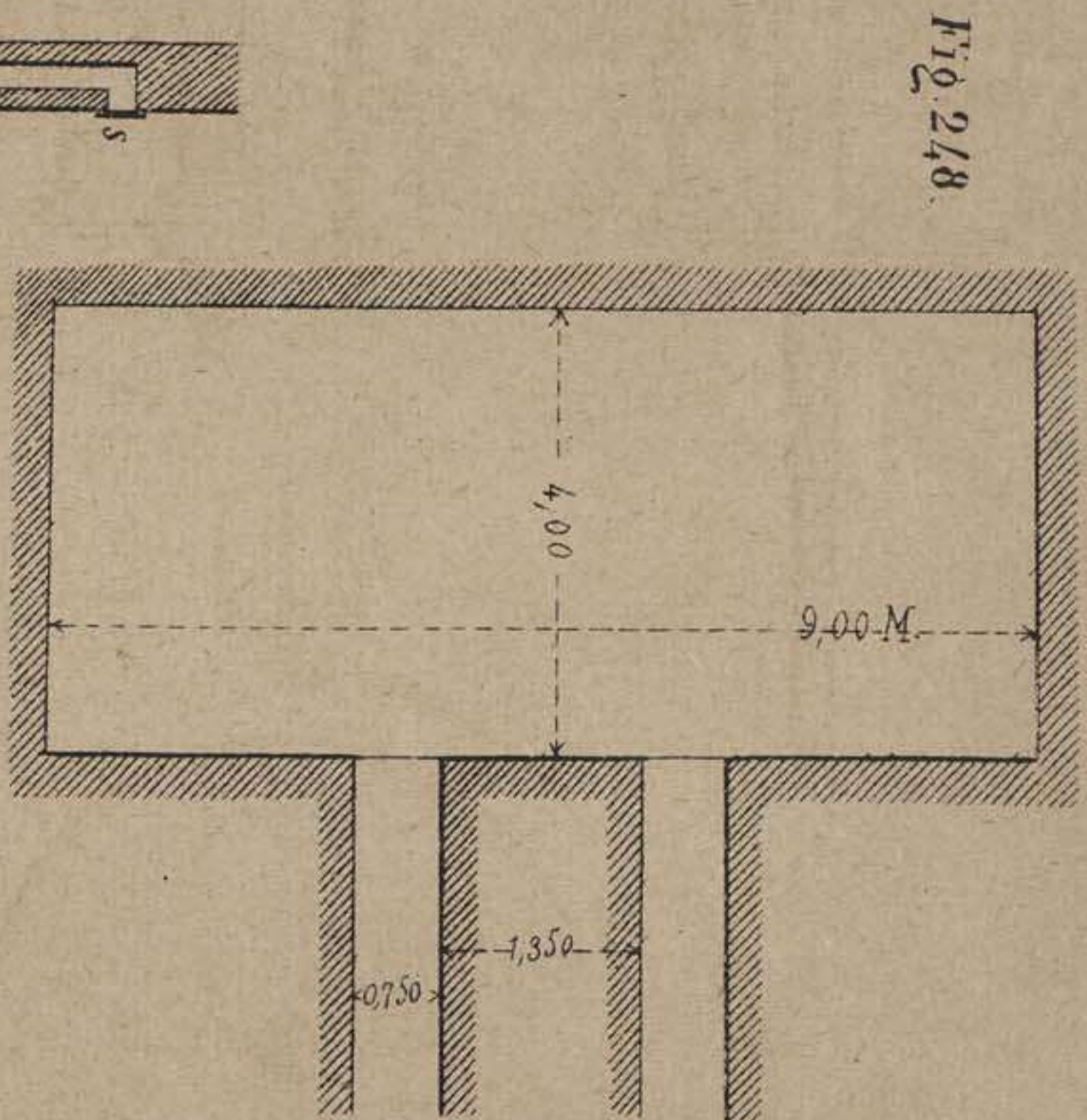


Fig. 248.

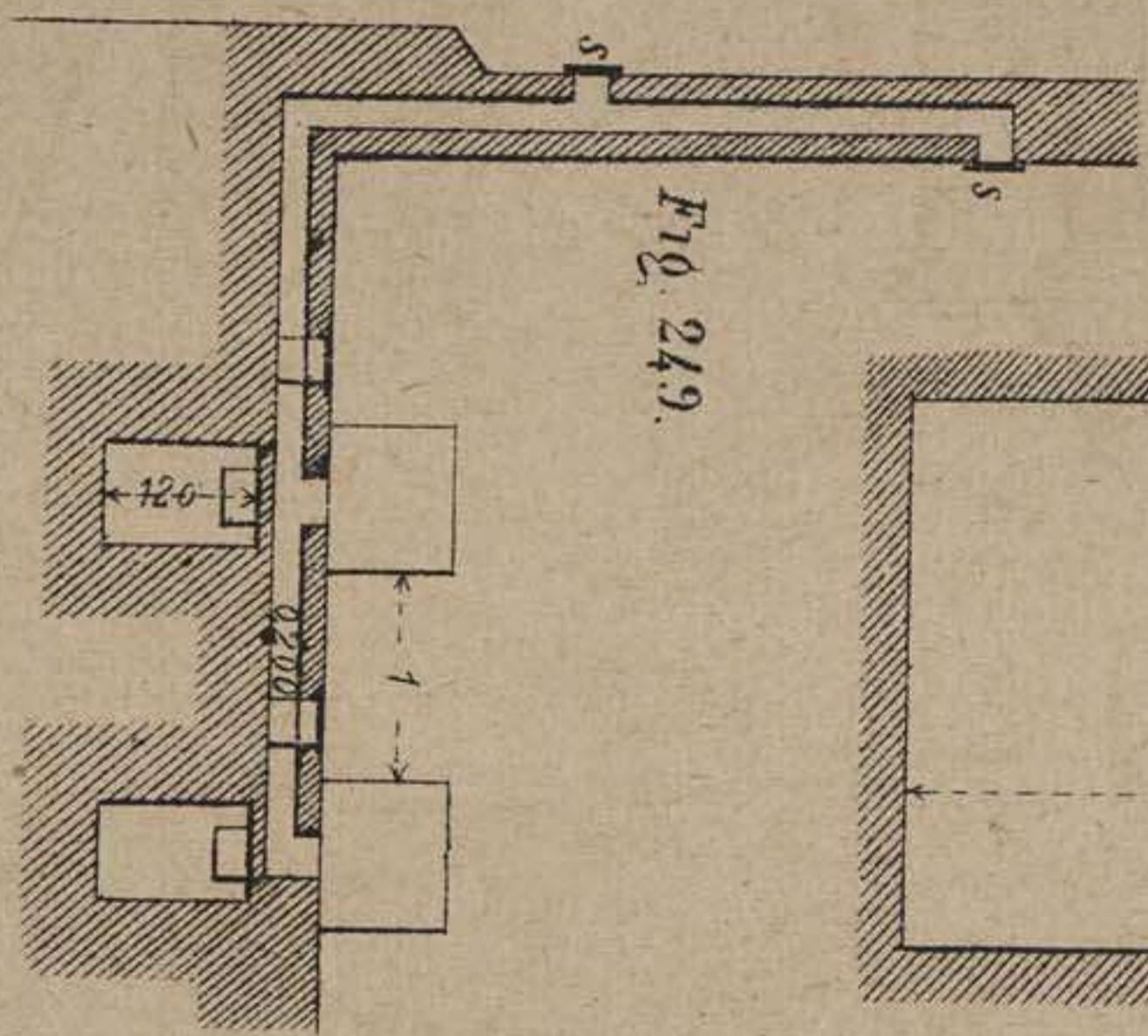


Fig. 249.

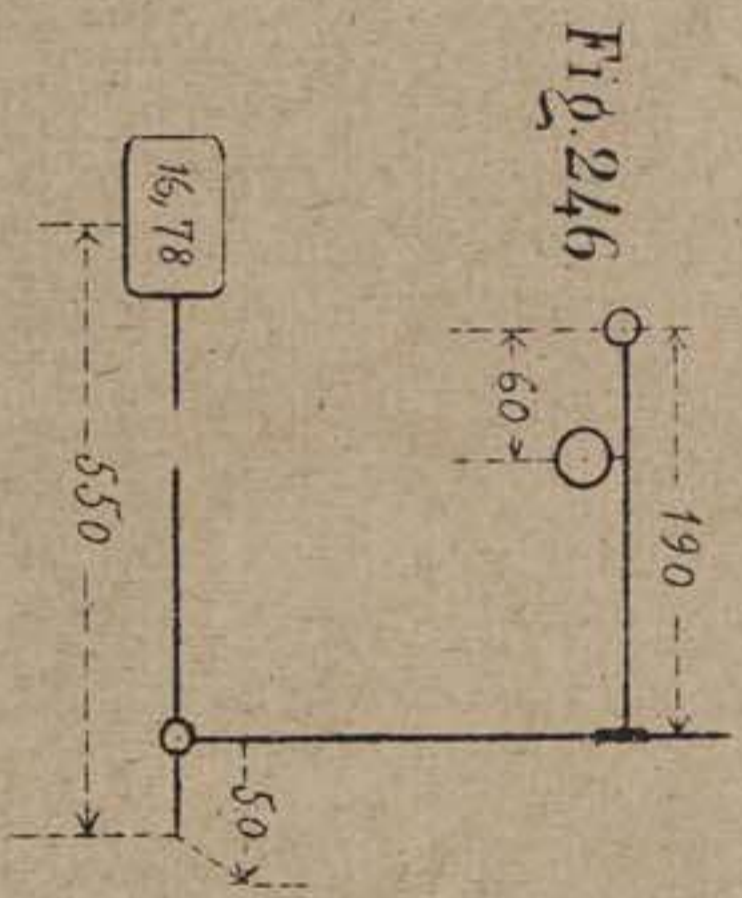


Fig. 246.

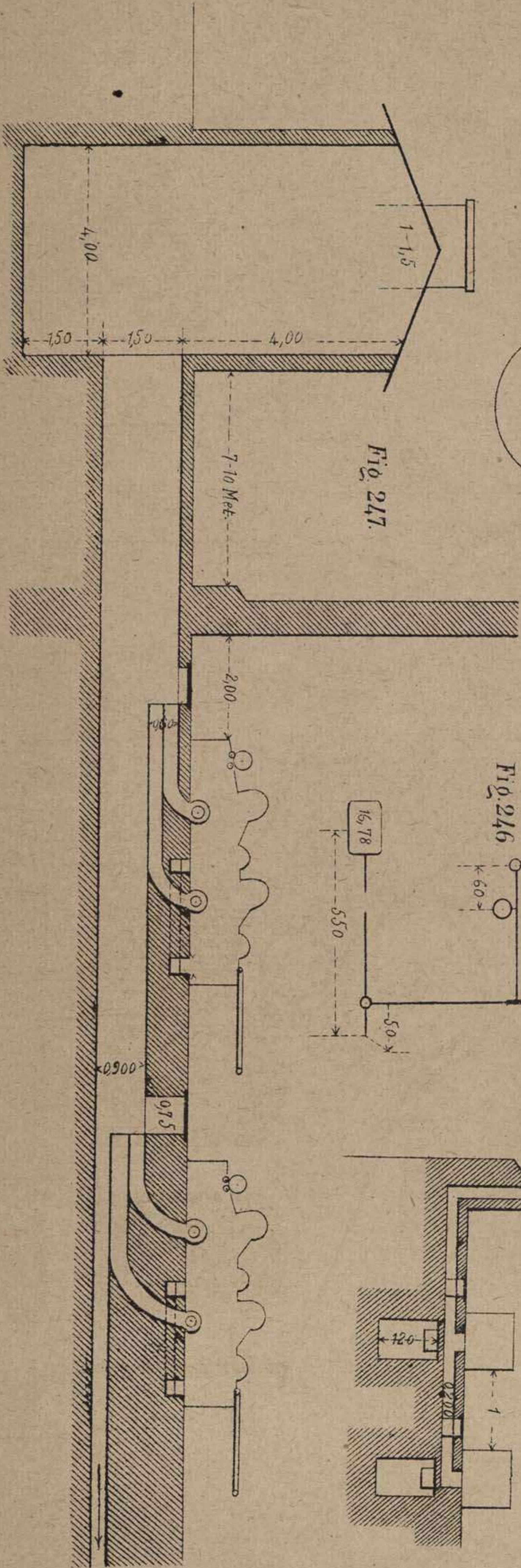


Fig. 247.

Fig 250

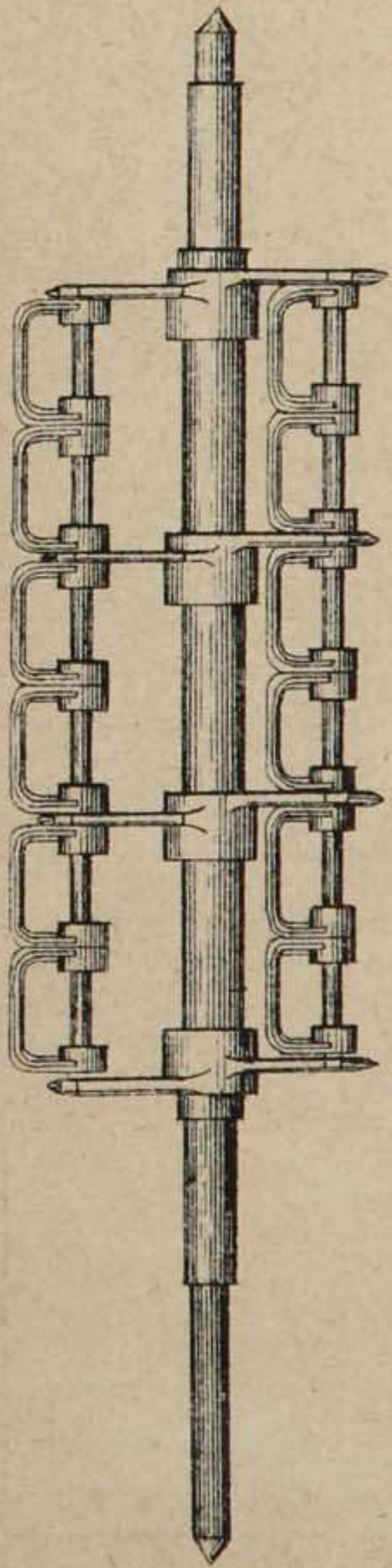


Fig 251

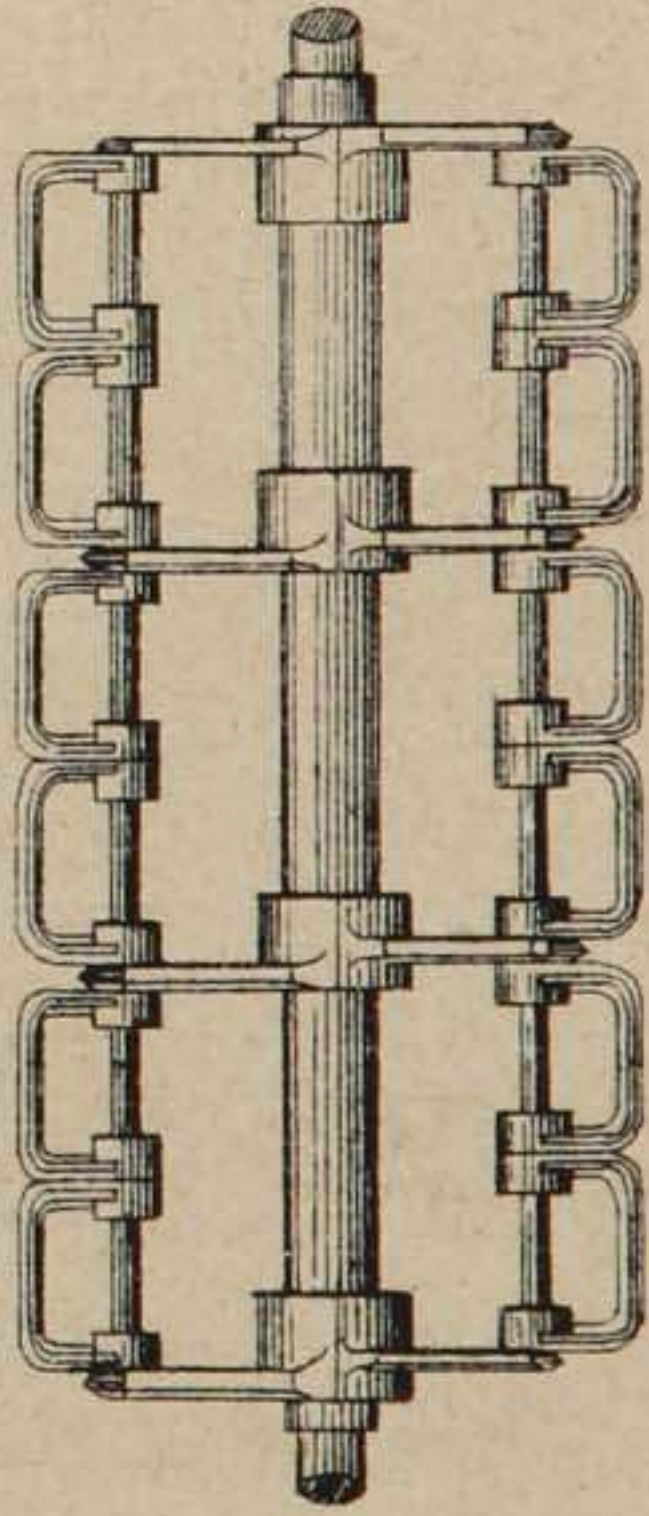


Fig 254

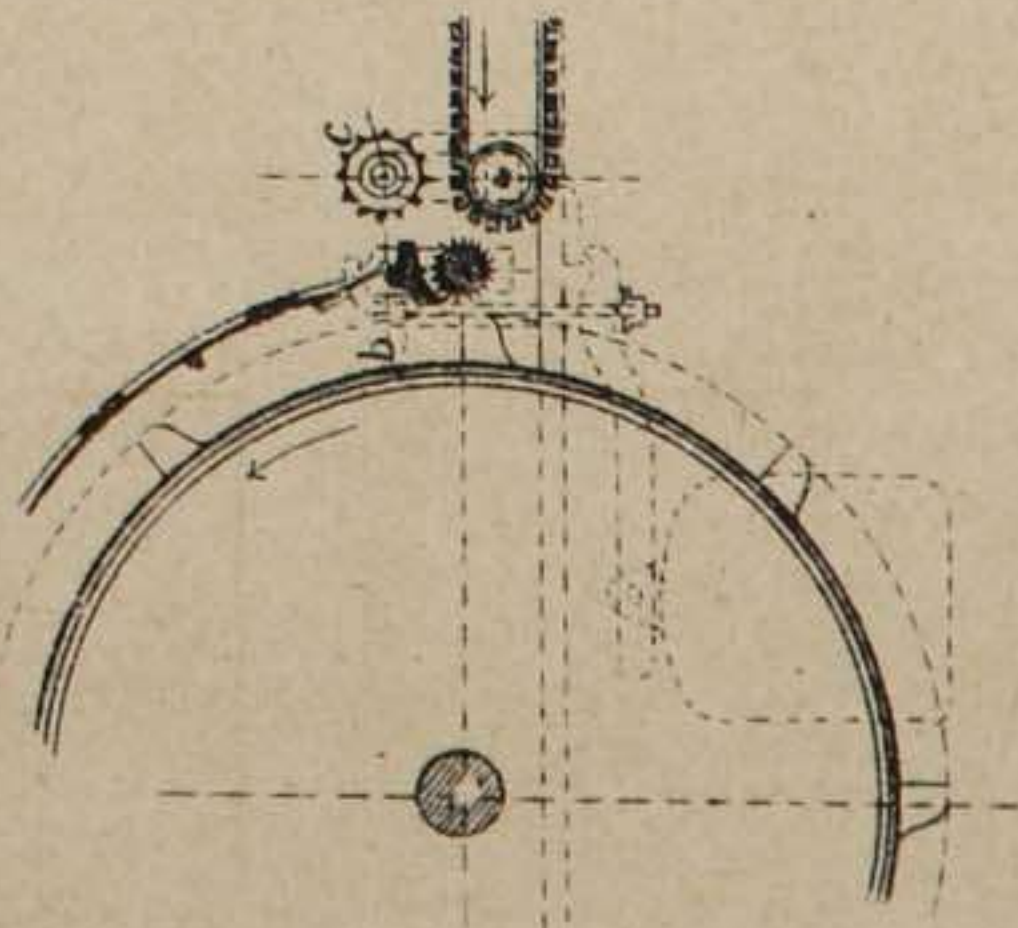


Fig 252

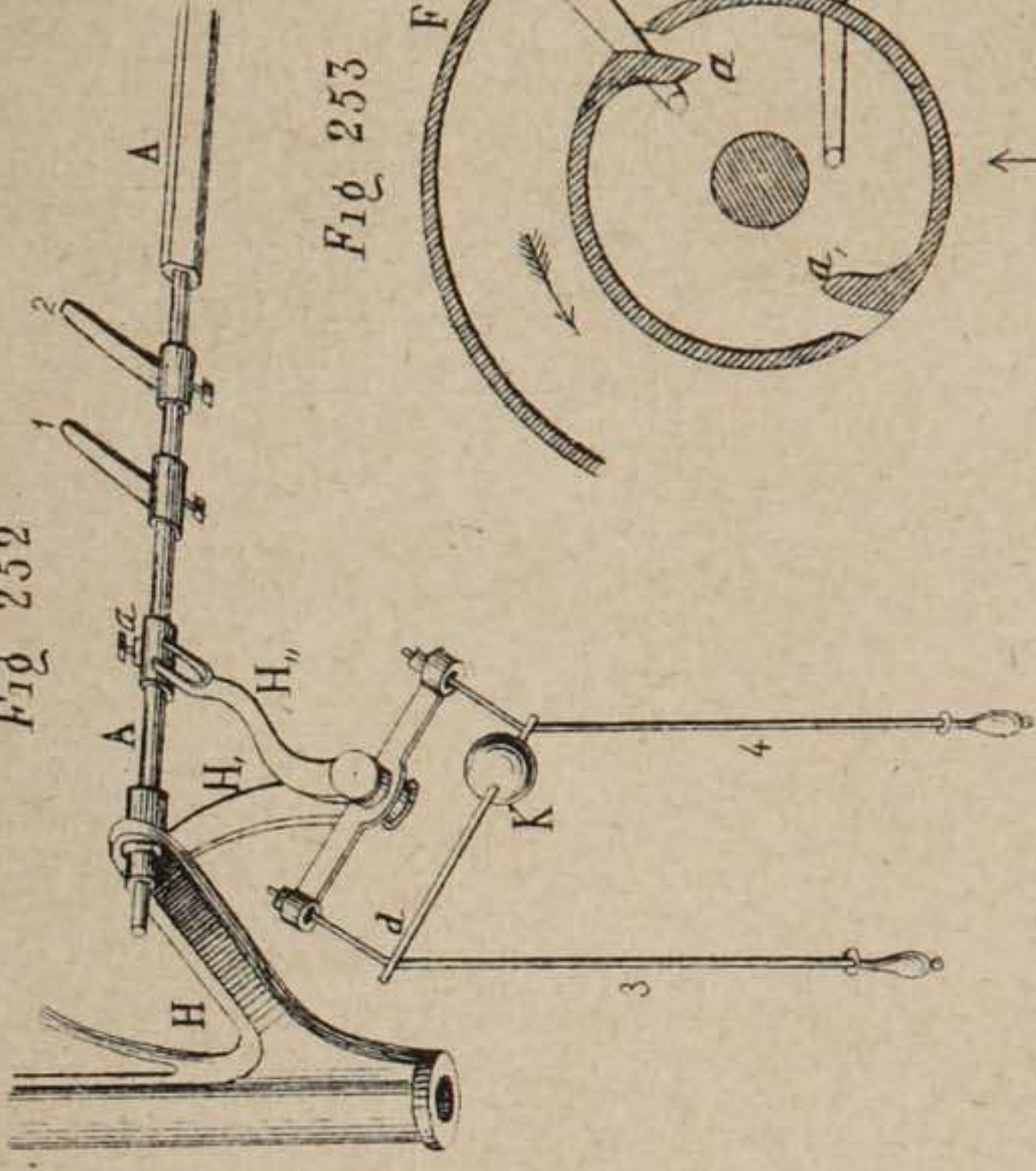


Fig 253

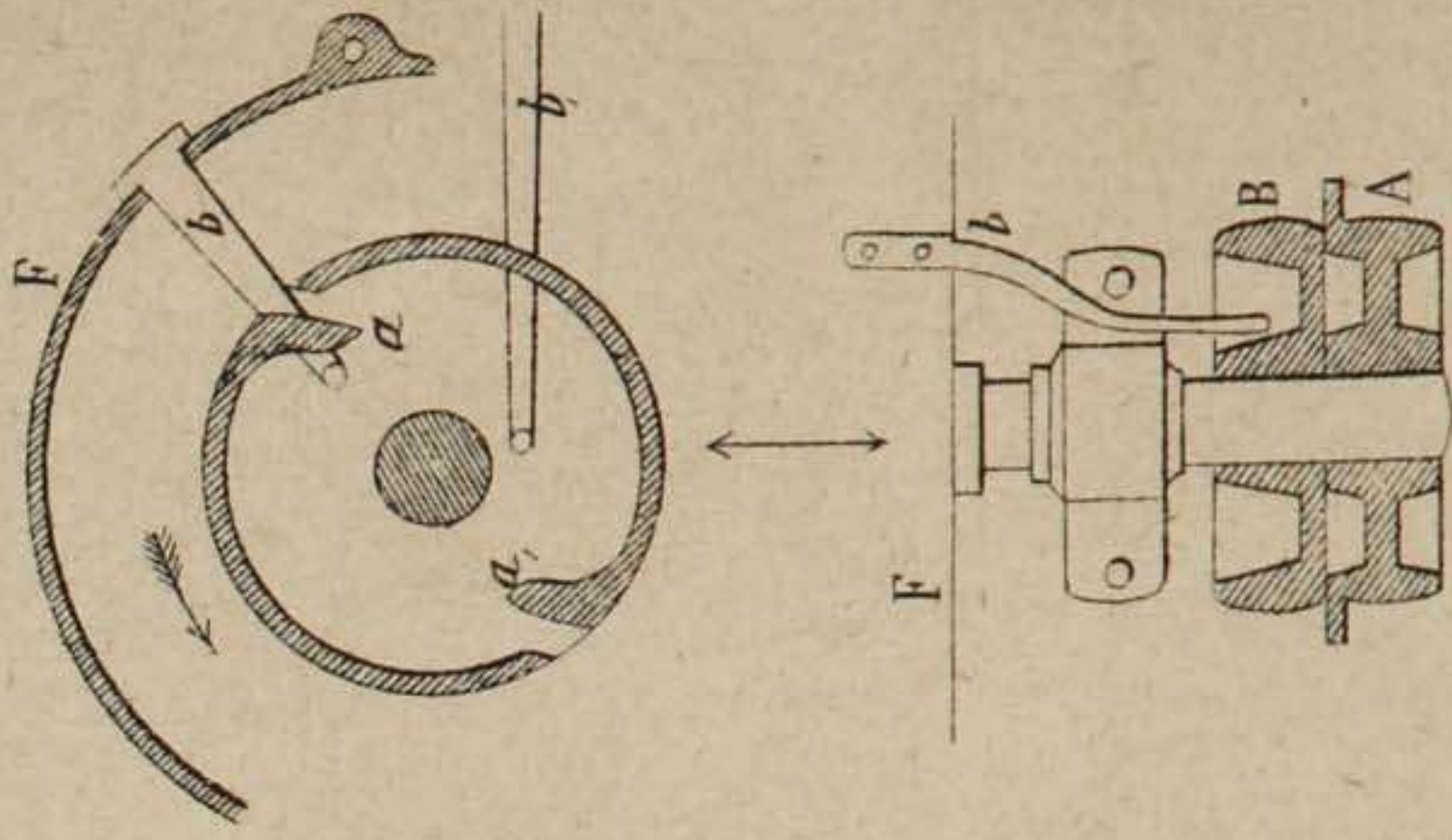


Fig 255

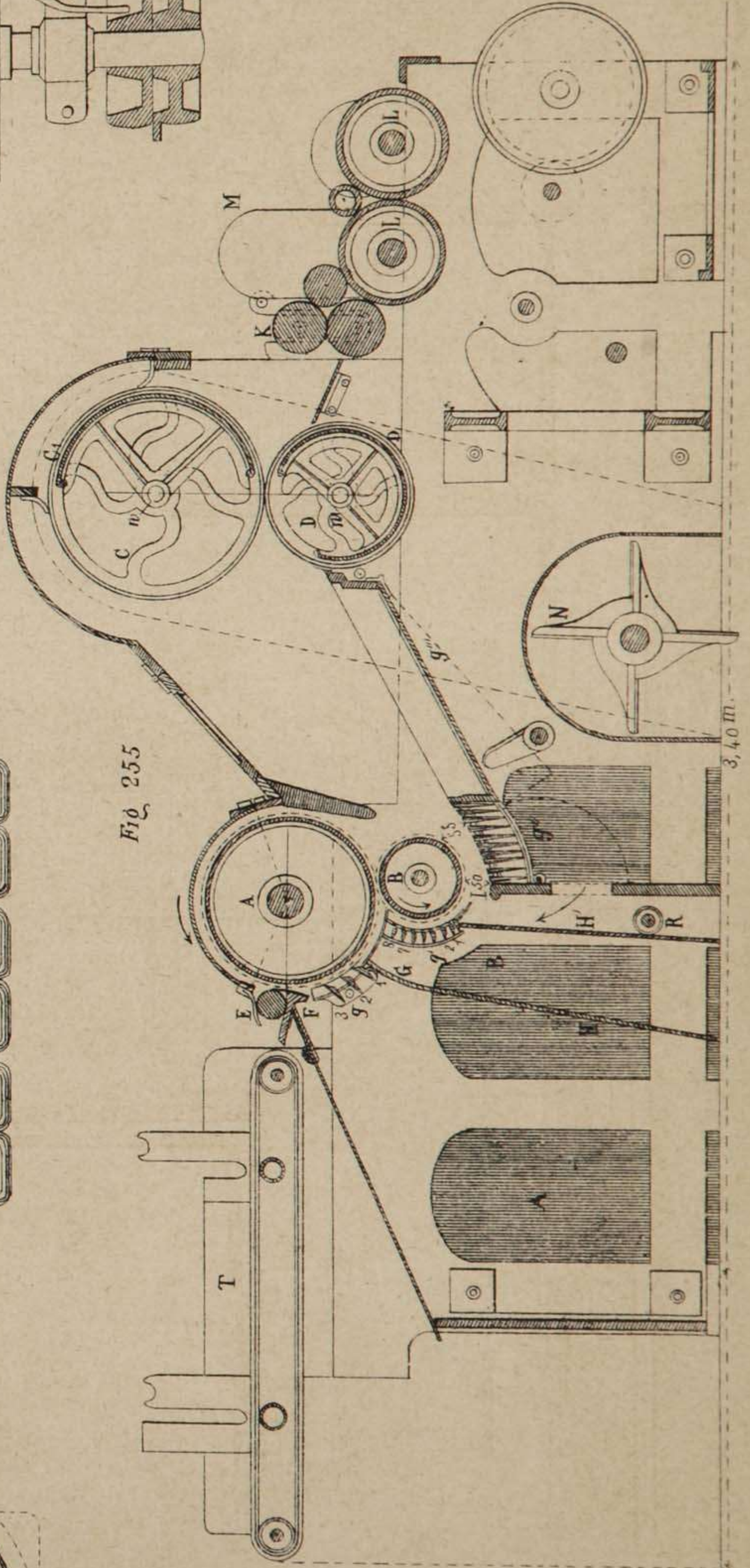


Fig. 258.

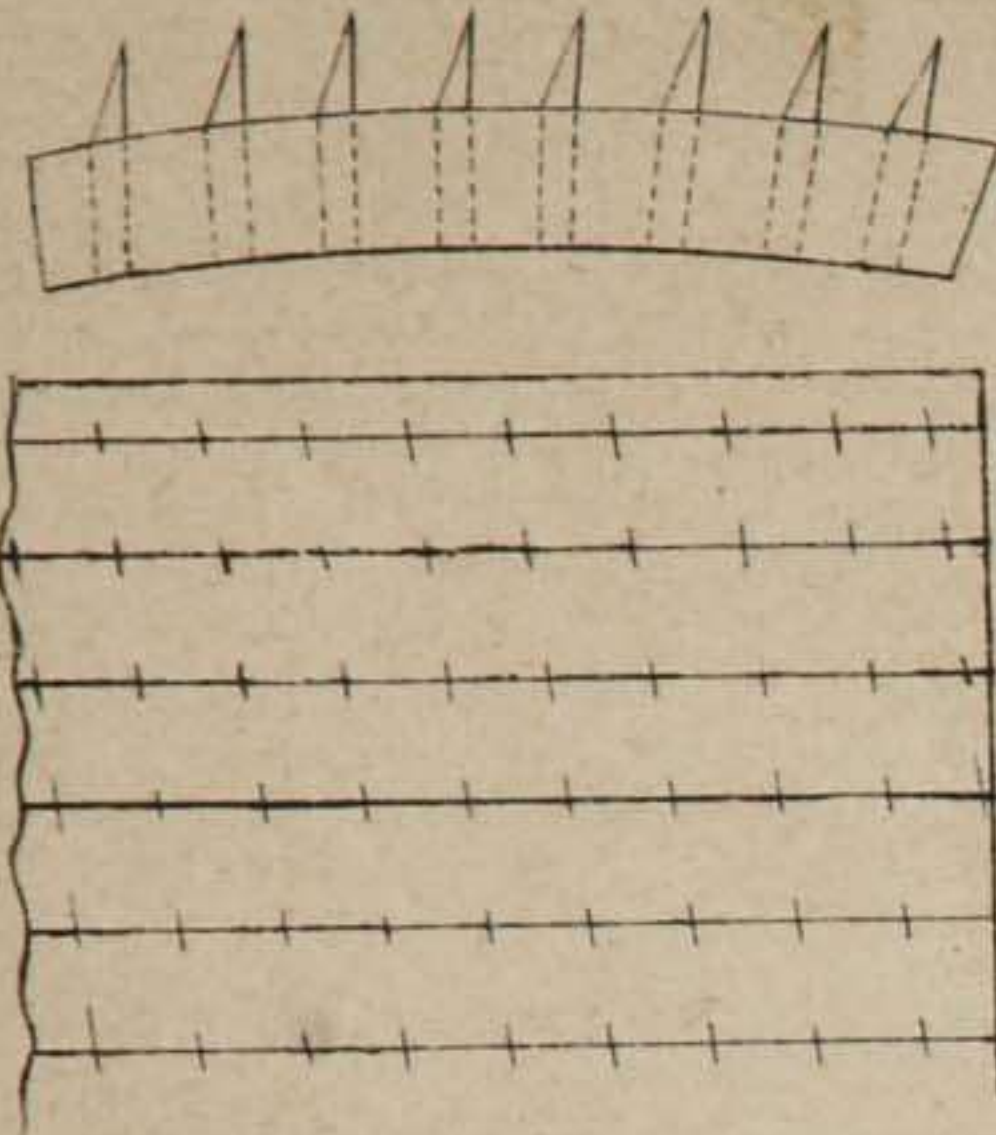


Fig. 257.

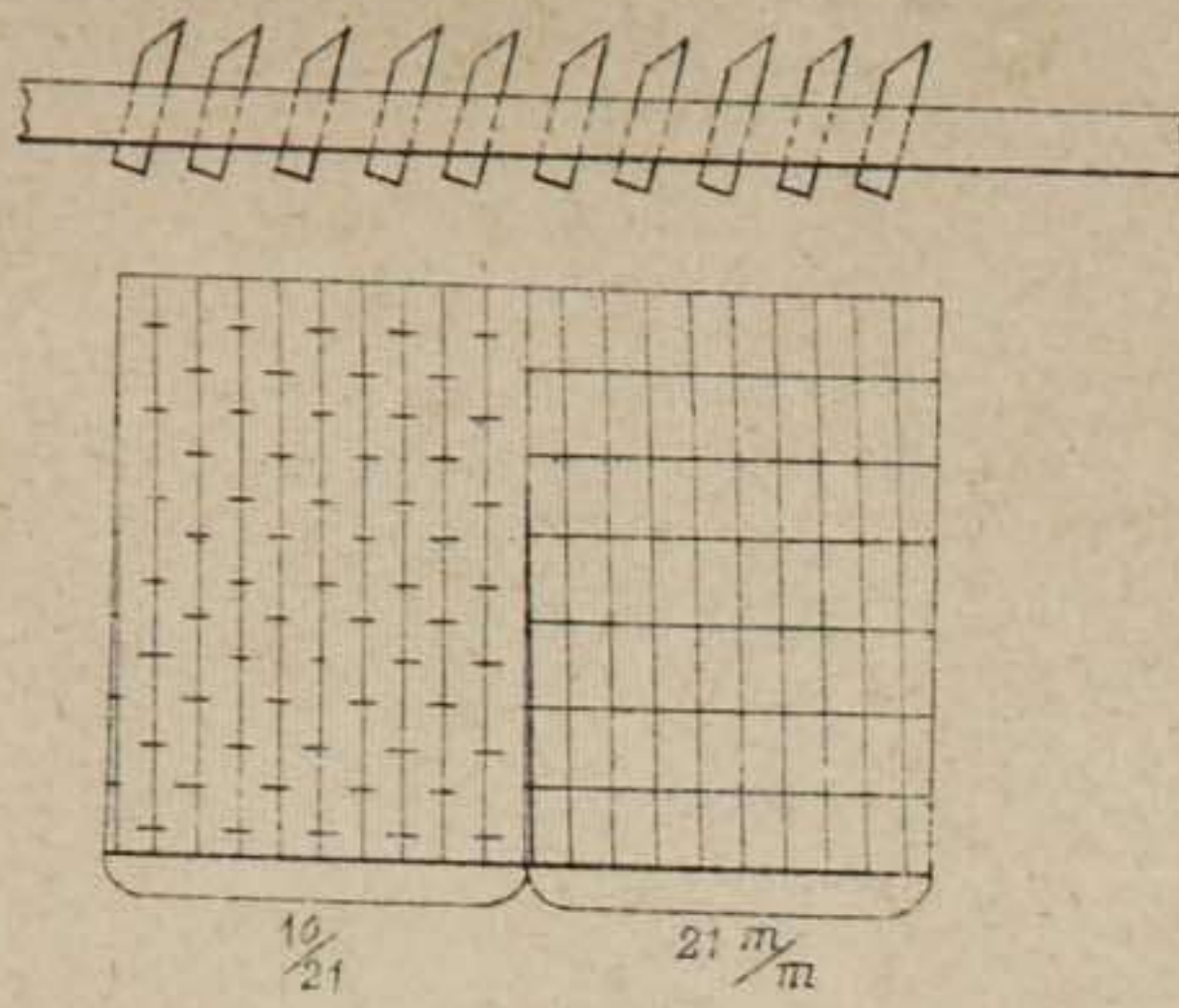


Fig. 256.

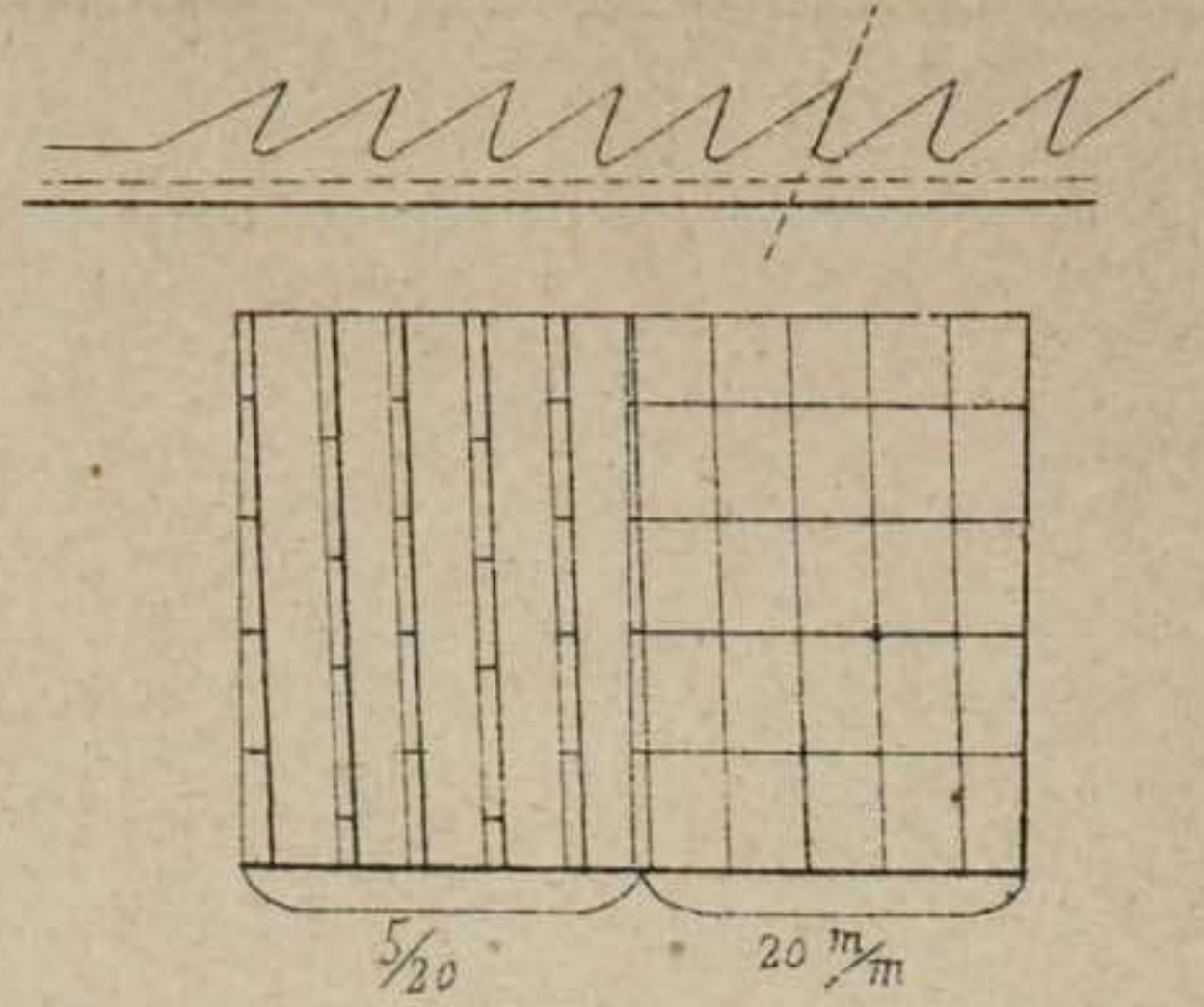


Fig. 268.

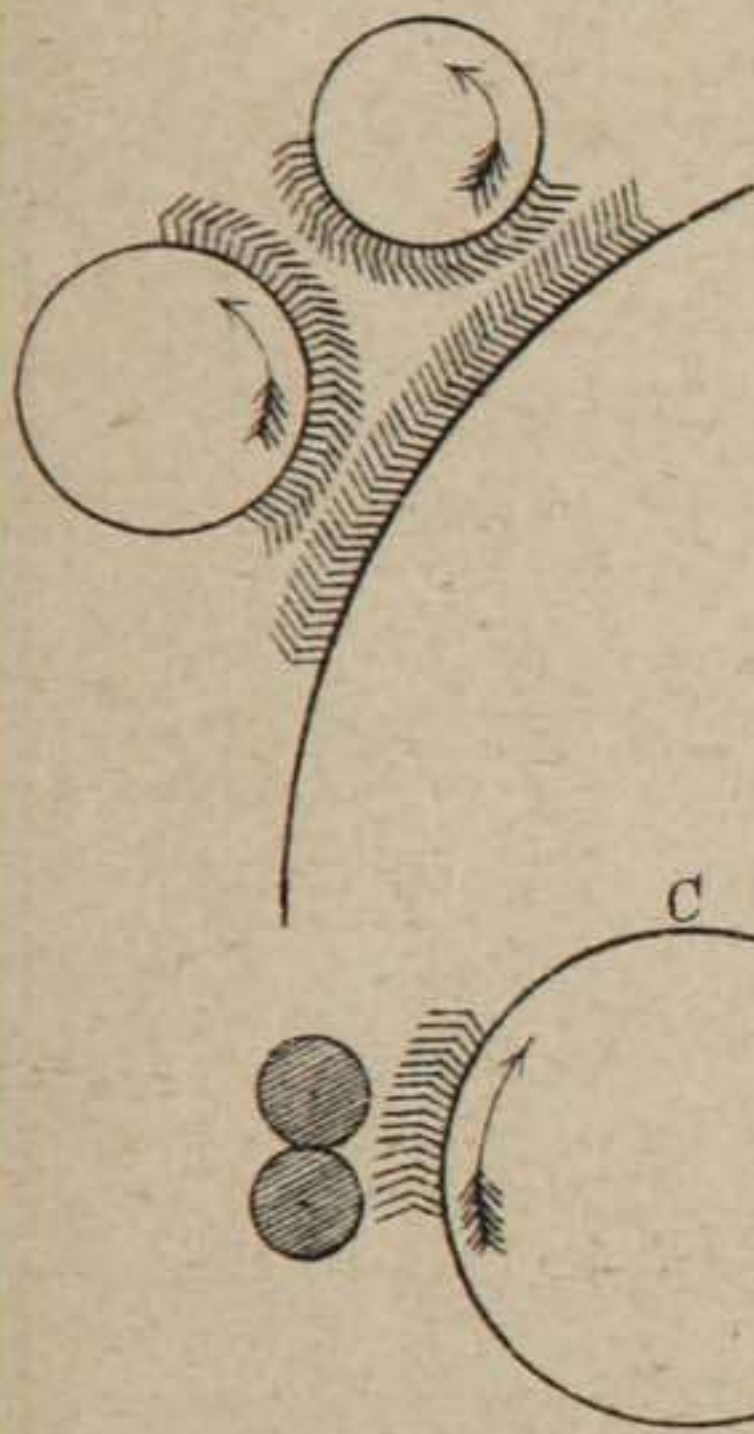


Fig. 270.

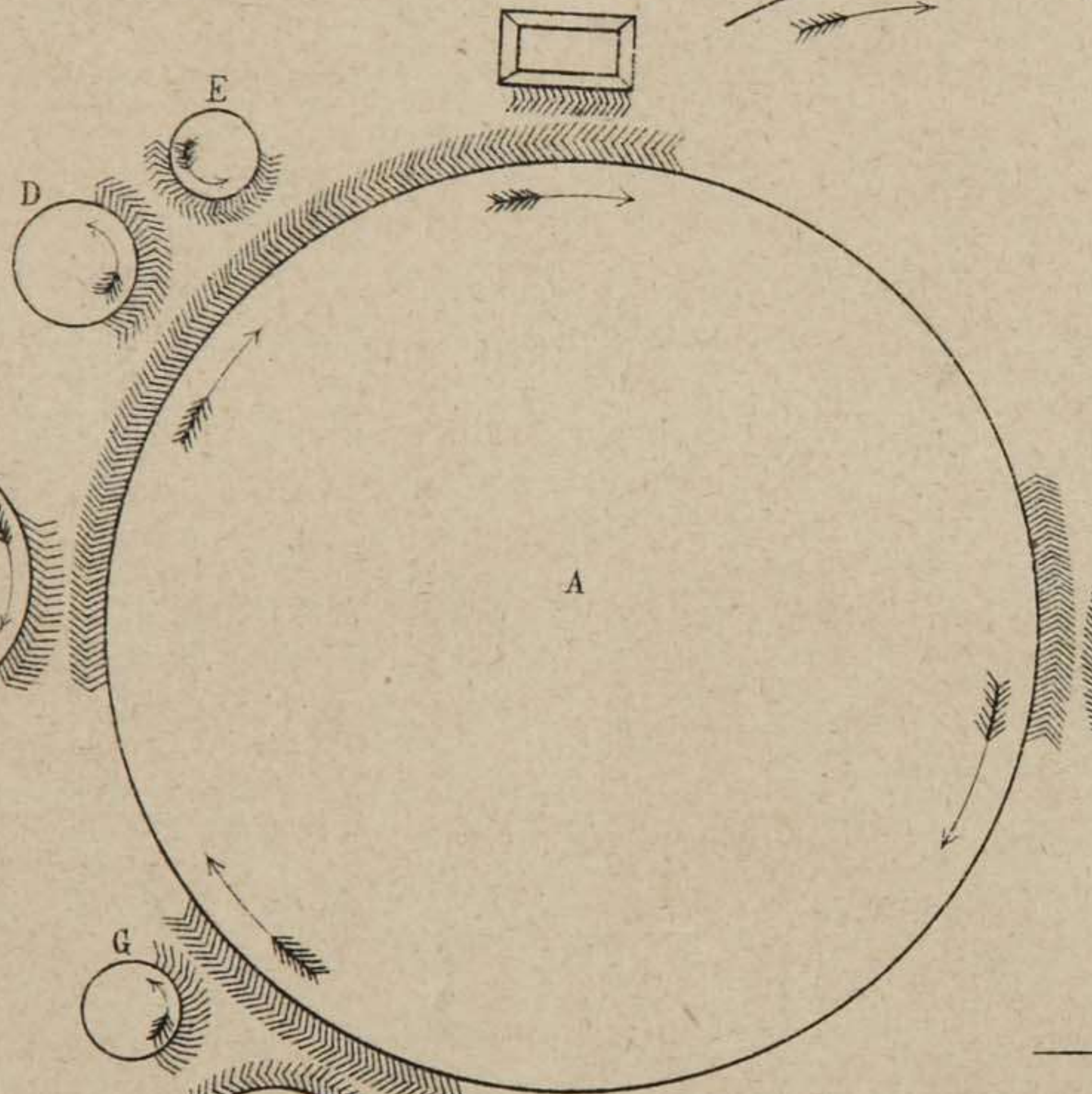


Fig. 266.

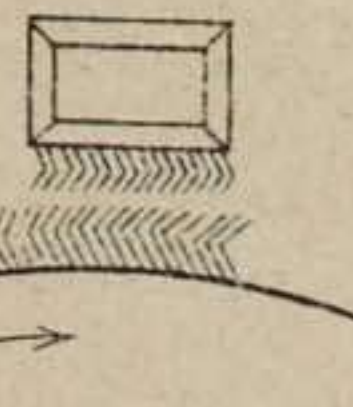


Fig. 267.

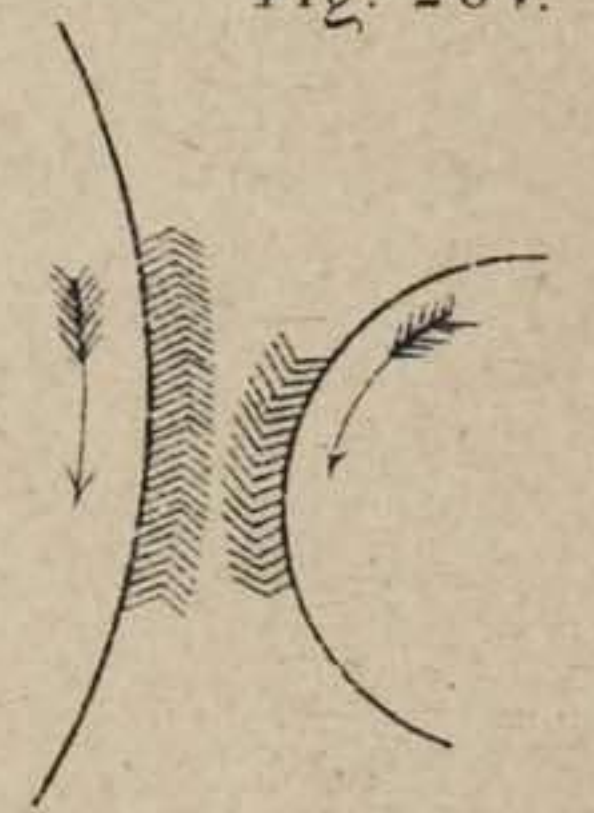


Fig. 264.

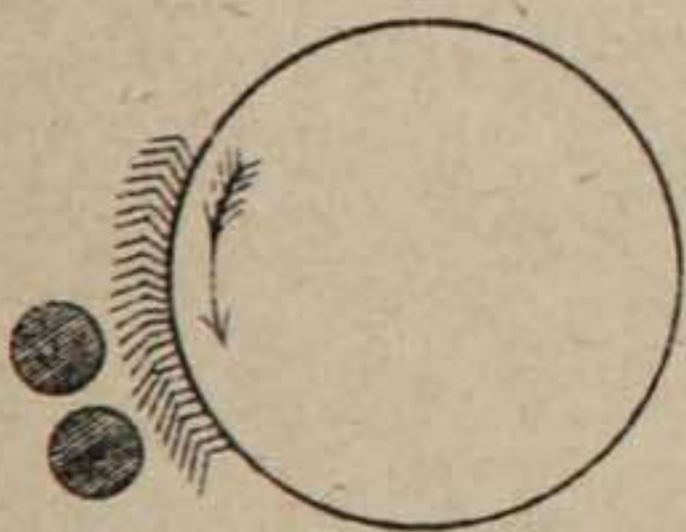


Fig. 261.

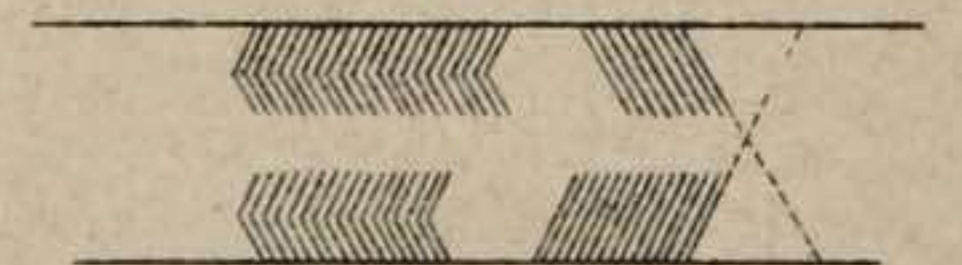


Fig. 265.

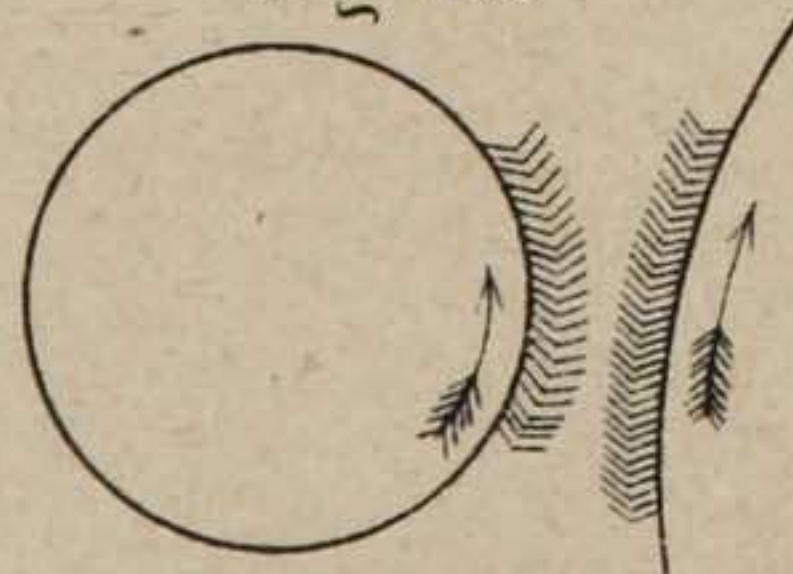


Fig. 260.

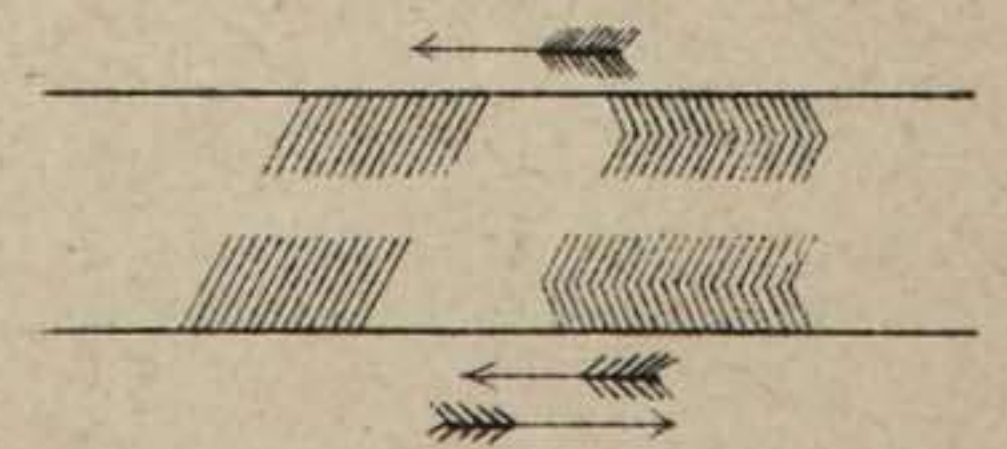


Fig. 269.

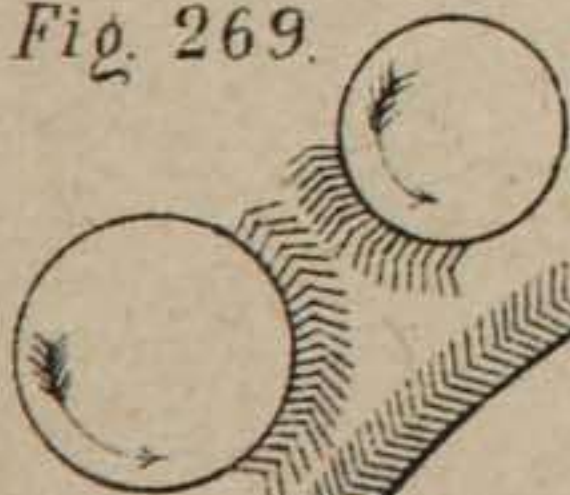


Fig. 263.

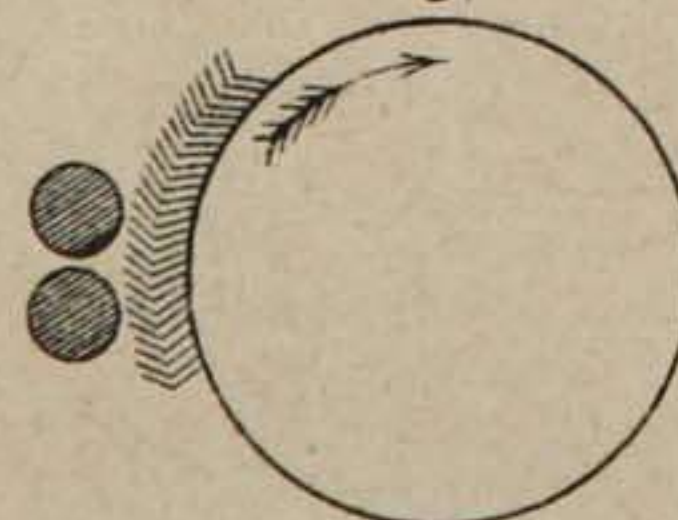


Fig. 259.

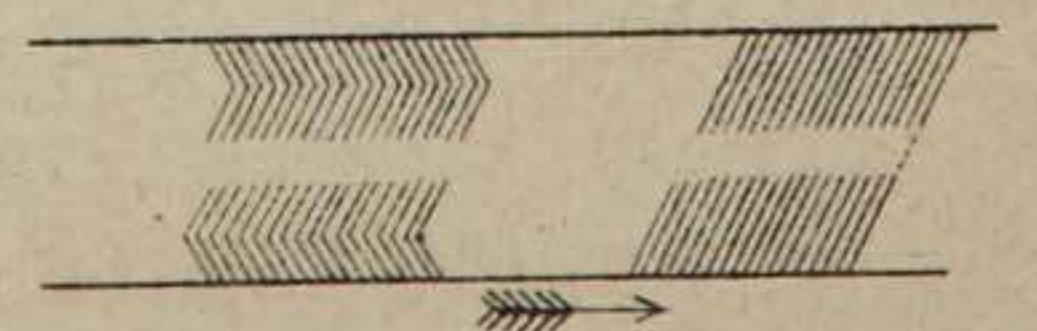


Fig. 262.



Fig. 290.

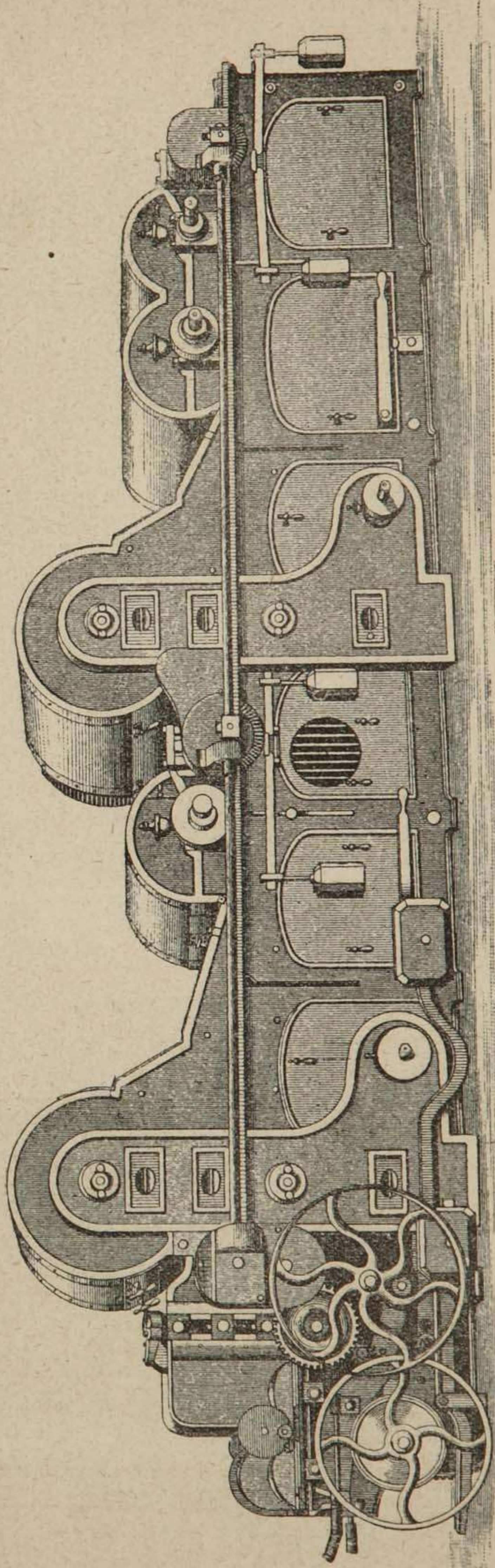
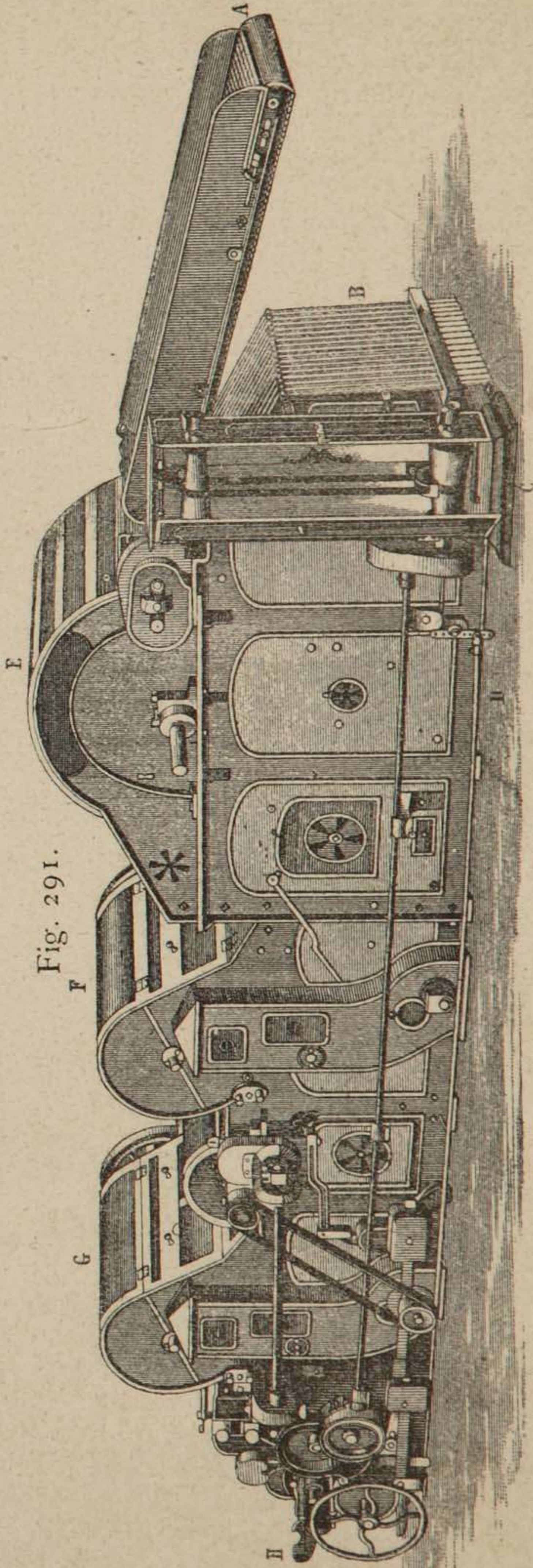


Fig. 291.



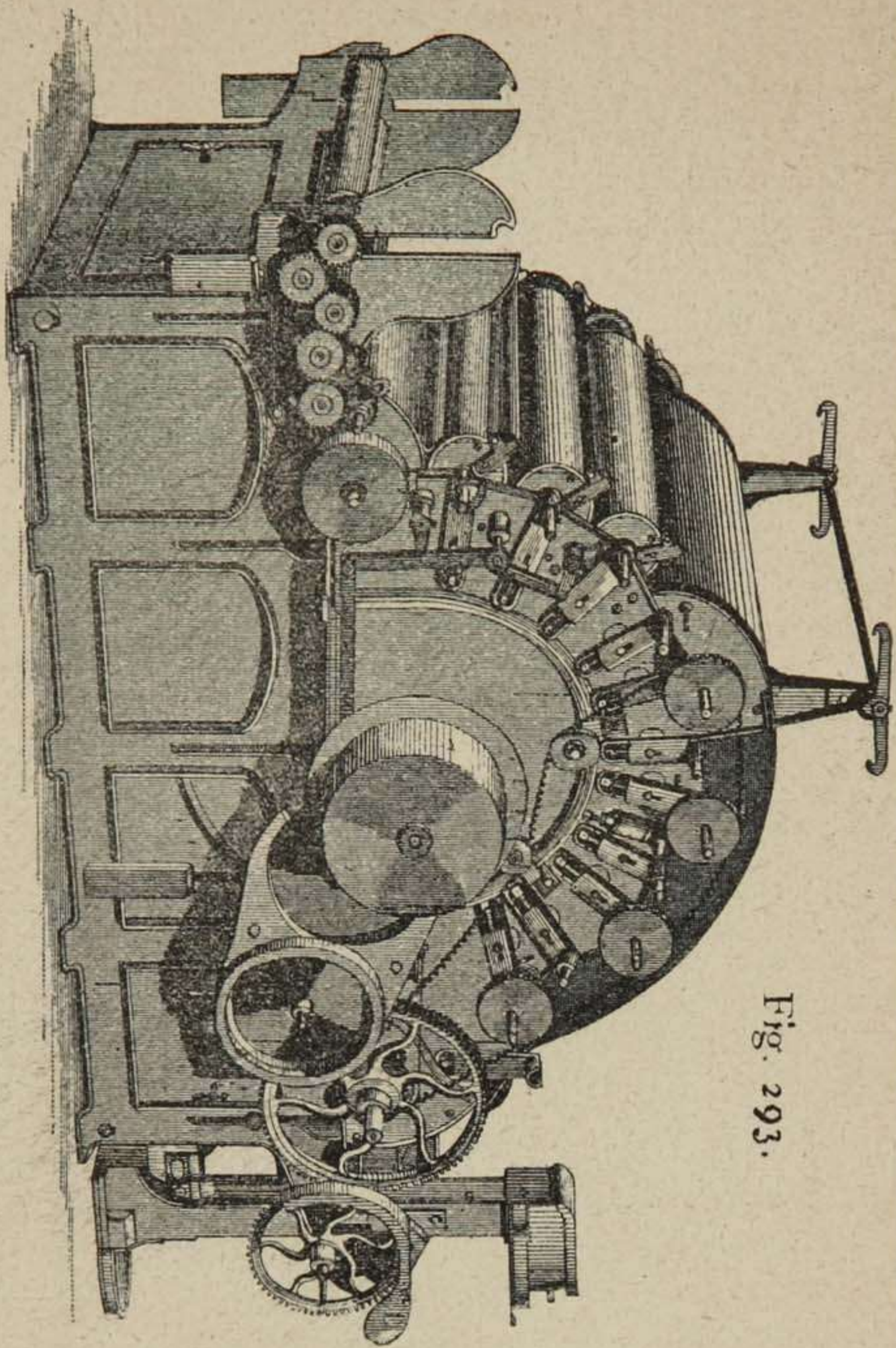


Fig. 293.

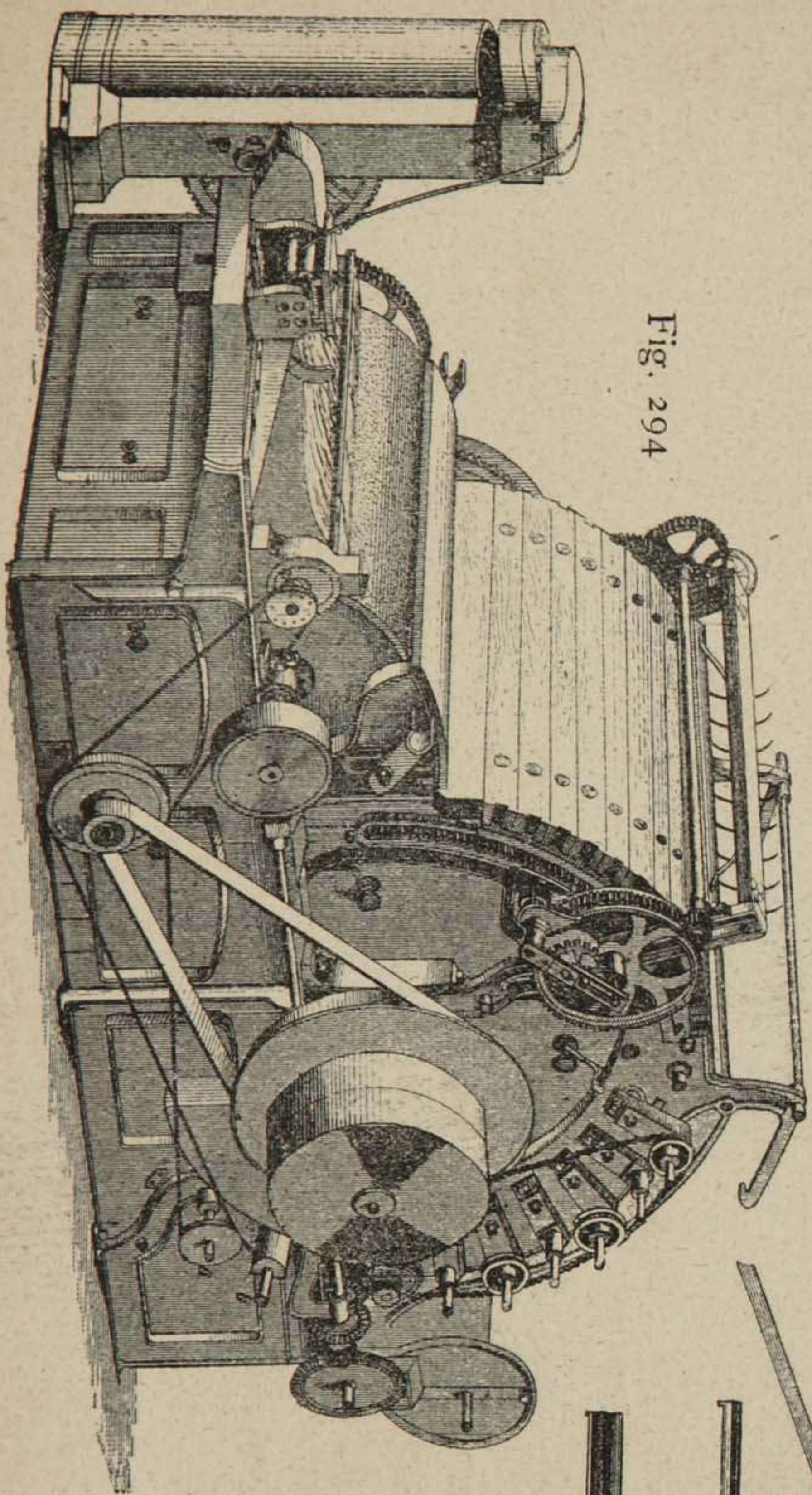


Fig. 294

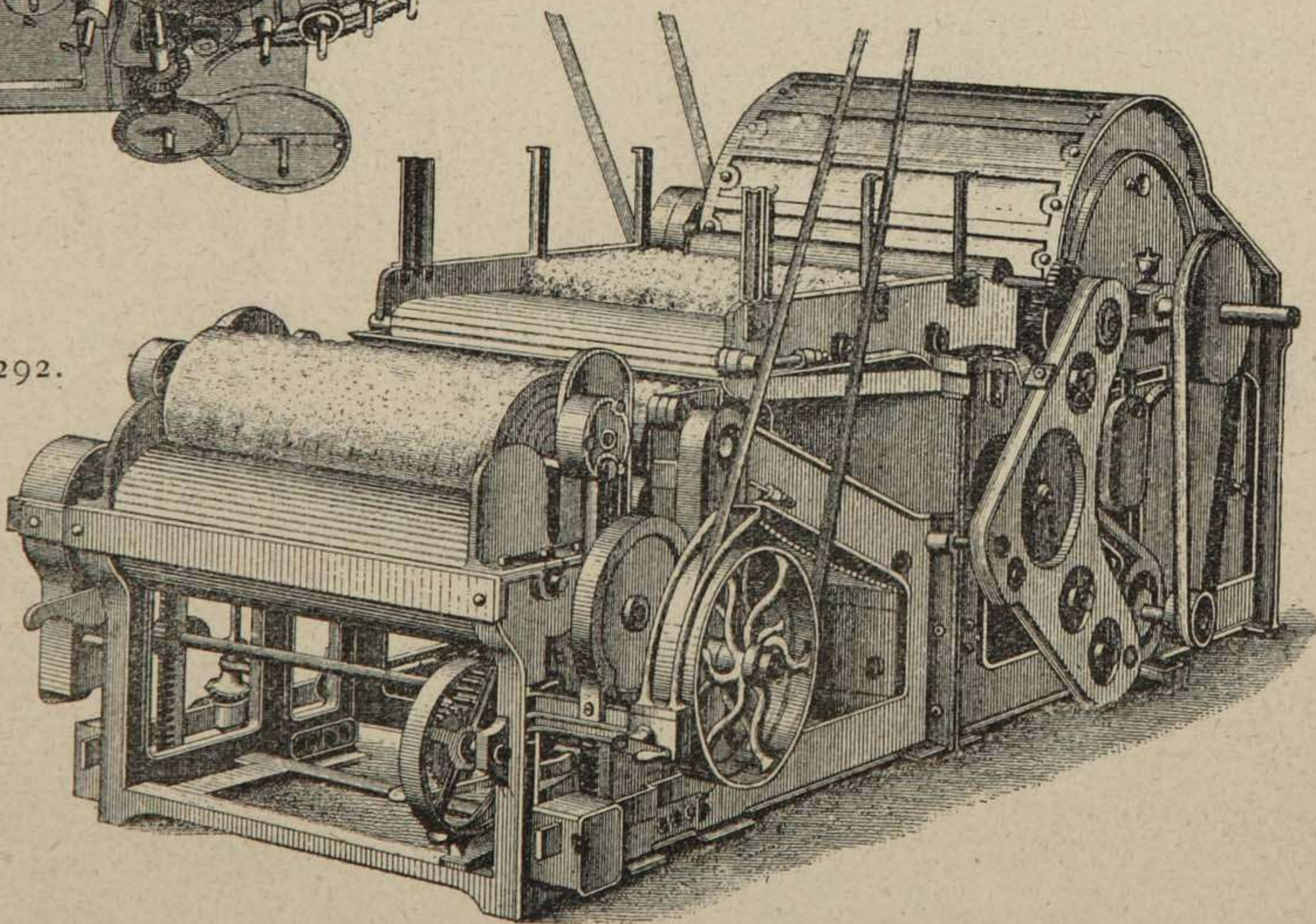


Fig. 292.

Fig. 295.

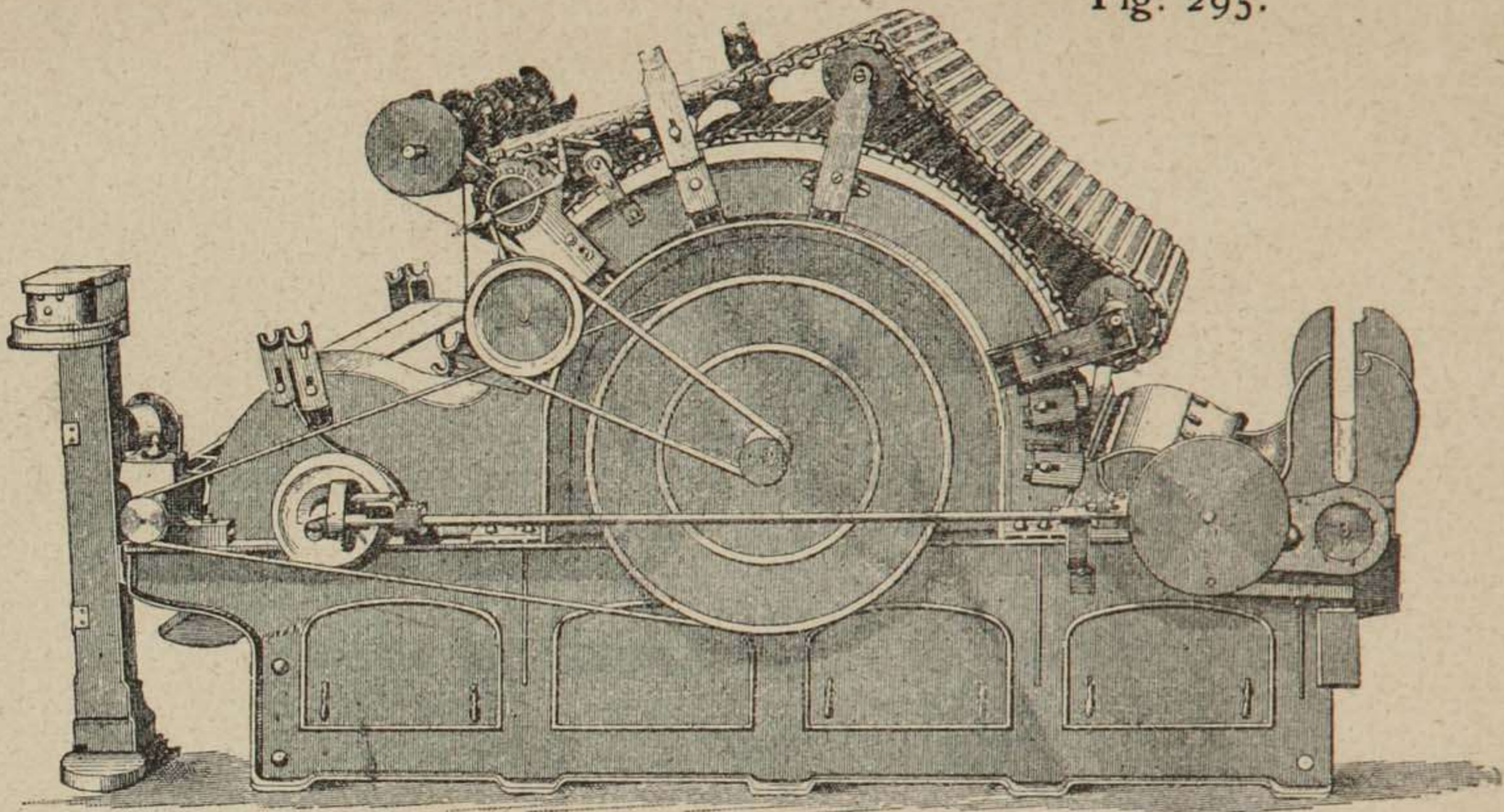


Fig. 296.

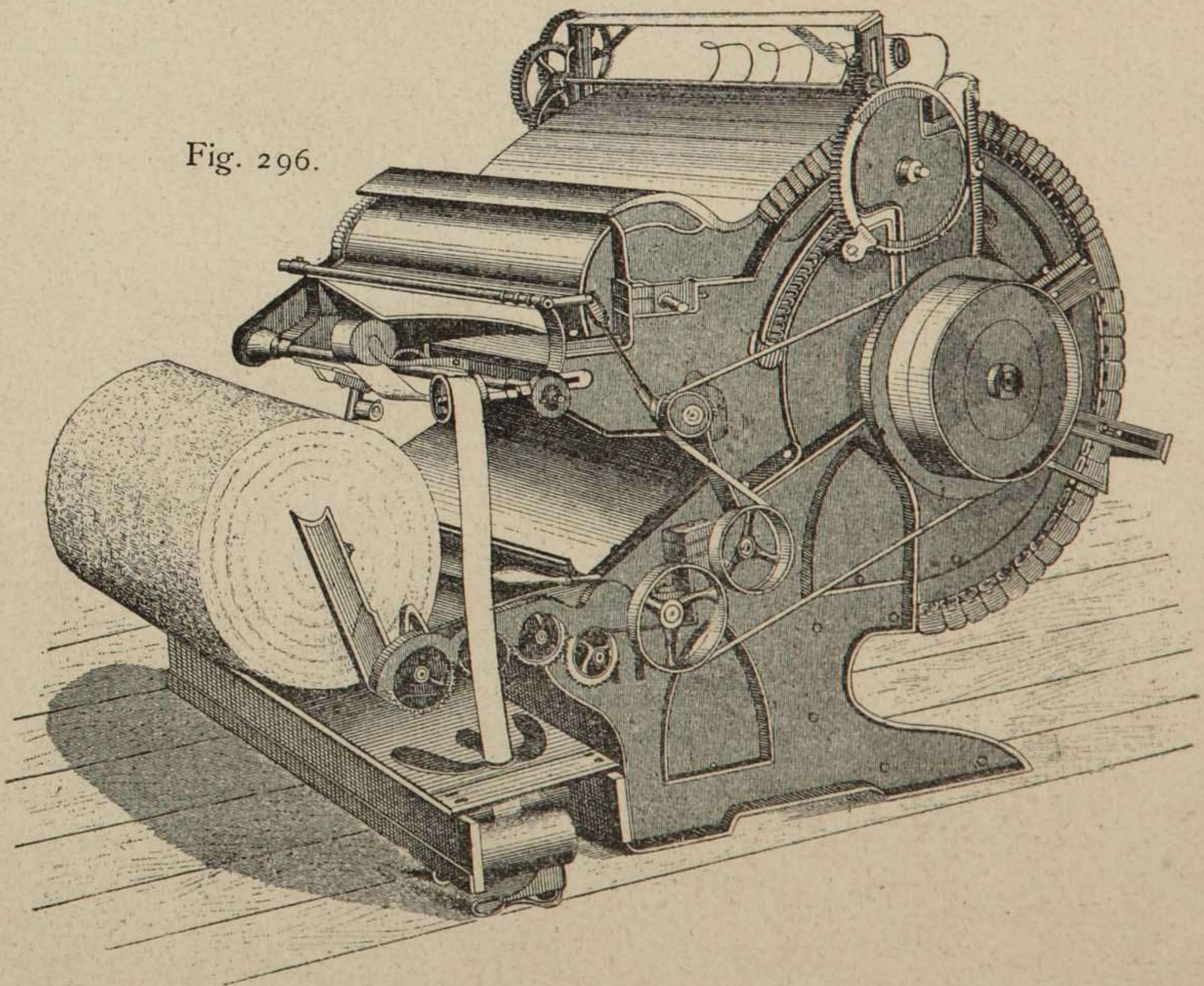


Fig. 298.

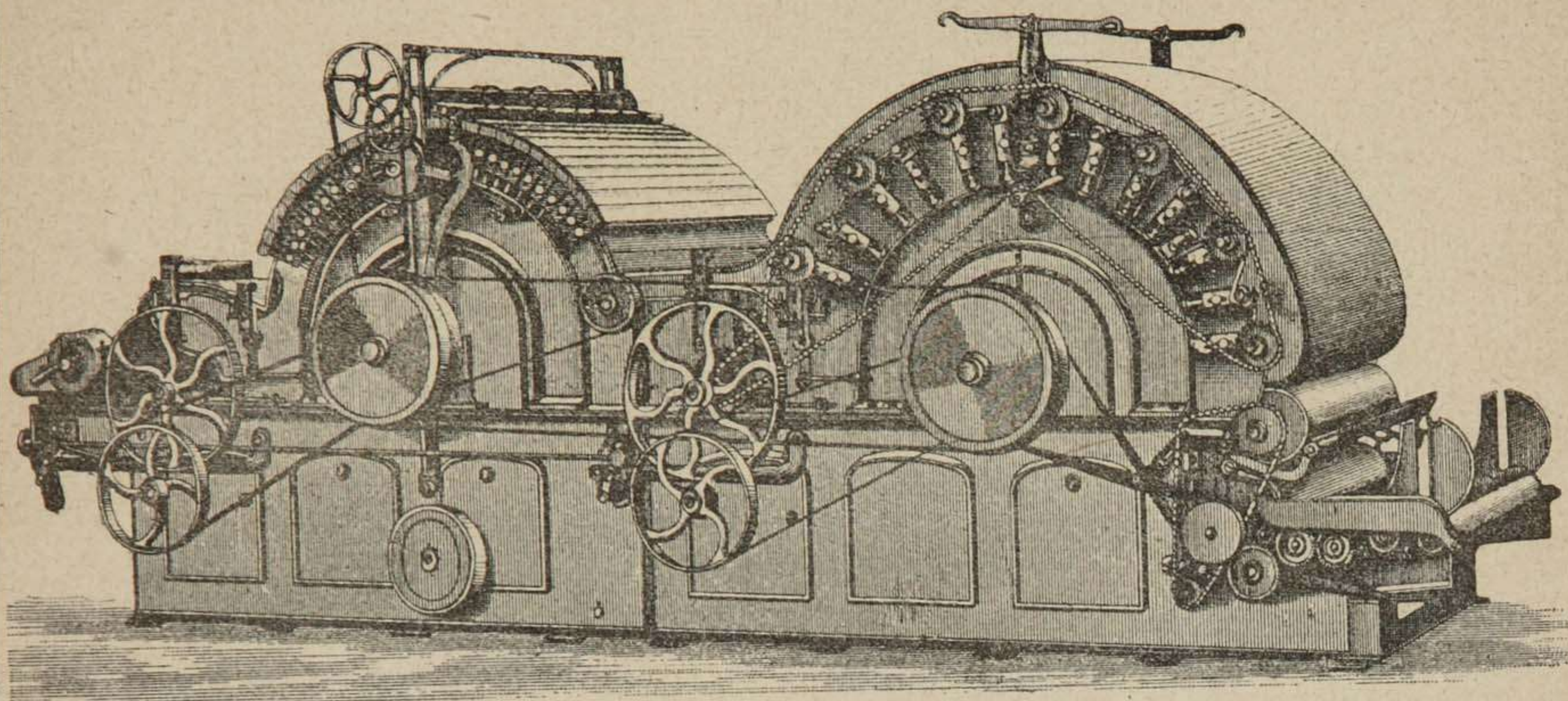


Fig. 297.

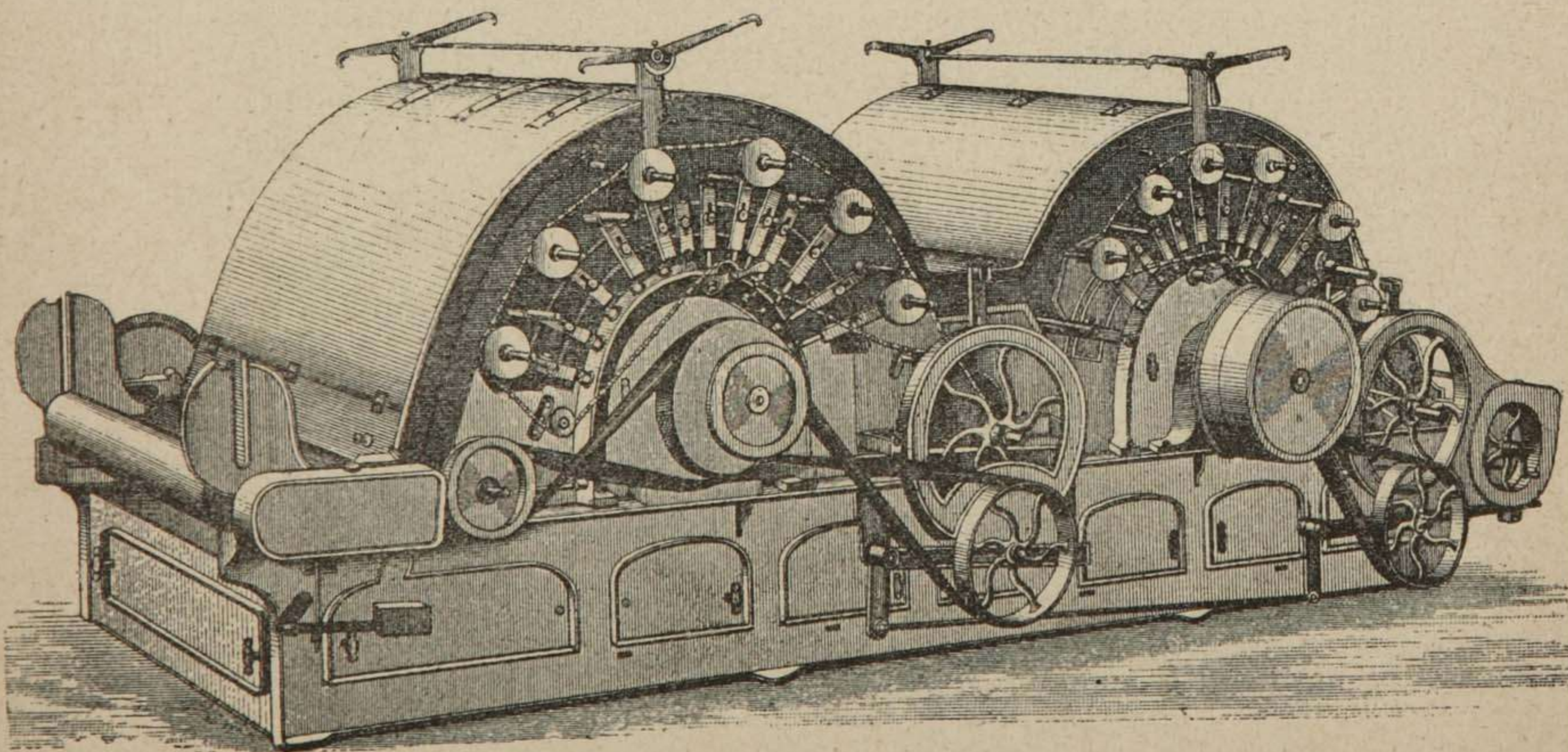


Fig. 271.



Fig. 272.



Fig. 278.



Fig. 287.

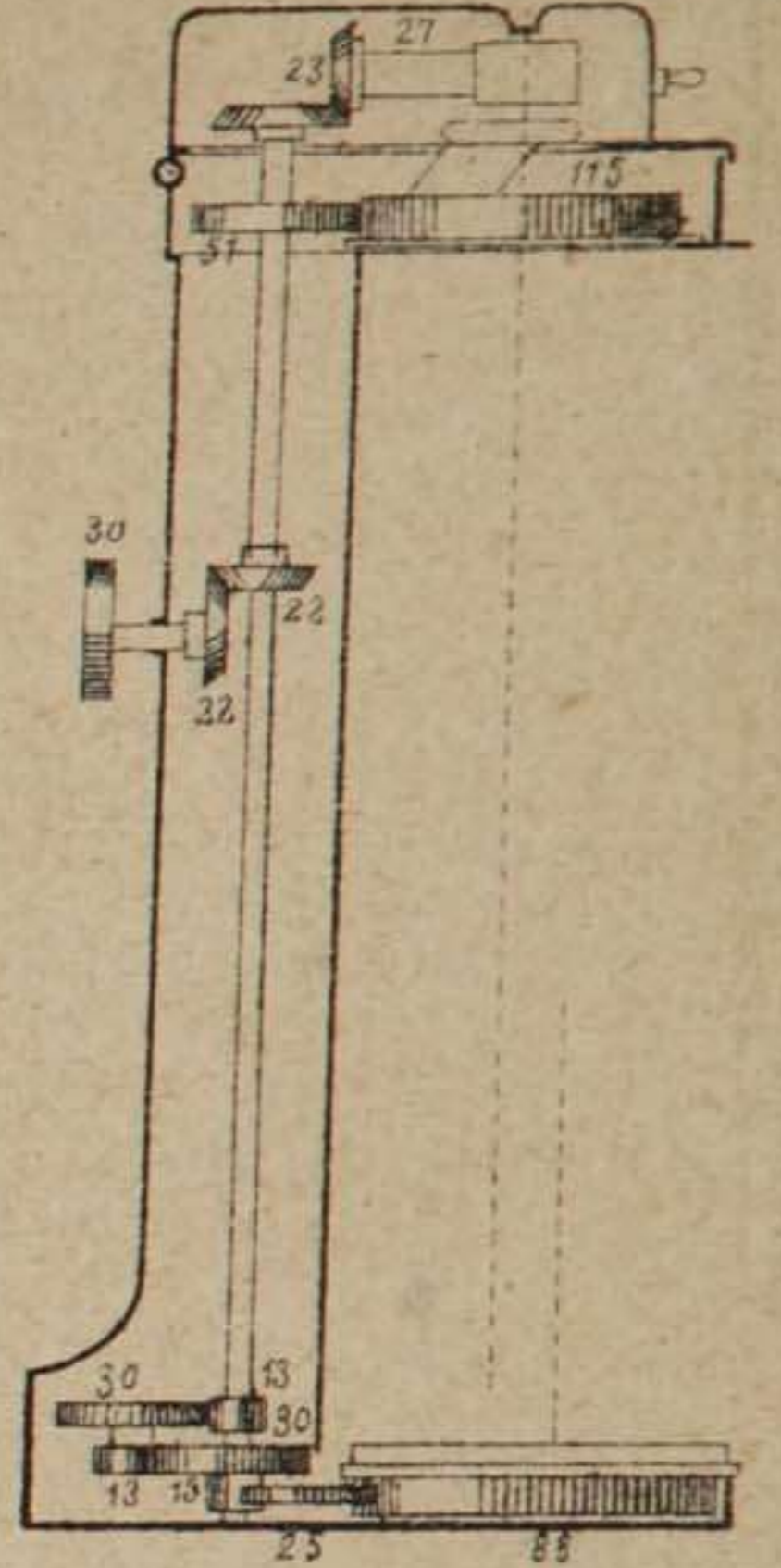


Fig. 273.



Fig. 274.



Fig. 275.



Fig. 276.

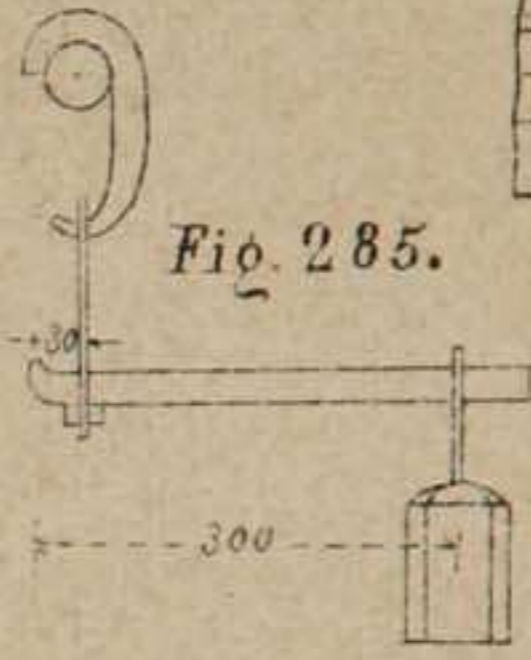


Fig. 285.

Fig. 277.

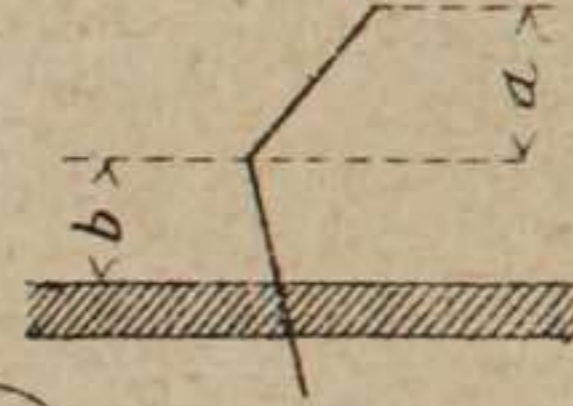


Fig. 281.

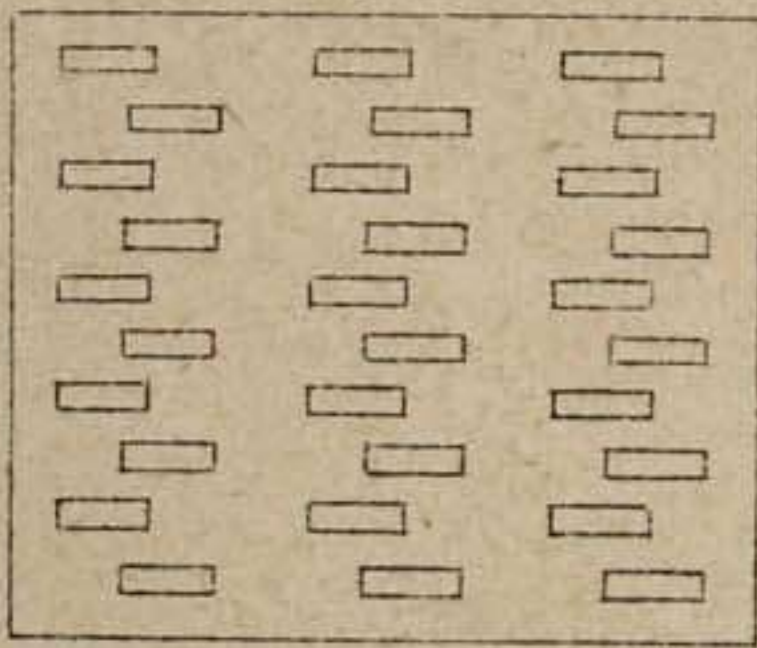


Fig. 284.

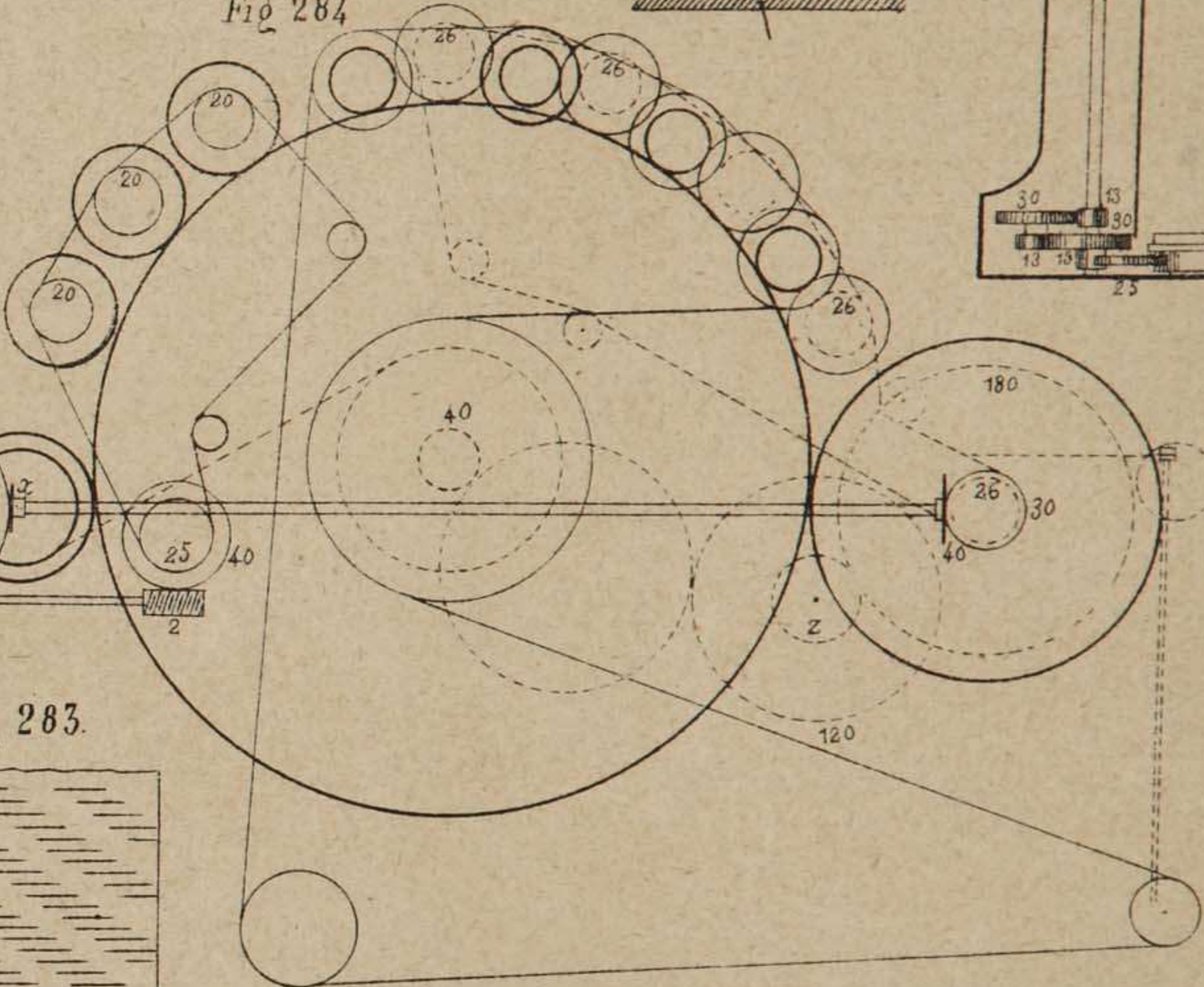


Fig. 280.



Fig. 283.



Fig. 288.

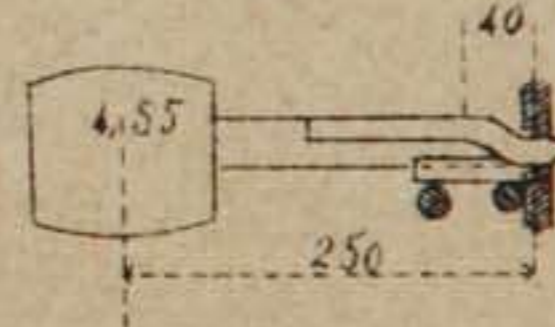


Fig. 282.



Fig. 279.

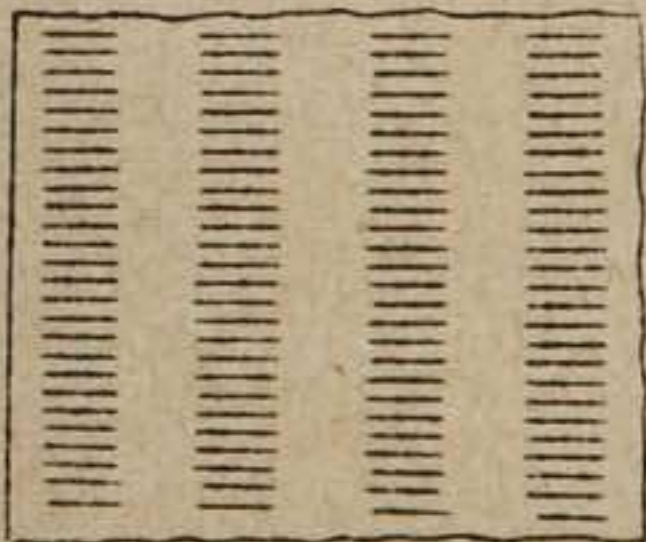


Fig. 286.

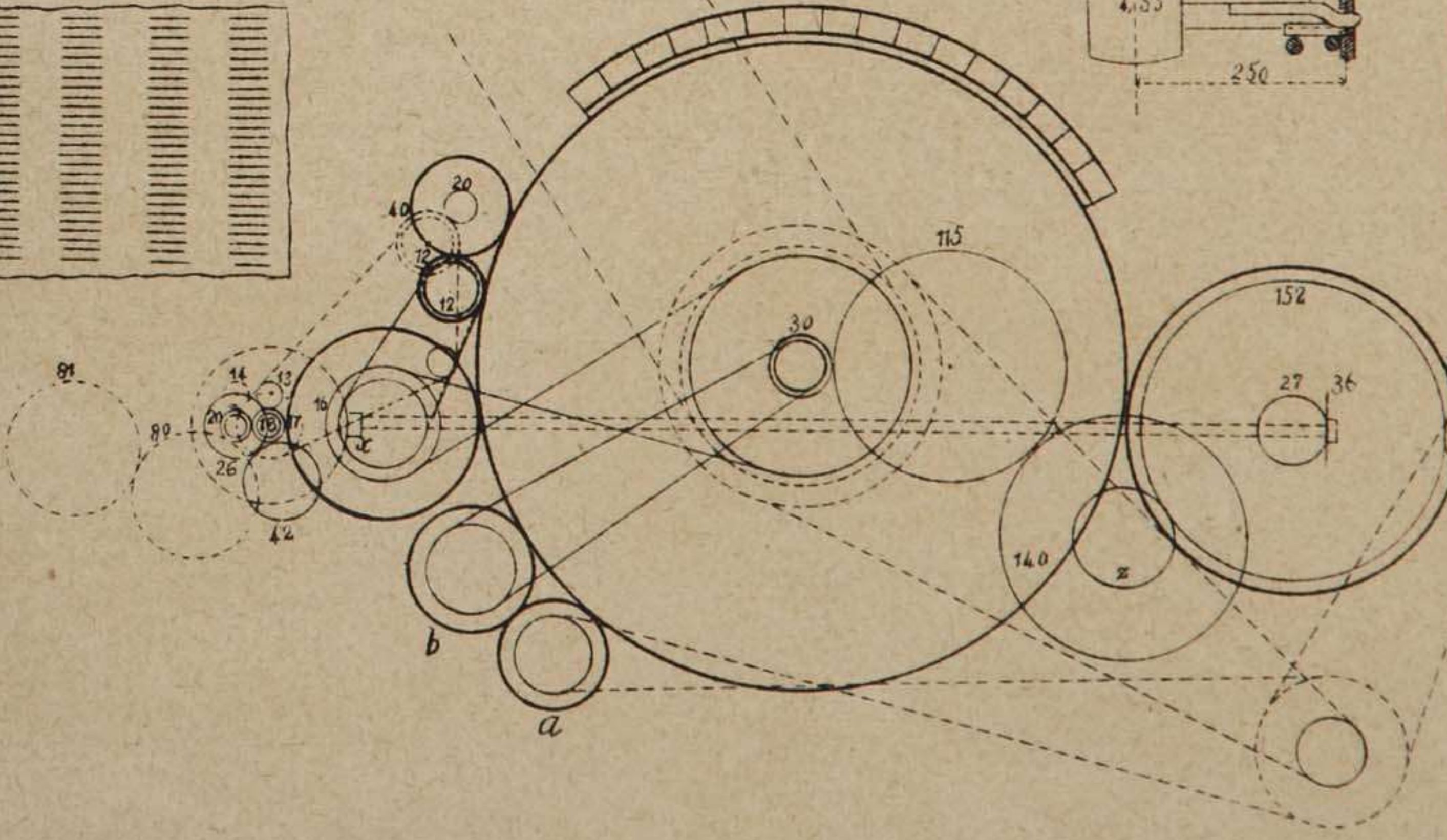


Fig. 289.

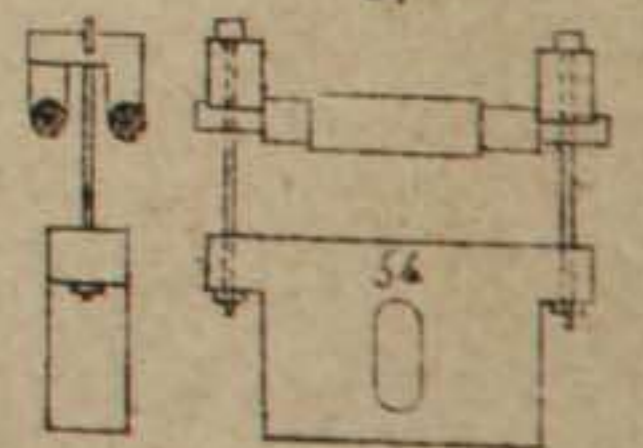


Fig. 303.

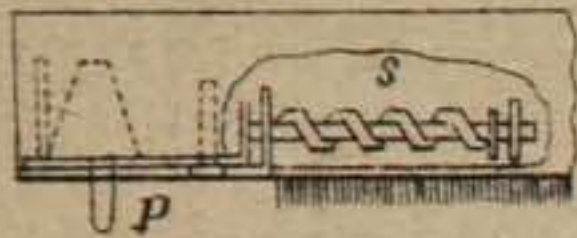


Fig. 299

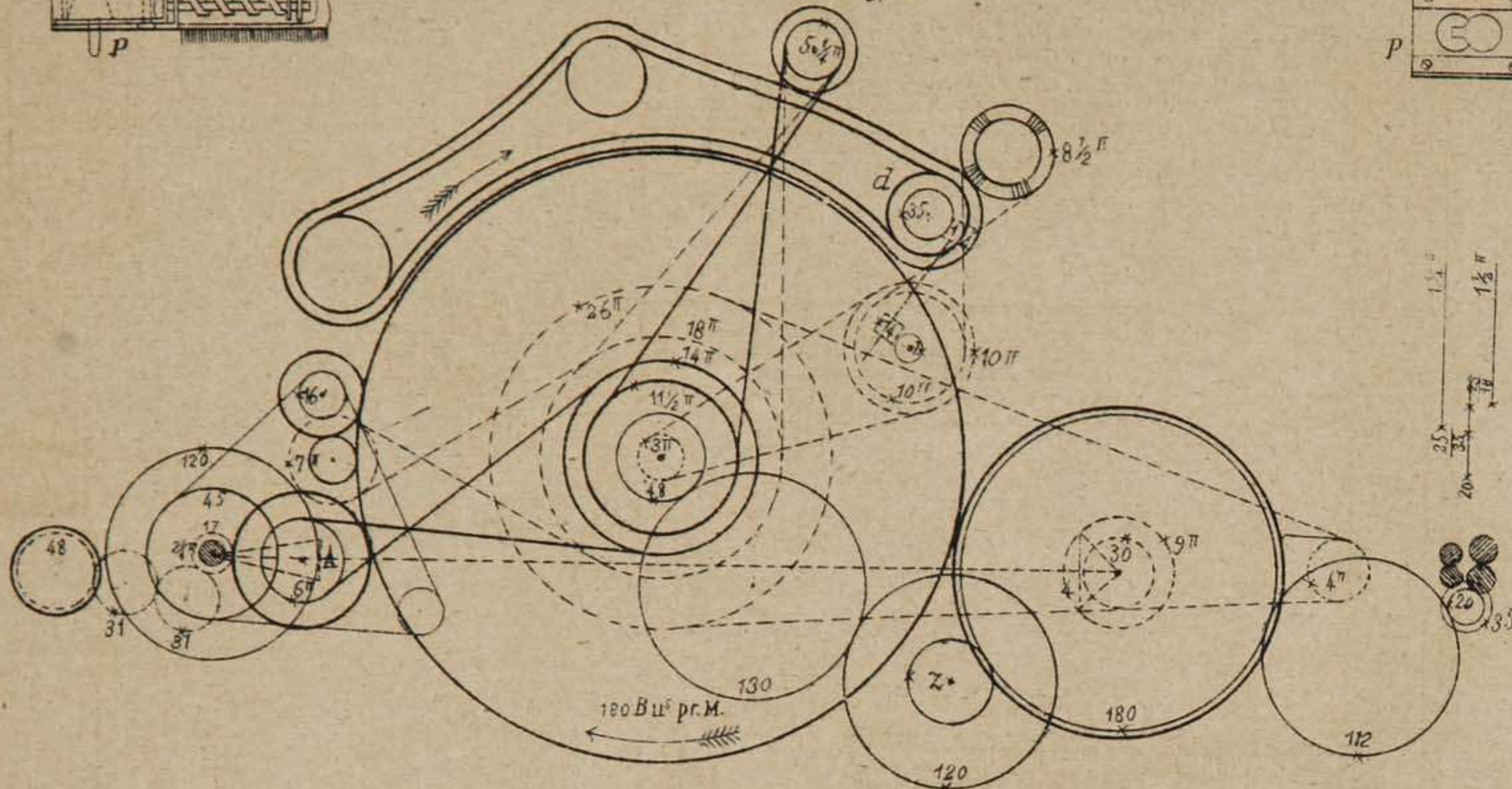


Fig. 302



Fig. 301.

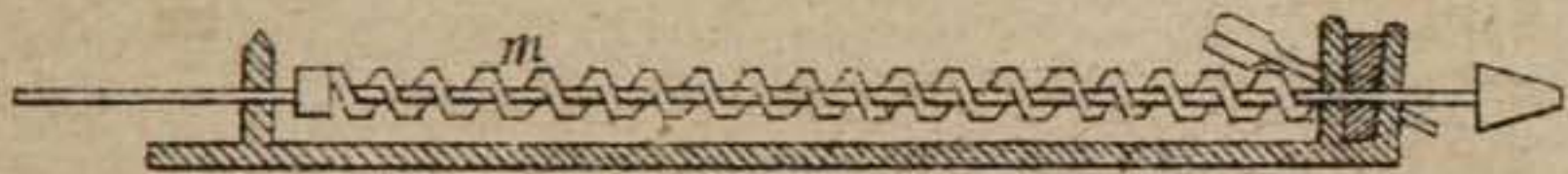
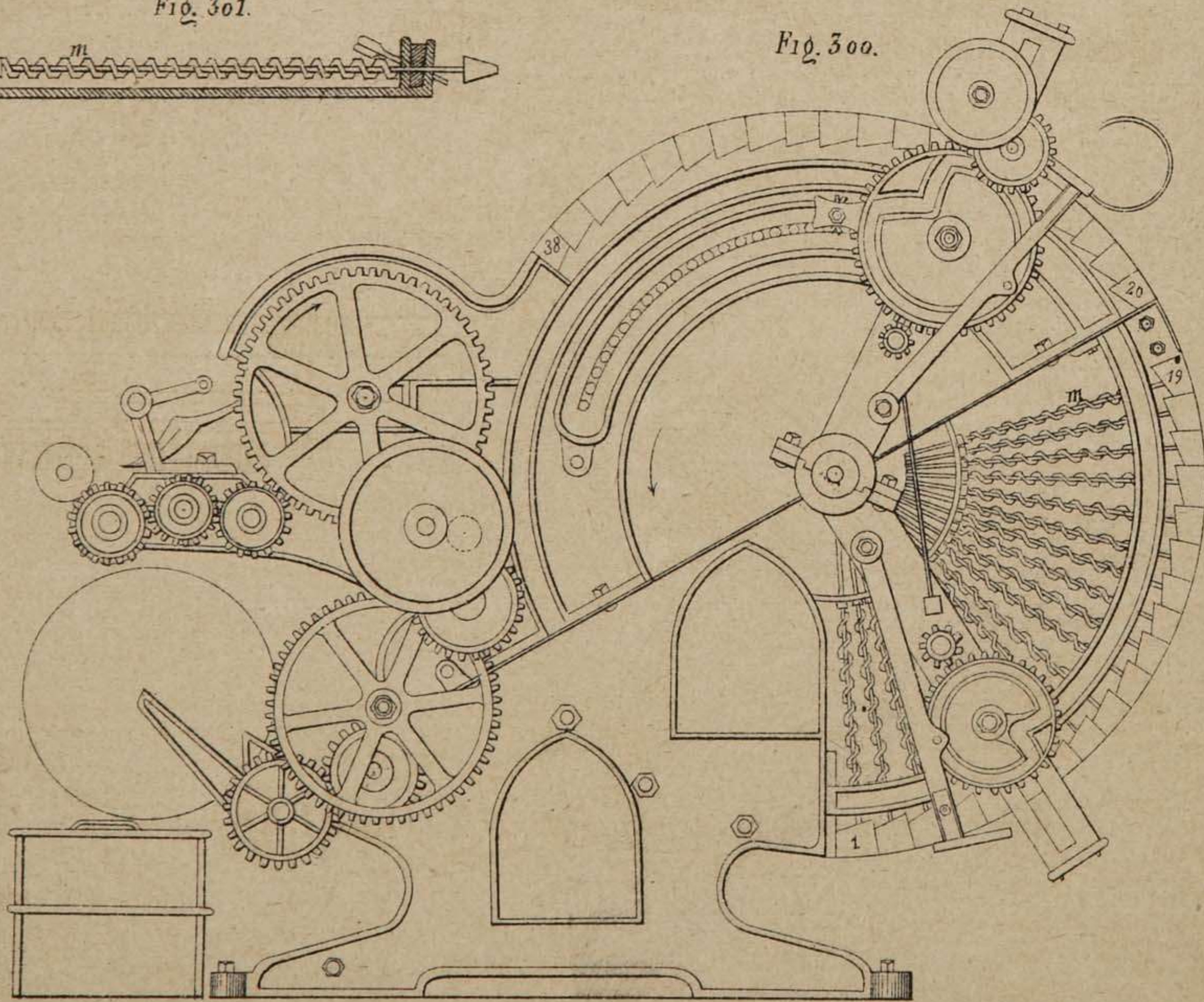


Fig. 300.



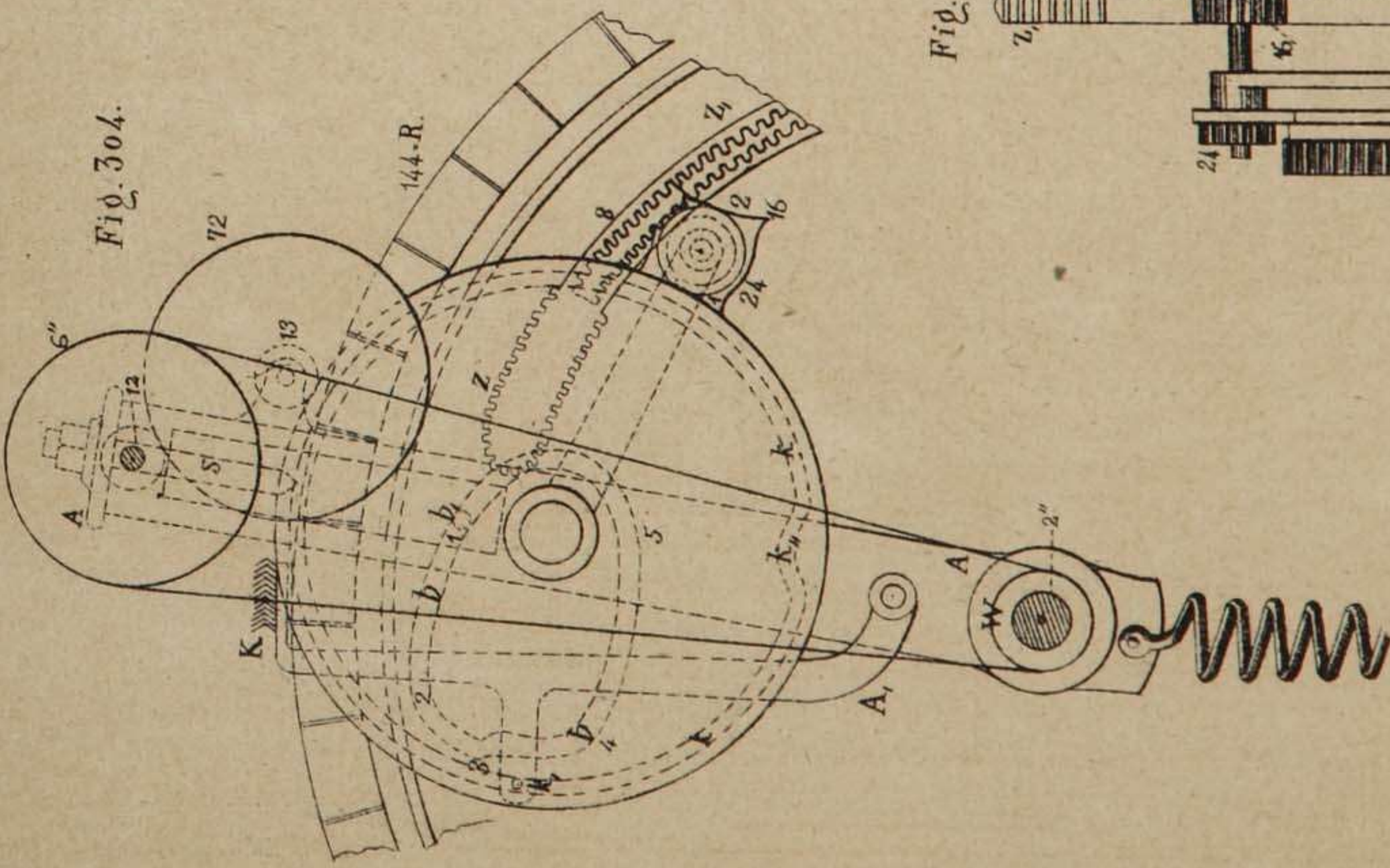


Fig. 304.

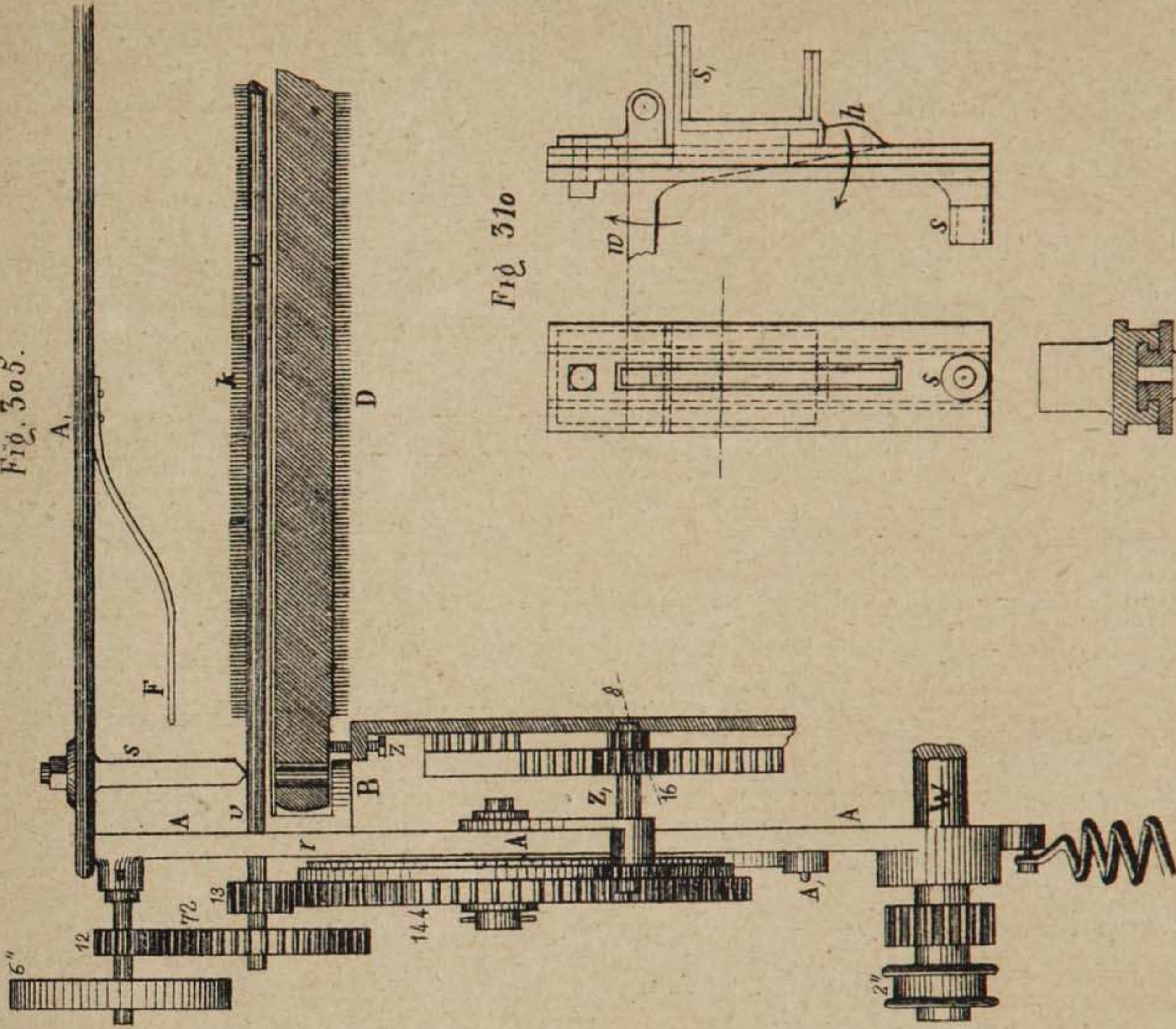


Fig. 305.

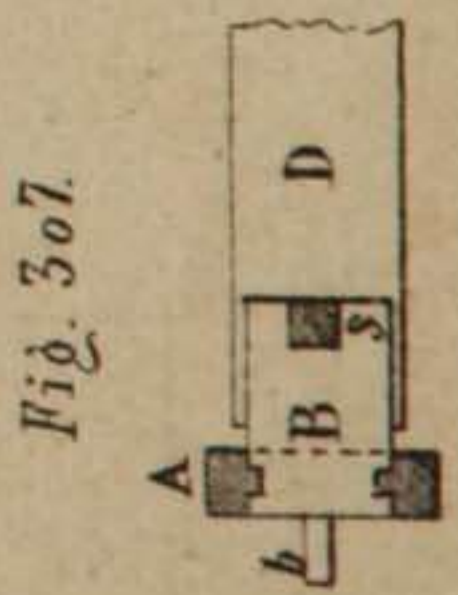


Fig. 307.

Fig. 306.

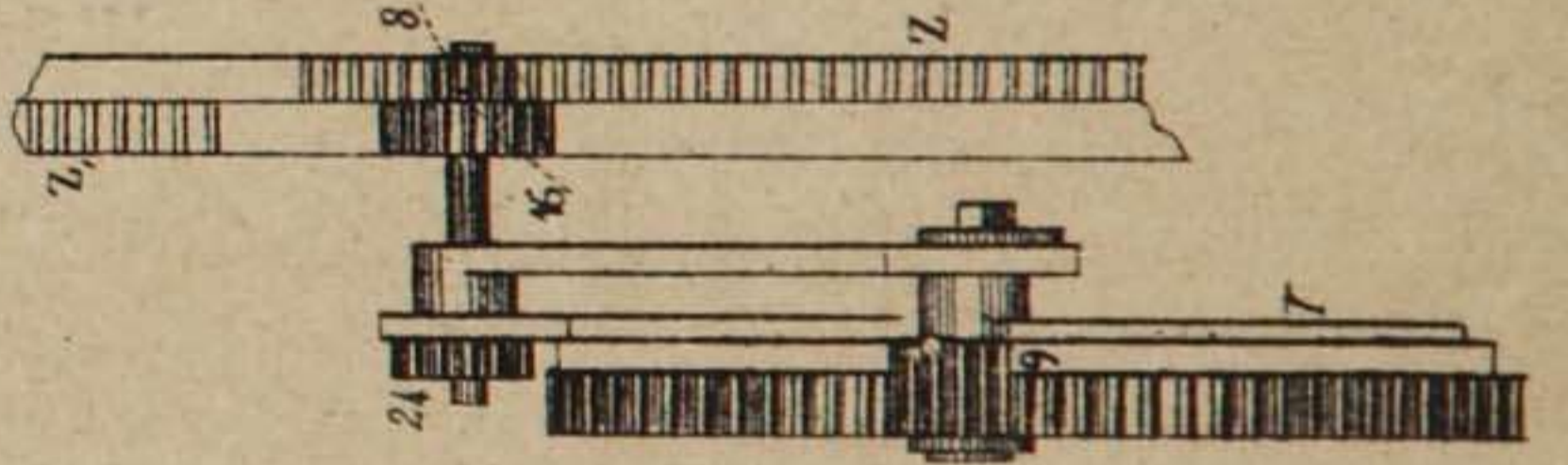


Fig. 310

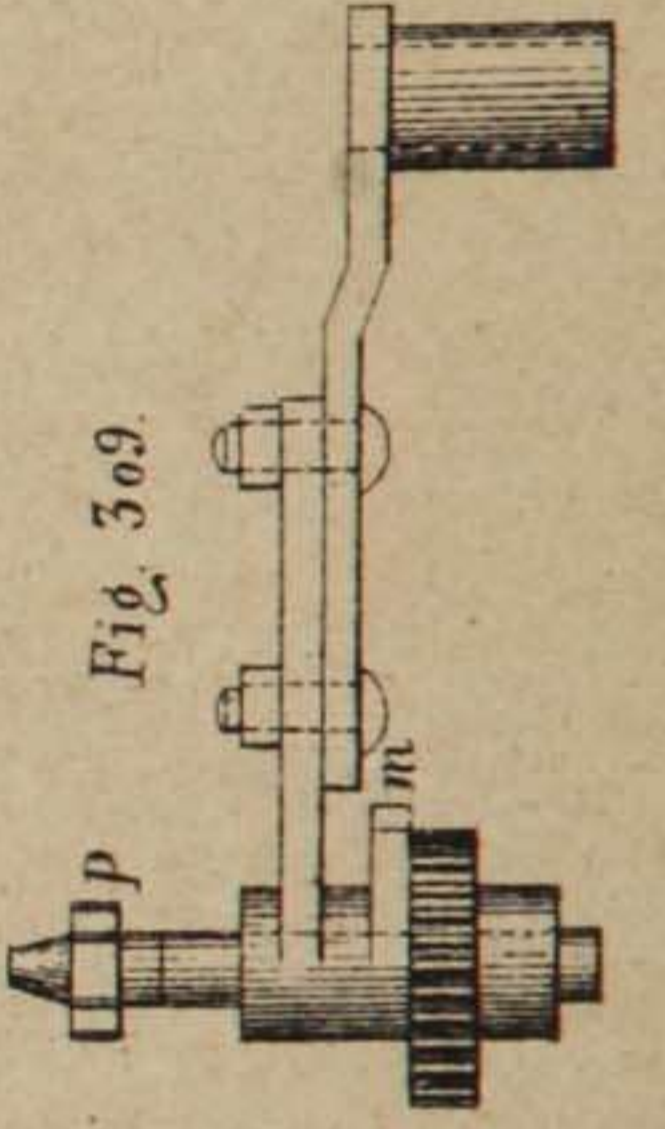
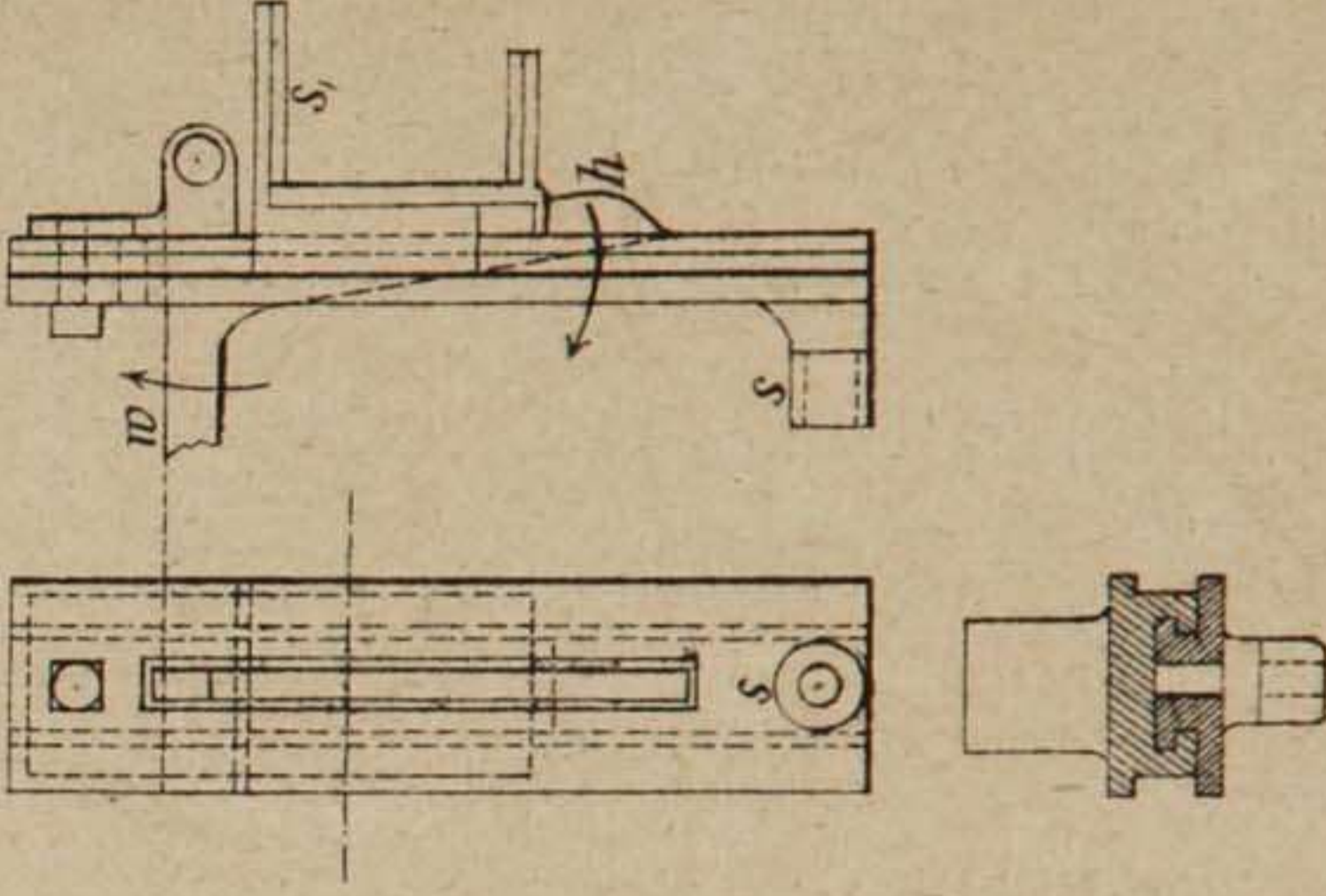


Fig. 309.

Fig. 308.

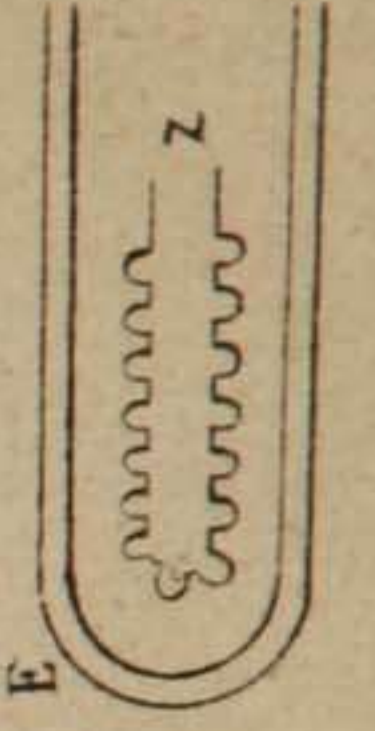


Fig. 311.

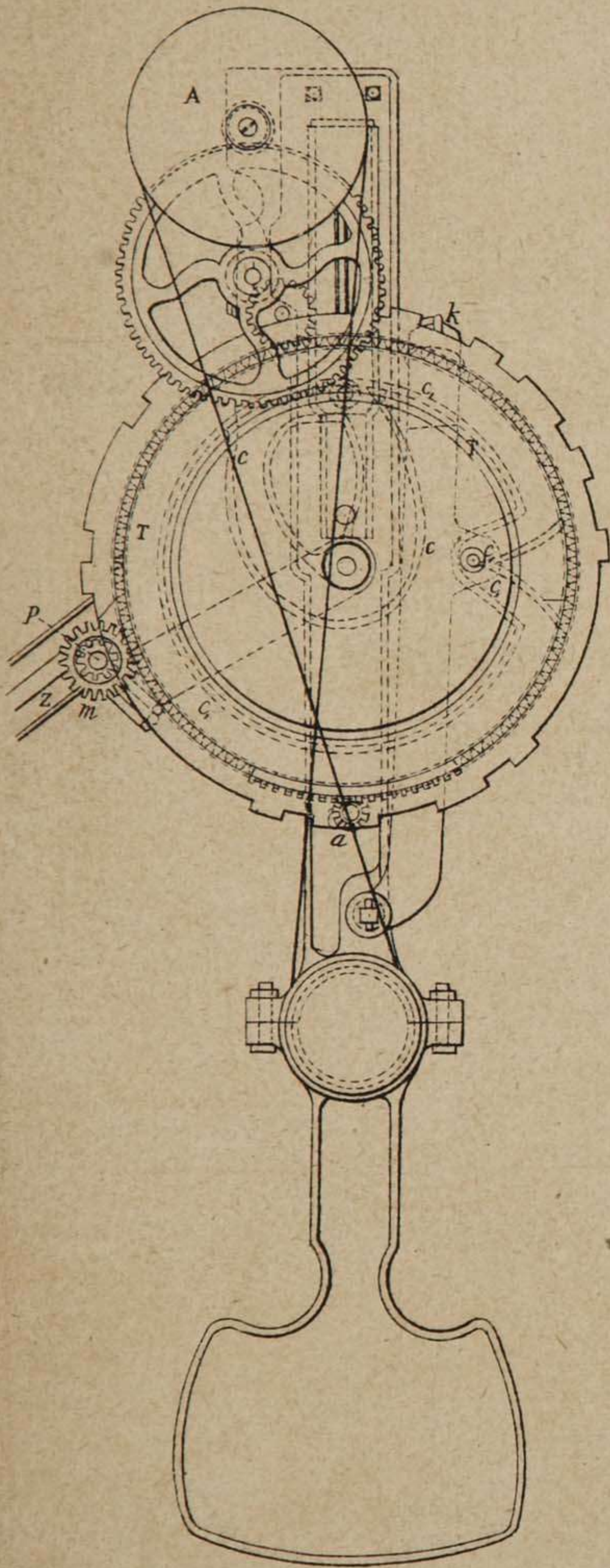


Fig. 312.

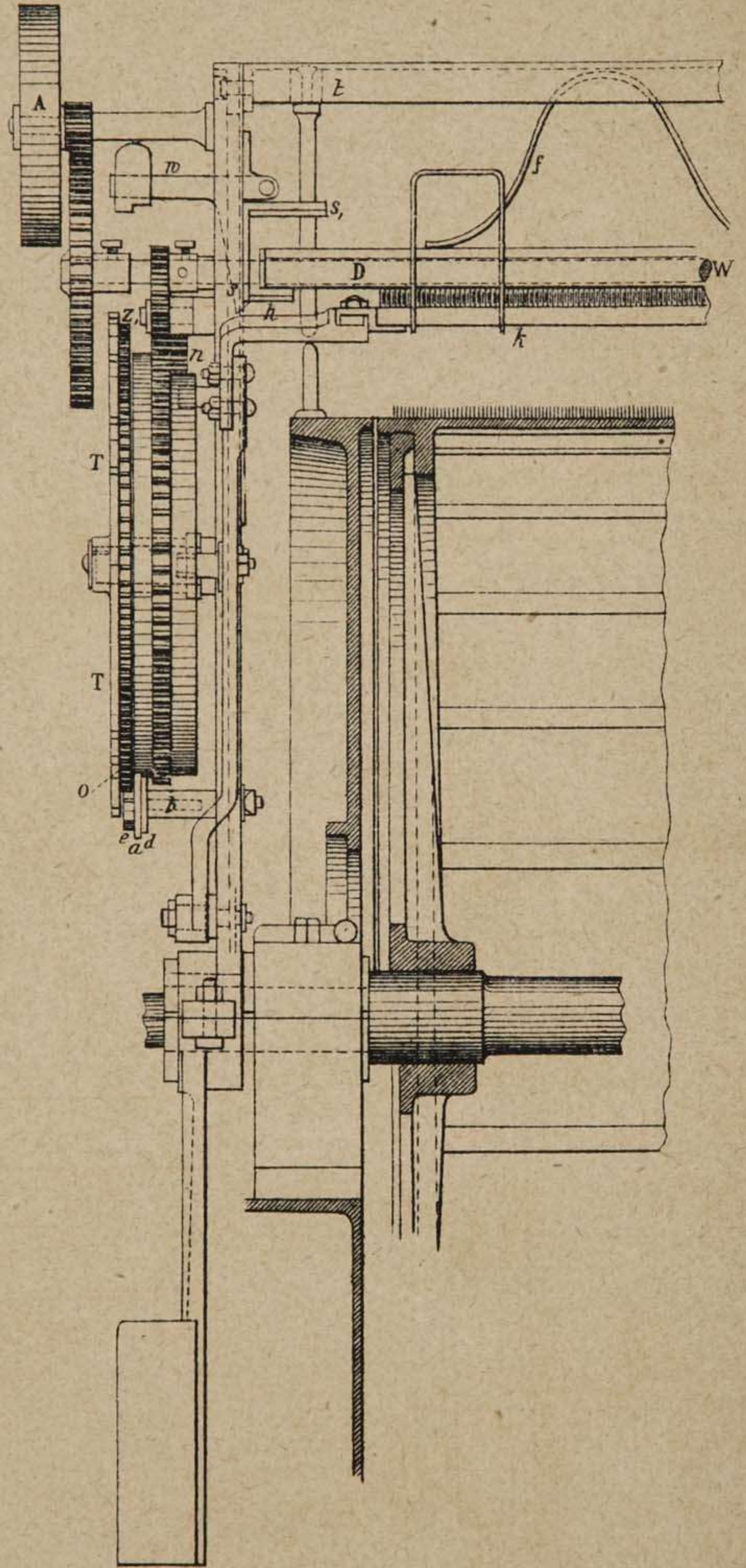


Fig. 313.

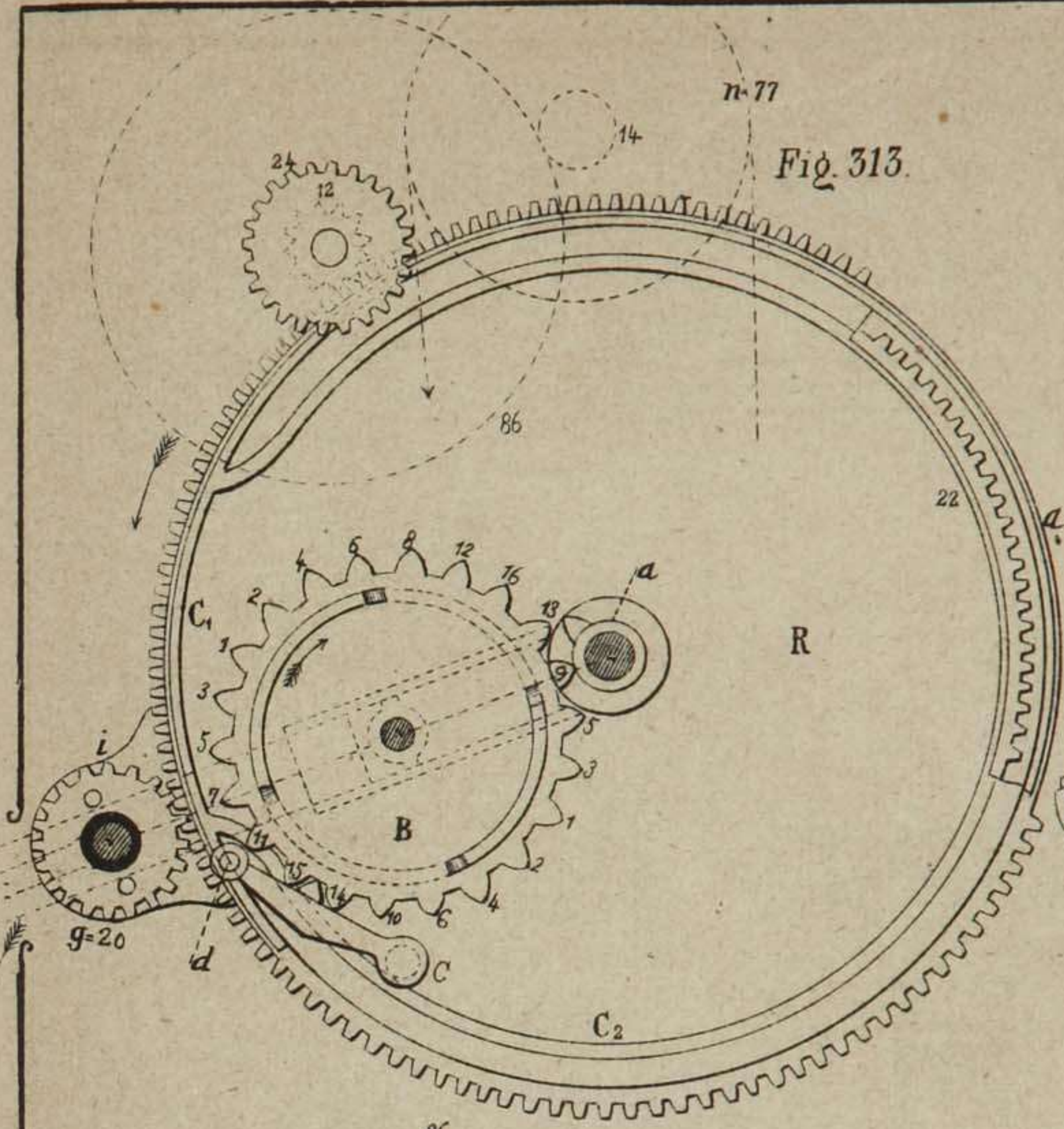


Fig. 316.

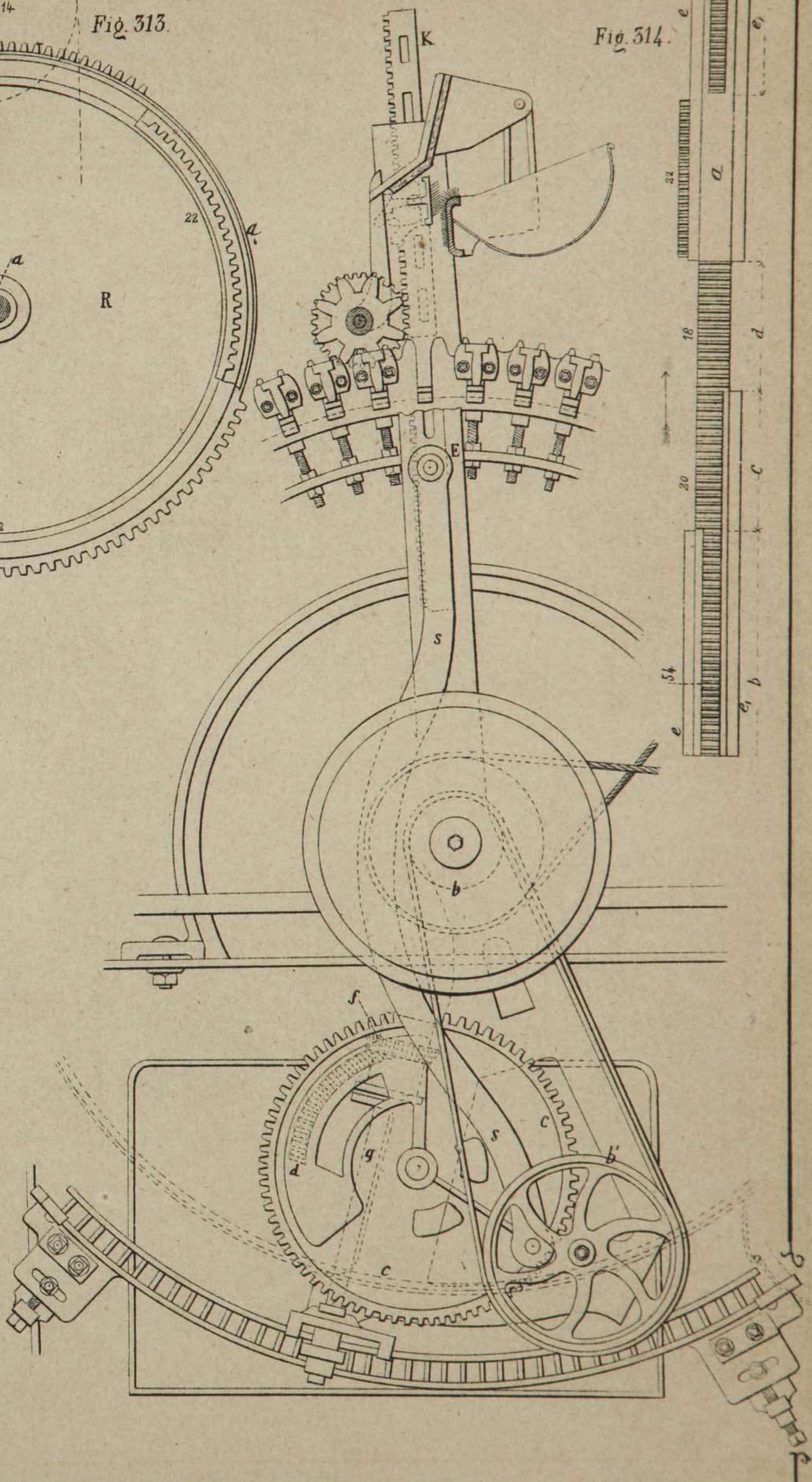


Fig. 314.

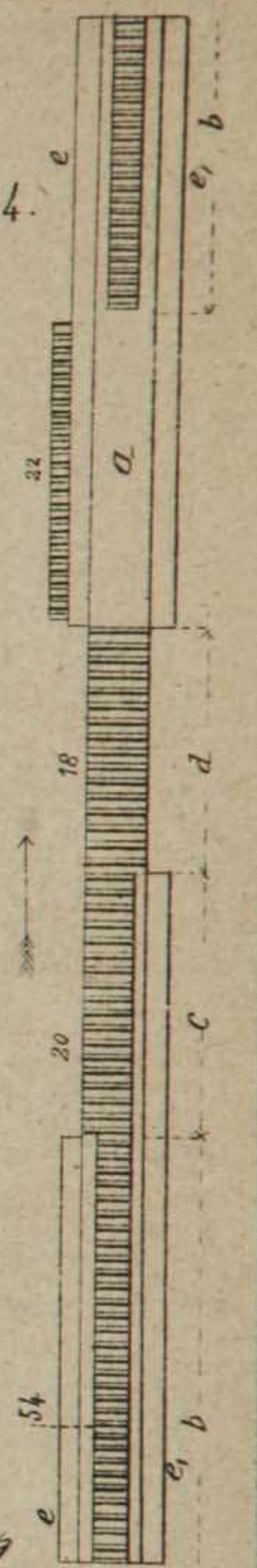


Fig. 315.

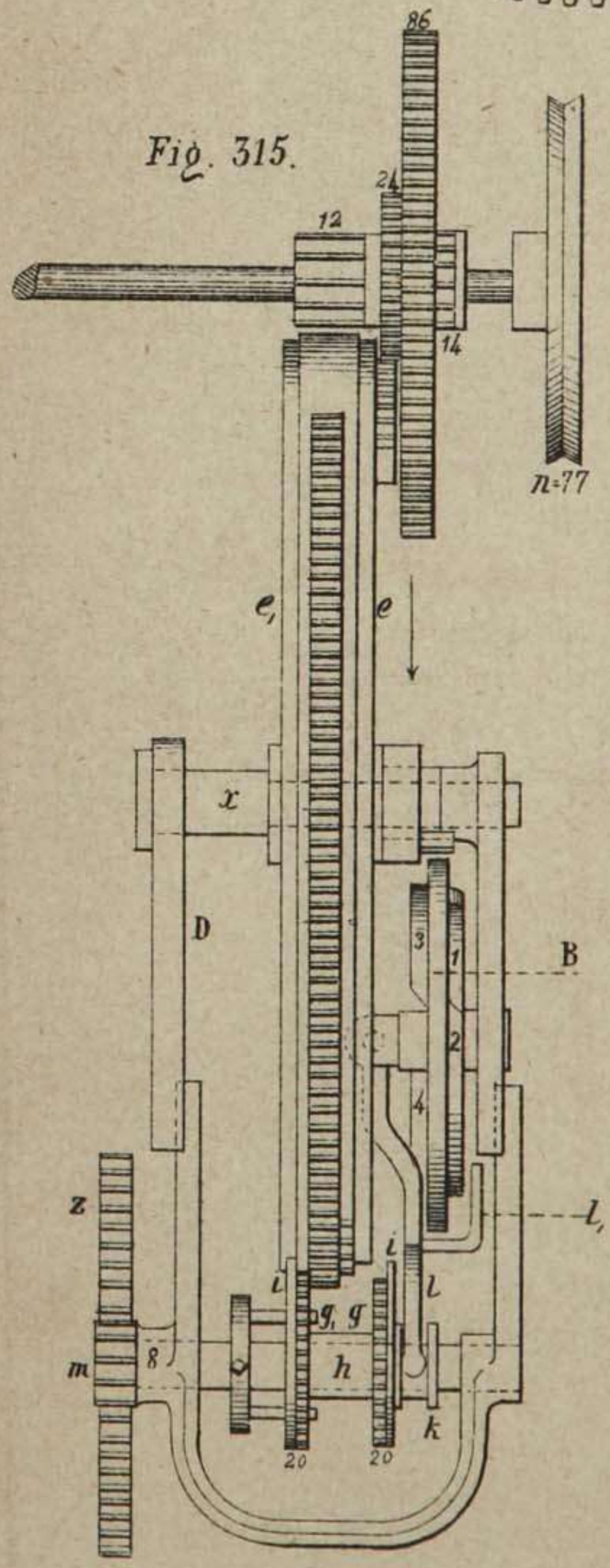


Fig. 317.

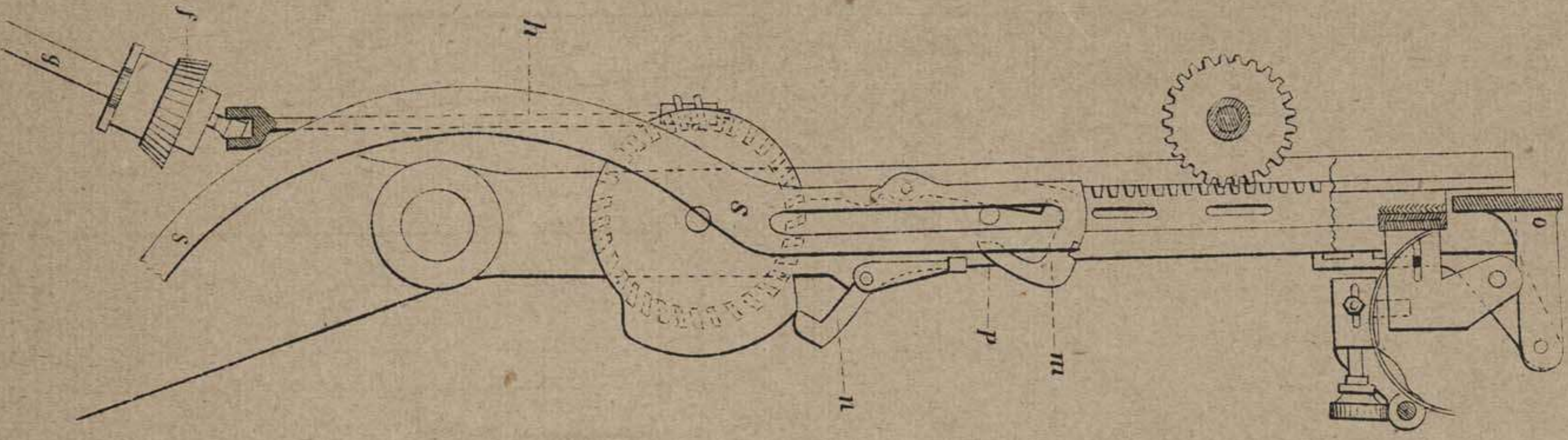


Fig. 322.



Fig. 319.

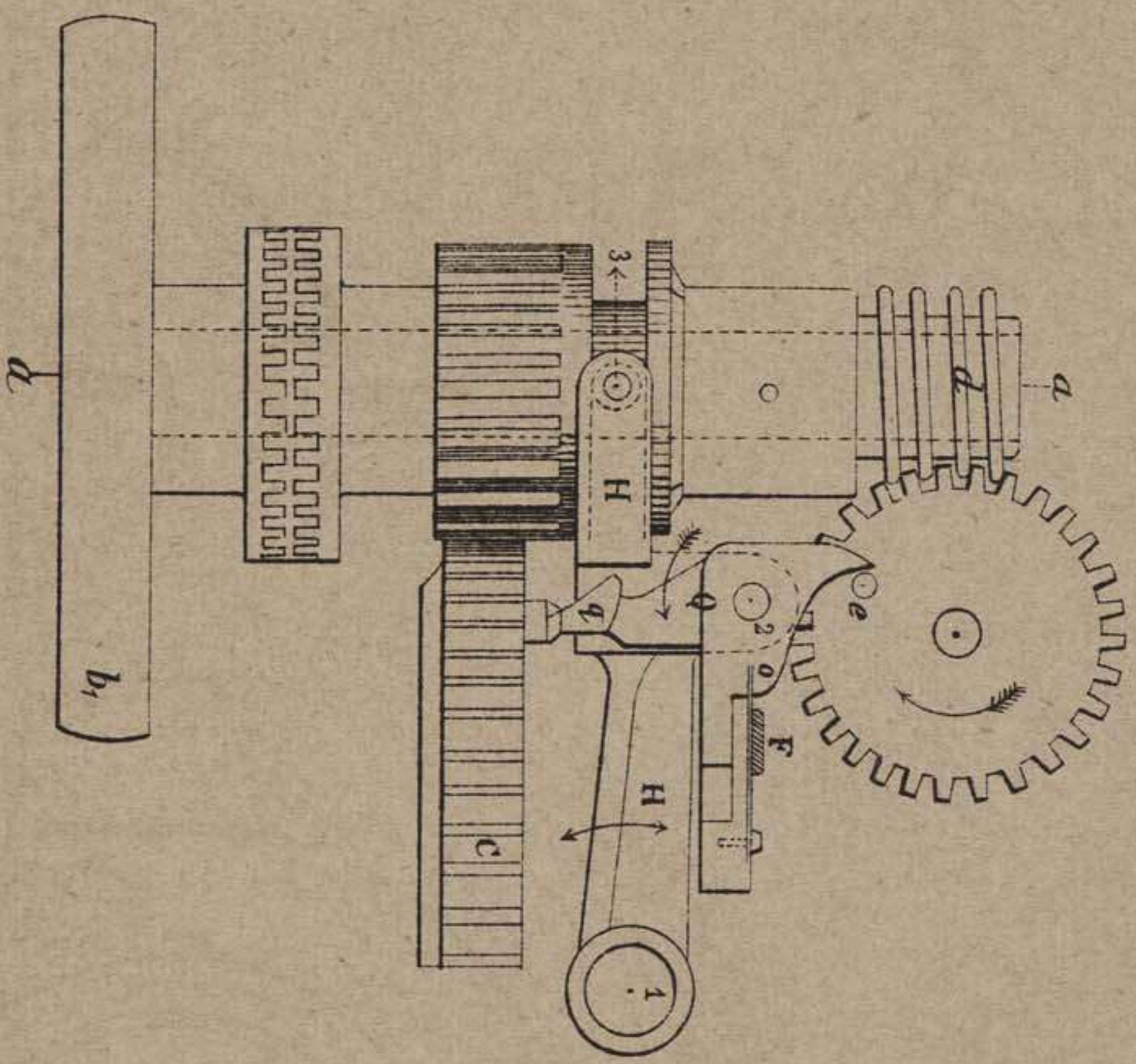


Fig. 318.

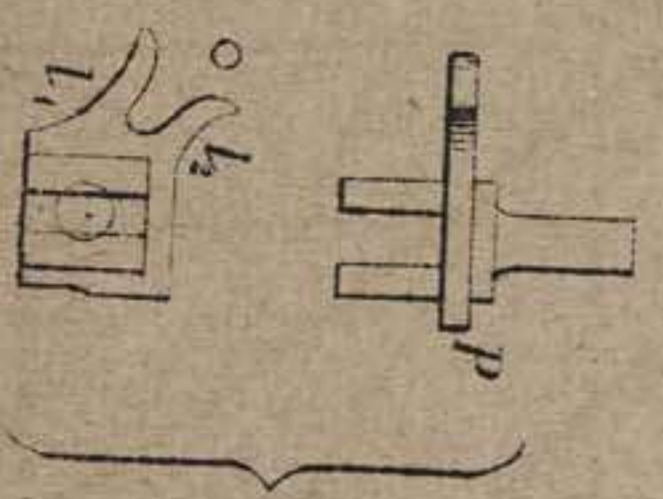


Fig. 320.

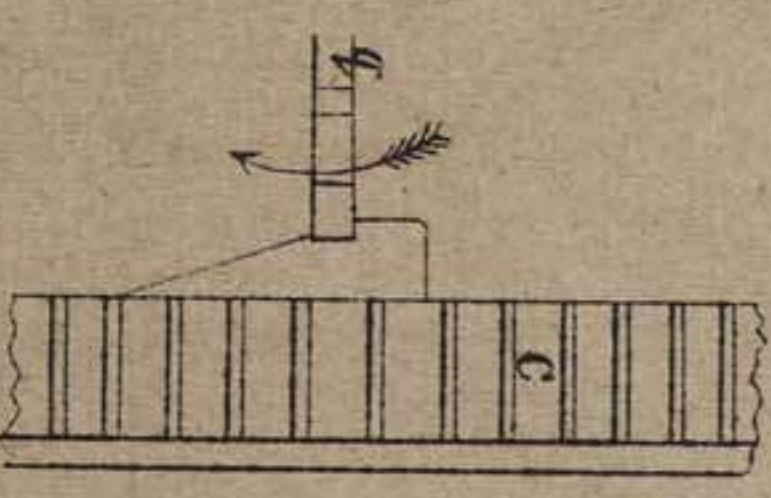


Fig. 324.

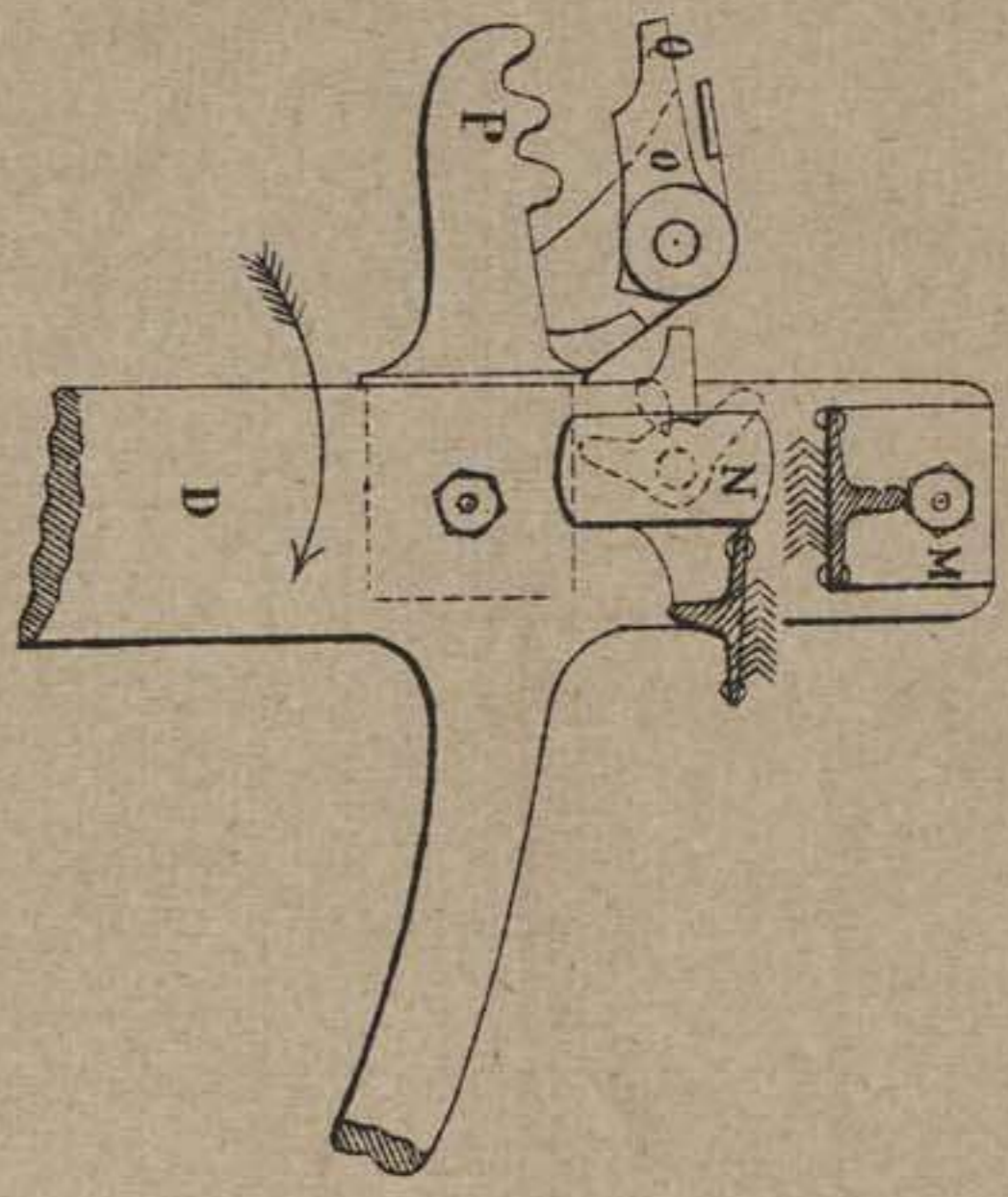


Fig. 323.

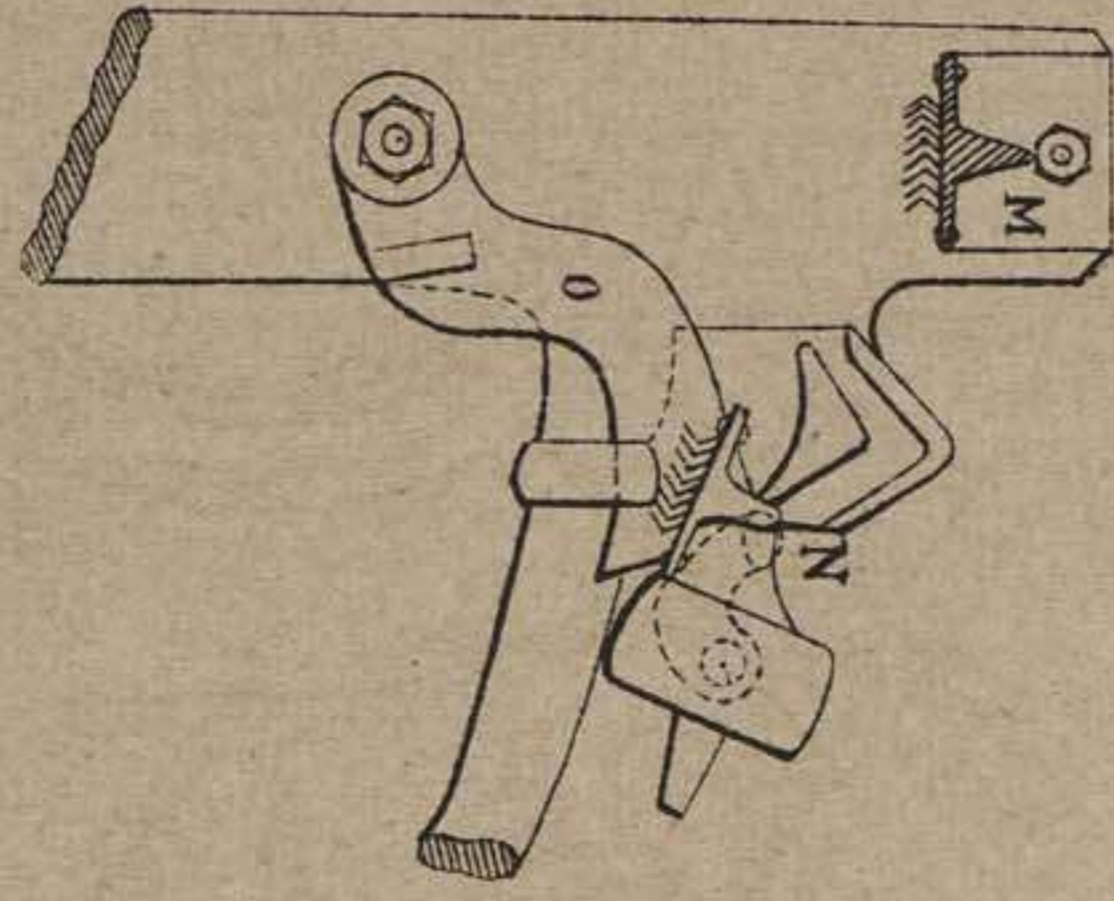


Fig. 325.

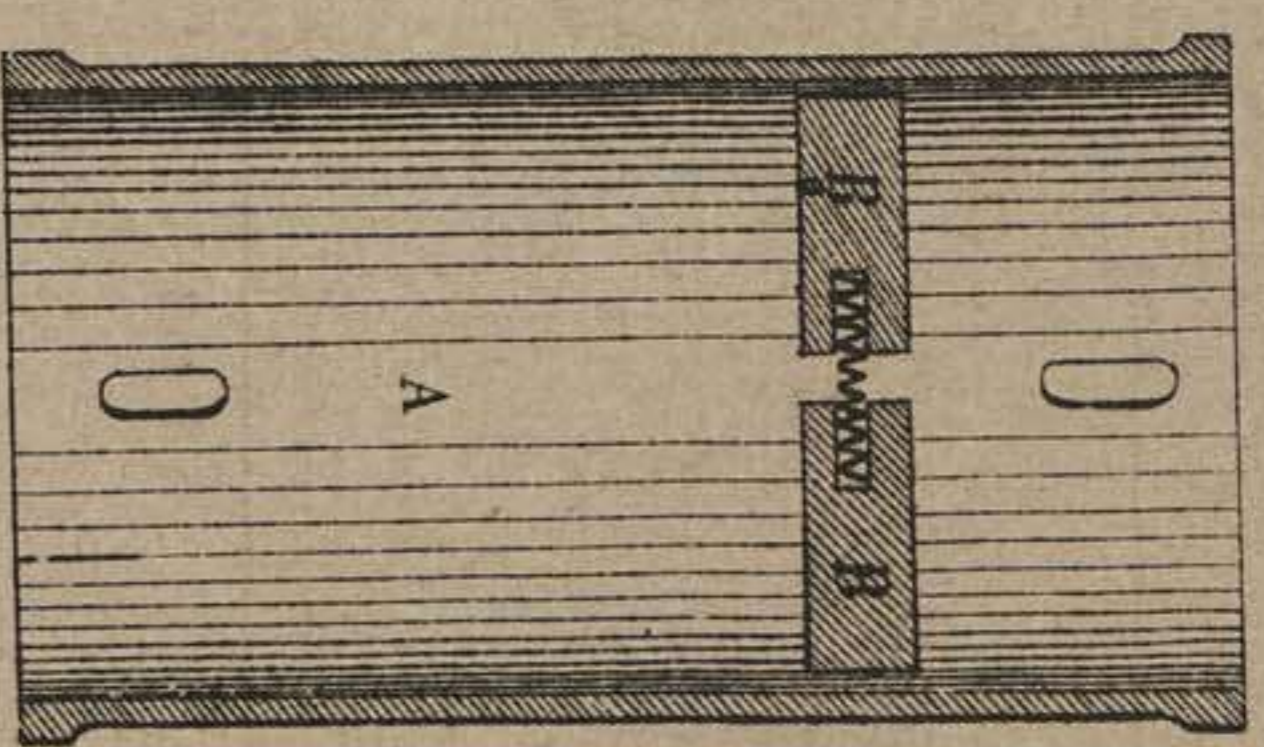


Fig. 326.

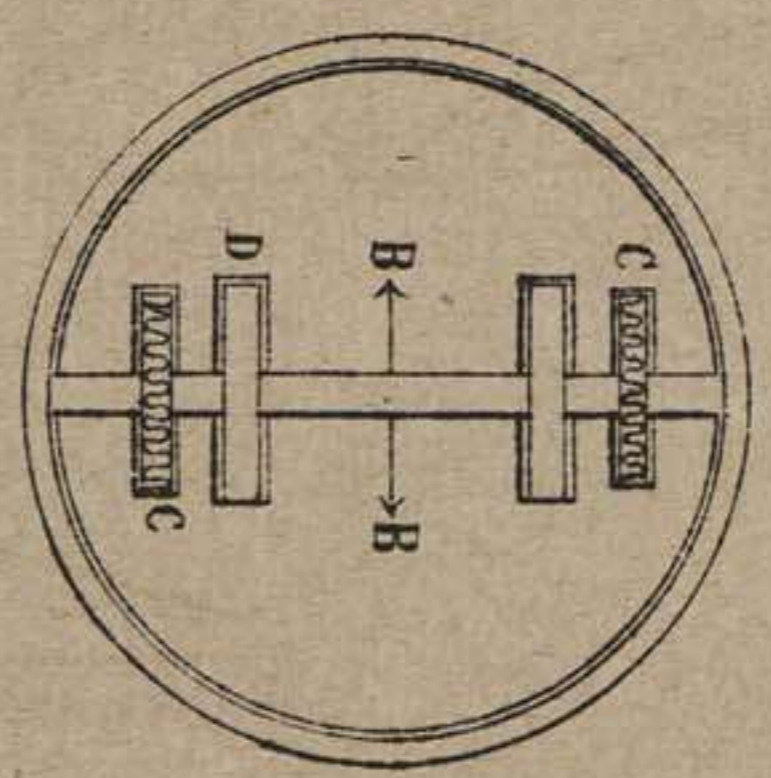
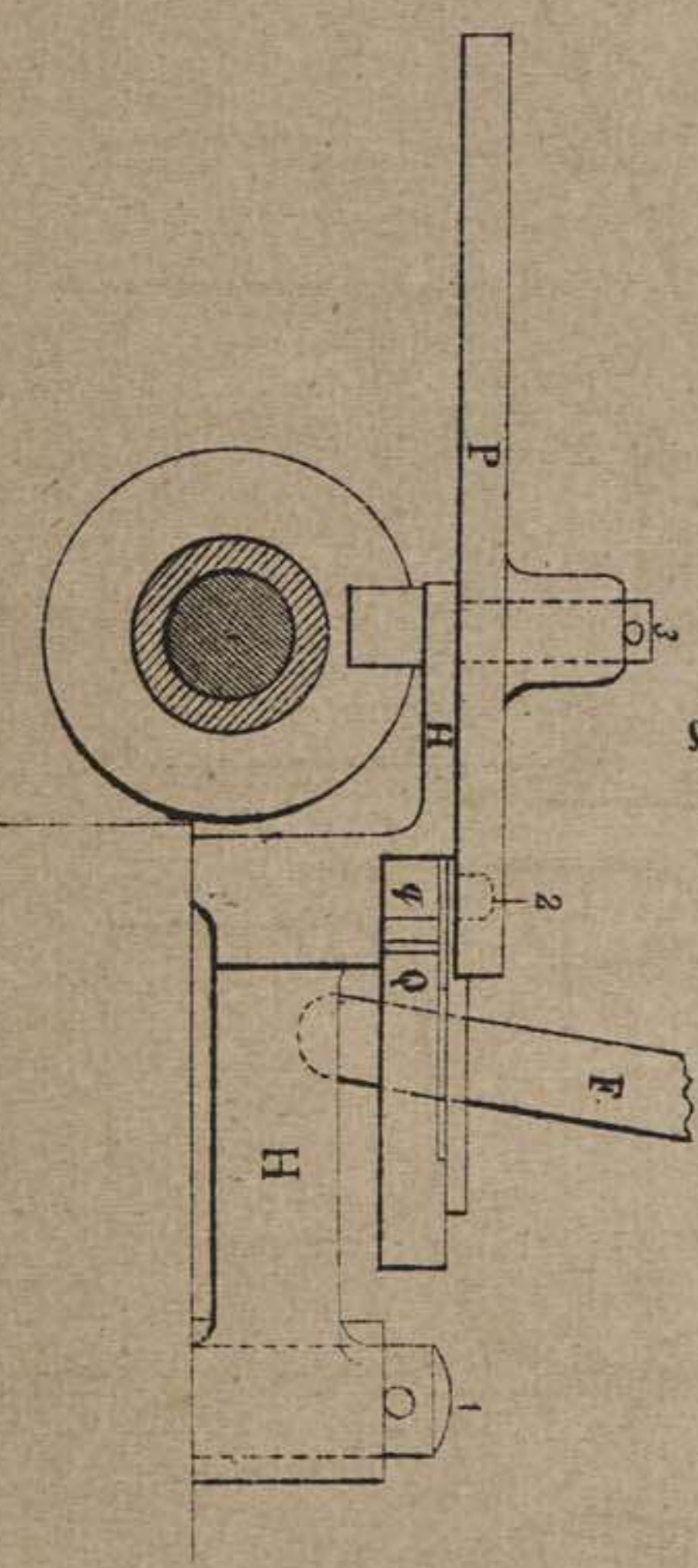


Fig. 321.



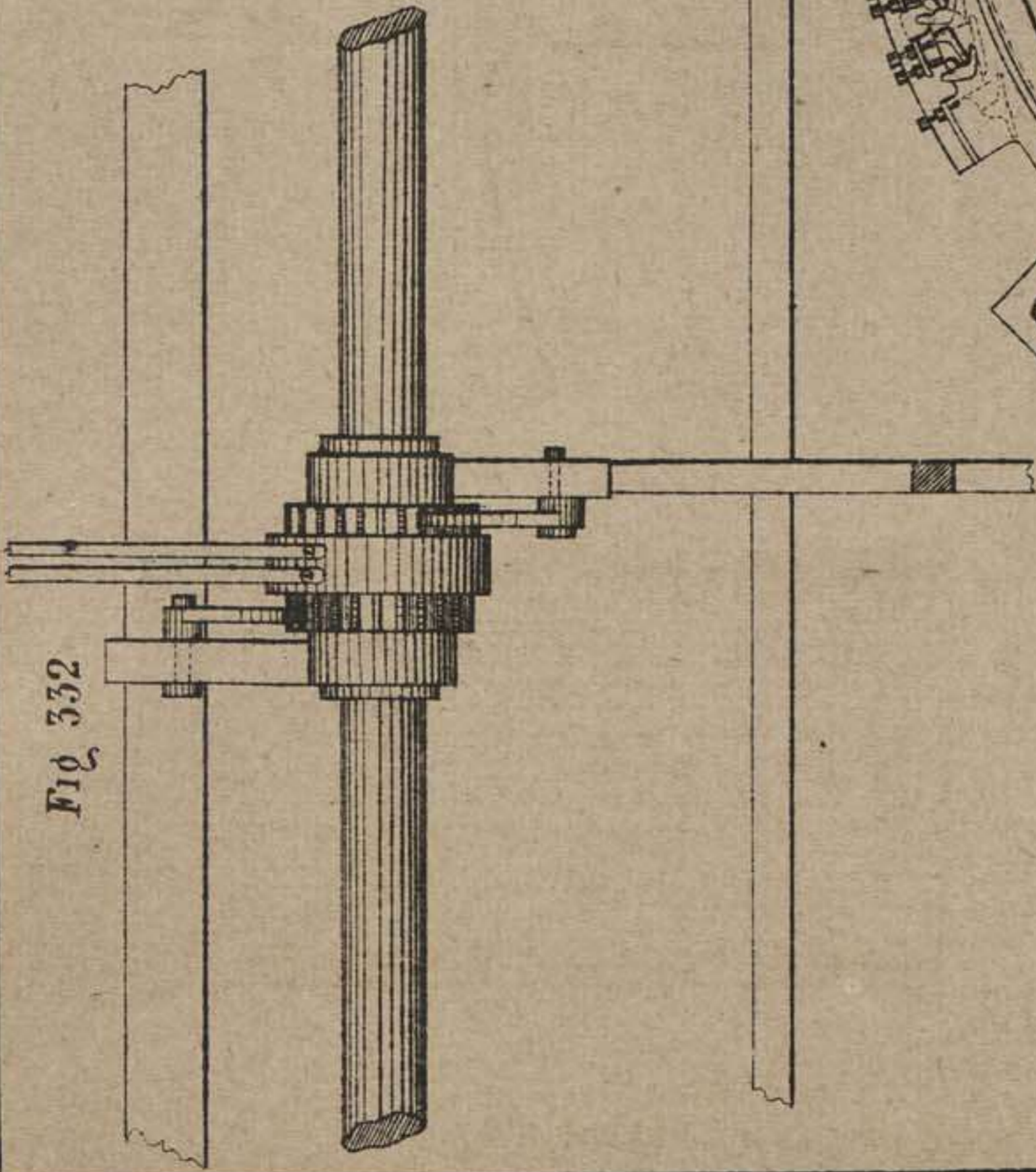


Fig. 332

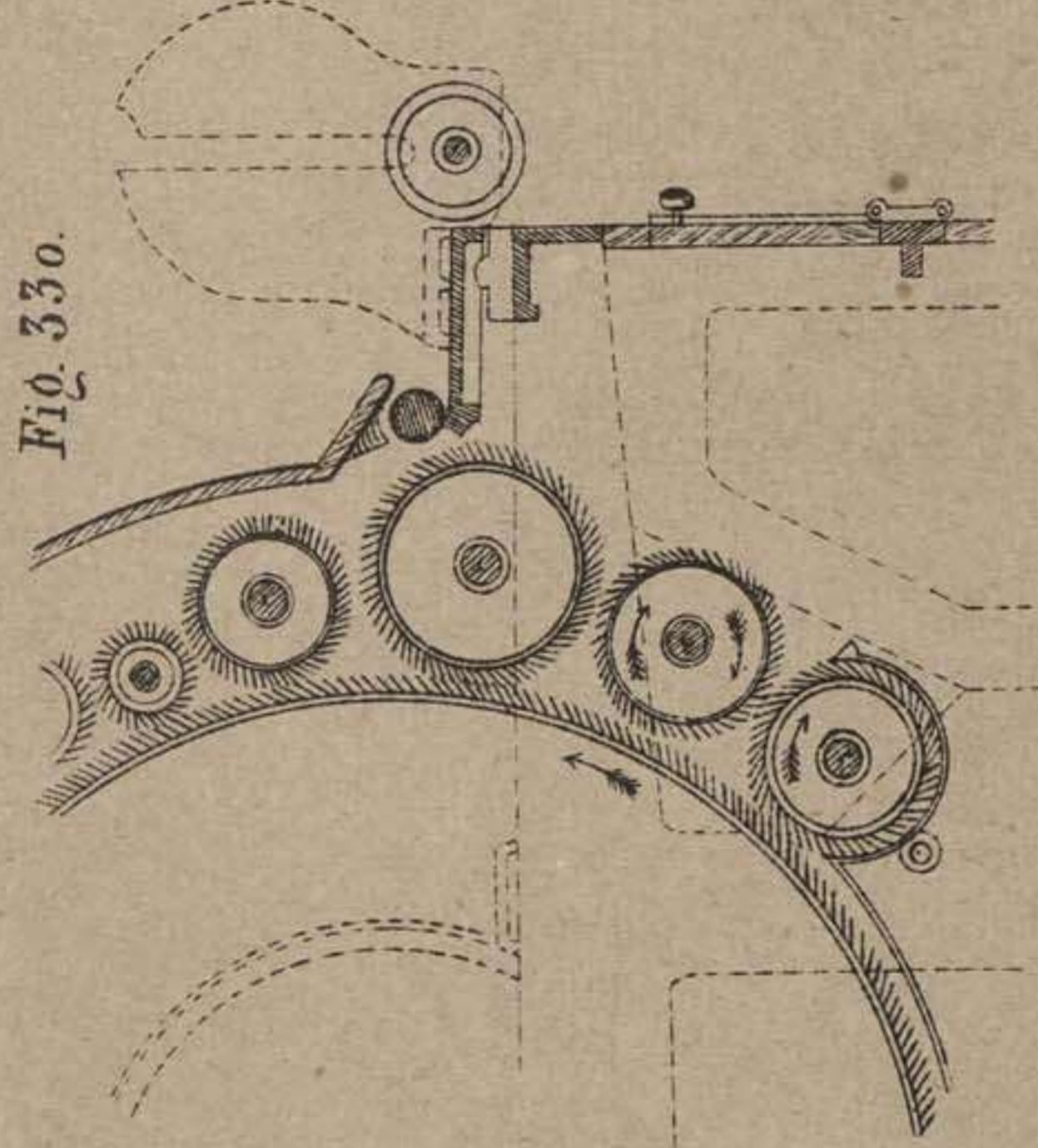


Fig. 330.

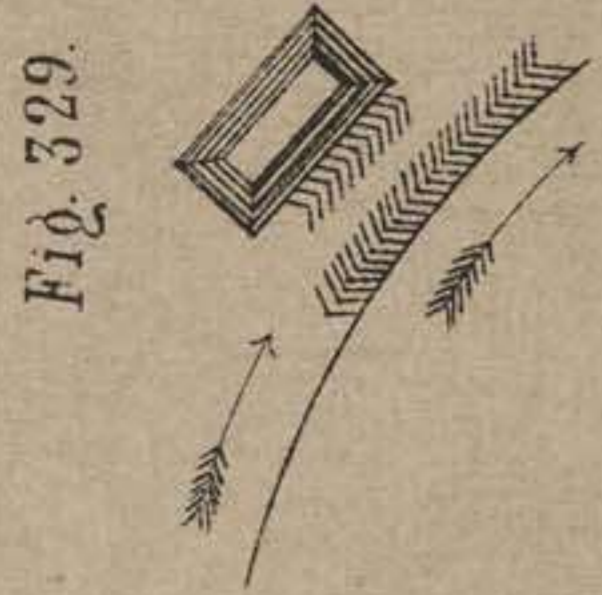


Fig. 329.

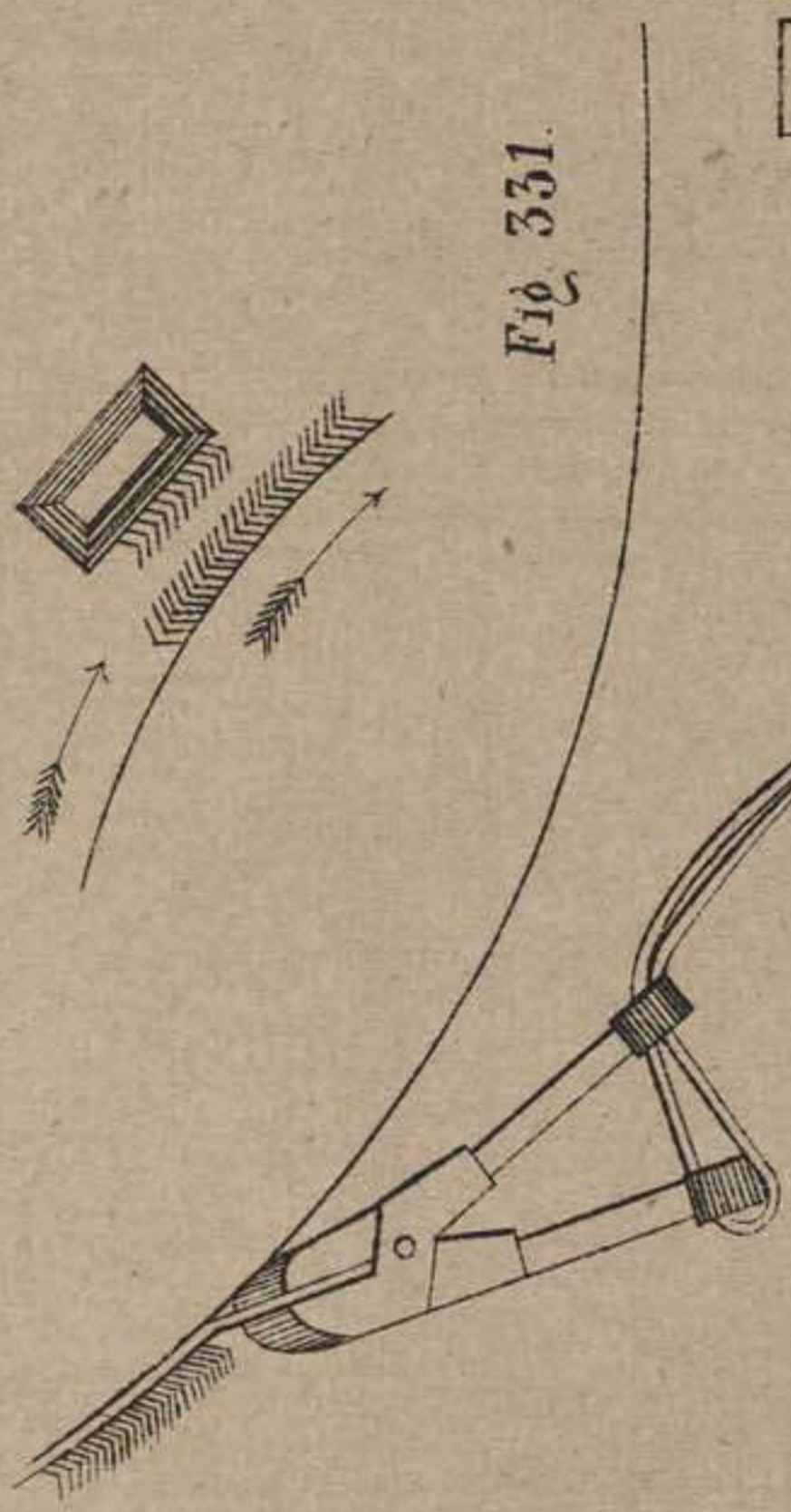


Fig. 331.



Fig. 328.

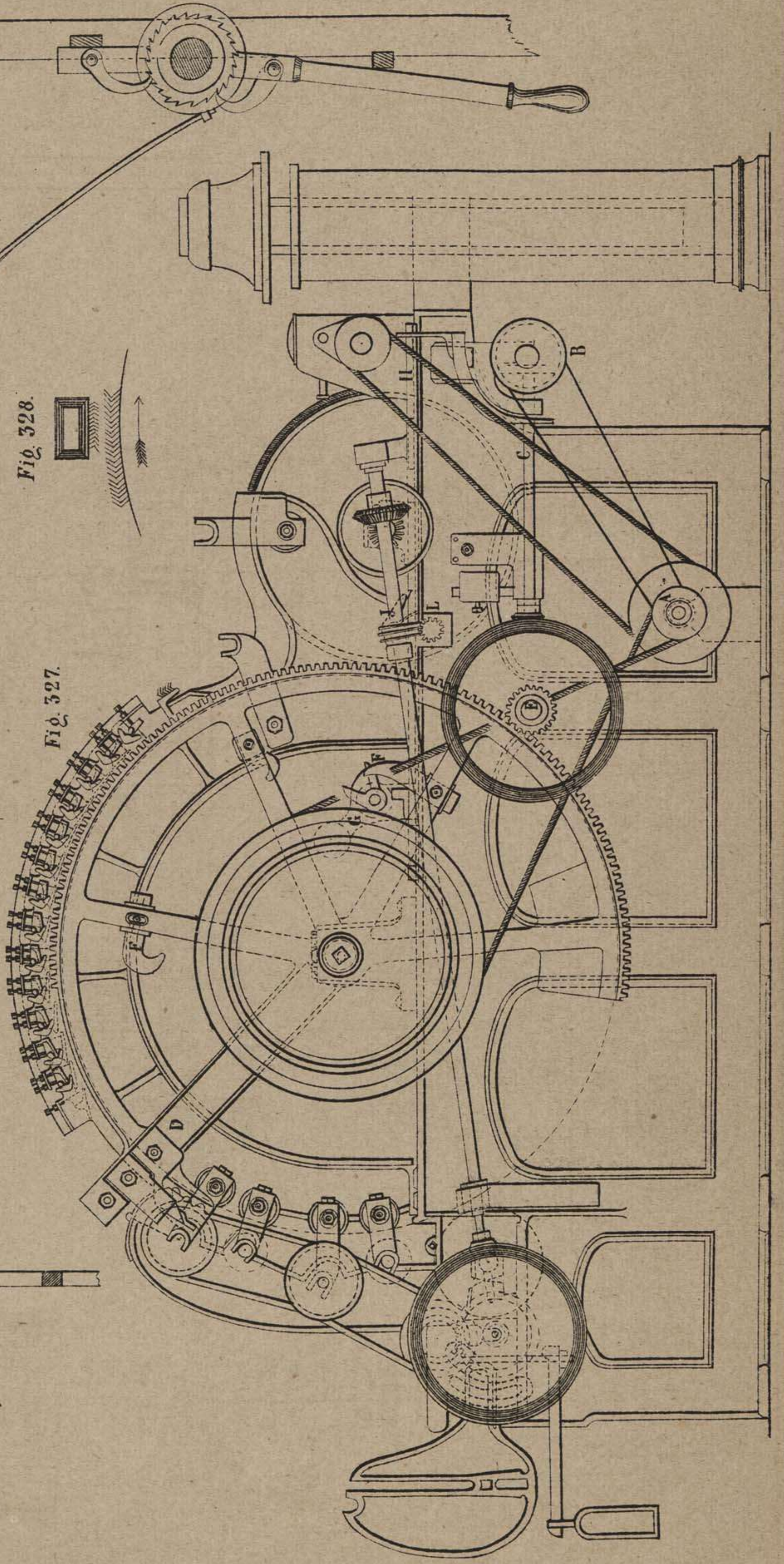


Fig. 327.

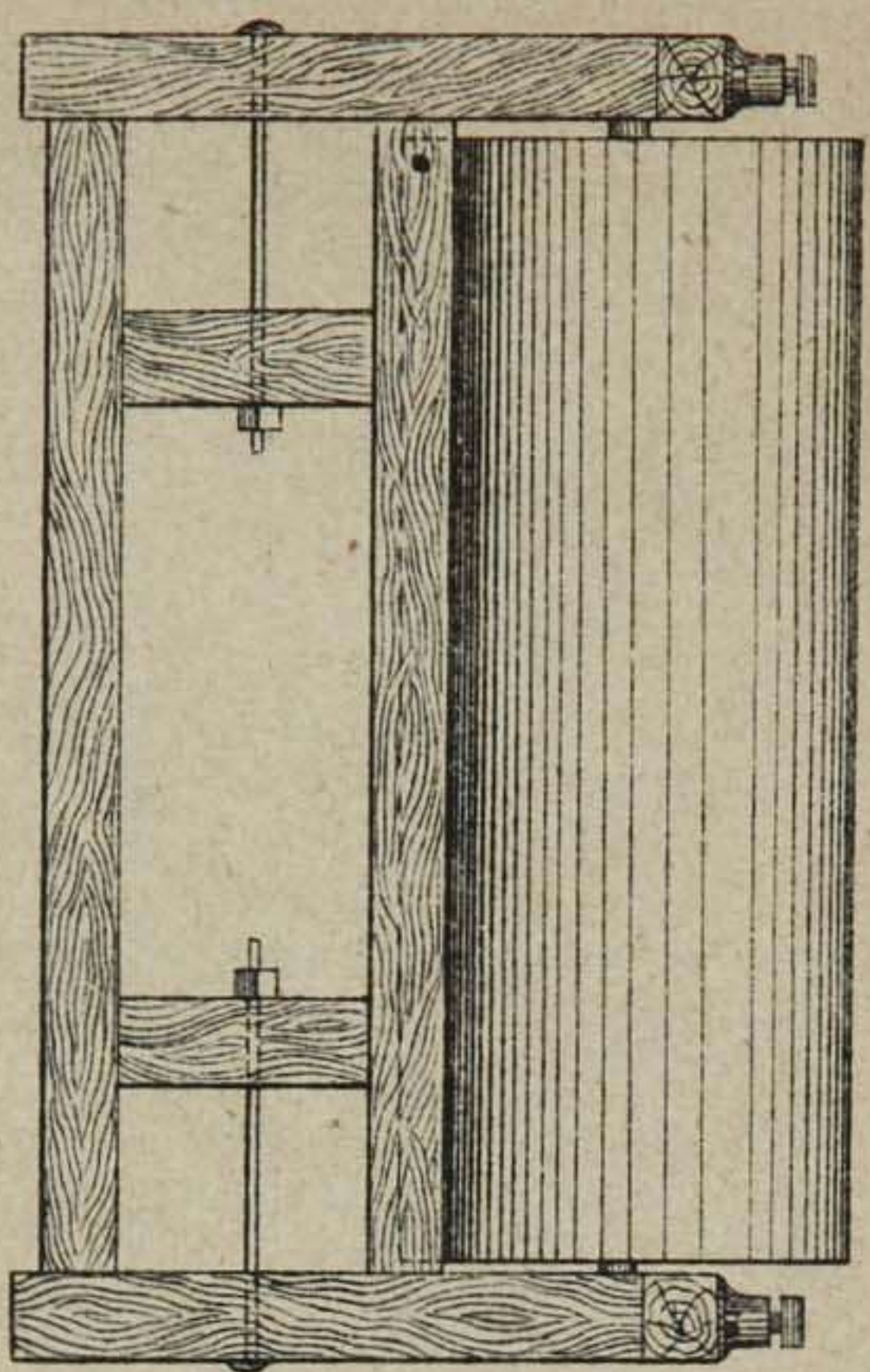


Fig. 333.

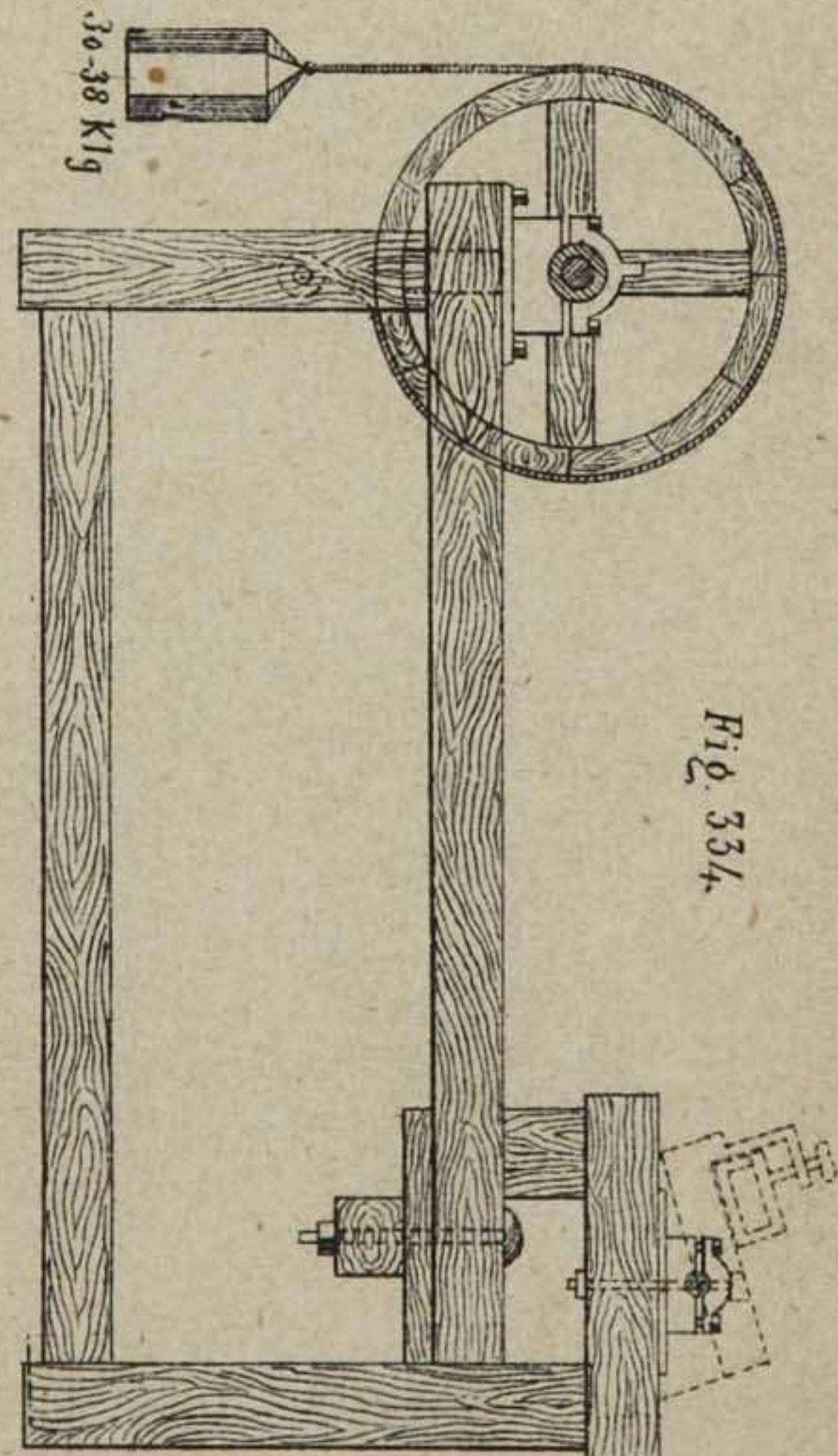


Fig. 334.

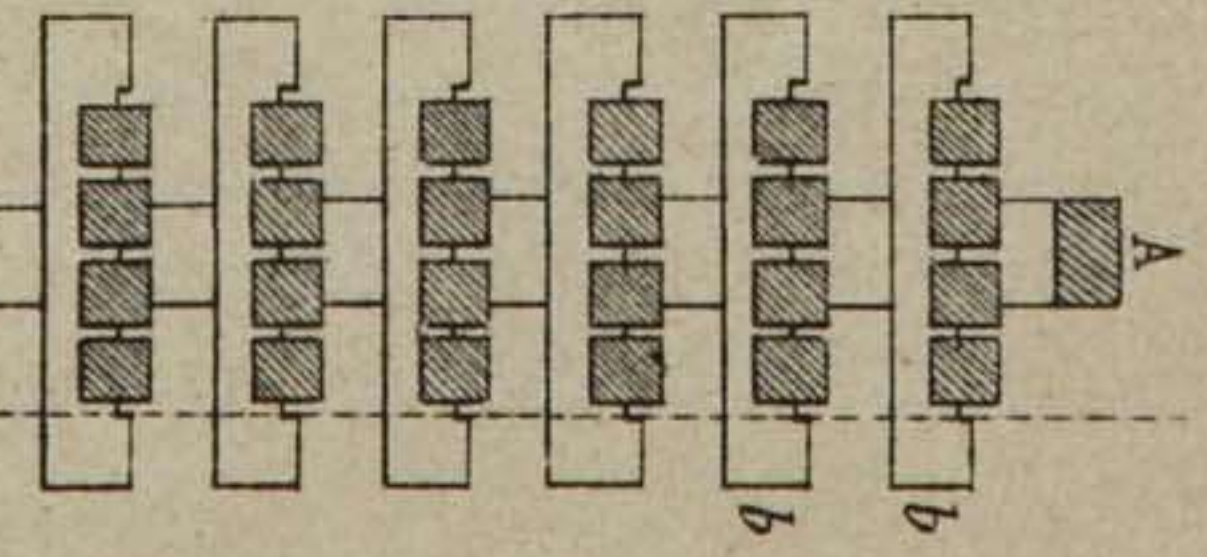


Fig. 341.

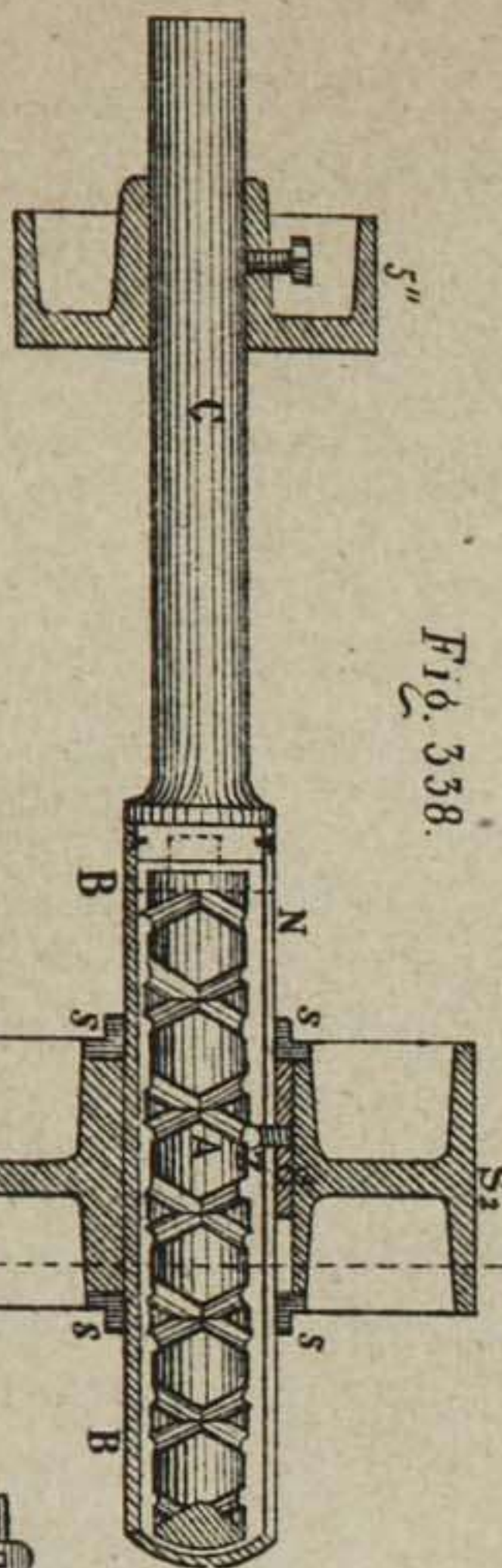


Fig. 338.

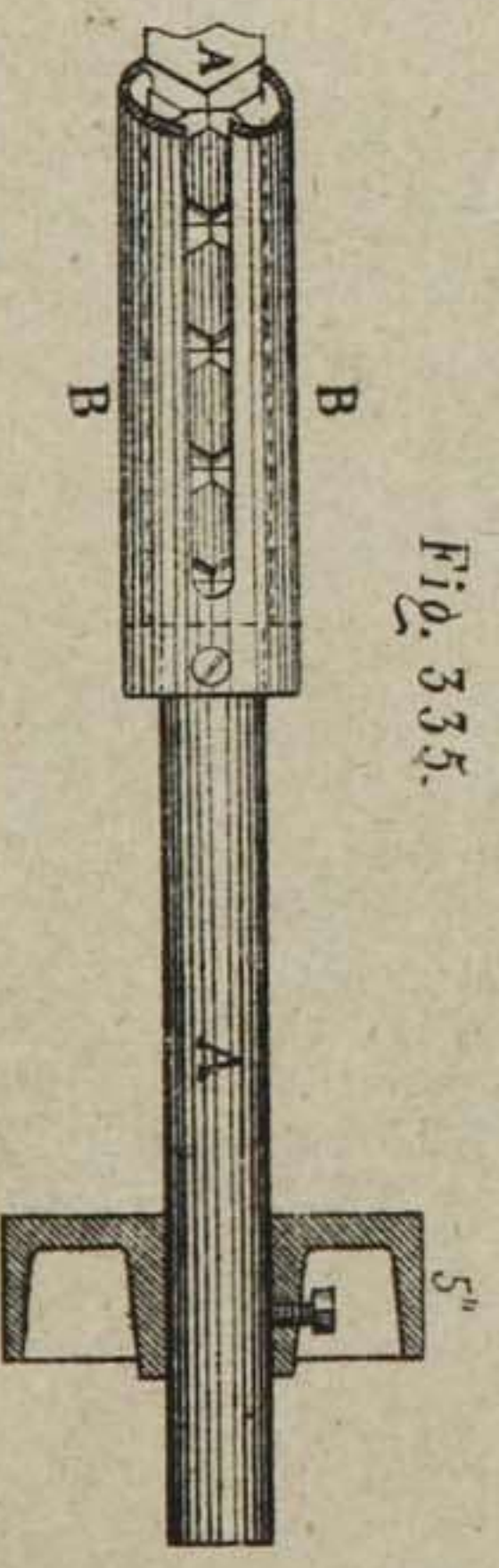


Fig. 335.

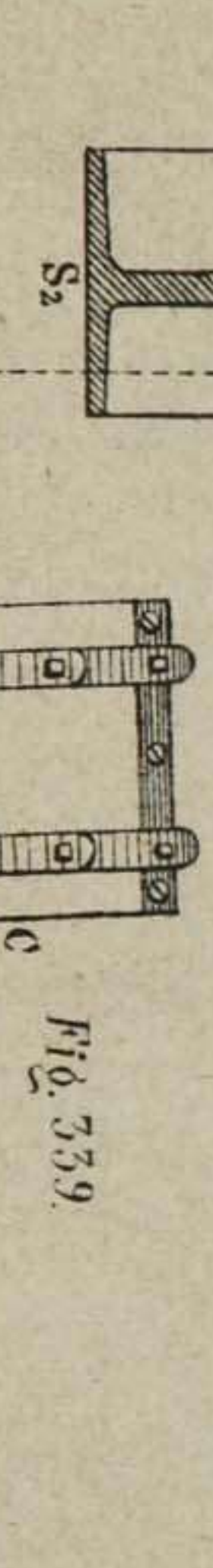


Fig. 339.



Fig. 337.

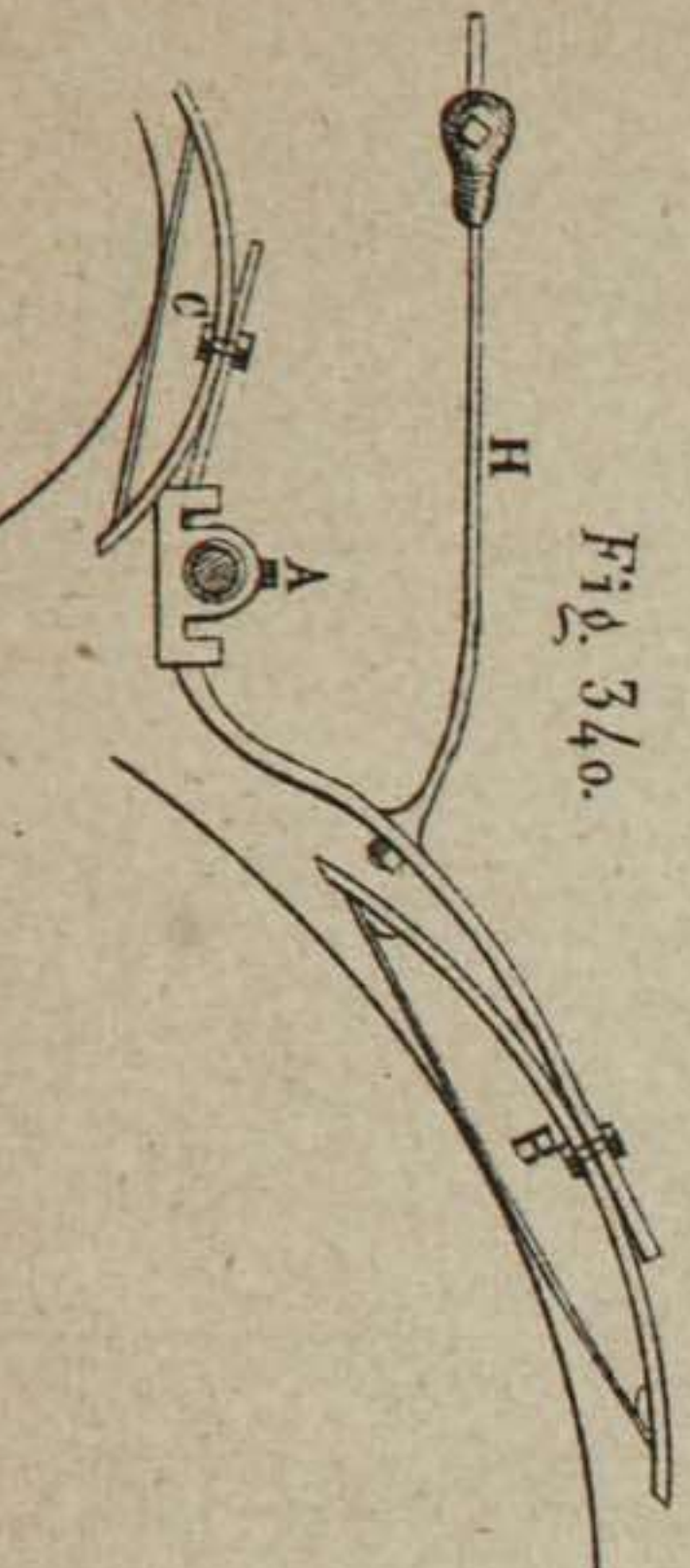


Fig. 340.

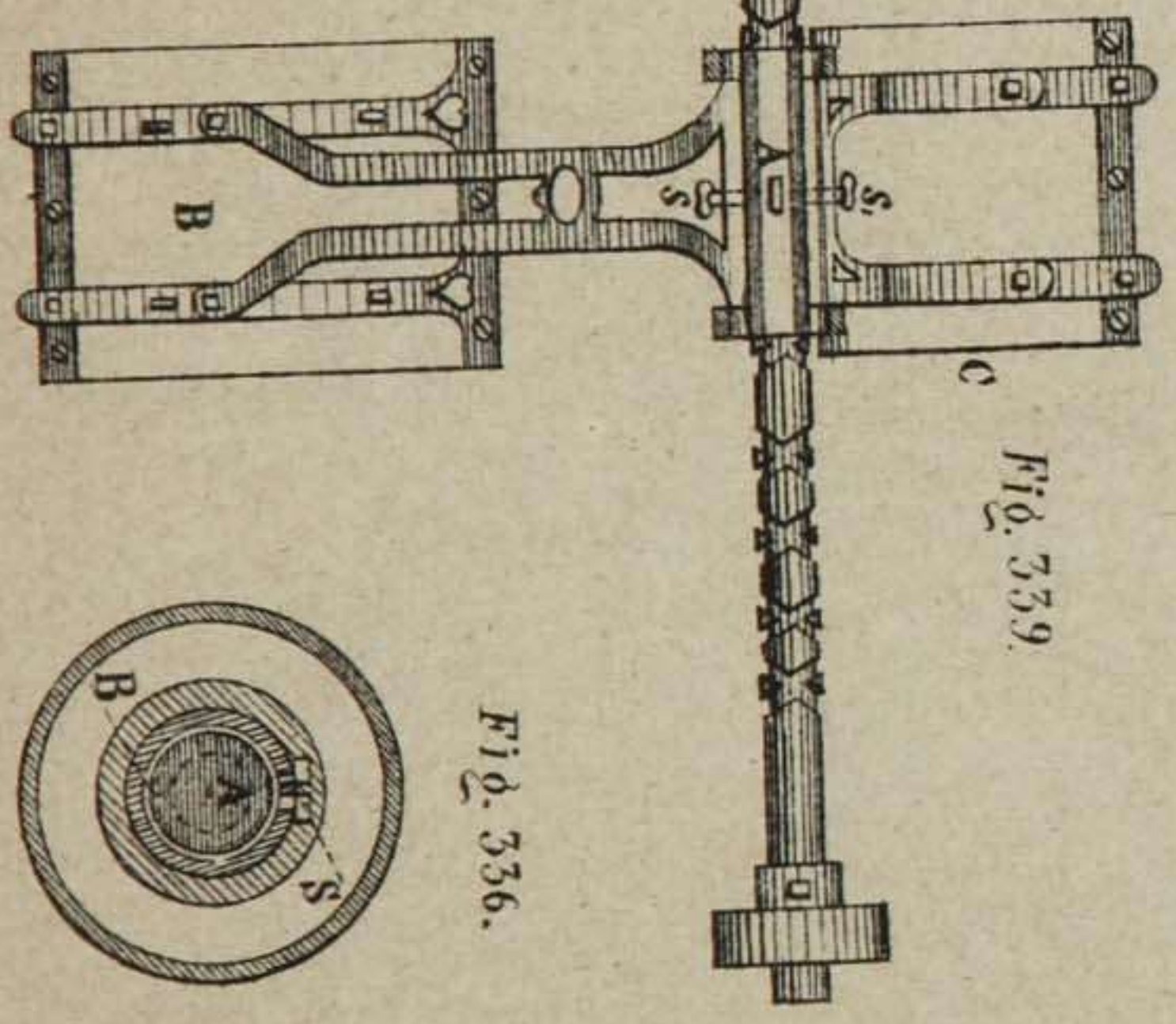


Fig. 336.

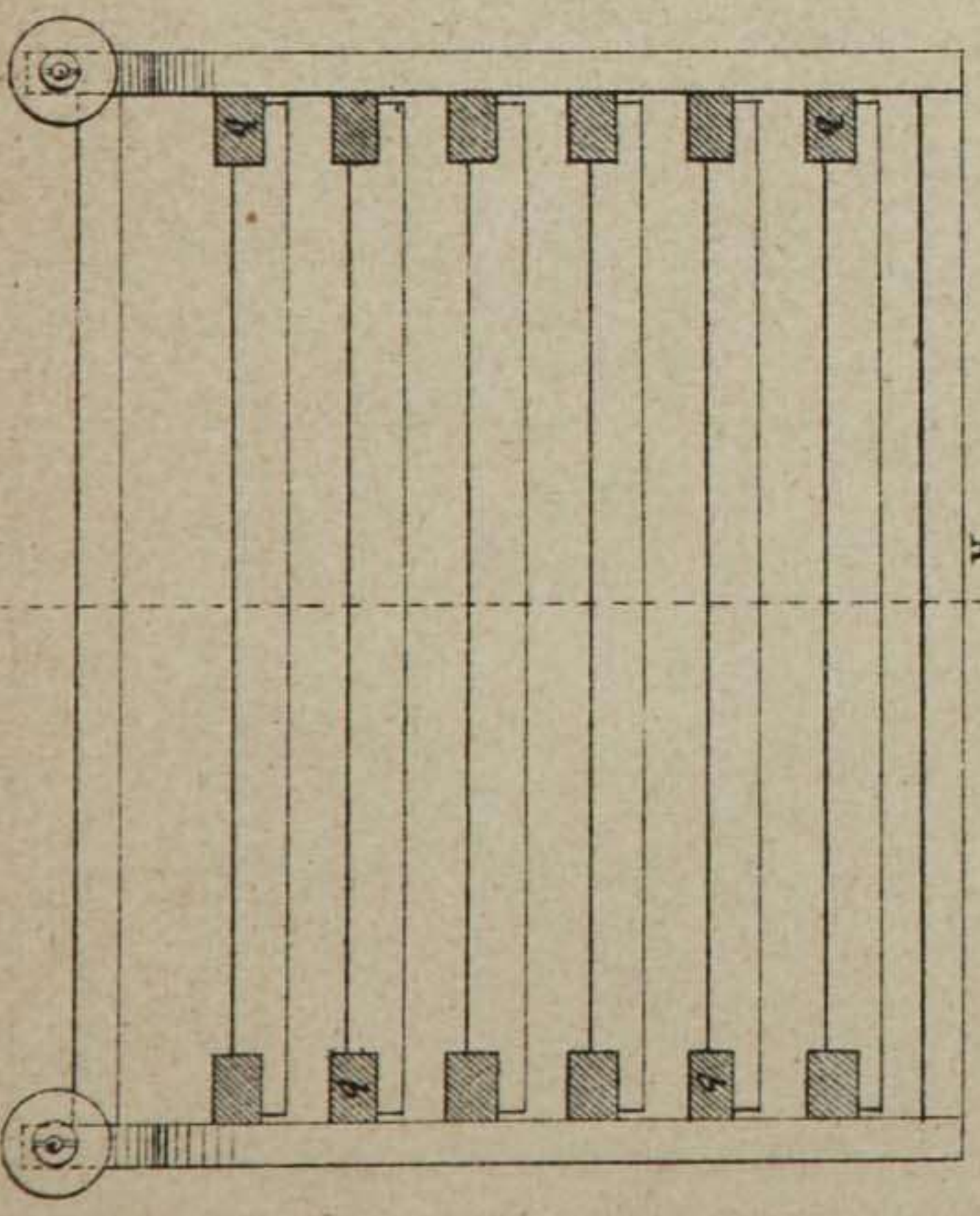
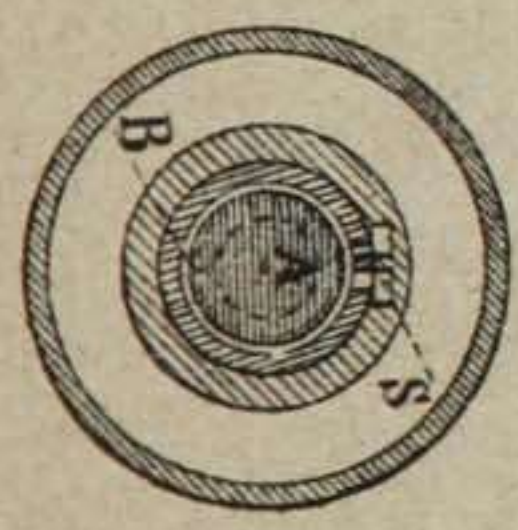


Fig. 342.

Fig. 372.

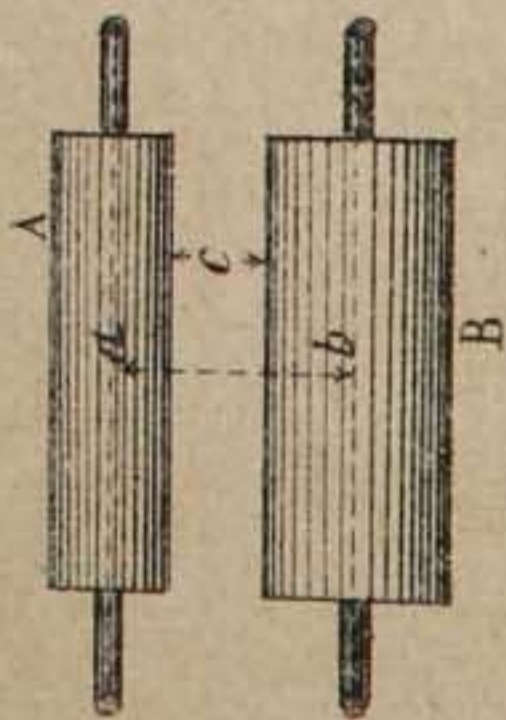


Fig. 375.

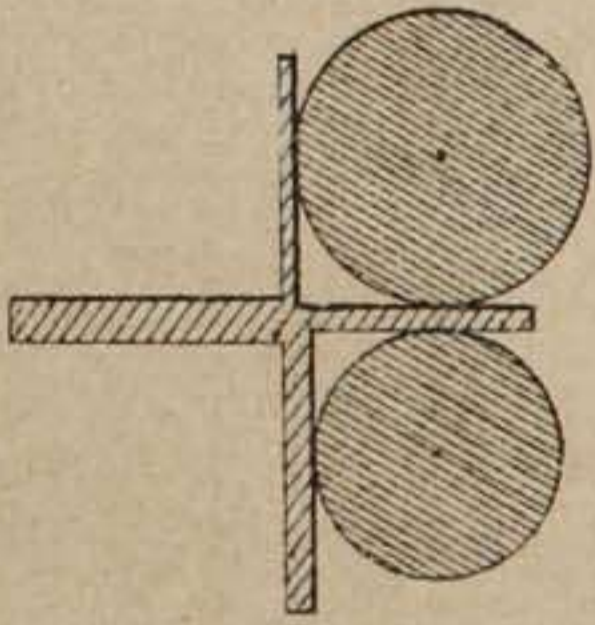


Fig. 376.

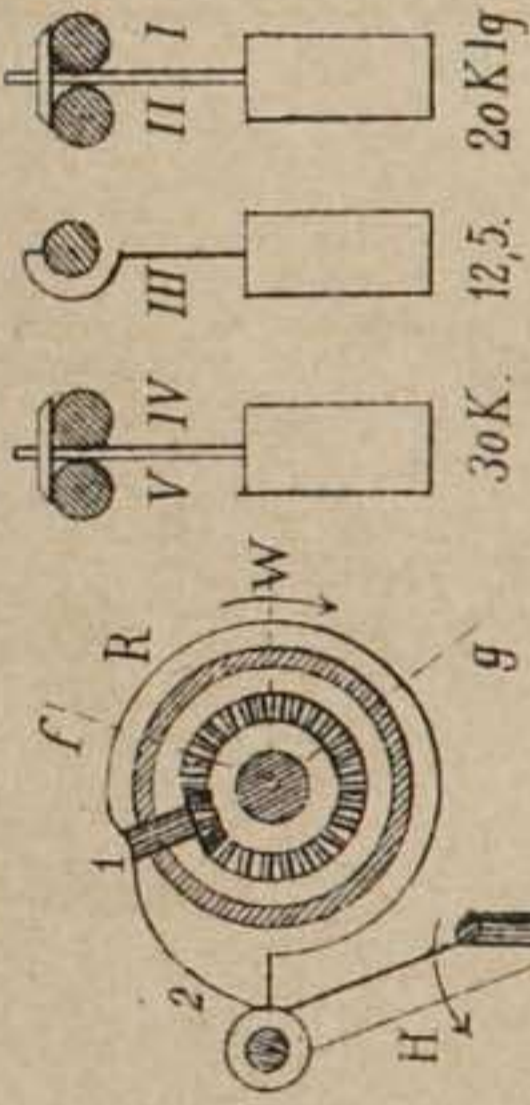


Fig. 367.

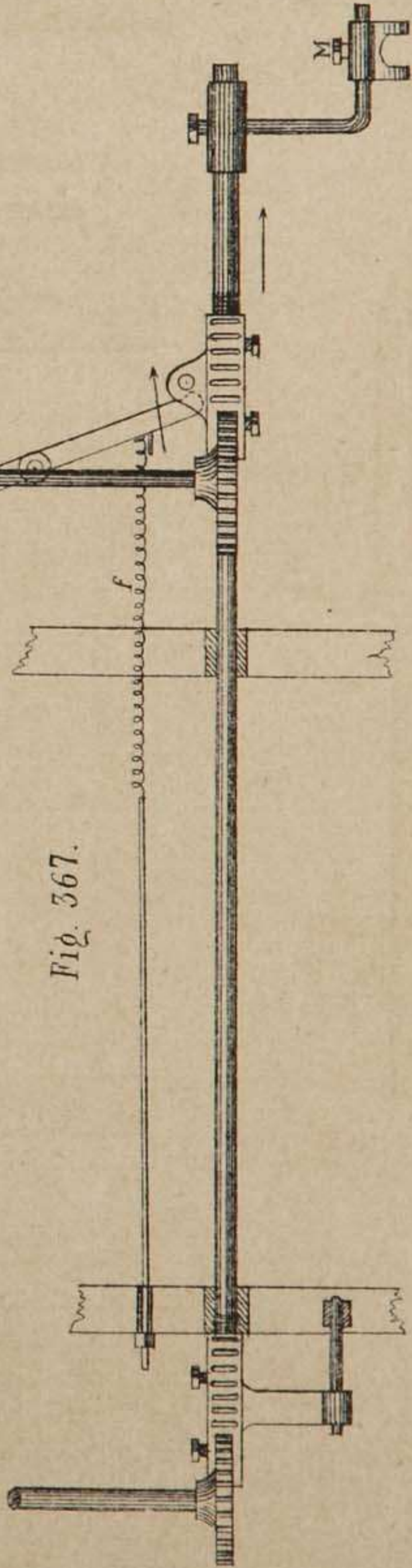


Fig. 370.

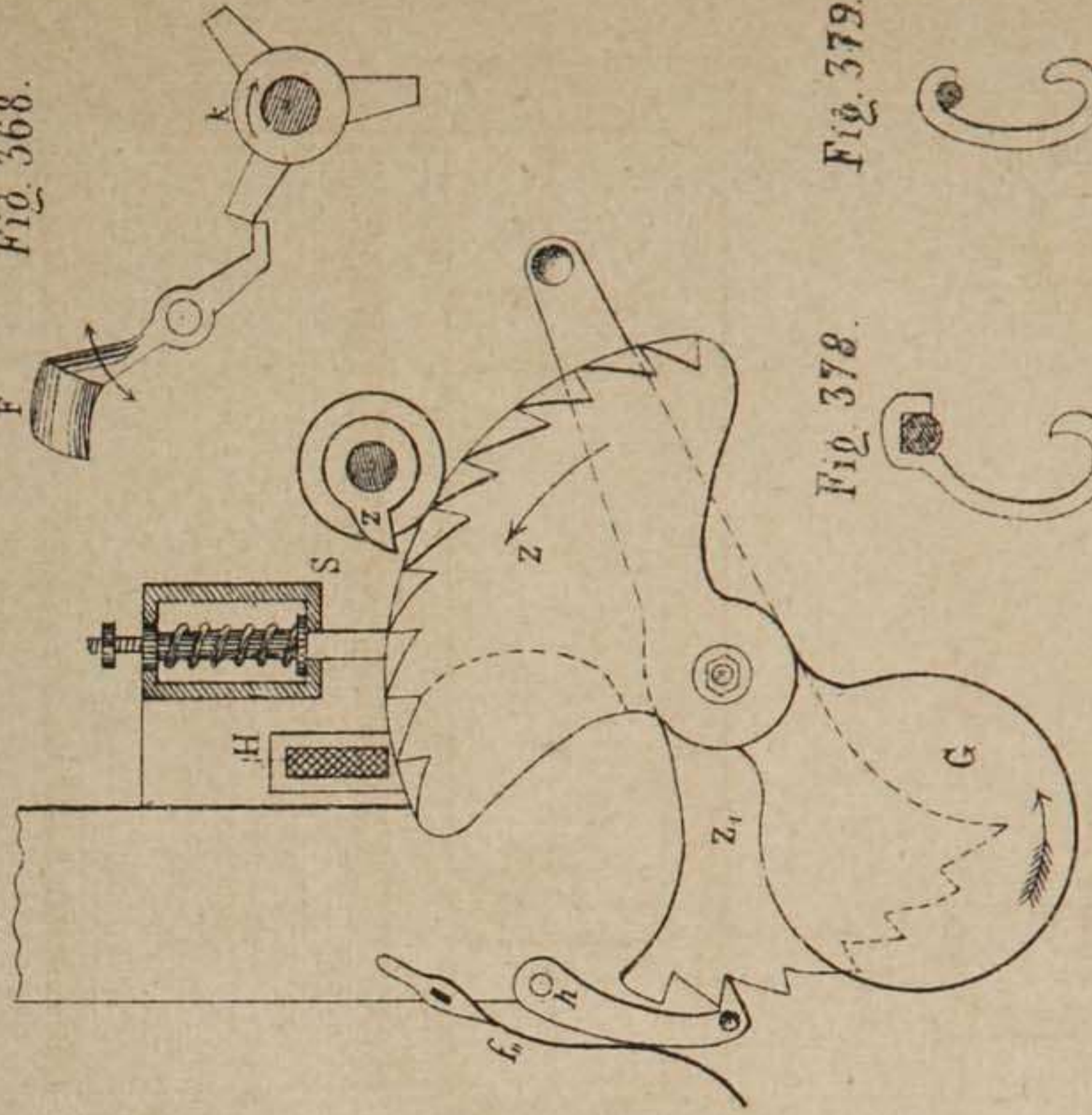


Fig. 378.



Fig. 379.



Fig. 373.

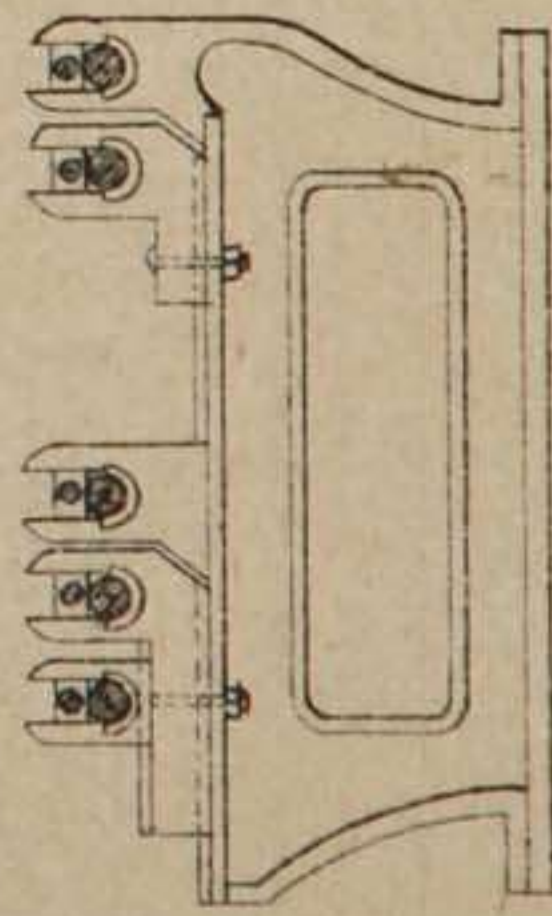


Fig. 374.

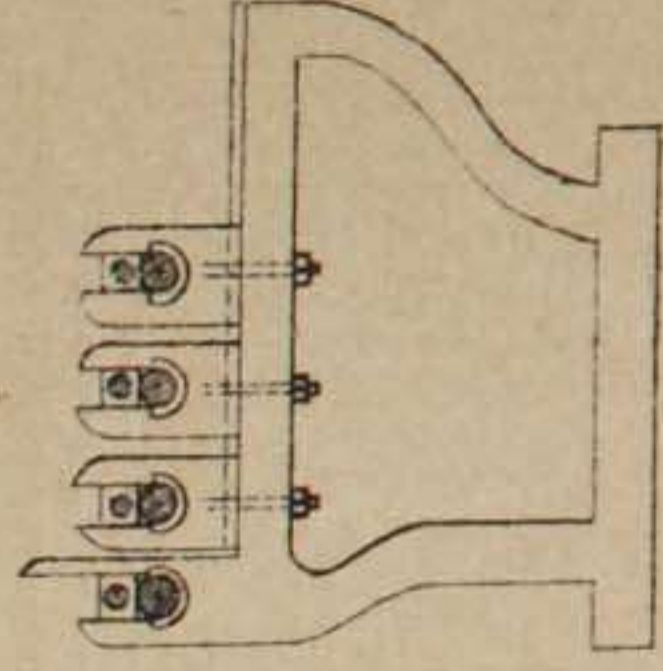


Fig. 377.

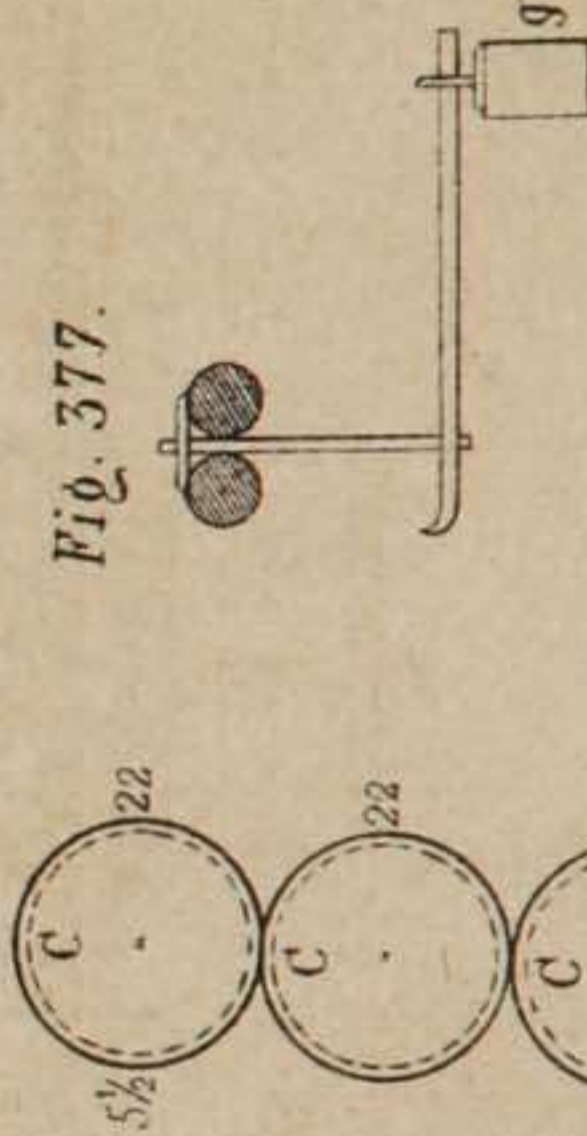


Fig. 371.

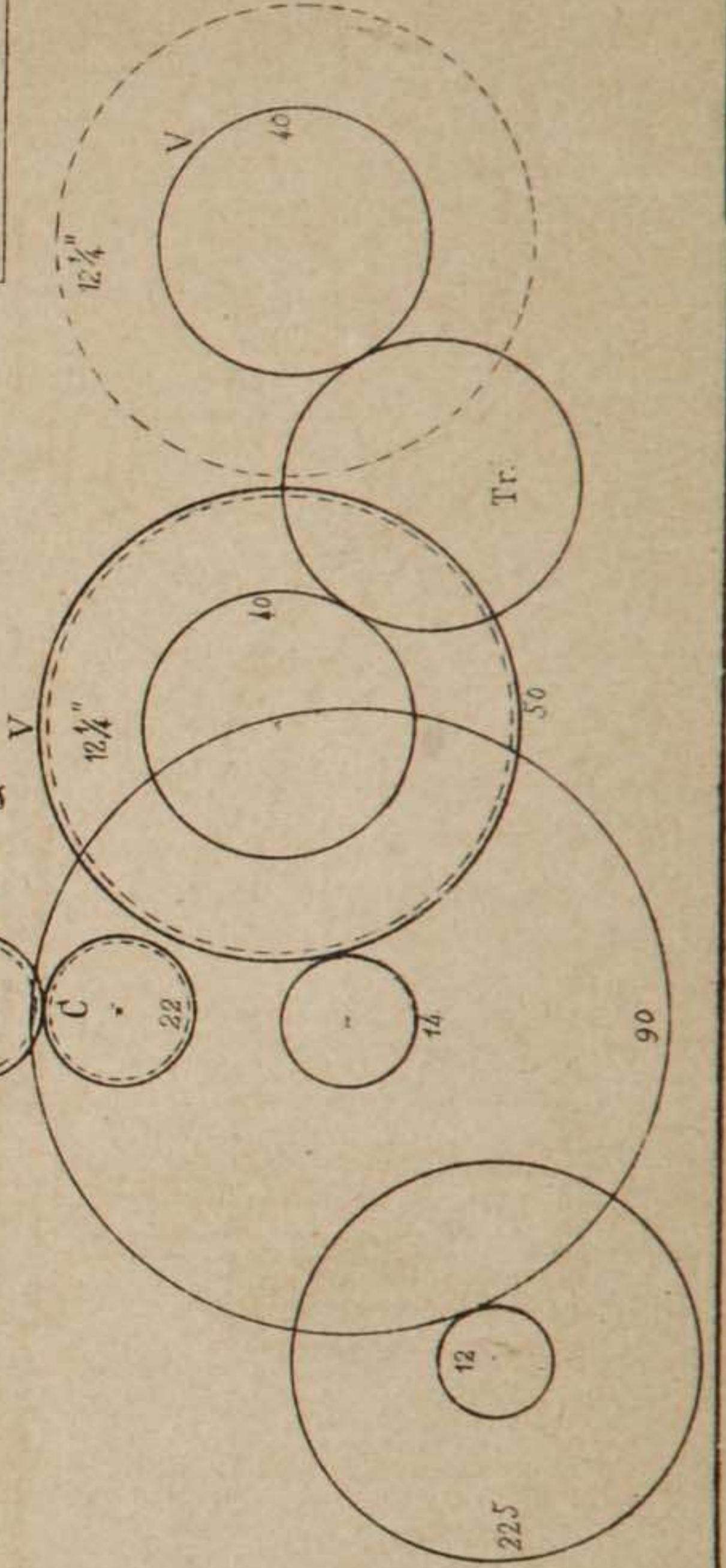
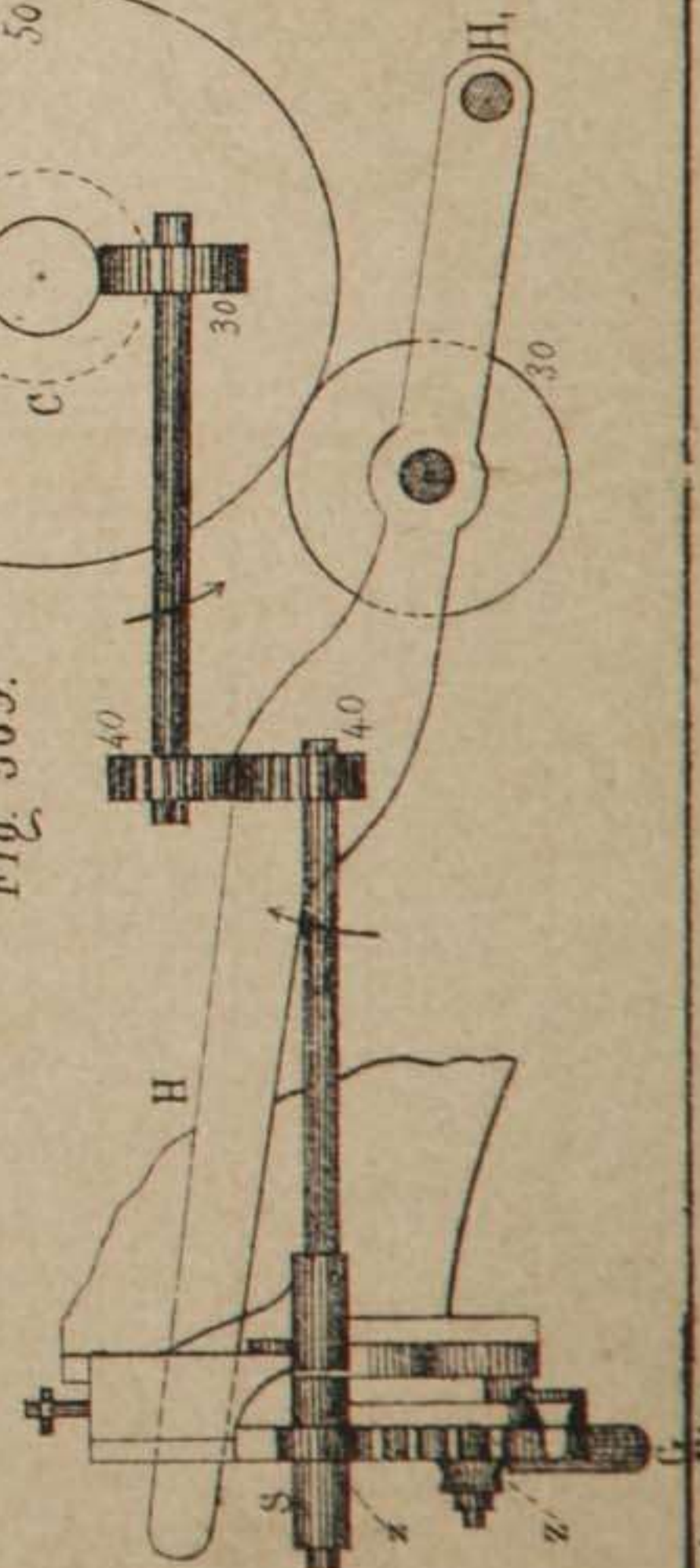


Fig. 369.



HILADURA Y PREPARACION.

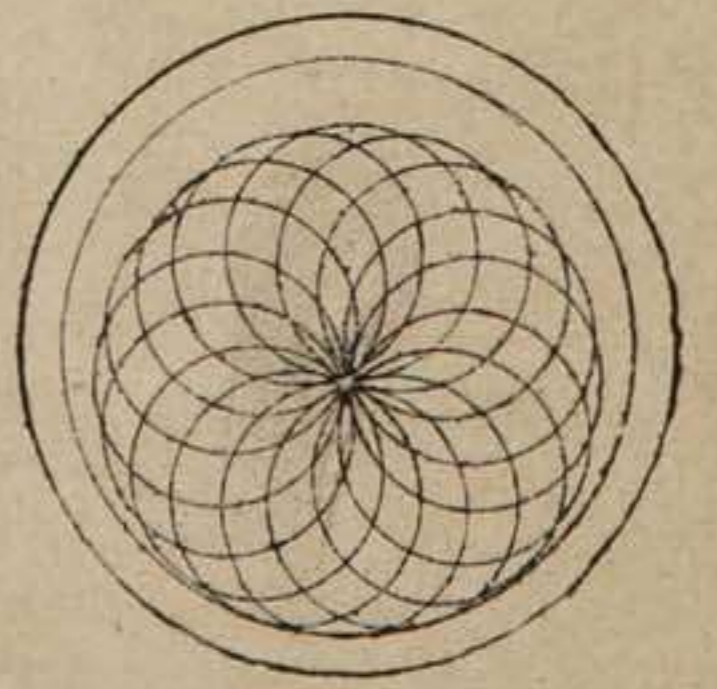


Fig. 357

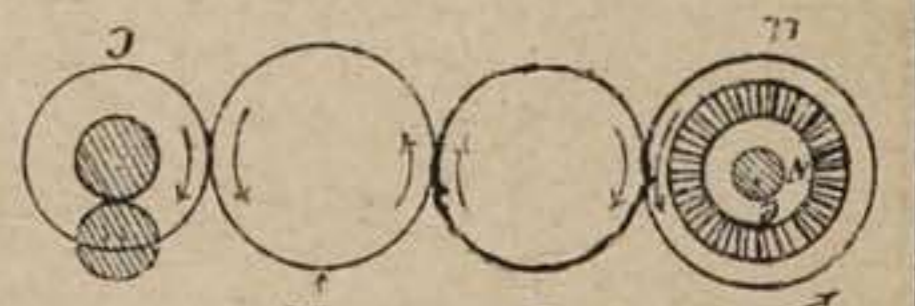


Fig. 365

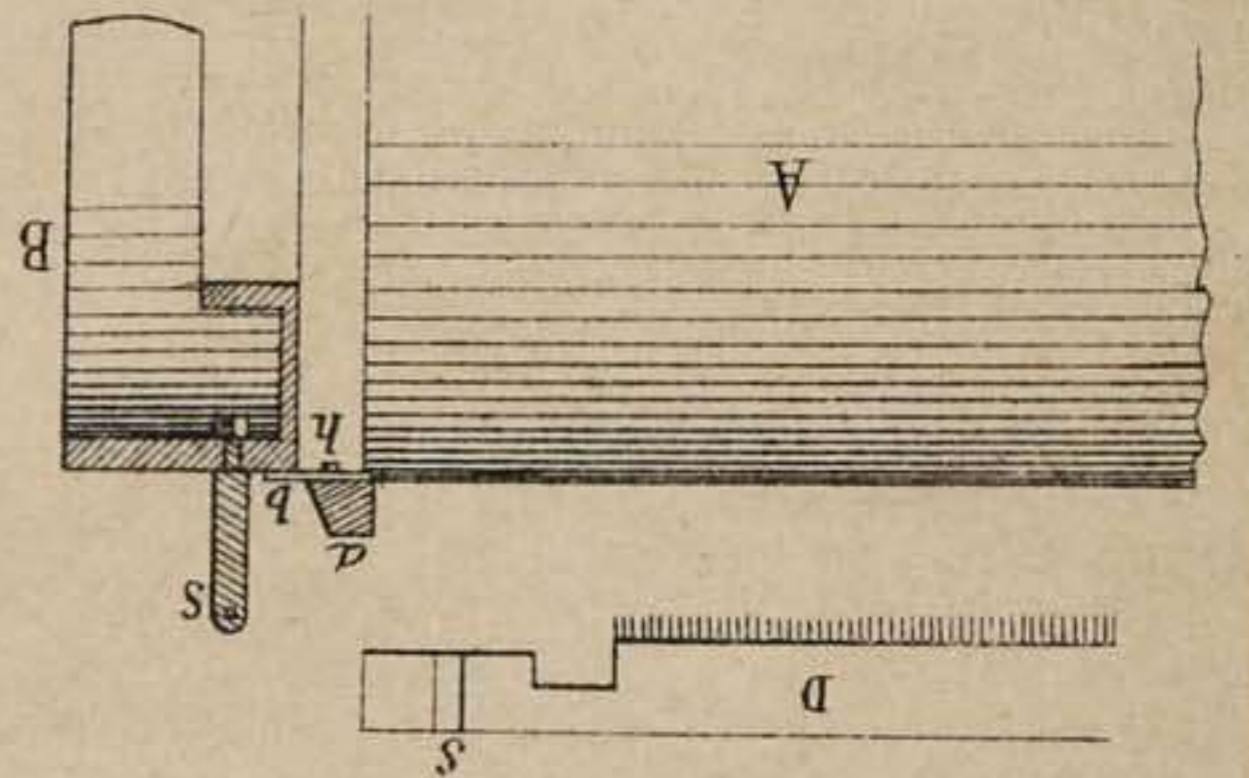


Fig. 359

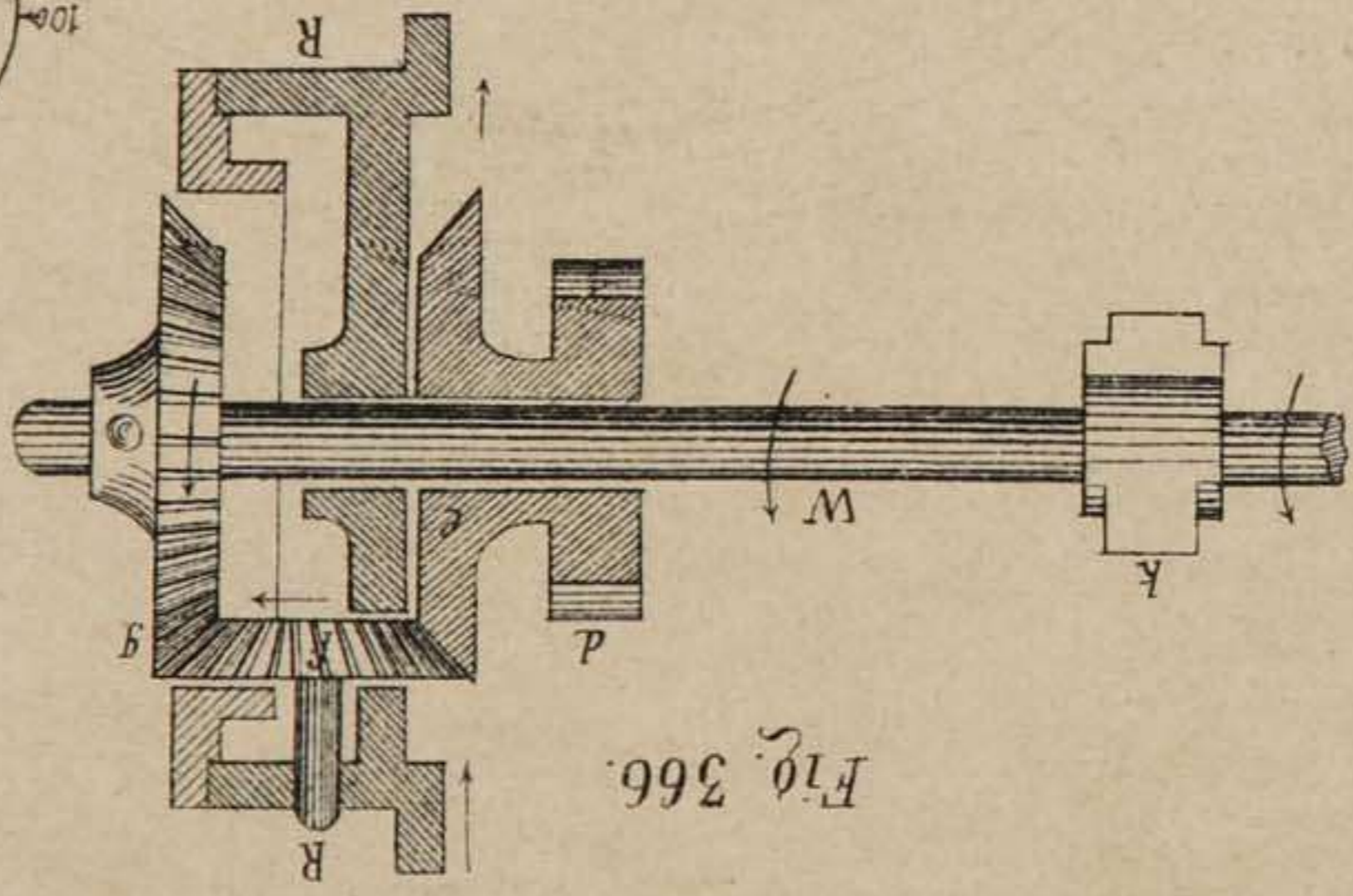


Fig. 366

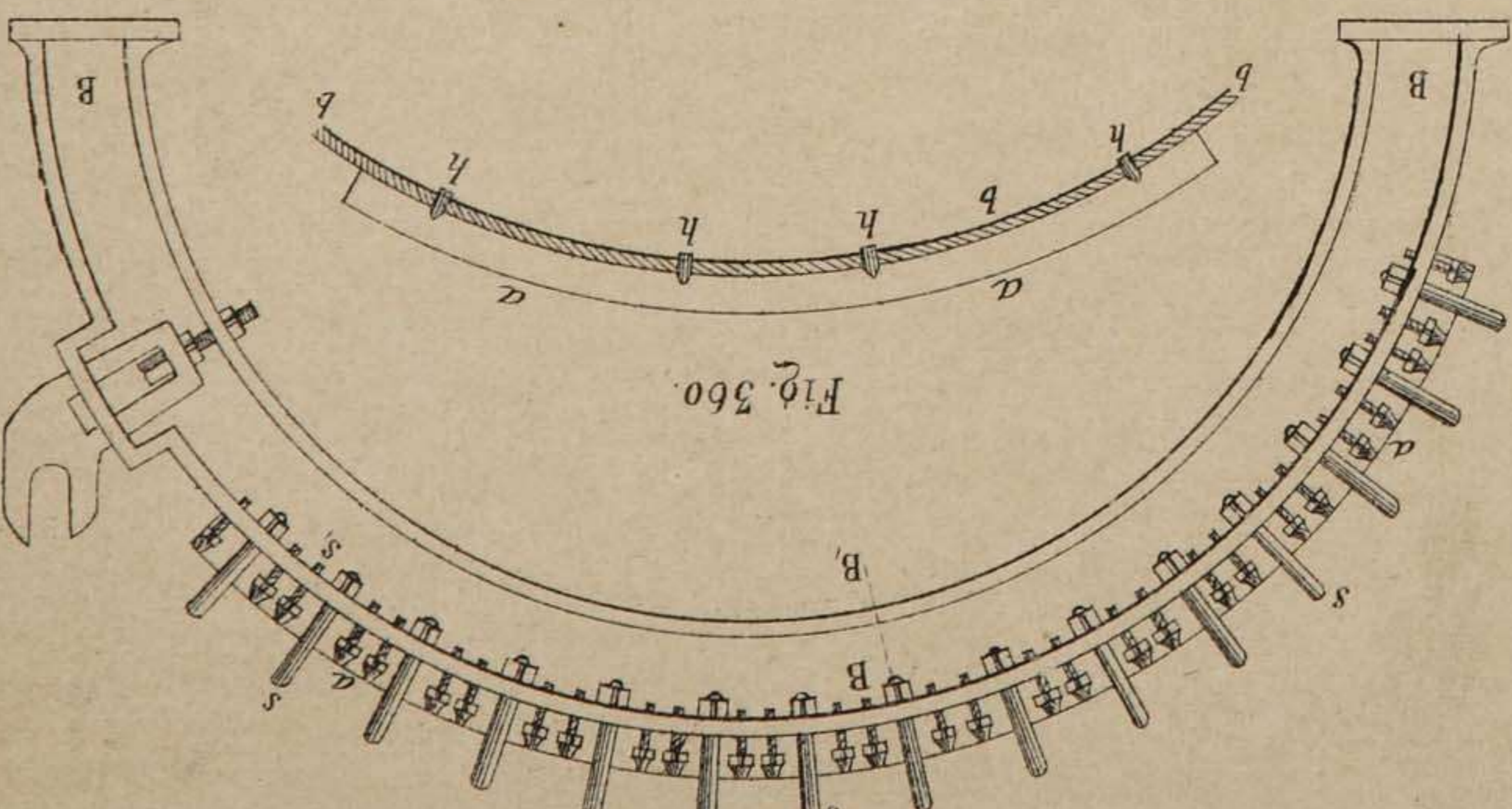


Fig. 358

Fig. 360

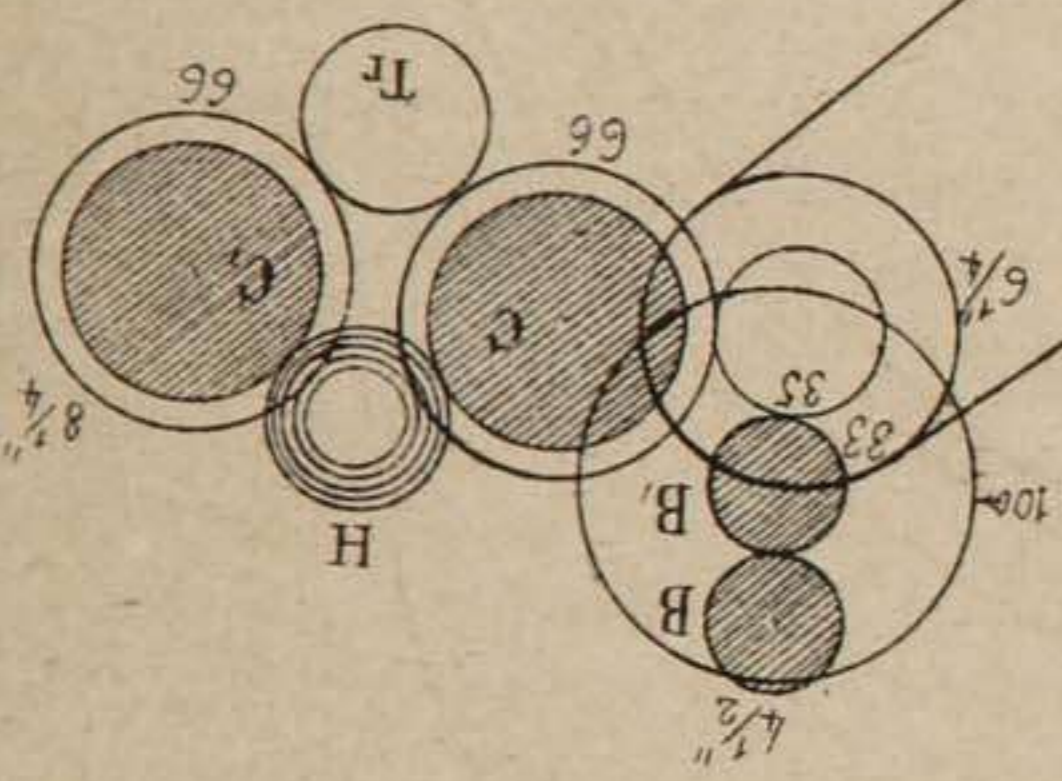


Fig. 364

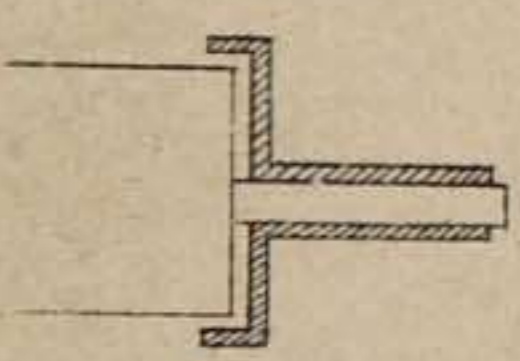


Fig. 361

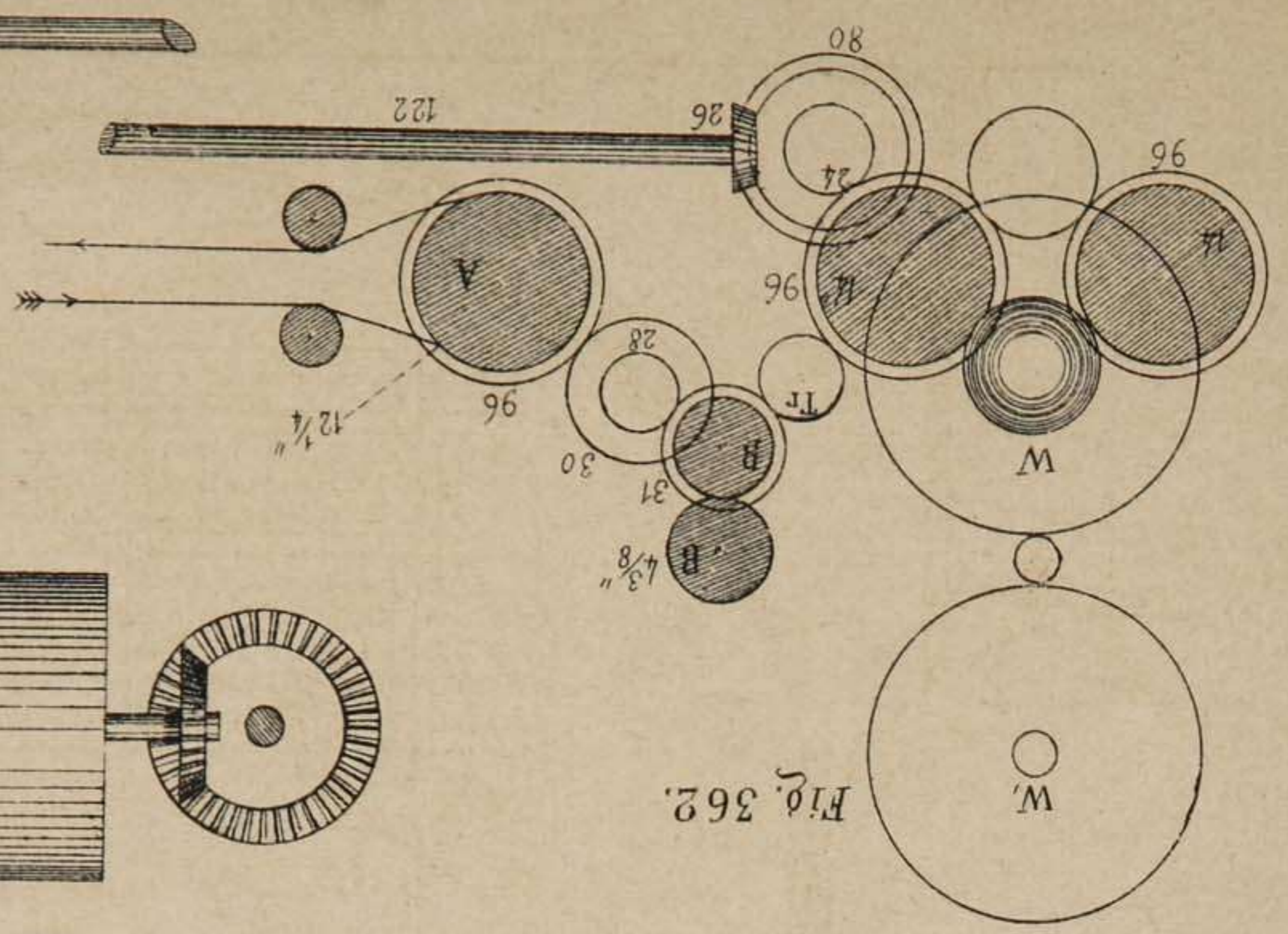


Fig. 362

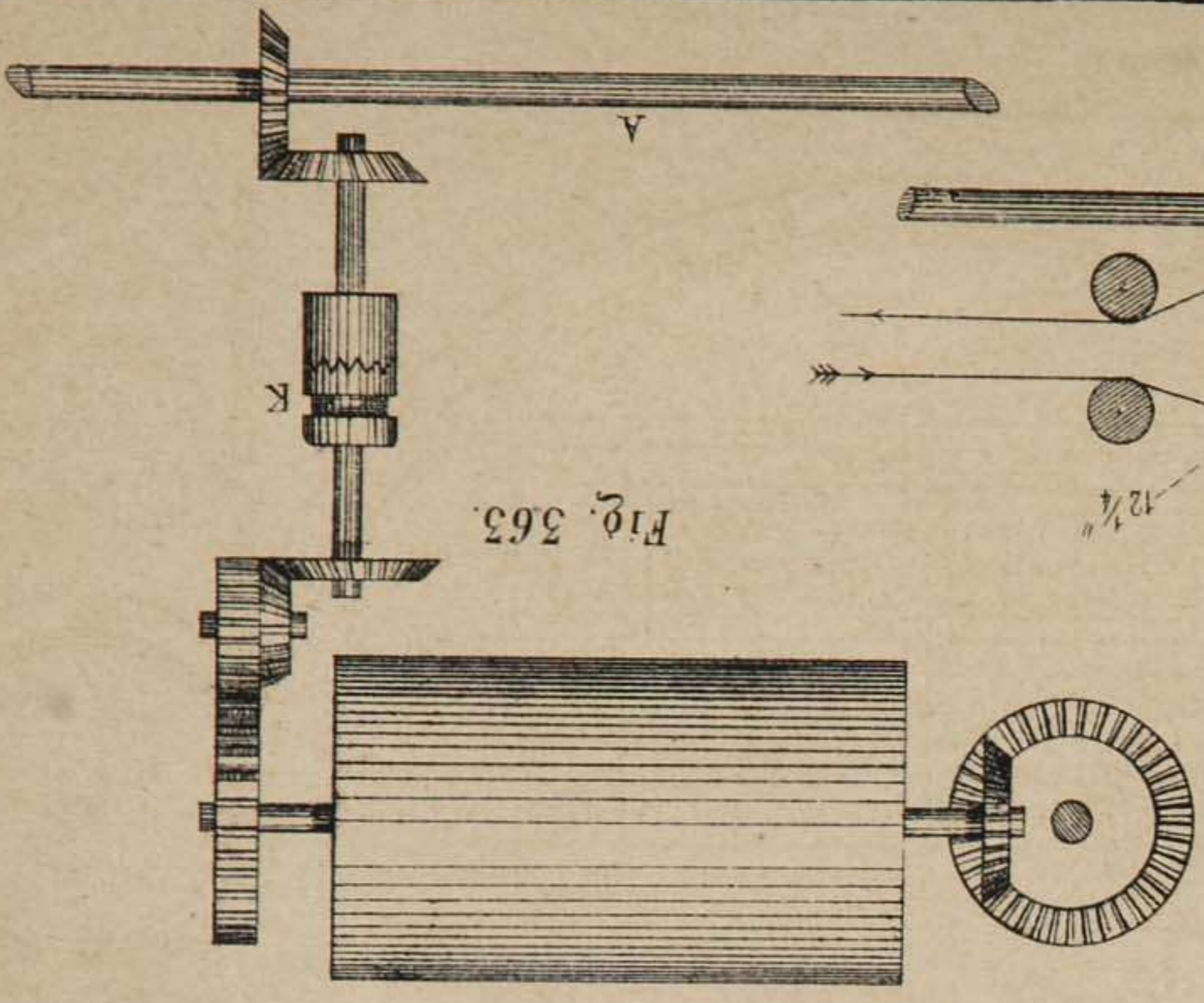


Fig. 363

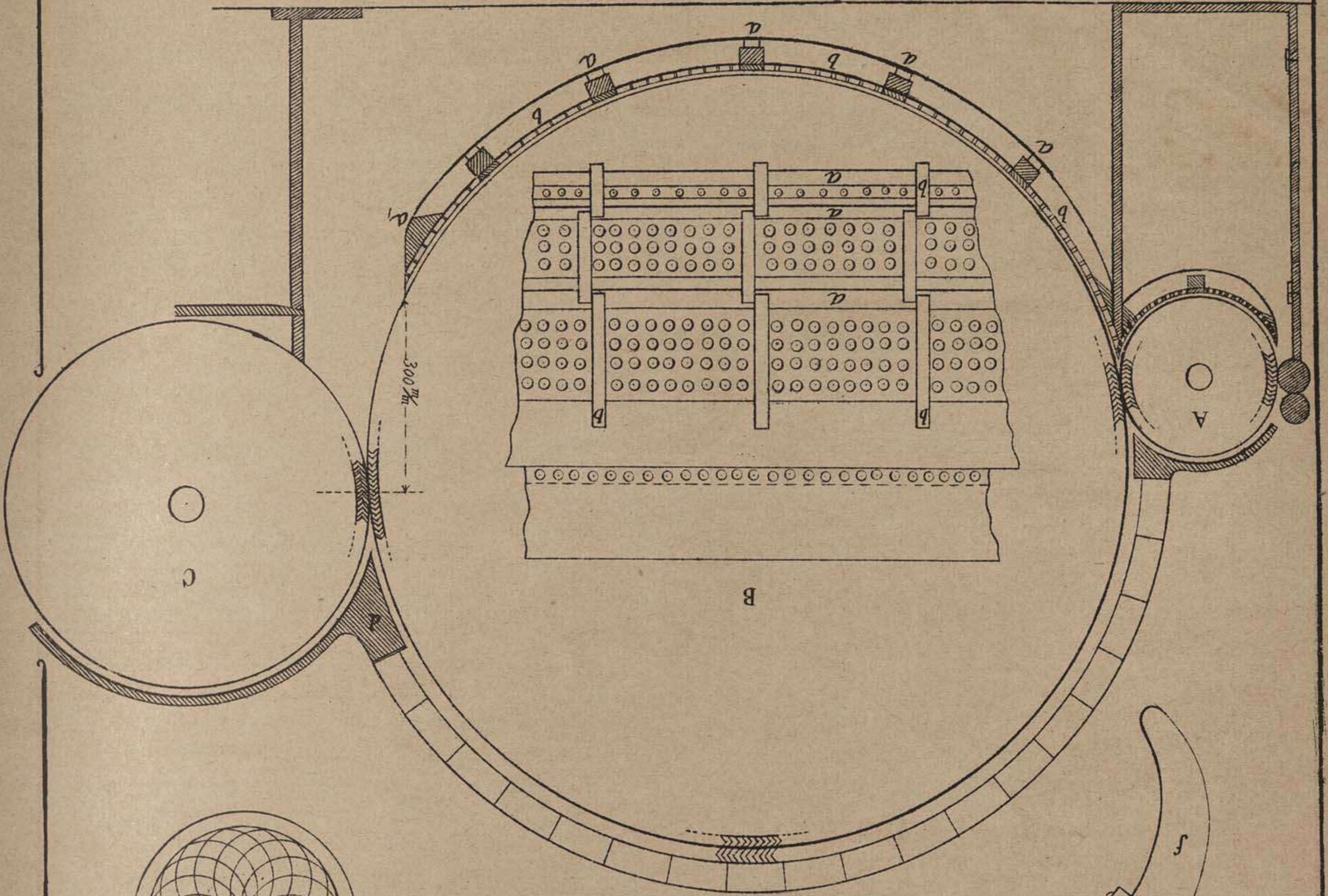


Fig. 354.

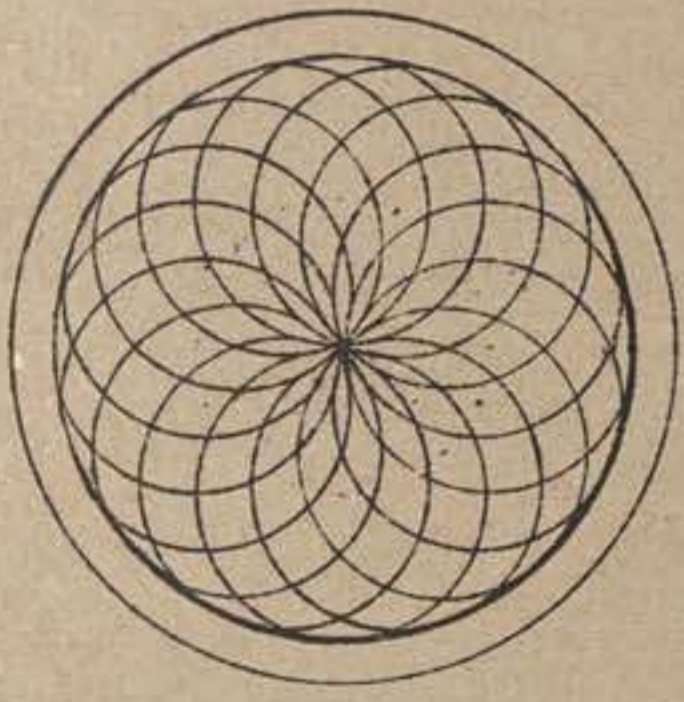


Fig. 355.

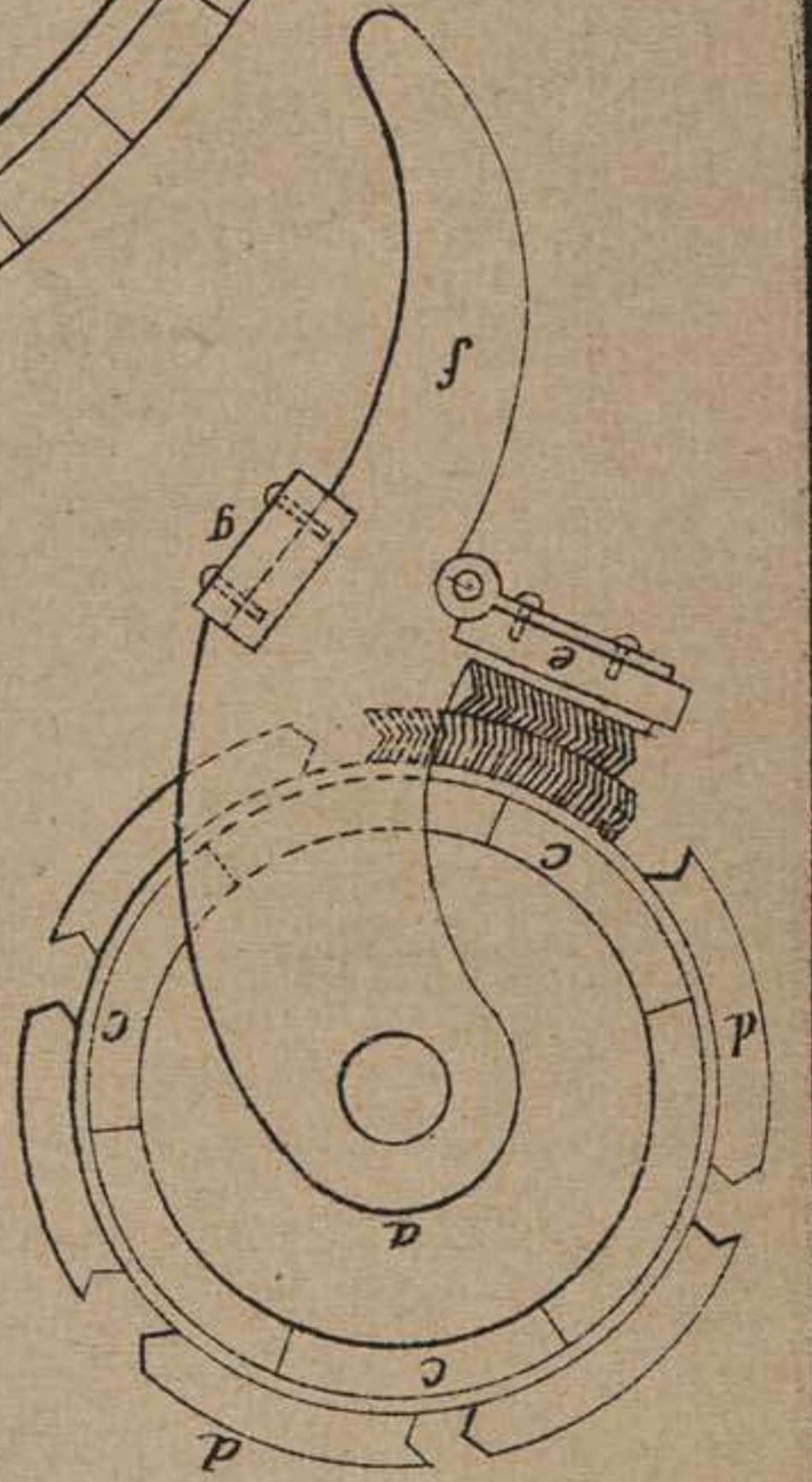


Fig. 353.

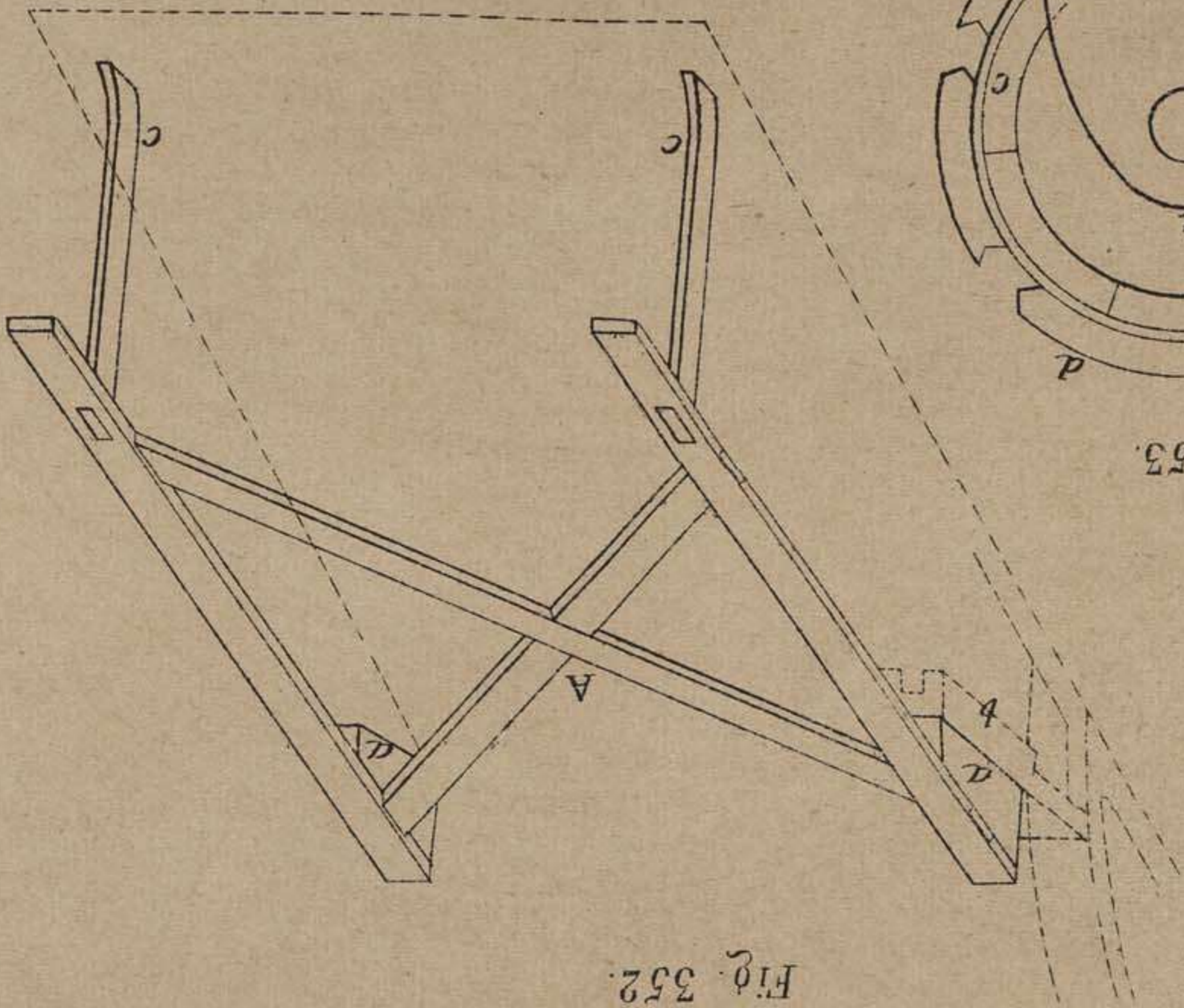


Fig. 352.

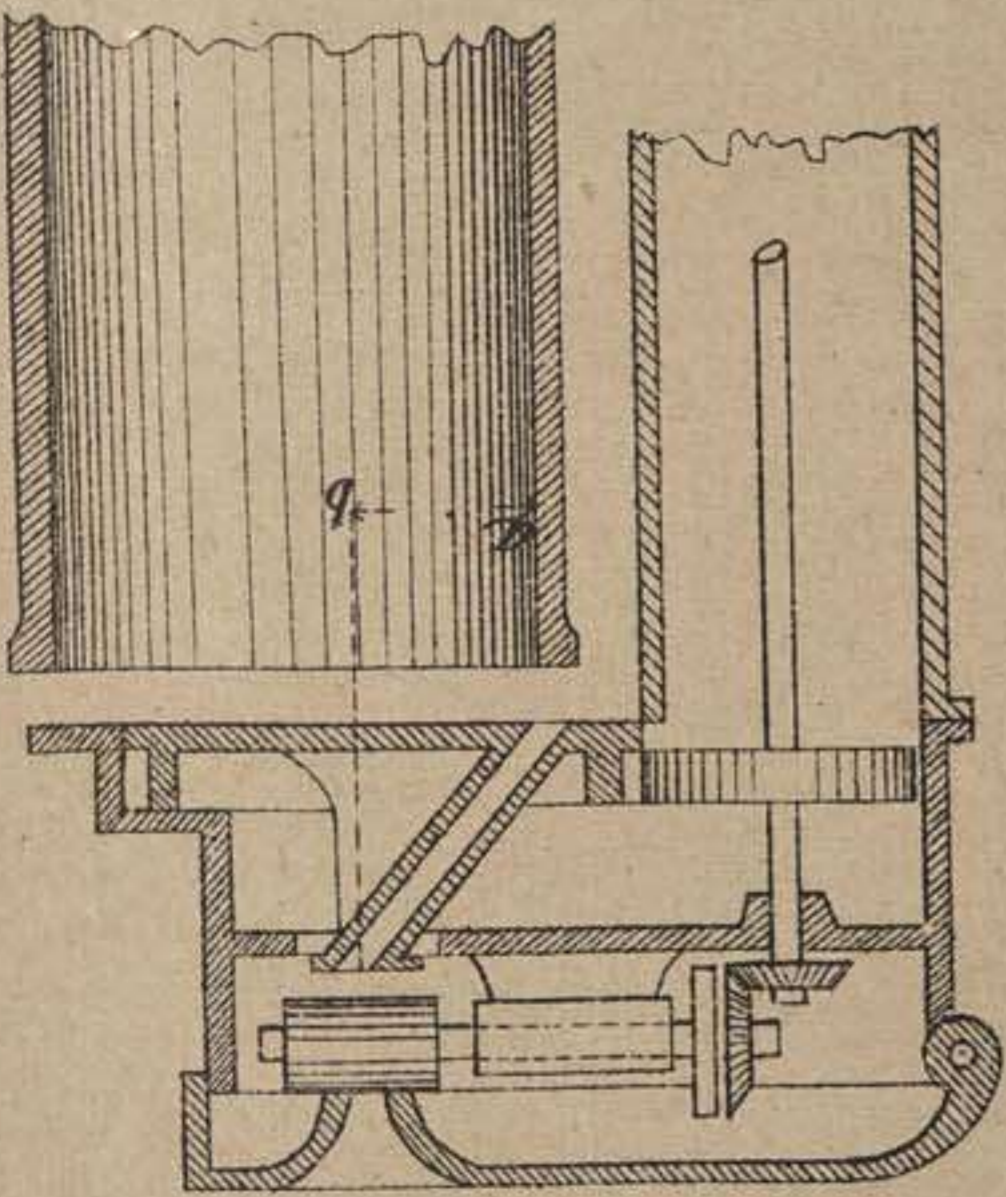


Fig. 356.

HILADURA Y PREPARACION.

Fig. 344.



Fig. 343.

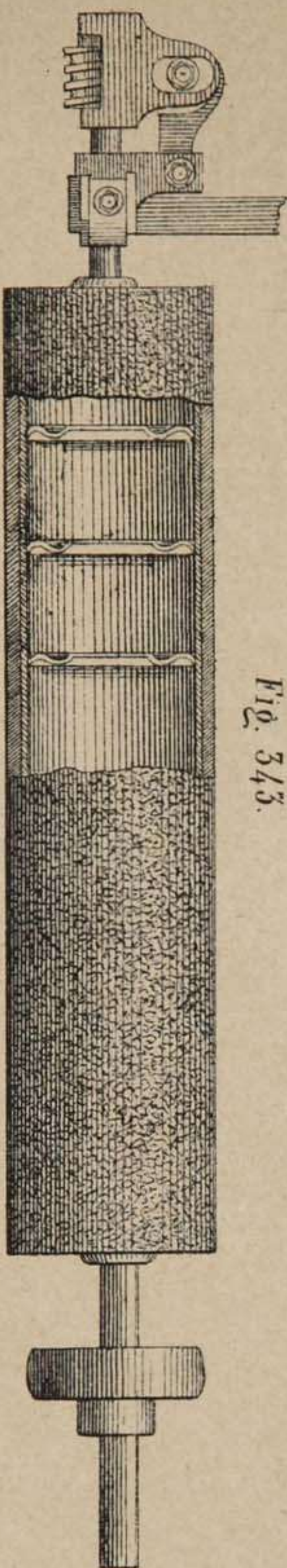


Fig. 350.



Fig. 345.



Fig. 348.

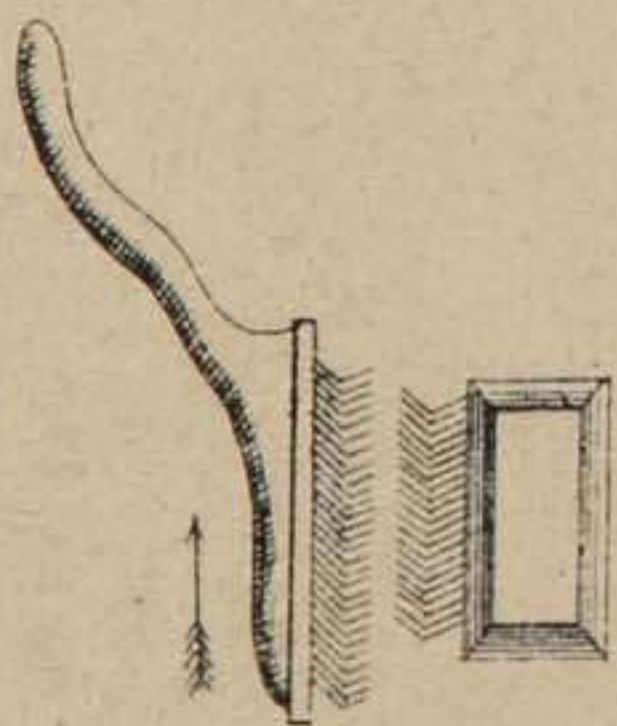


Fig. 350.

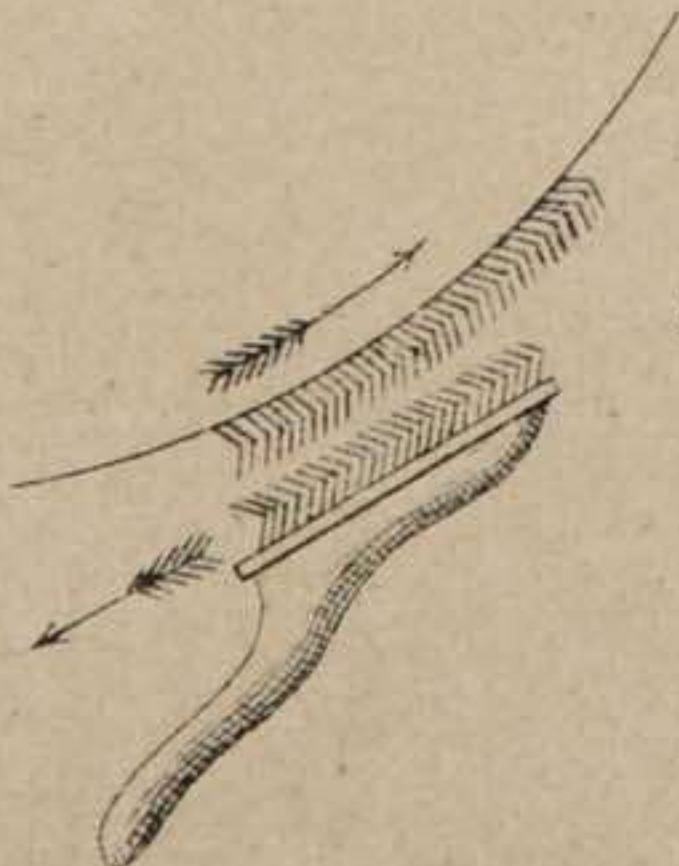


Fig. 346.

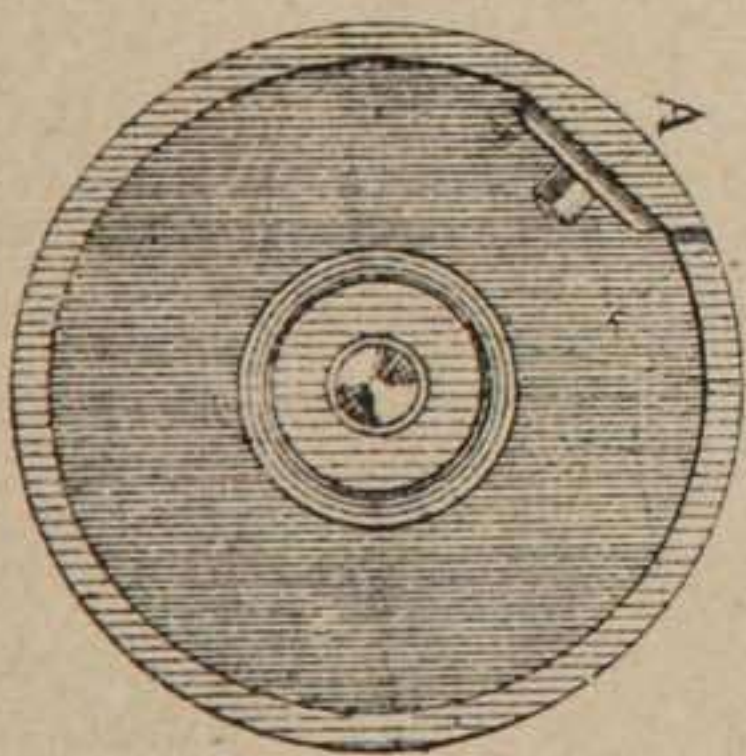


Fig. 347.

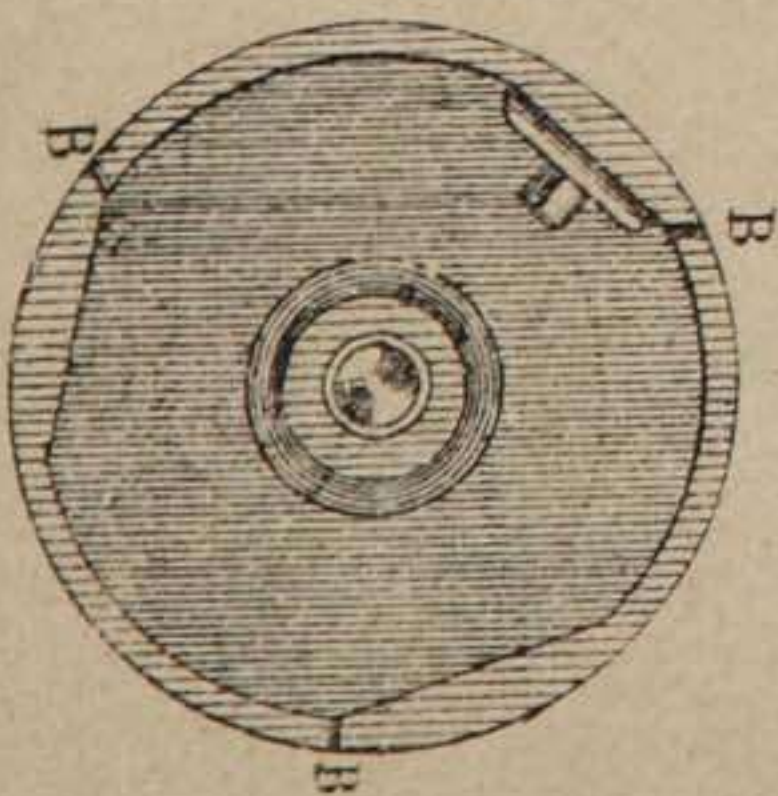
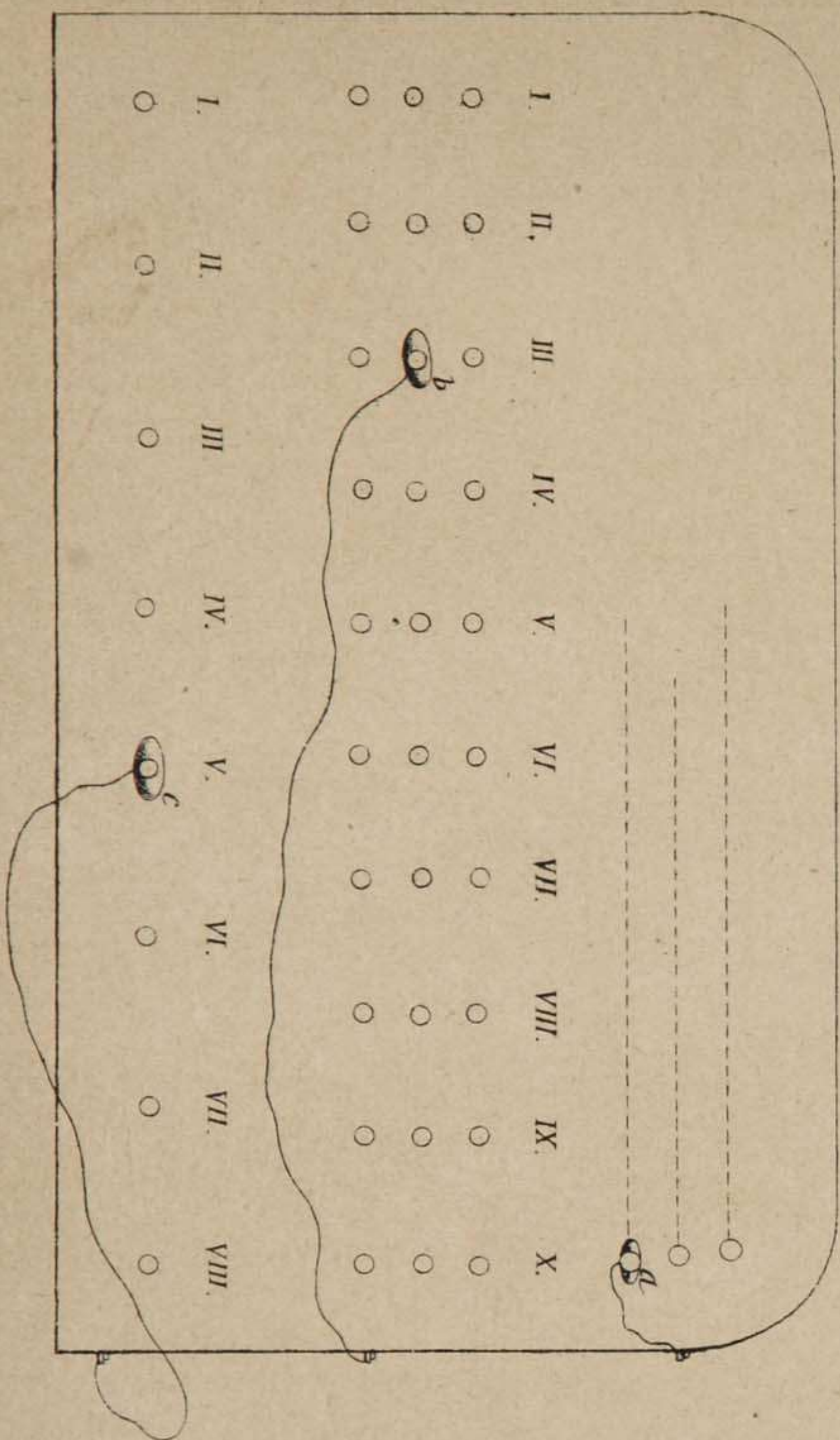


Fig. 349.



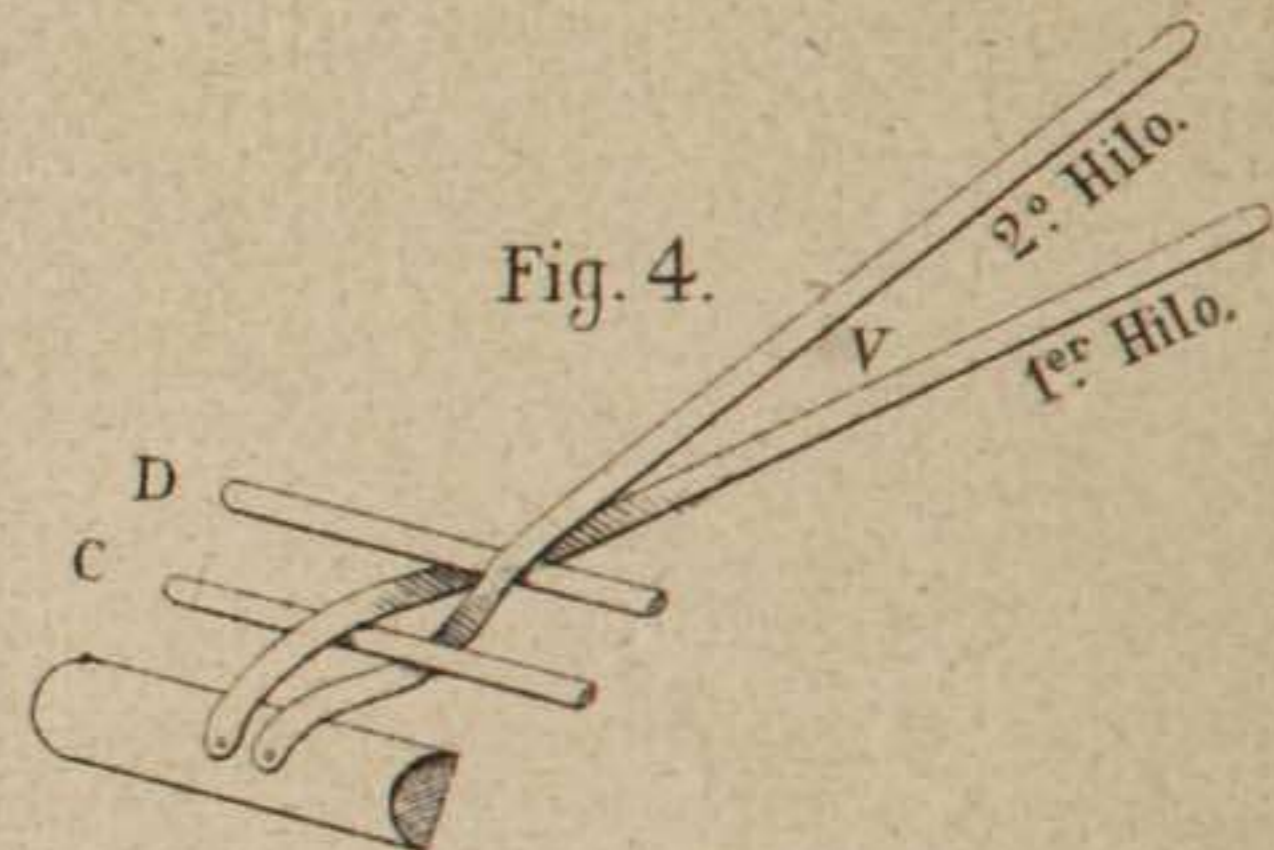
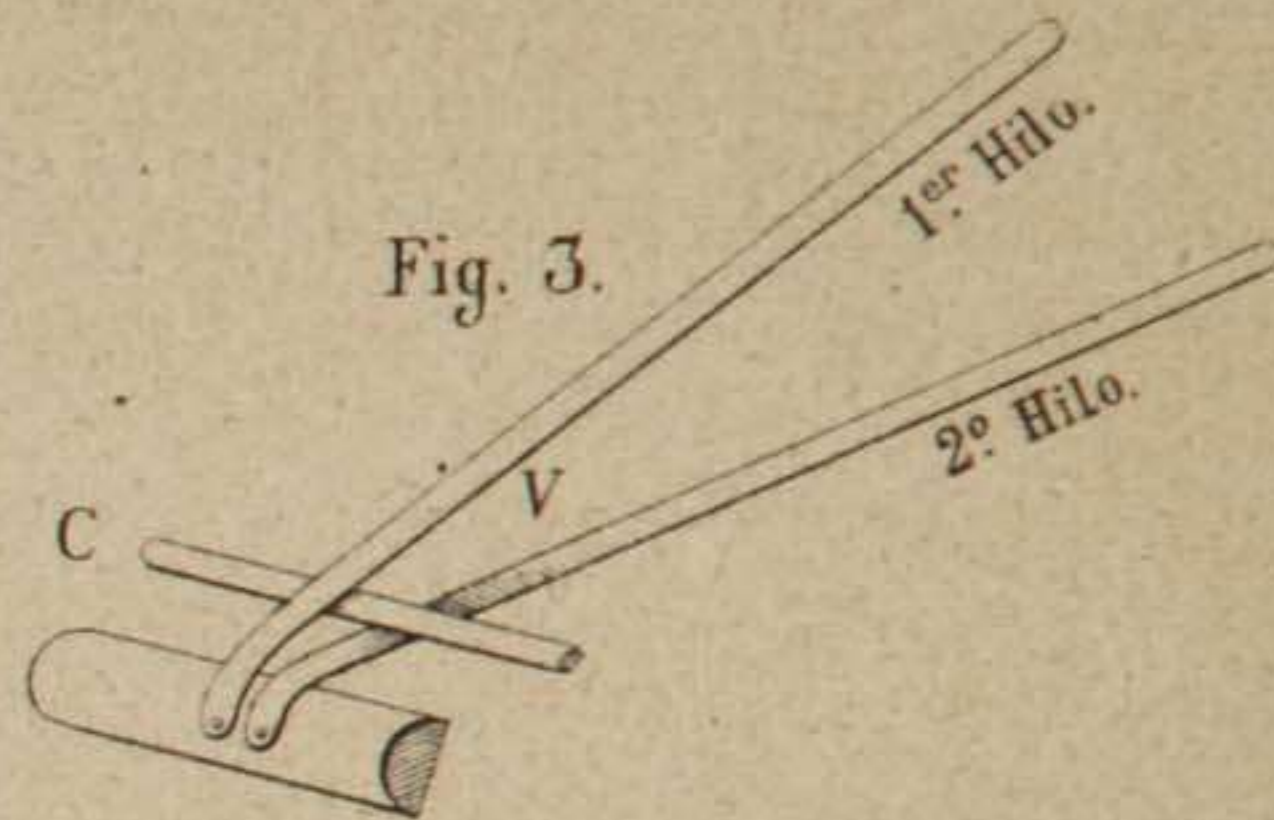
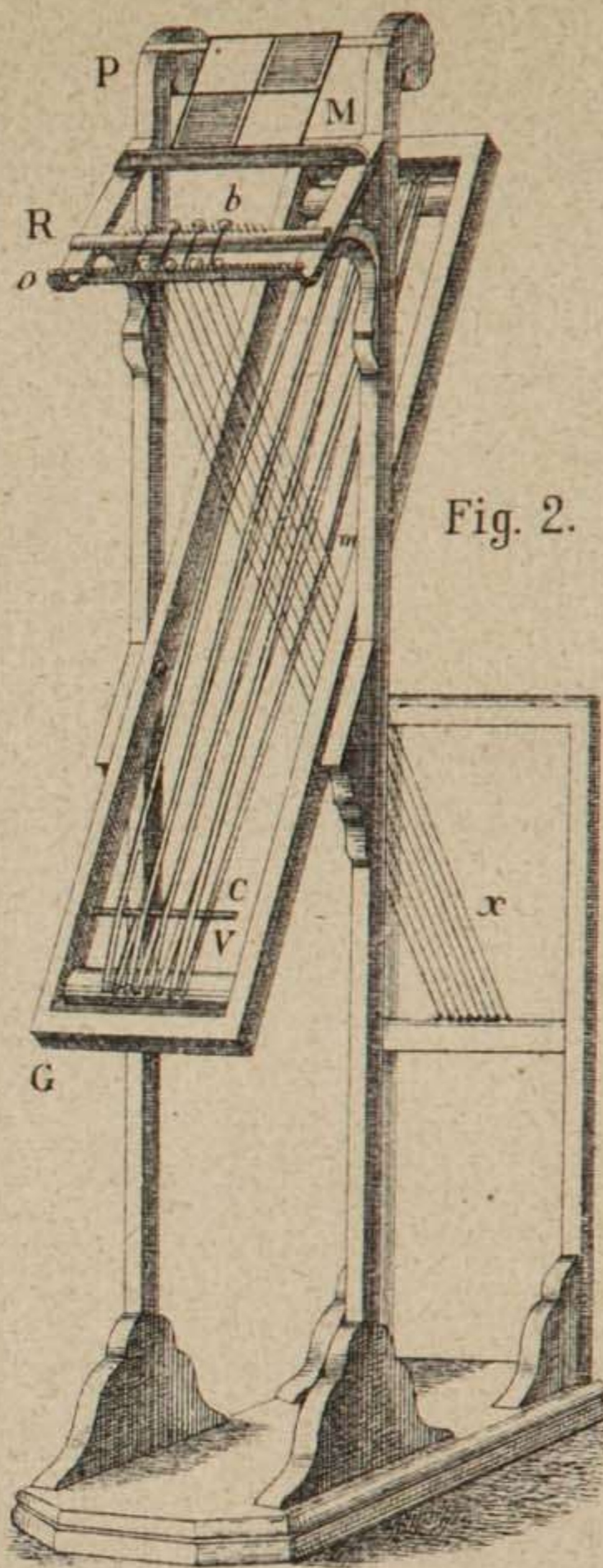
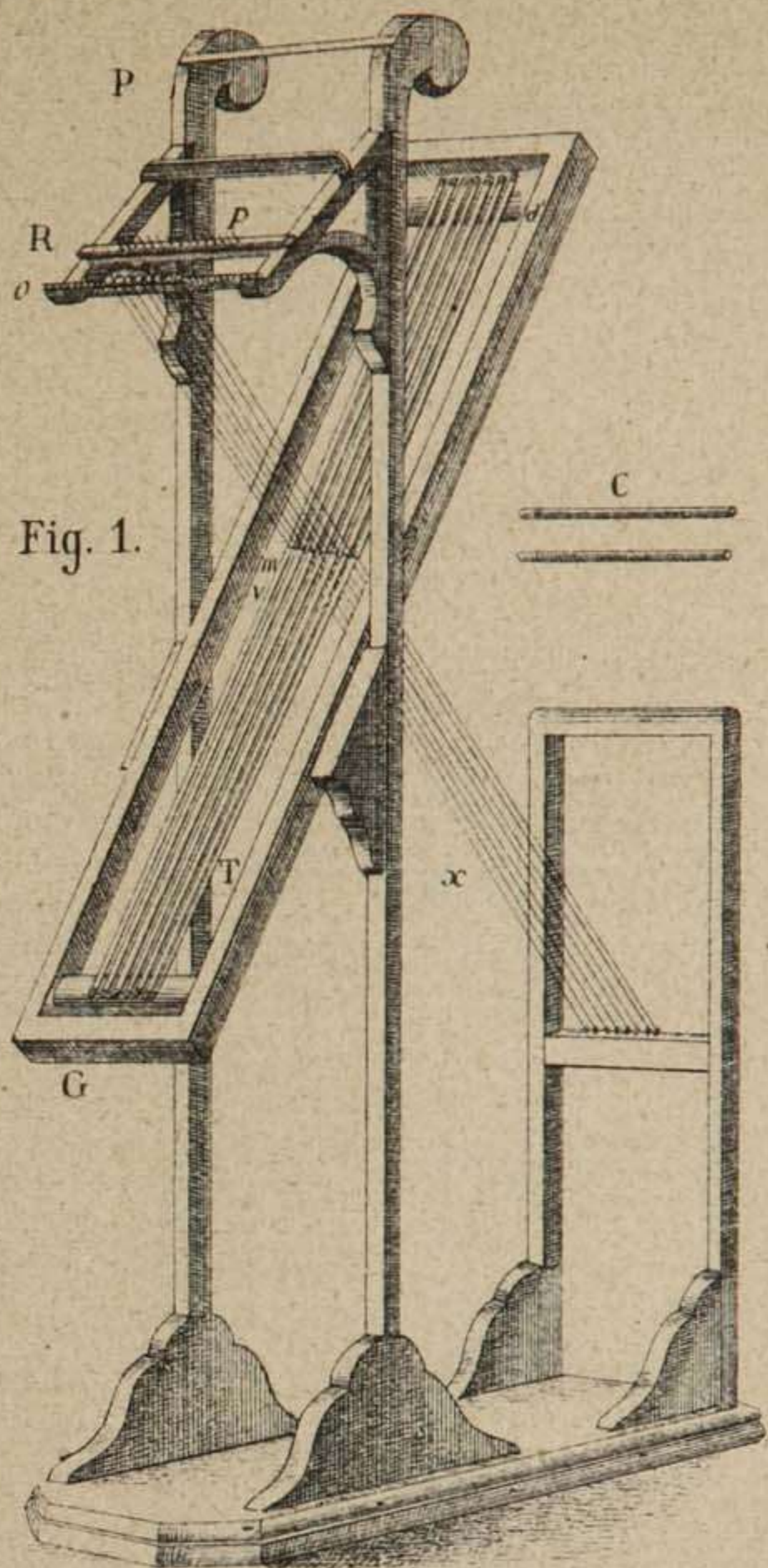


Fig. 5.
 □ 2ª pasada.
 ■ 1ª pasada.
 2.

Fig. 6.
 ■ 2ª pasada.
 □ 1ª pasada.
 2.

Fig. 7.
 □ ■ 2ª pasada.
 ■ □ 1ª pasada.
 1 2

Fig. 8 y 9.
 □ ■ 2ª pasada.
 1 2
 ■ □ 1ª pasada.
 1 2

TAFETAN.

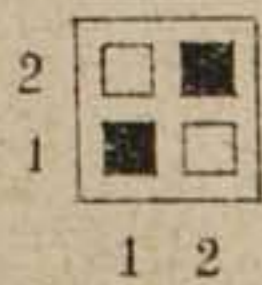


Fig. 10.

BATAVIA.

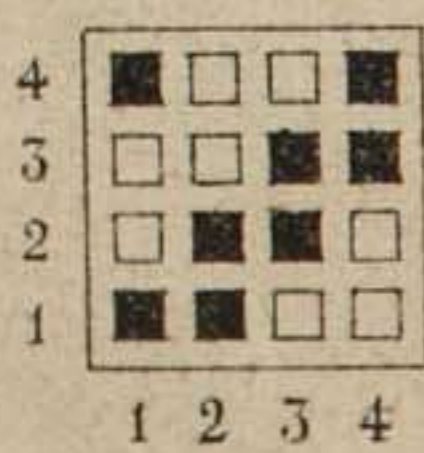


Fig. 11.

SARGA.

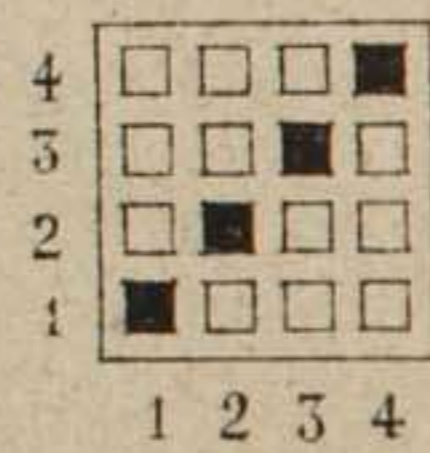


Fig. 12.

RASO.

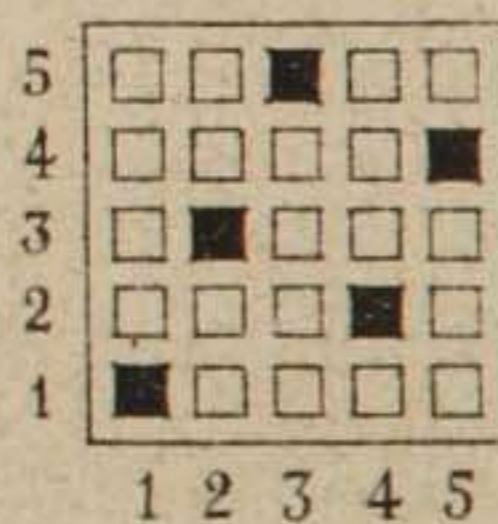


Fig. 13.

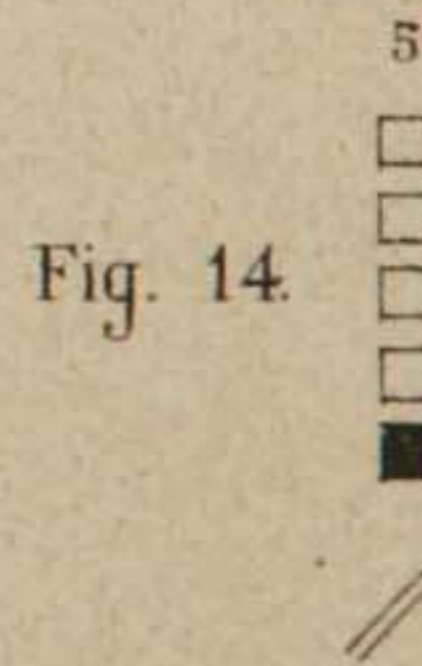


Fig. 14.

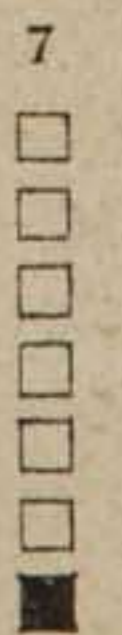


Fig. 15.

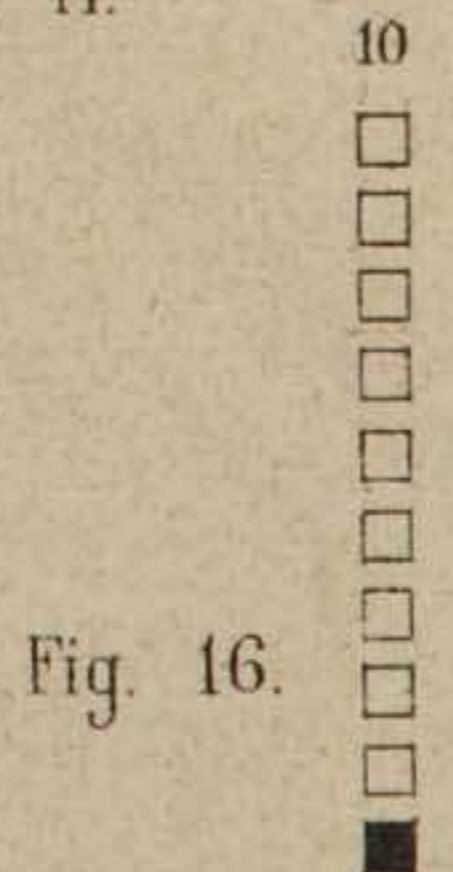


Fig. 16.

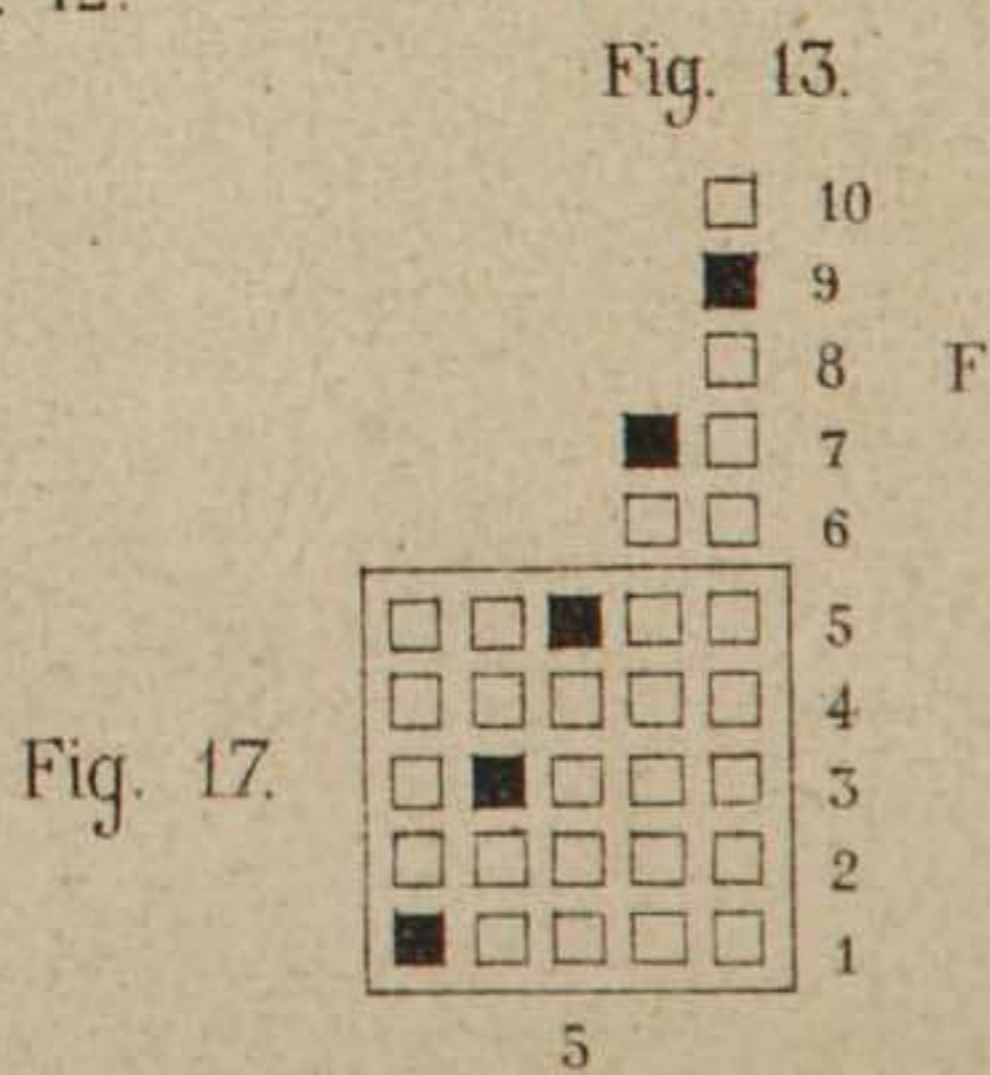


Fig. 17.

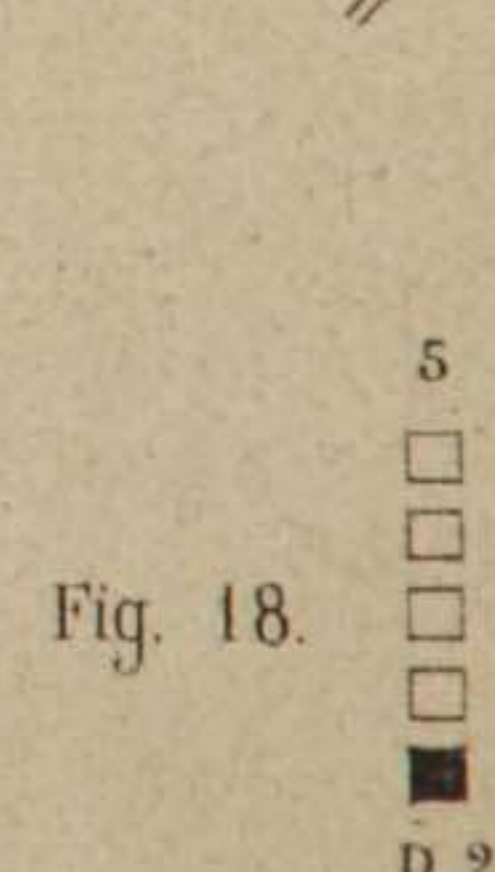


Fig. 18.

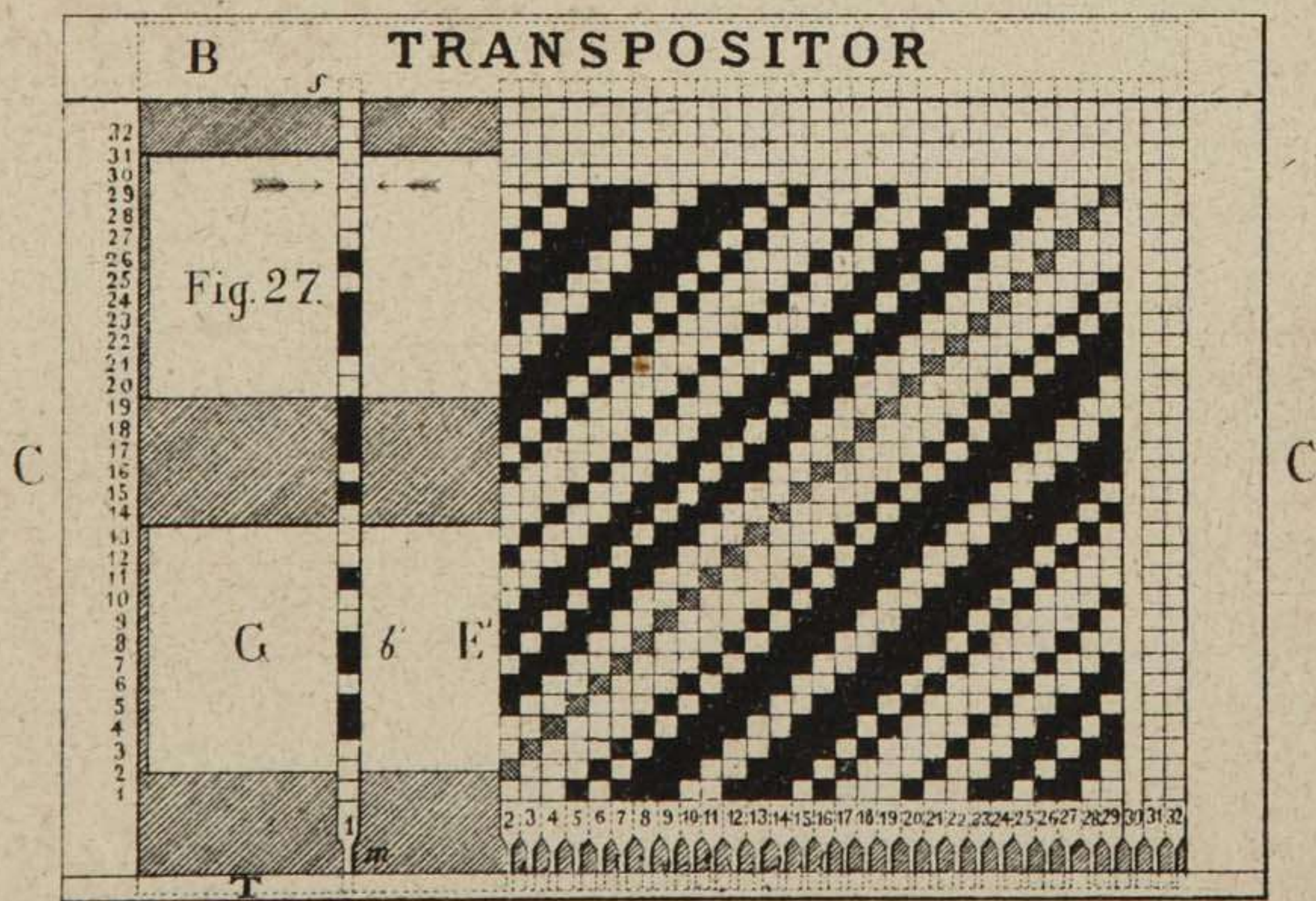
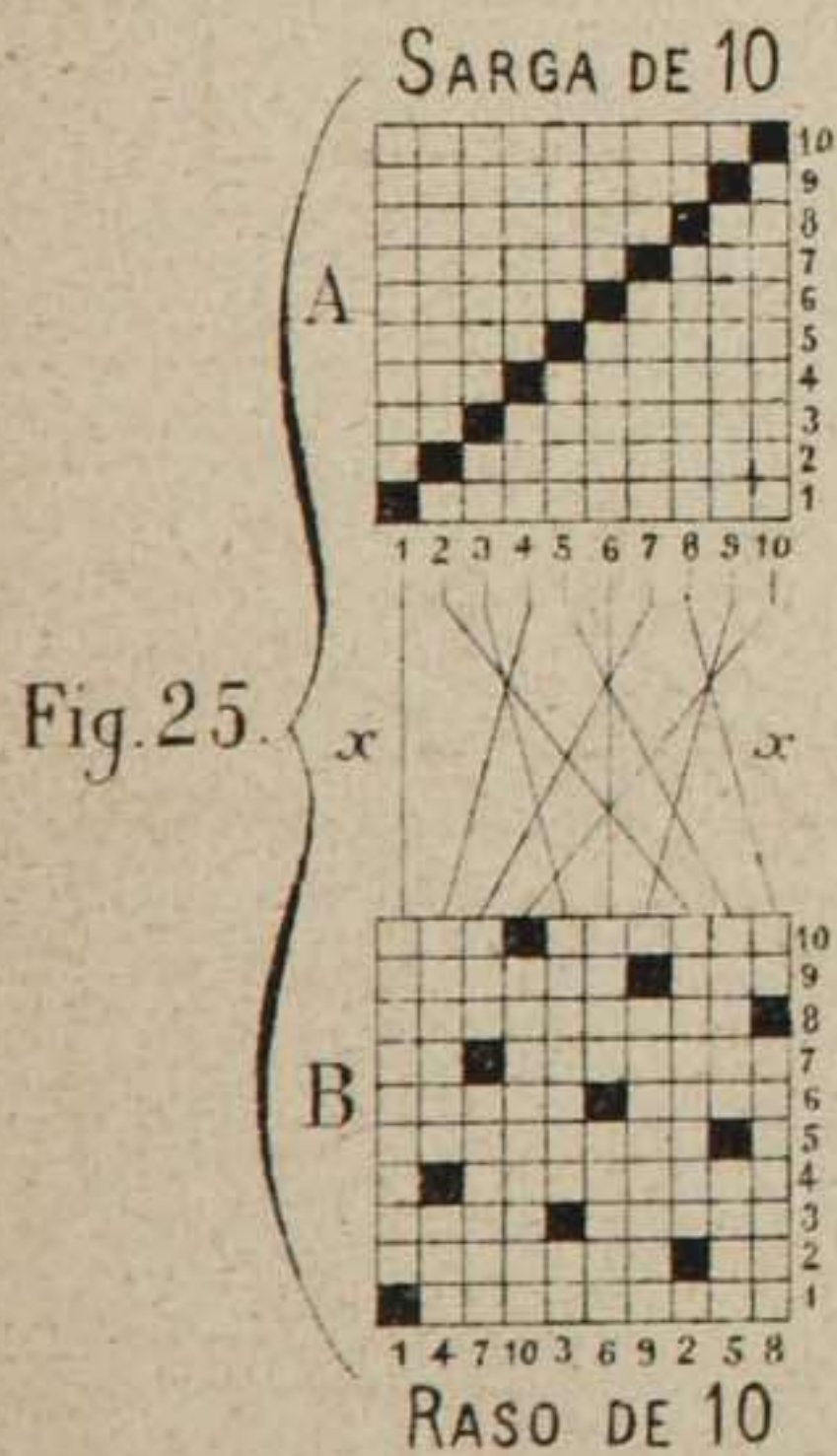
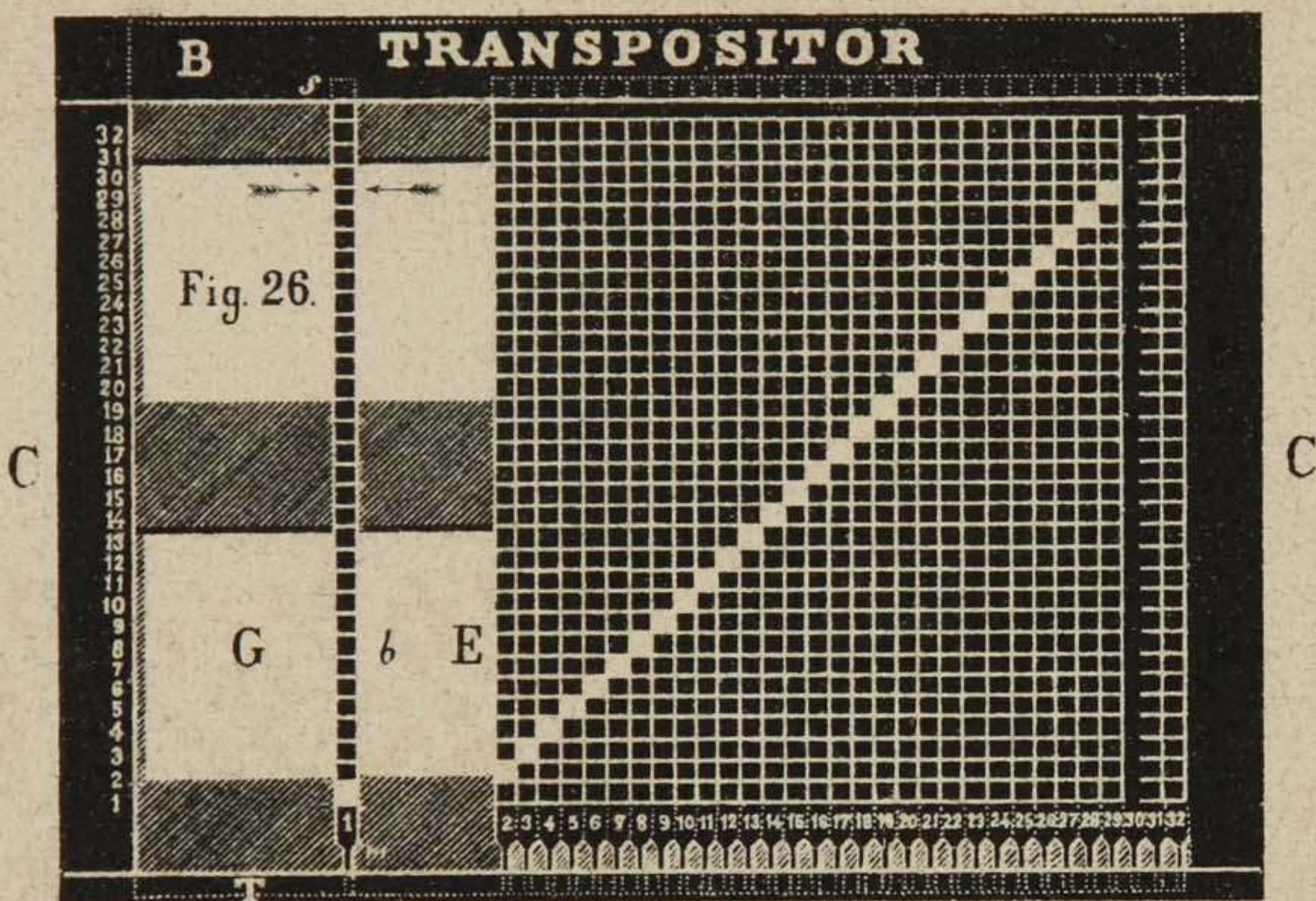
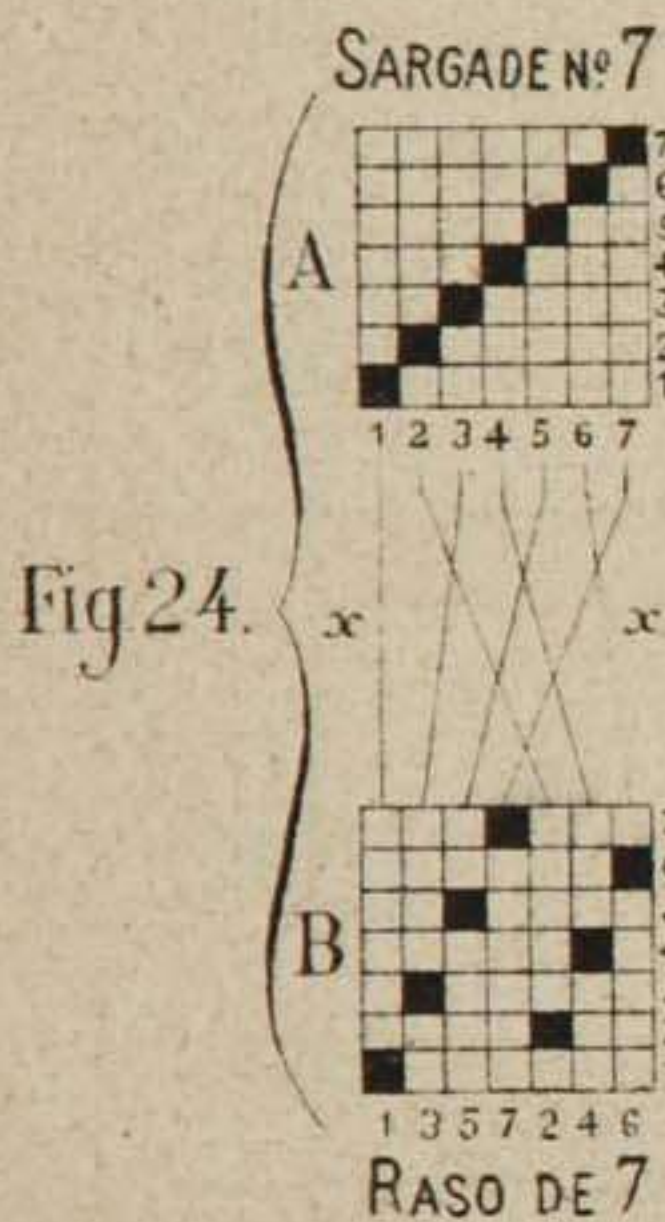
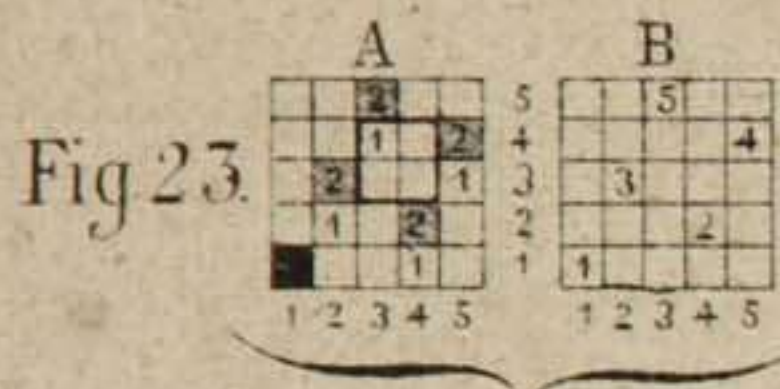
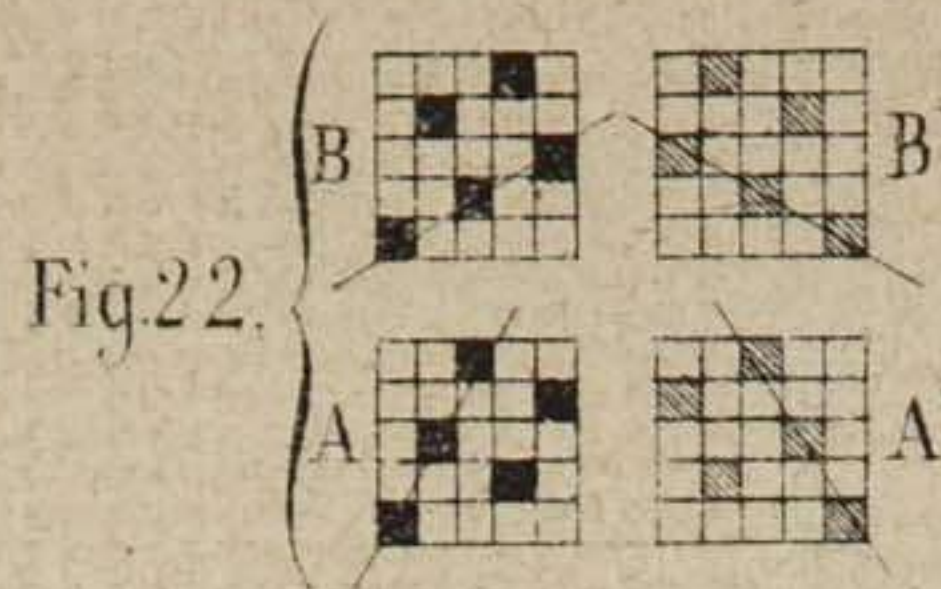
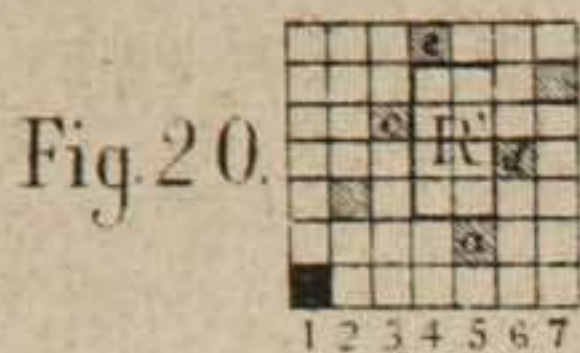
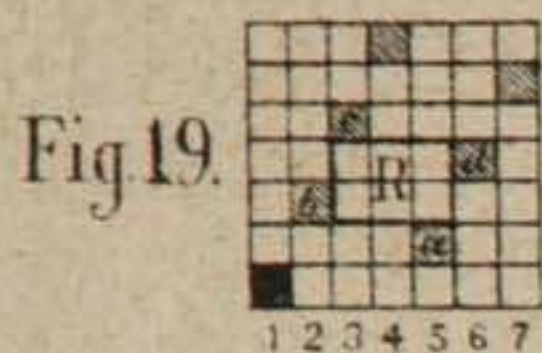
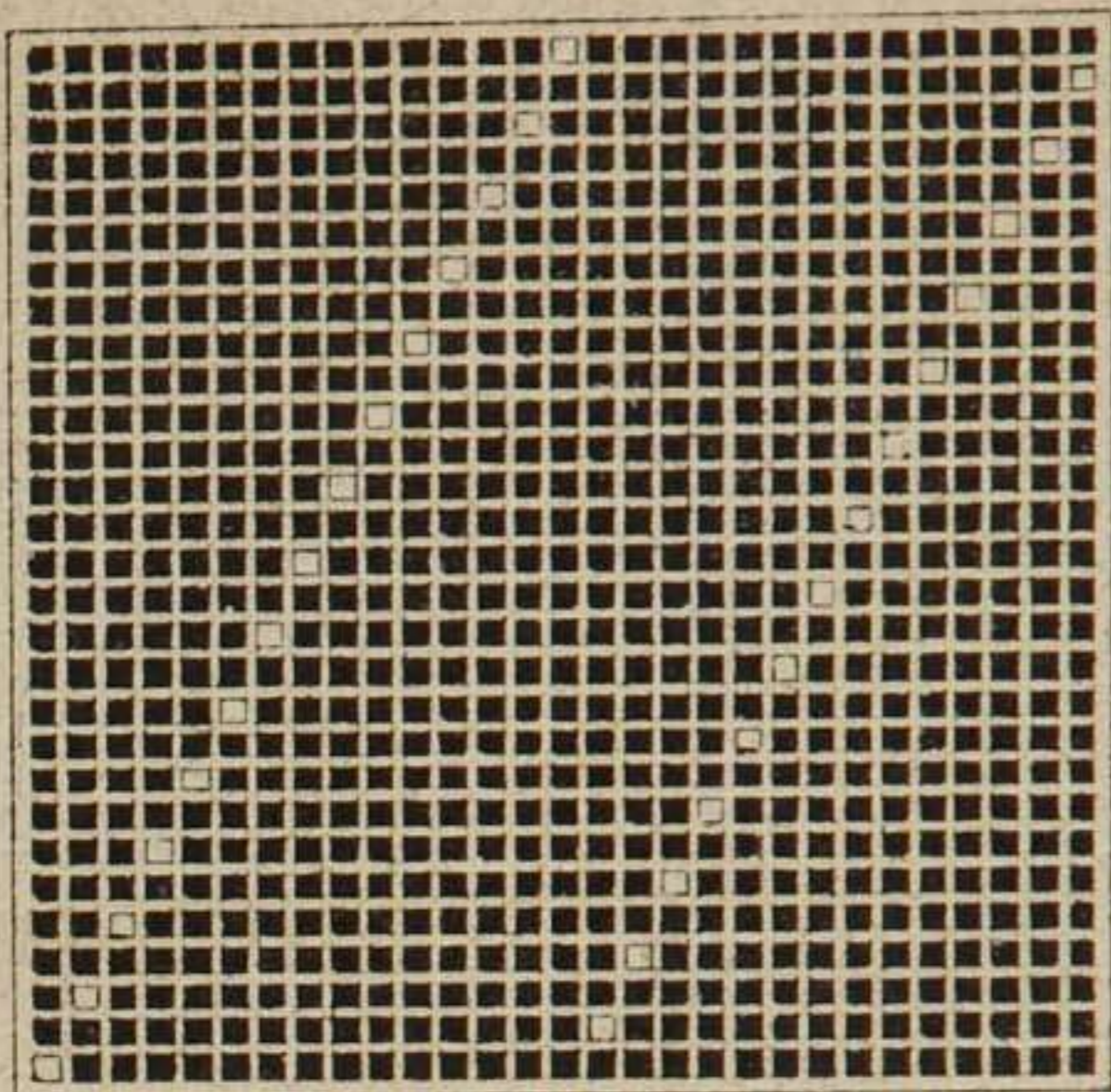
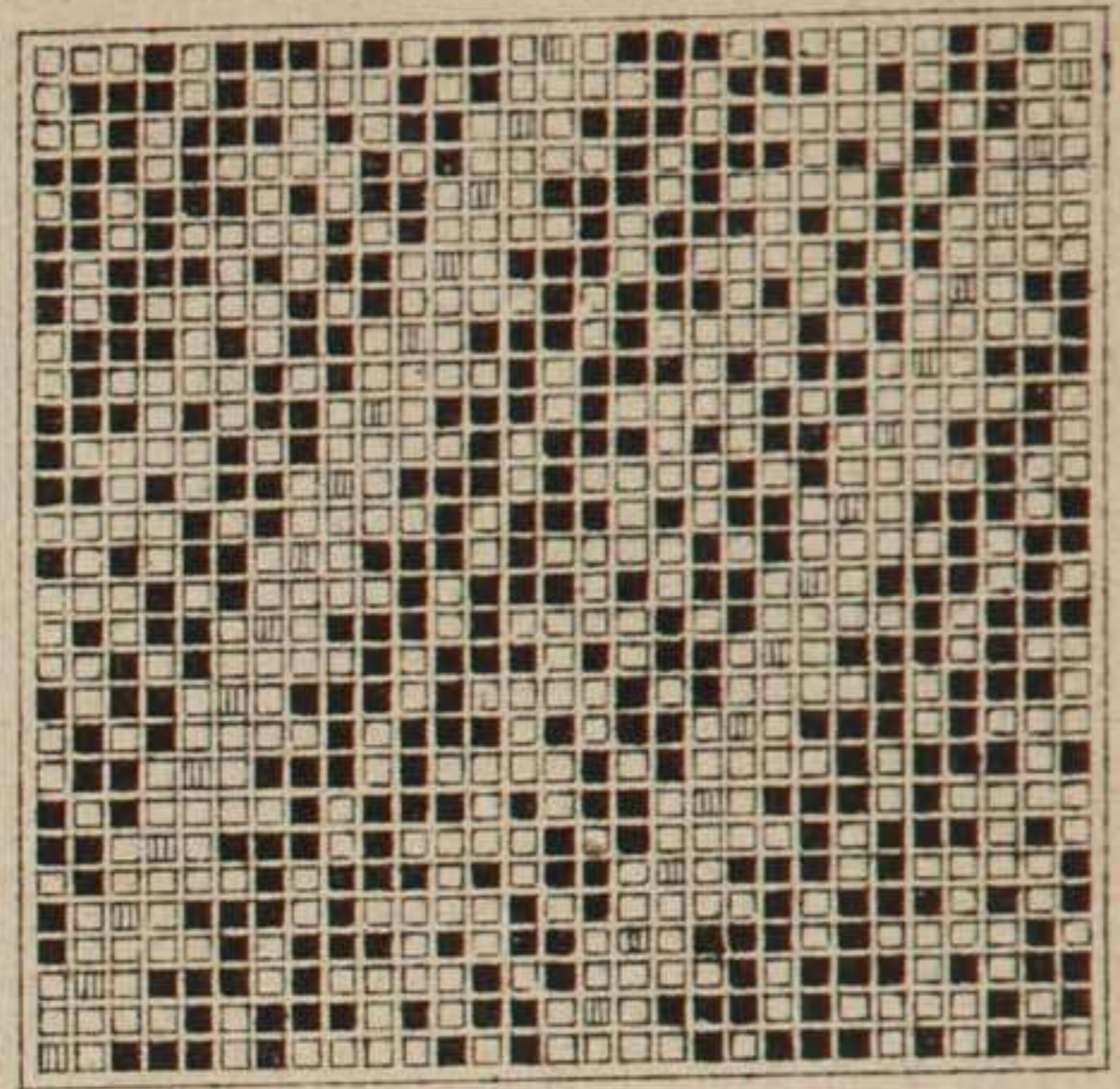


Fig. 30.



1 5 9 13 17 21 25 29 4 8 12 16 20 24 28
3 7 11 15 19 23 27 2 6 10 14 18 22 26

Fig. 31.



1 5 9 13 17 21 25 29 4 8 12 16 20 24 28
3 7 11 15 19 23 27 2 6 10 14 18 22 26

Fig. 28.

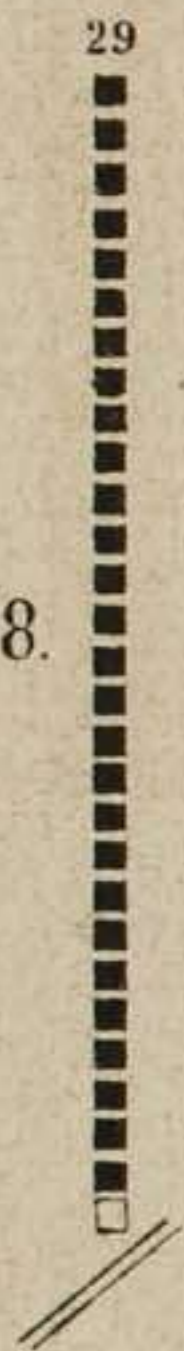


Fig. 29.

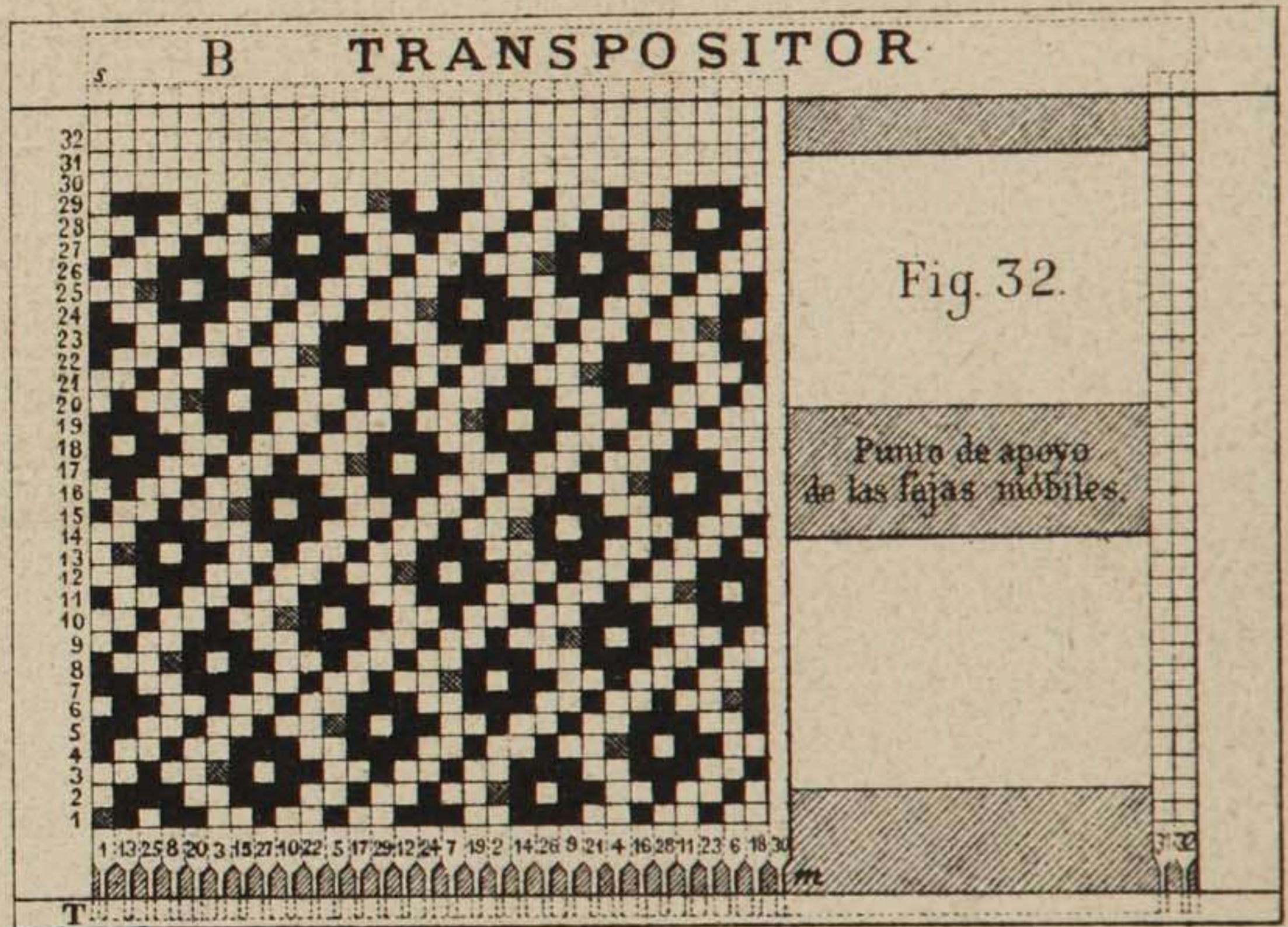
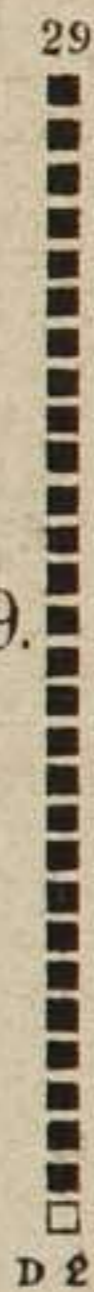


Fig. 32.

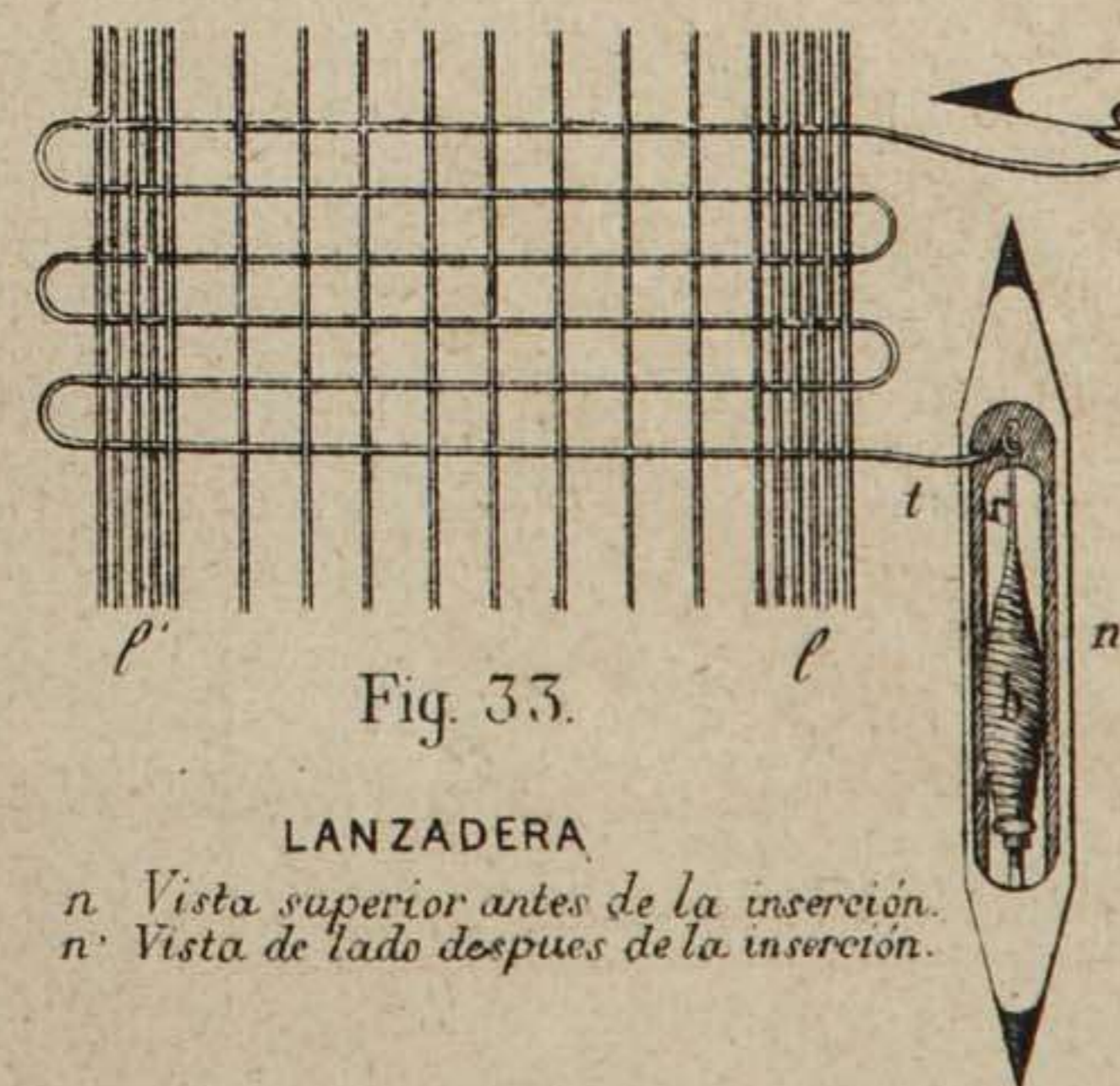


Fig. 33.

LANZADERA

n Vista superior antes de la inserción.
n' Vista de lado despues de la inserción.



Fig. 34.

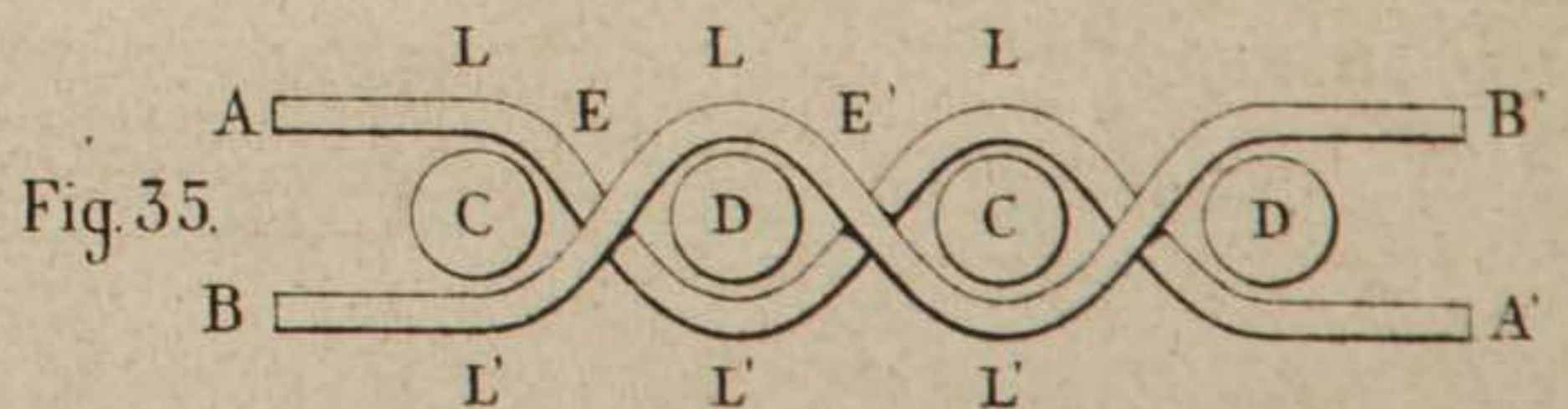


Fig. 35.

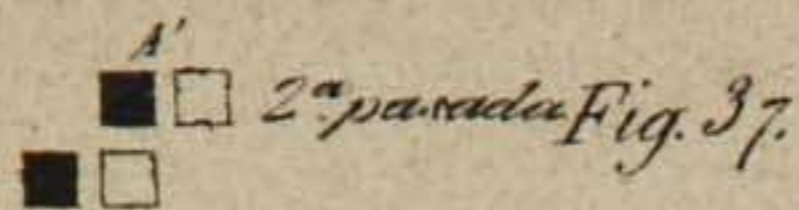
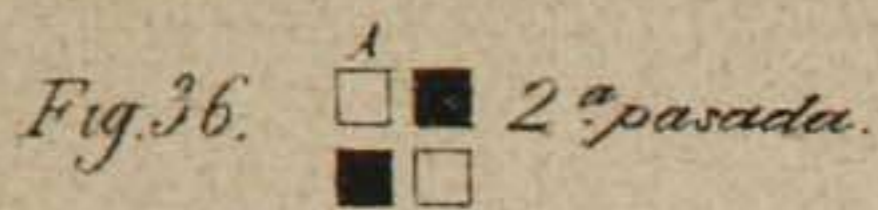


Fig. 38.



Fig. 39.

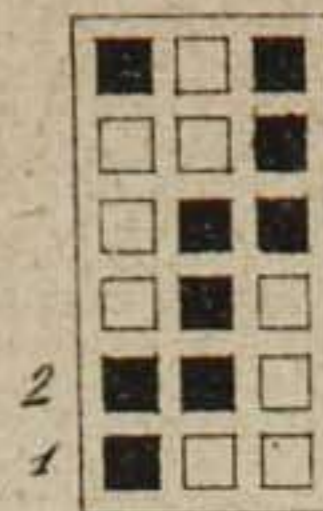


Fig. 40.

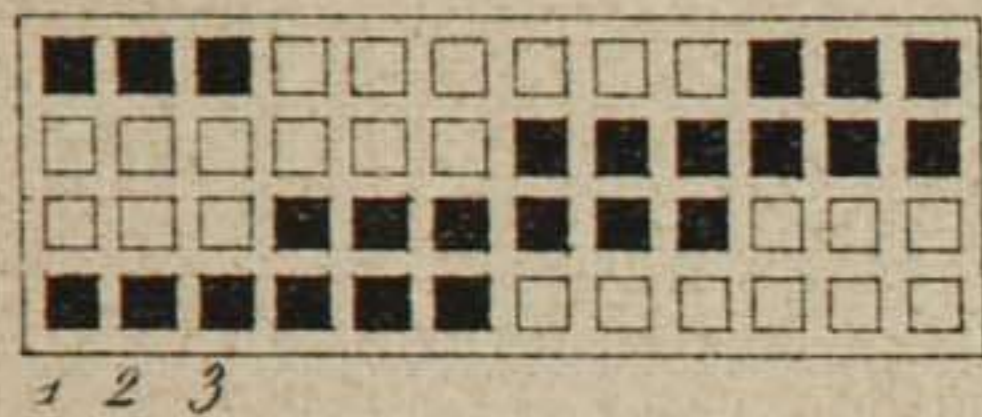


Fig. 41.

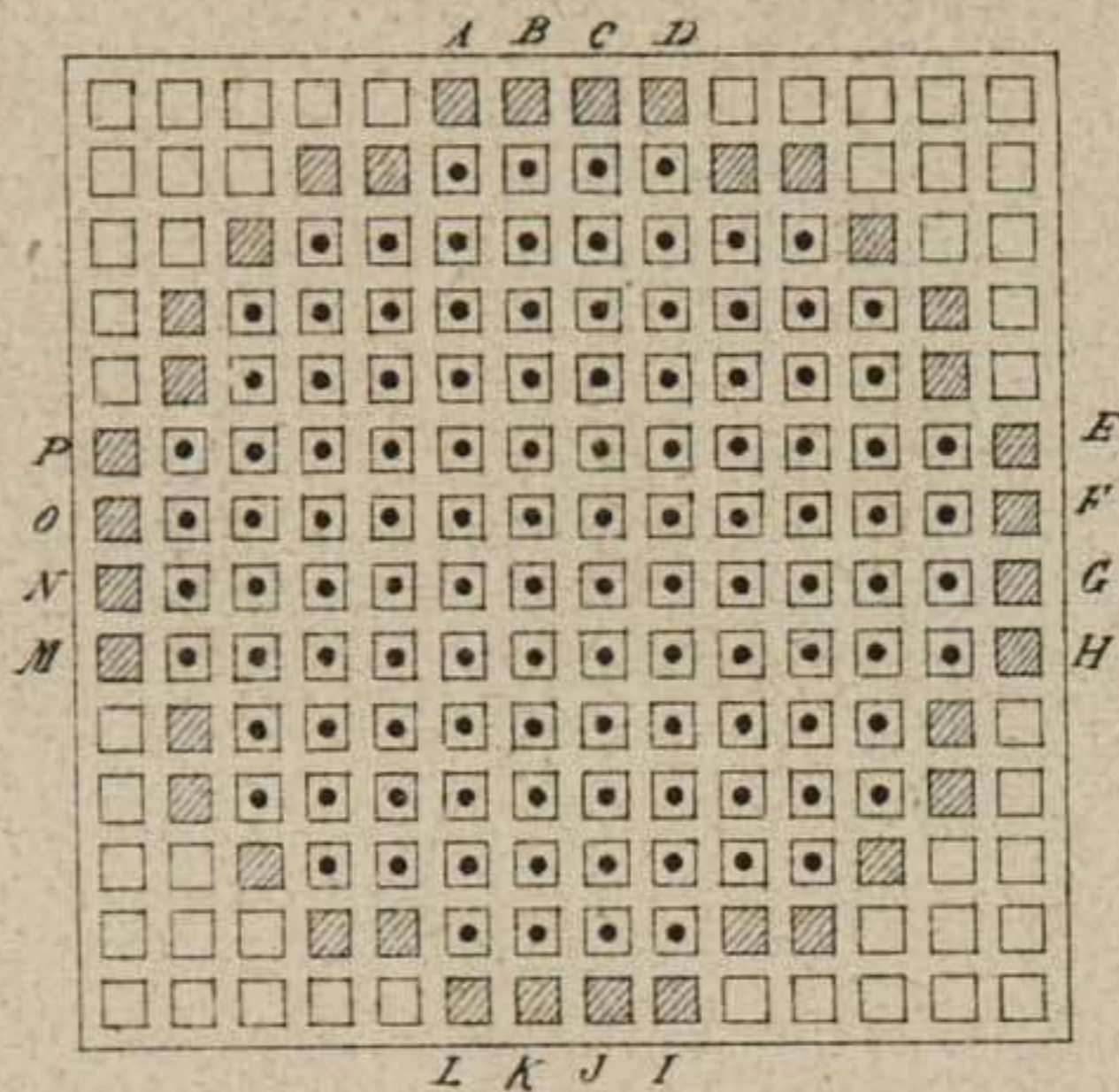


Fig. 42.

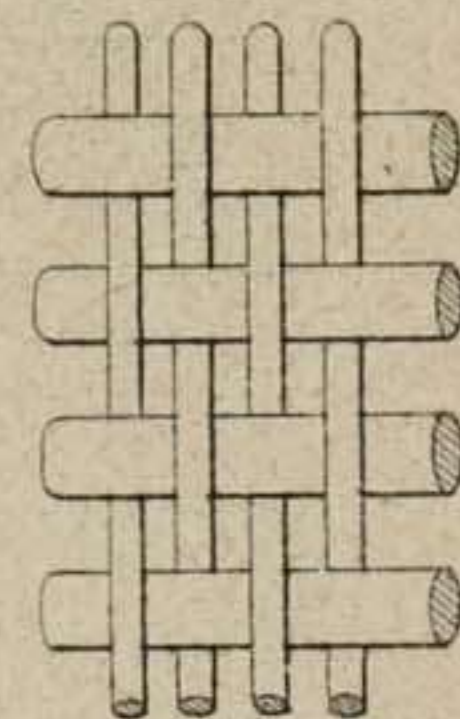


Fig. 43.

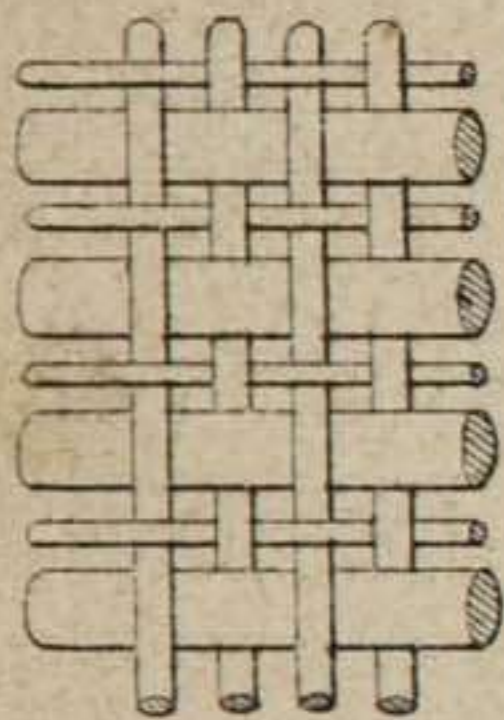


Fig. 44.

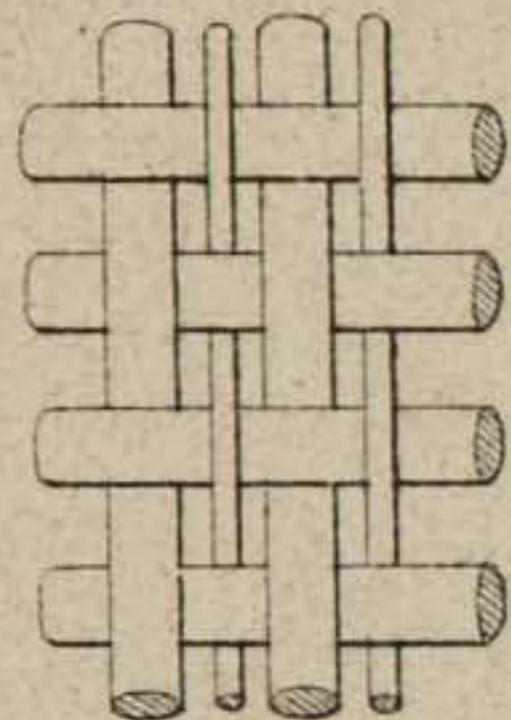


Fig. 46.

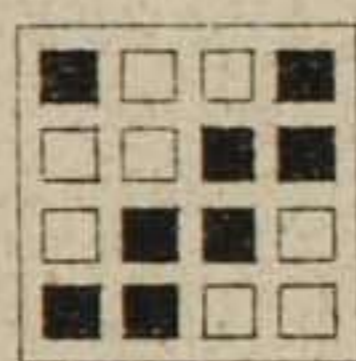


Fig. 47.

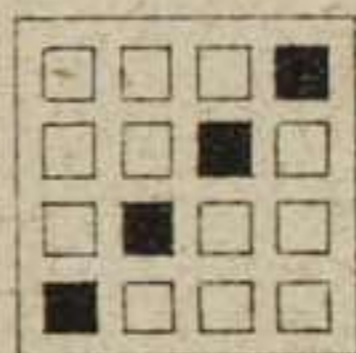


Fig. 51.

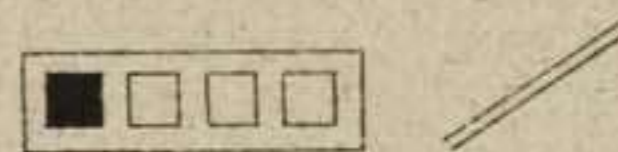


Fig. 45.

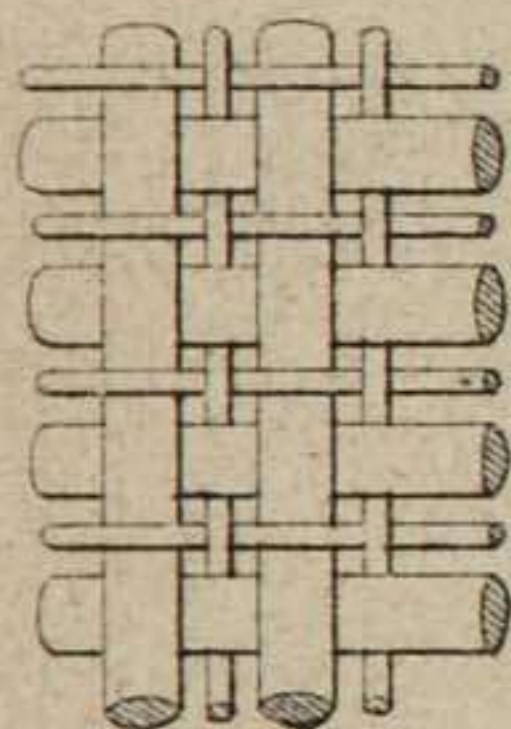


Fig. 48.

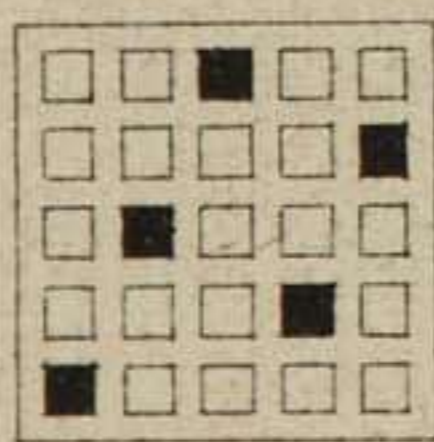


Fig. 49.

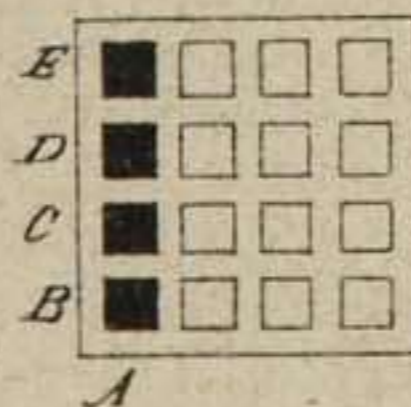


Fig. 50.

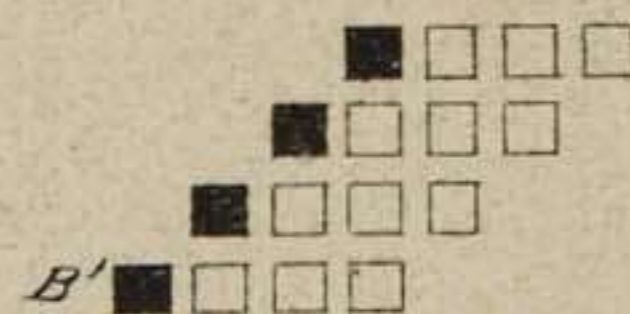
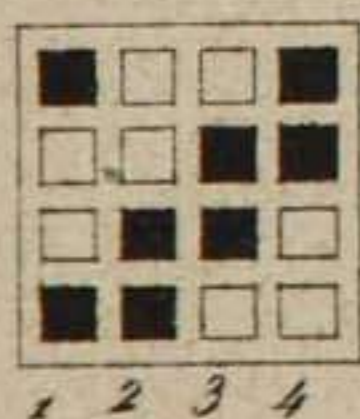


Fig. 52.



BATAVIA.

Fig. 53.

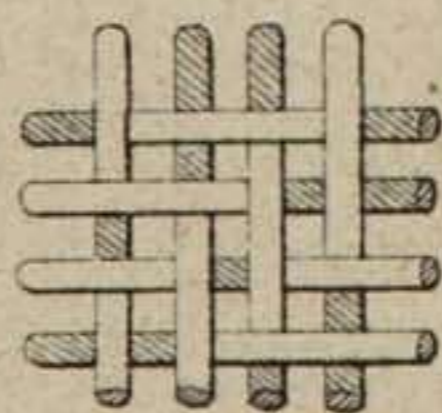


Fig. 54.

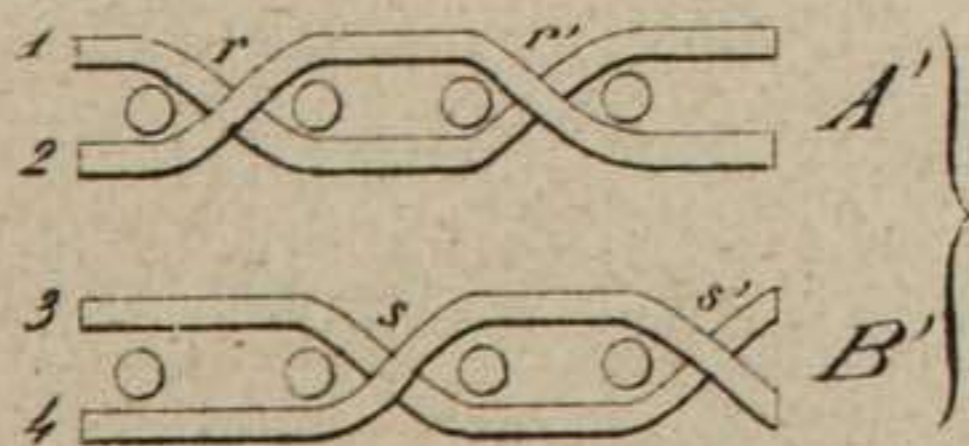
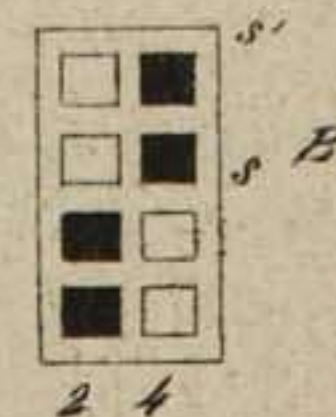


Fig. 55.

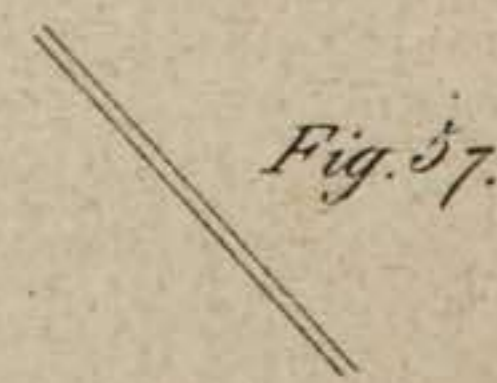
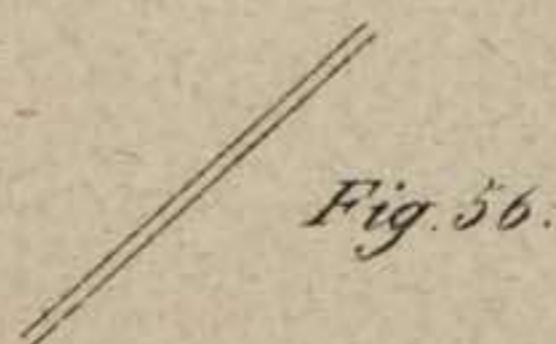
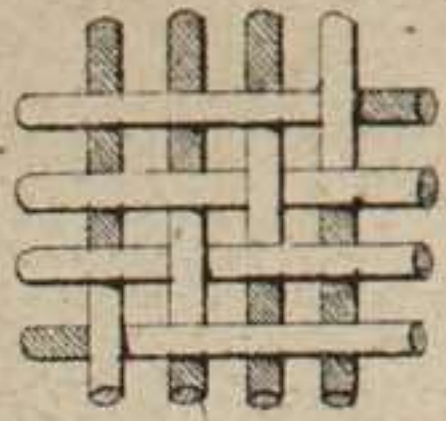


Fig. 58.



SARGA de 3 al 4.

Fig. 59.

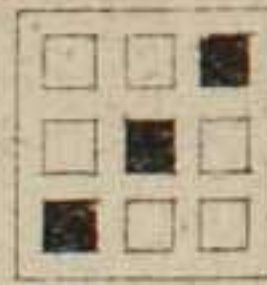


Fig. 60.

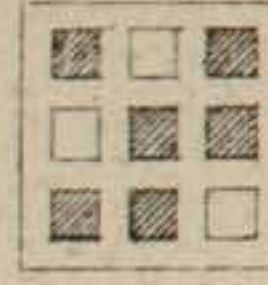


Fig. 61.

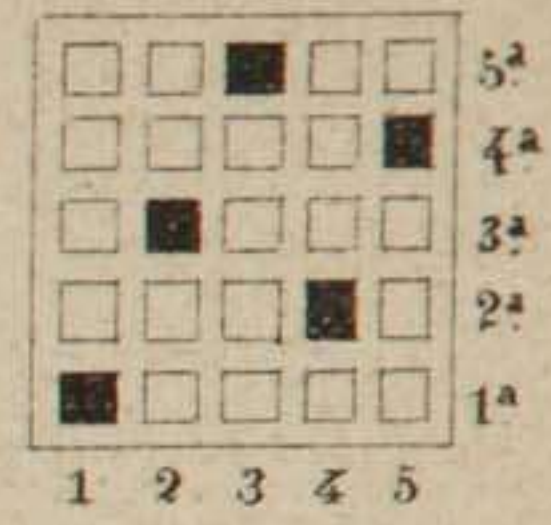


Fig. 62.

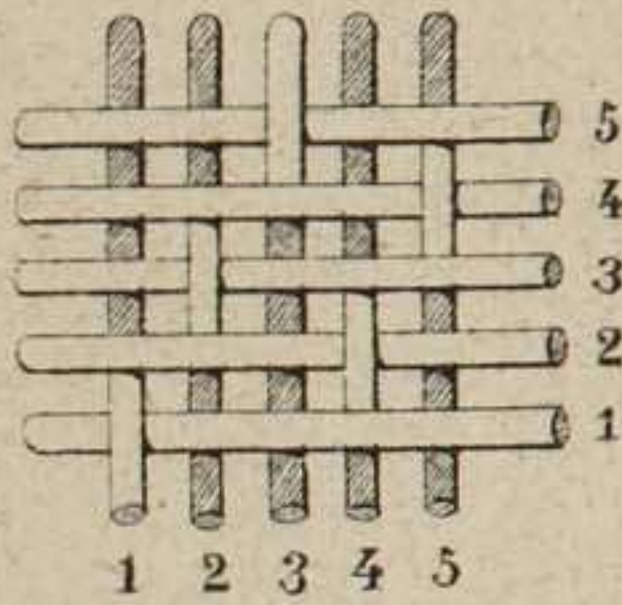


Fig. 63.

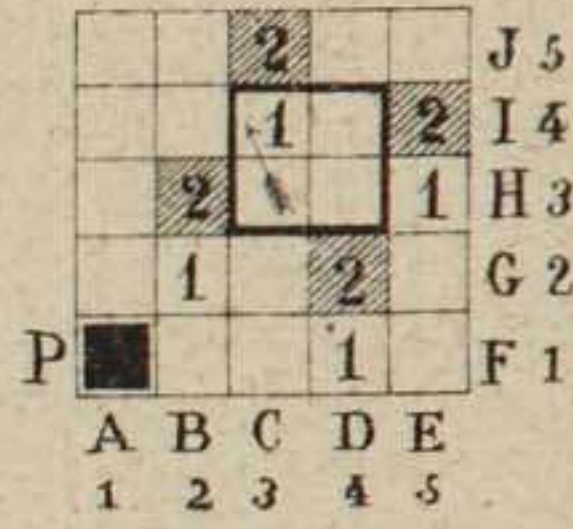


Fig. 64.

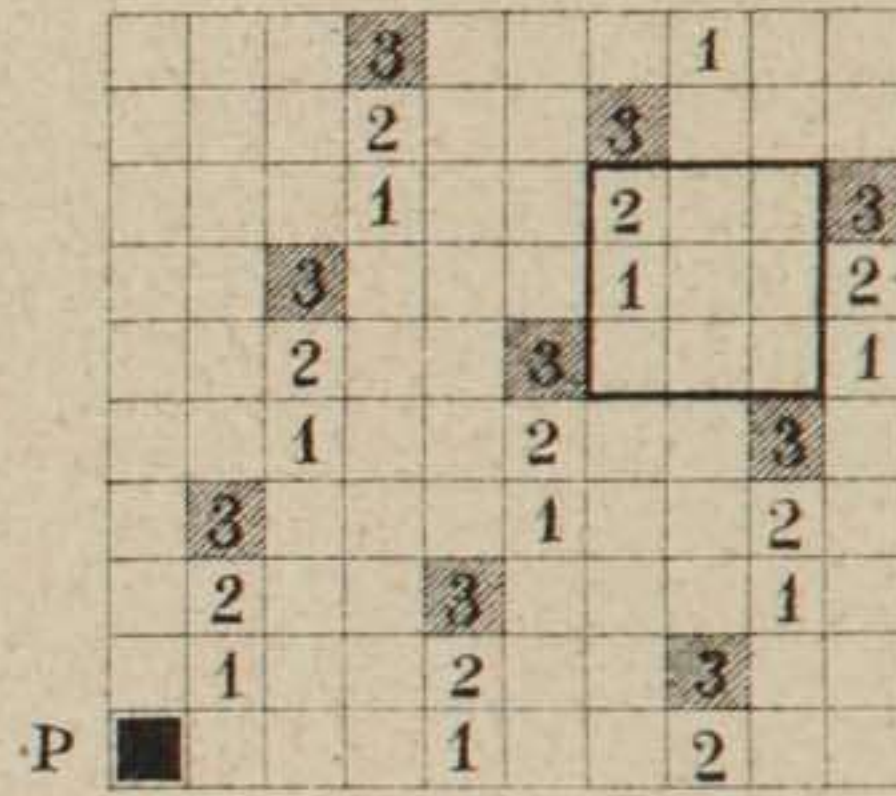


Fig. 65.

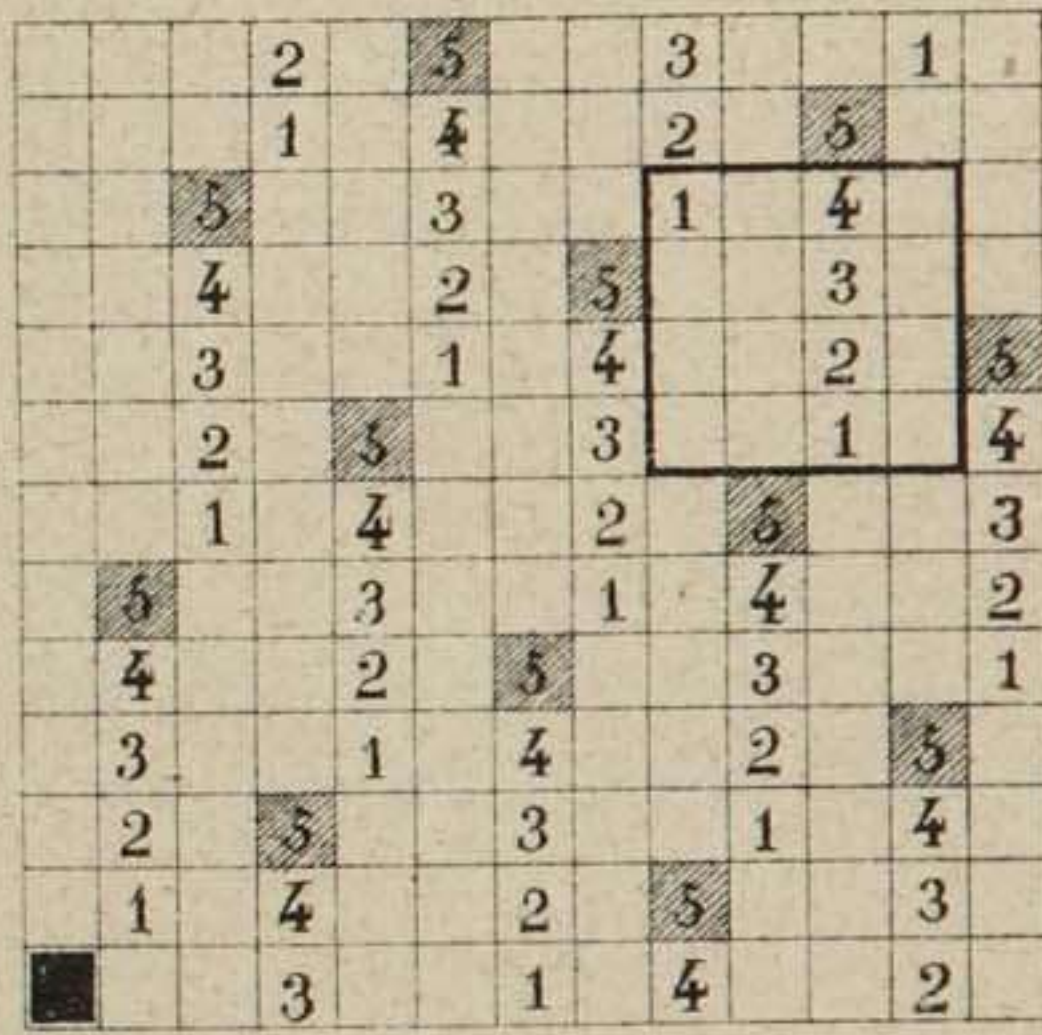


Fig. 66.

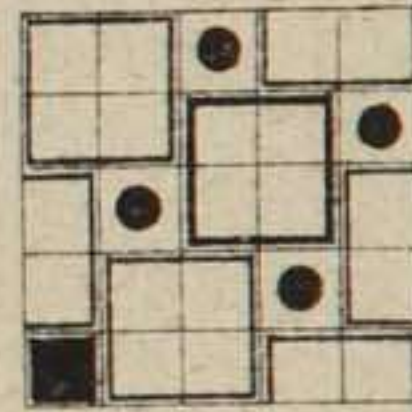


Fig. 67.

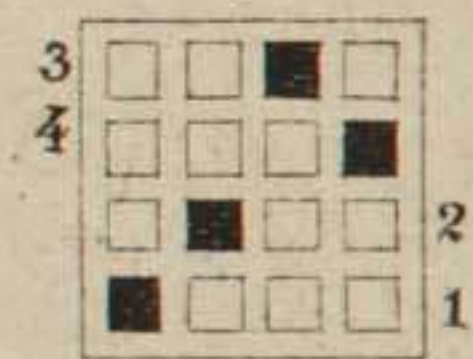


Fig. 68.

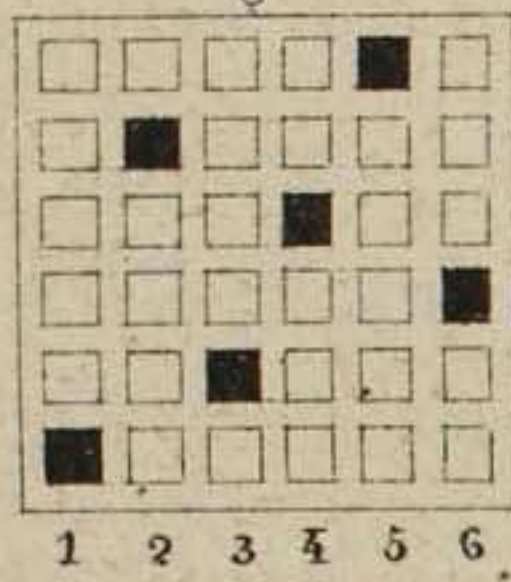


Fig. 69.

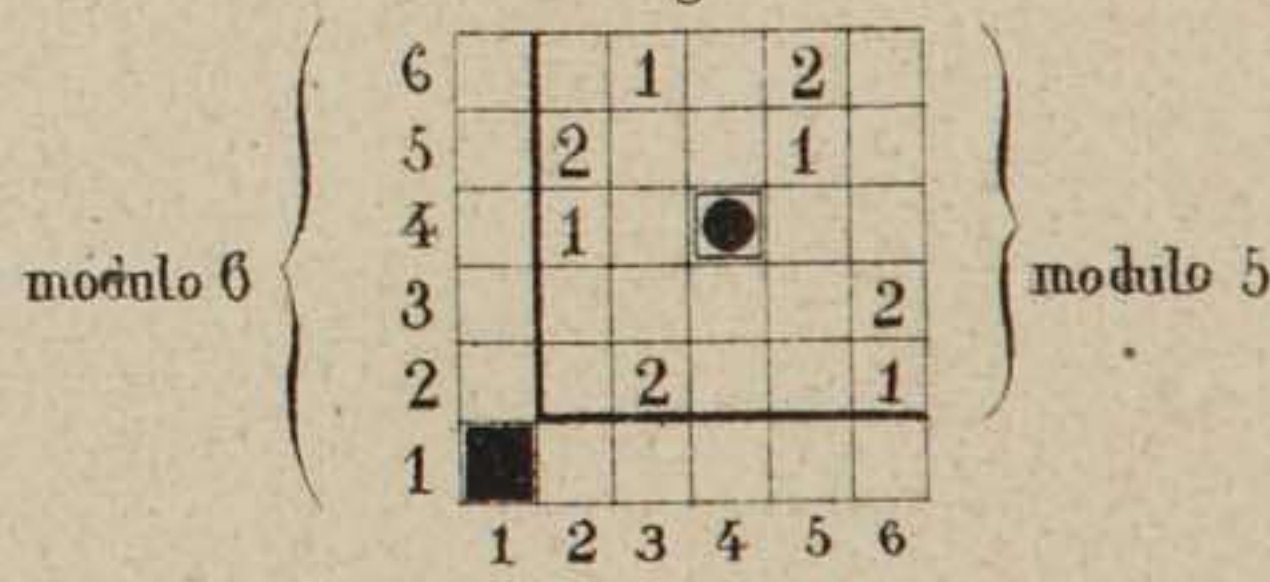


Fig. 71.

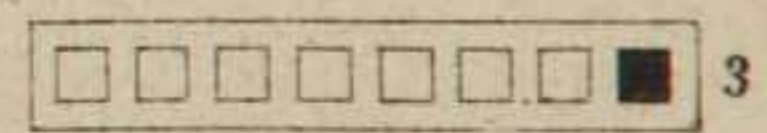


Fig. 72.

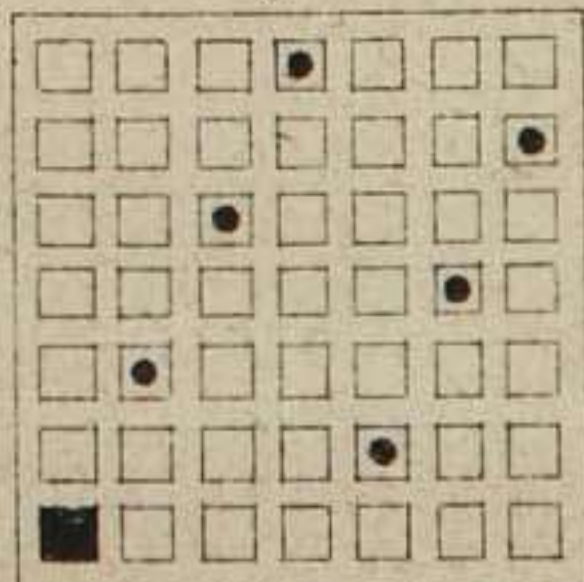


Fig. 73.

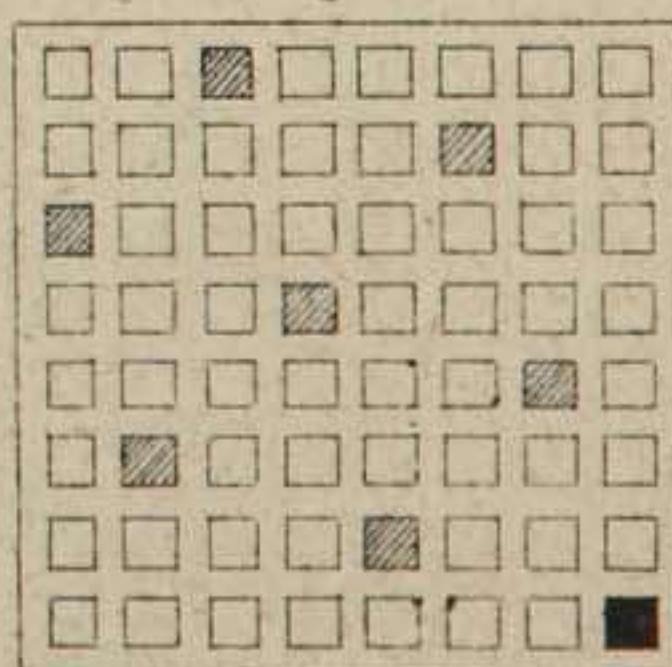
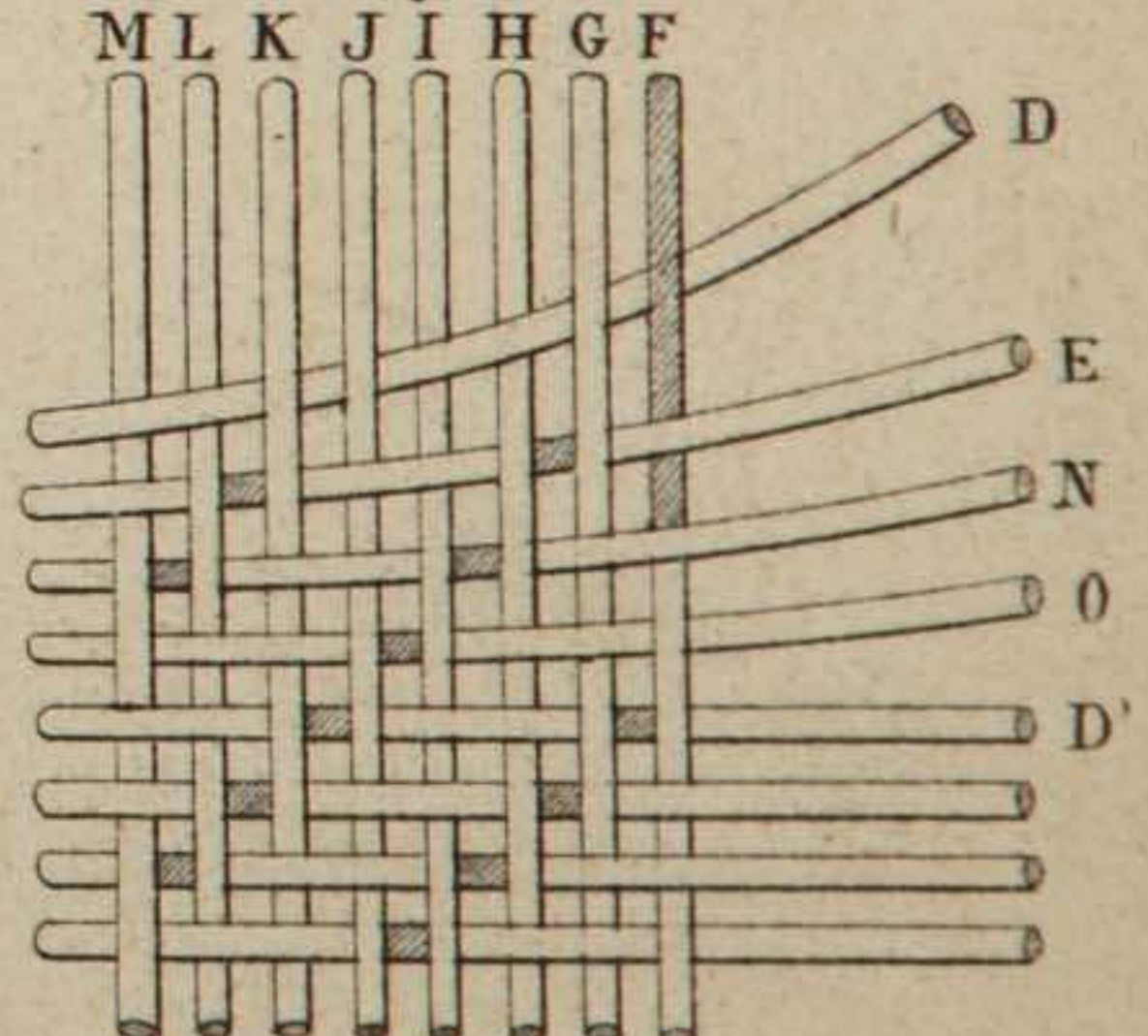


Fig. 74.



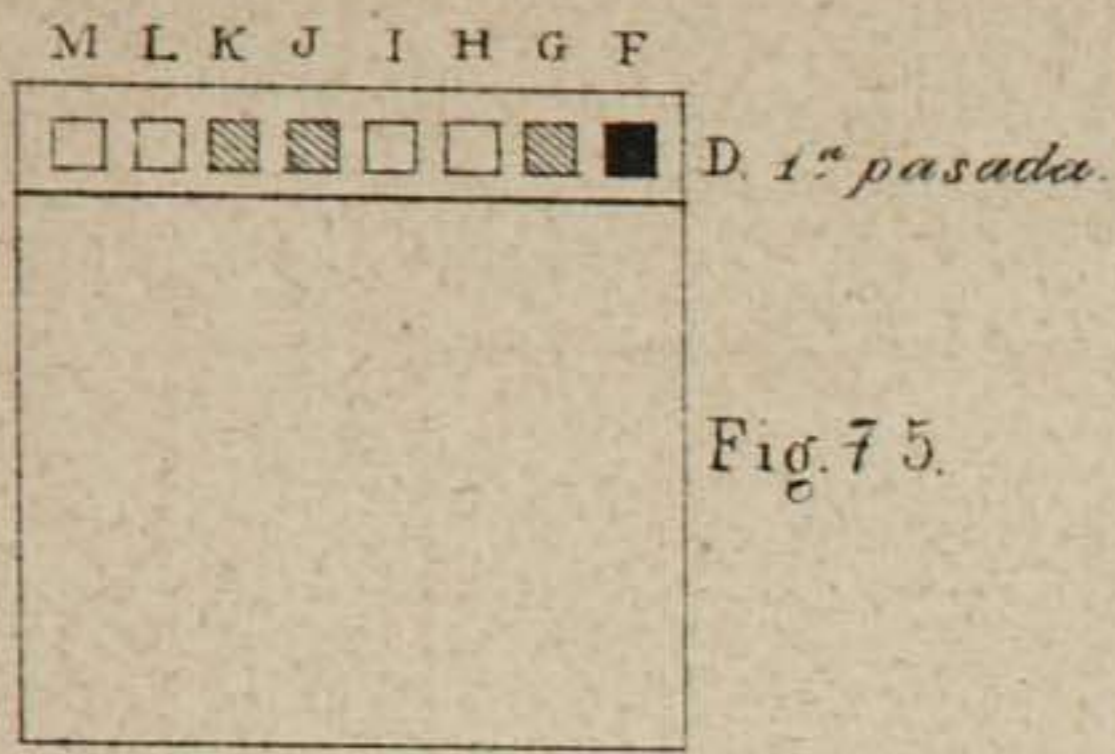


Fig. 75.

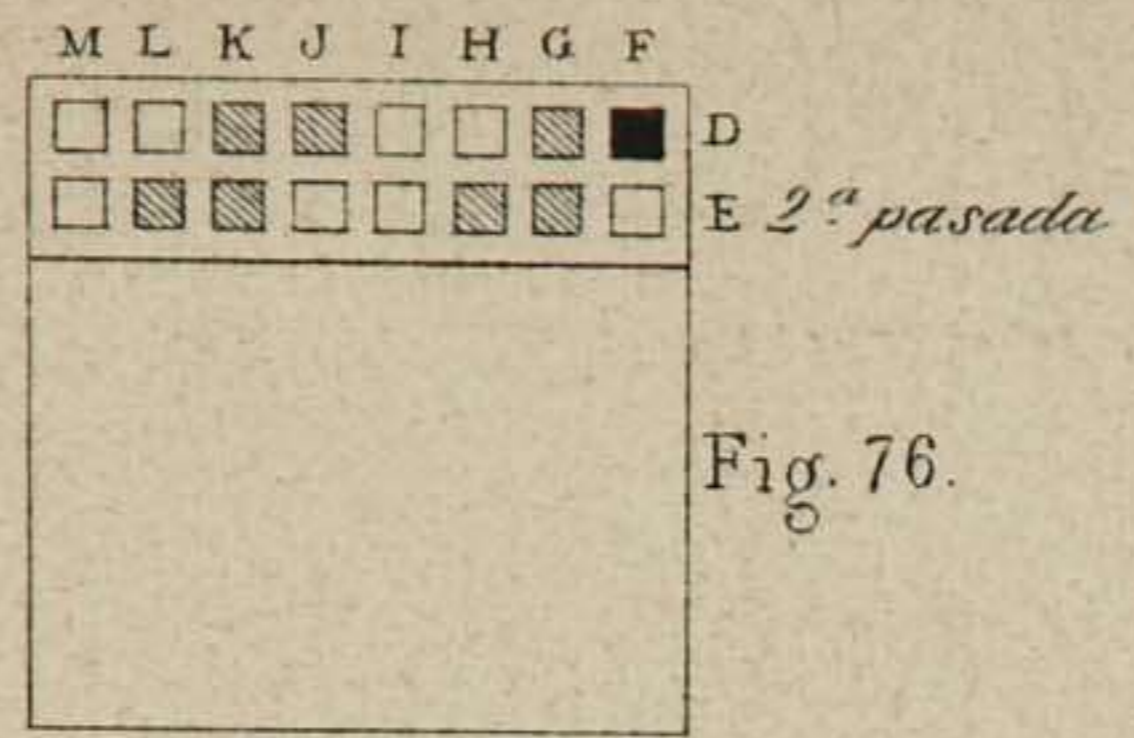


Fig. 76.

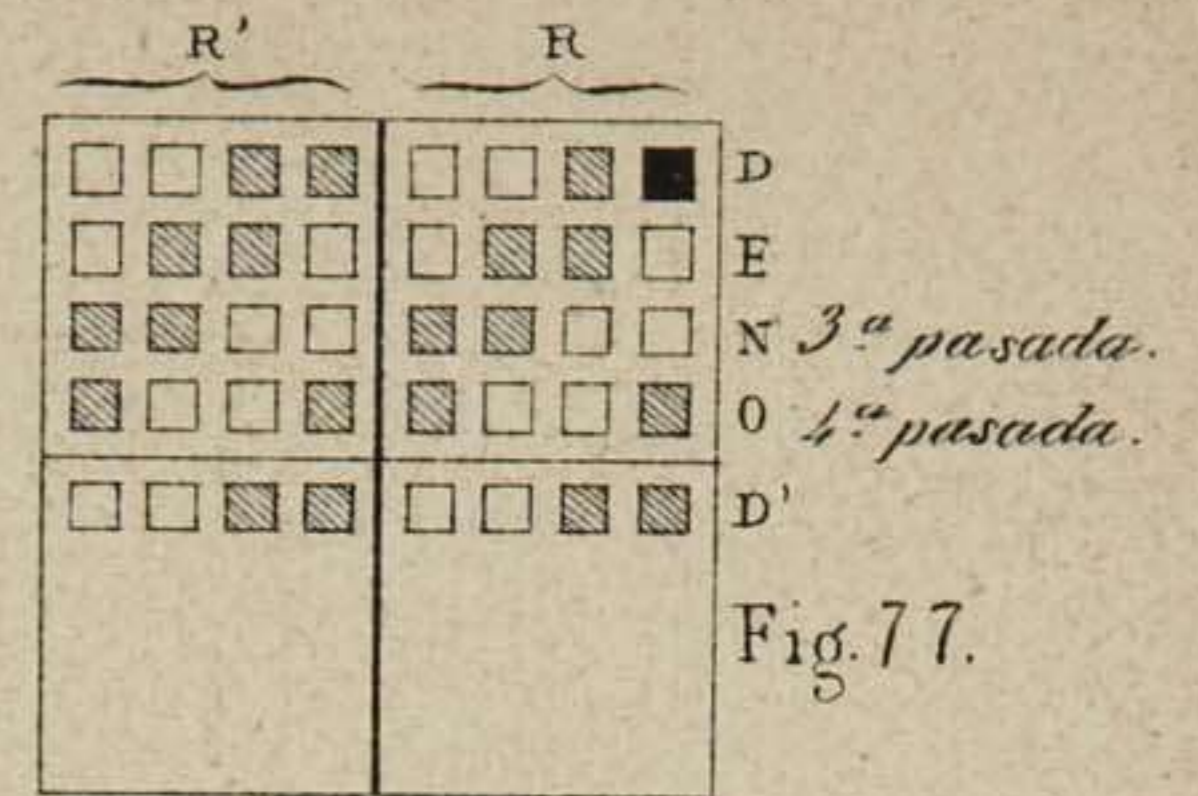
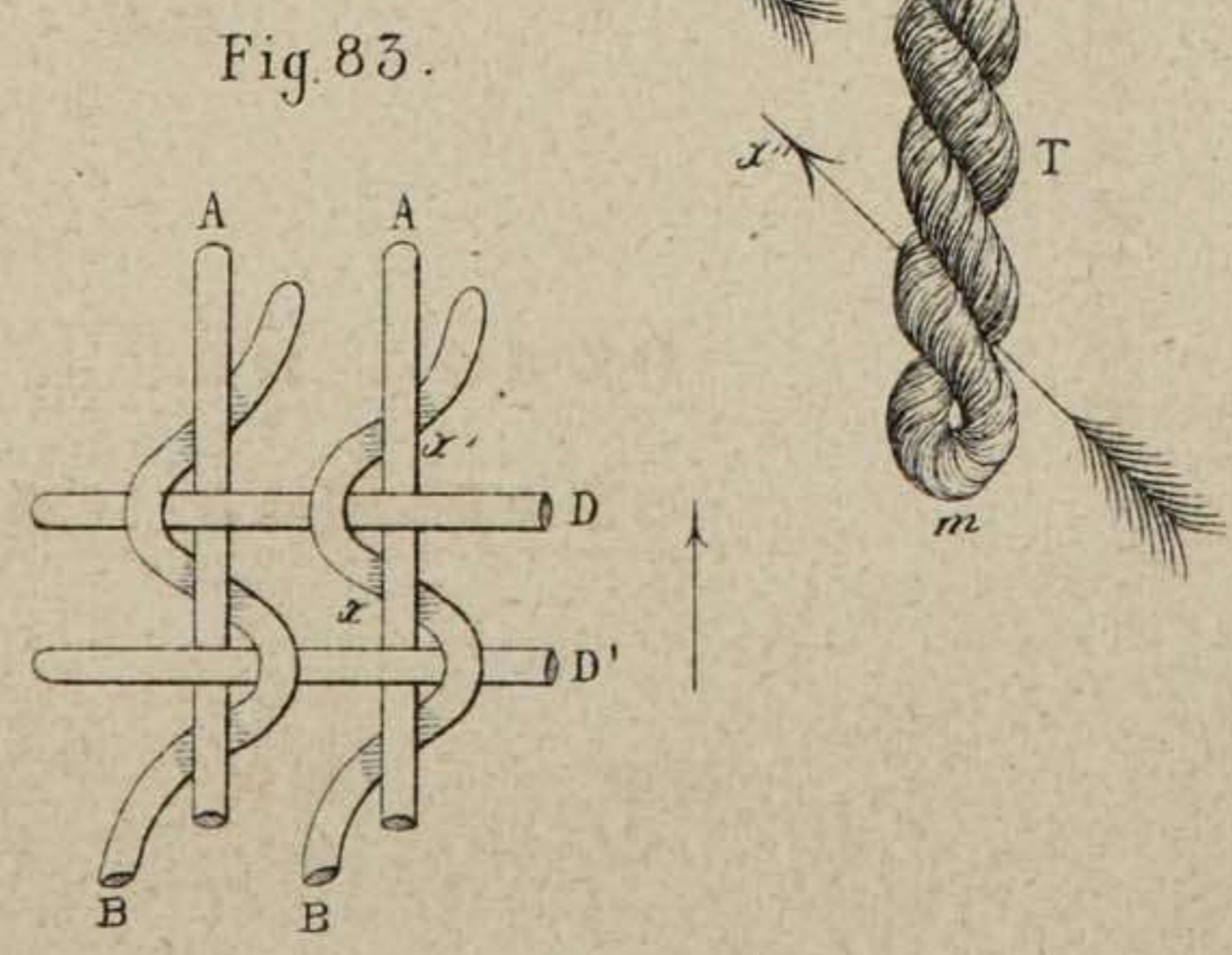
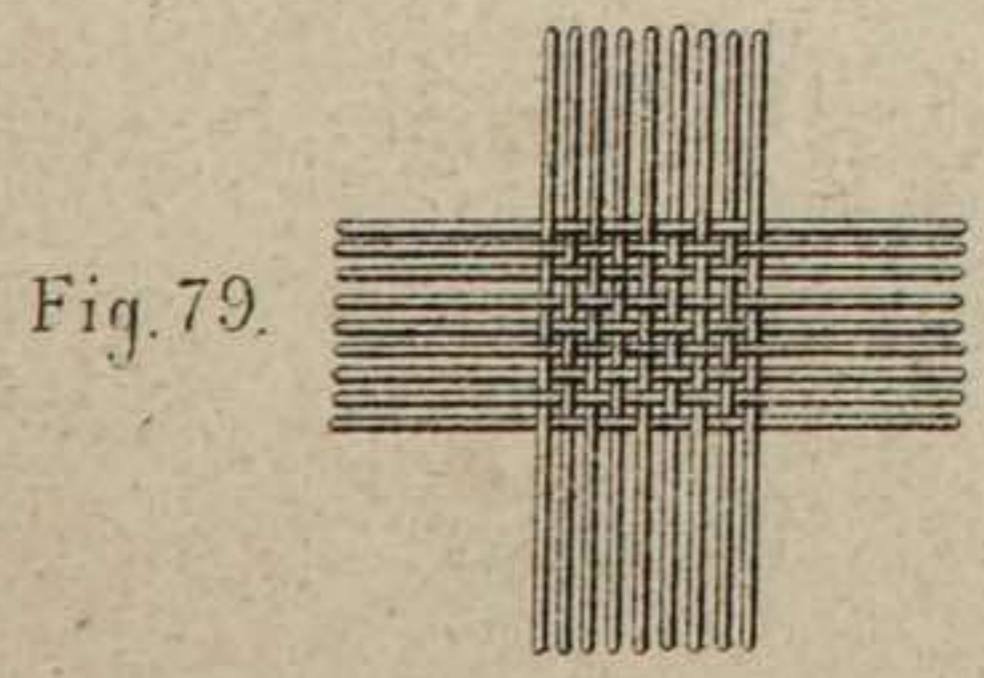
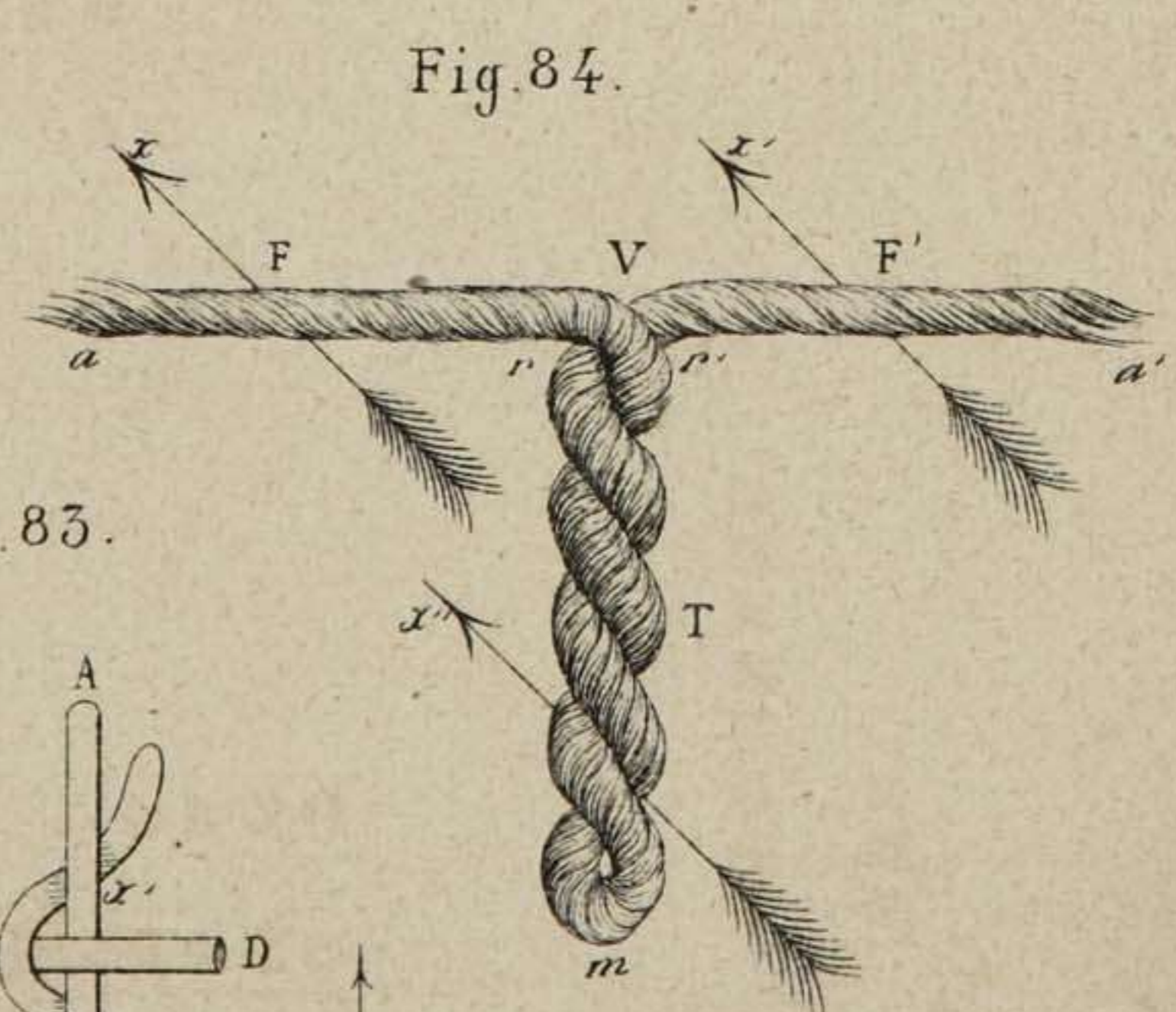
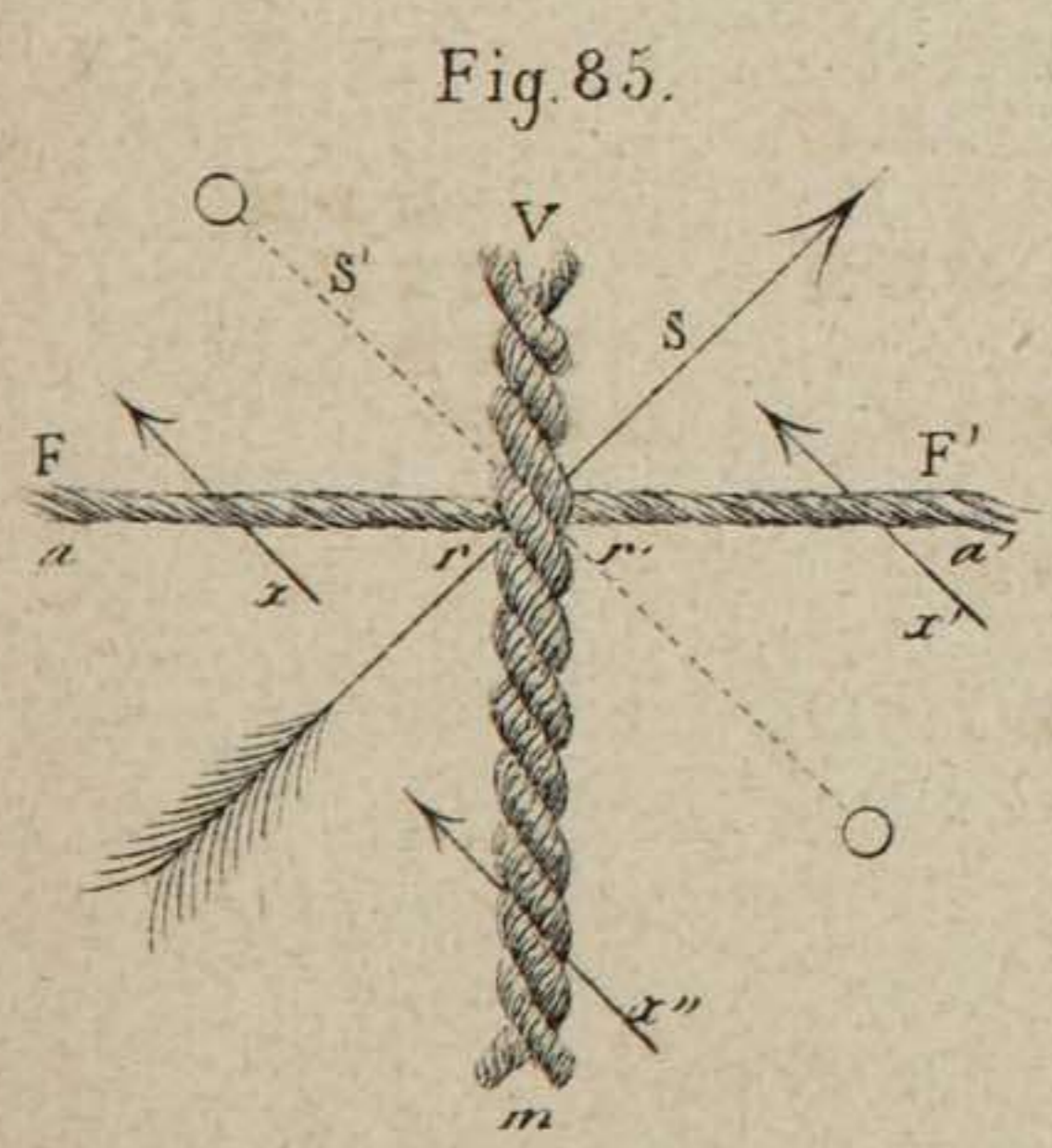
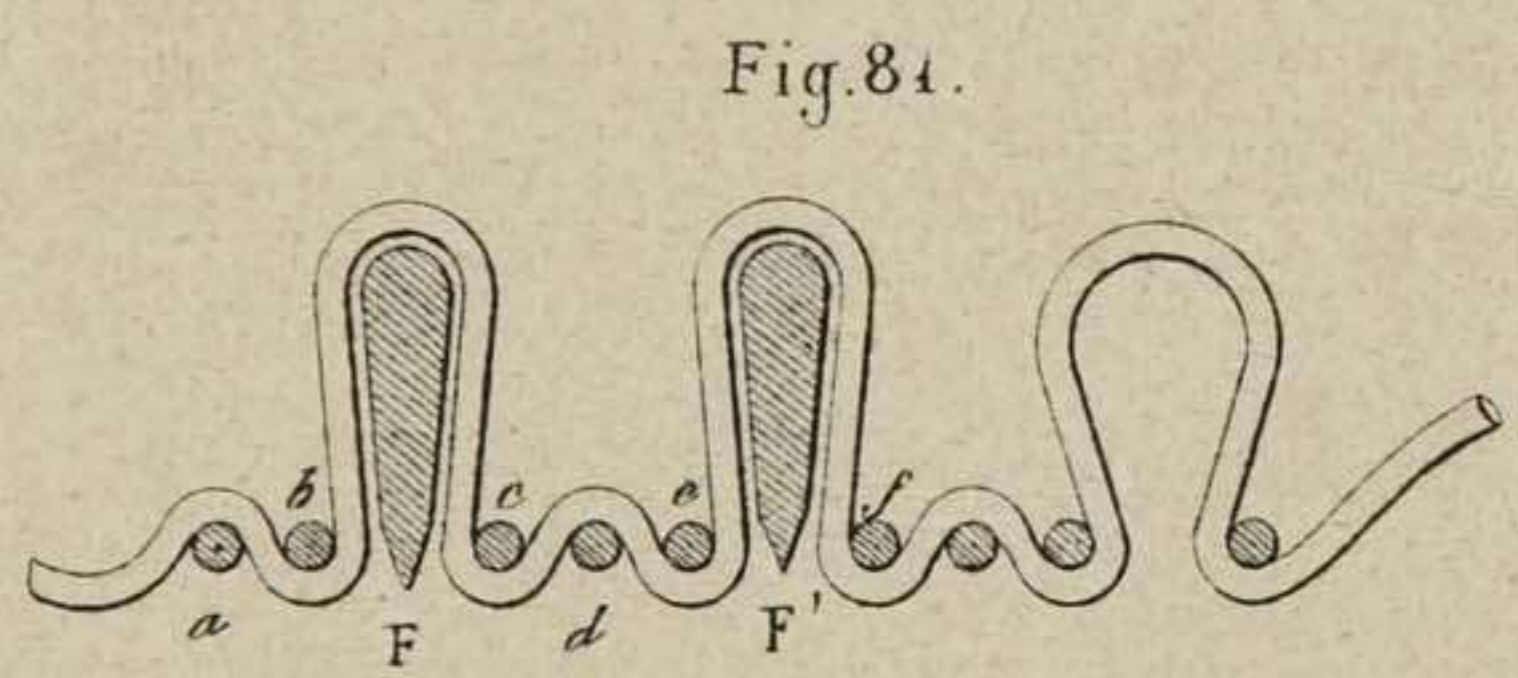
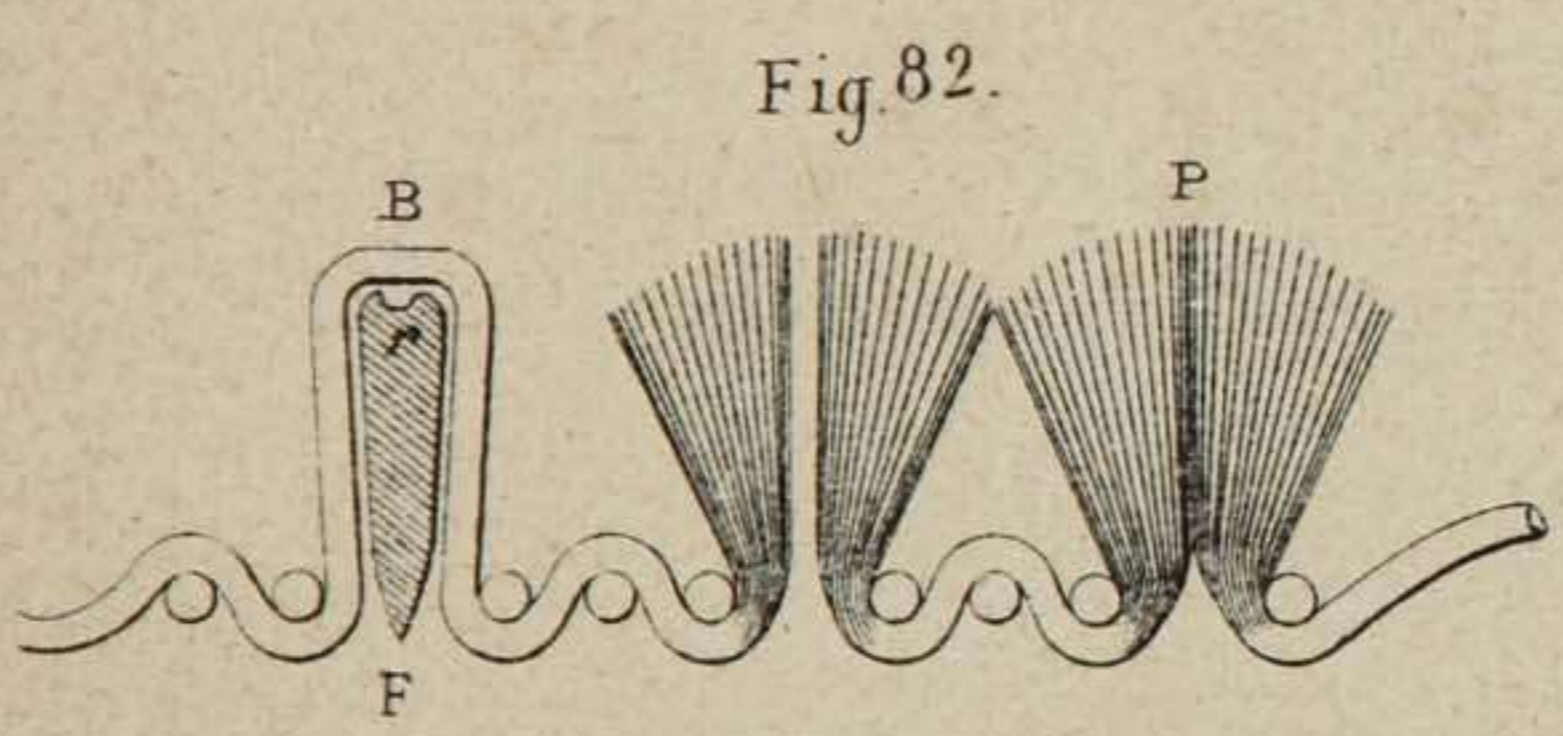
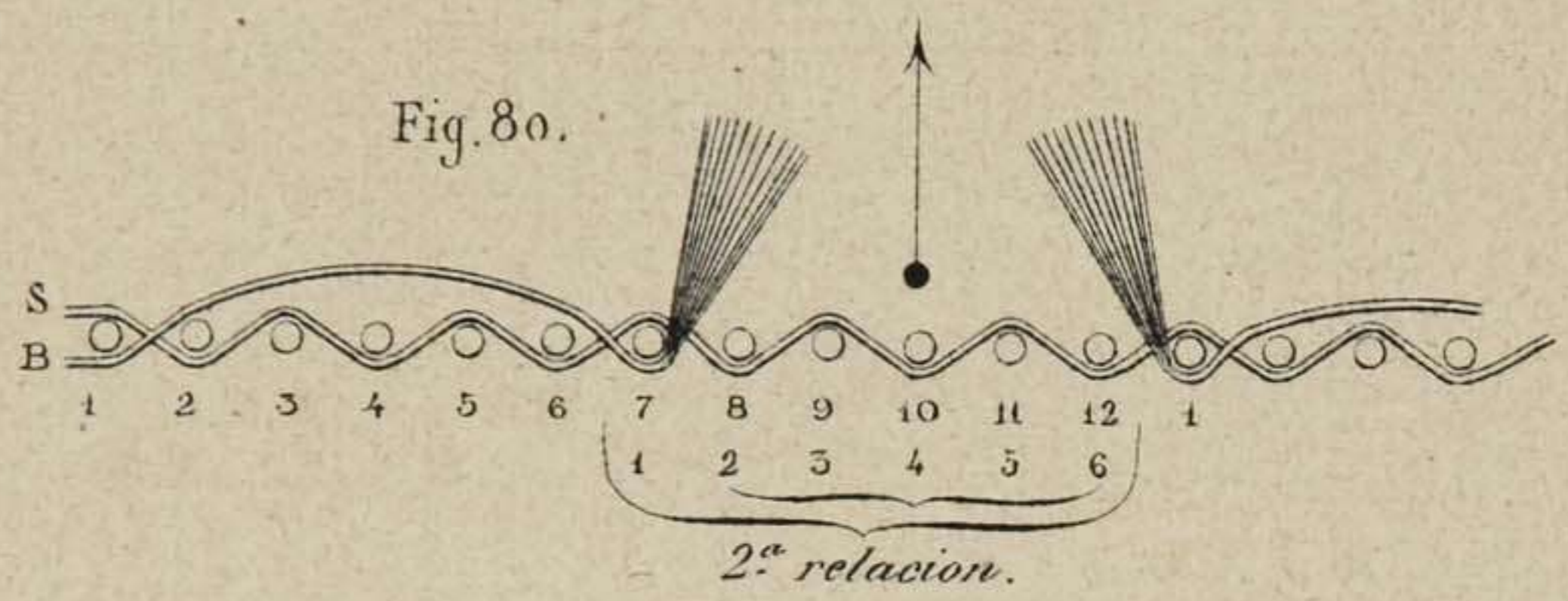
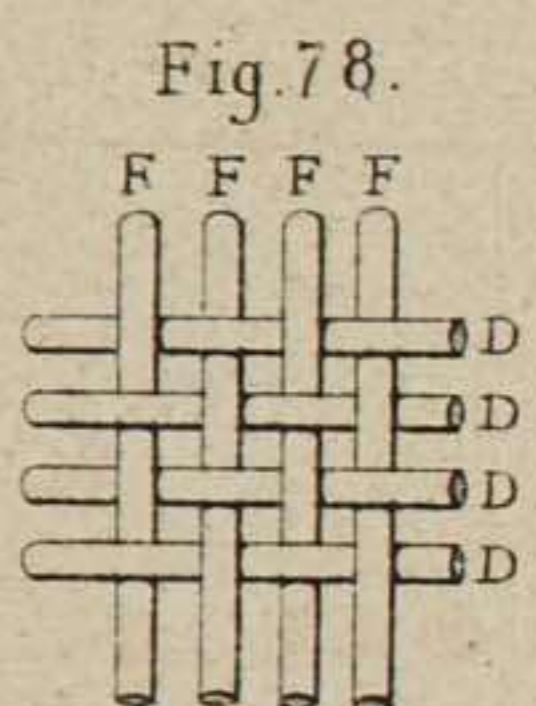


Fig. 77.



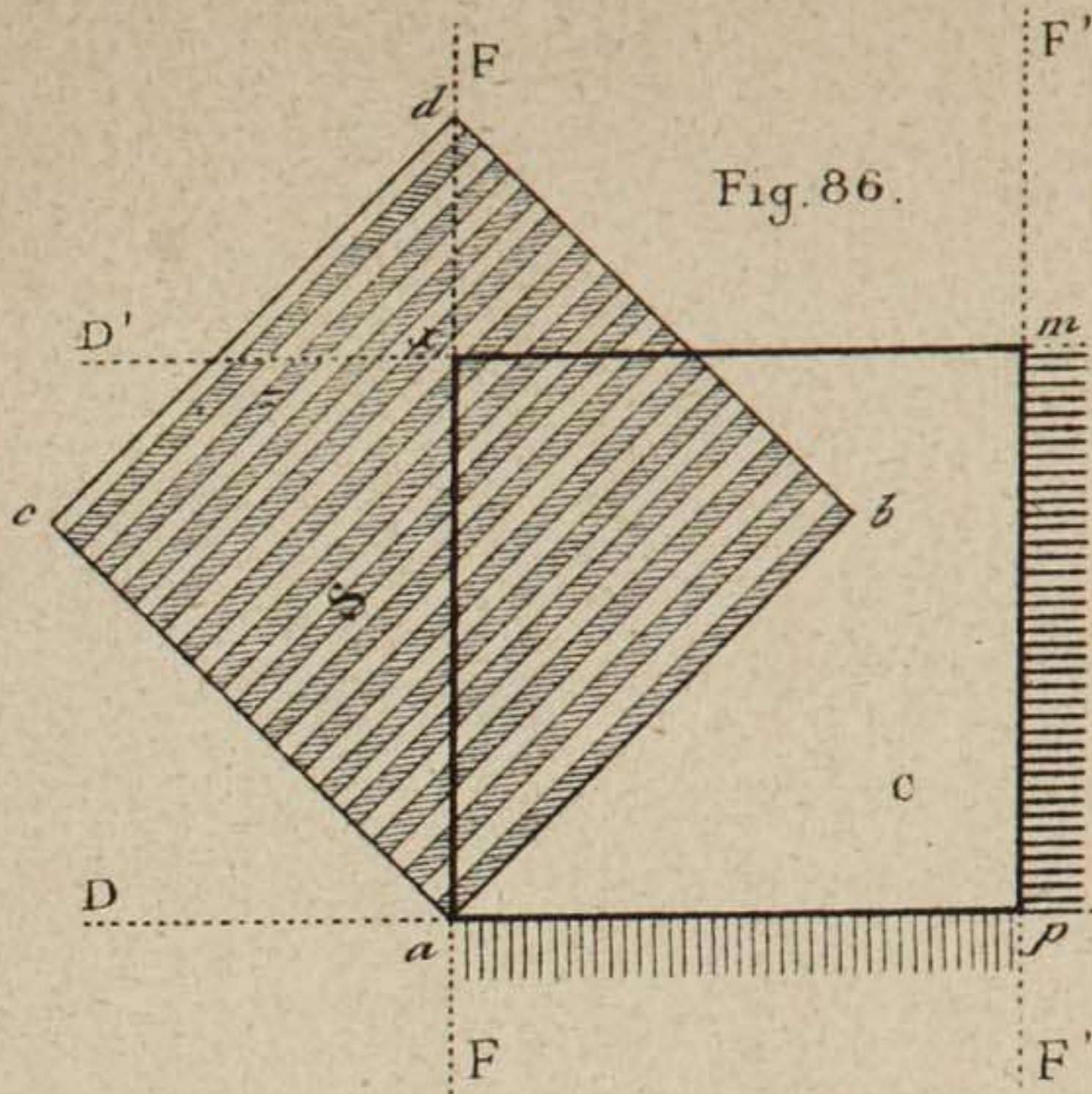


Fig. 86.

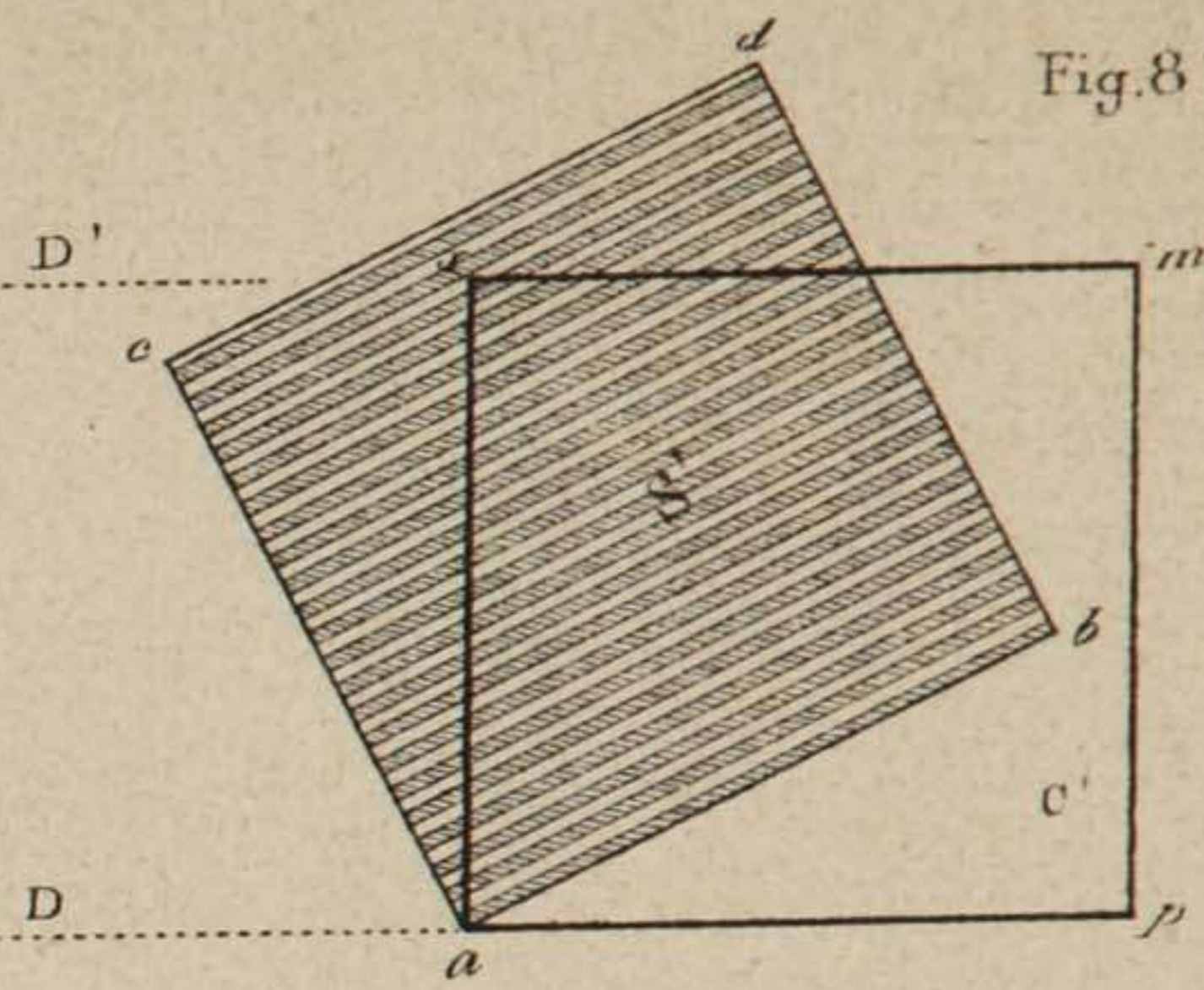
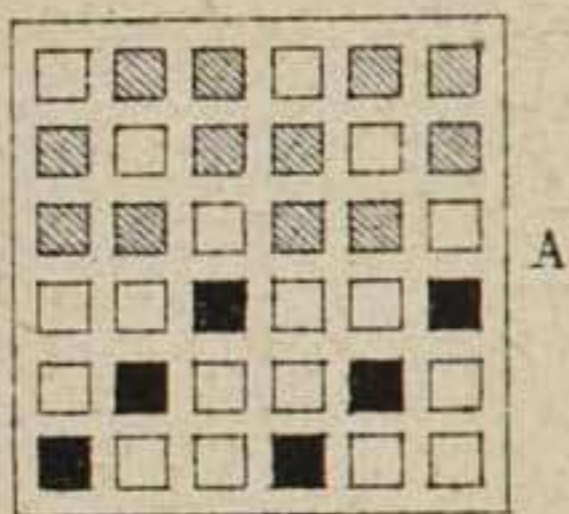


Fig. 87.

Fig. 94.



Reps por la trama
Colas longitudinales

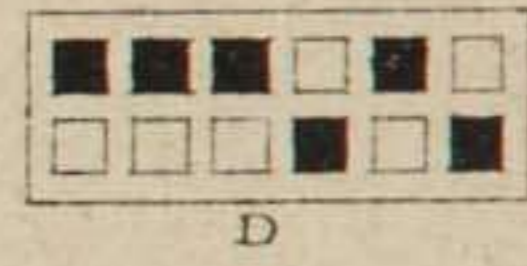
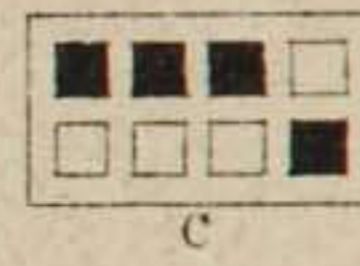
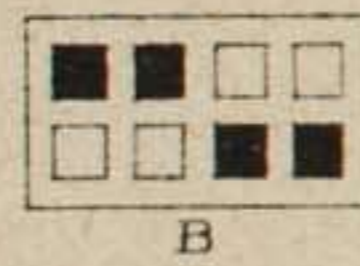
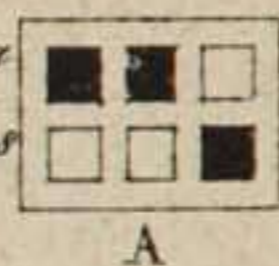
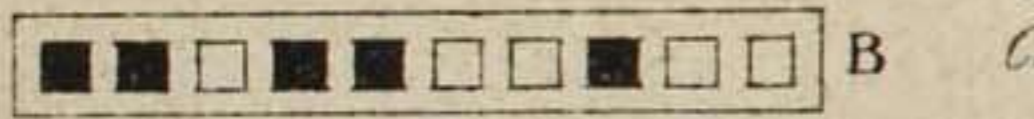


Fig. 88^{bis}



Reps por el urdimbre
Colas transversales

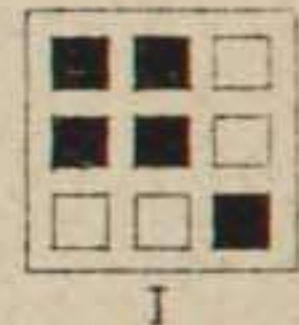
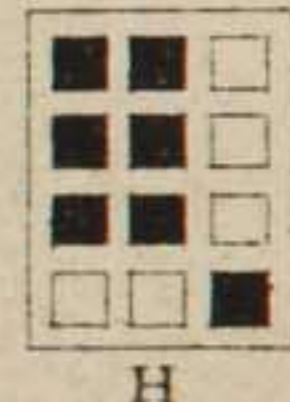
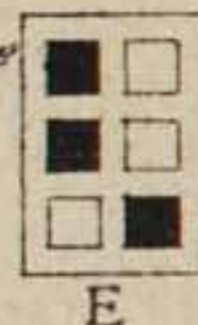


Fig. 89.

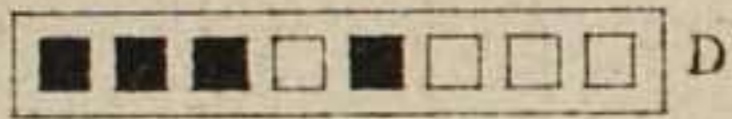


Fig. 95.

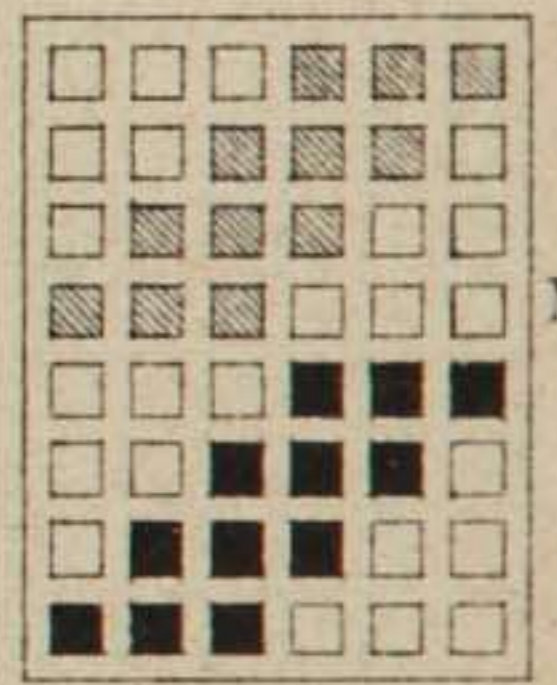
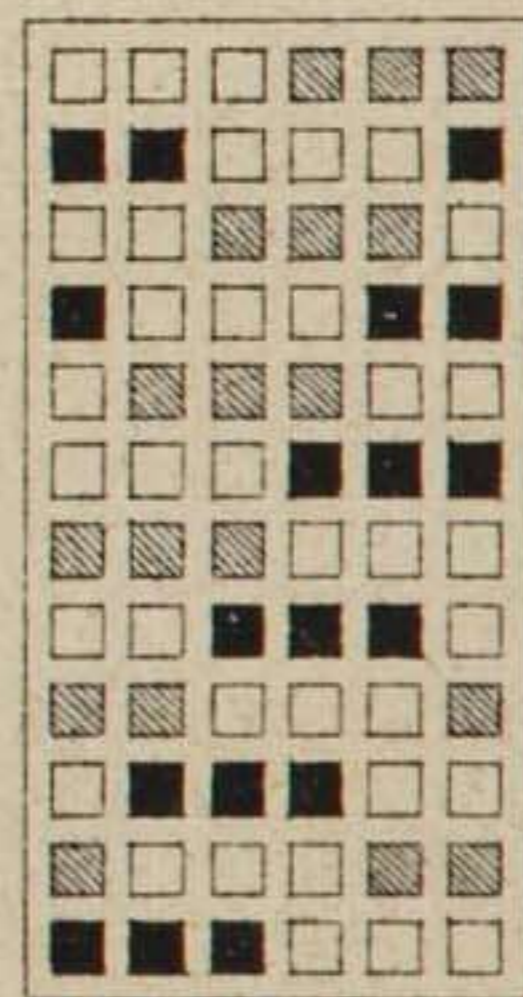
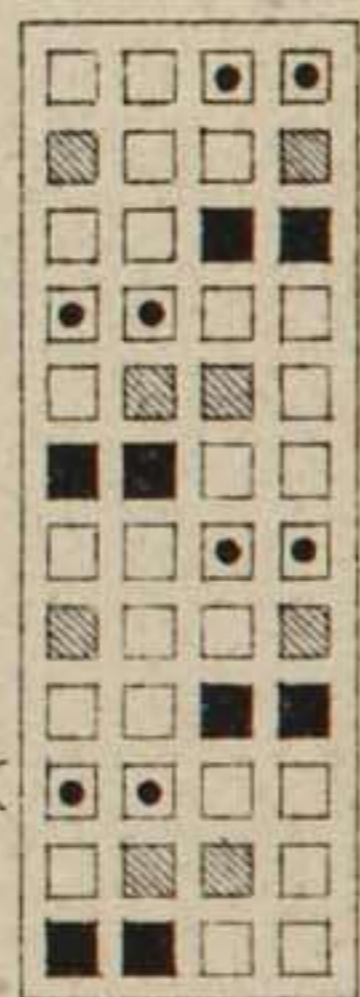
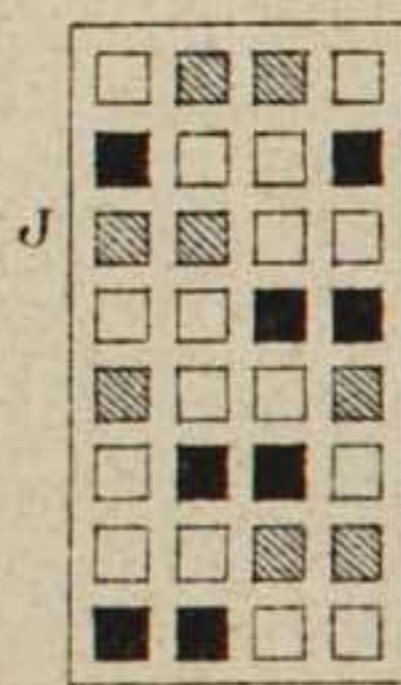


Fig. 90.

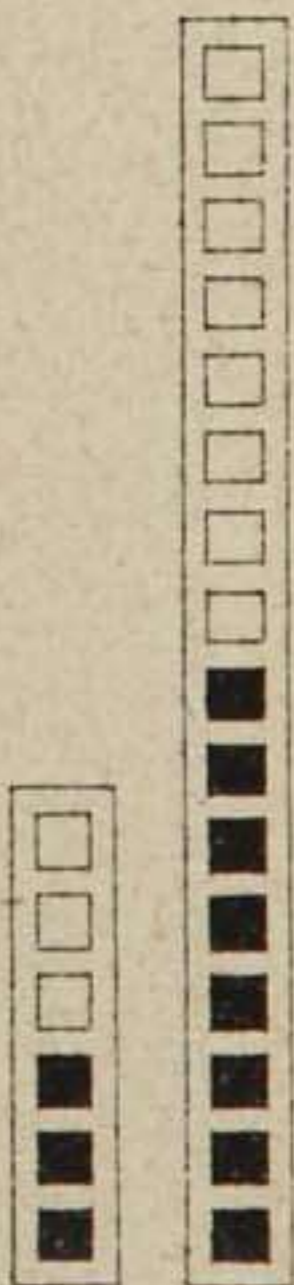


Fig. 91.

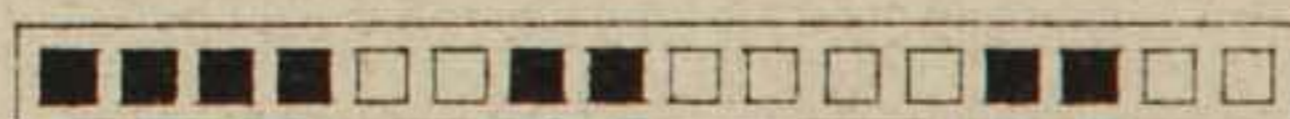


Fig. 88.

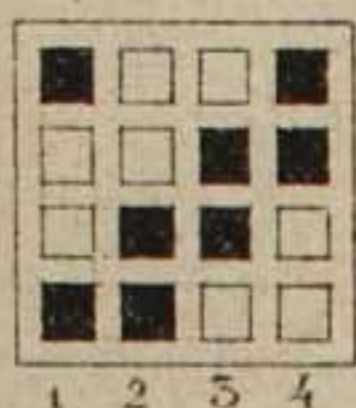
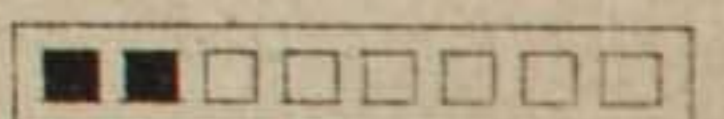
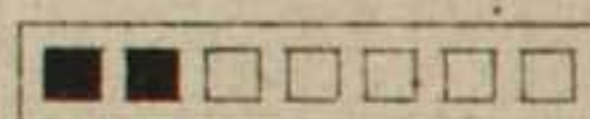
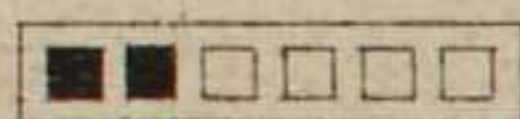


Fig. 92.



este último: gran tela rusa

Fig. 97.

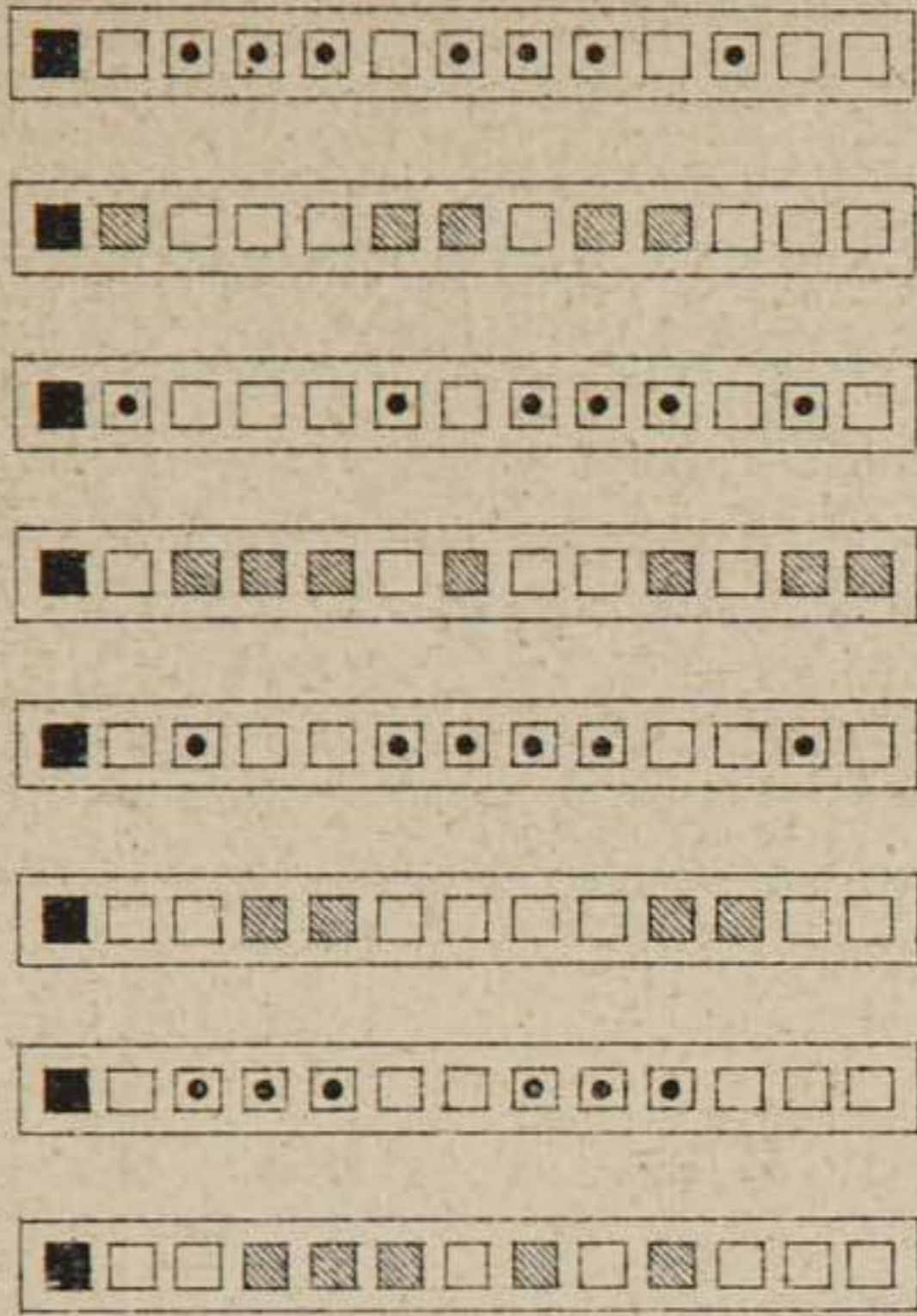
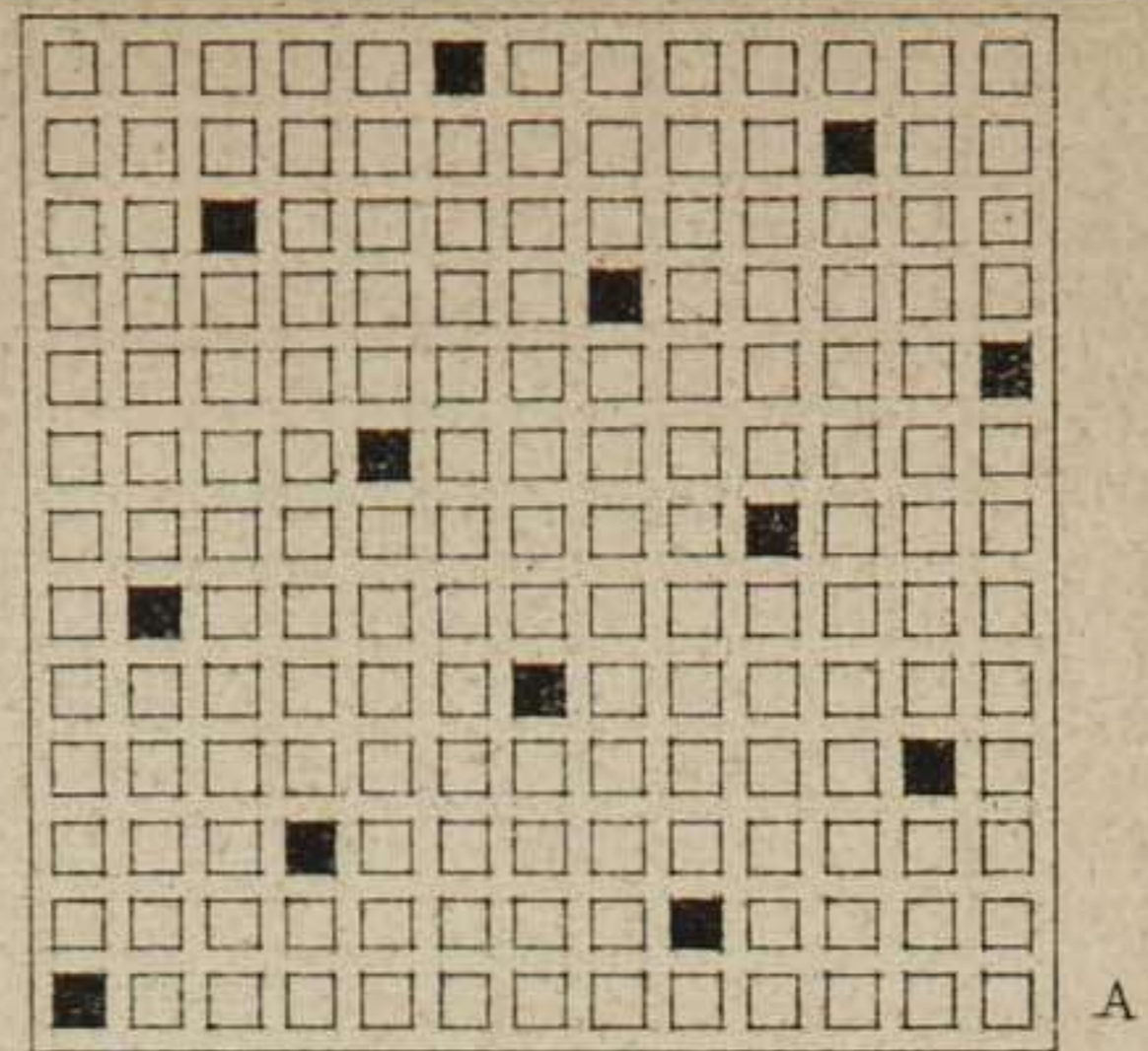


Fig. 95.



1ª pasada

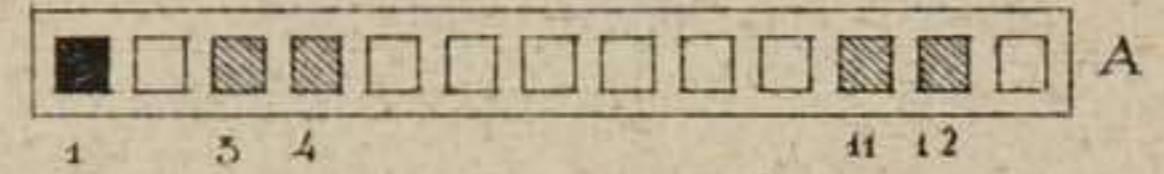


Fig. 96.

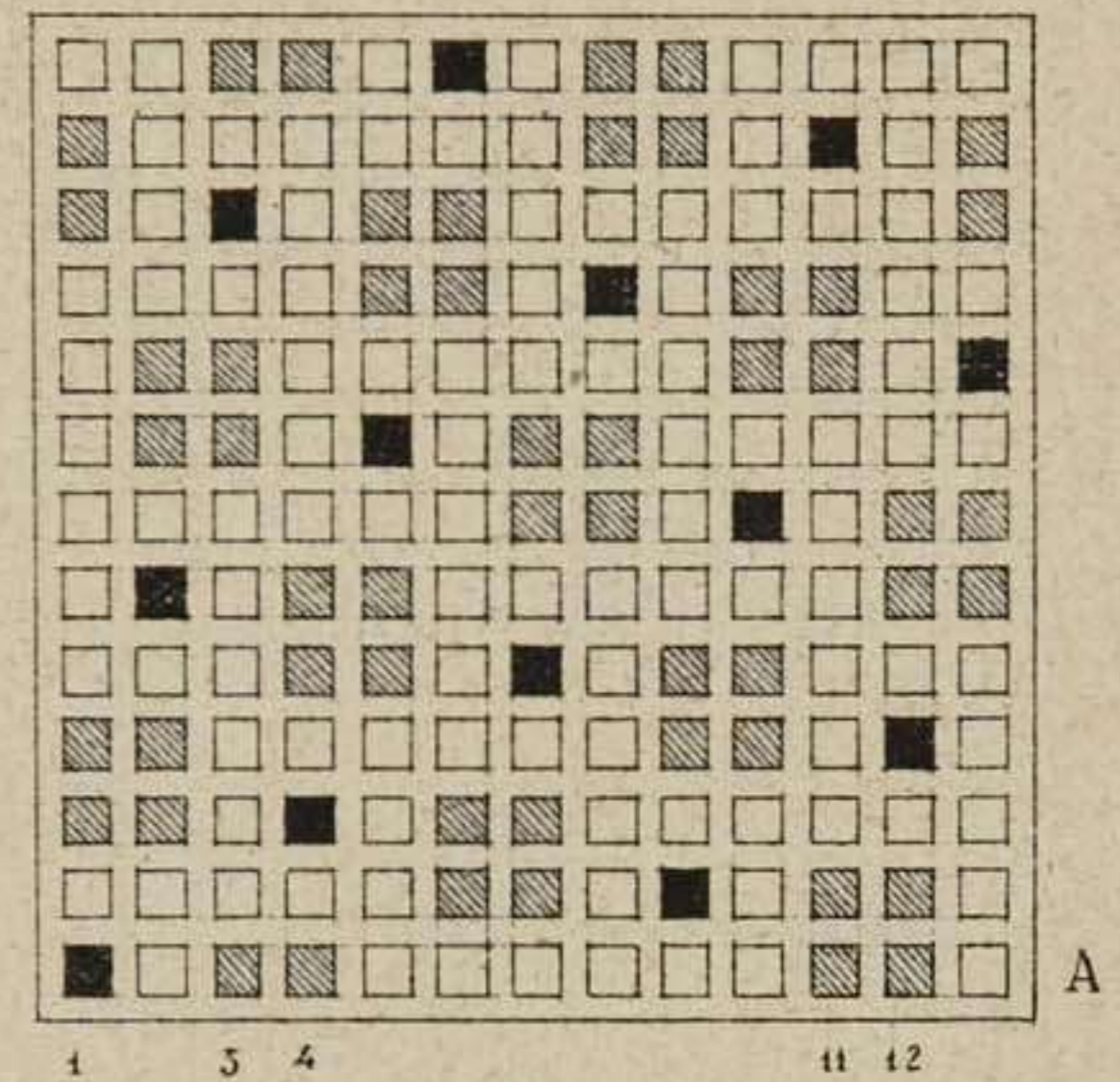


Fig. 99.

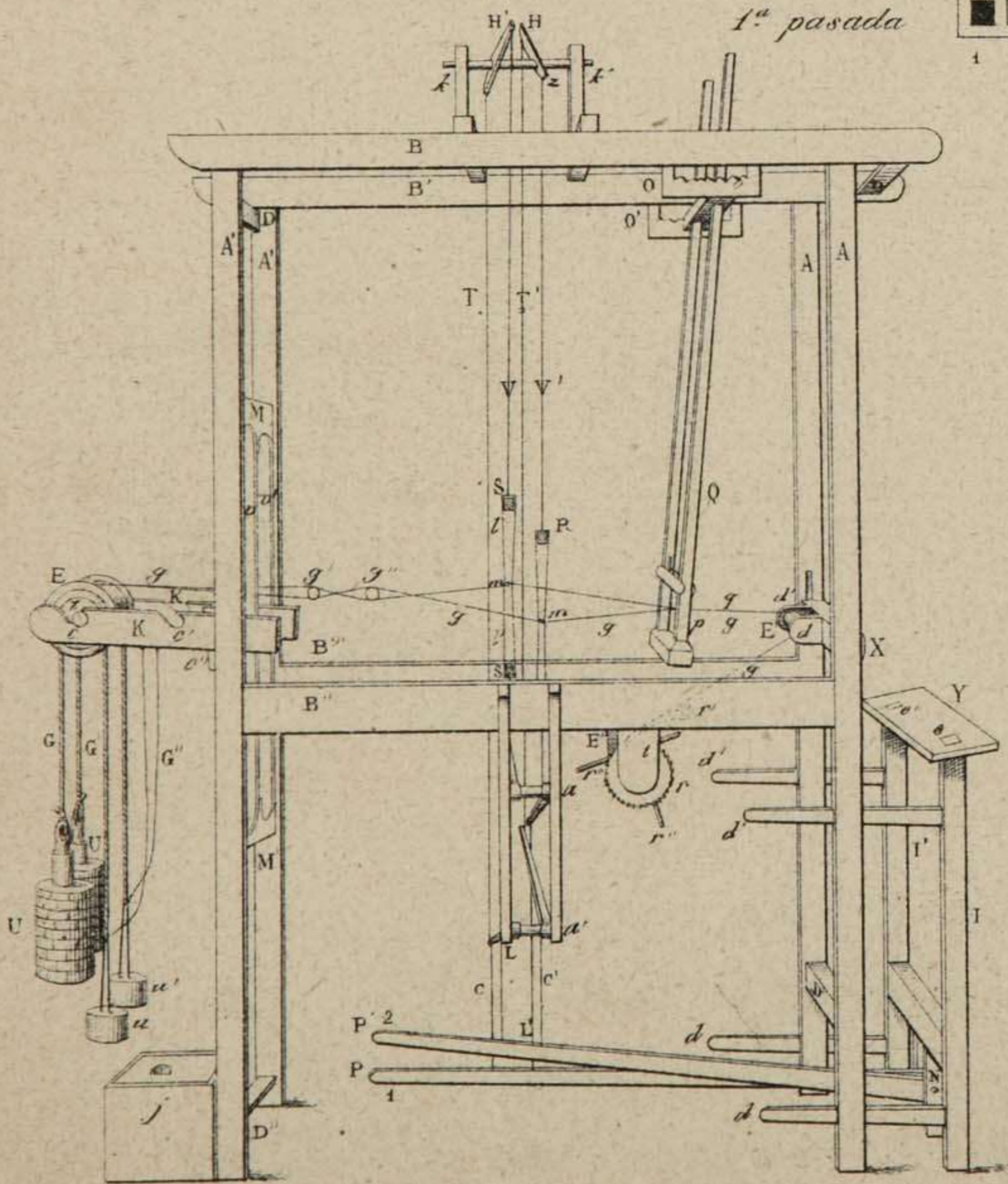
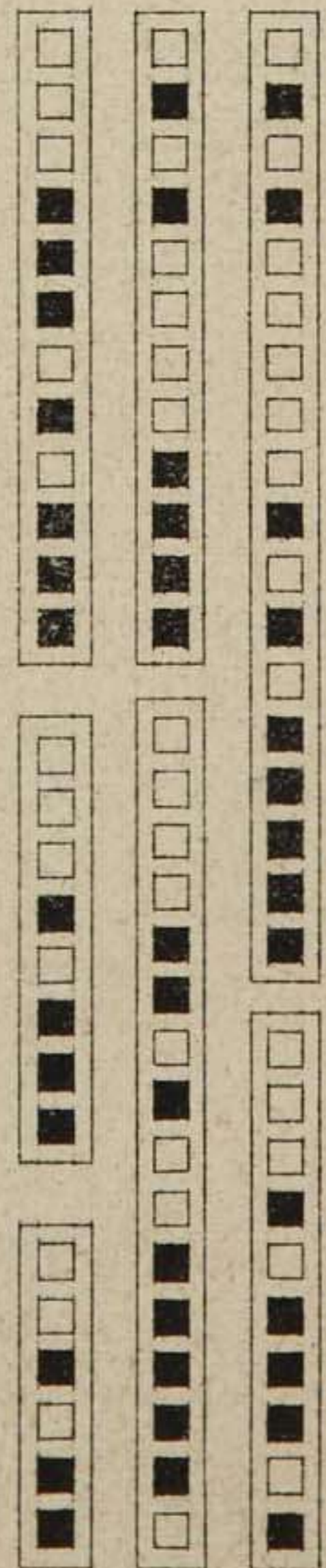


Fig. 98.



ESPLICACION DE LA MARCHA Y DEL EMBRAGADO

Cuatro sistemas de palancas:

- 1.º Cárcolas.
- 2.º Espadas.
- 3.º Espaditas.
- 4.º Palancas.

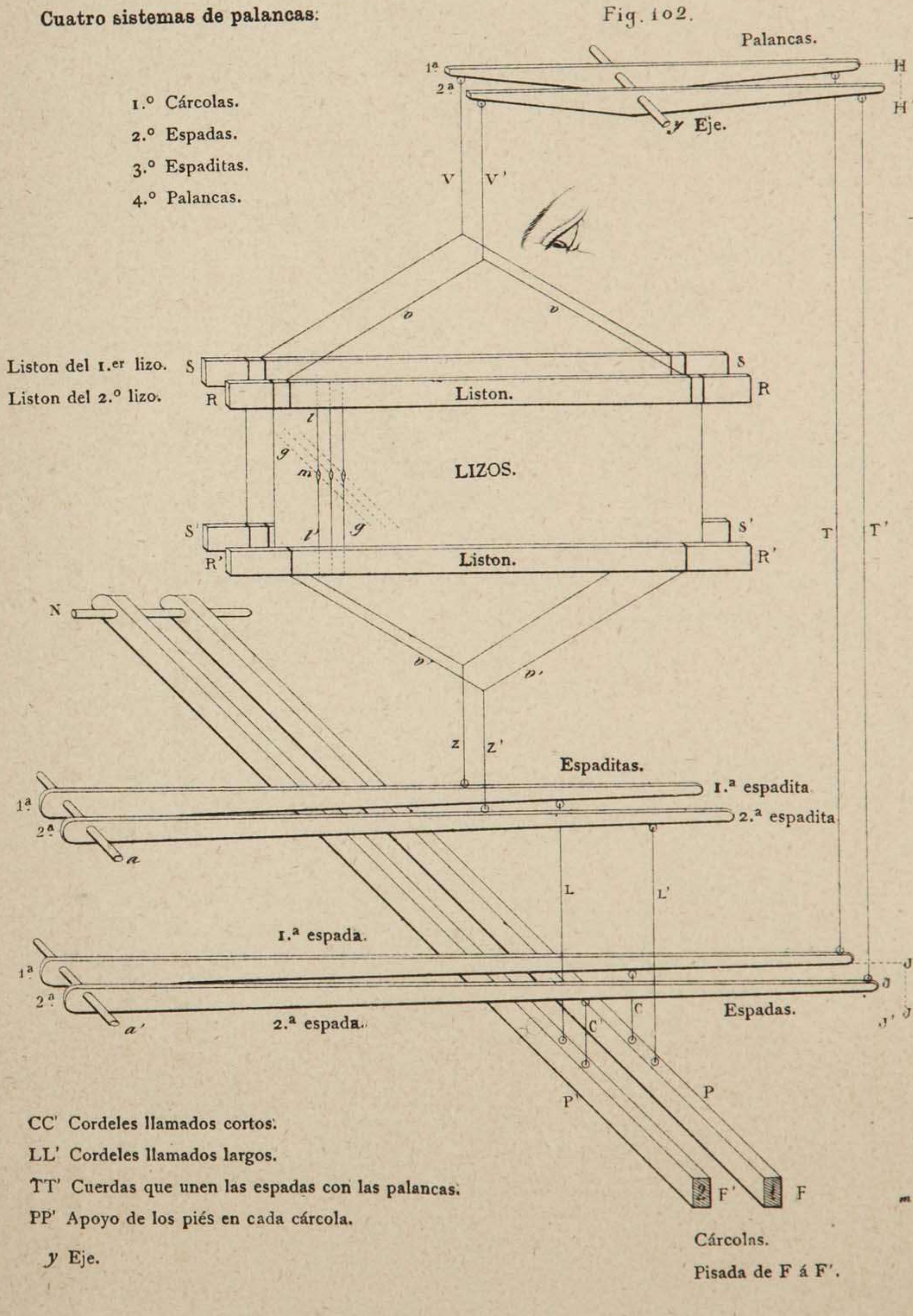


Fig. 102.

Fig. 100.

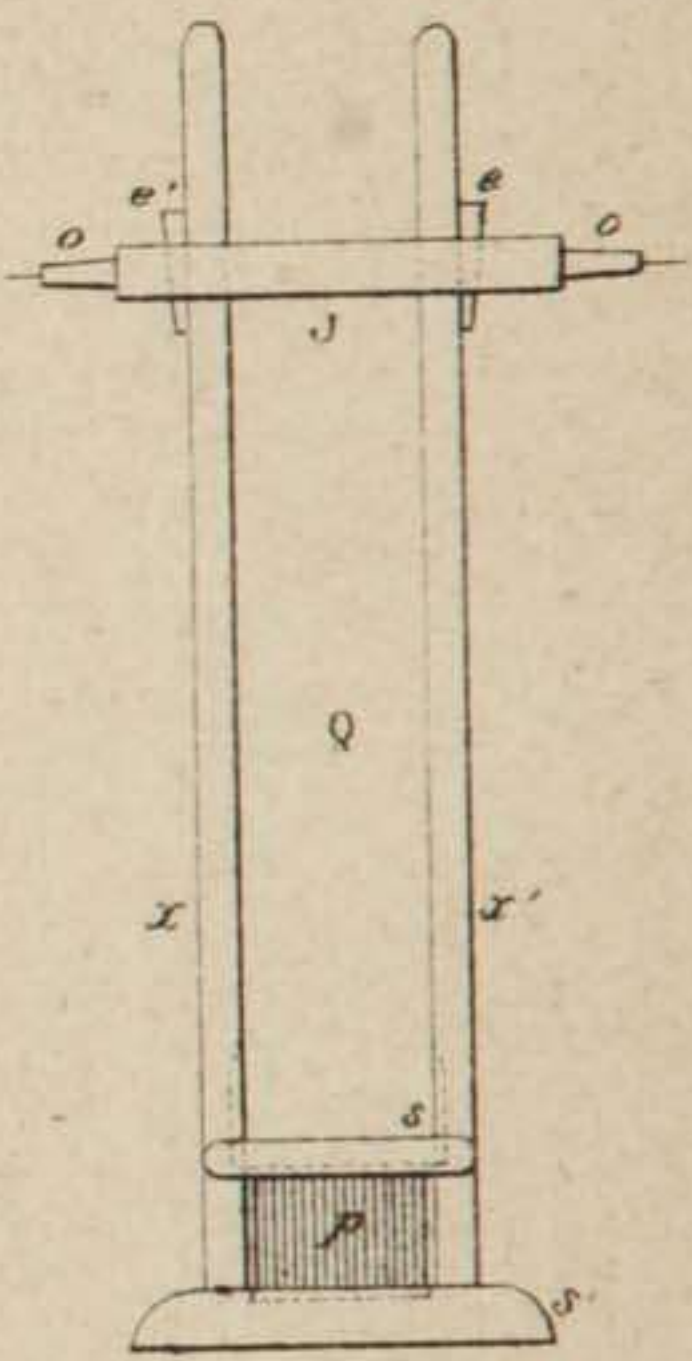


Fig. 101.

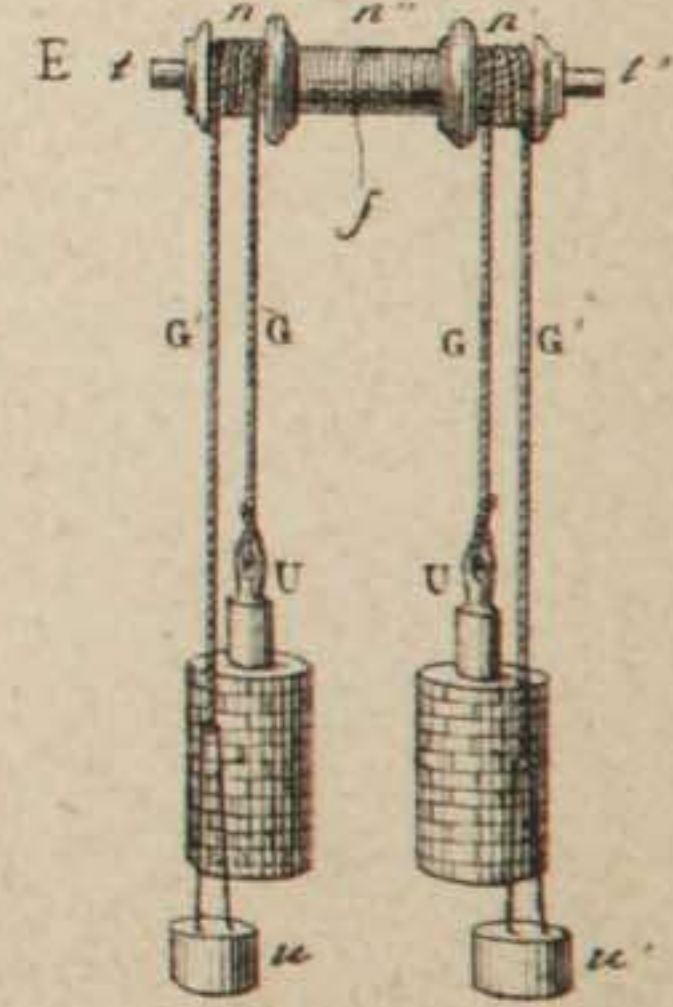
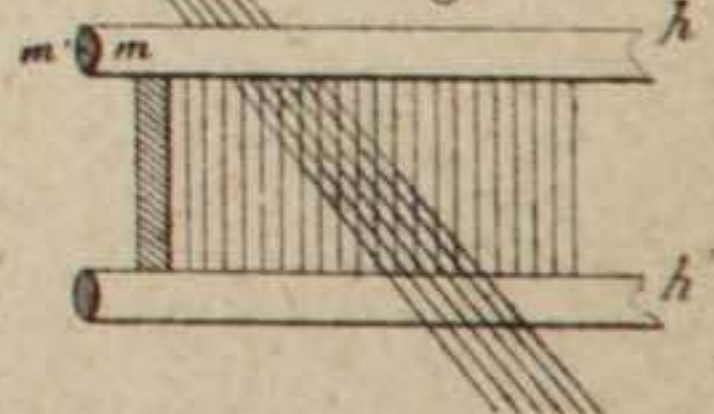


Fig. 103.



CC' Cordeles llamados cortos.
 LL' Cordeles llamados largos.
 TT' Cuerdas que unen las espadas con las palancas.
 PP' Apoyo de los piés en cada cárcola.
 y Eje.

Cárcolas.
 Pisada de F á F'.

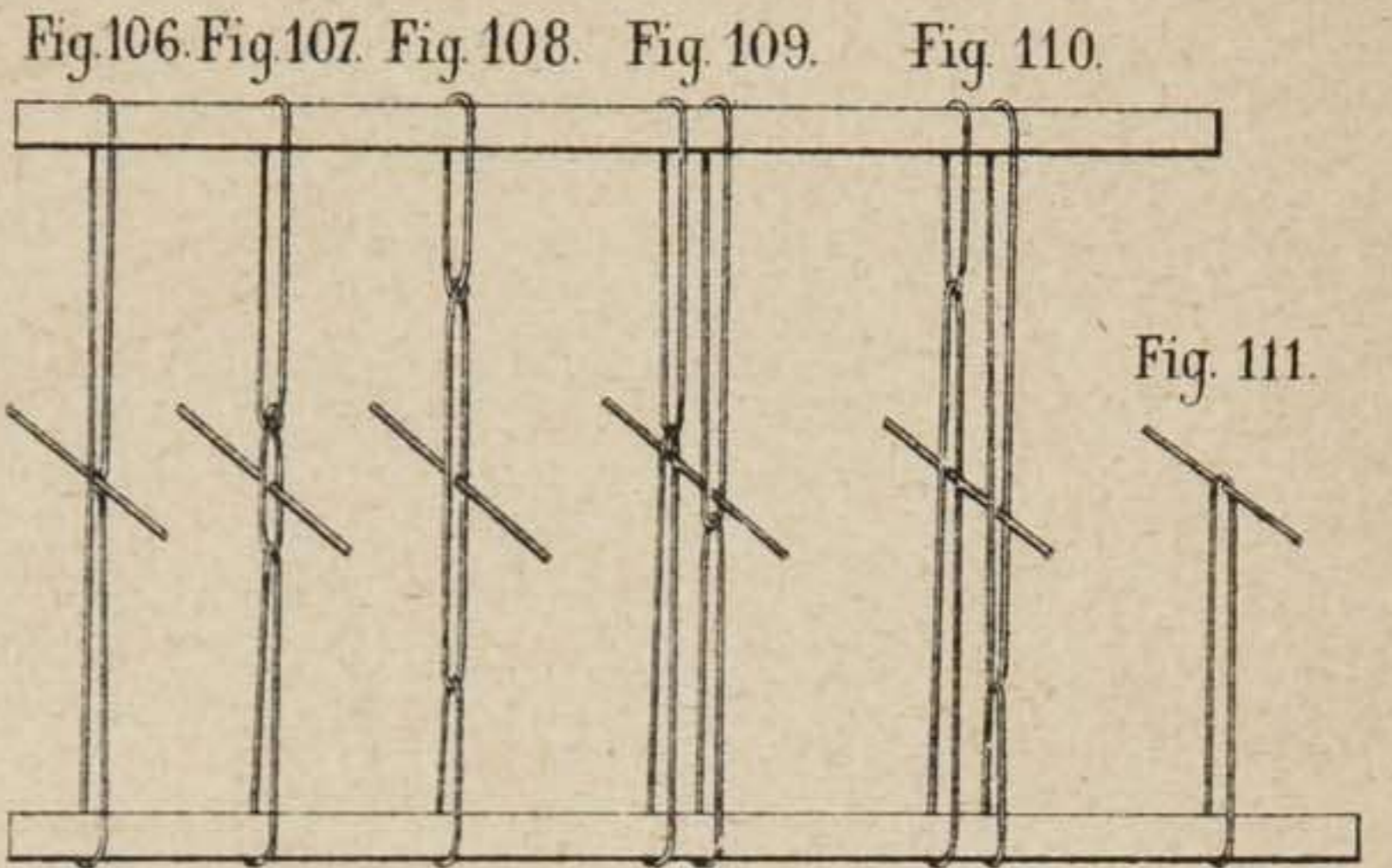
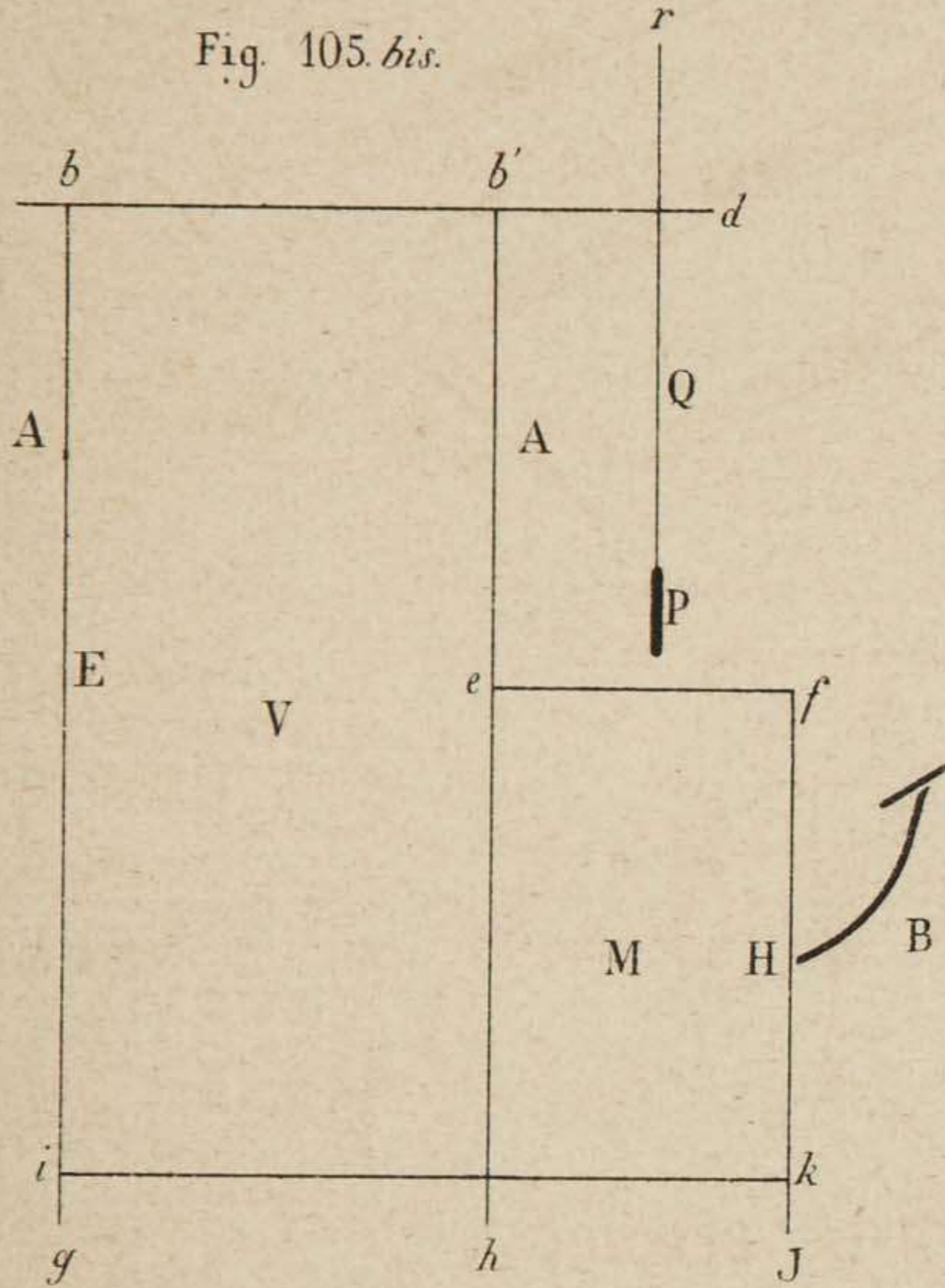


Fig. 114.

1^{er} lizo. ————— regla superior vista de arriba.
 2^o lizo. ————— id.

■
 OPERARIO.

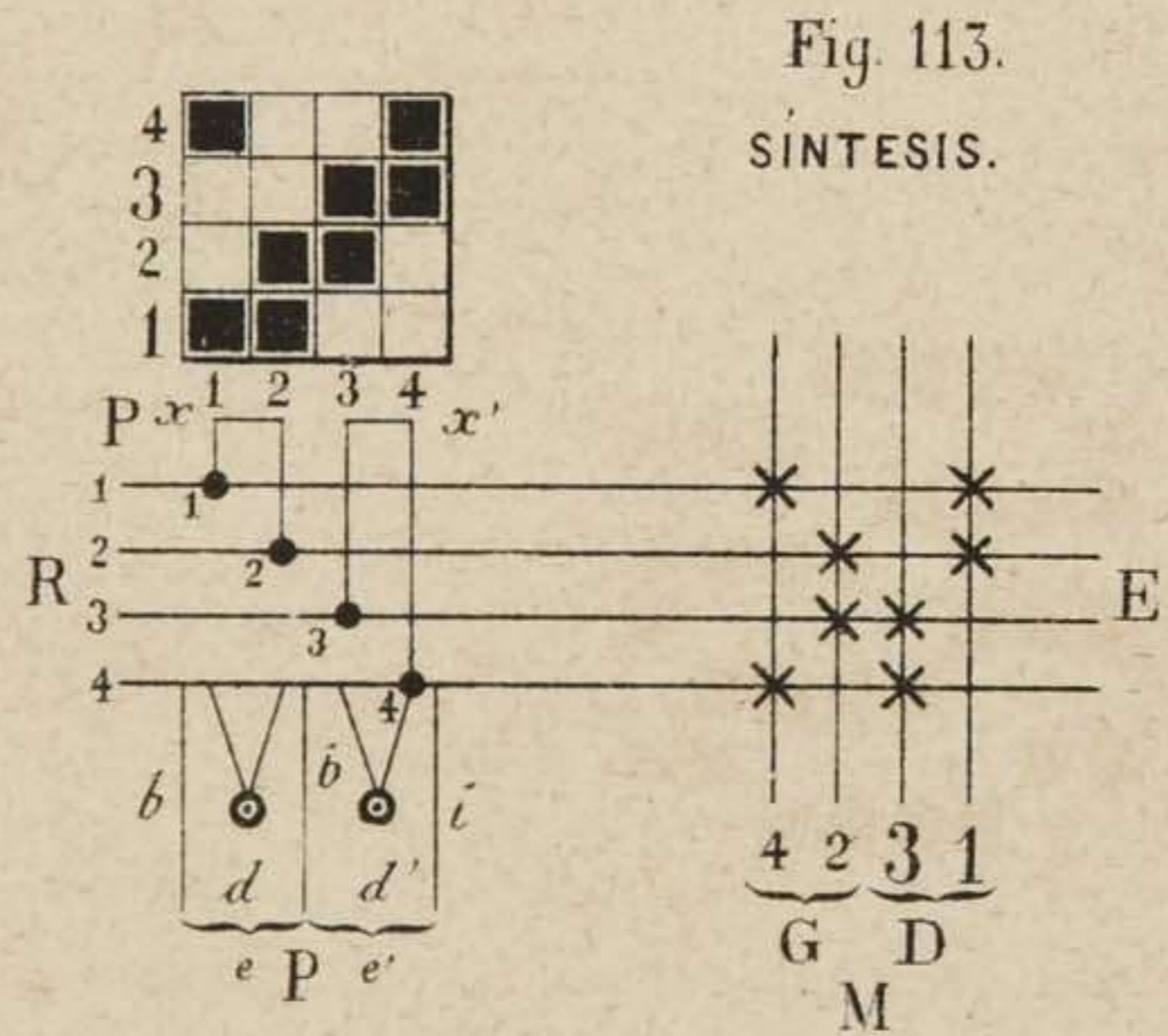


Fig. 112.

Fig. 115.

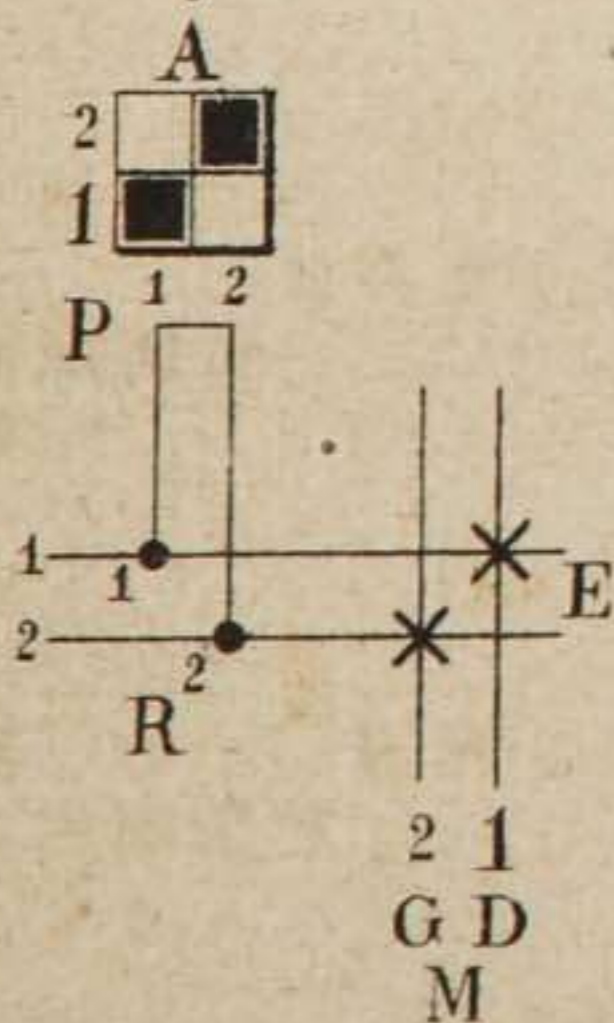


Fig. 116.

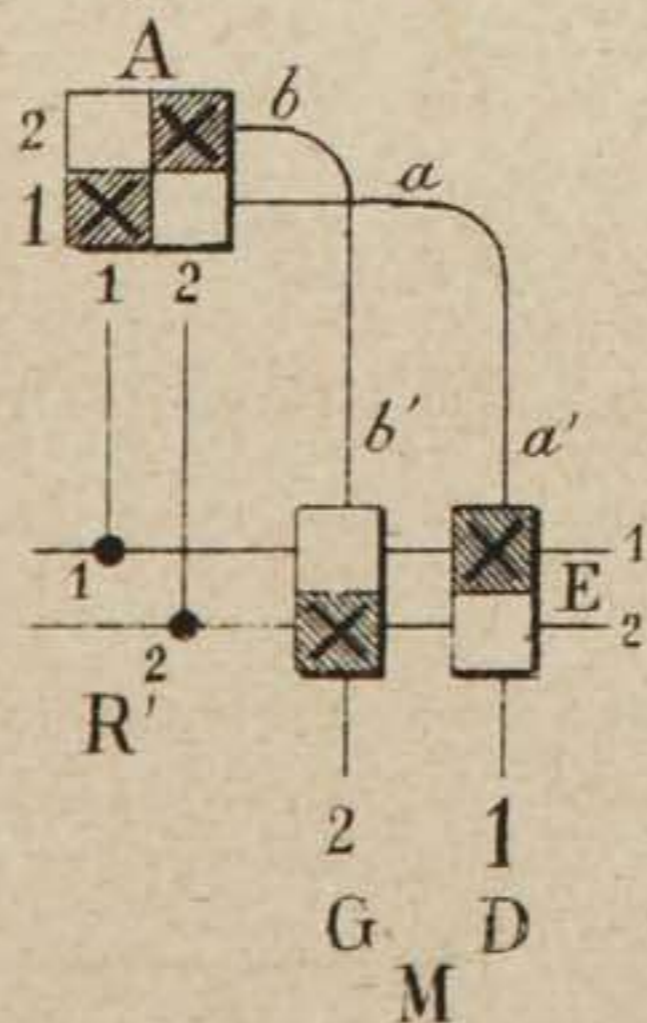
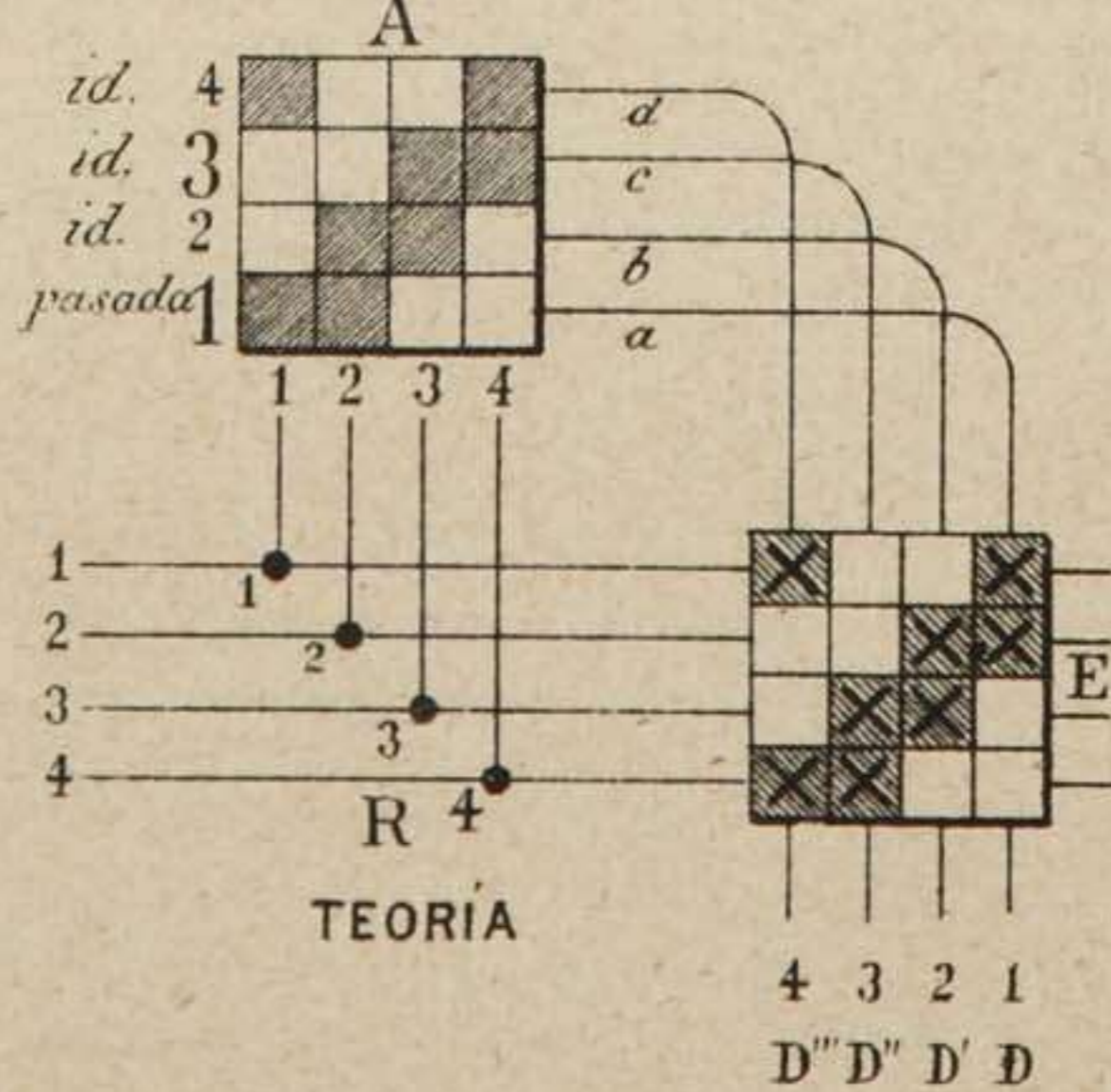
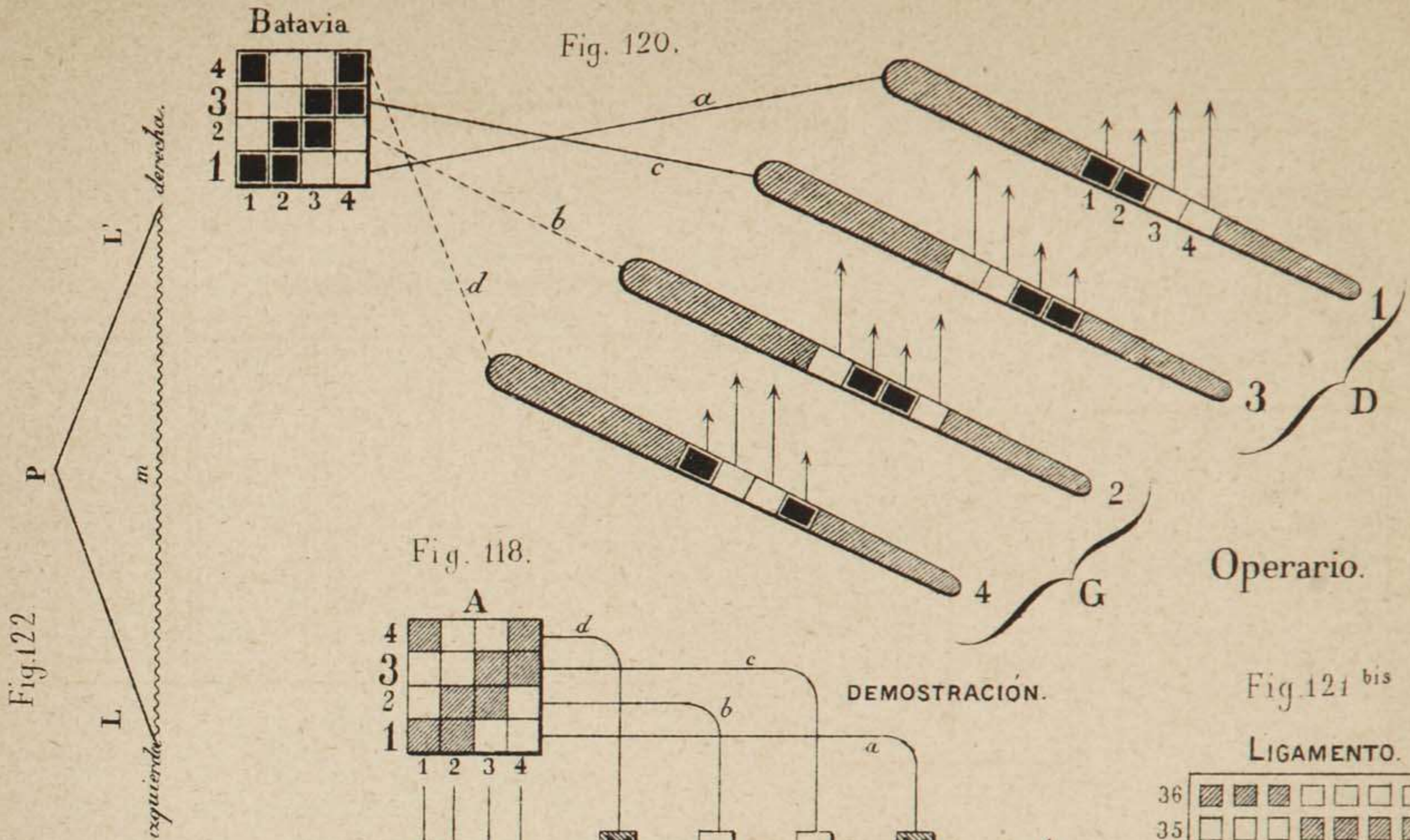


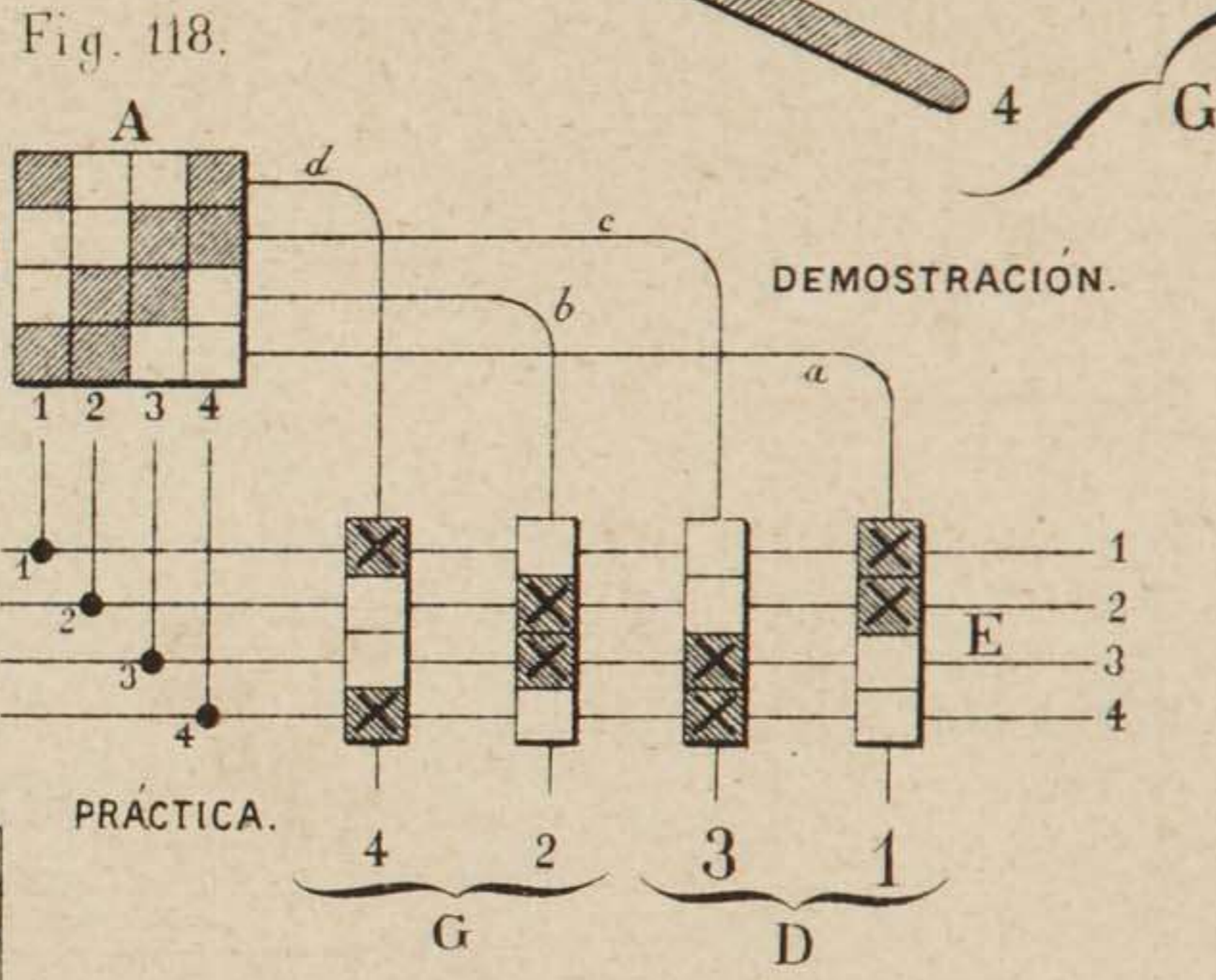
Fig. 117.





PASADAS Semejantes.

24	22	20					
23	21	19					
30	28	26	18	16	14		
29	27	25	17	15	13		
36	34	32	12	10	8		
35	33	31	11	9	7		
6	4	2					
5	3	1					



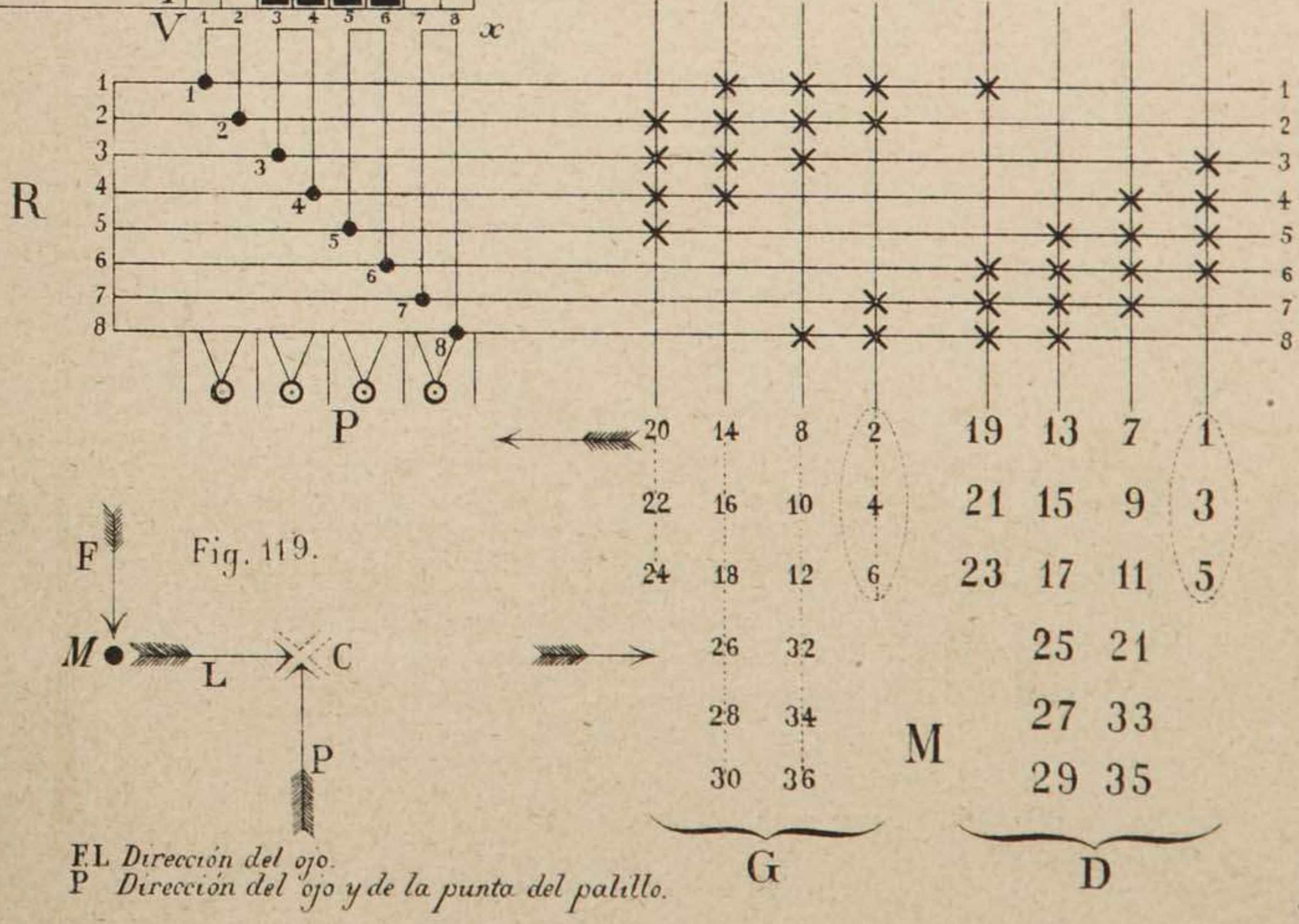
Operario.

Fig. 121 bis

LIGAMENTO.

36							
35							
34							
33							
32							
31							
30							
29							
28							
27							
26							
25							
24							
23							
22							
21							
20							
19							
18							
17							
16							
15							
14							
13							
12							
11							
10							
9							
8							
7							
6							
5							
4							
3							
2							
1							

REMETIDO SEGUIDO



Vedotes-trama puntuadas en negro. Similares, puntuadas grisado.

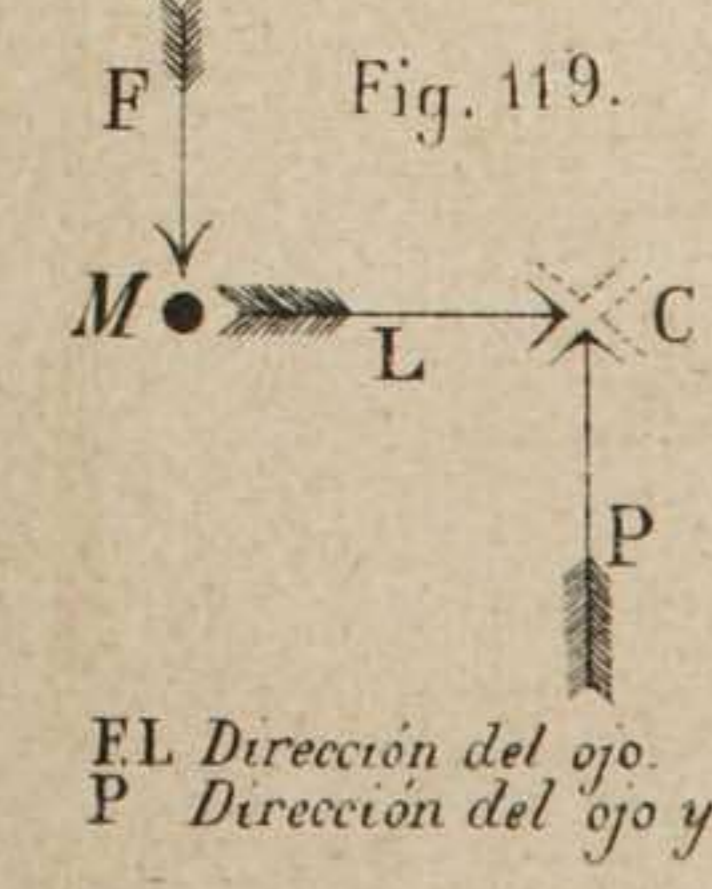


Fig. 123.

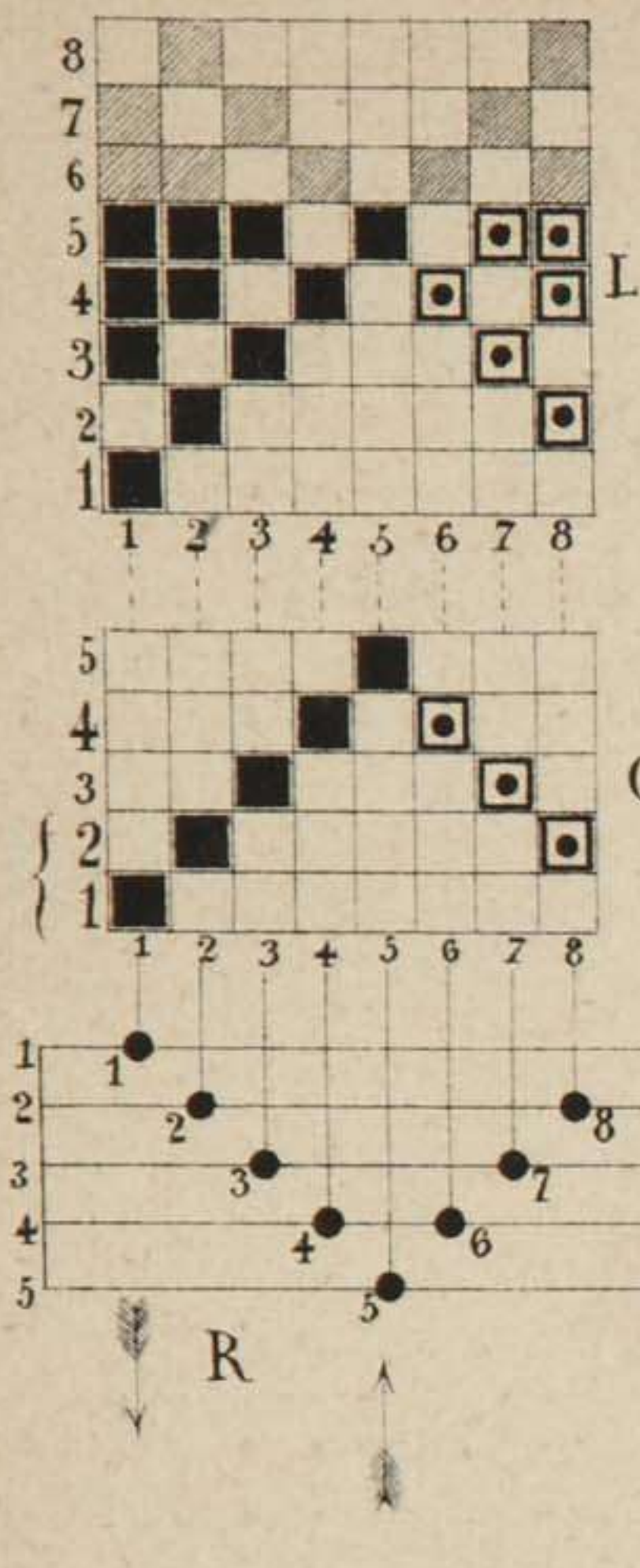


Fig. 124.

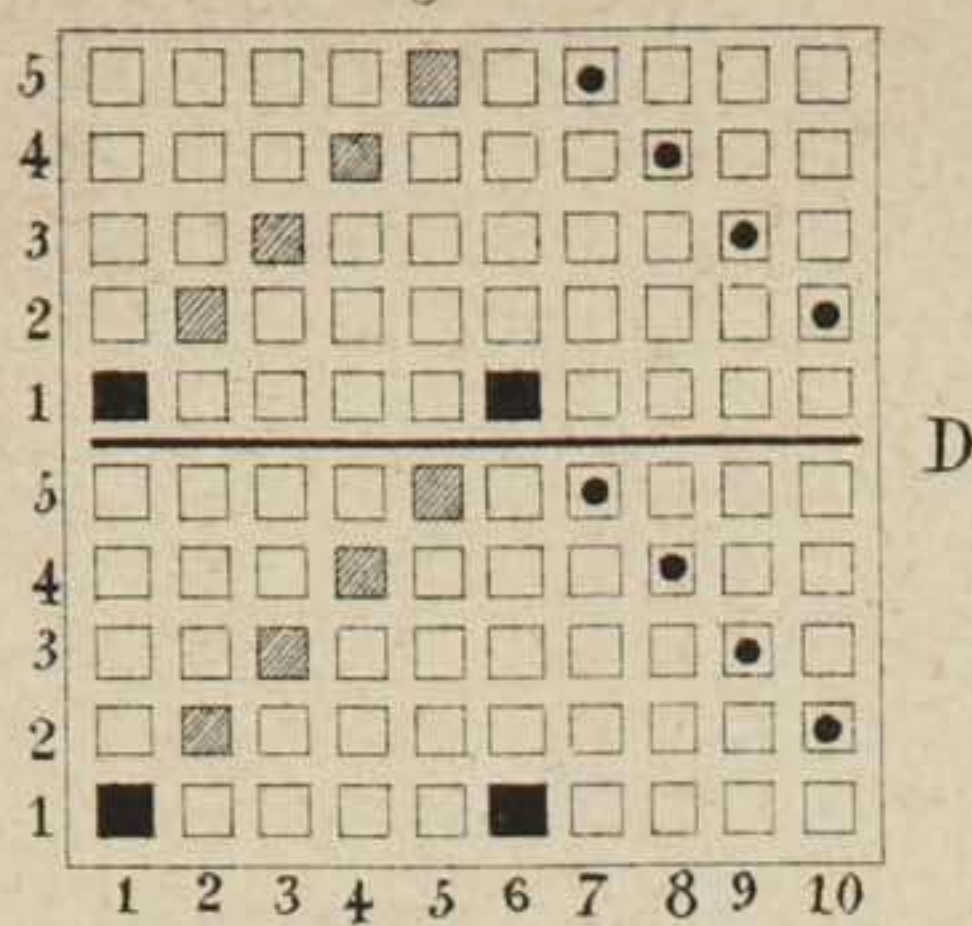


Fig. 125.

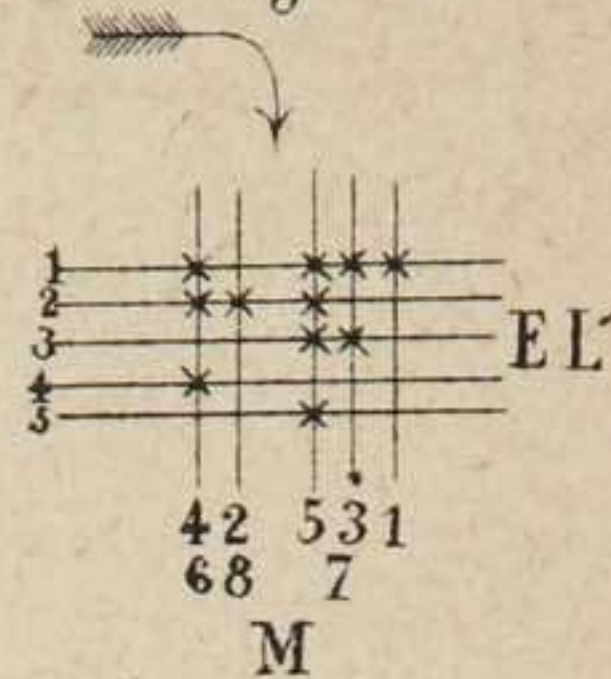
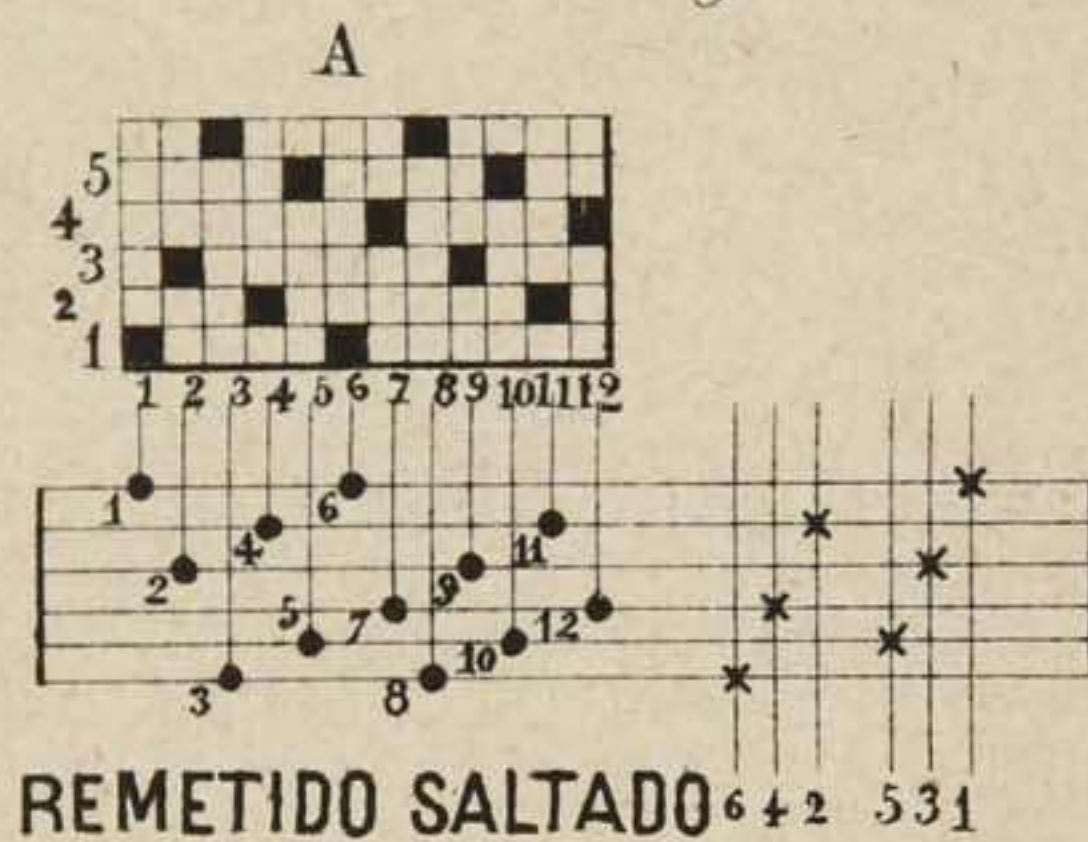


Fig. 127.



REMETIDO Á PUNTA Y RETORNO.

Fig. 126.

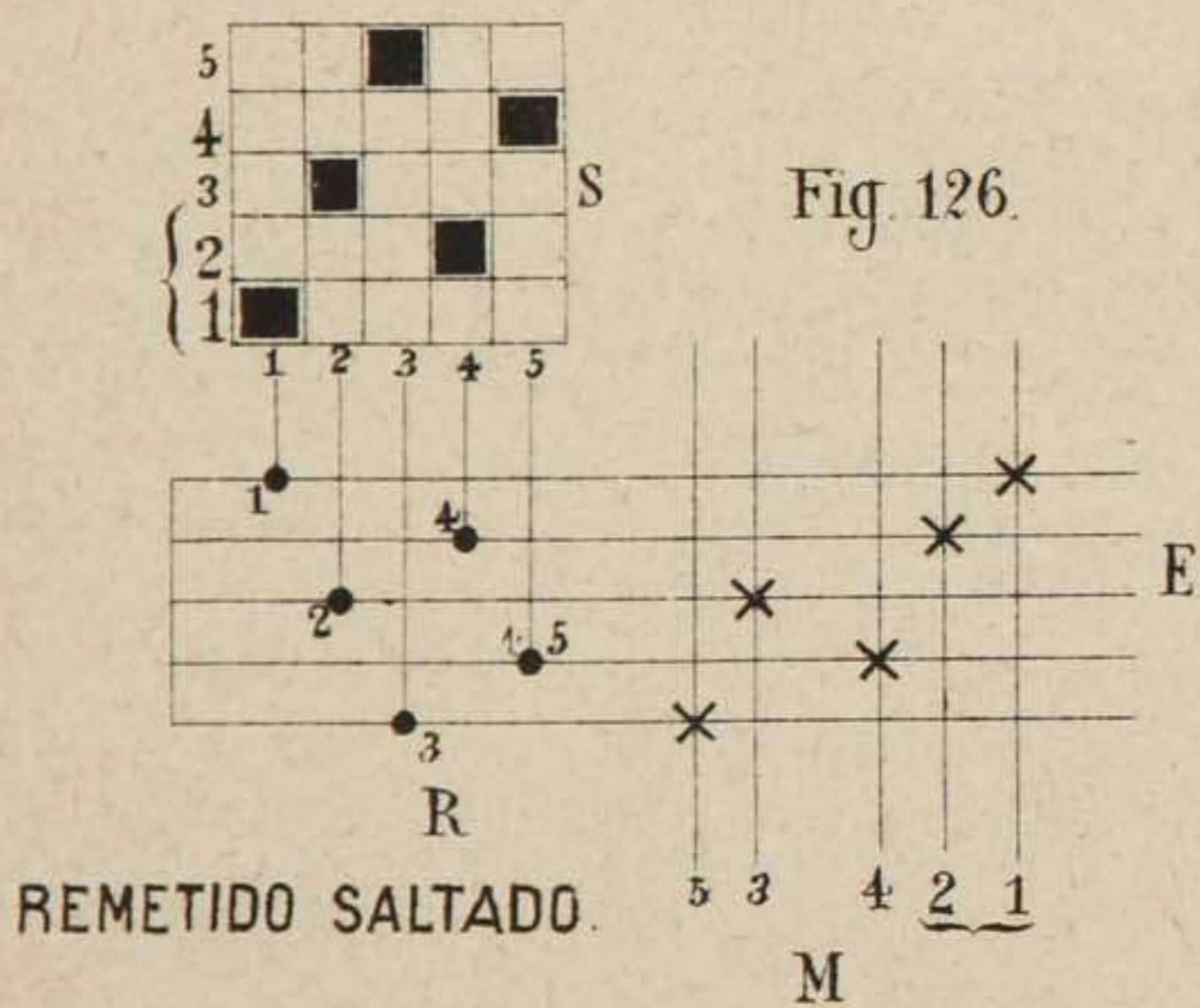


Fig. 131.

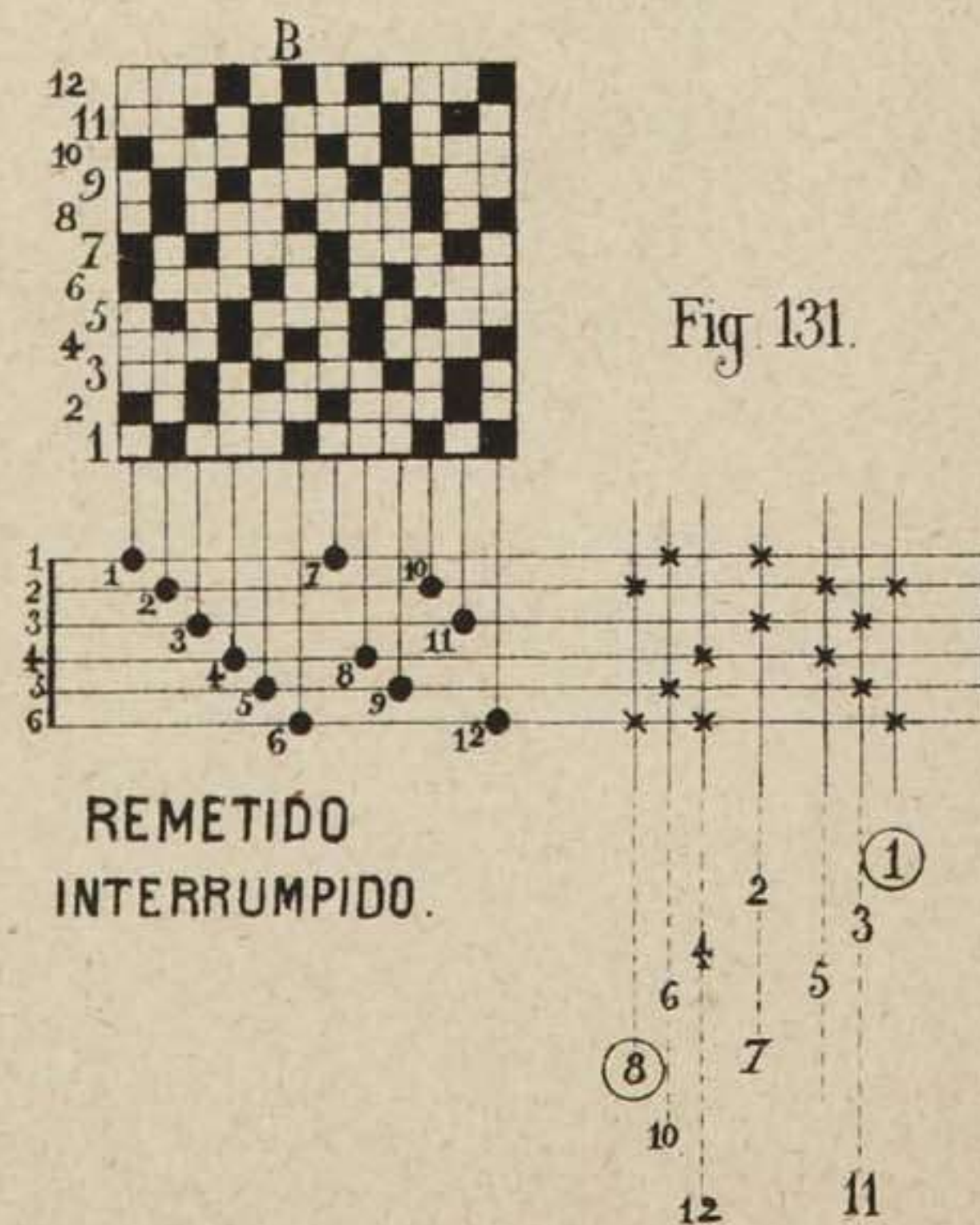
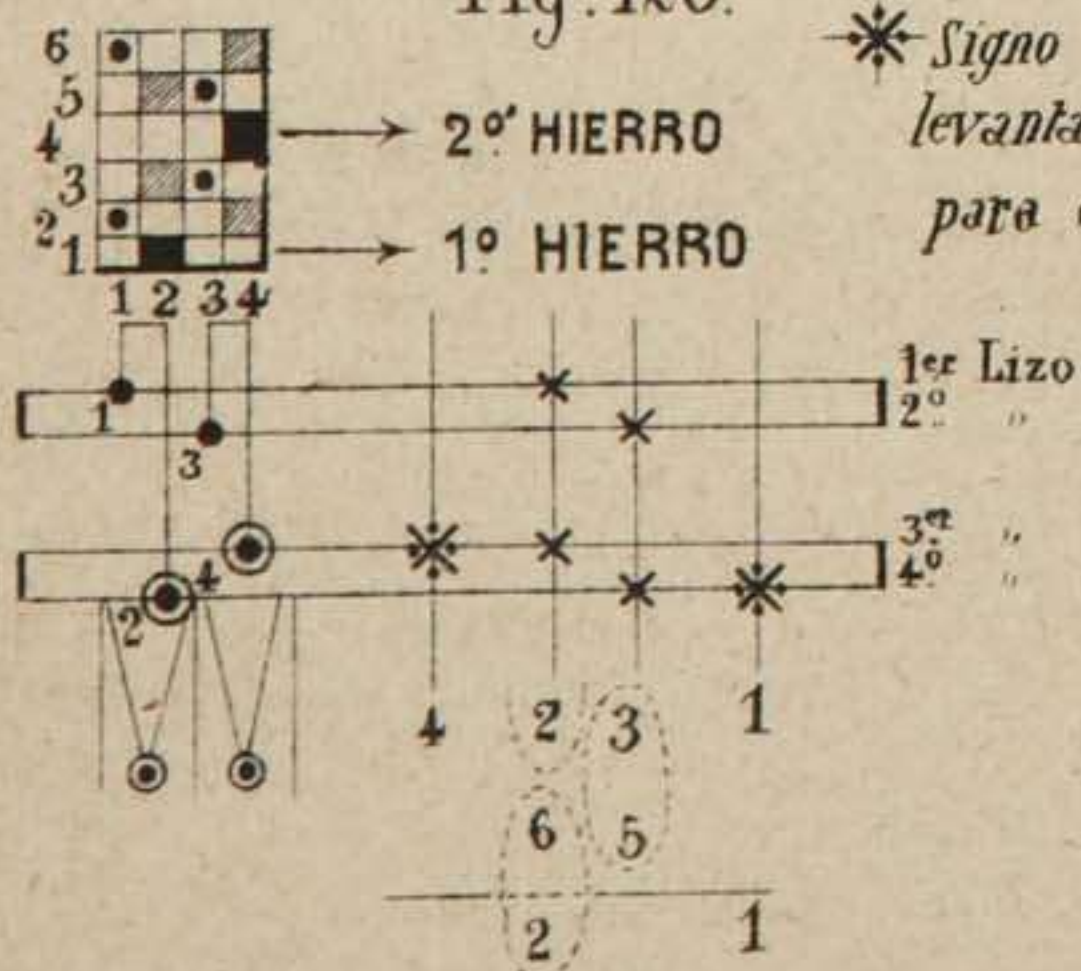


Fig. 128.

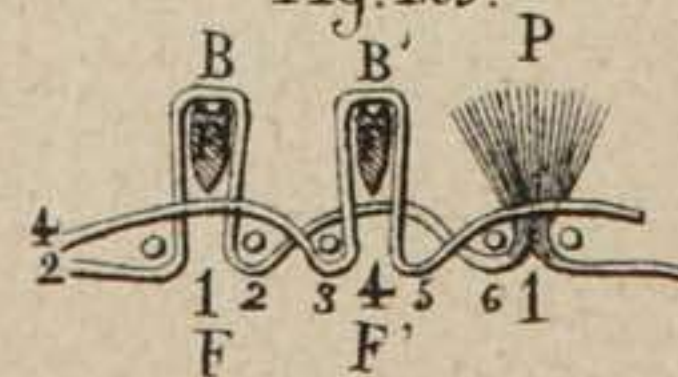


* Signo que indica el levantamiento de los pelos para el paso de los hierros.

Fig. 130.



Fig. 129.



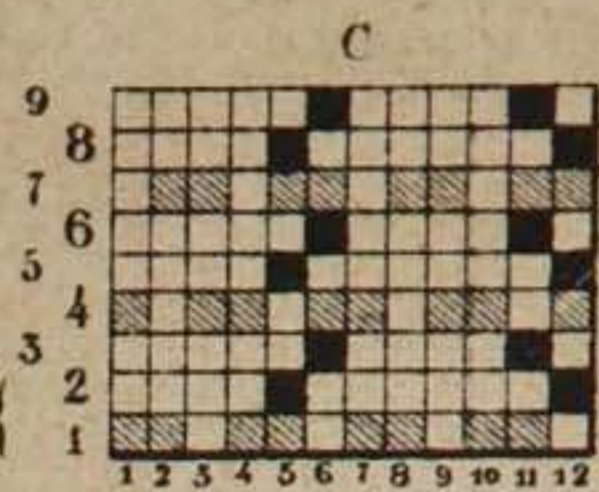


Fig. 133.

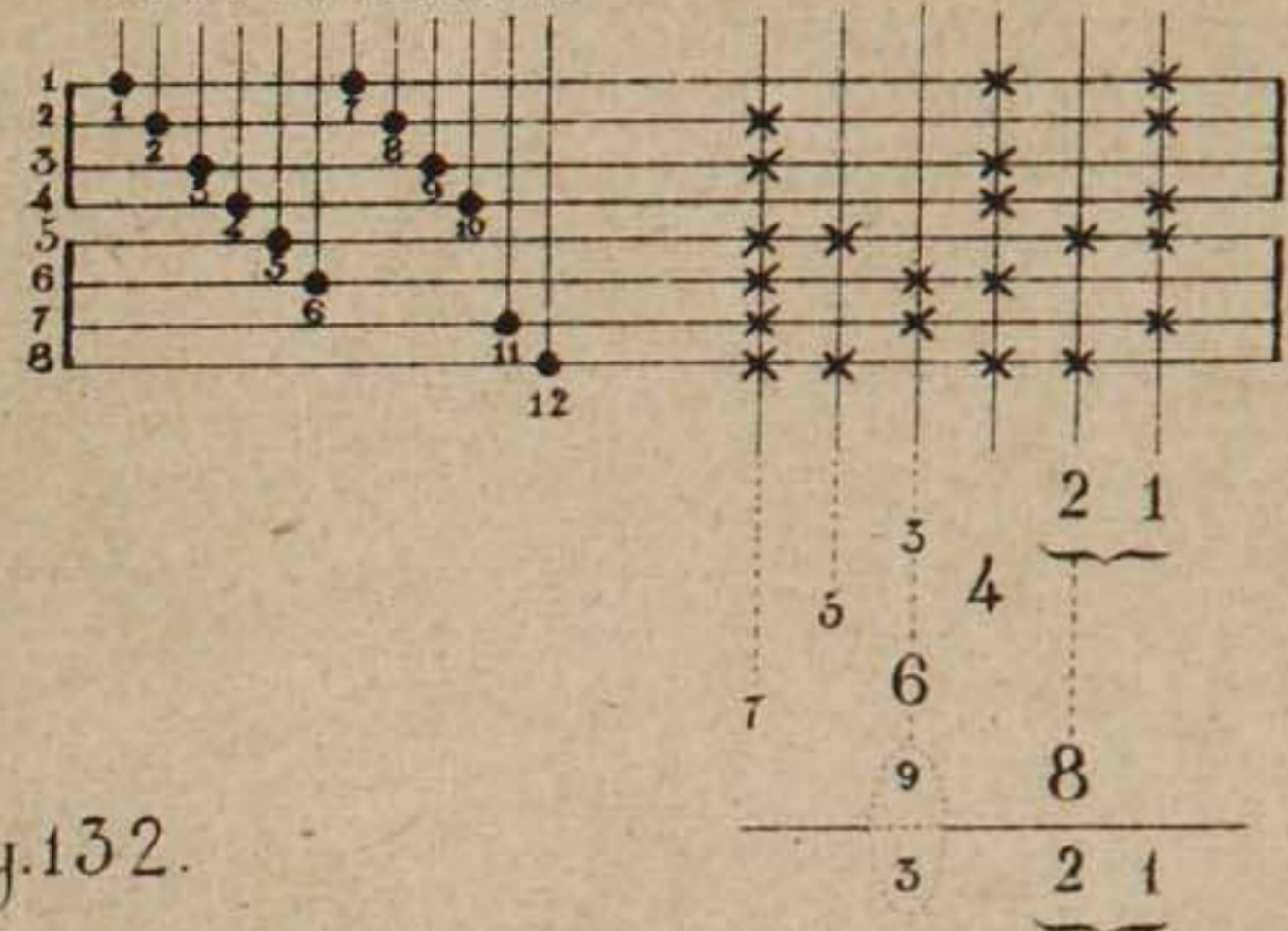


Fig. 132.

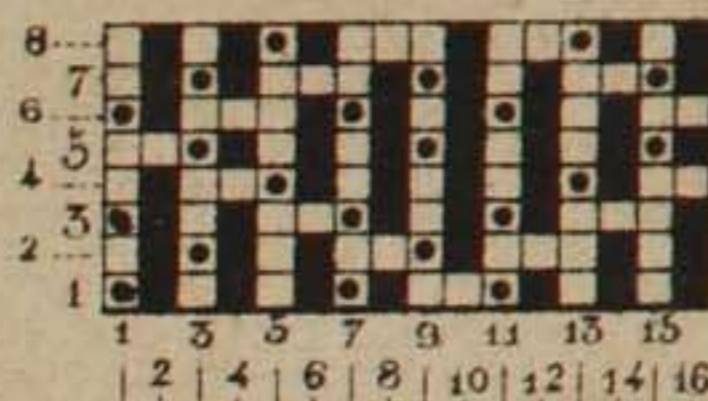
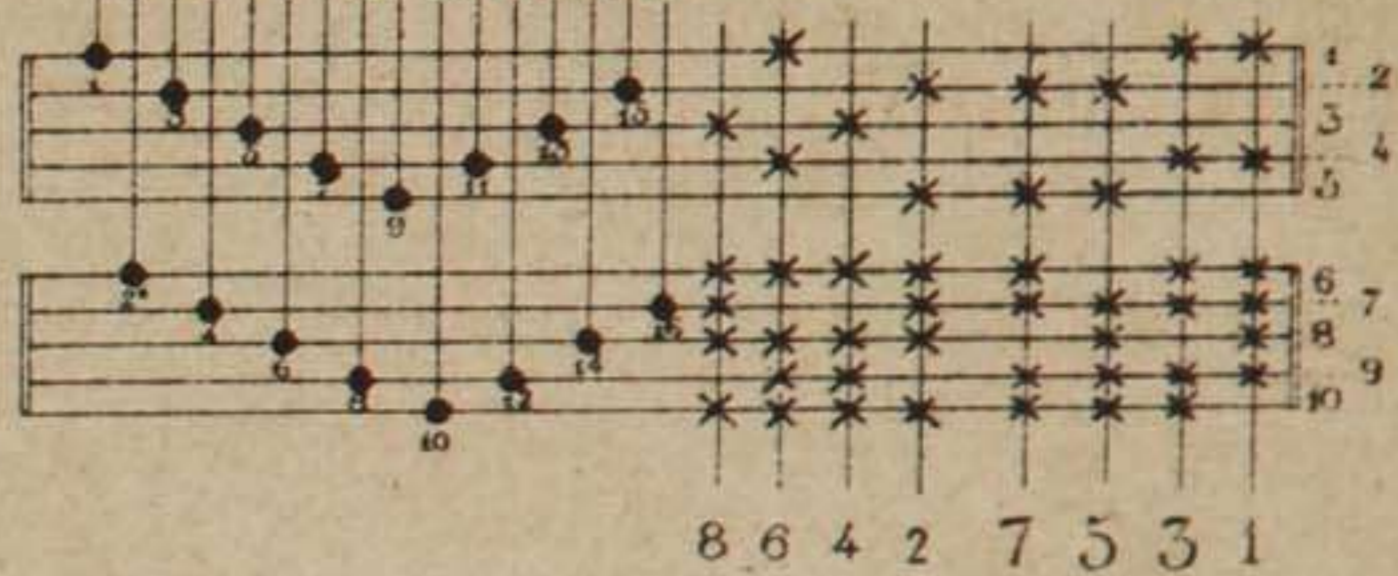


Fig. 140.



8 6 4 2 7 5 3 1

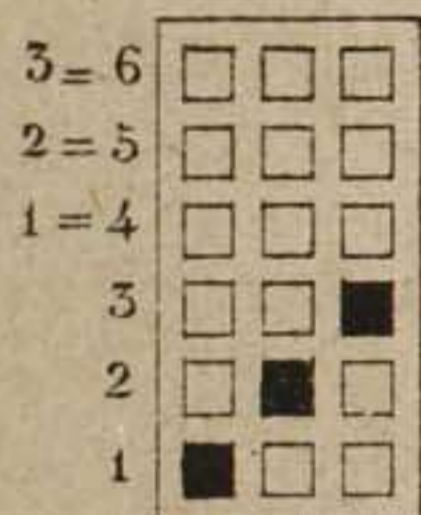
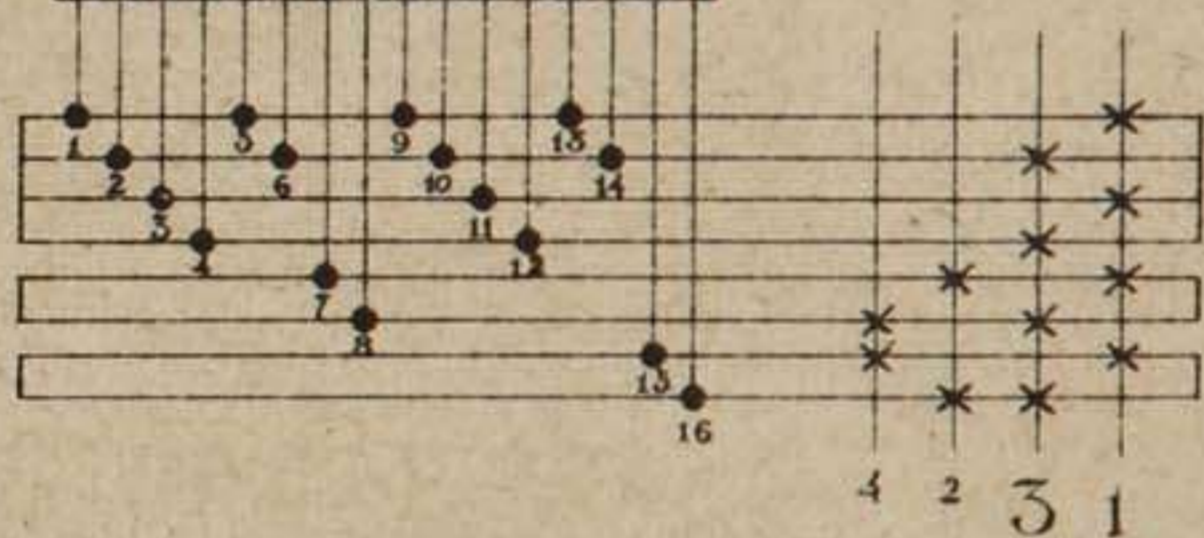


Fig. 135.



4 2 3 1

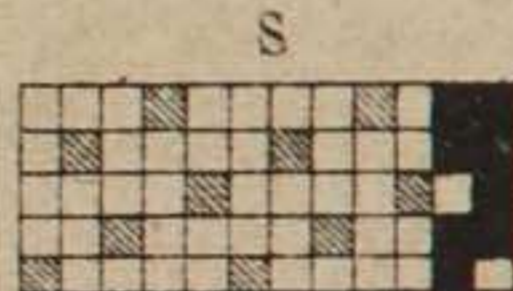


Fig. 134.



9 7

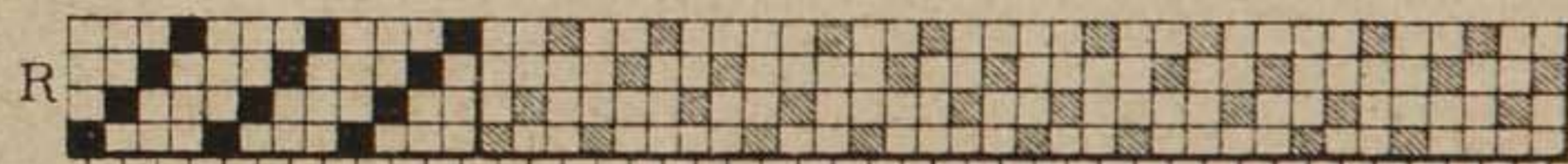
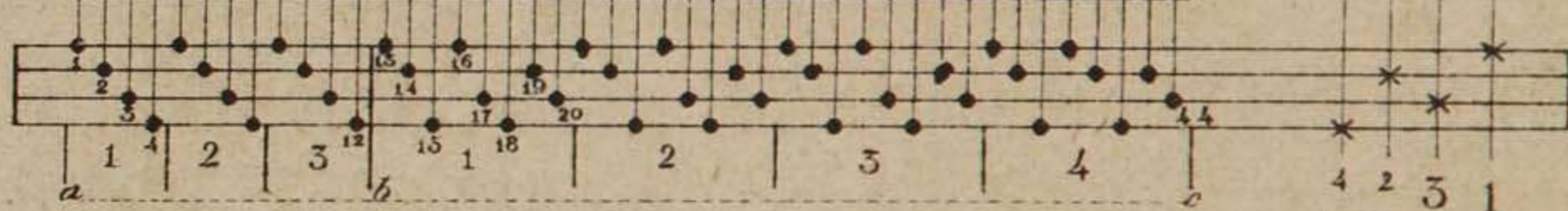
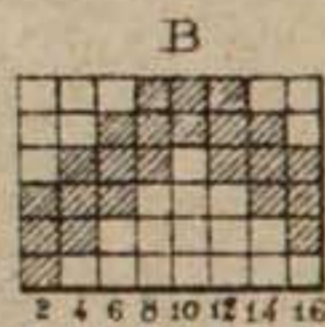
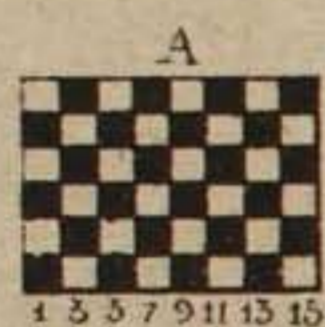


Fig. 136.

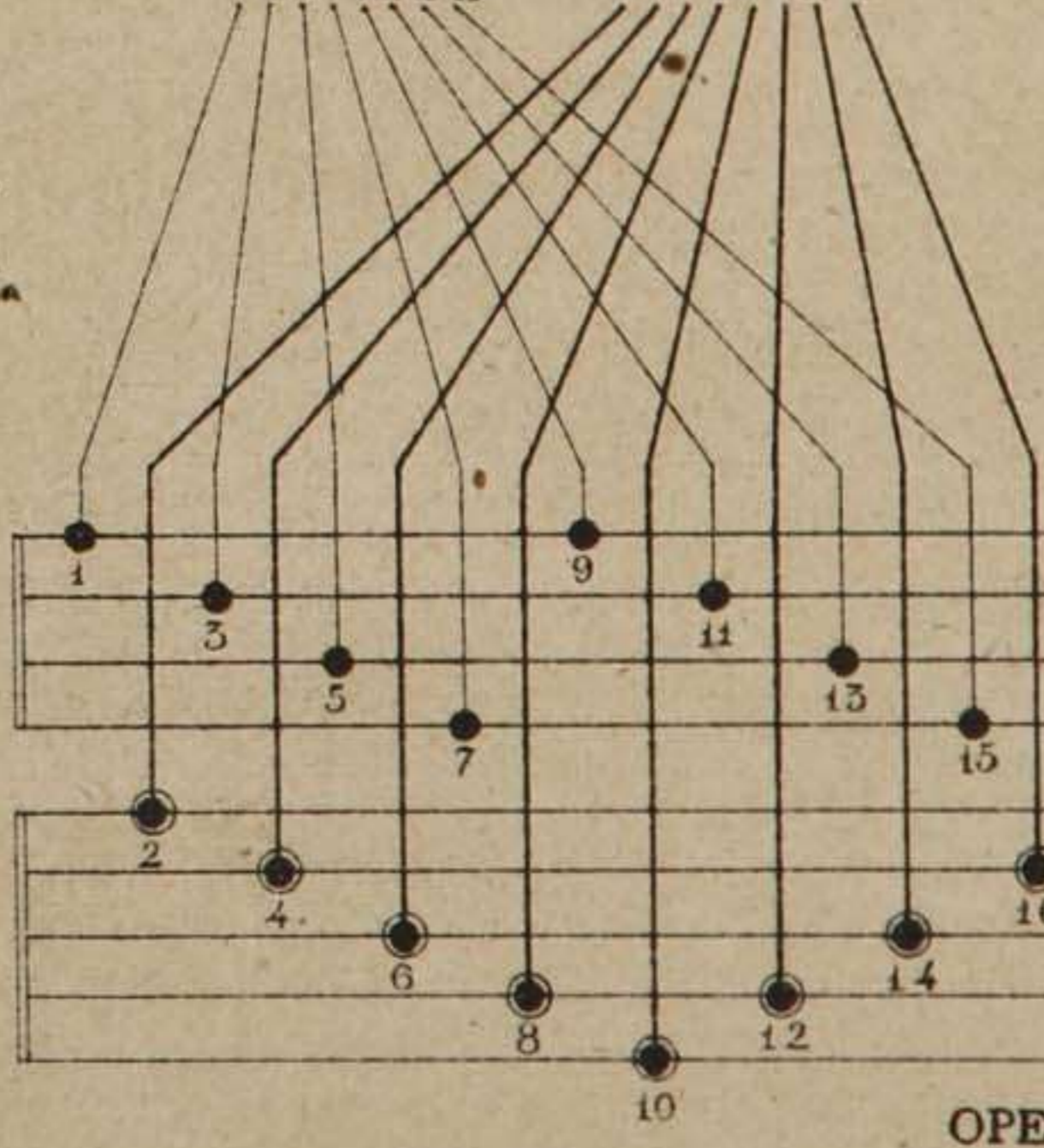


1 4 2 3 12 15 1 18 2 3 4 4 4 2 3 1



Varios remetidos à 2 Cuerpos.

Fig. 137.



OPERARIO.

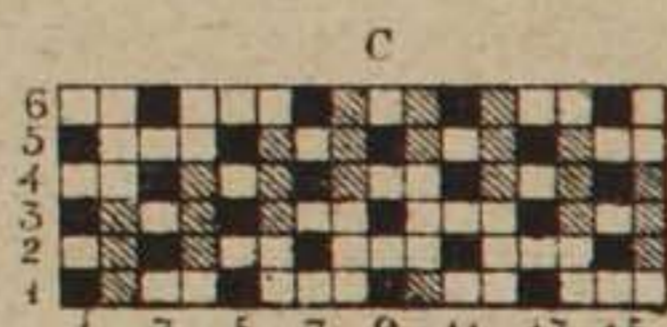
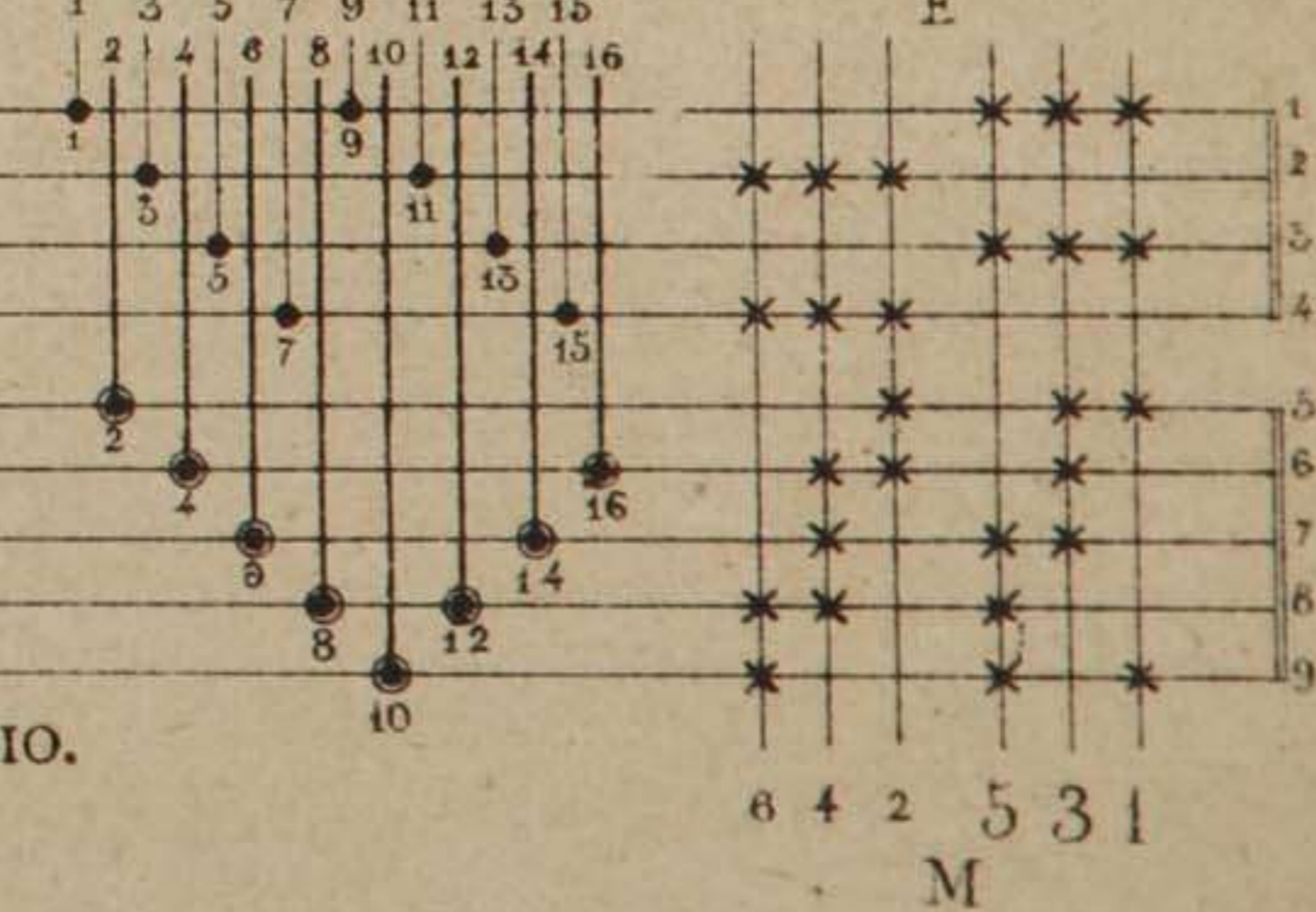


Fig. 138.



8 4 2 5 3 1

M

Fig. 139.

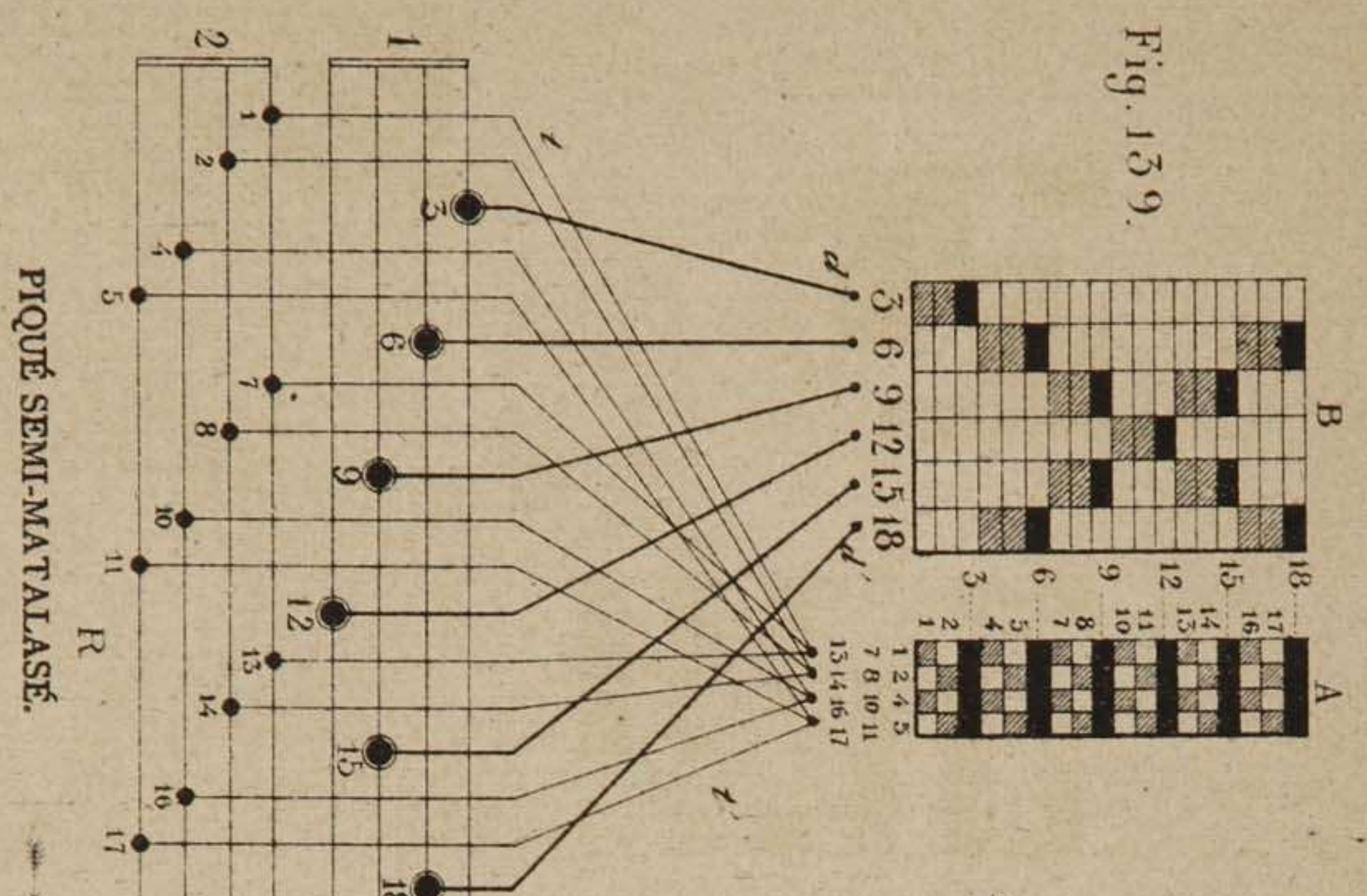


Fig. 142.

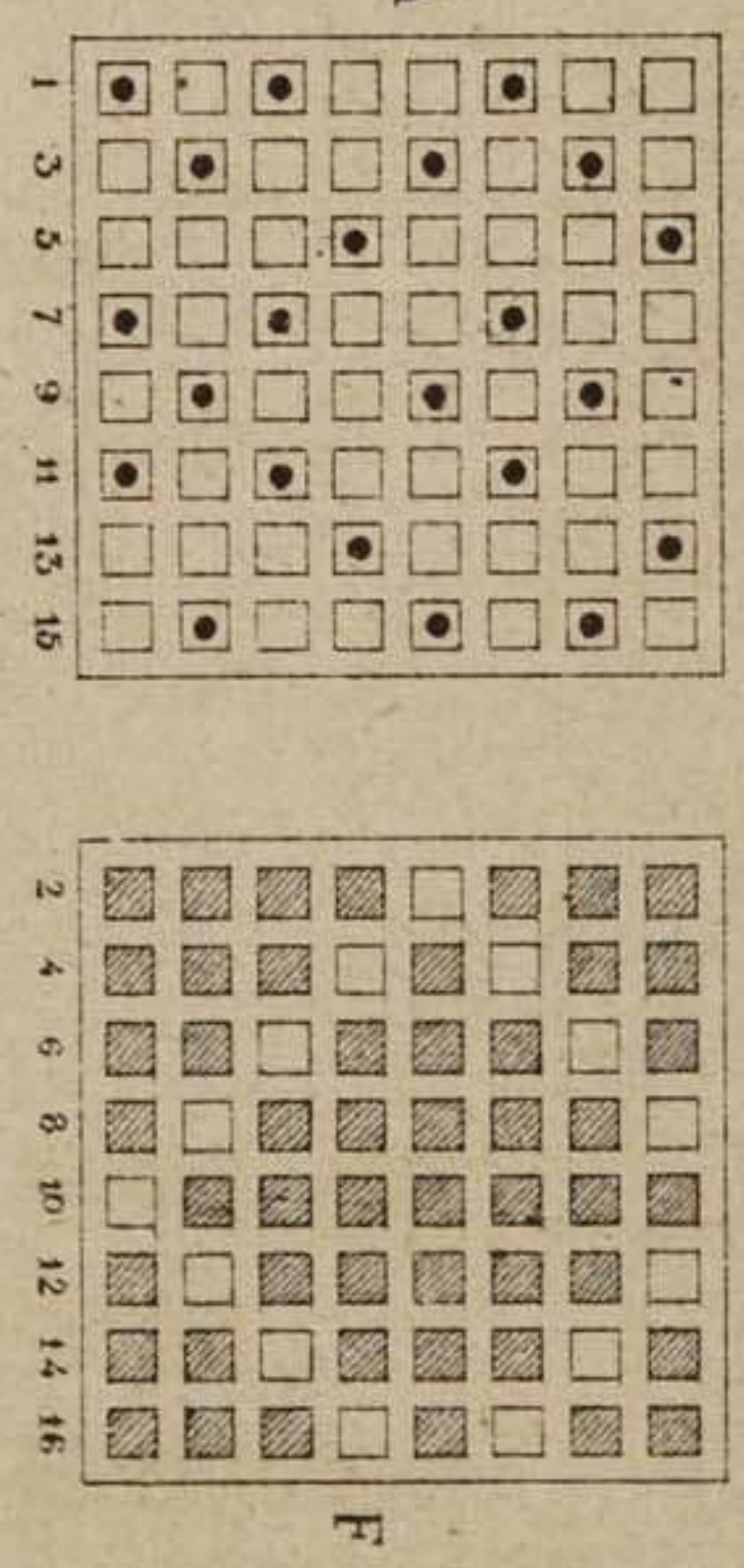


Fig. 143.

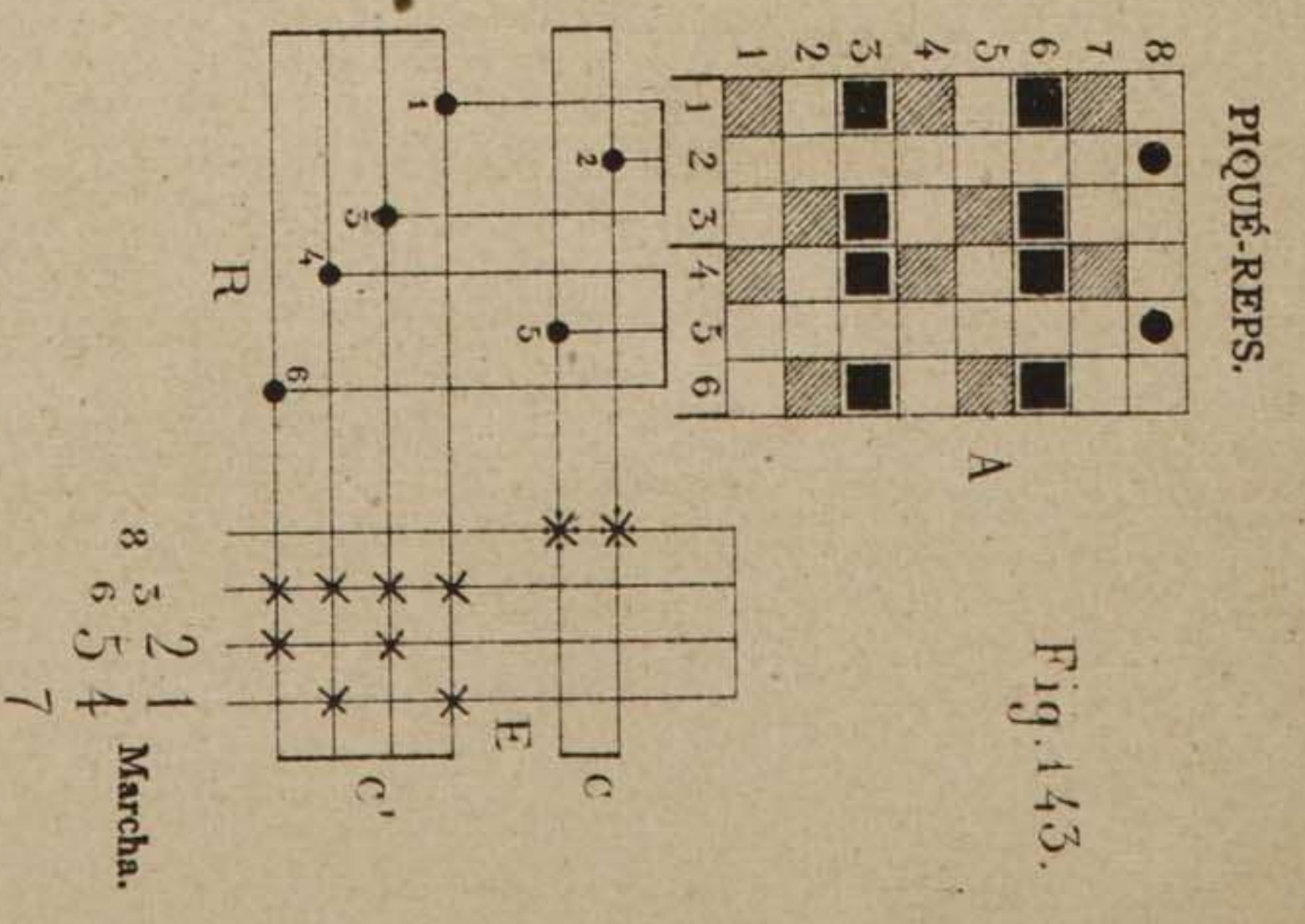


Fig. 144.

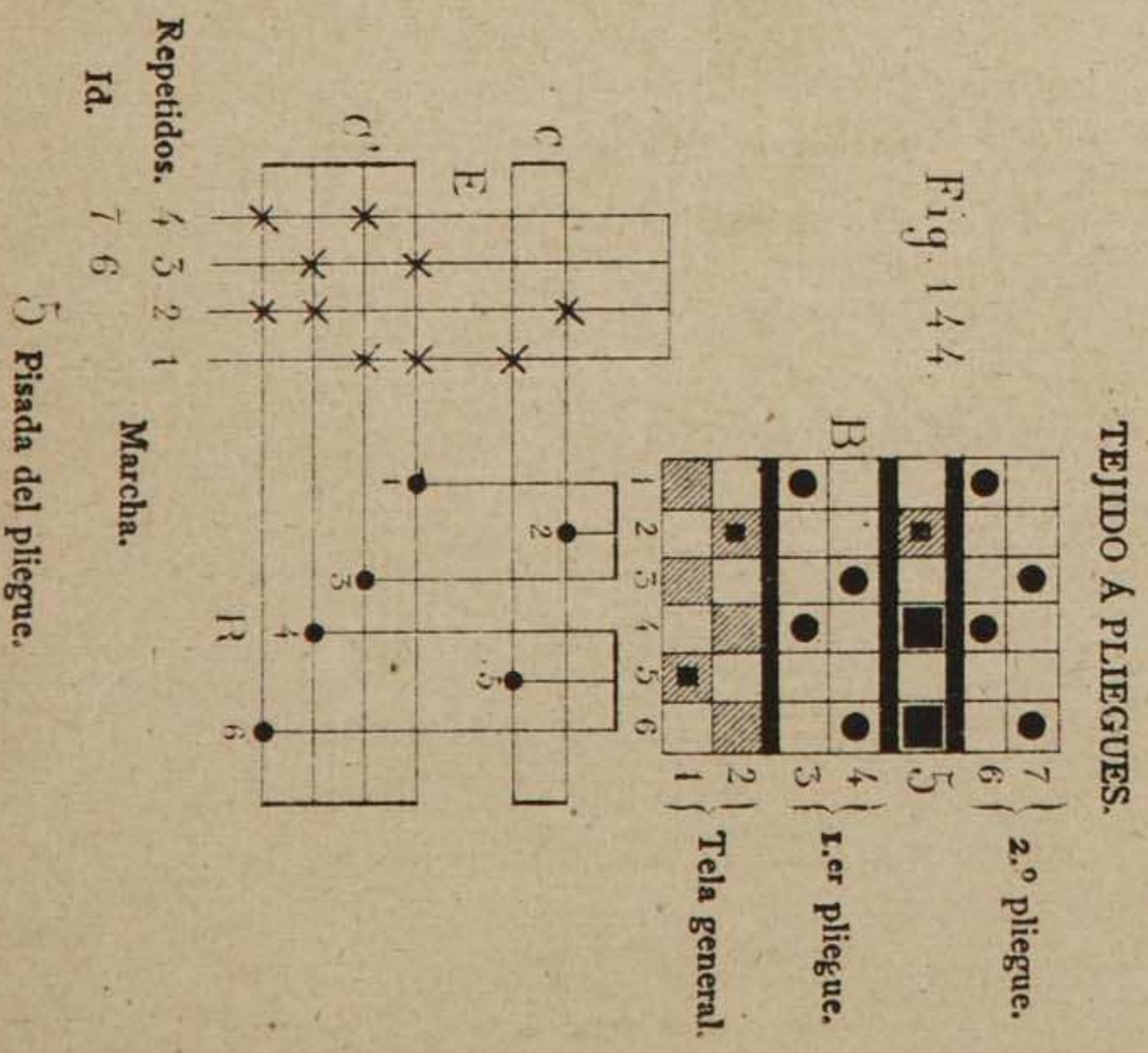
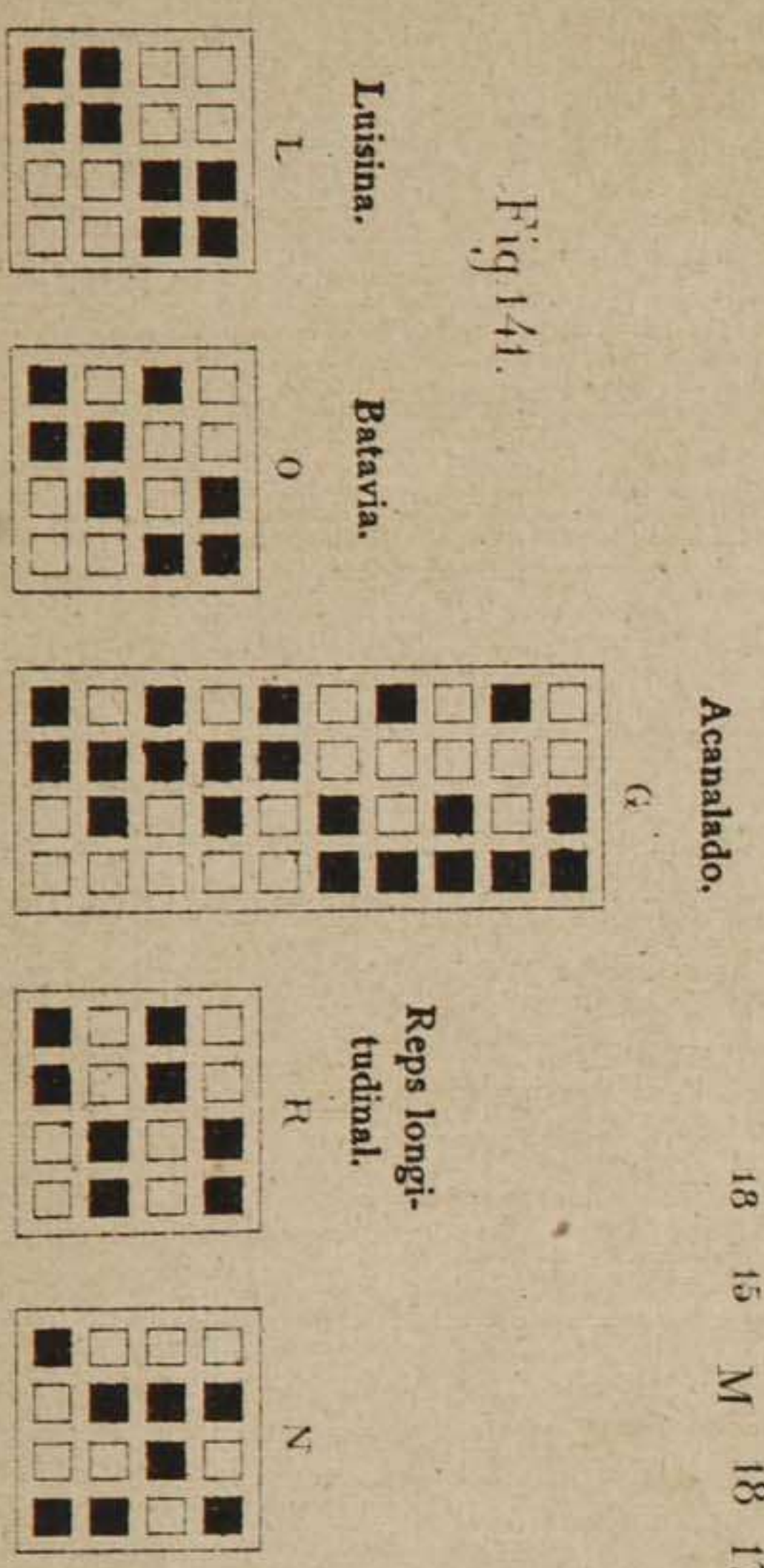


Fig. 141.



DISEÑO.

LIGAMIENTO.

Fig.146.

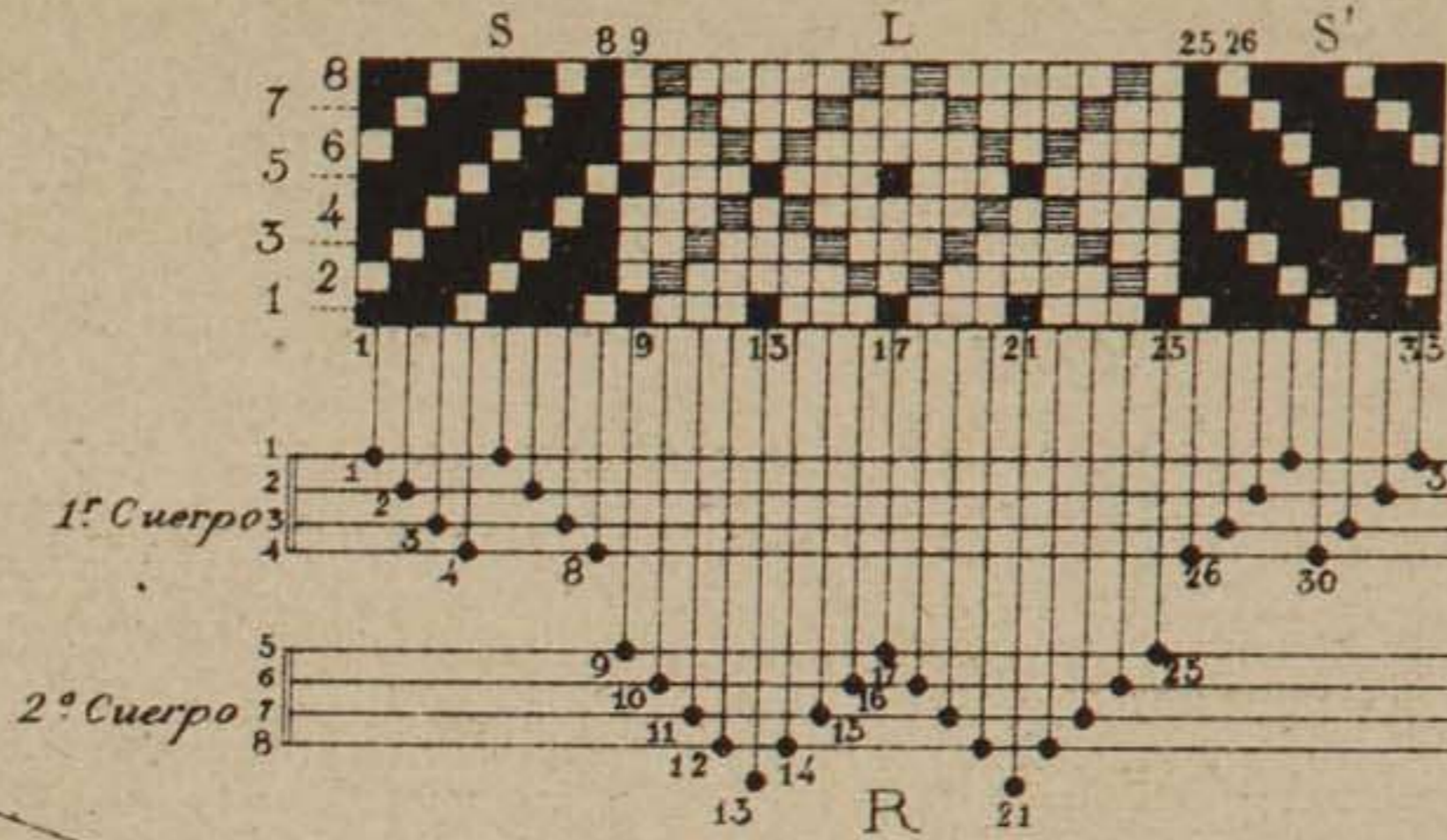
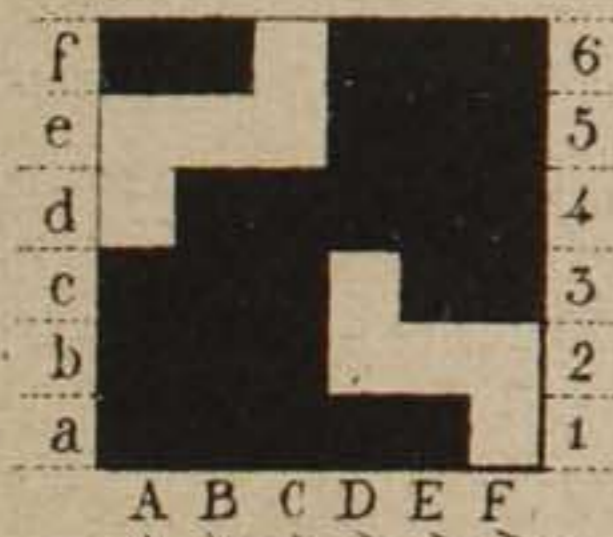


Fig.145.

Fig.148.

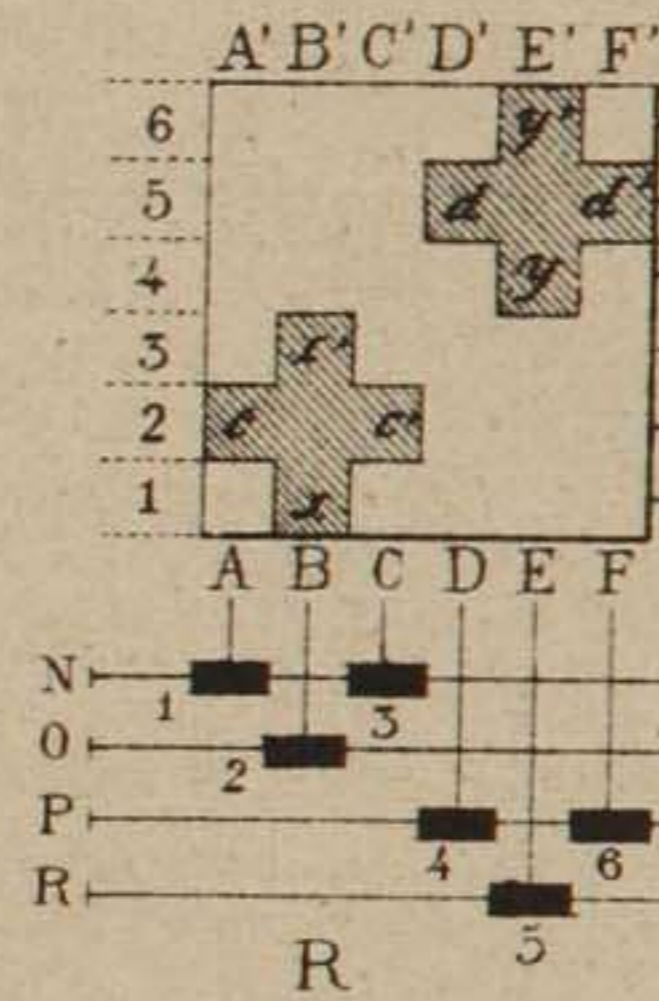
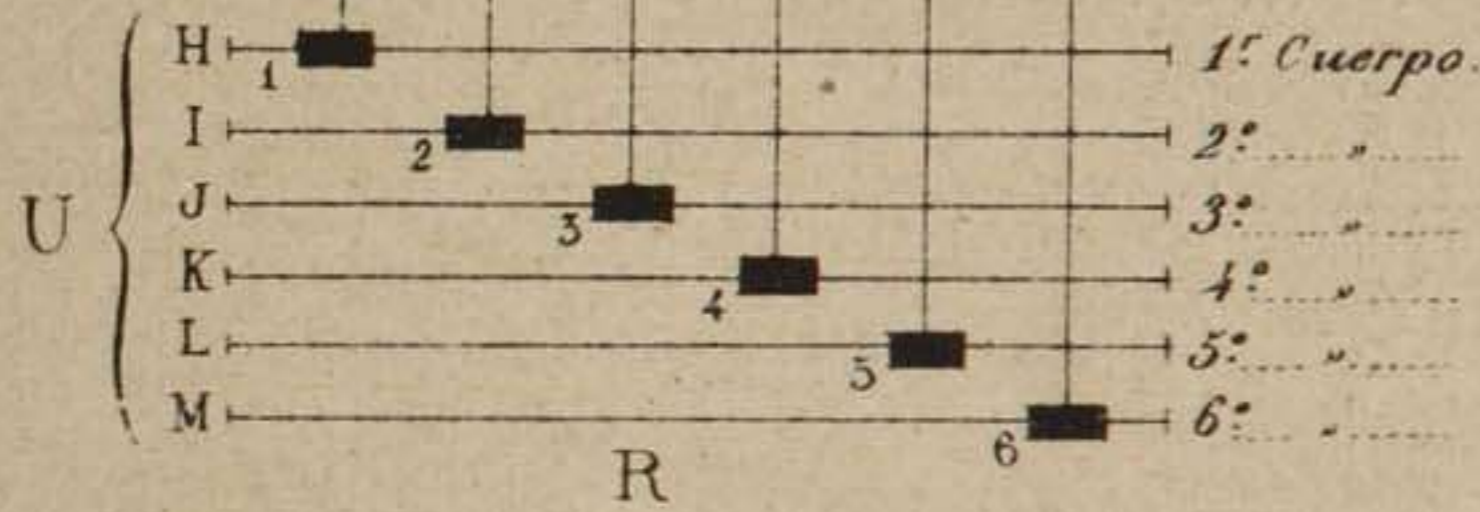
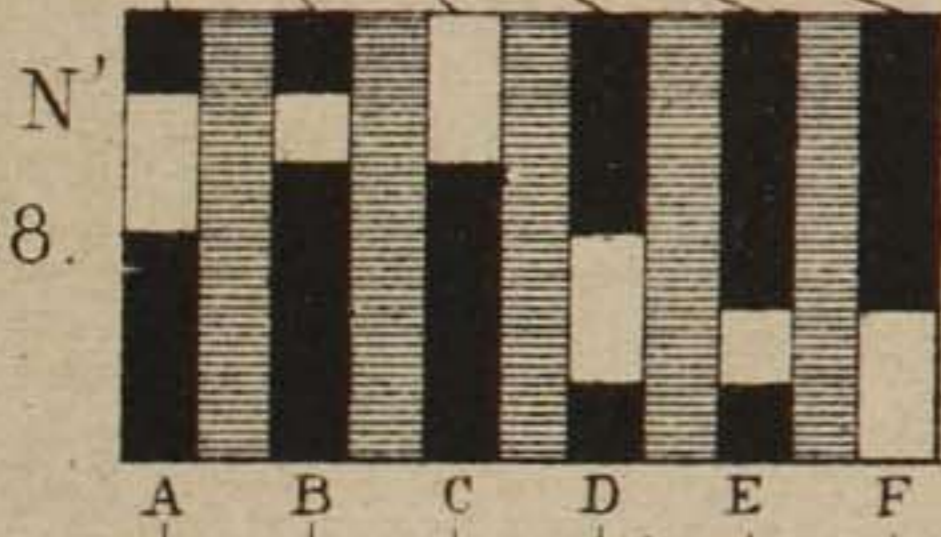


Fig.147.

Fig.151.

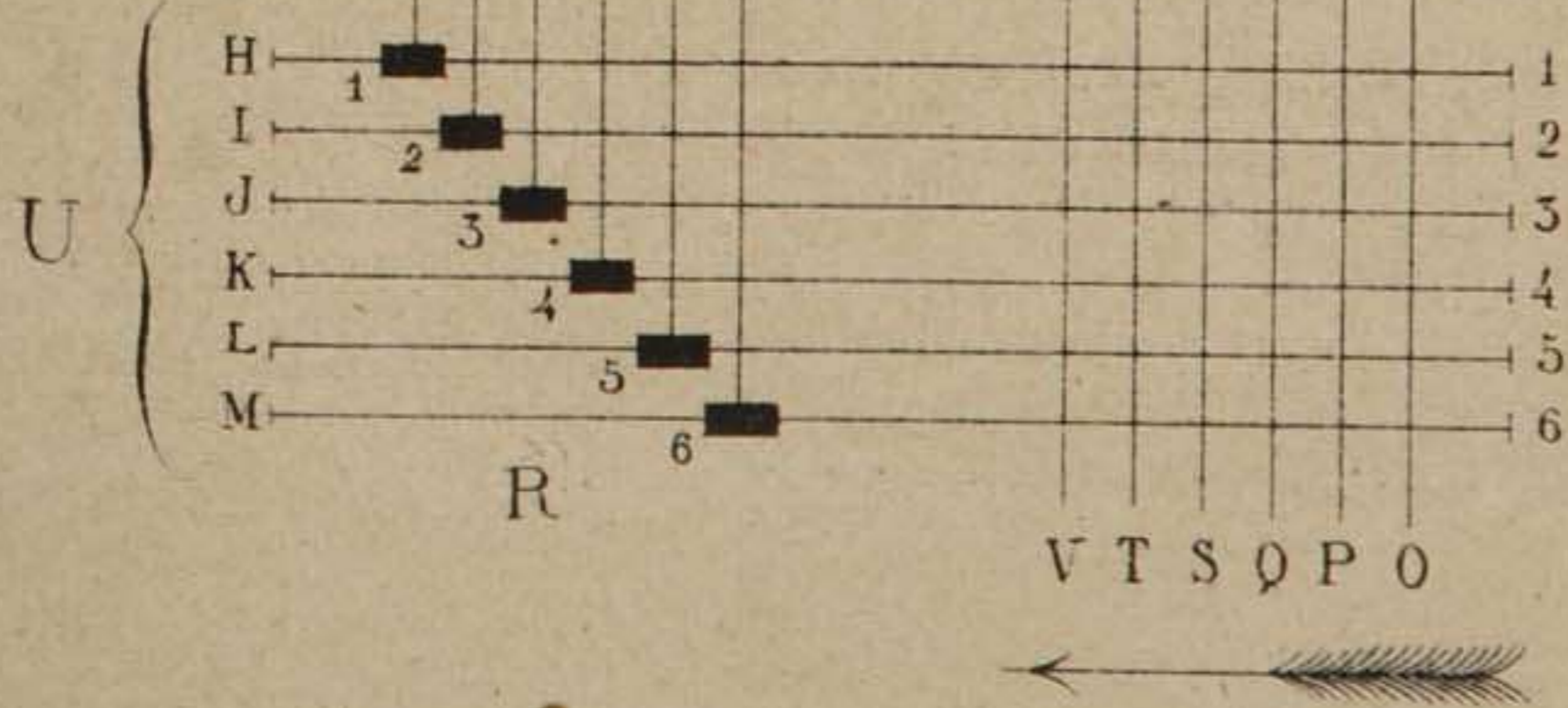
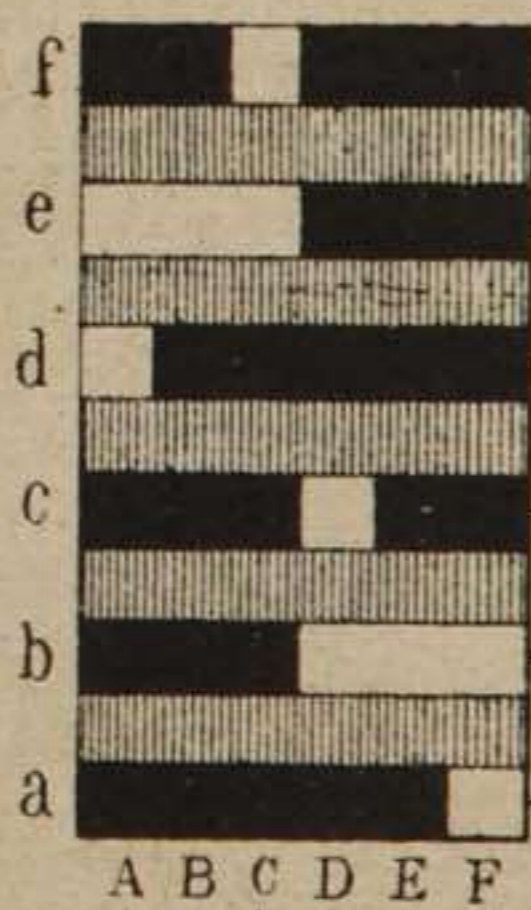
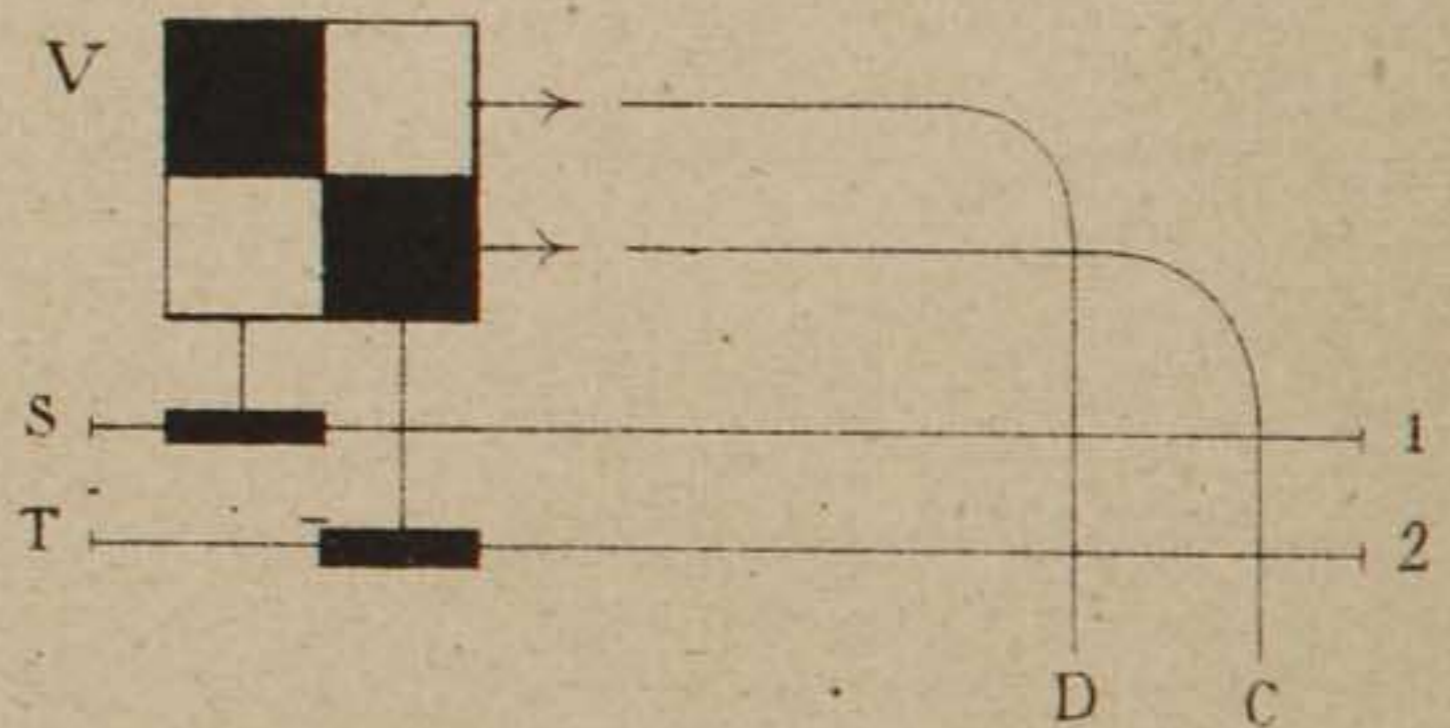
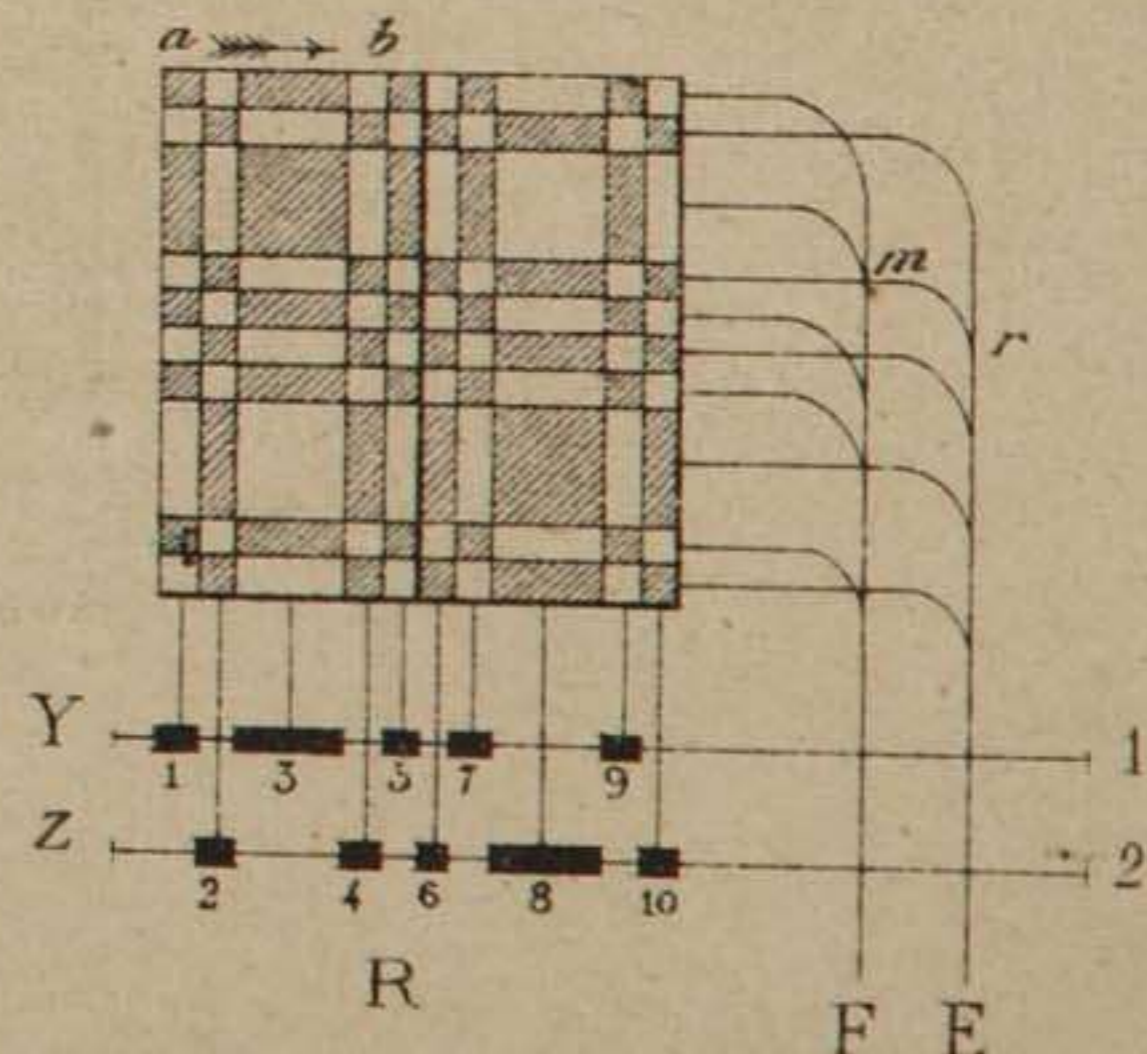


Fig.149.



x Fig.150.



PUESTA EN CARTA V'.

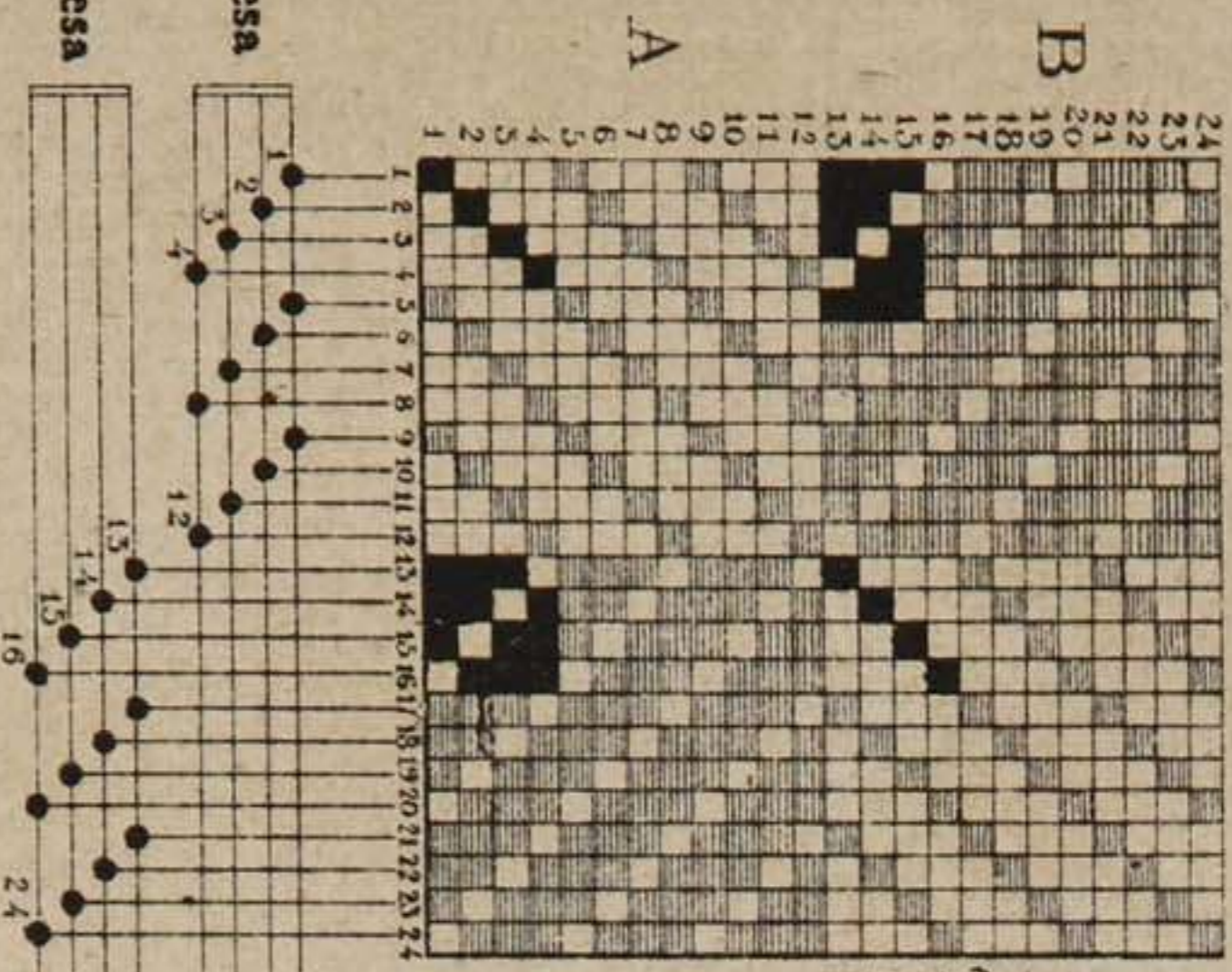
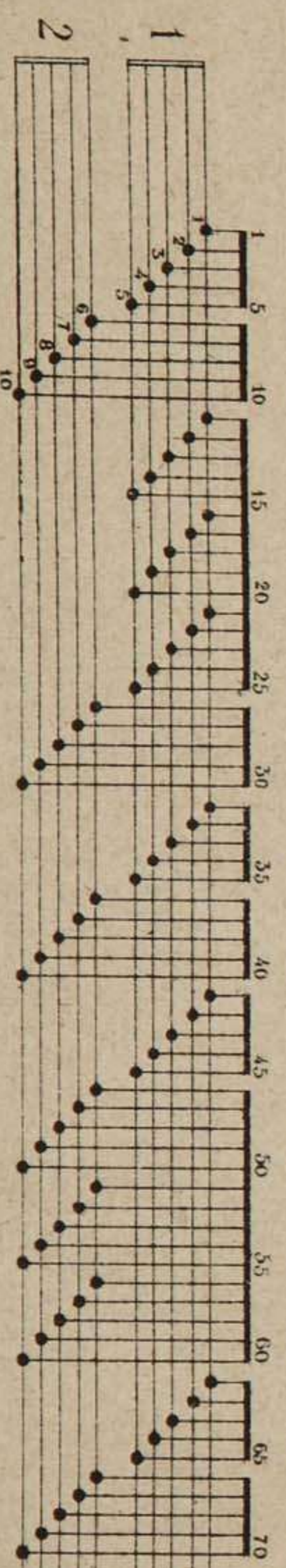
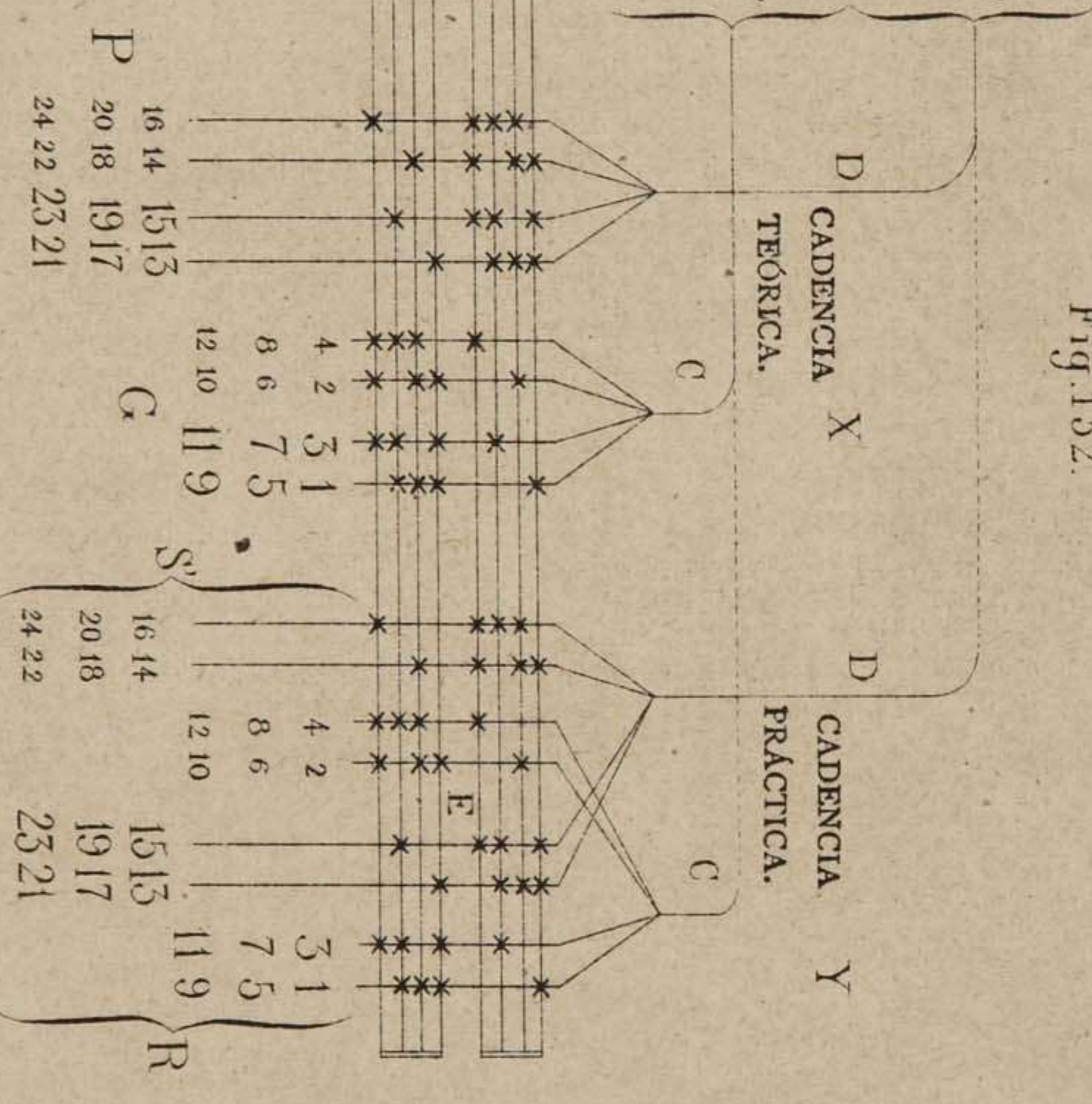


Fig. 152.



REMETIDO DEL CROQUIS X.

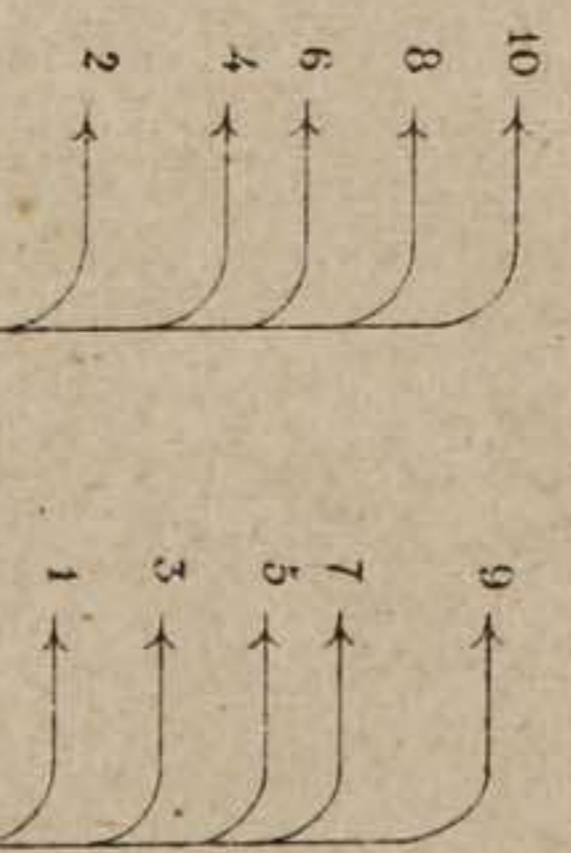


Fig. 153.

VÉASE EL CROQUIS X.—Fig. 150.

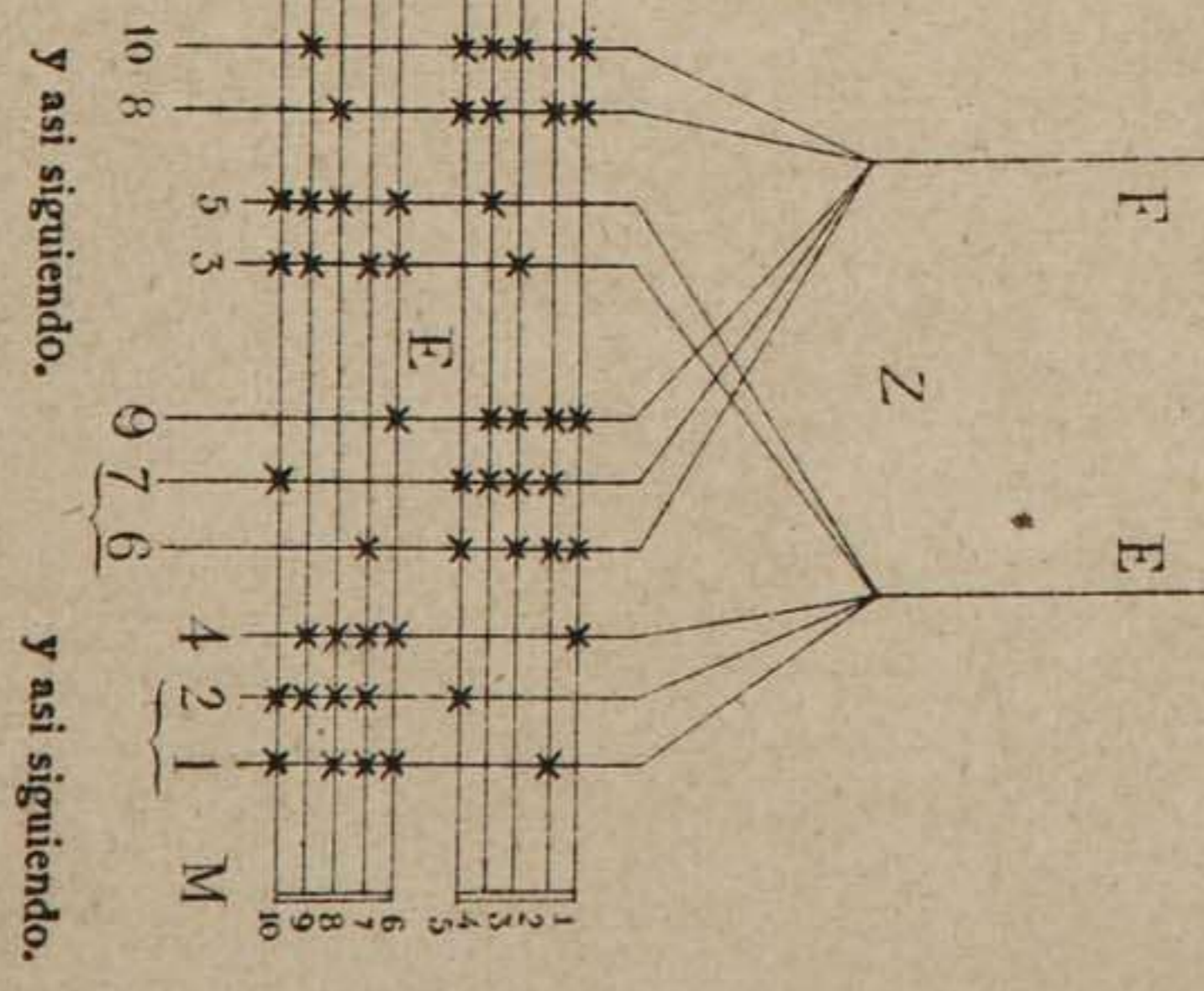


Fig. 154.

PUESTO EN CARTA X'.

Solo para 35 hilos de urdimbre.

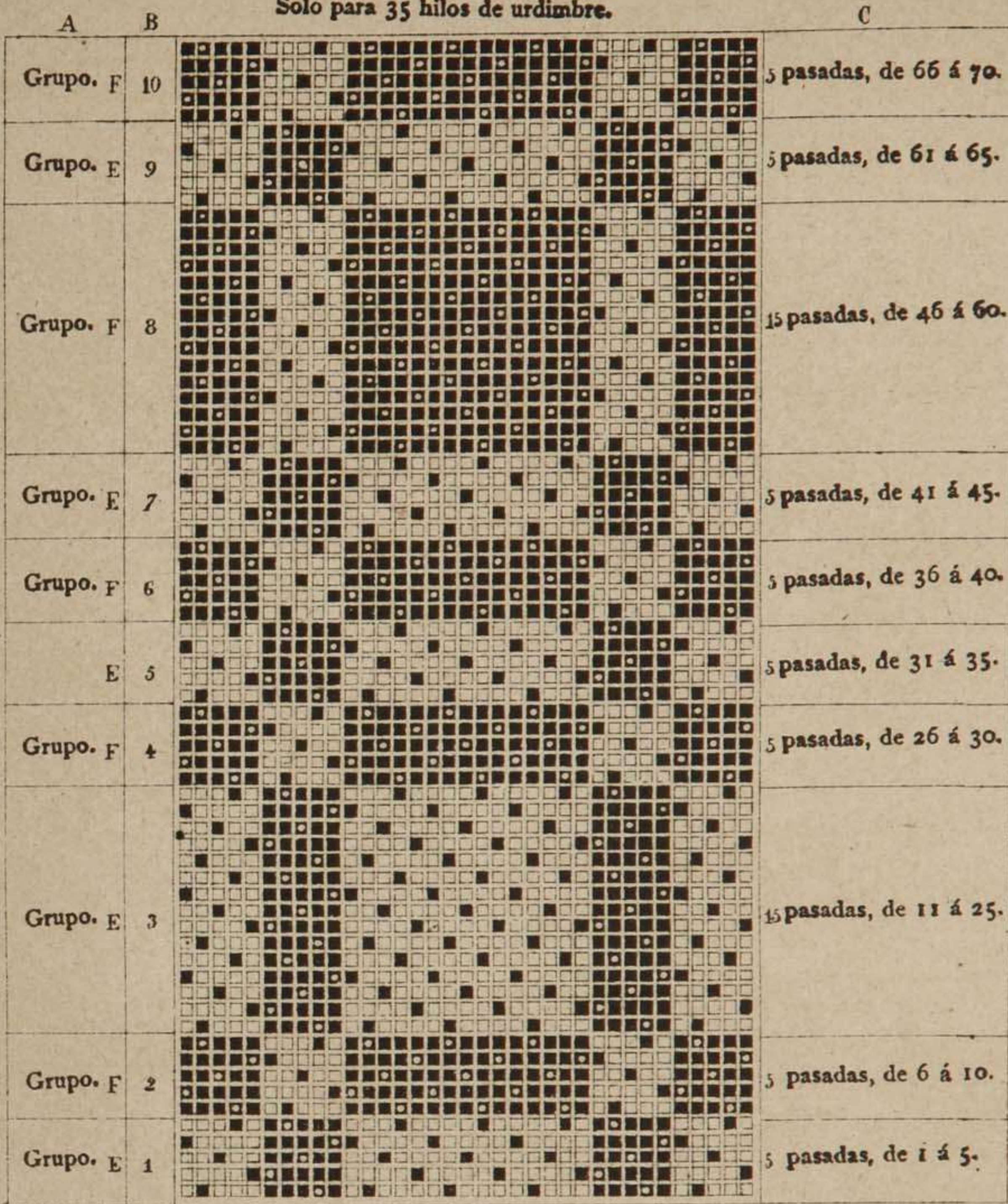


Fig. 156.

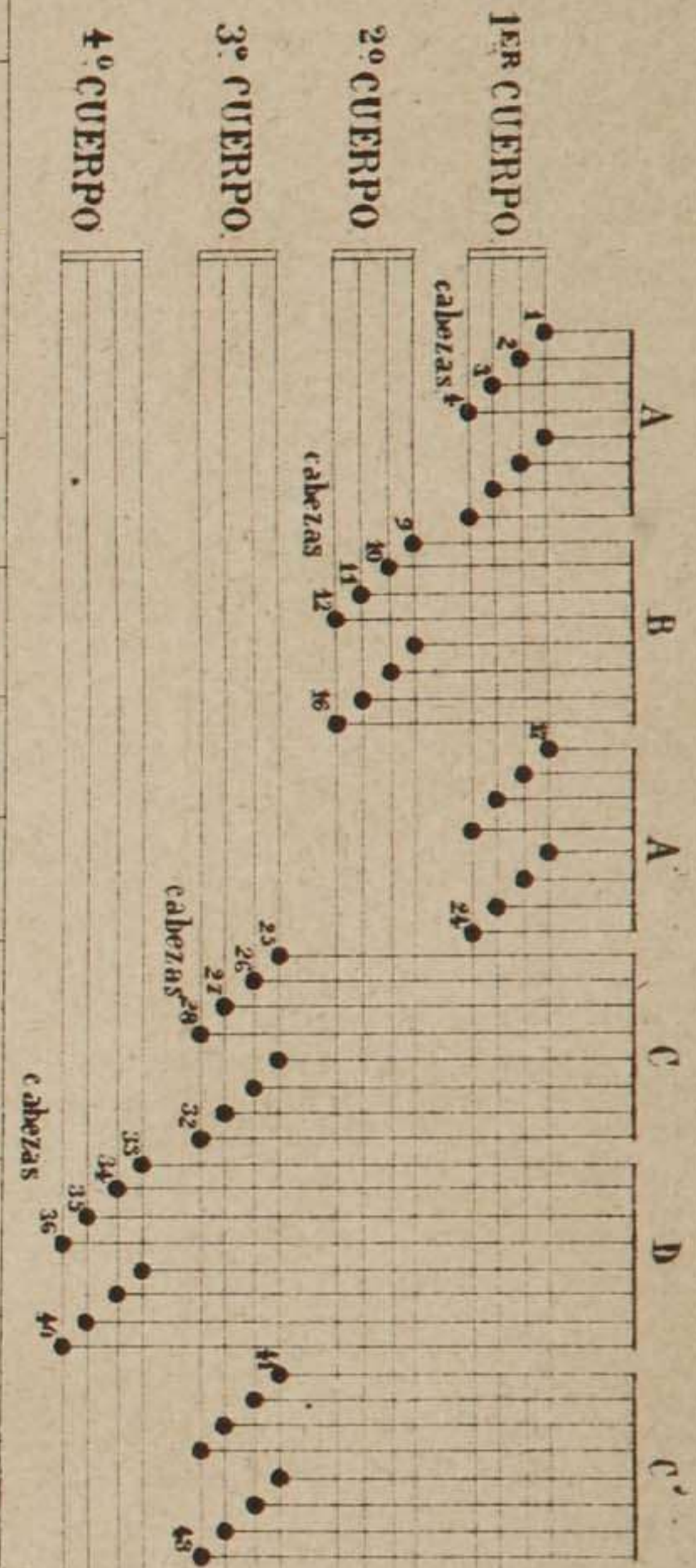


Fig. 155.

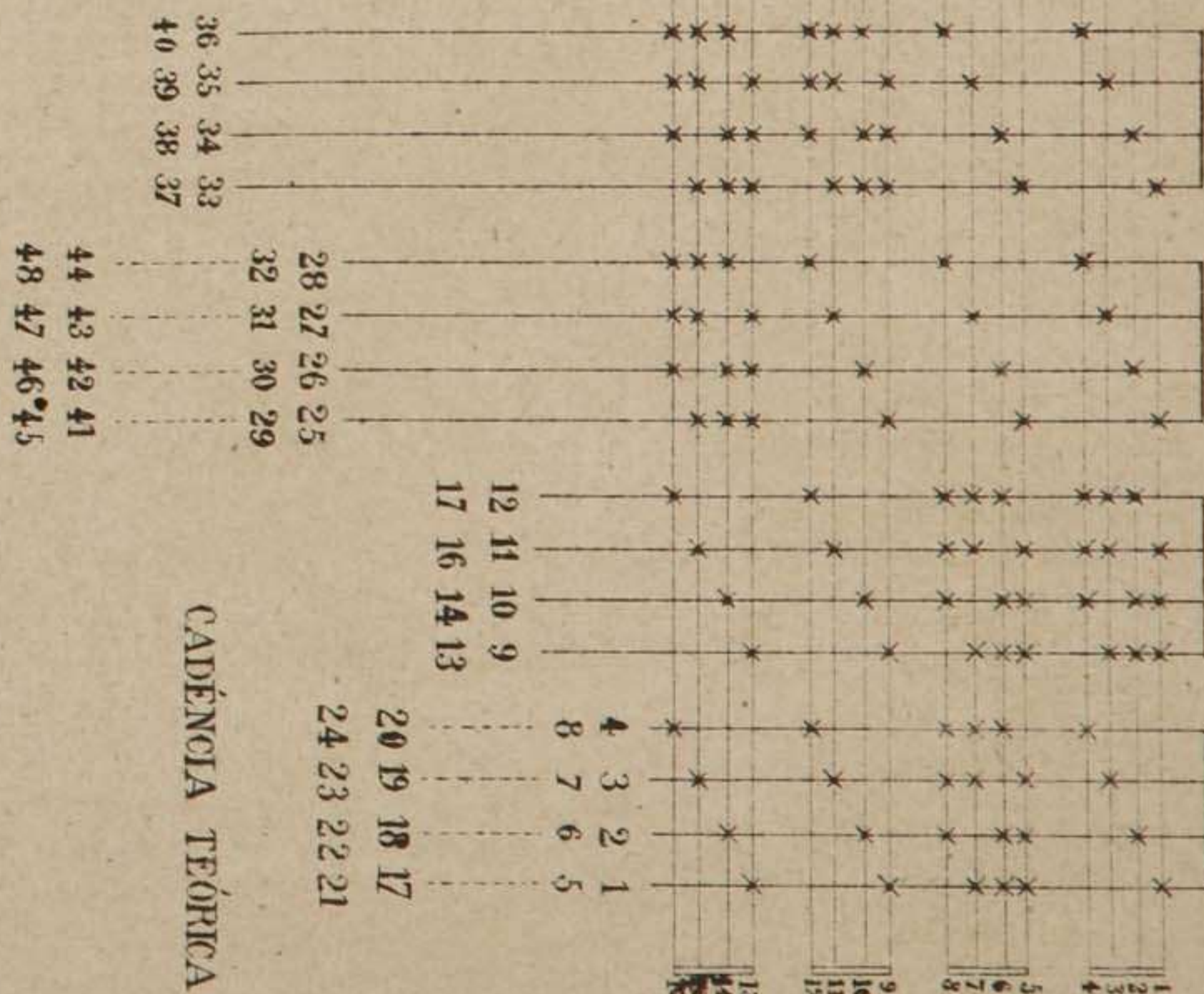
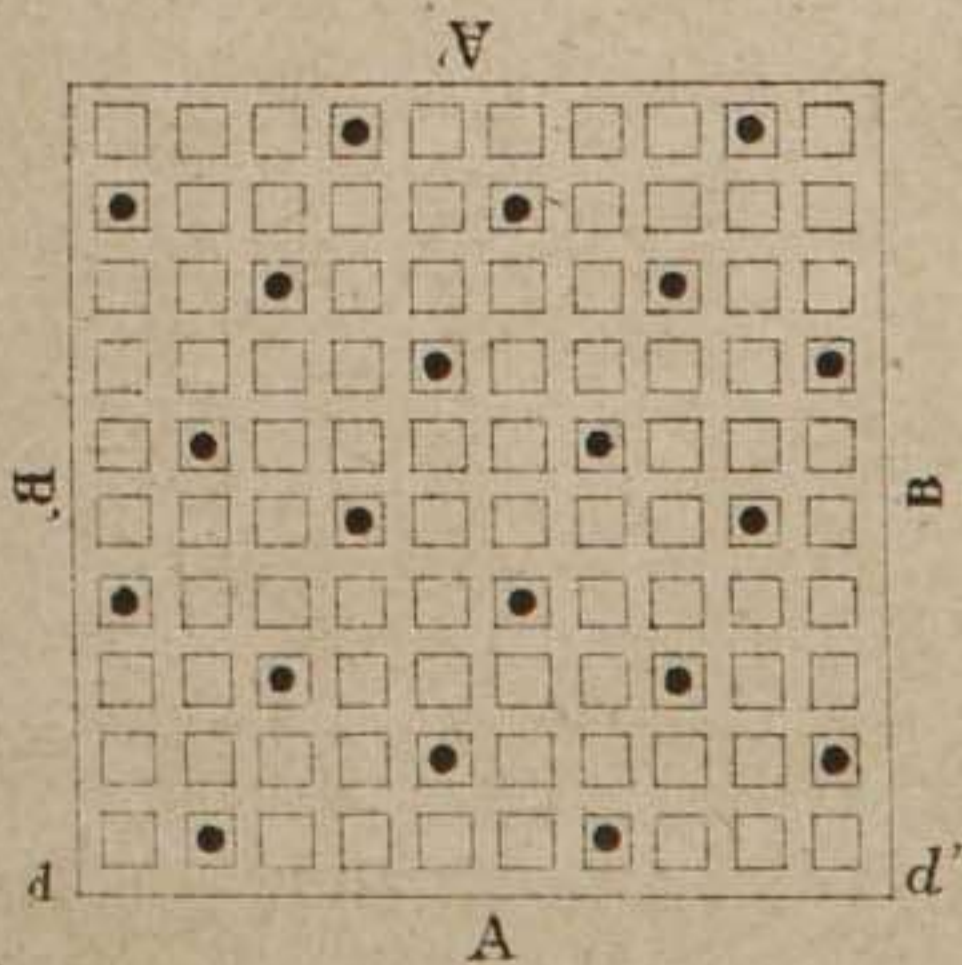


Fig. 157.
PUESTA EN CARTA J.
DEL DISEÑO J. FIG. 147.

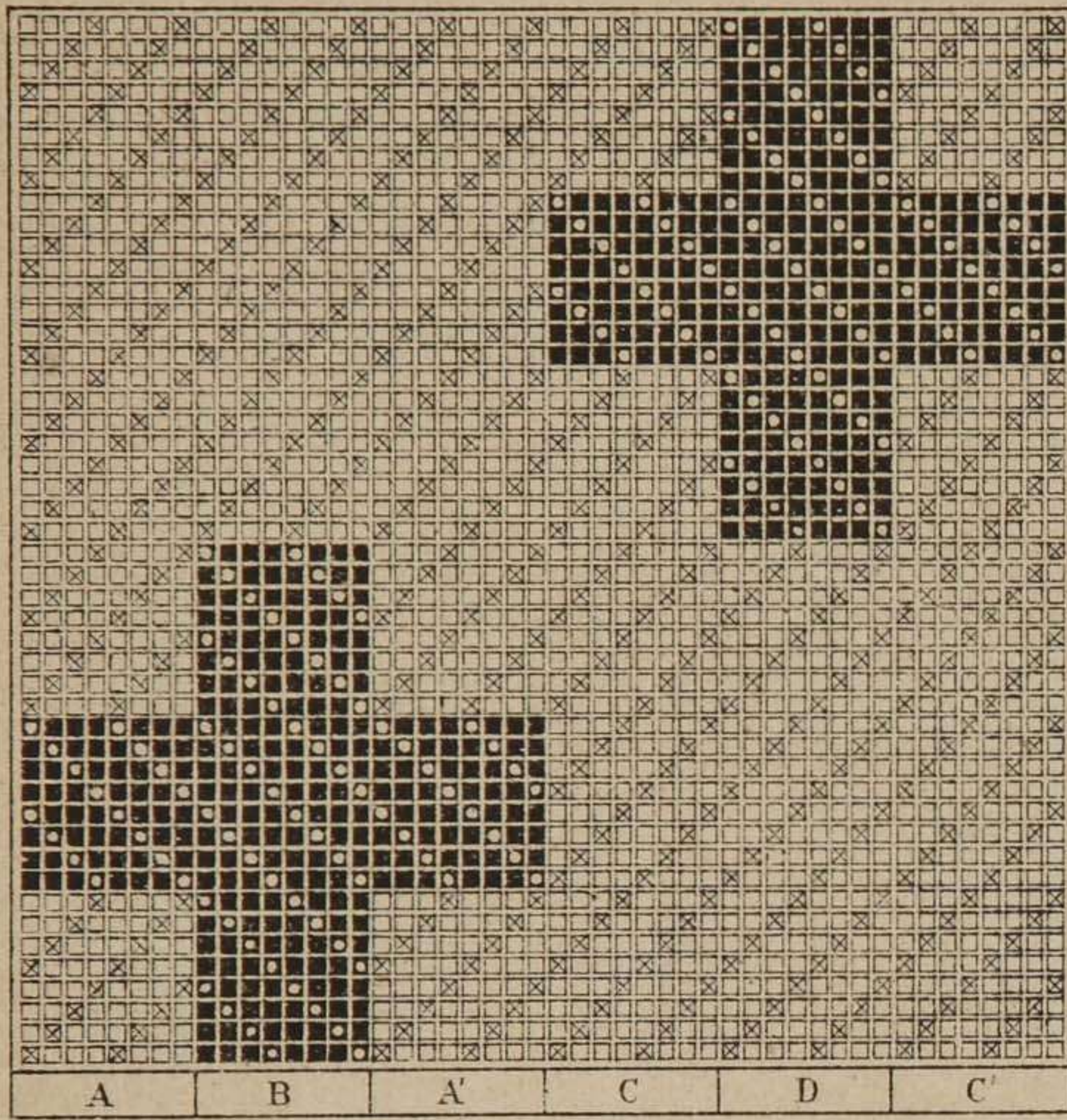


Fig. 162.

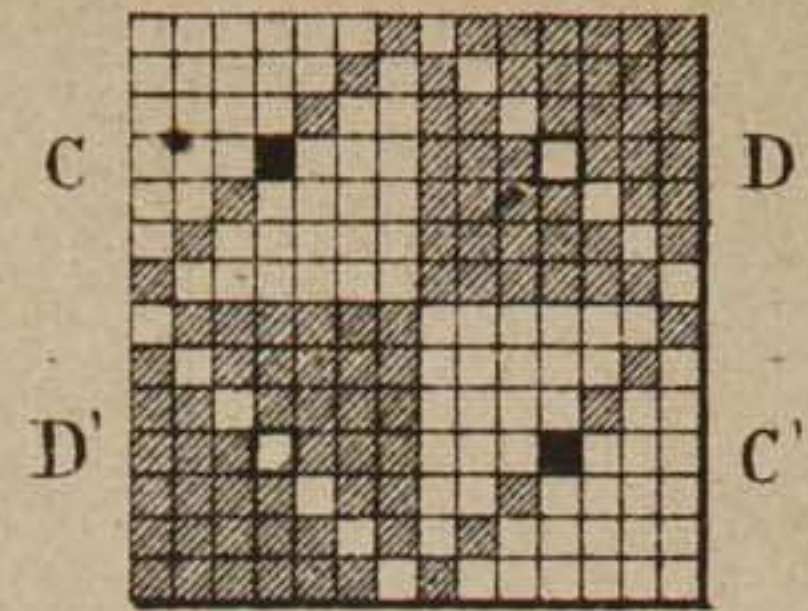


Fig. 165.

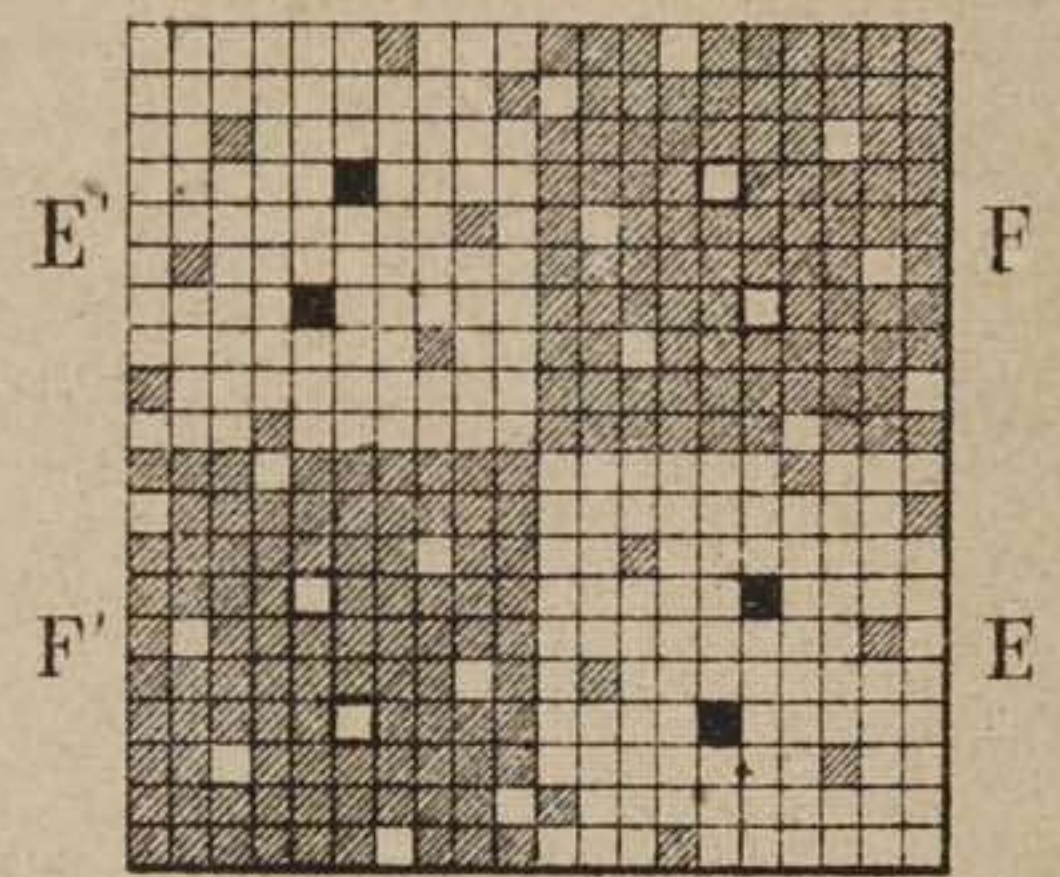


Fig. 164.

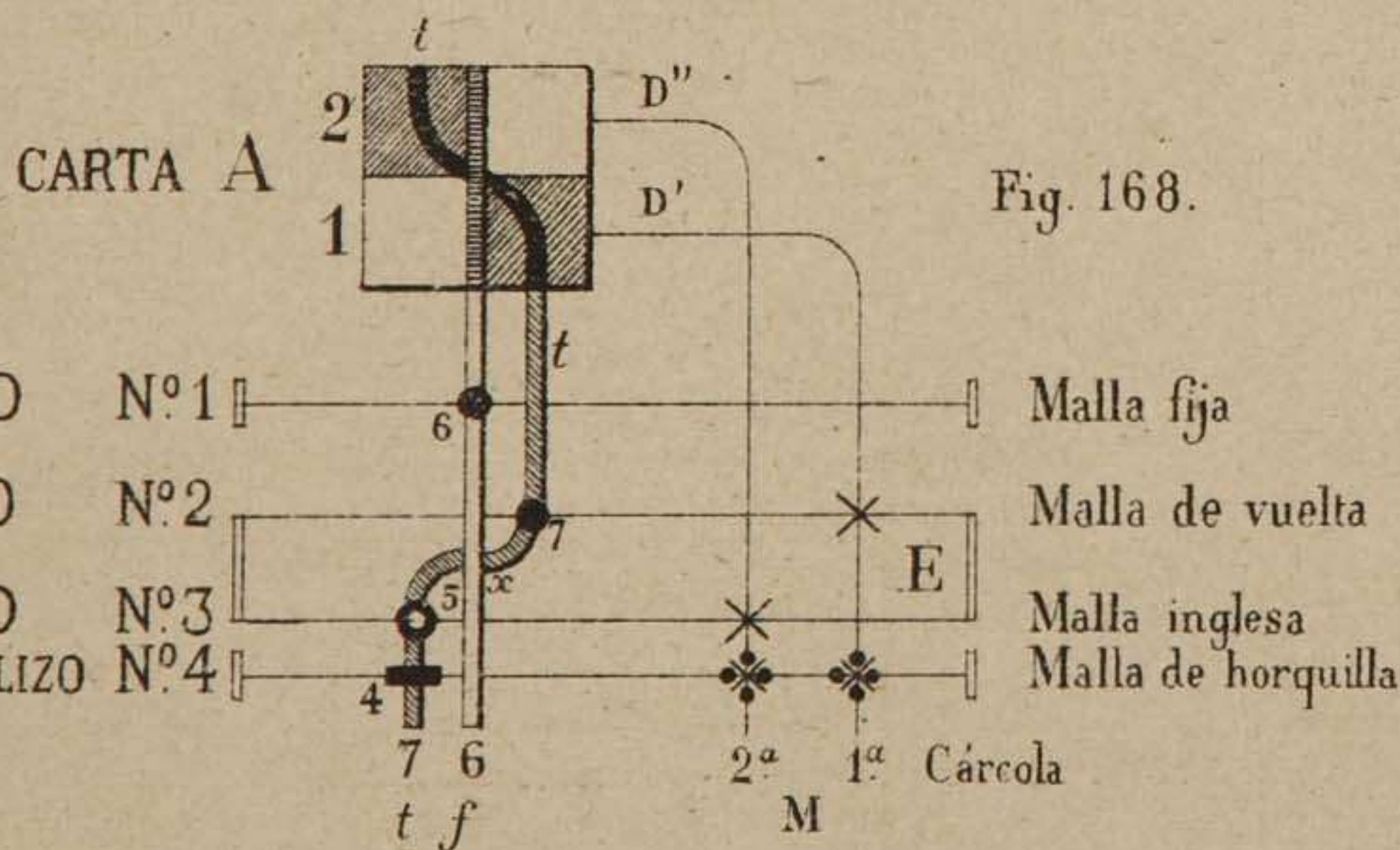
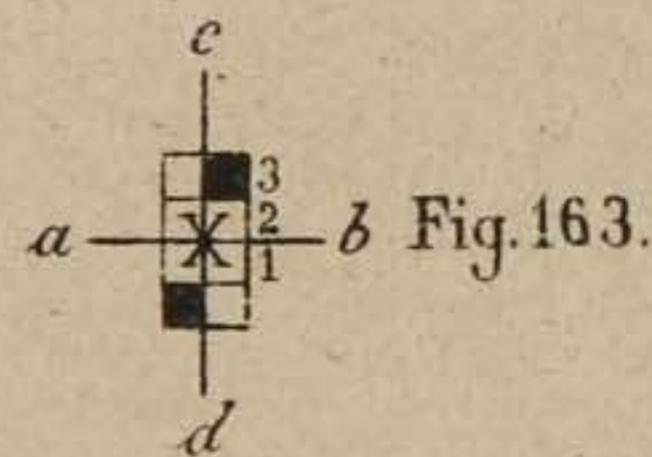
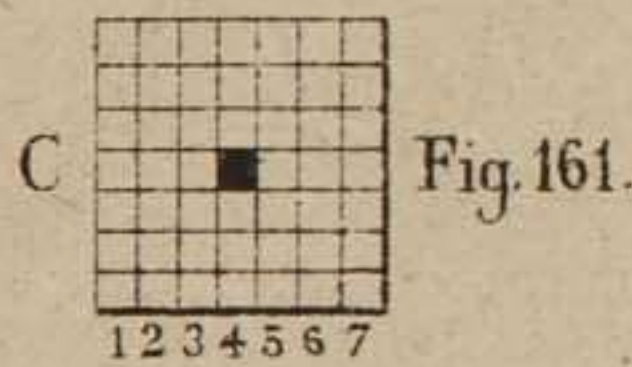
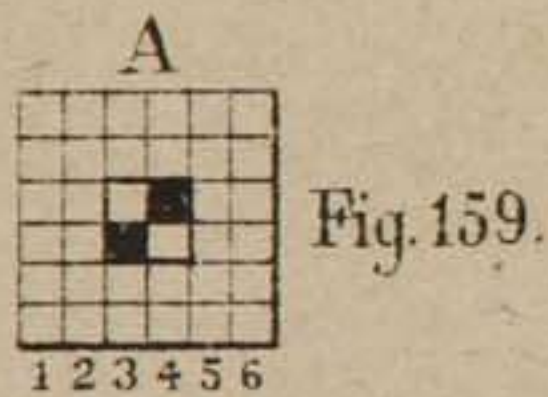
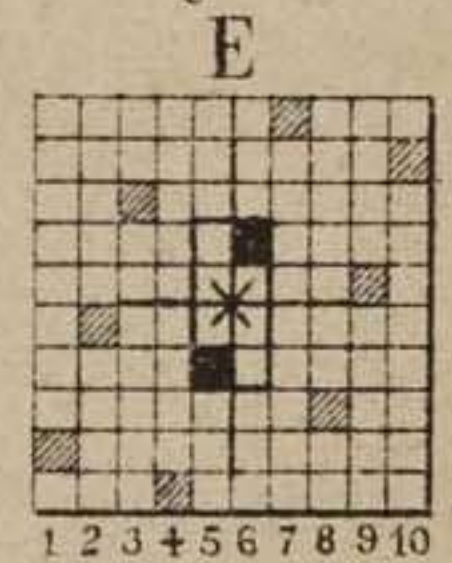


Fig. 160.

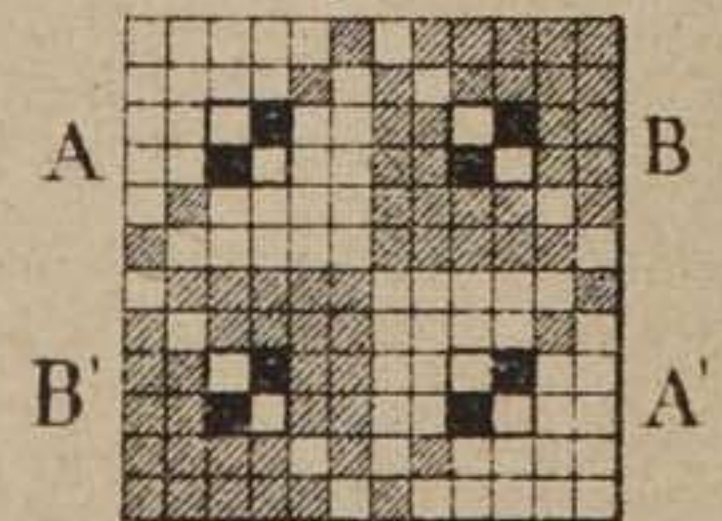


Fig. 167.

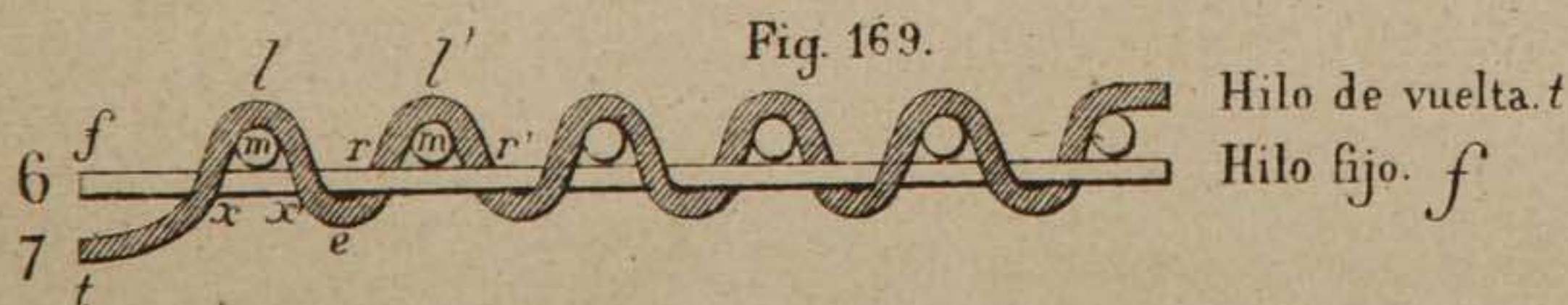
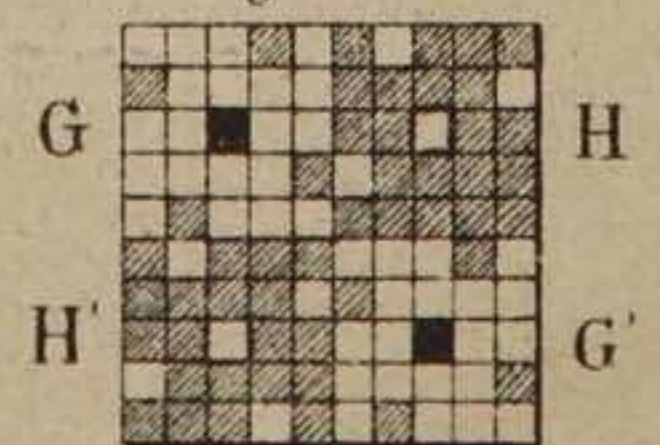


Fig. 166.



Fig. 174.

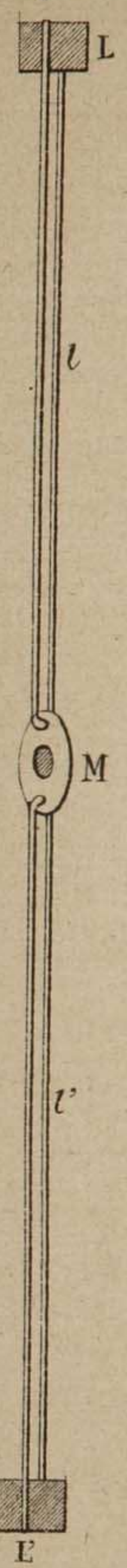


Fig. 173.

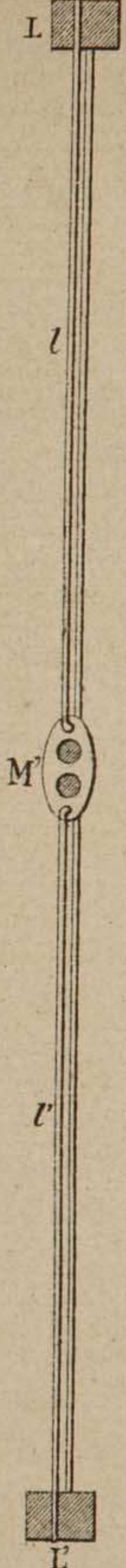


Fig. 172.

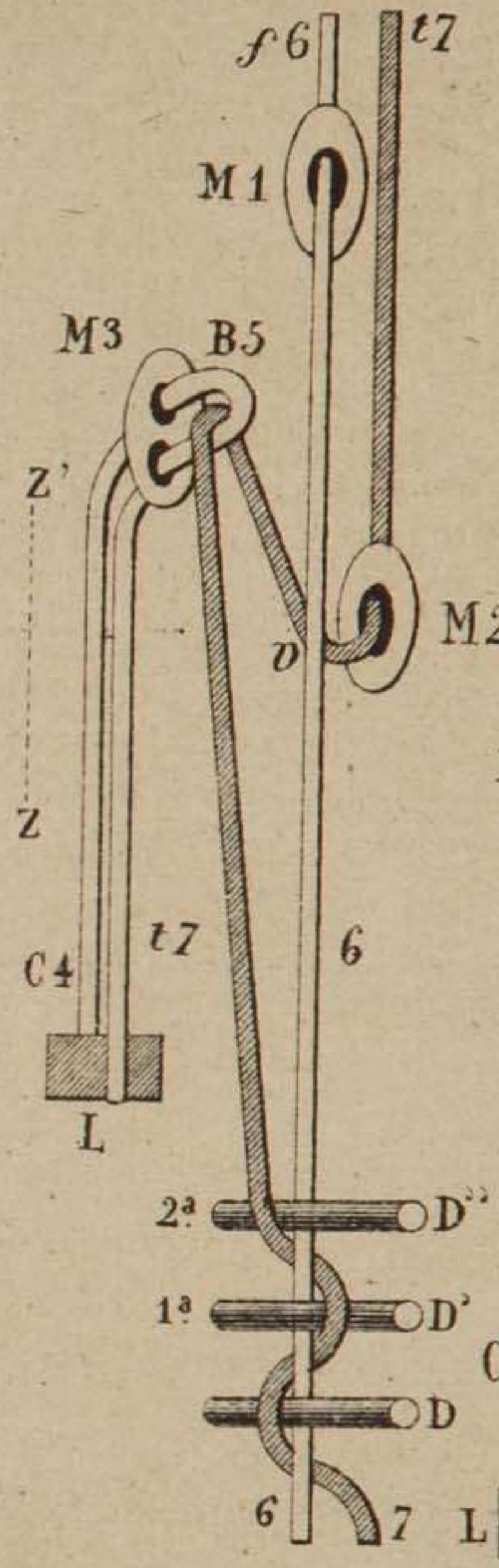


Fig. 170.

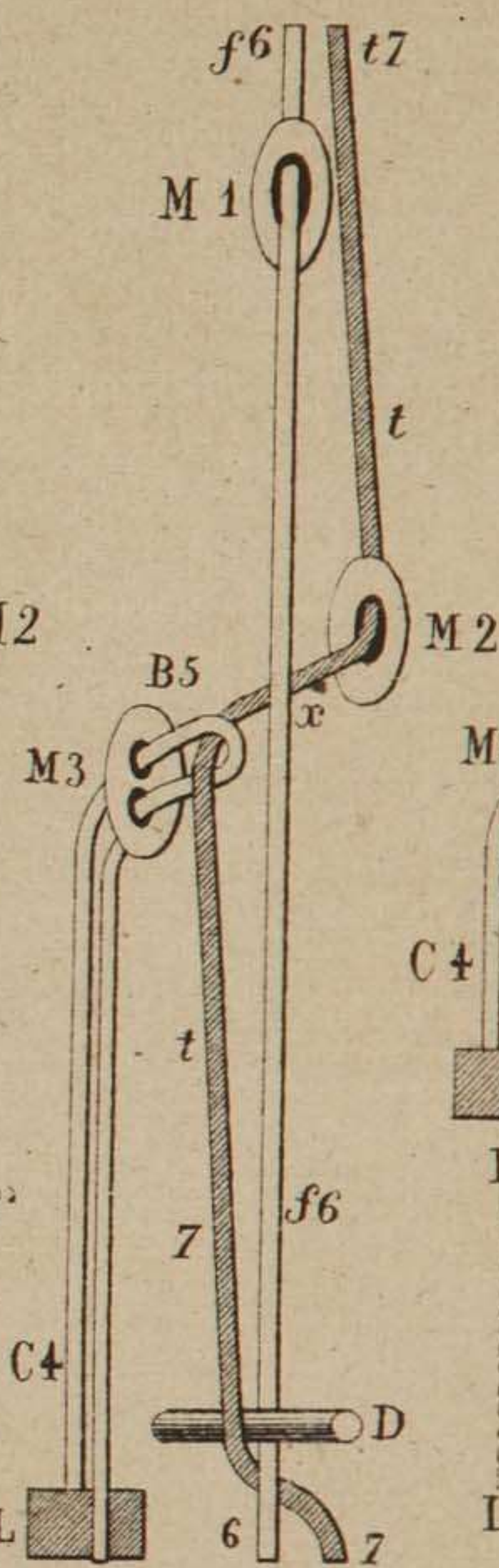
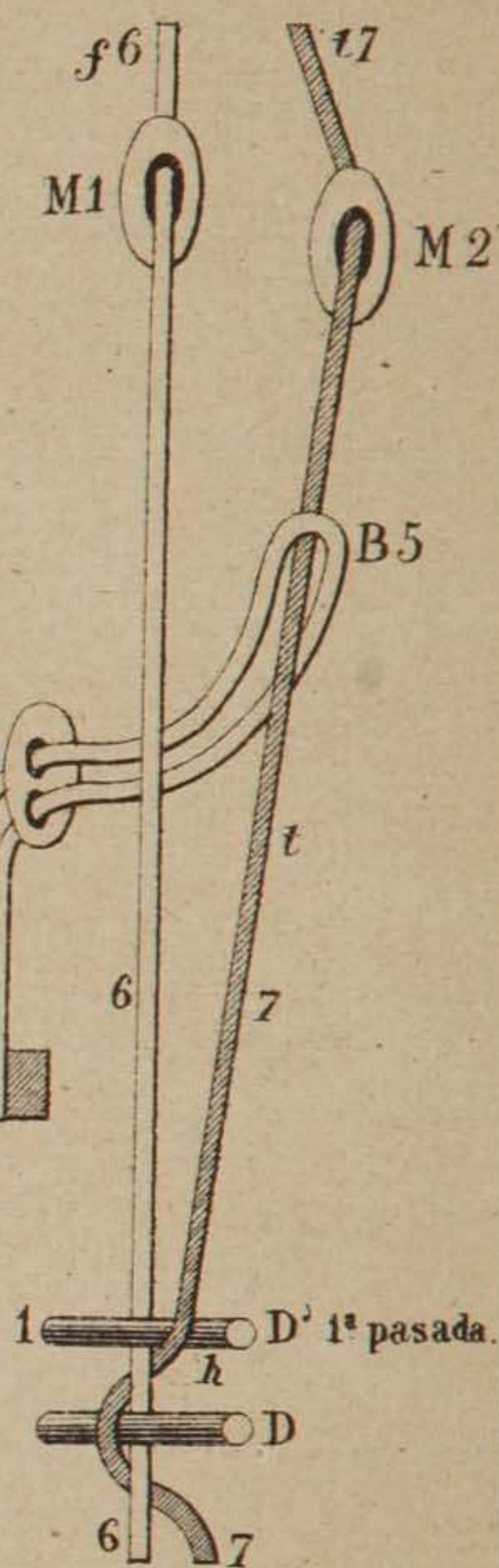


Fig. 171.



(OPERARIO.)

Fig. 175.

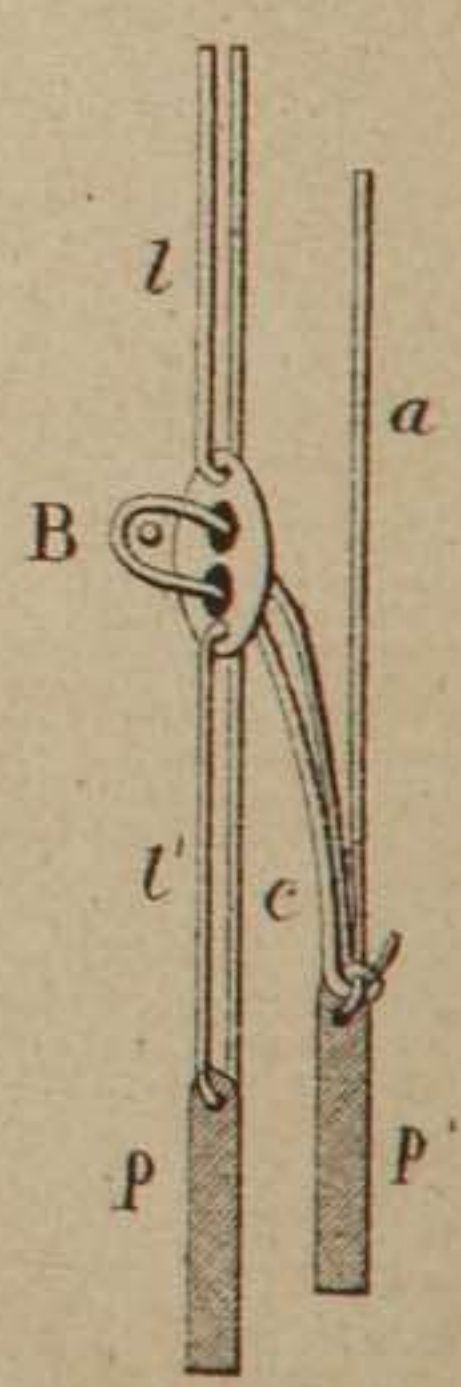


Fig. 176.

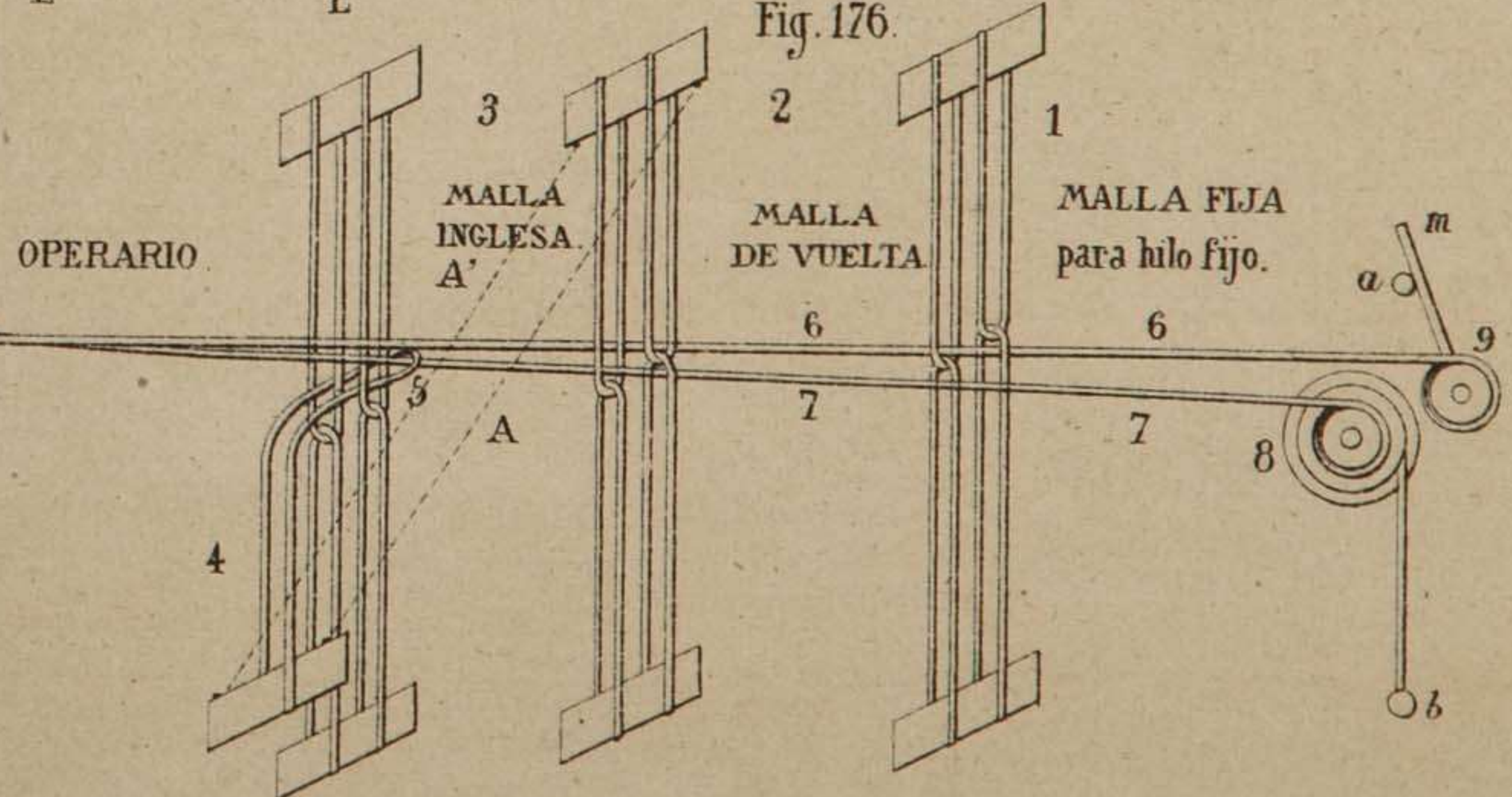


Fig. 177.

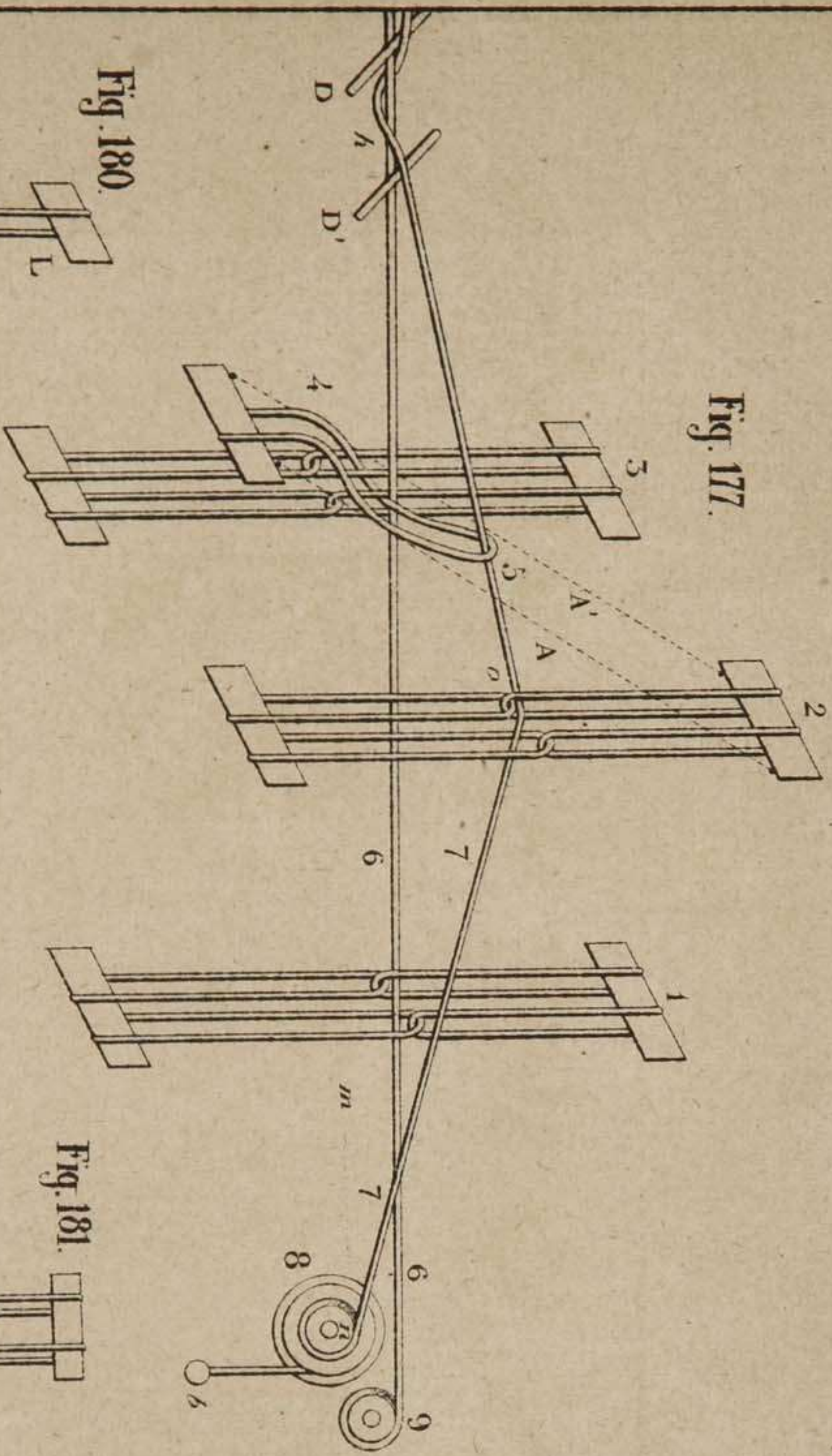


Fig. 180.

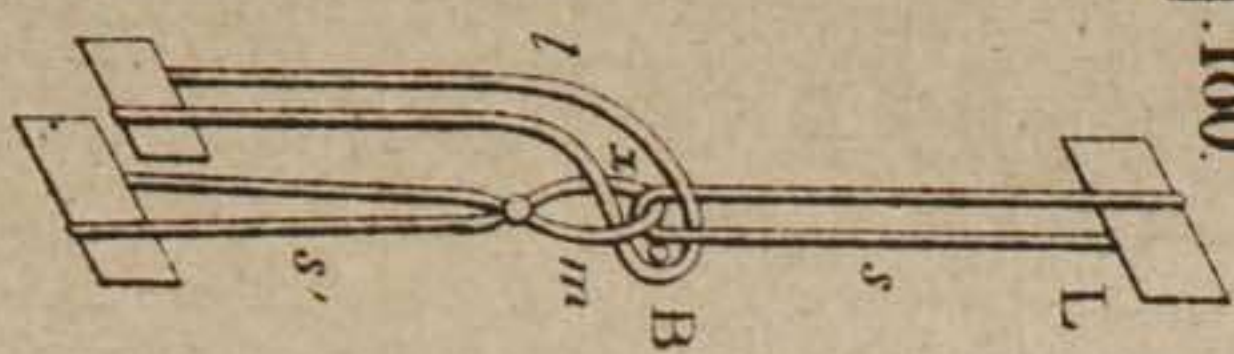


Fig. 178.

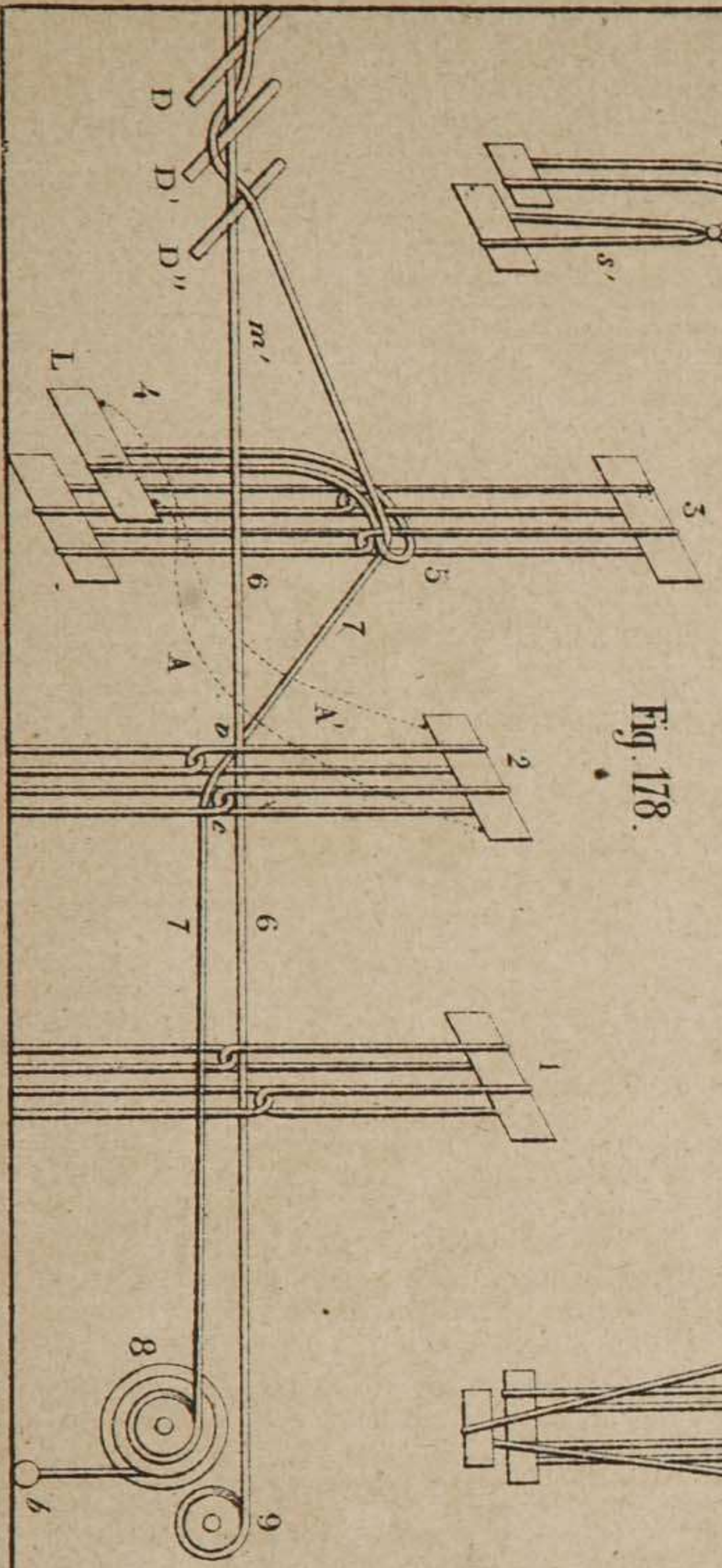
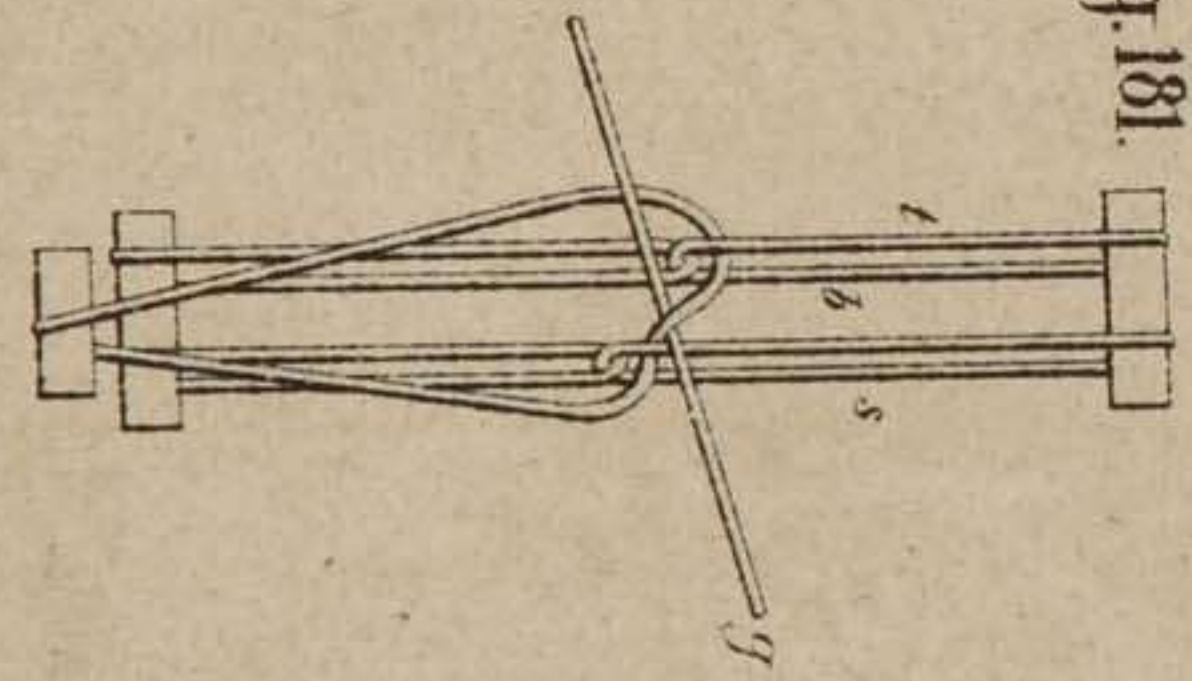


Fig. 181.



Diseño A

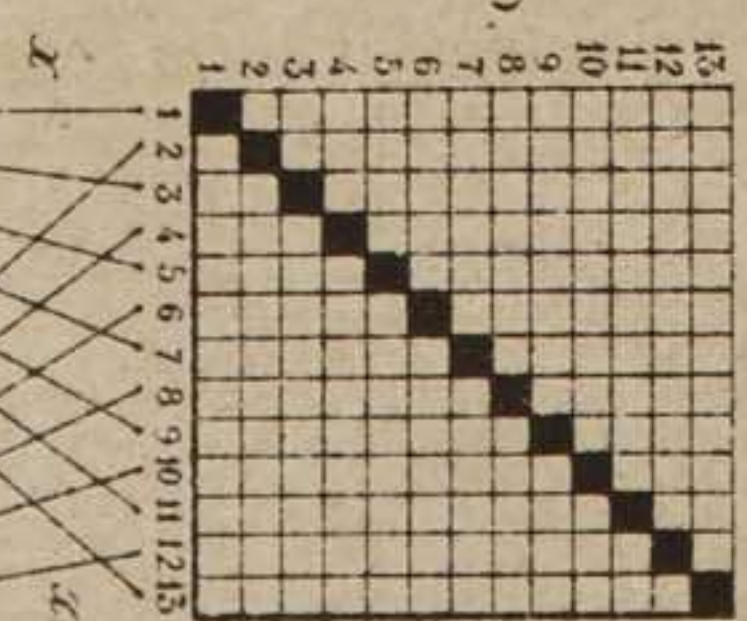


Fig. 184.

E

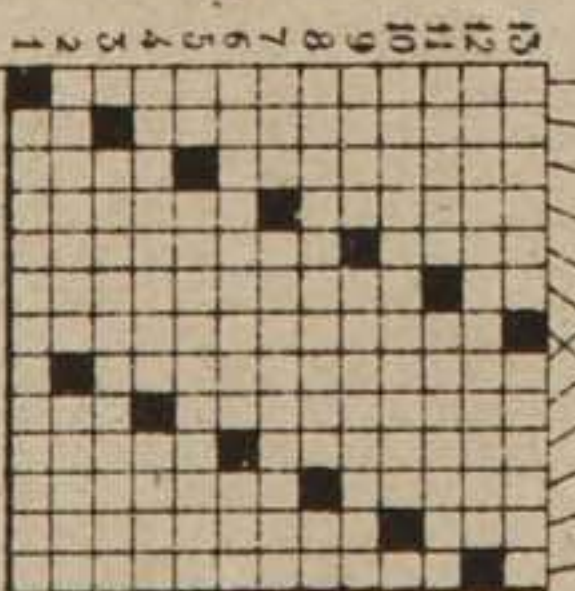
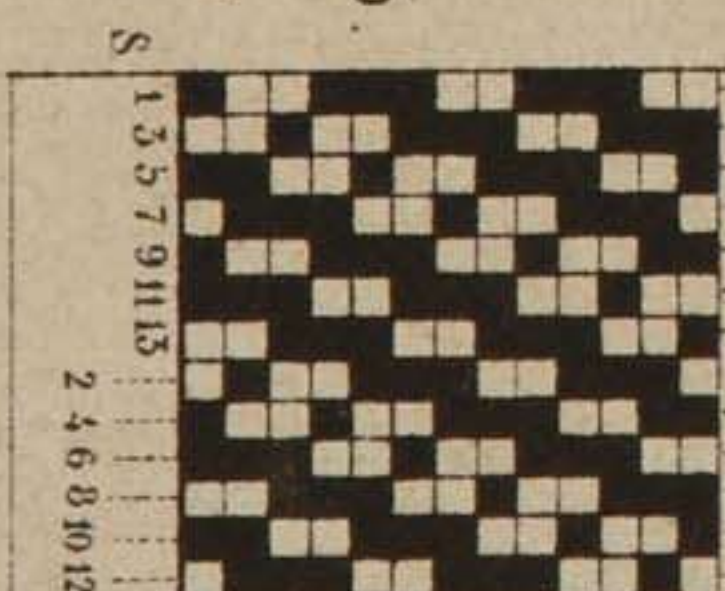


Fig. 185.

F



Diseño A'

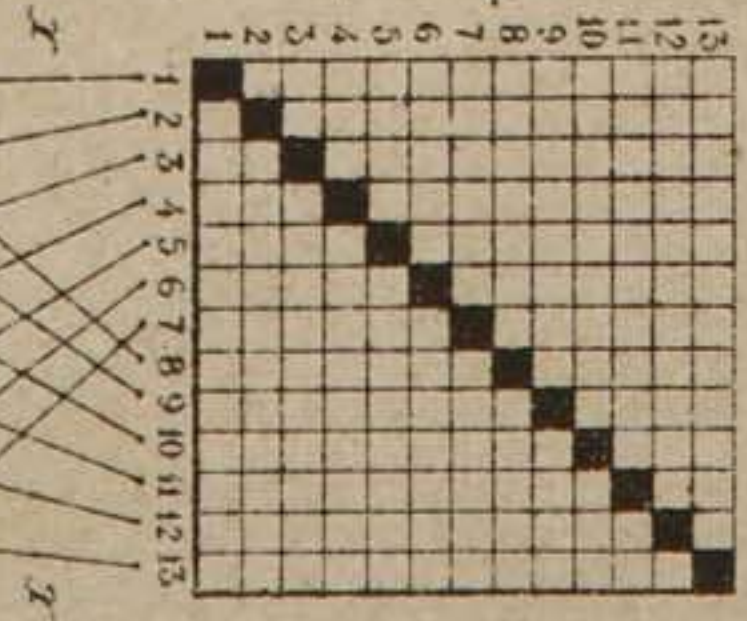


Fig. 186.

G

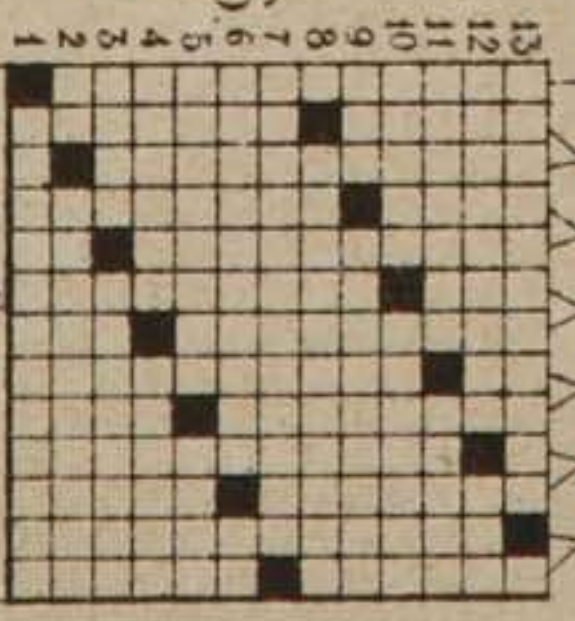


Fig. 187.

H

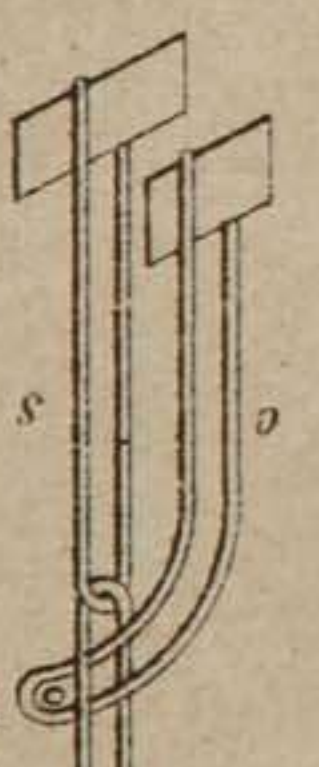
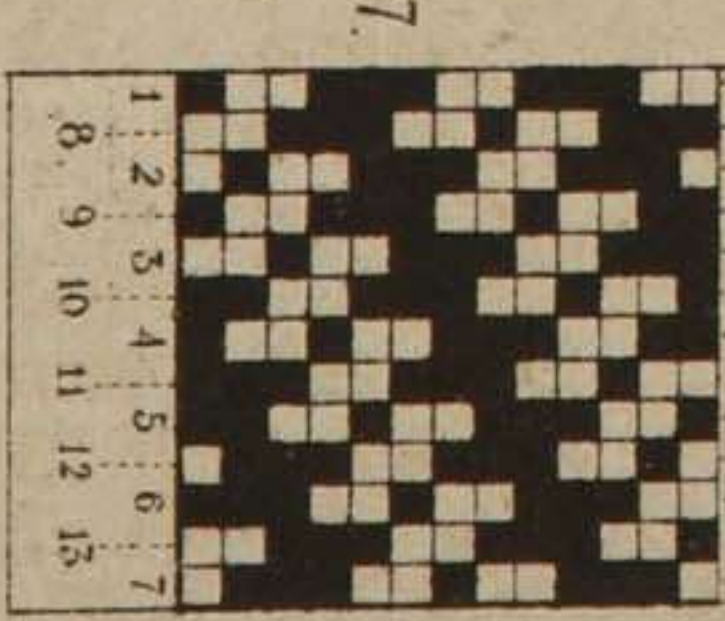
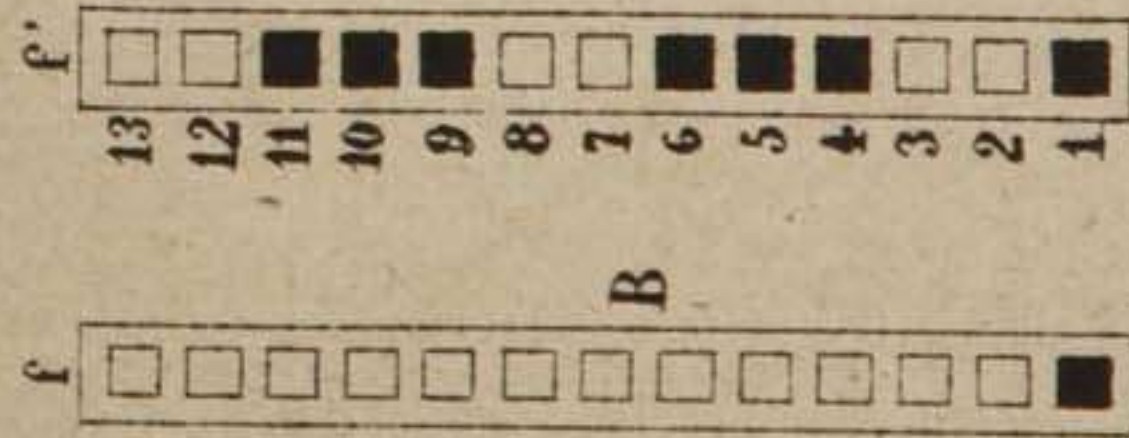
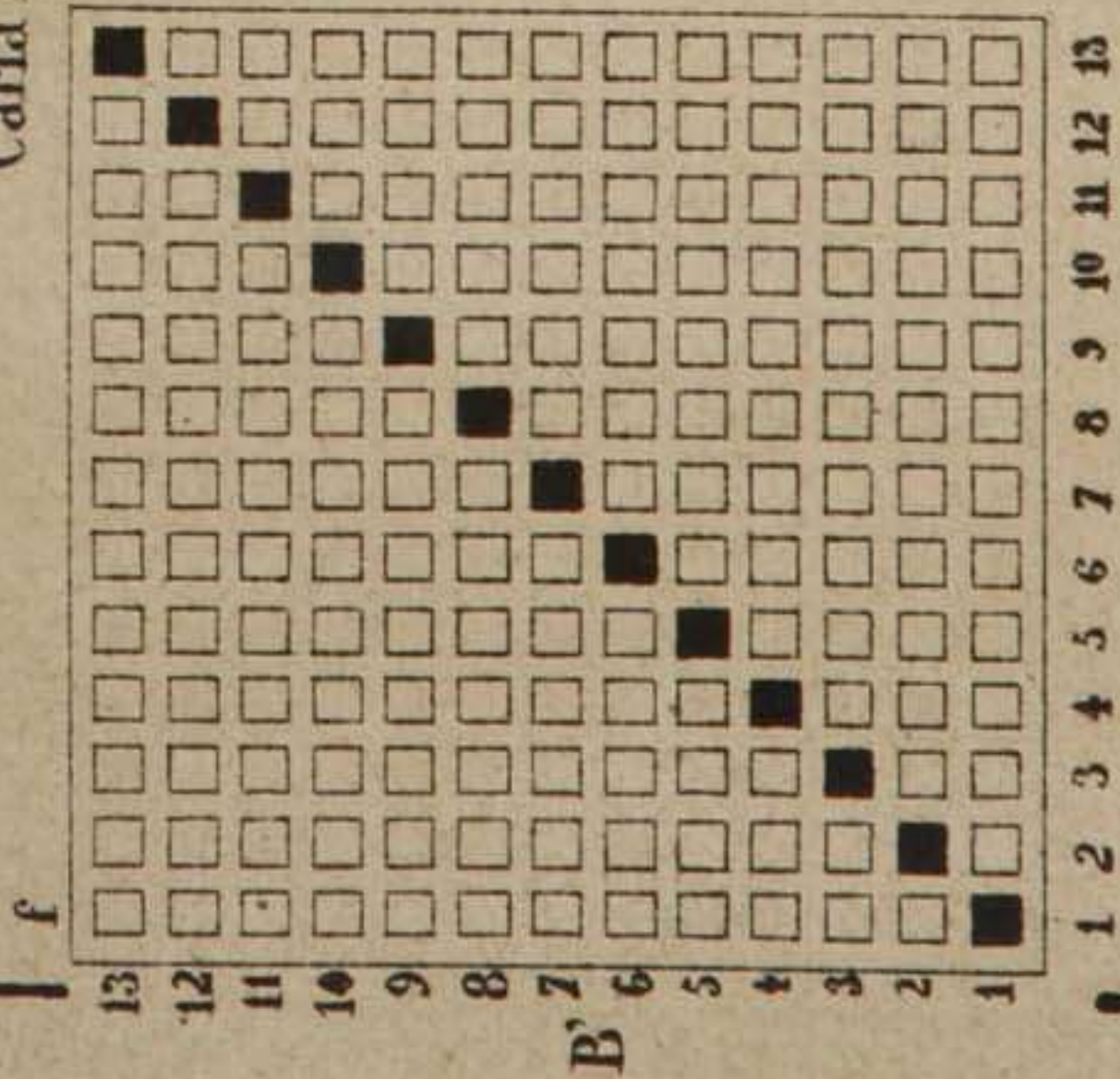


Fig. 179.

Fig. 182.

Carla A.



Diseño A''

Fig. 183

Carla D.

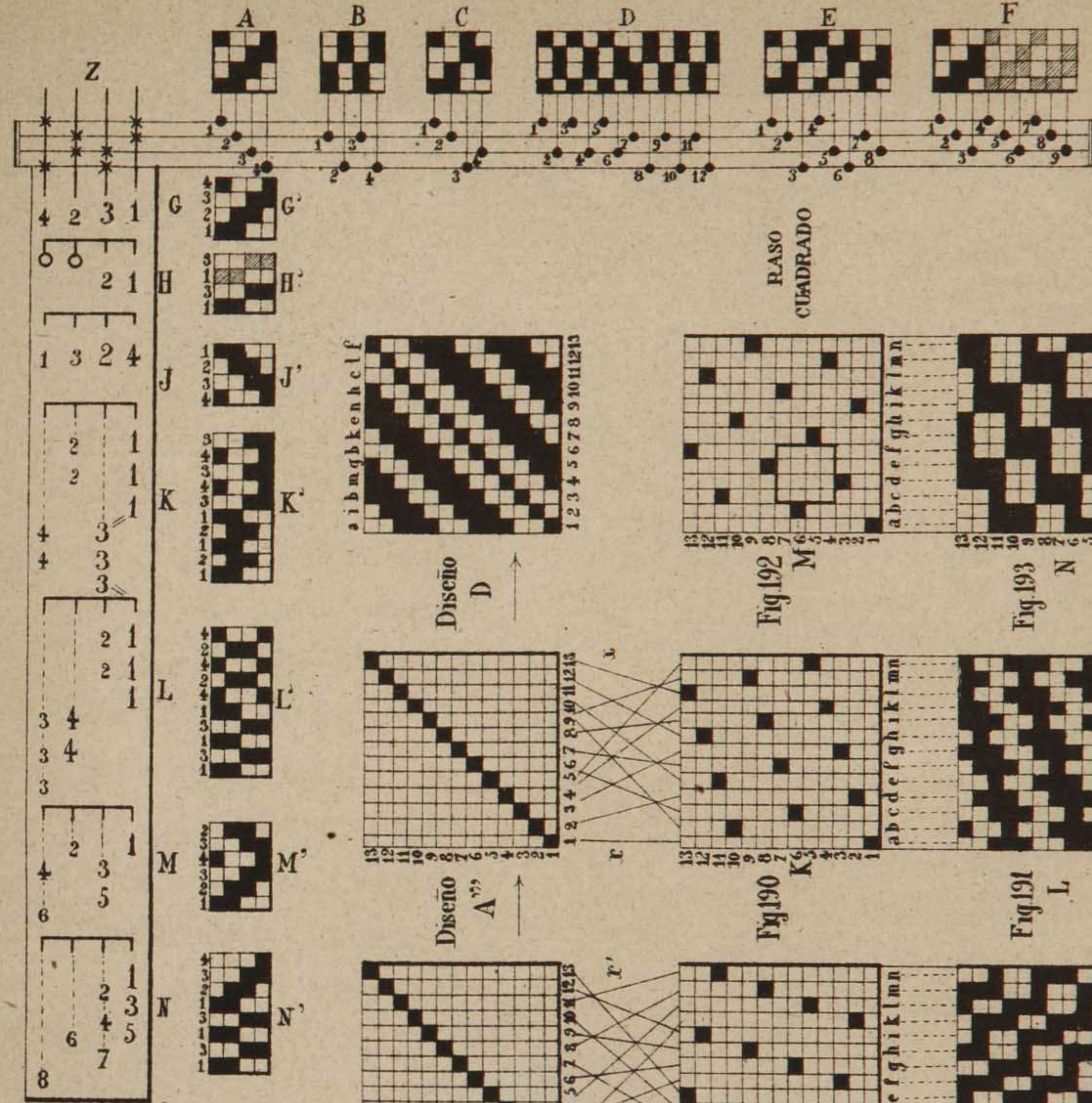
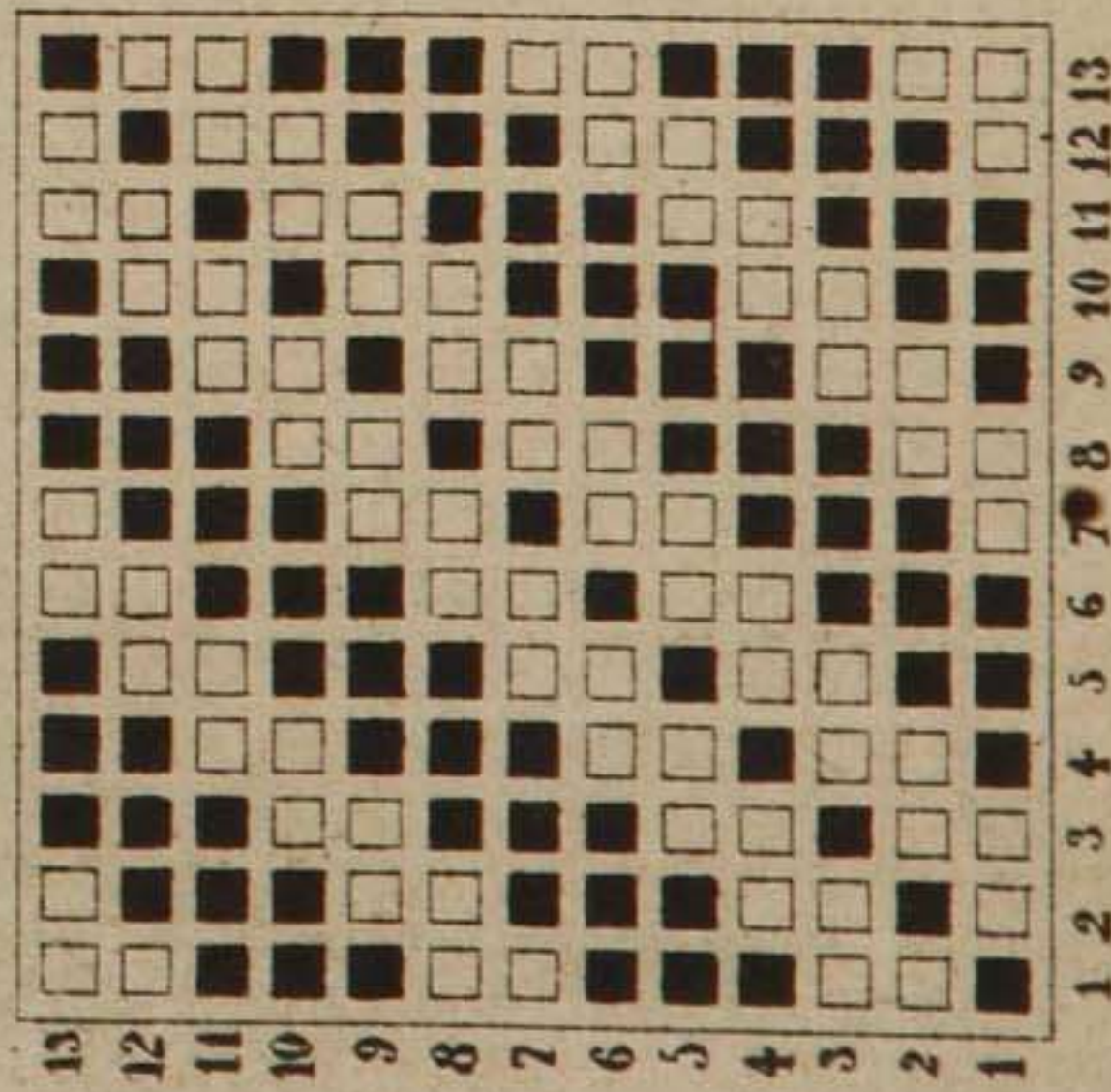


Fig. 195.

Fig. 192

Fig. 190

Fig. 188

Fig. 193

Fig. 191

Fig. 189

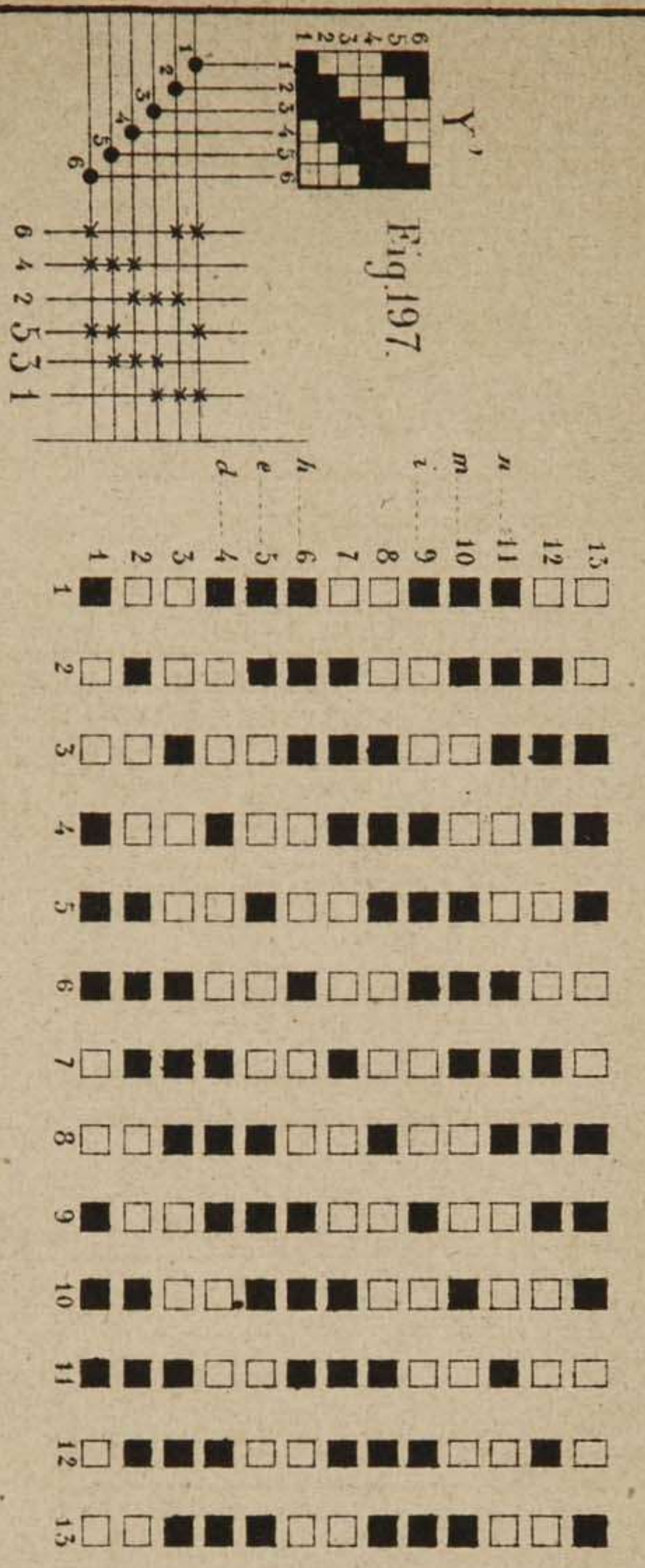


Fig. 194 Segun el dibujo D.

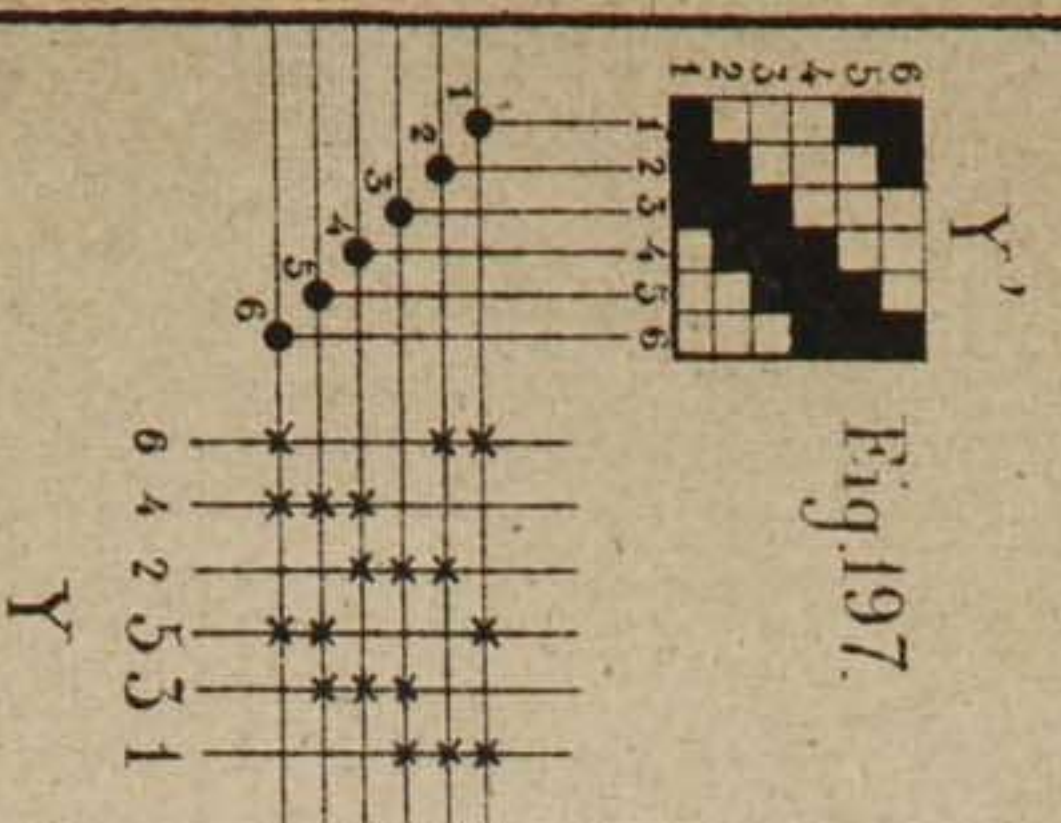


Fig. 198.

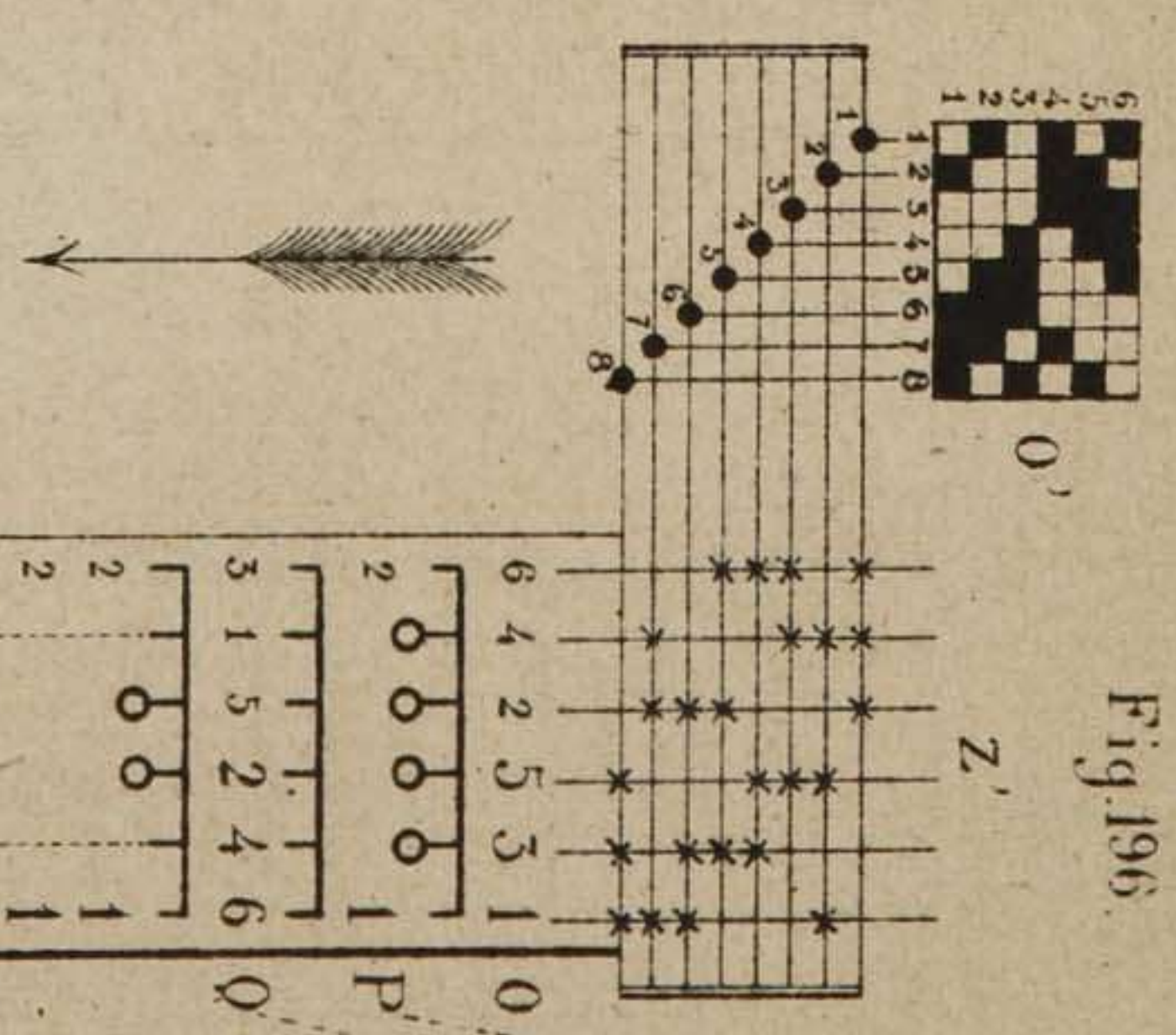
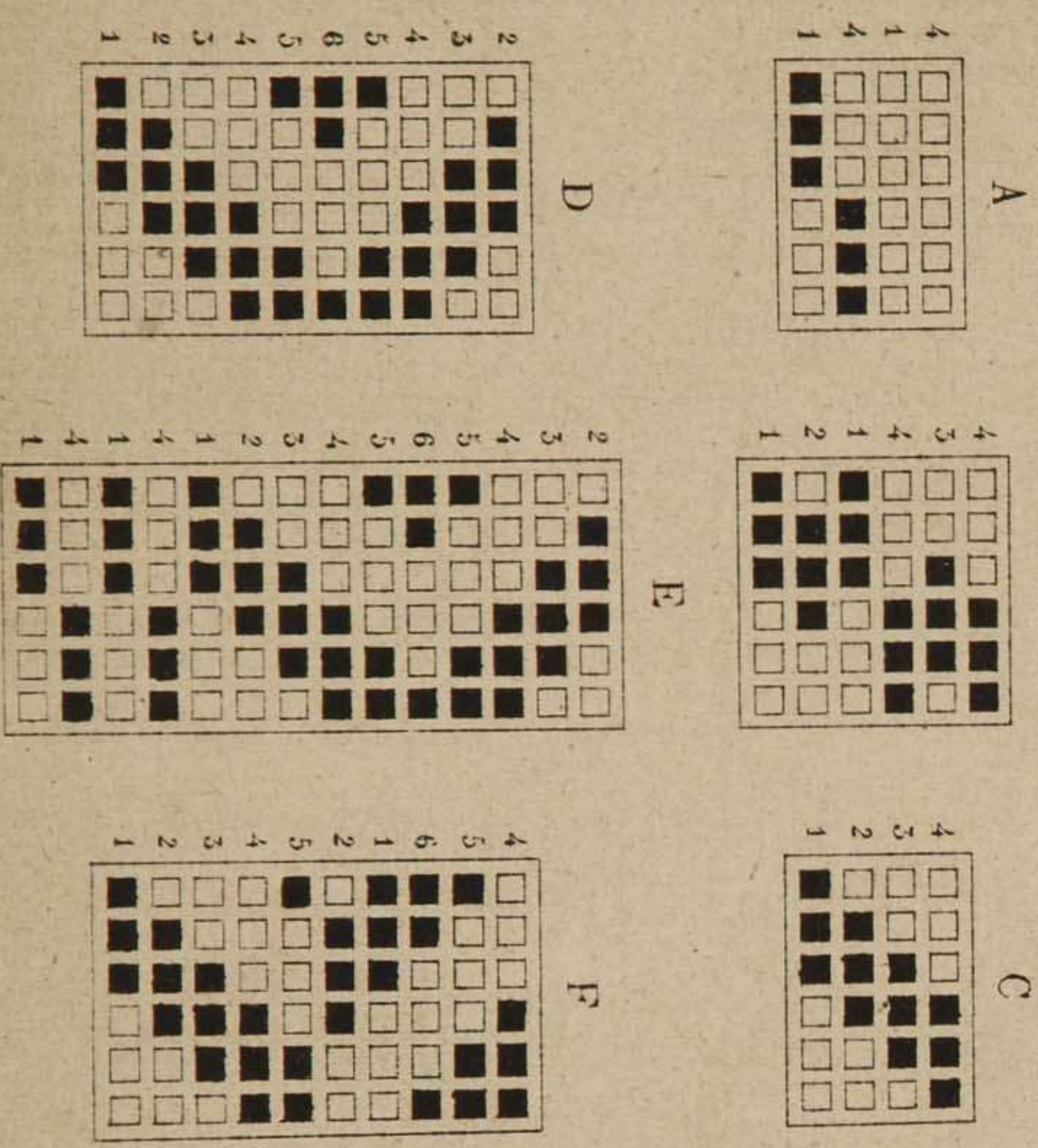
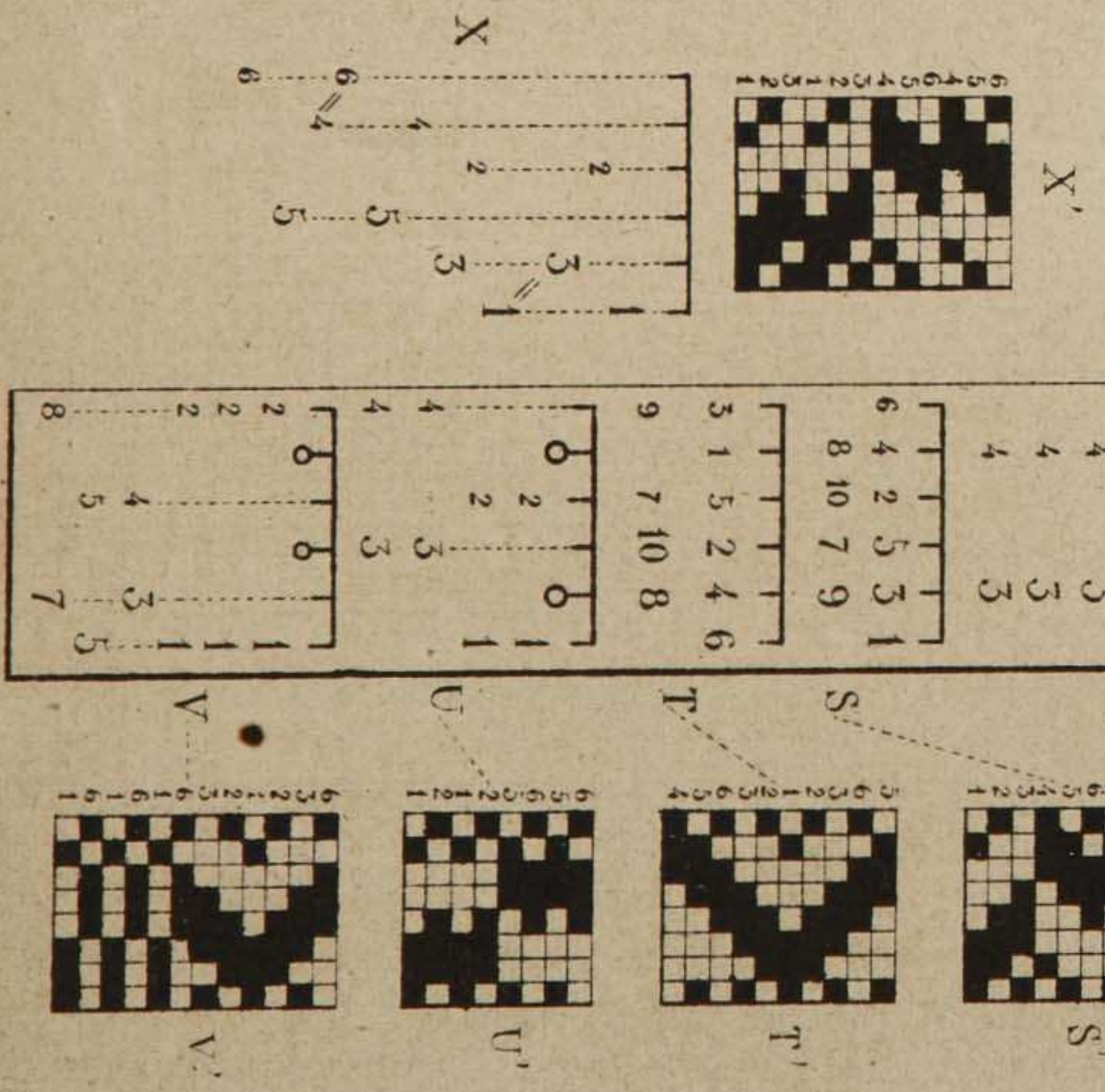
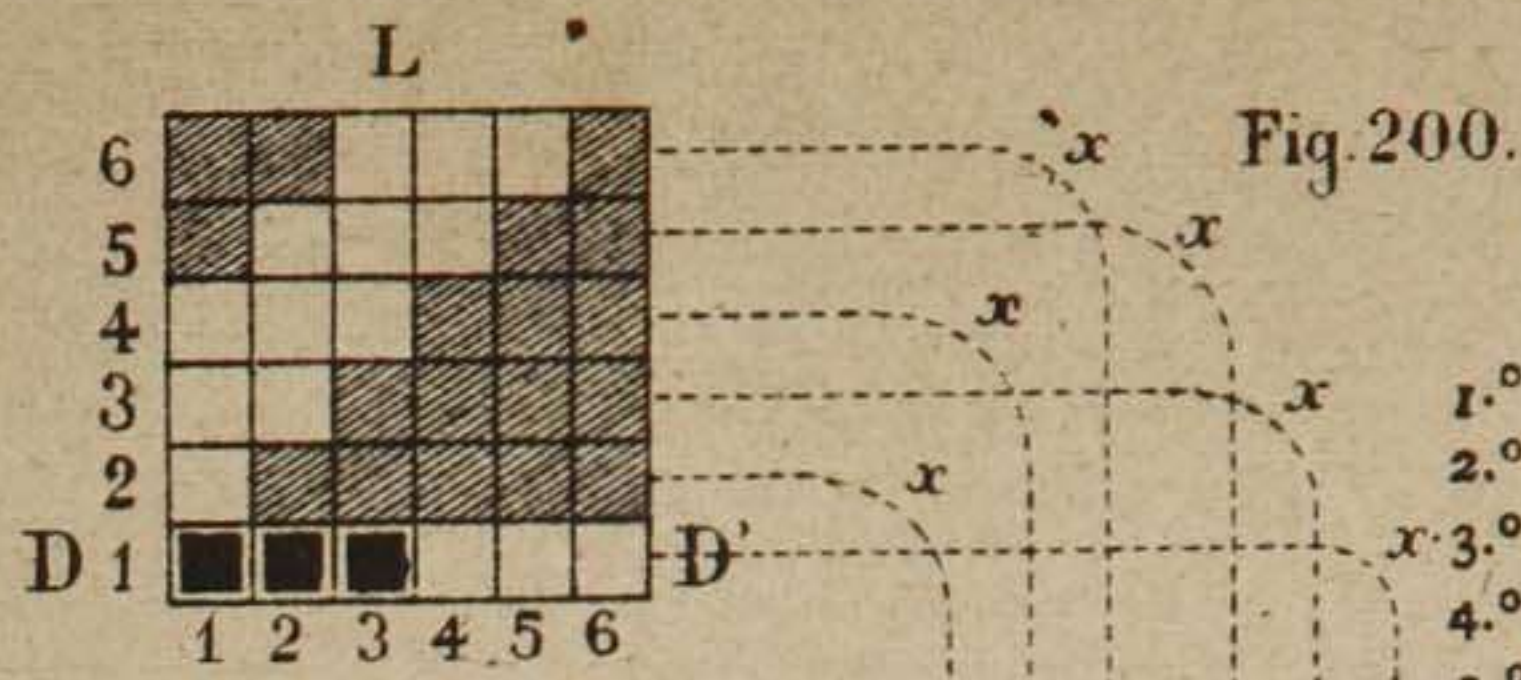


Fig. 196.

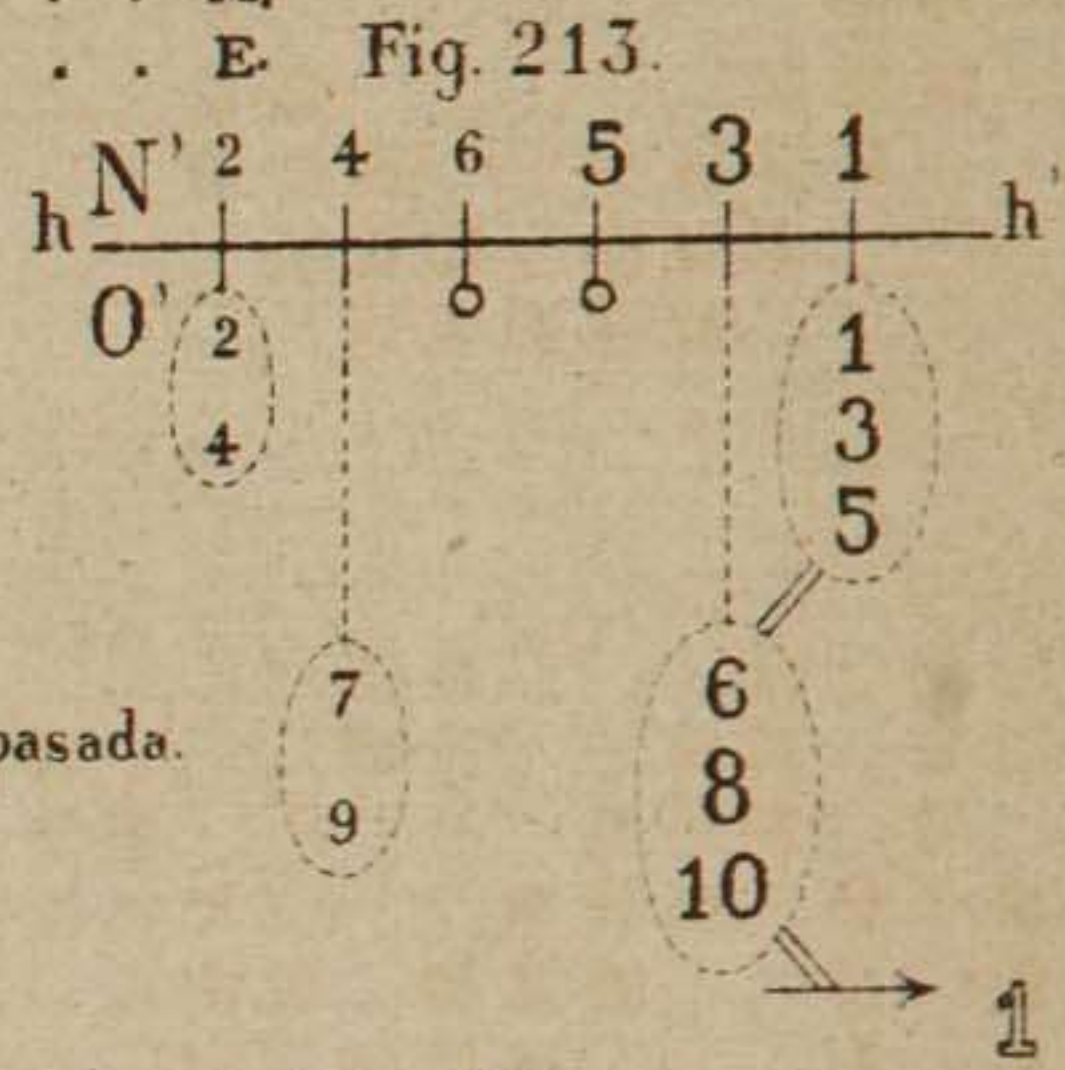
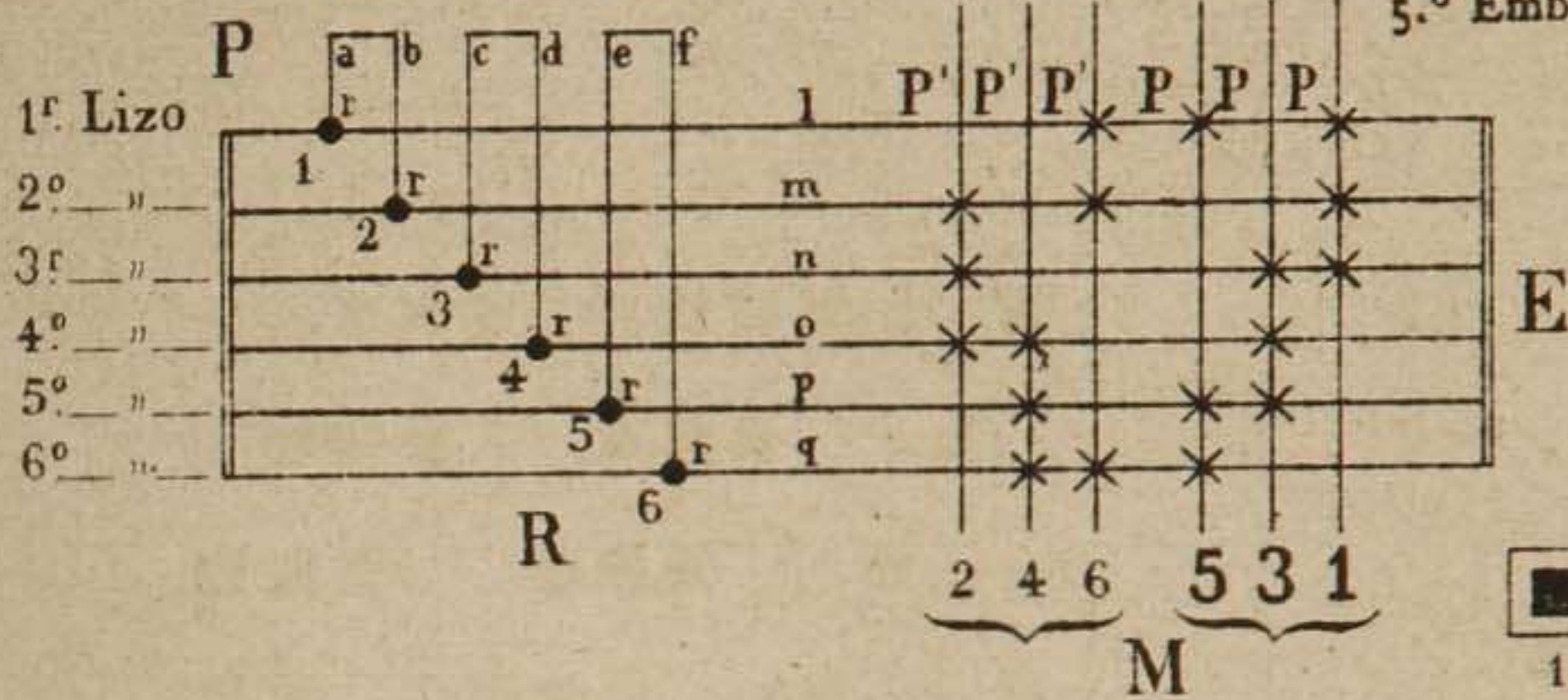




LEYENDA.

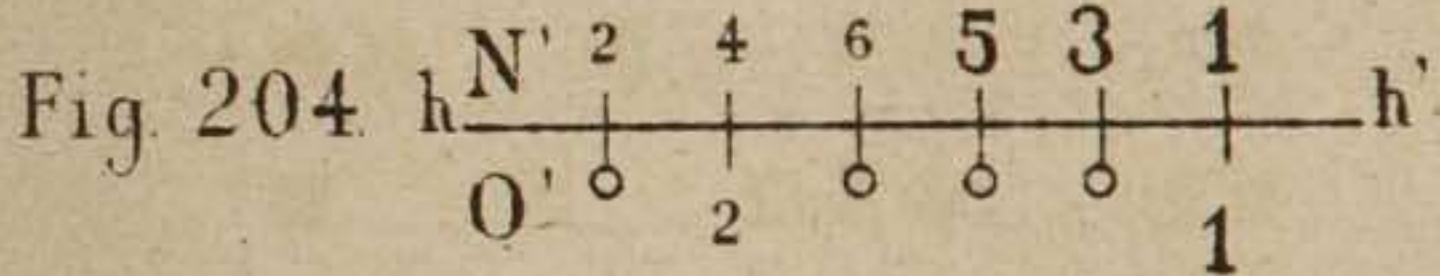
Orden de las operaciones sucesivas

- 1.º Ligamiento primordial.. . . . L.
- 2.º Remetido de los hilos.. . . . R.
- 3.º Pasado de los hilos en peine. . . P.
- 4.º Marcha cifrada. M.
- 5.º Embragado. E.

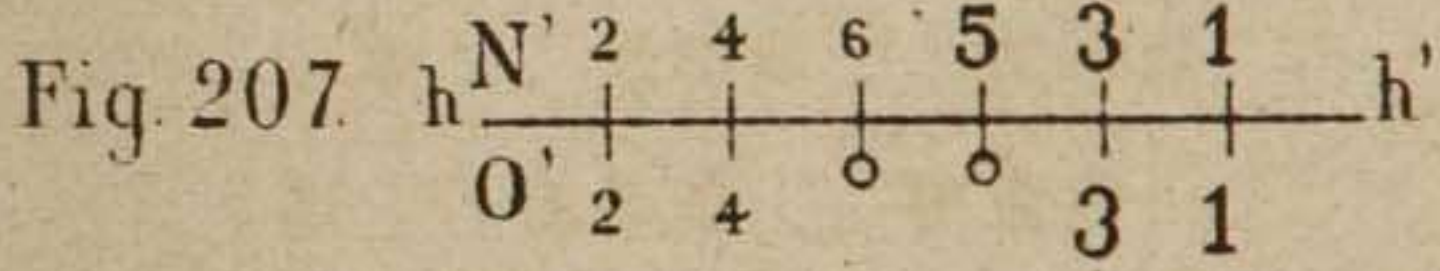
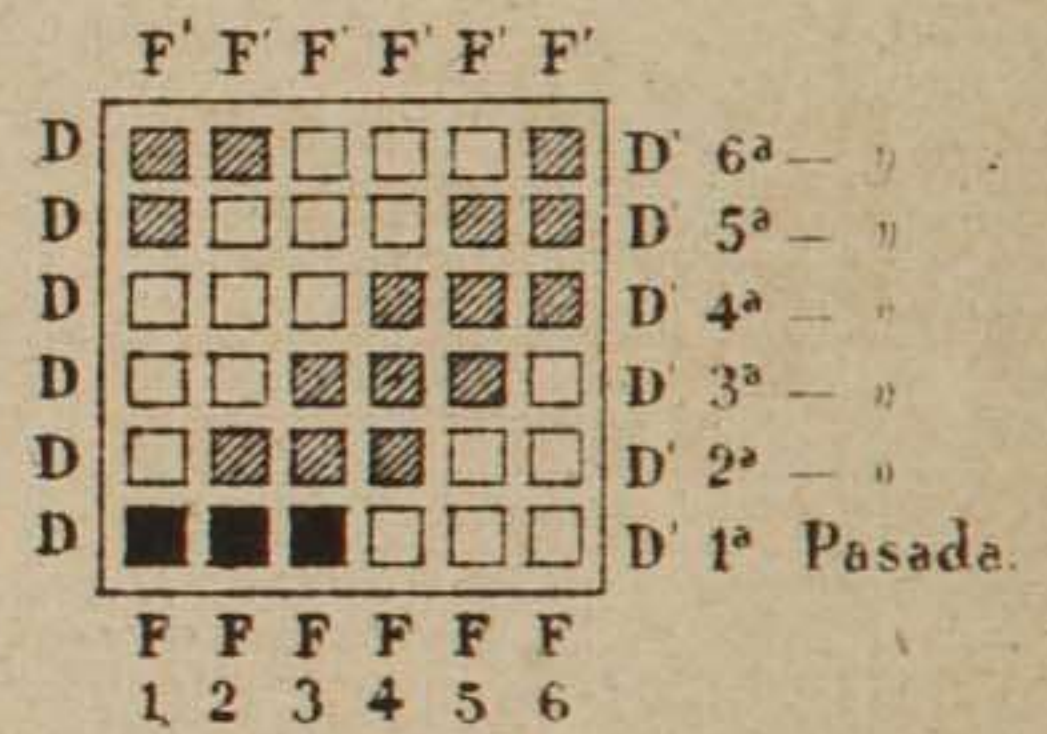
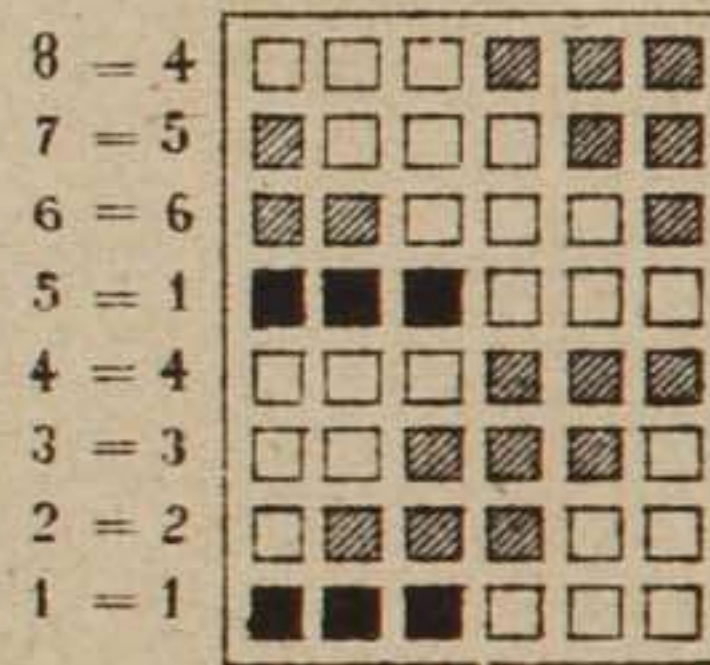


SIMBOLOS COMPARATIVOS DE LAS CADENCIAS.

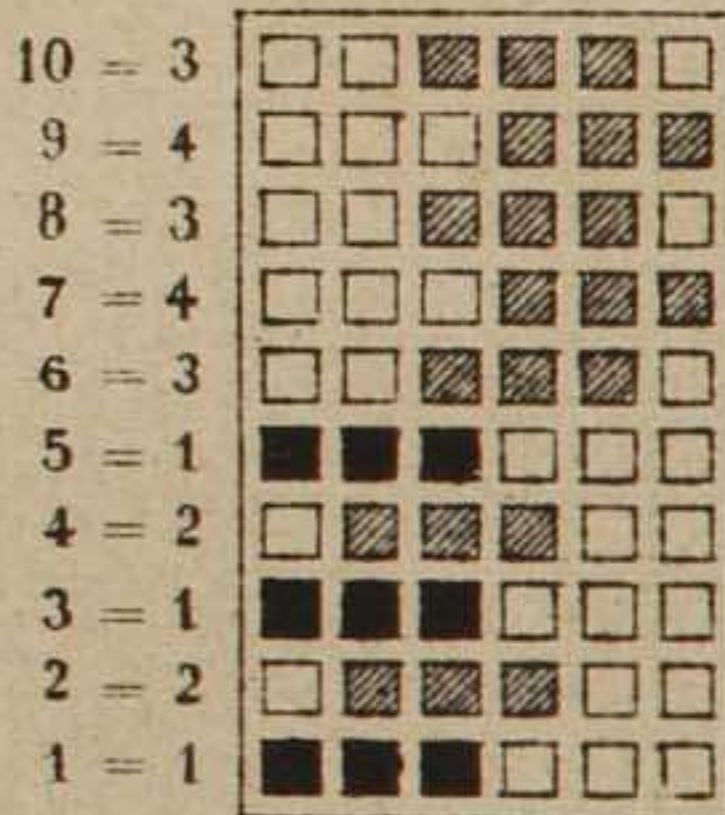
N' Cadencia tipo del ligamiento primordial.
O' Cadencia del ligamiento engendrado.



O N Fig. 208.



O N Fig. 212.



O N Fig. 210.

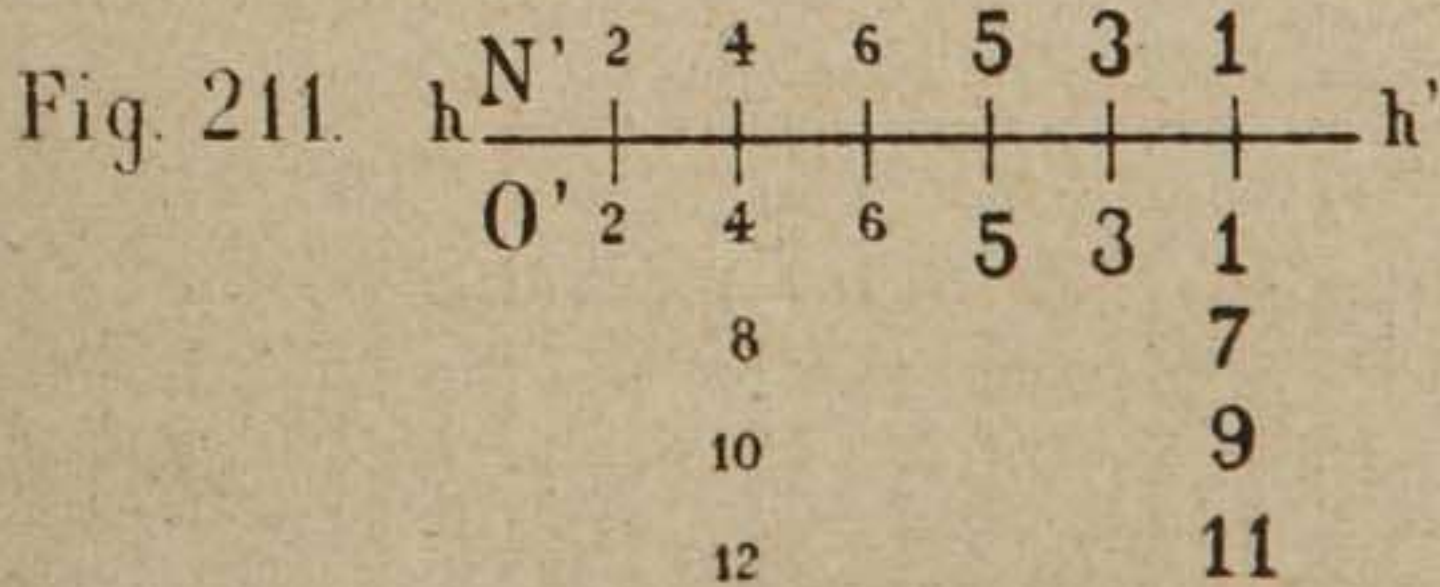
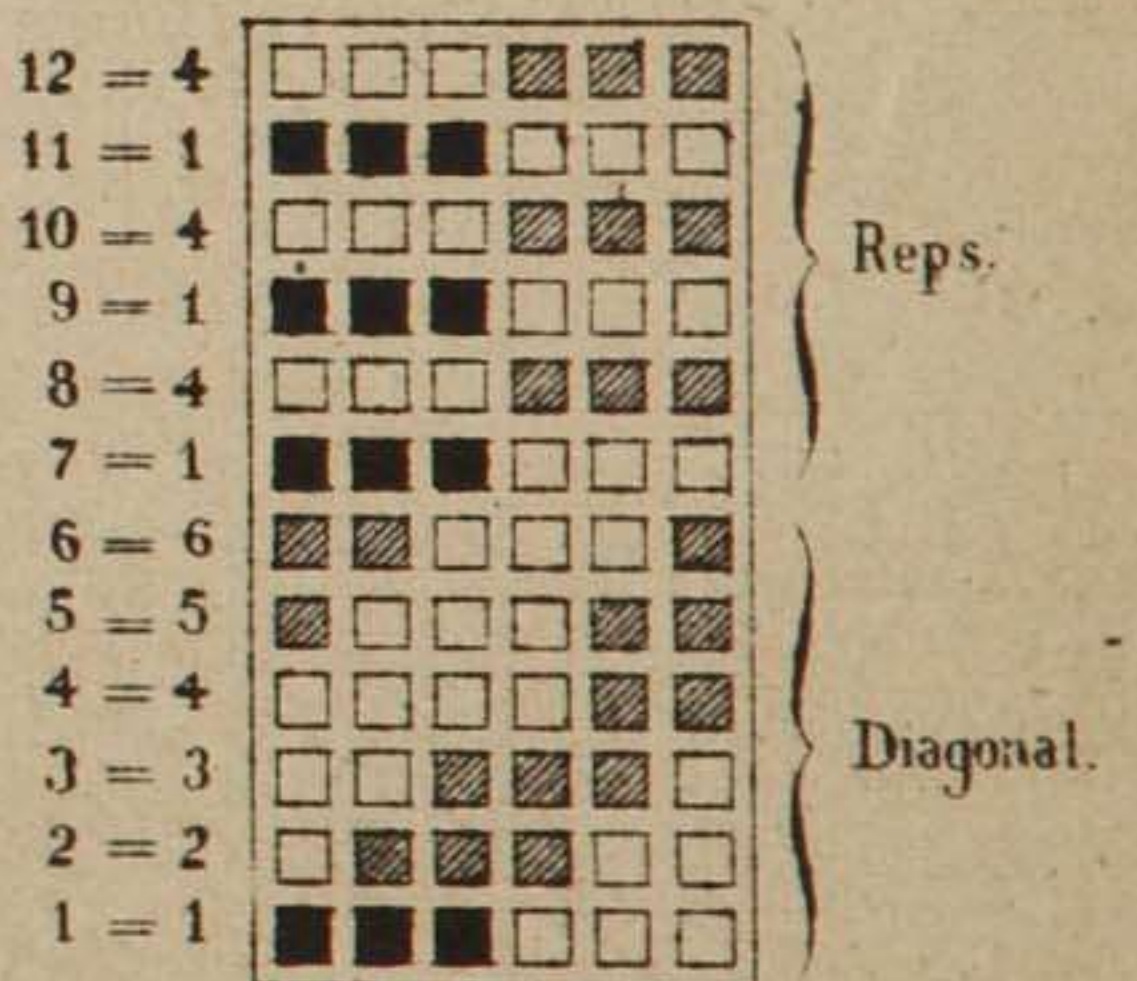
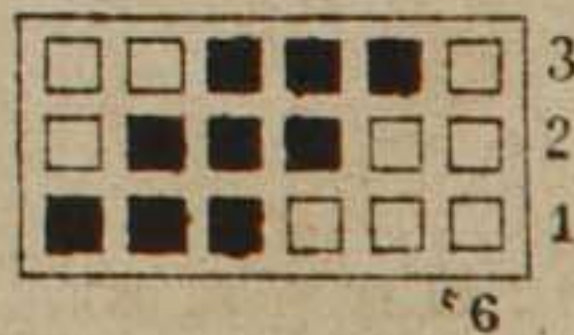
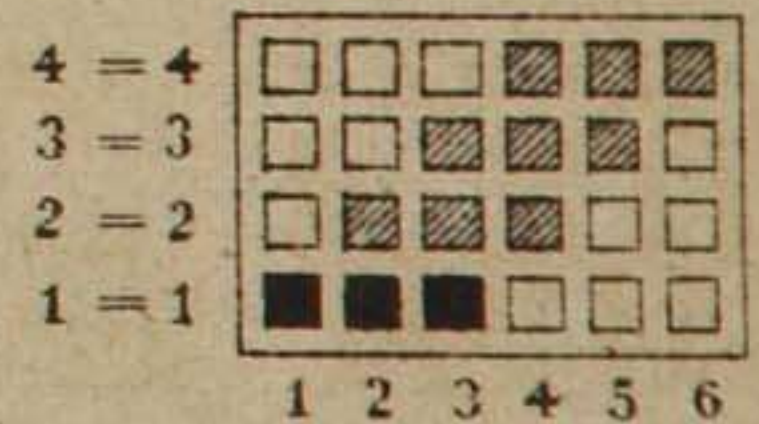


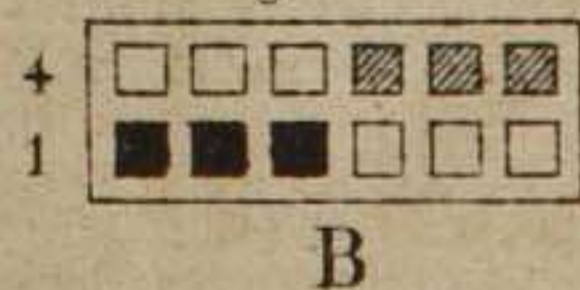
Fig. 205.



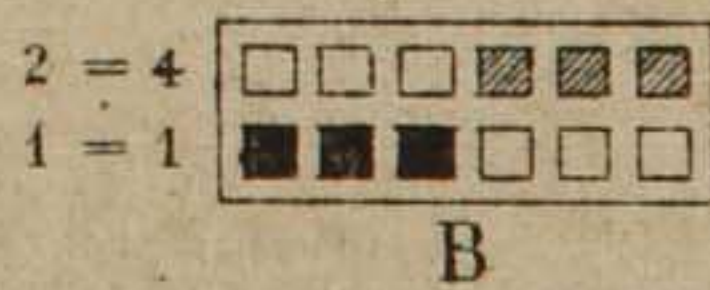
O N Fig. 206.

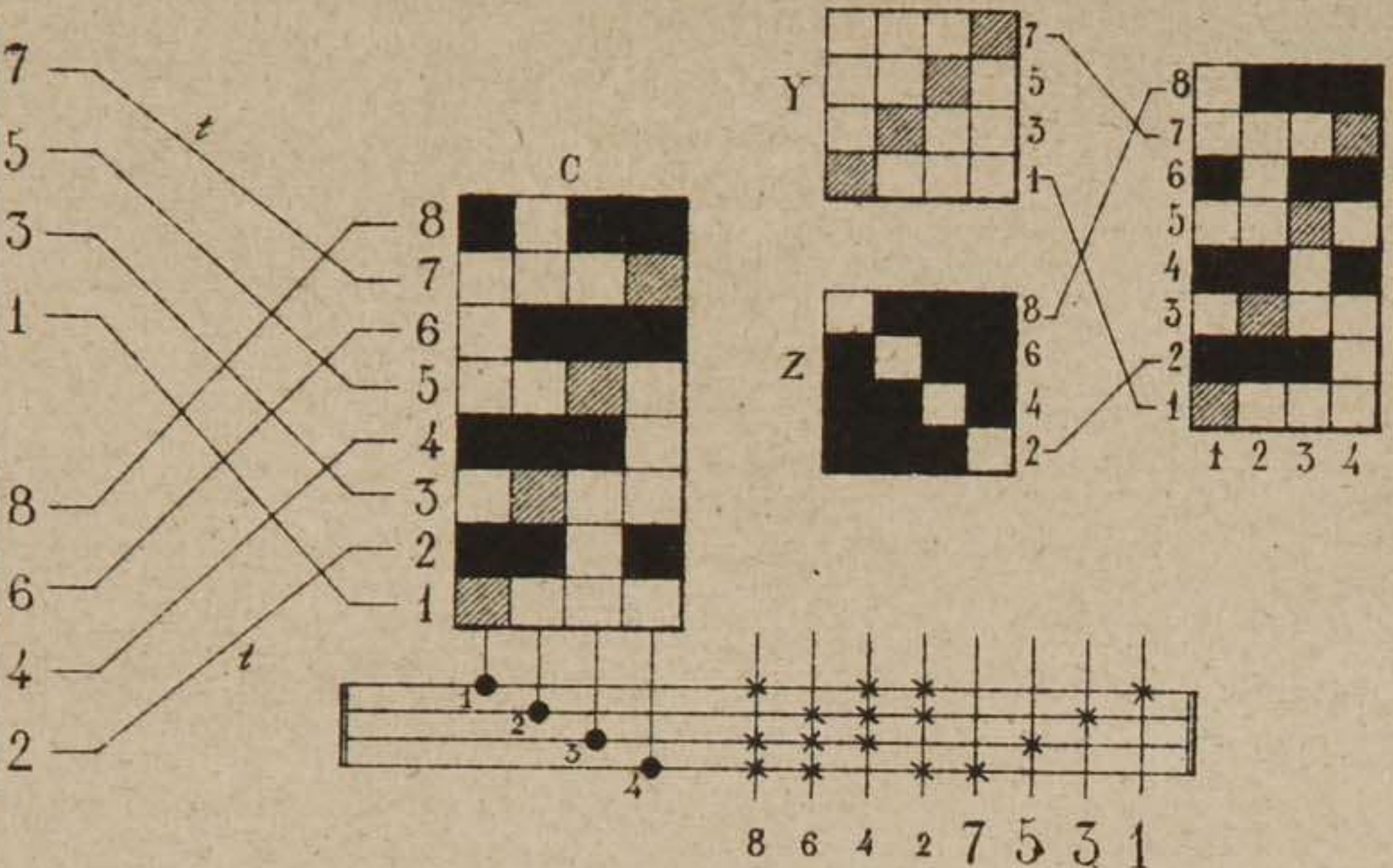
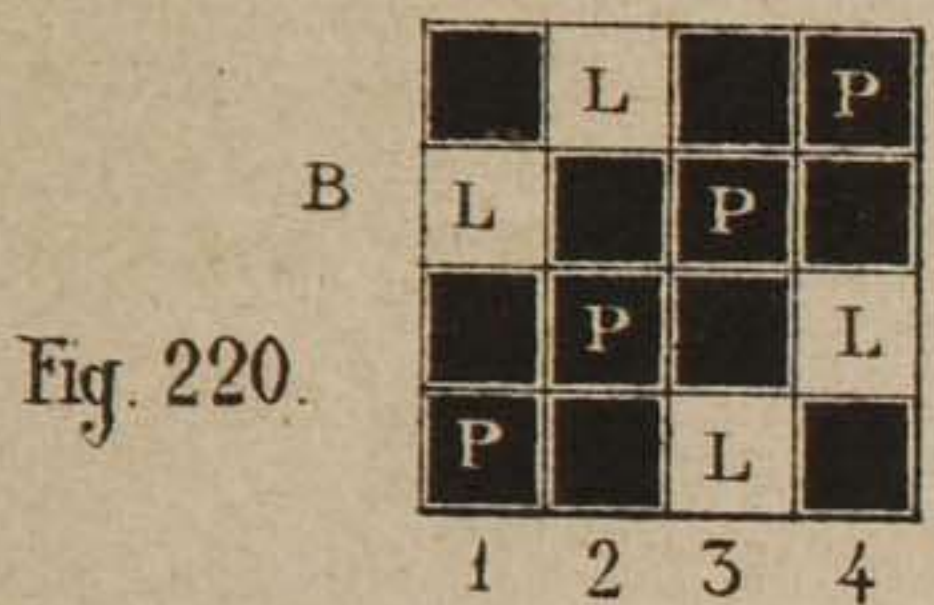
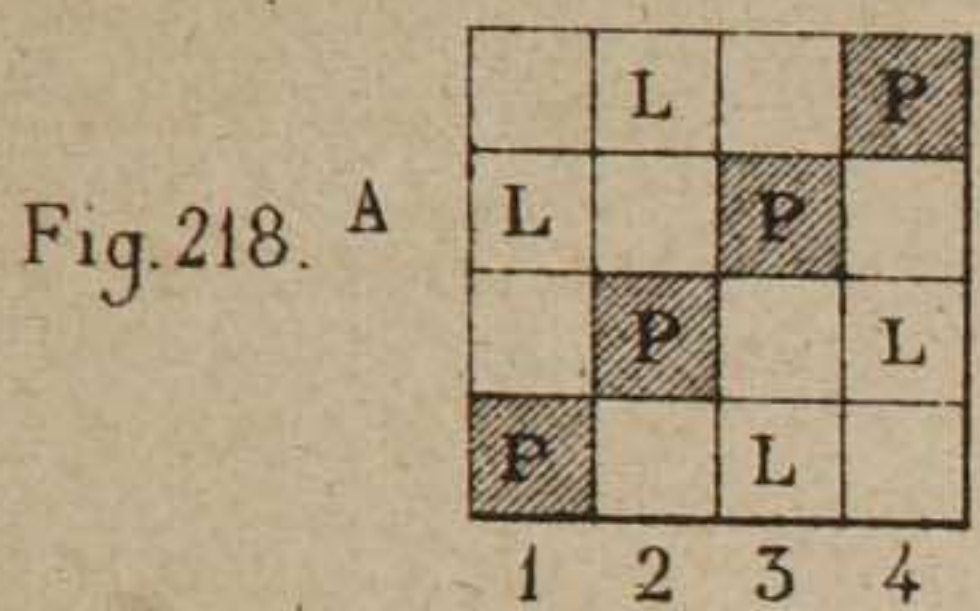
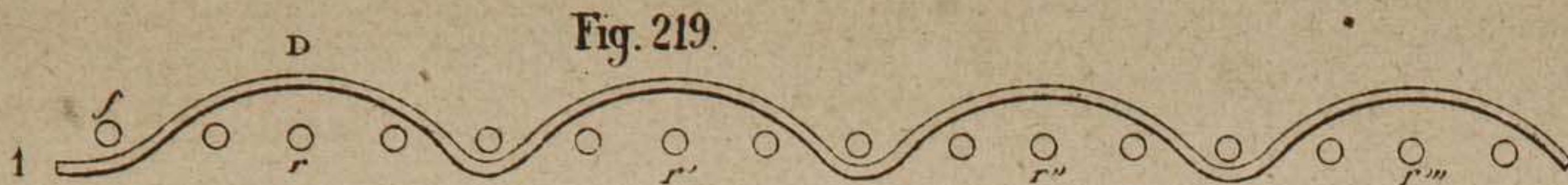


N Fig. 202.



O N Fig. 203.





cg Fig. 224.

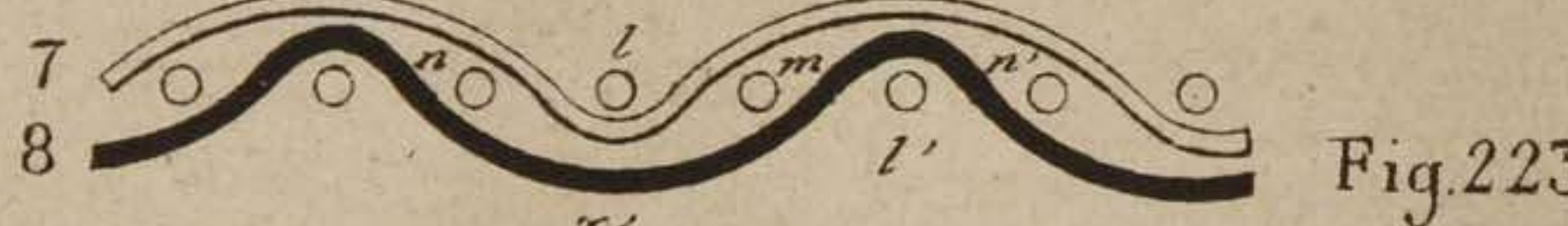
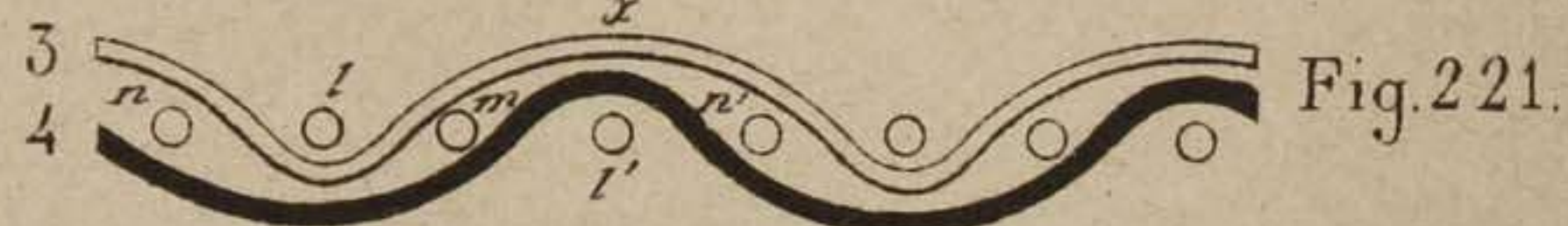
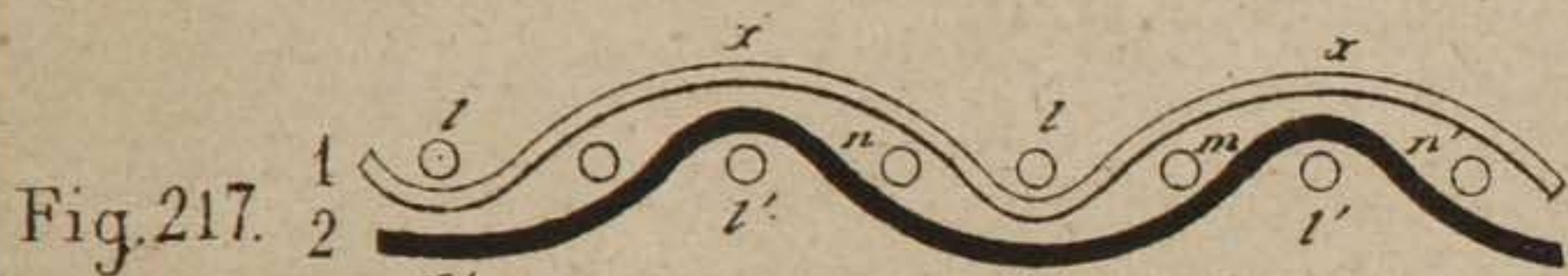


Fig. 215.

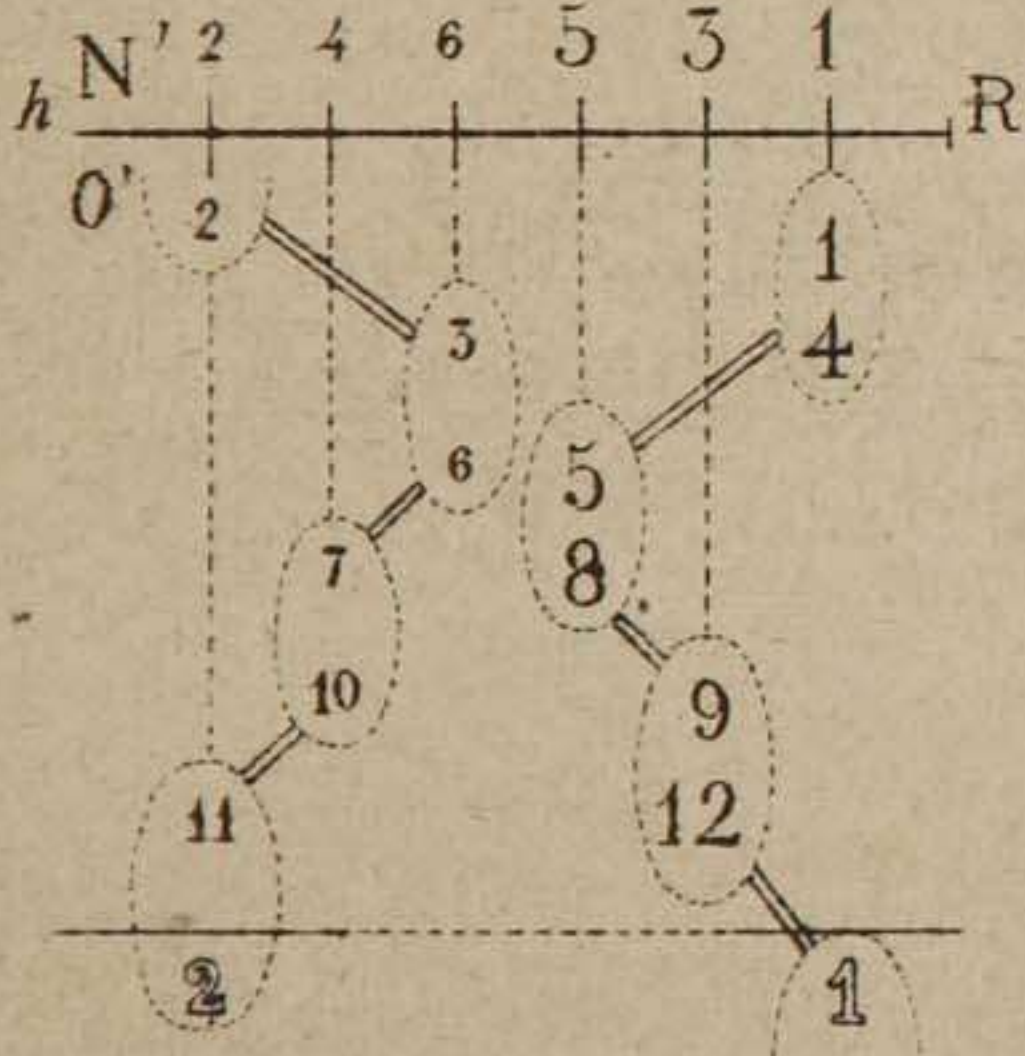


Fig. 214.

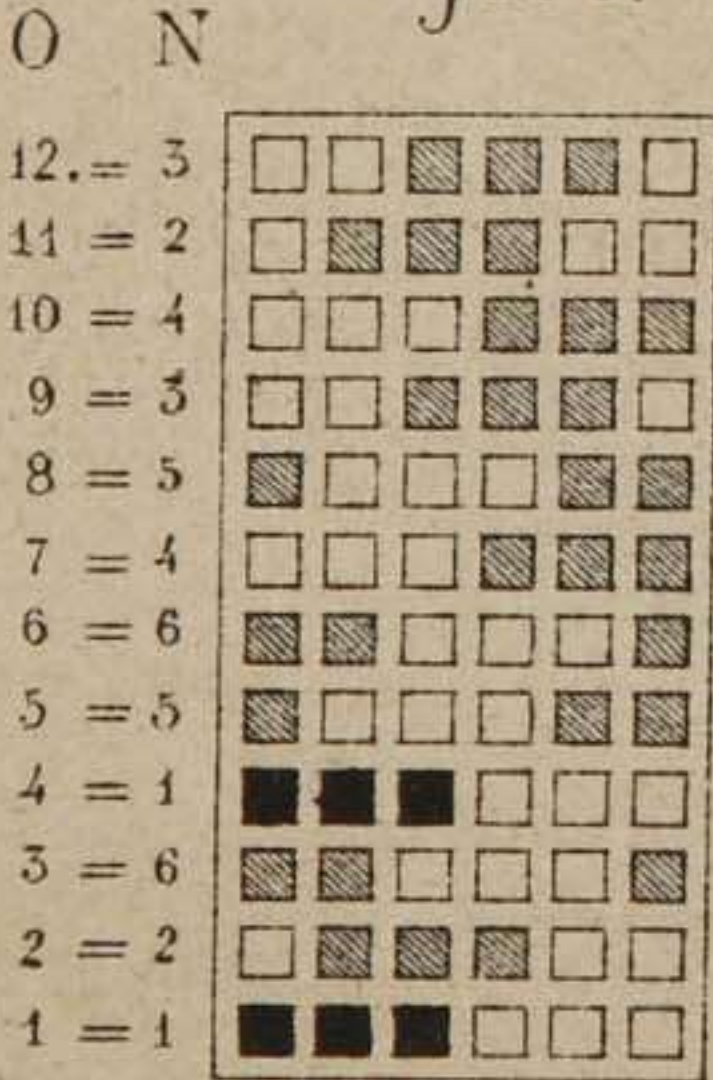


Fig. 228.

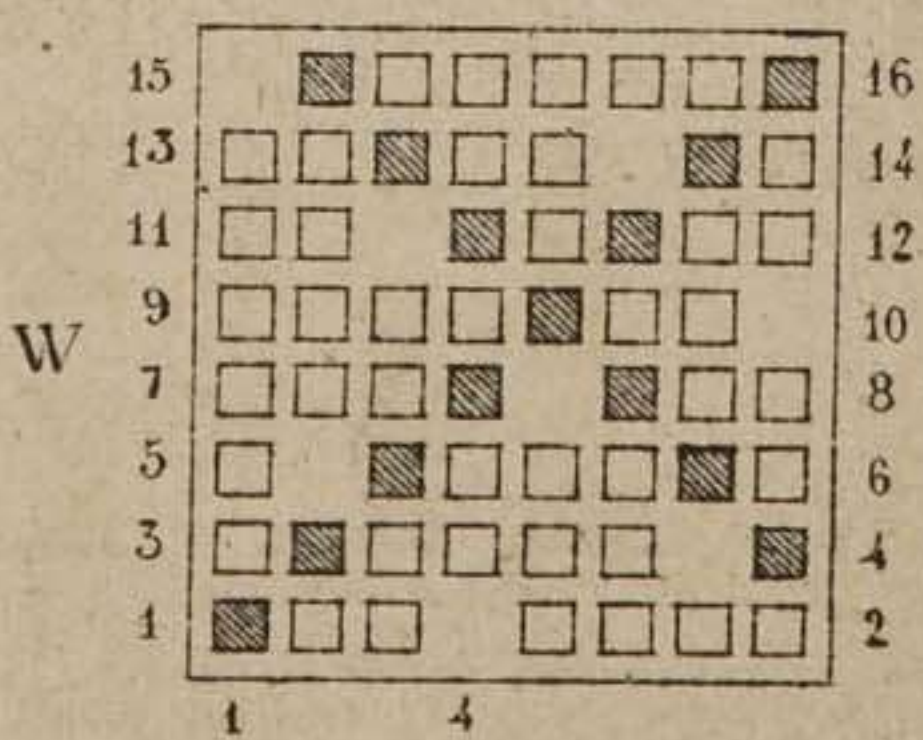


Fig. 226.

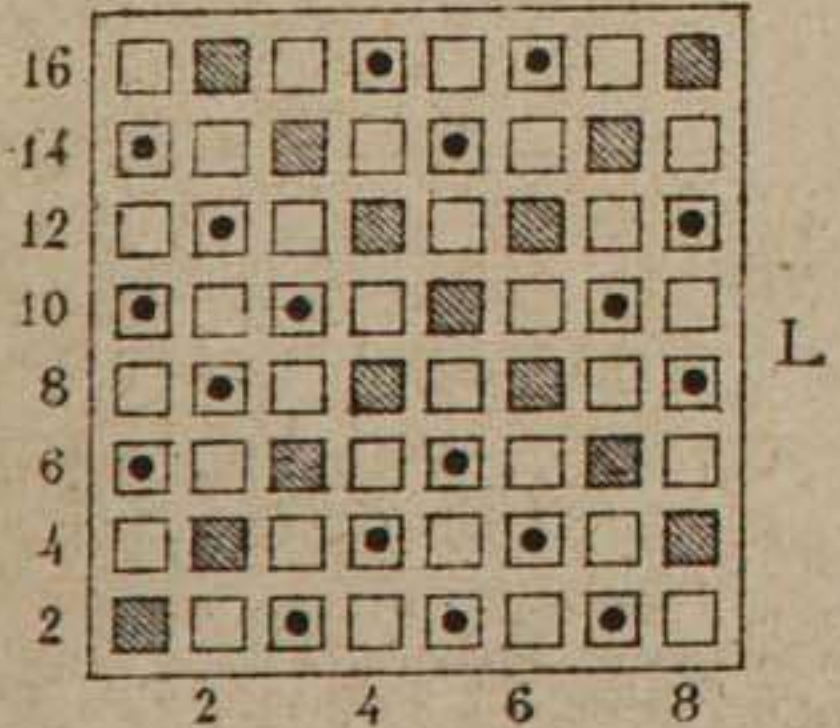


Fig. 225.

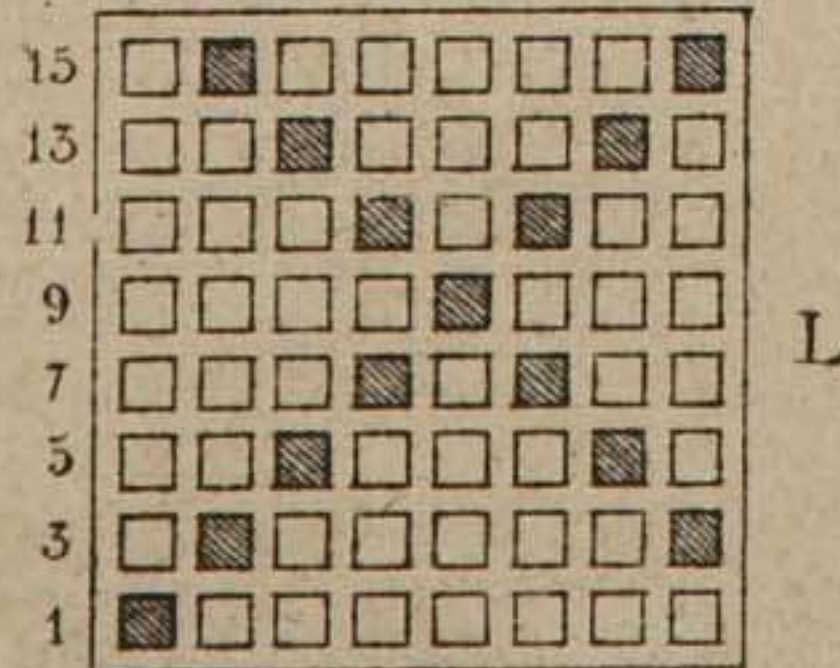


Fig. 227.

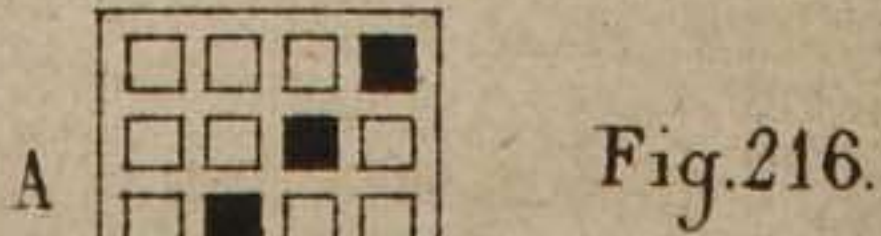
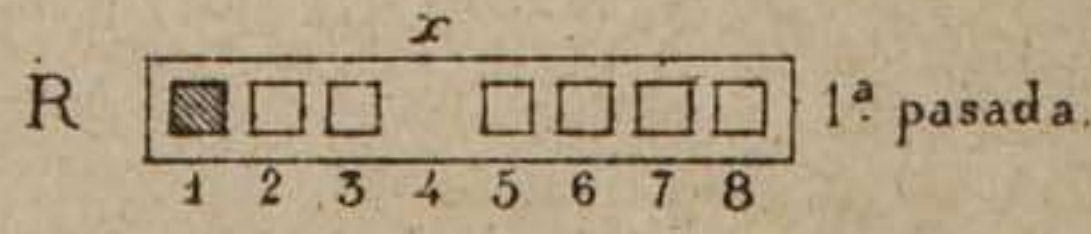


Fig. 331.

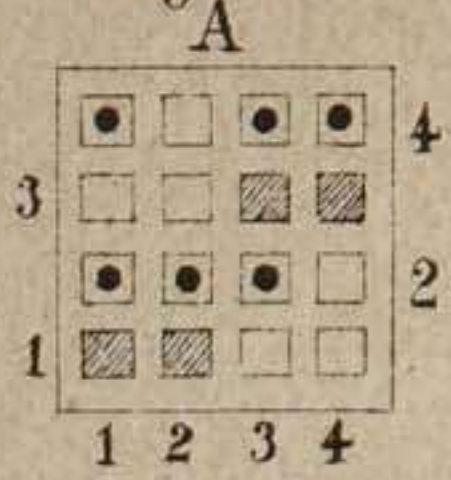


Fig. 232.

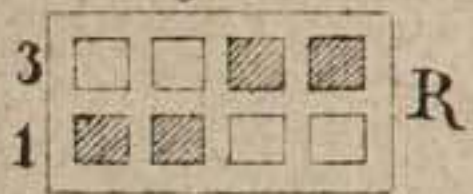


Fig. 233.

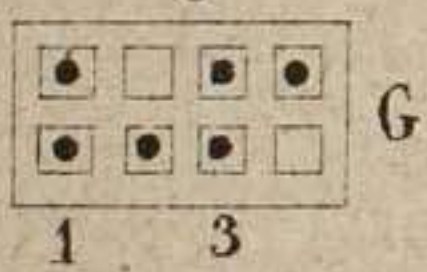


Fig. 230.

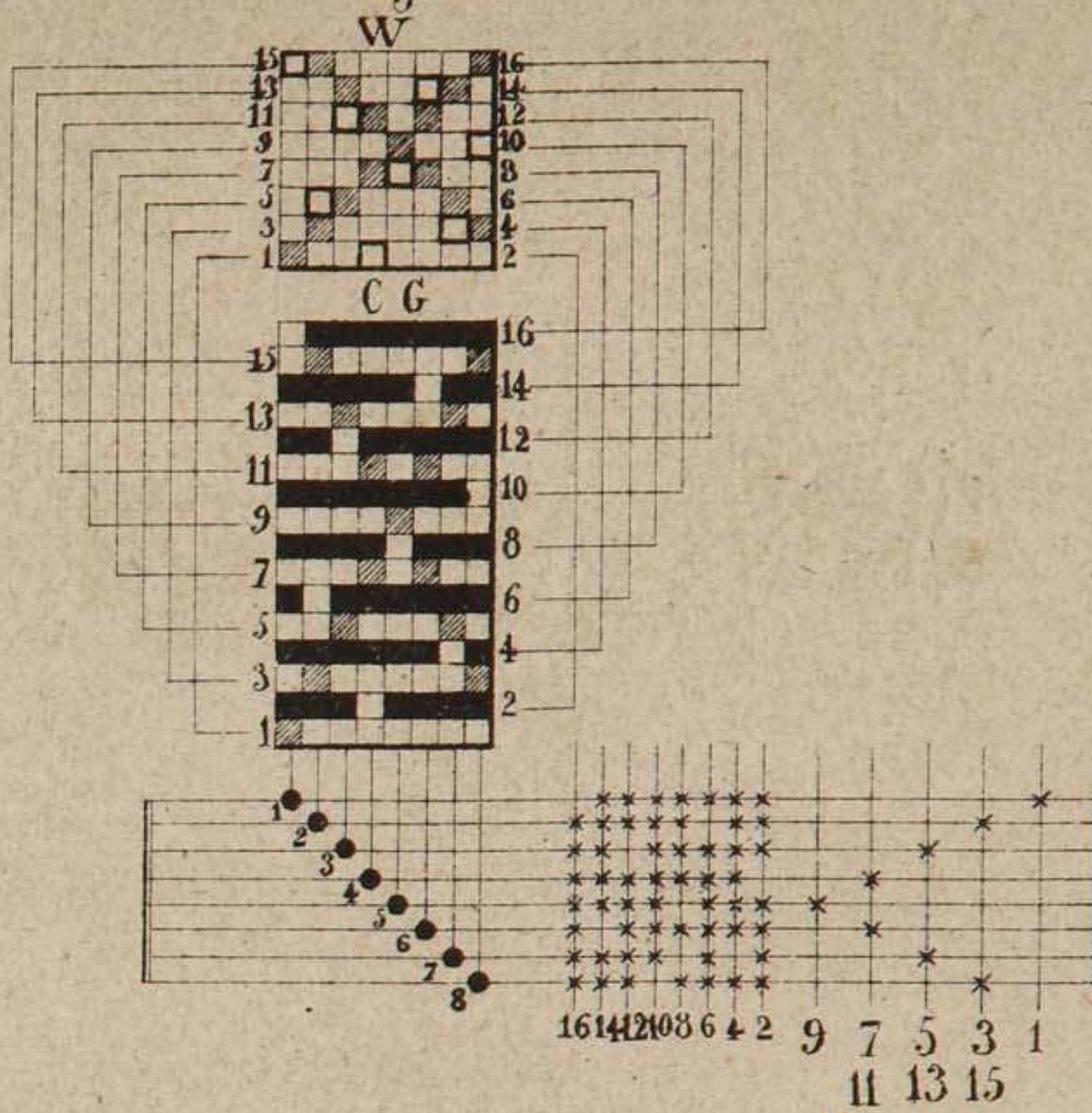


Fig. 229.

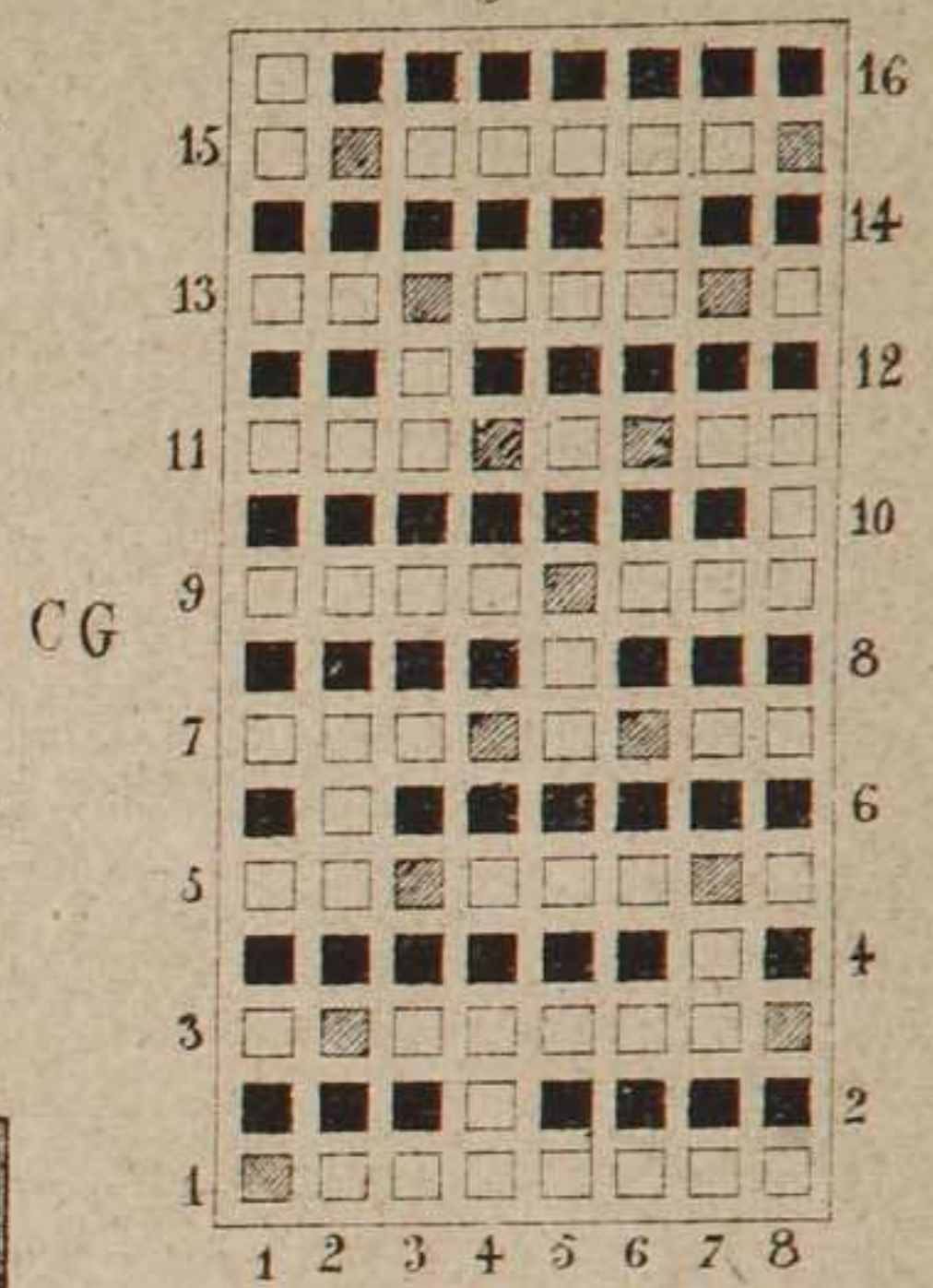


Fig. 237.

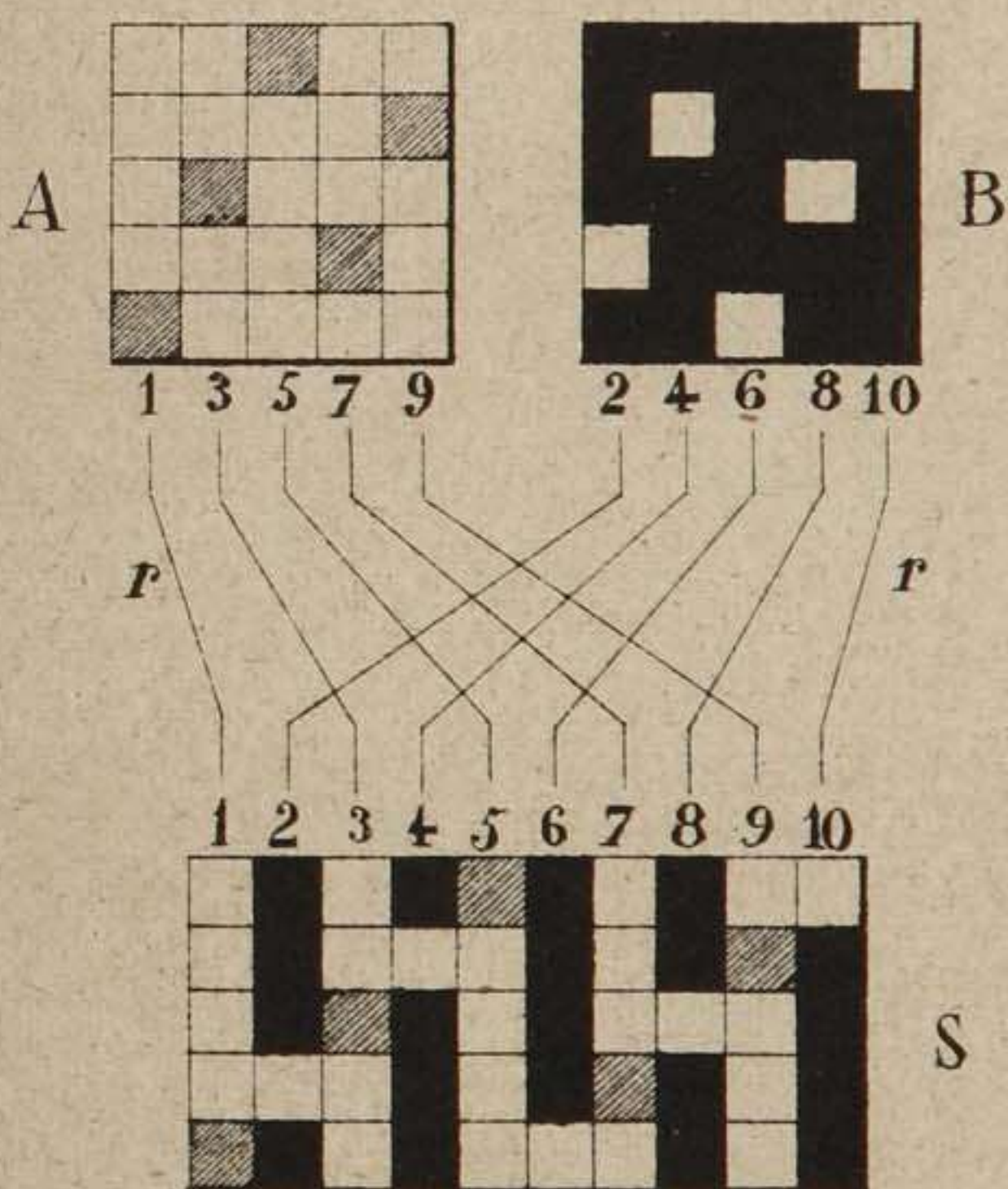


Fig. 234.

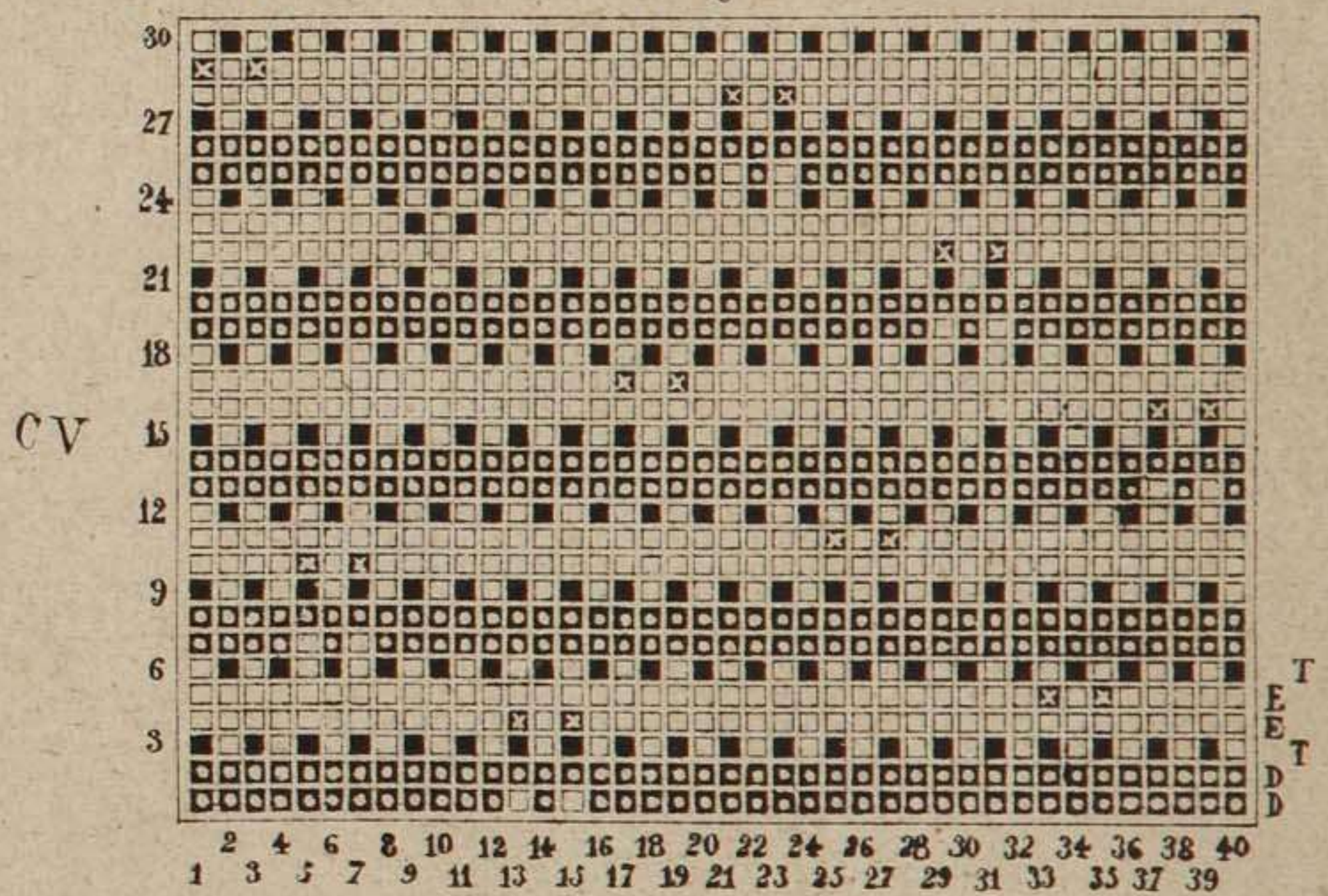


Fig. 235.

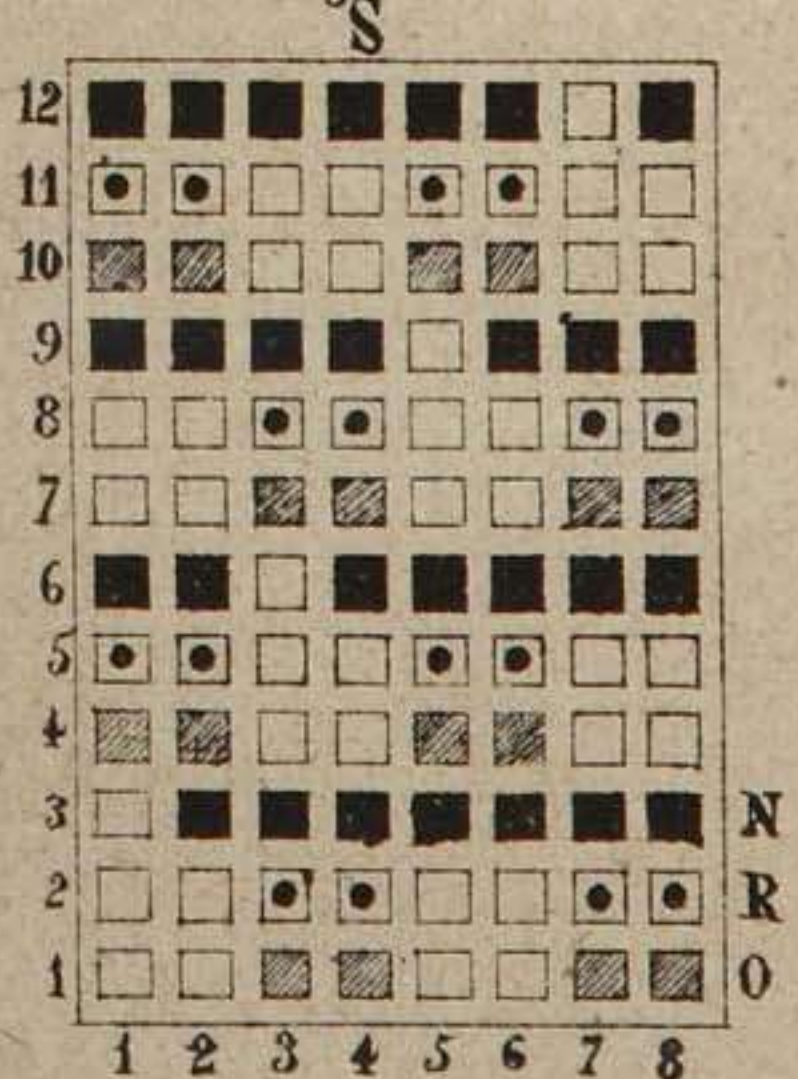


Fig. 238.

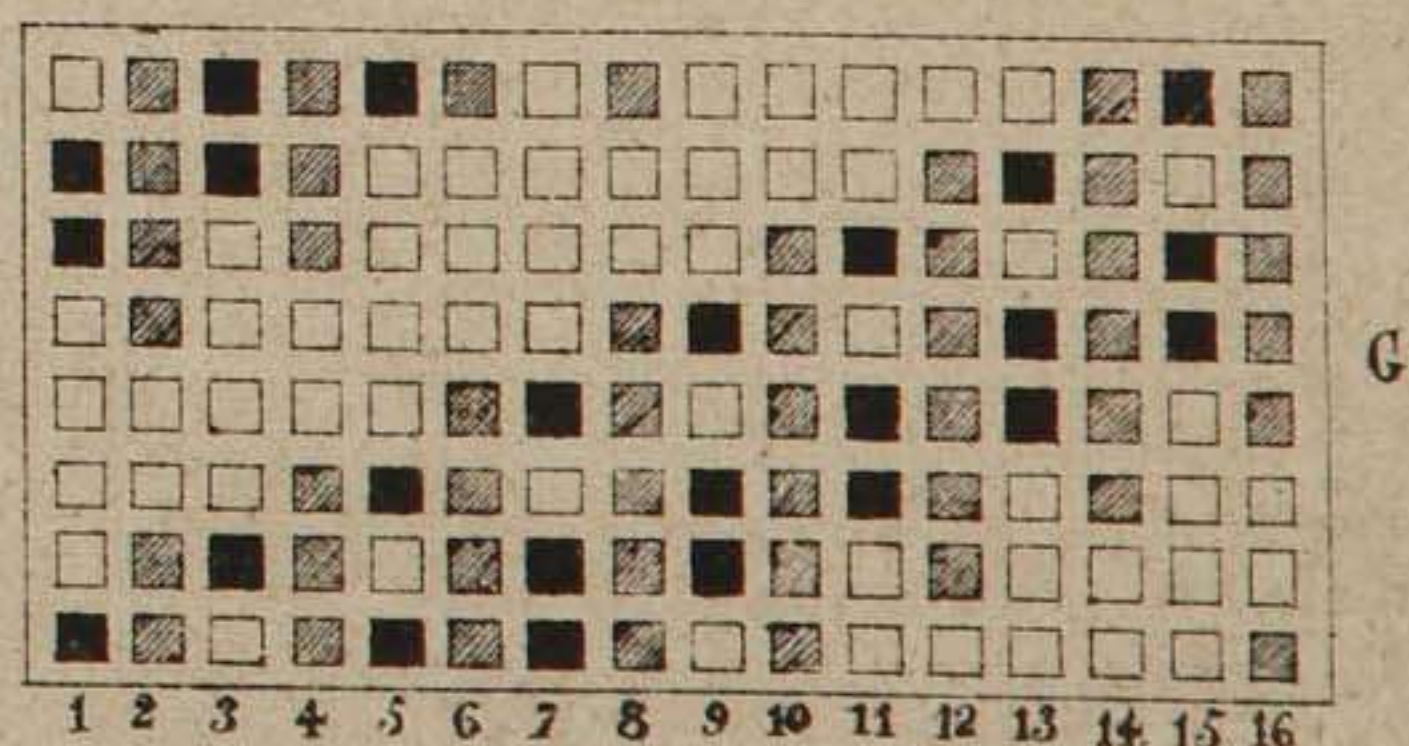
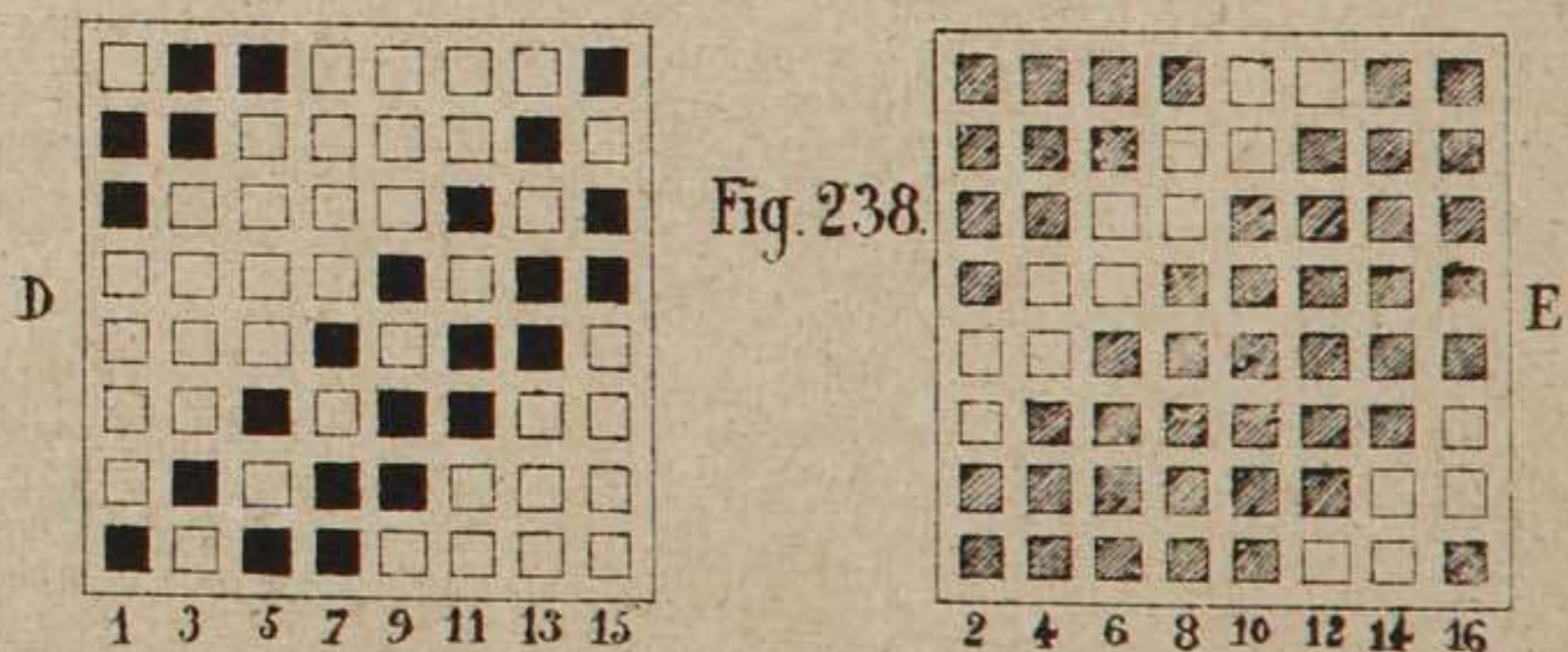


Fig. 239.

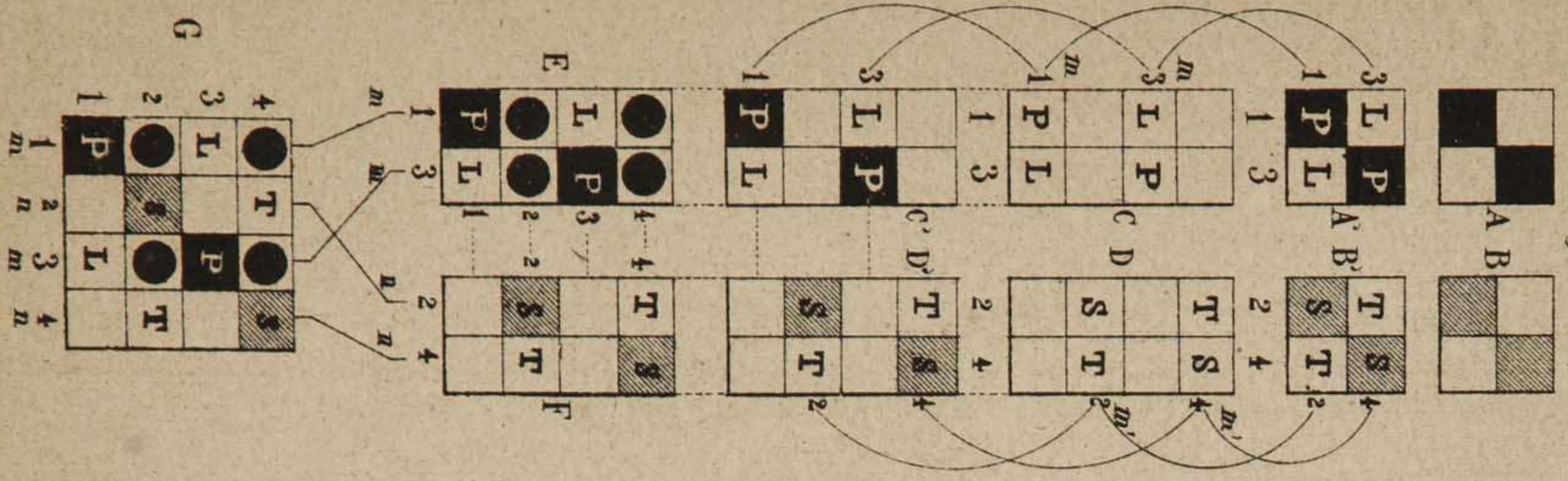


Fig. 236.

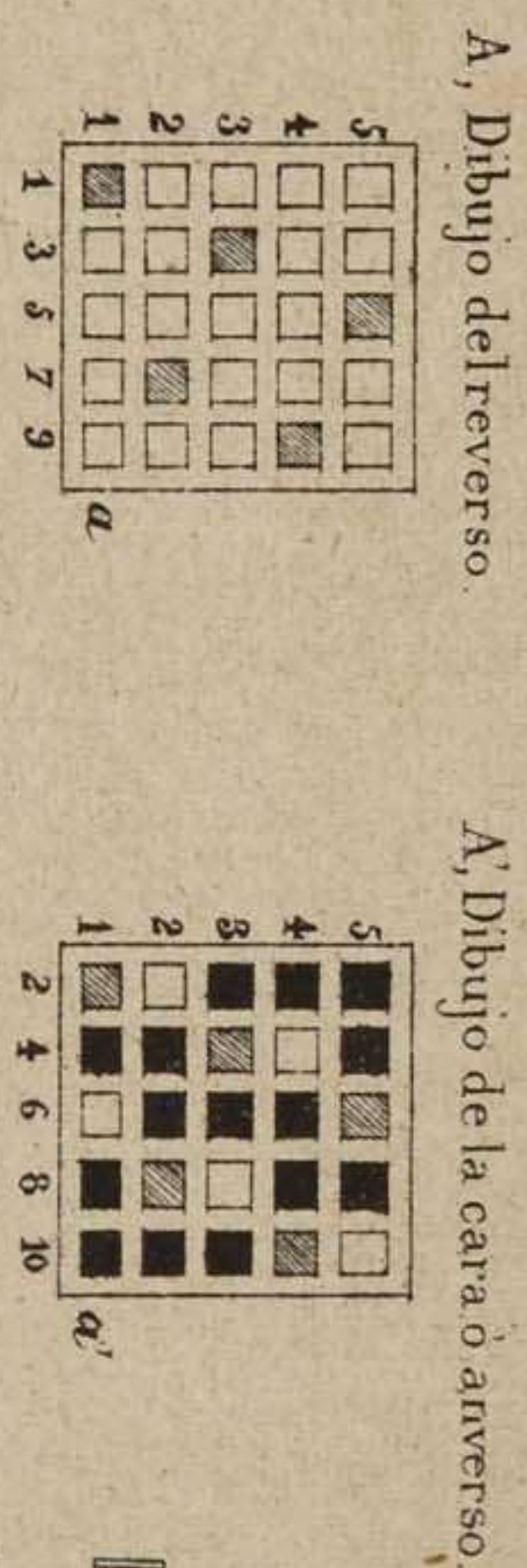


Fig. 248.

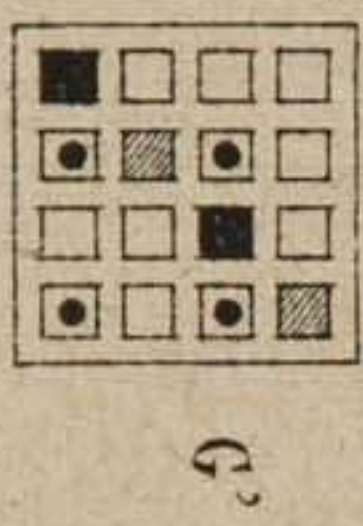


Fig. 240.

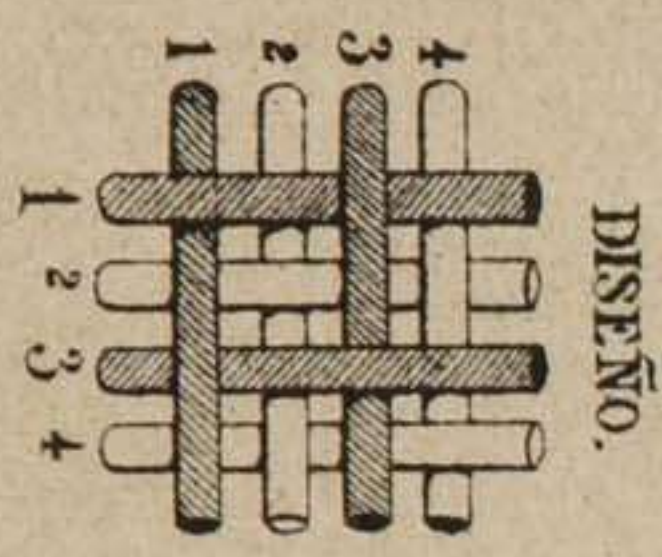


Fig. 243.

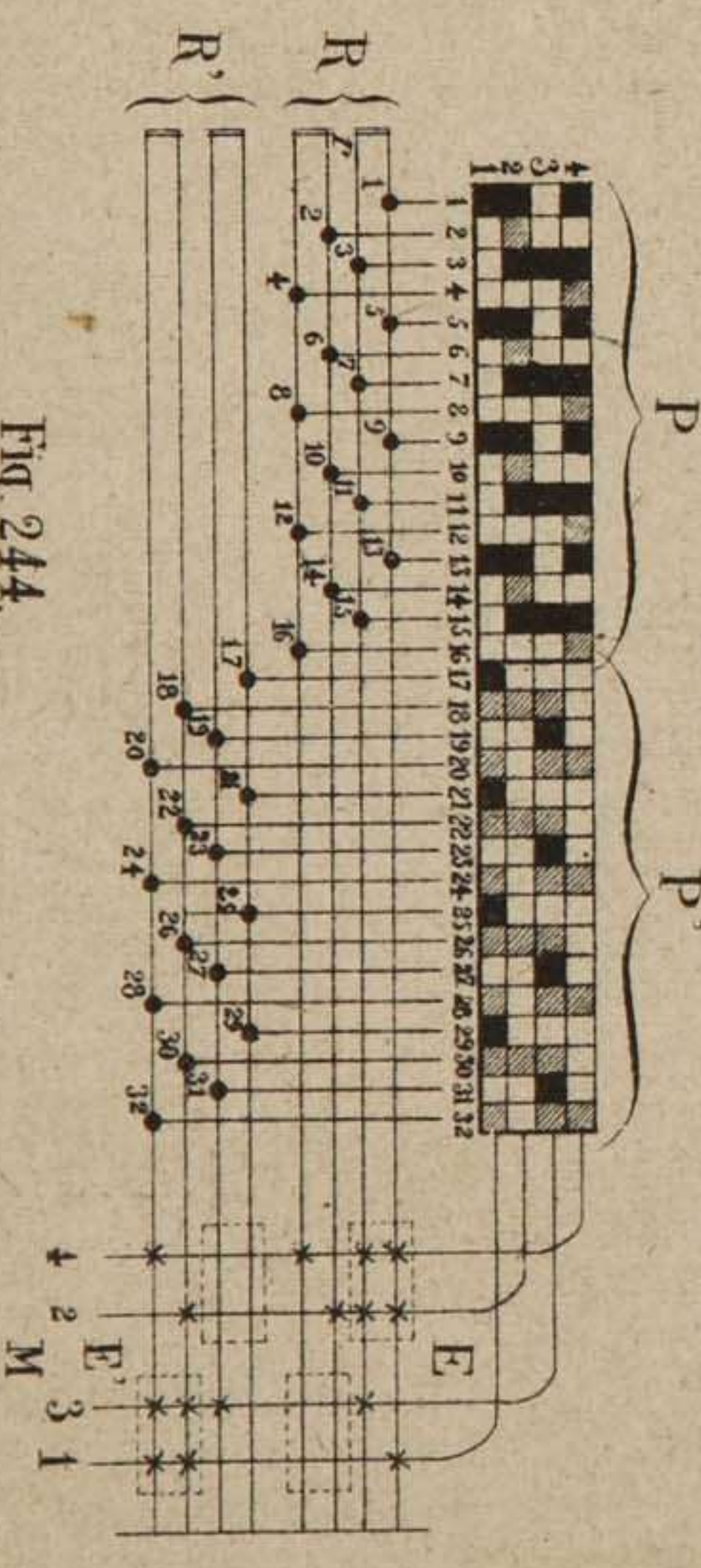


Fig. 244.



Fig. 245.

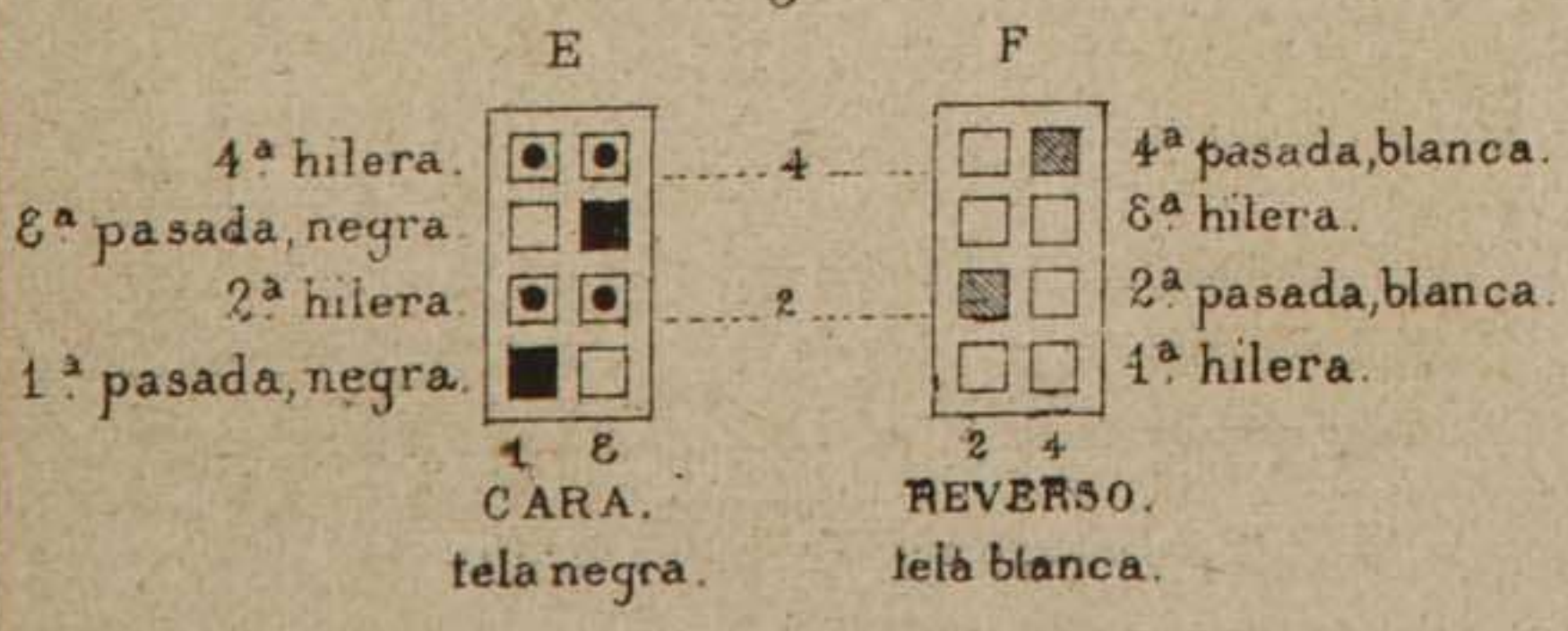


Fig. 241.

TAFETAN DOBLE

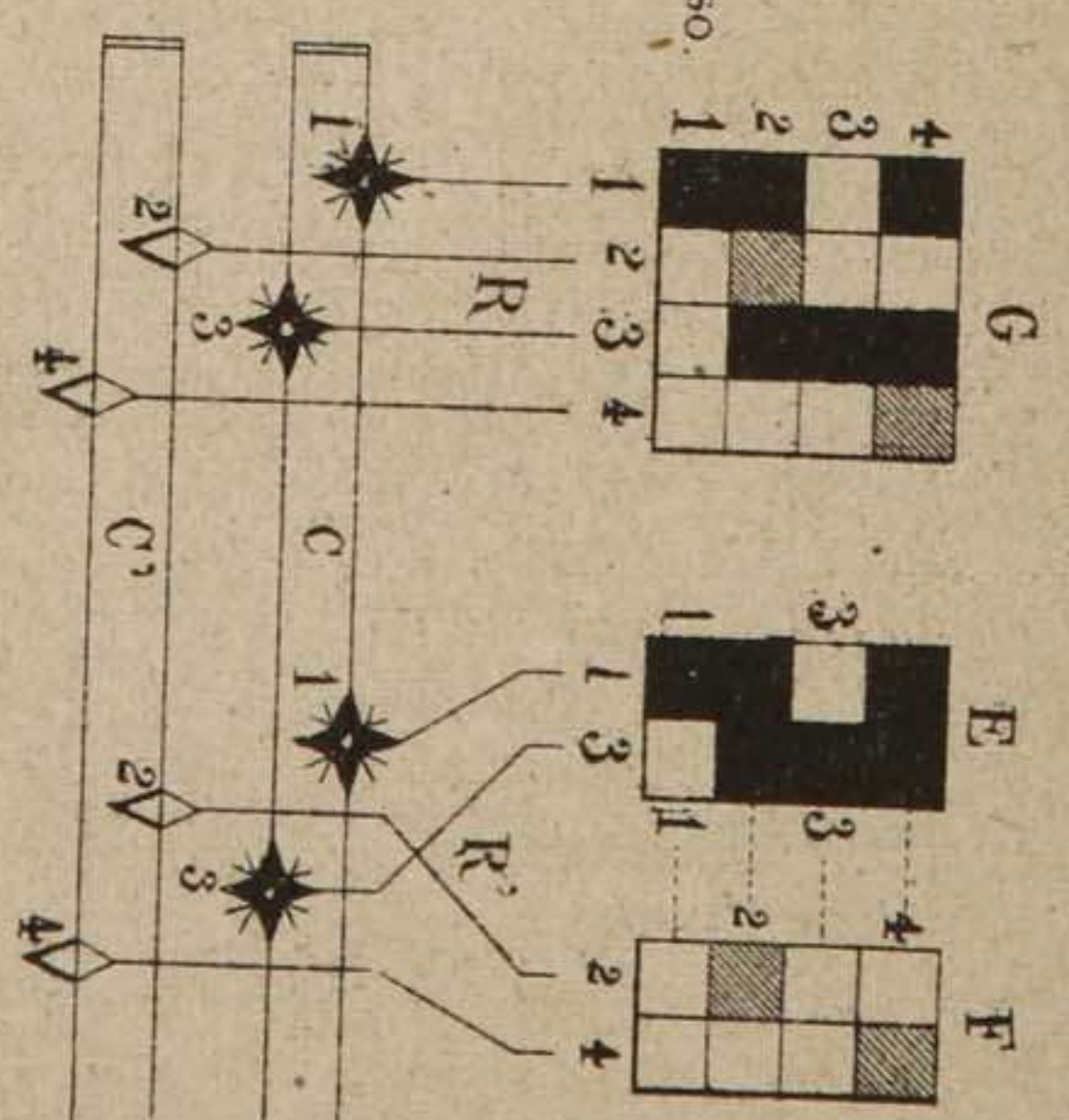


Fig. 242.

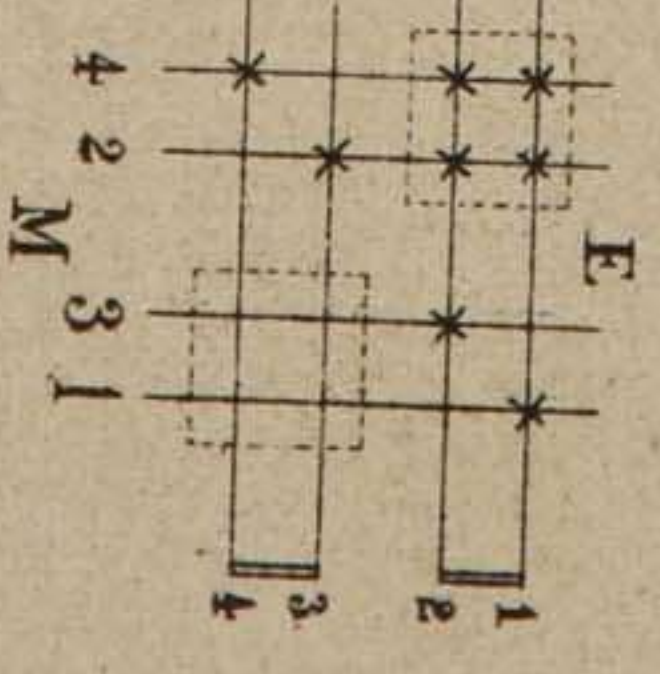
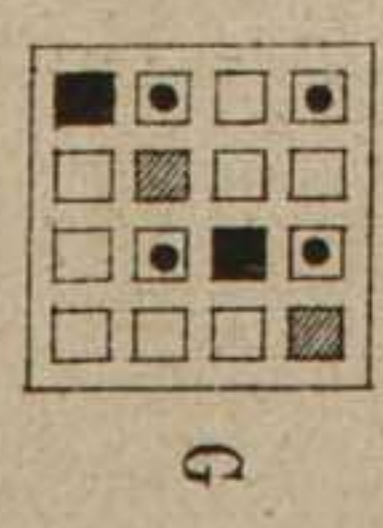


Fig. 247.



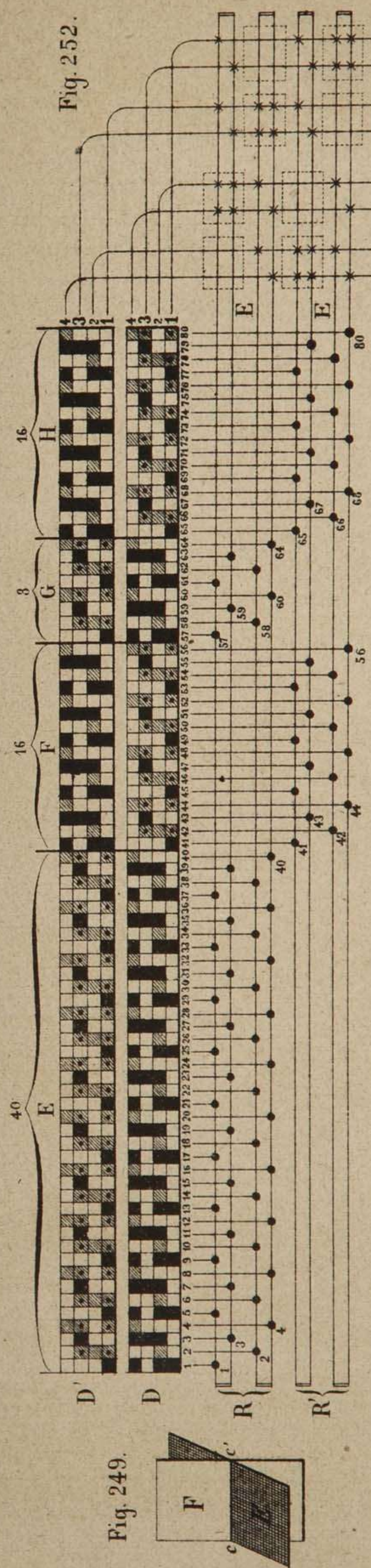


Fig. 249.

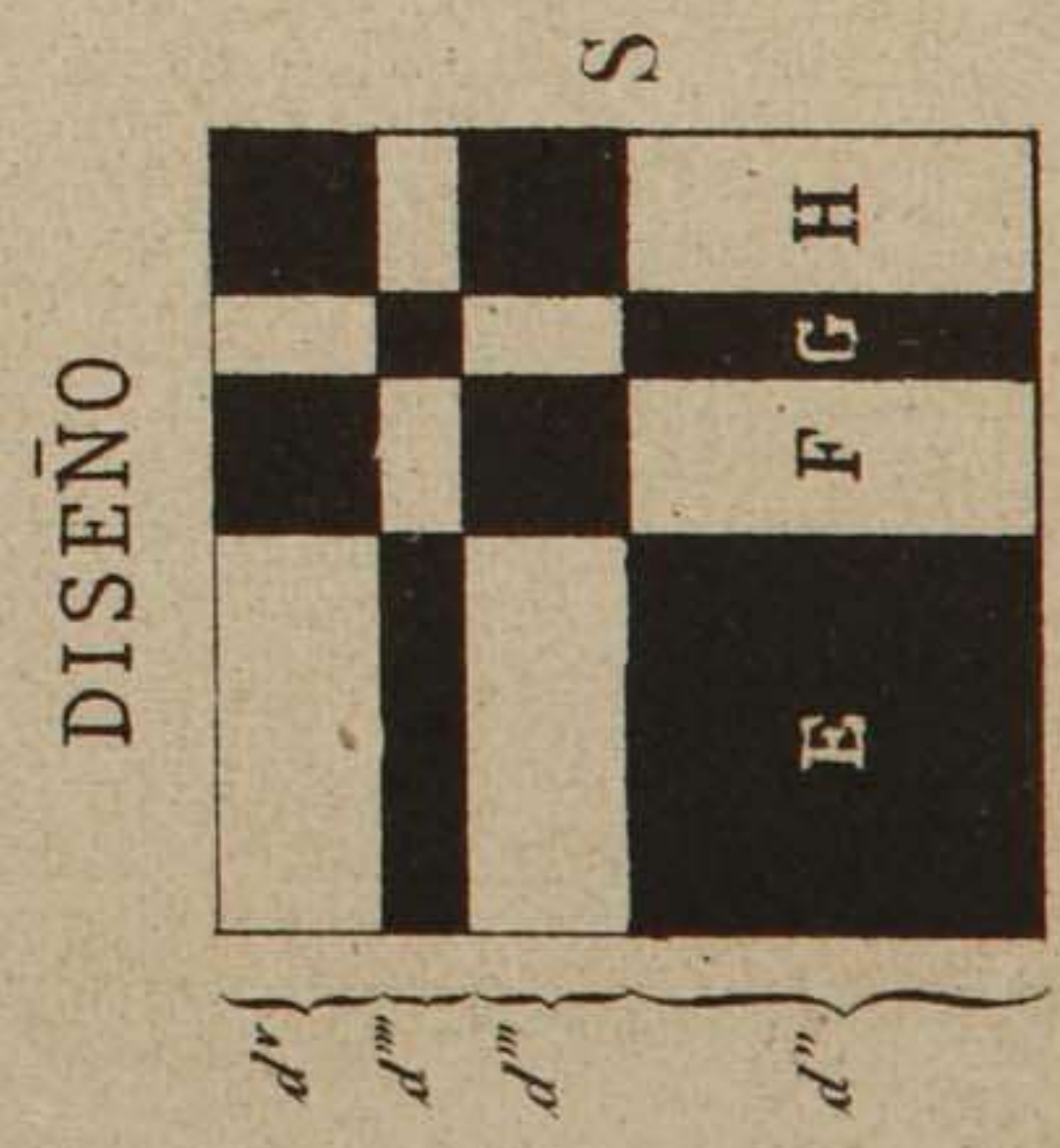


Fig. 253.

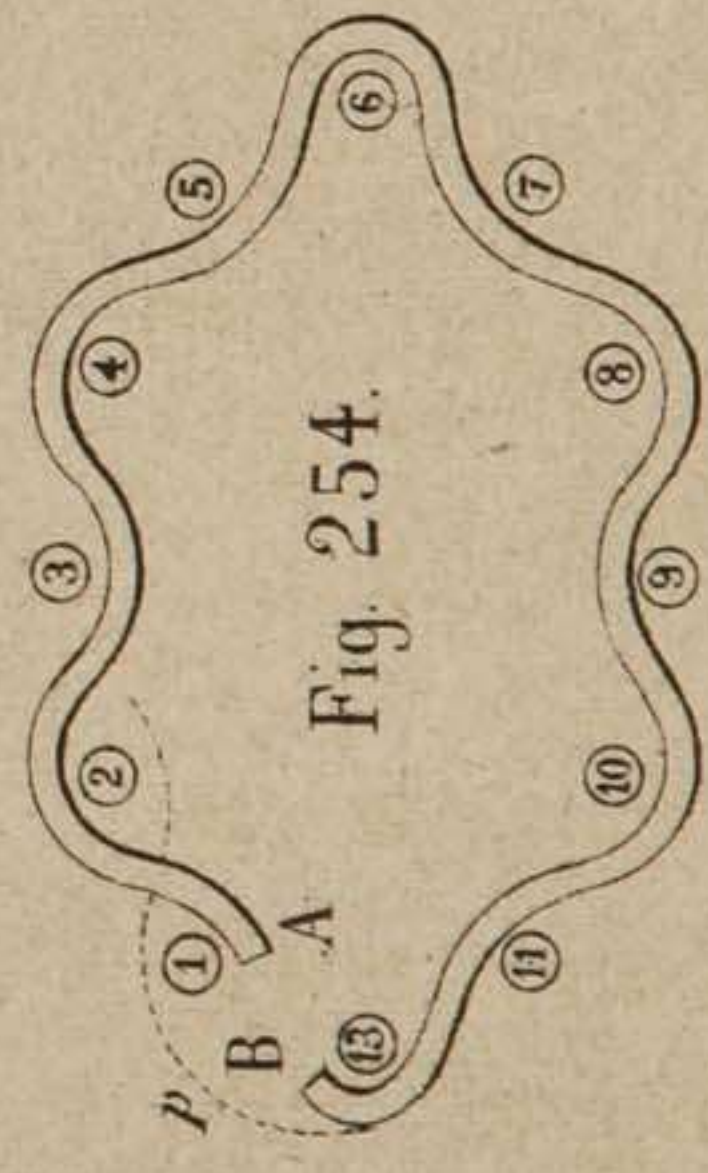


Fig. 254.

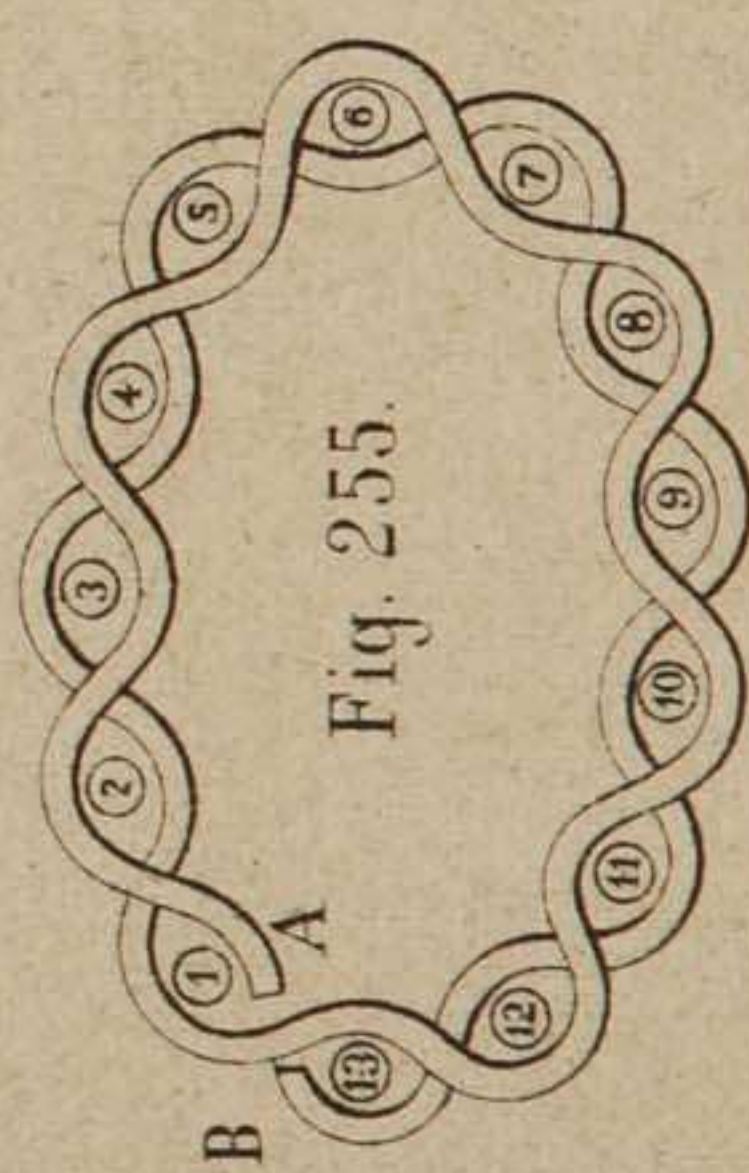


Fig. 255.

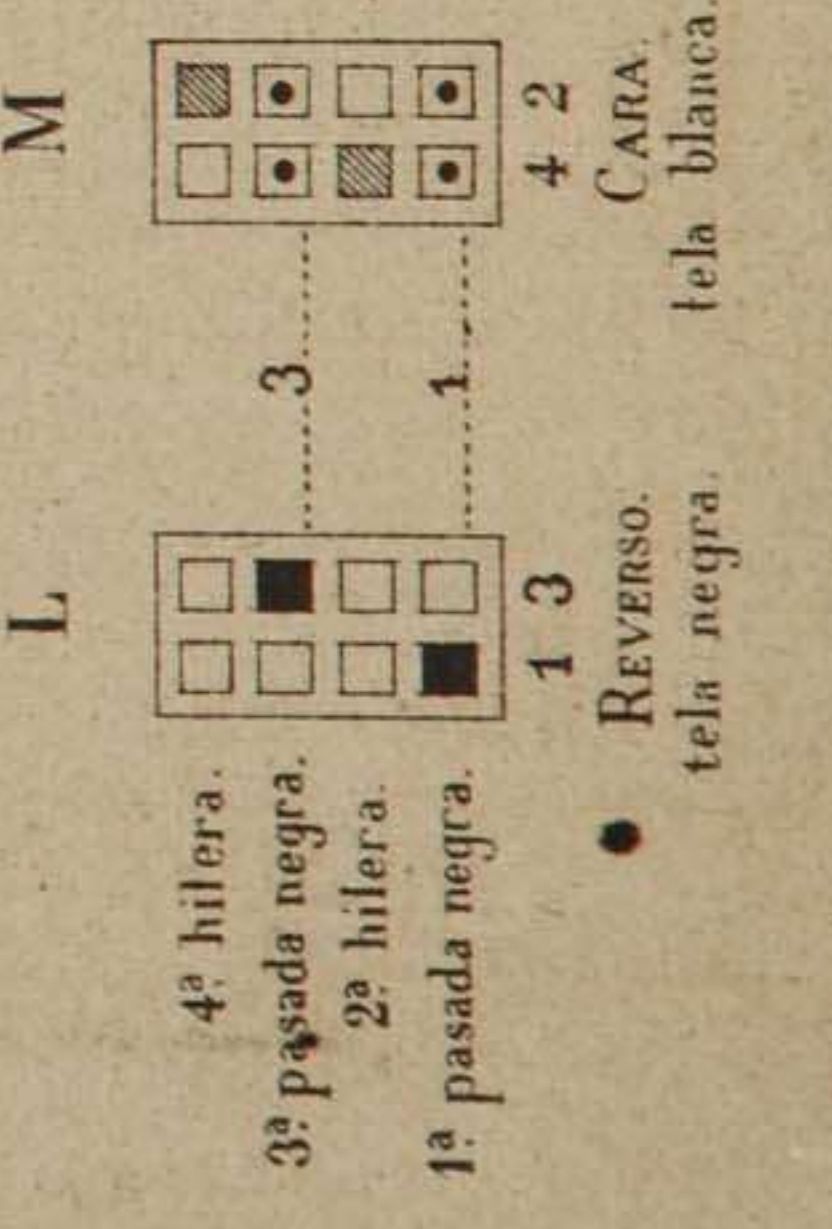


Fig. 246.

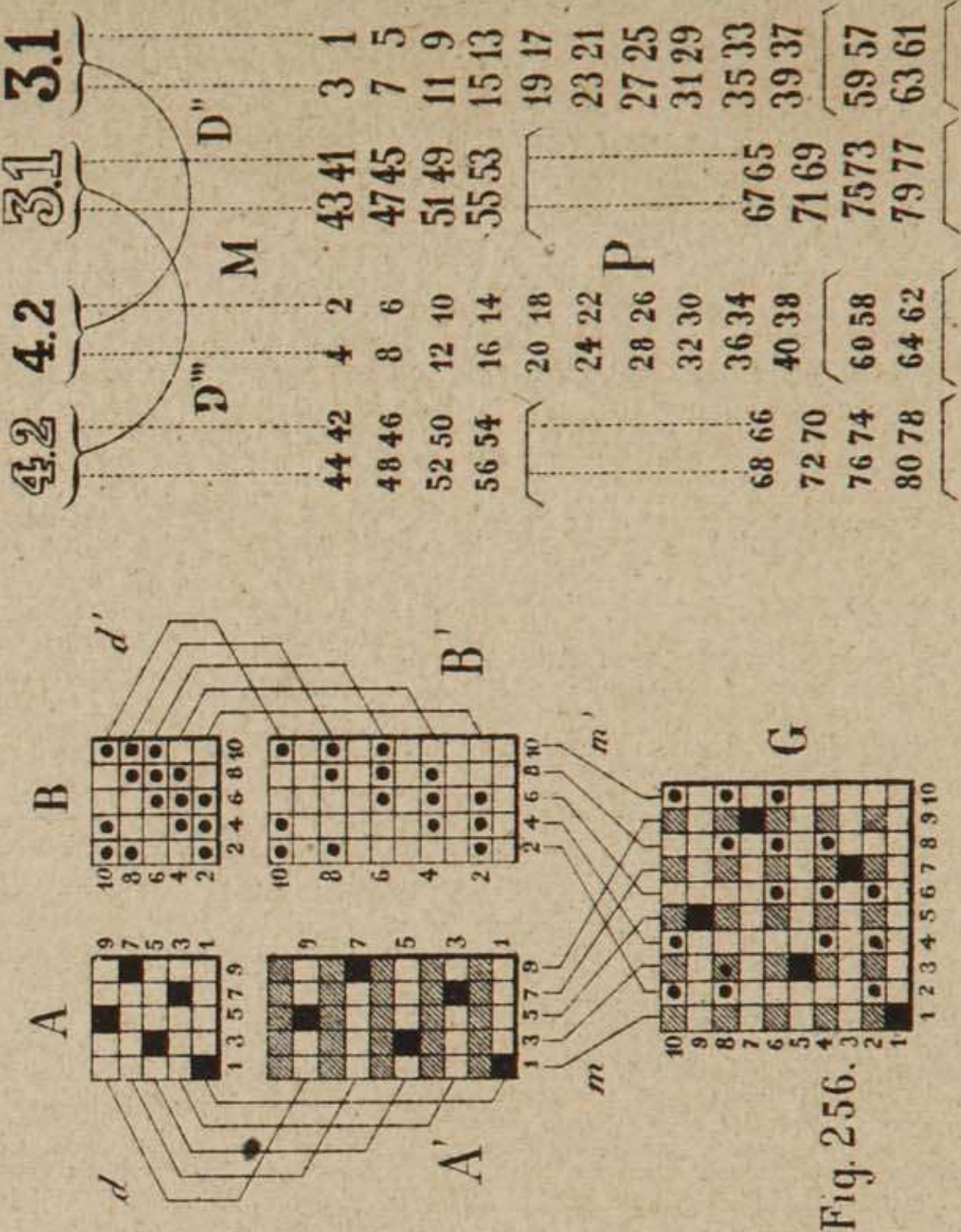


Fig. 256.

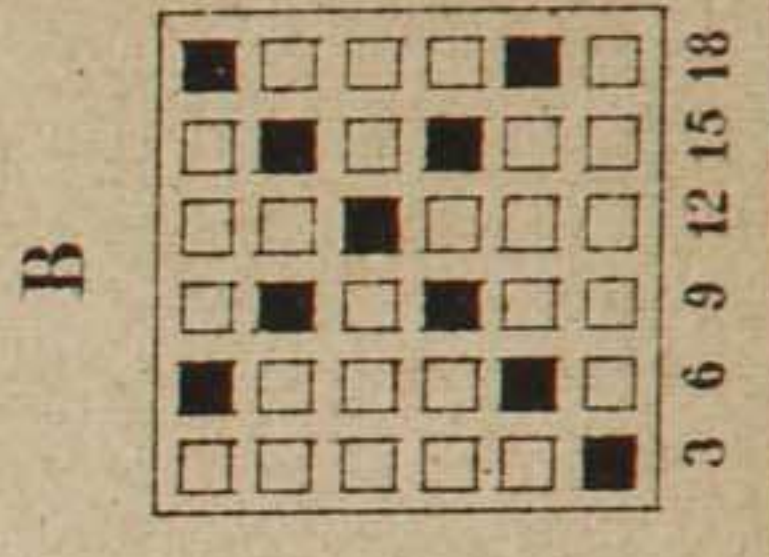


Fig. 257.

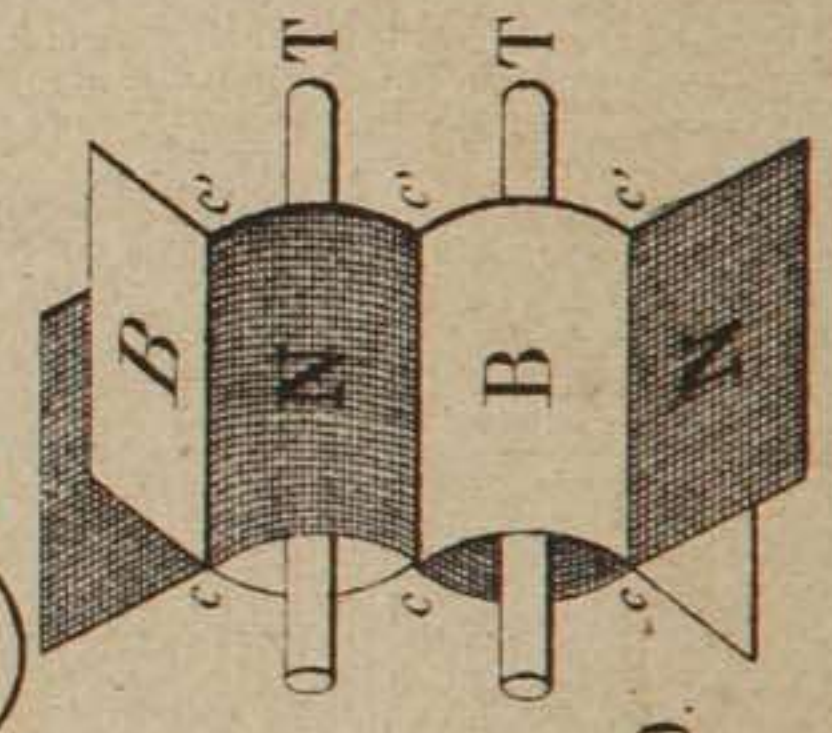


Fig. 250.

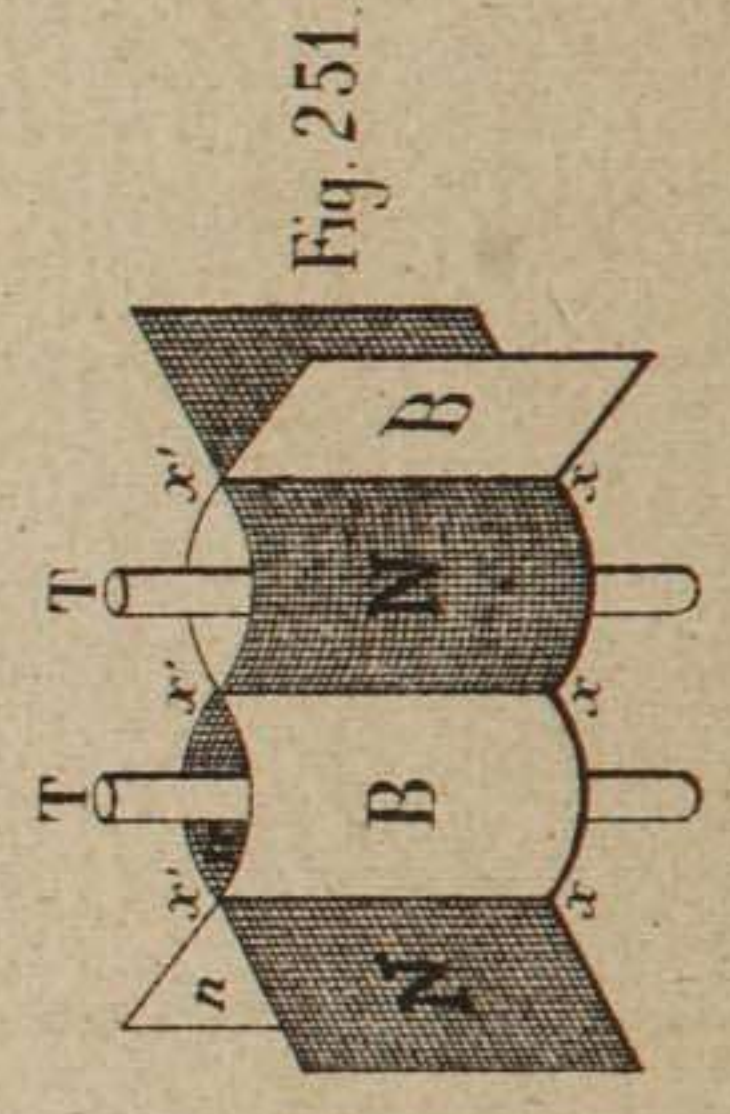
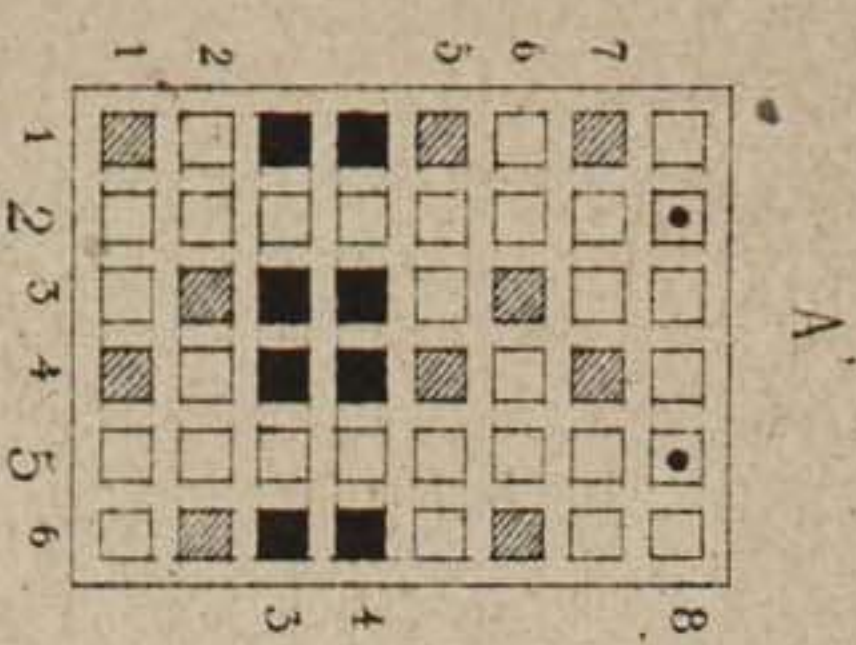


Fig. 251.

Fig 261.



A

Fig 263.

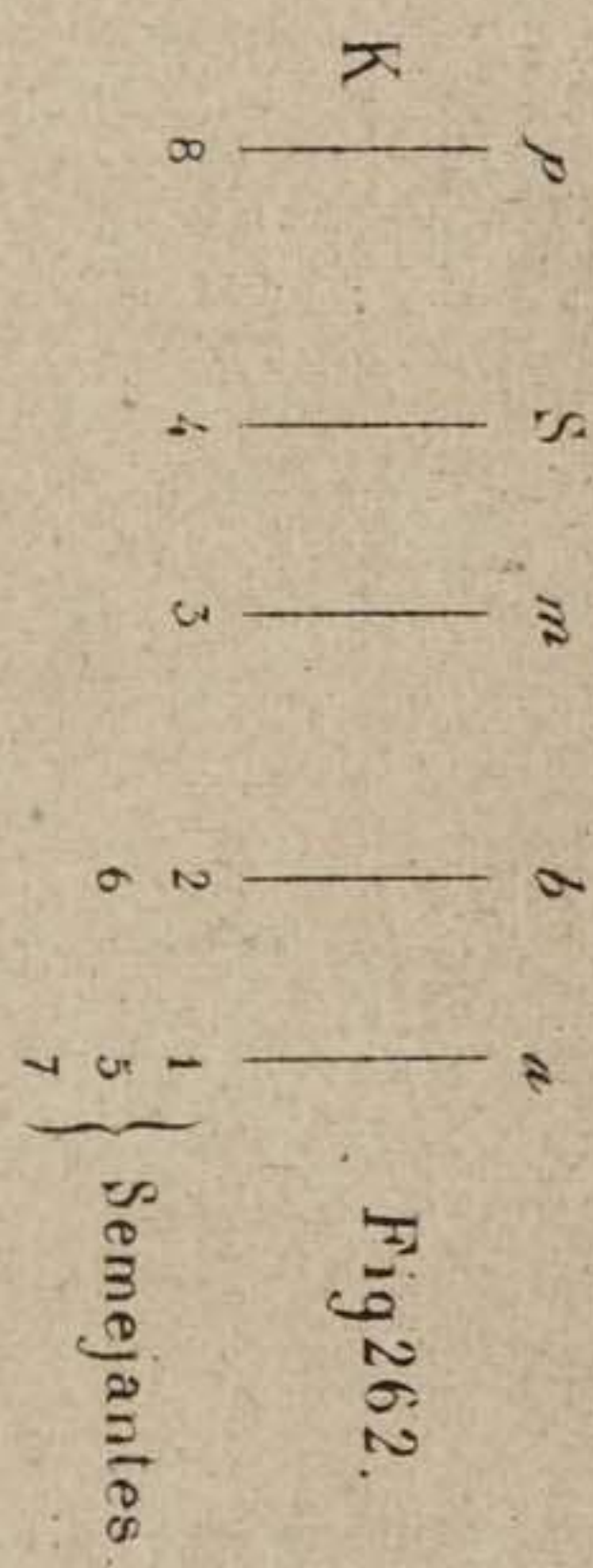
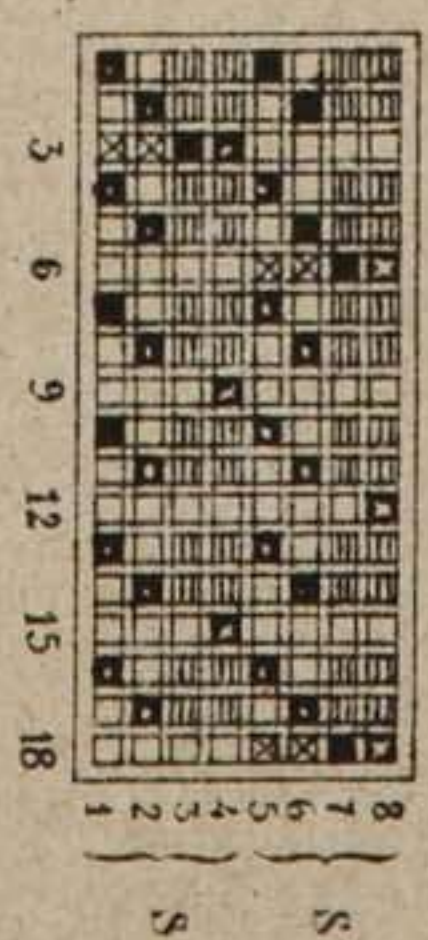


Fig 262.

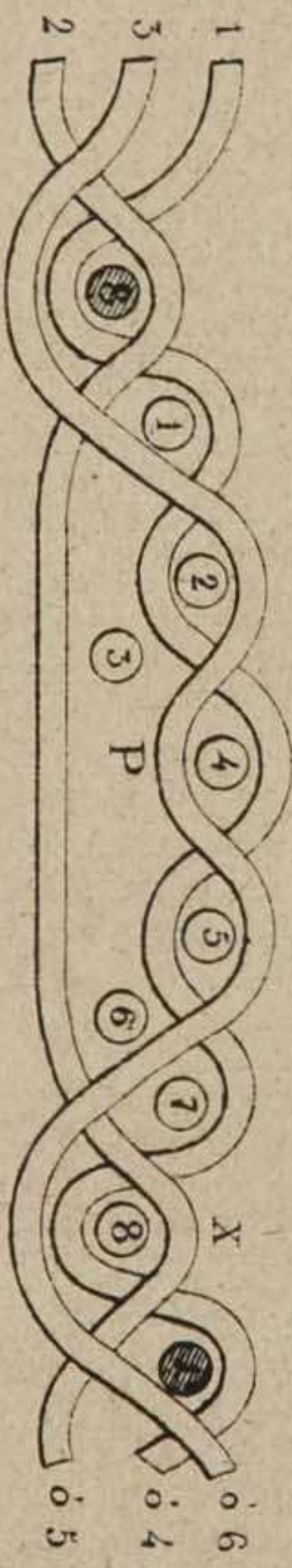
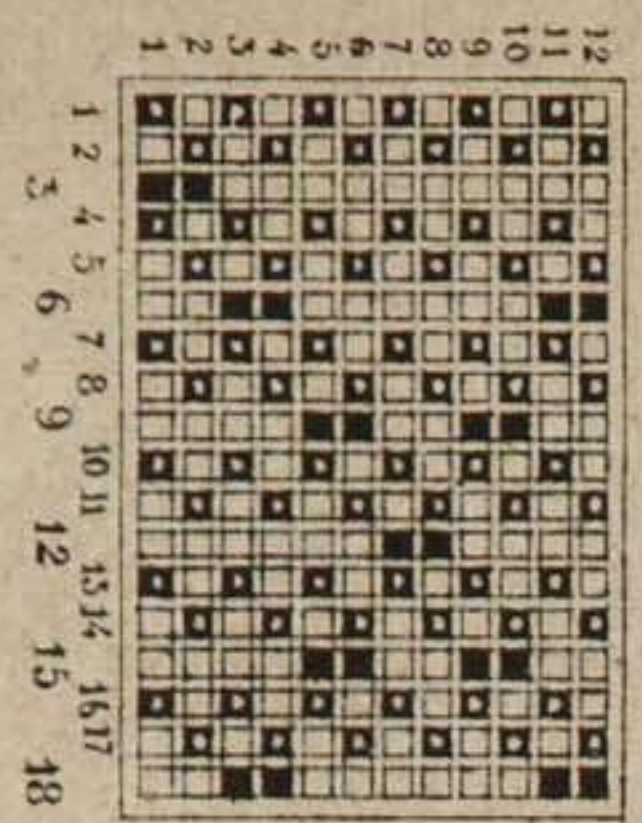
Fig. 260.



A B M

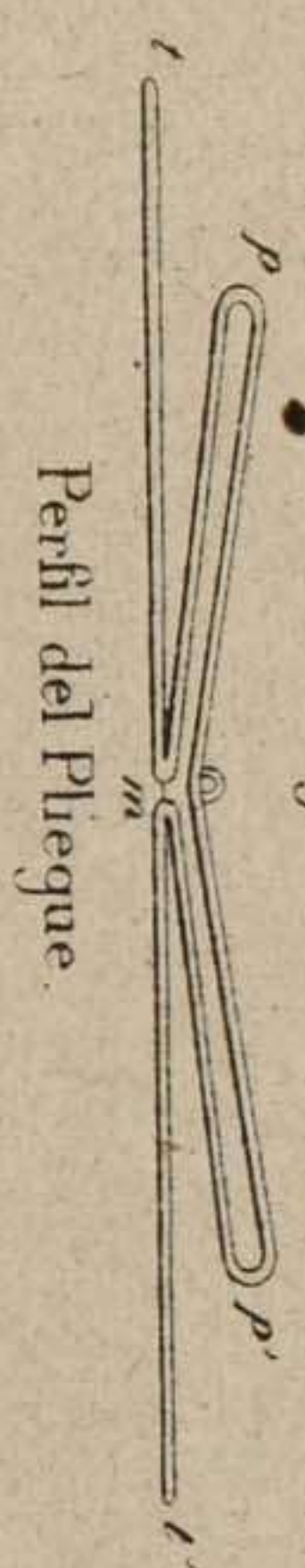
Fig 258

AB



Perfil del Piqué-Reps.

Fig 264



Perfil del Pliegue.

Ligamiento B

Fig 265

Fig 259.

A' B'

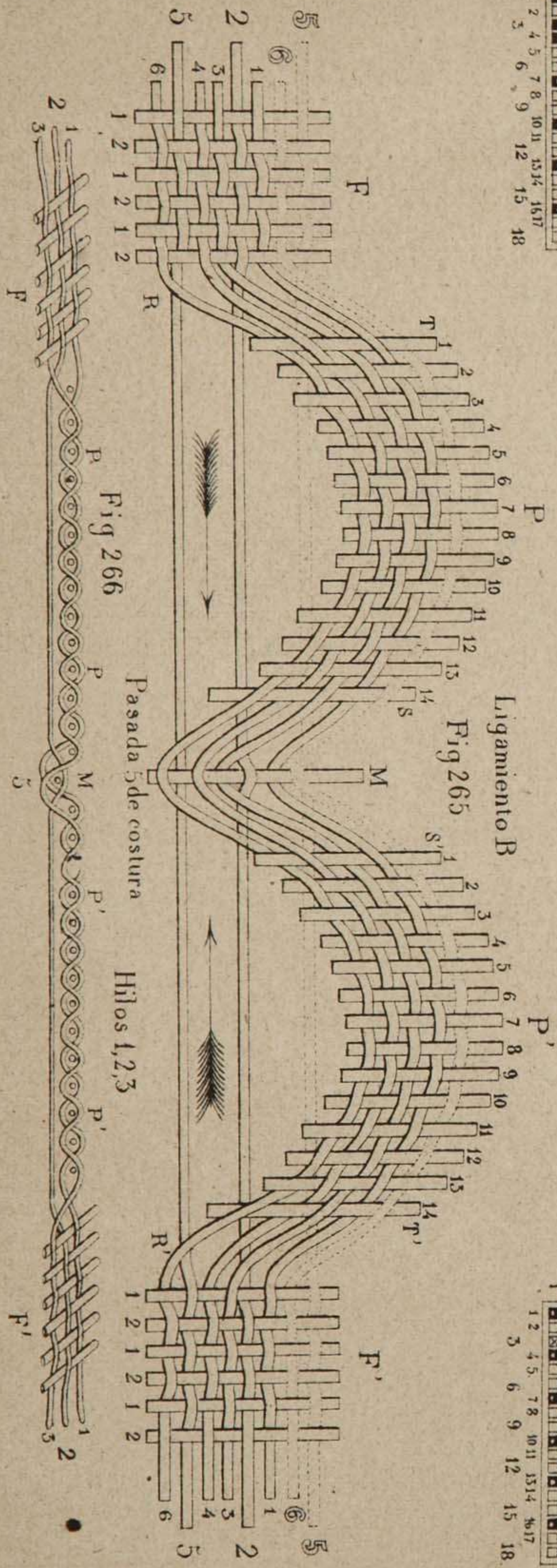
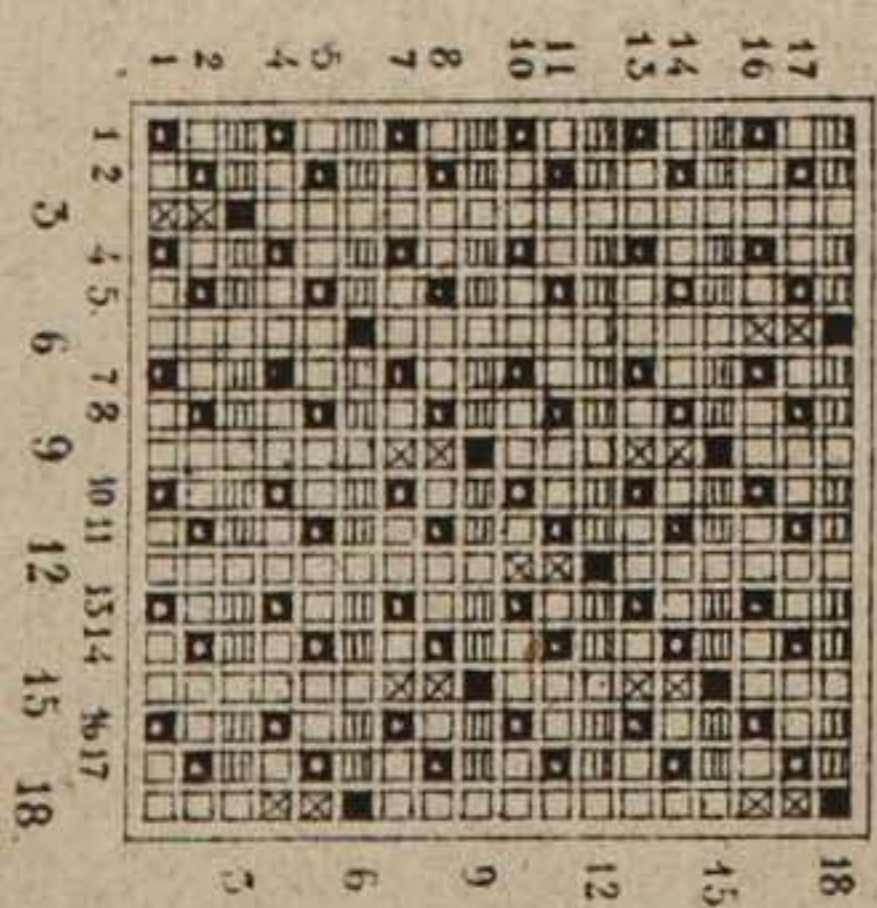


Fig 266

Pasada de costura

Hilos 1,2,3

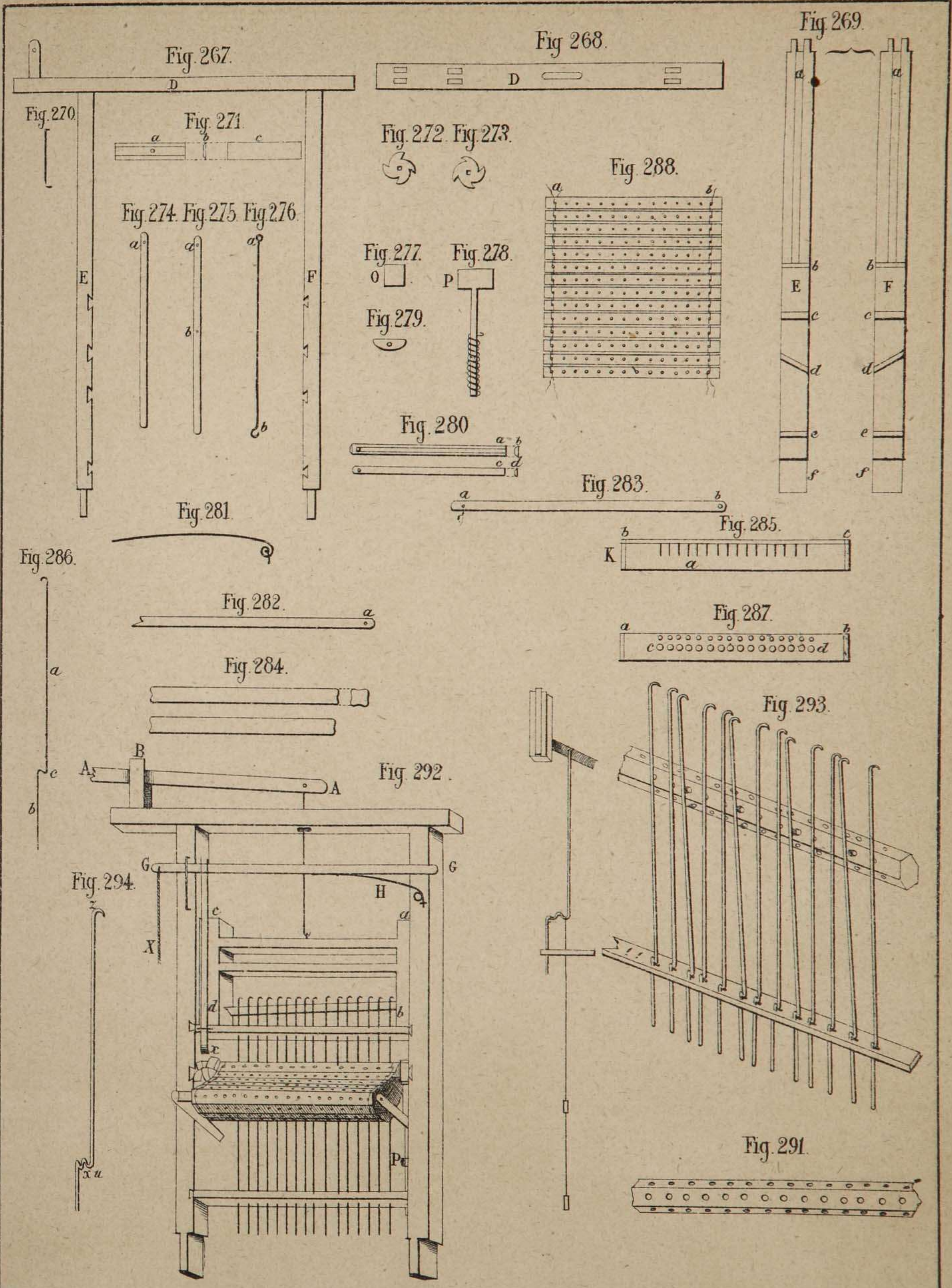


Fig. 295.



Fig. 297.

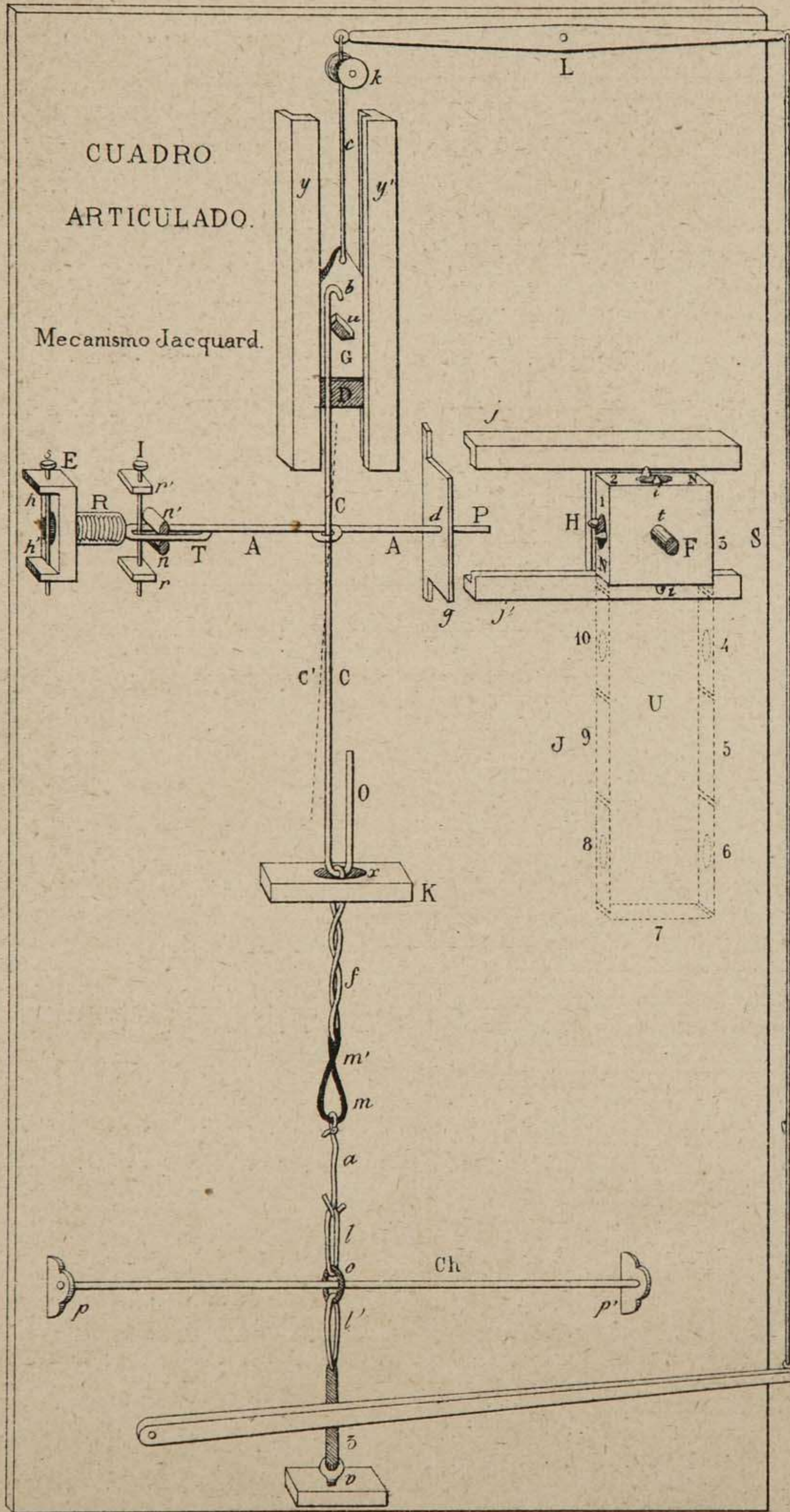


Fig. 298.

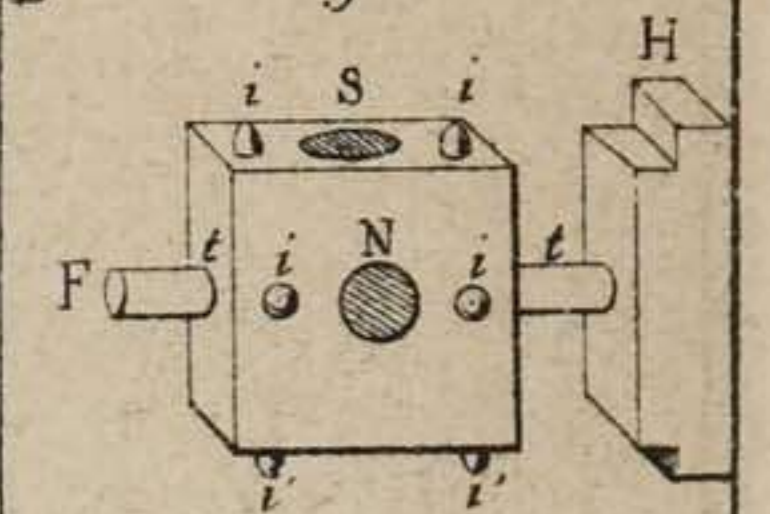


Fig. 296.

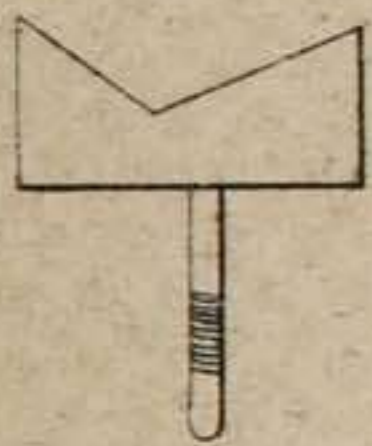


Fig. 299.

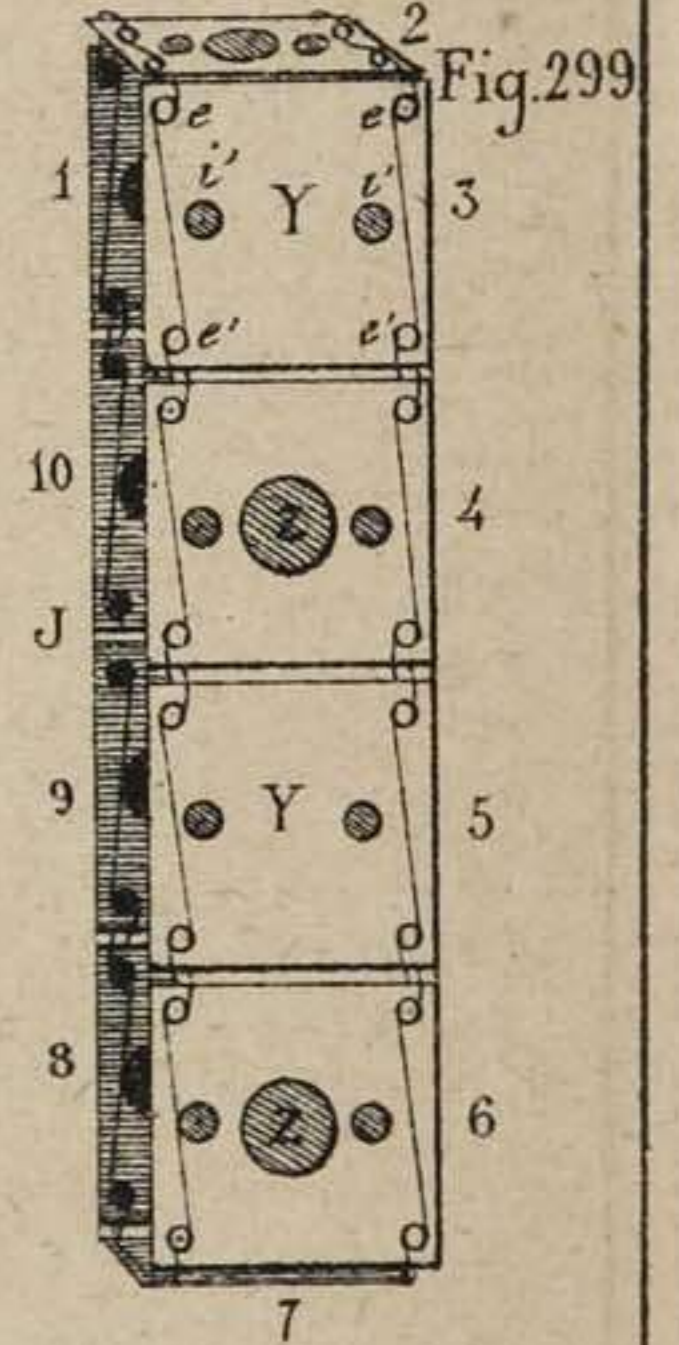
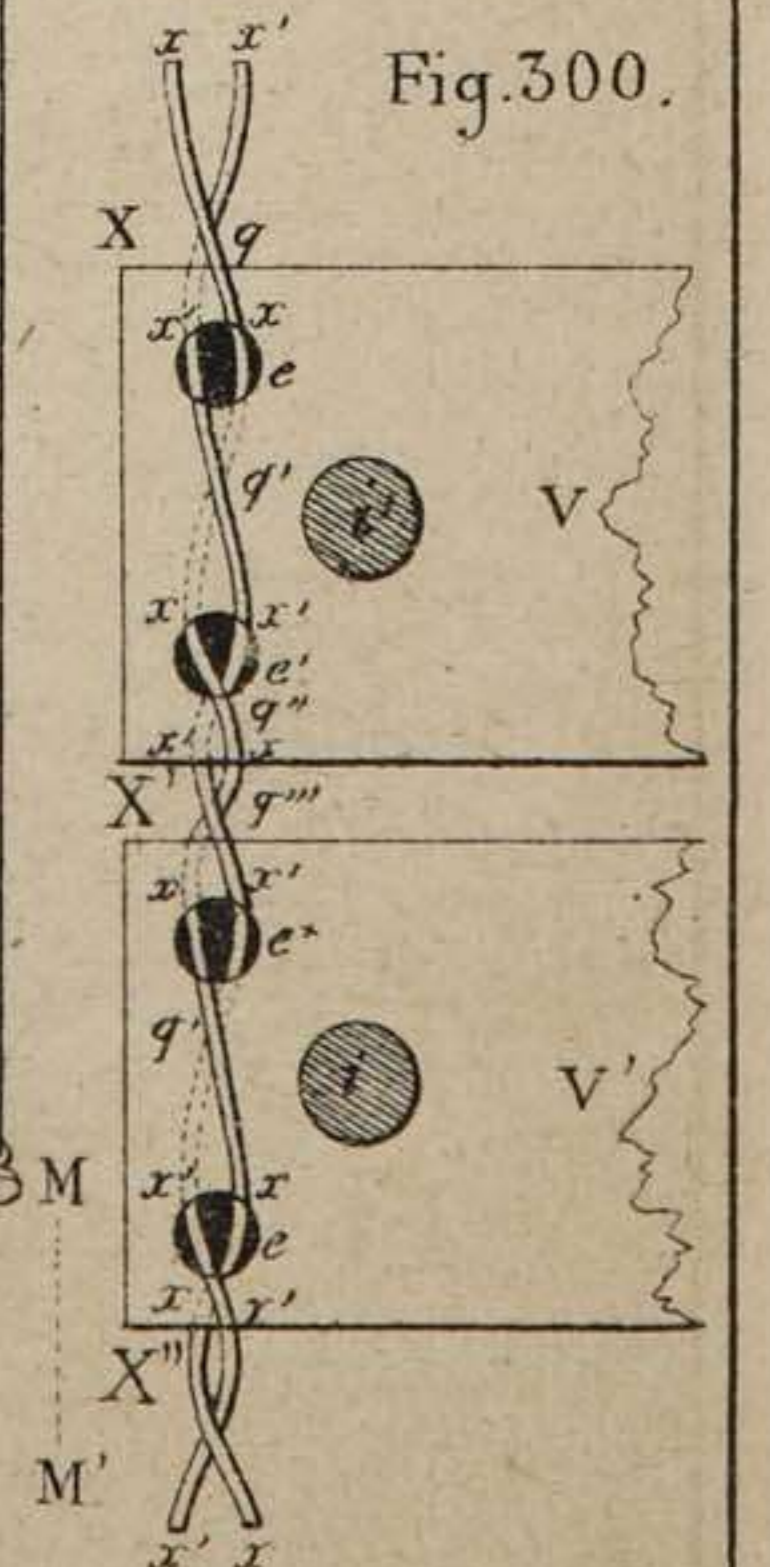


Fig. 289.



Fig. 290.

Fig. 300.



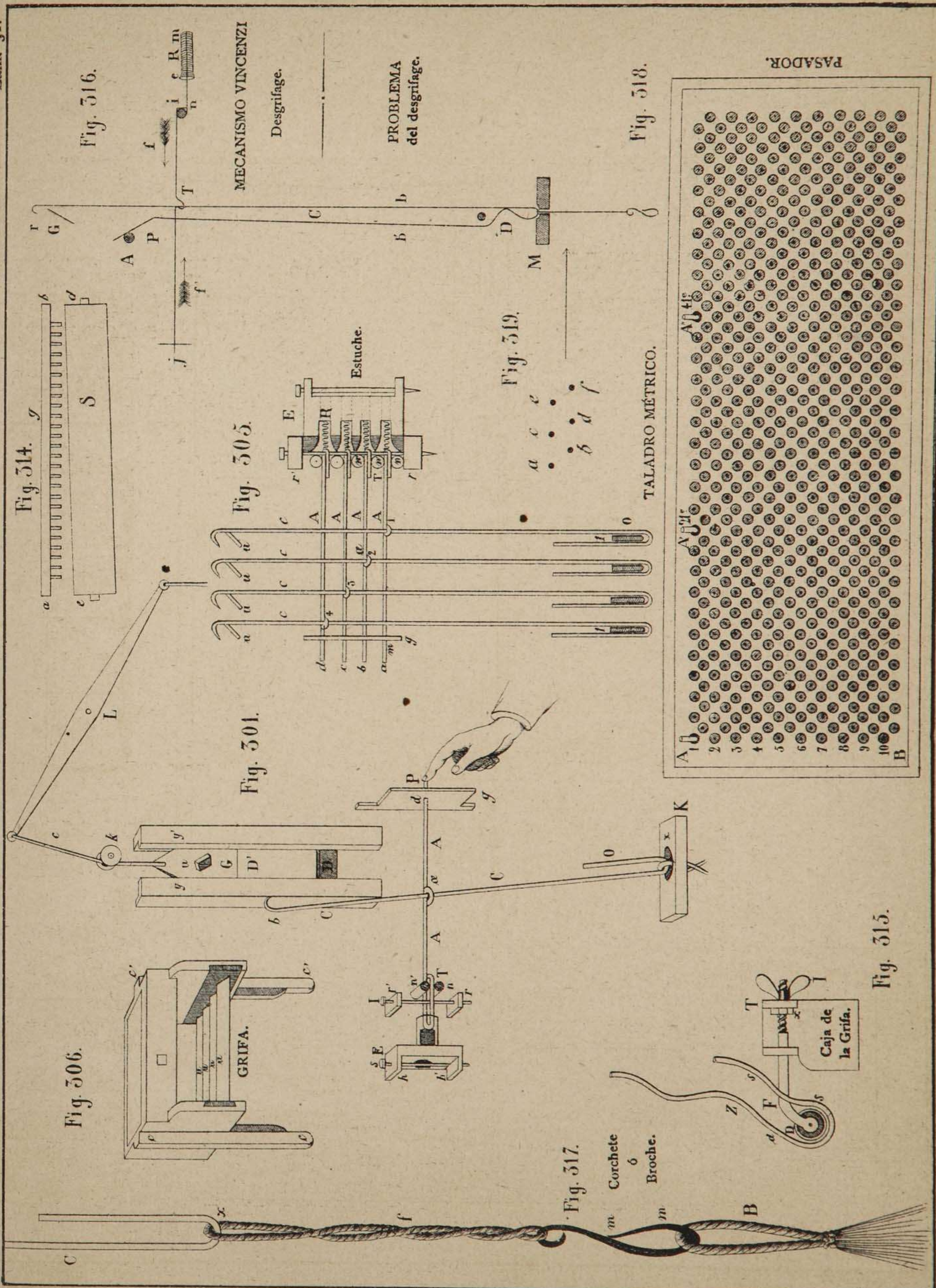


Fig. 302.

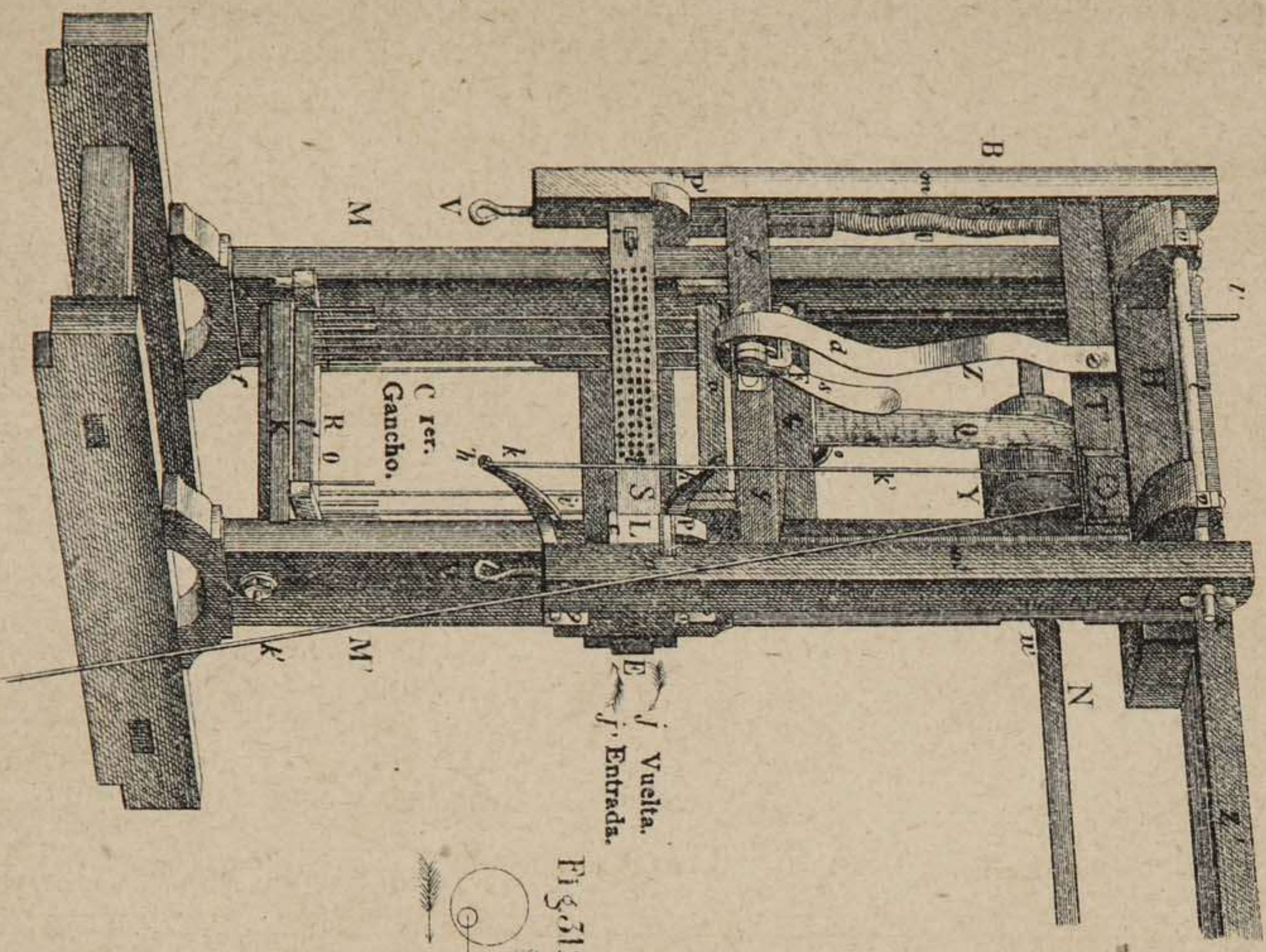


Fig. 303.

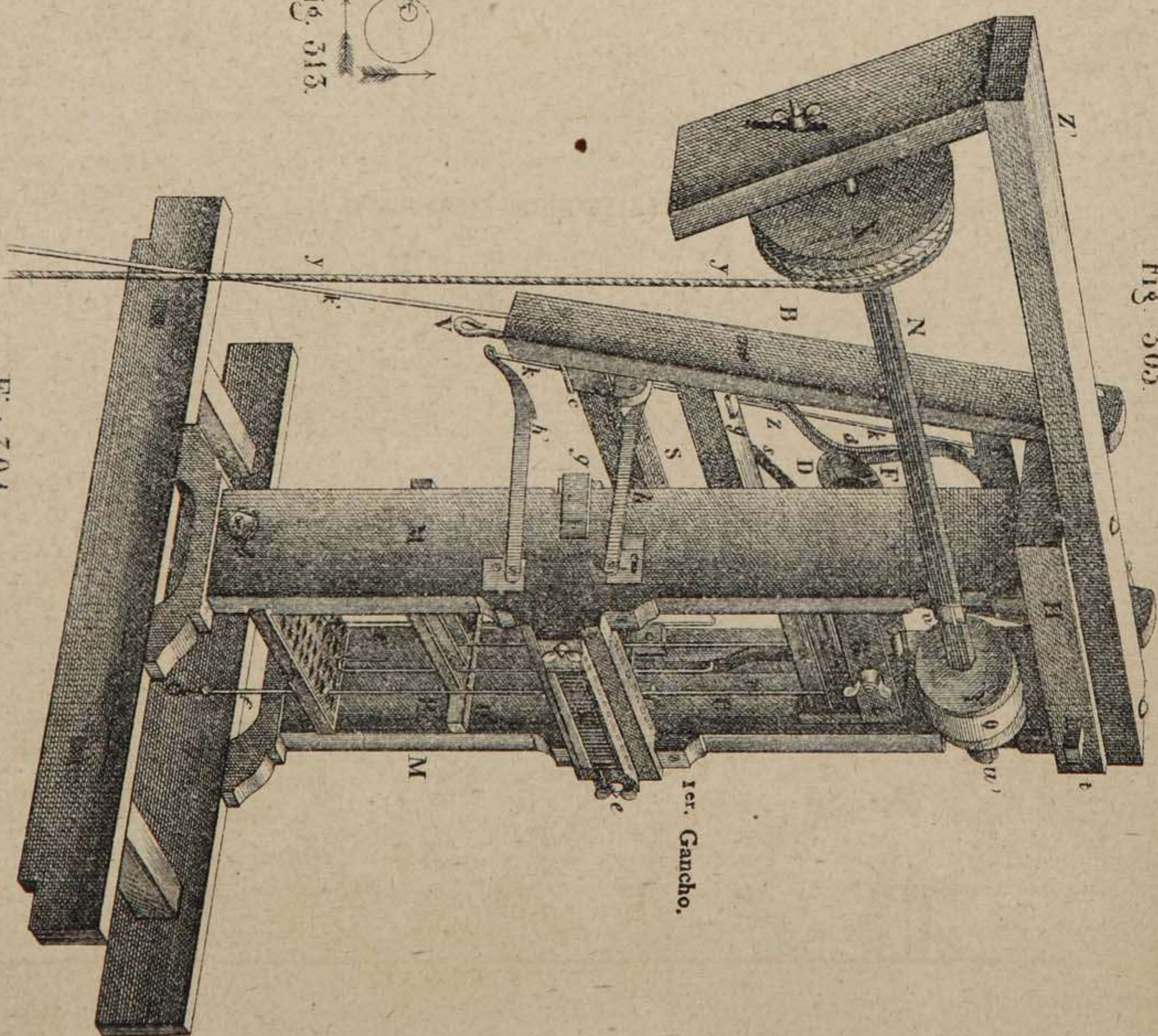


Fig. 312

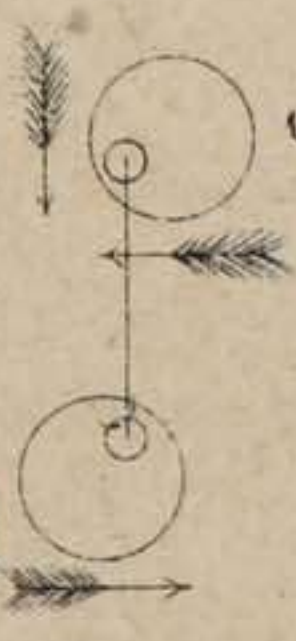


Fig. 313.

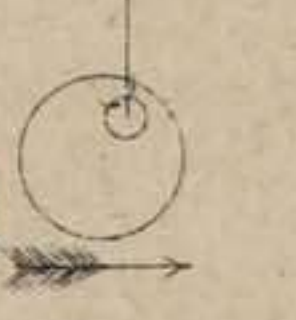
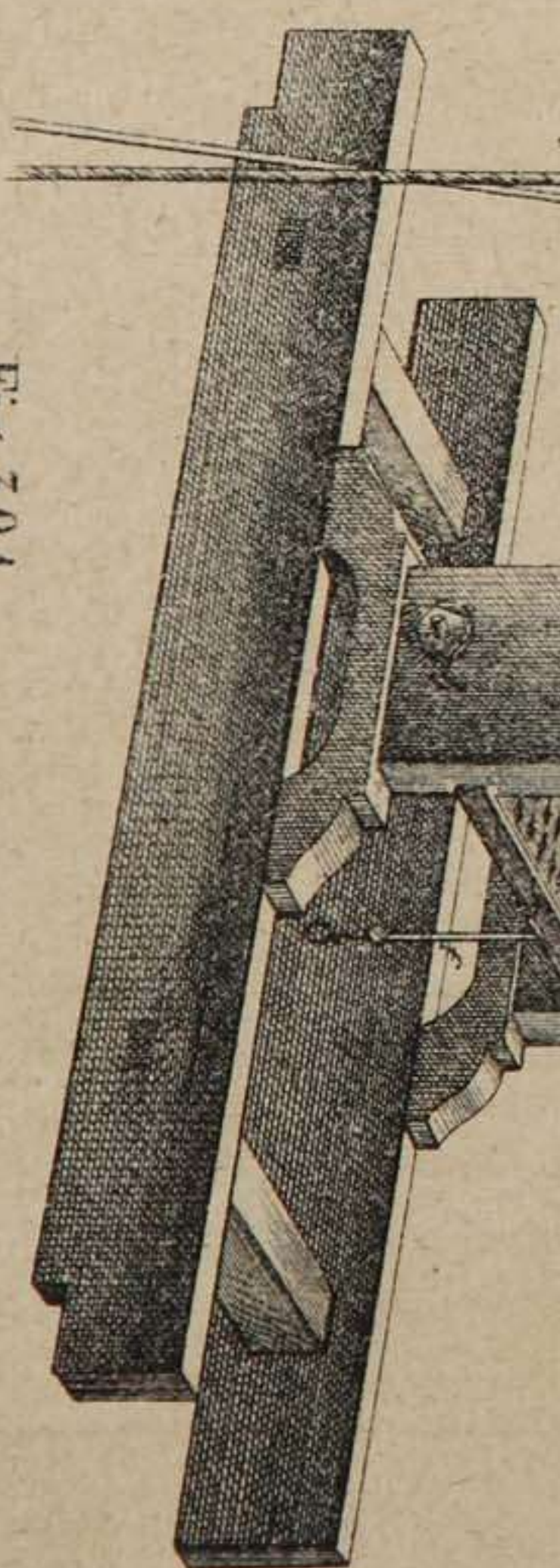


Fig. 307 Fig. 308. Fig. 309. Fig. 310. Fig. 311.



Fig. 304



1	2	3	4	5	6	7	8	9	10	11	12	13	14	15	16	17	18	19	20	21	22	23	24	25	26	27	28	29	30	31	32	33	34	35	36	37	38	39	40	41	42	43	44	45	46	47	48	49	50	51	52	53	54	55	56	57	58	59	60	61	62	63	64	65	66	67	68	69	70	71	72	73	74	75	76	77	78	79	80	81	82	83	84	85	86	87	88	89	90	91	92	93	94	95	96	97	98	99	100	101	102	103	104	105	106	107	108	109	110
---	---	---	---	---	---	---	---	---	----	----	----	----	----	----	----	----	----	----	----	----	----	----	----	----	----	----	----	----	----	----	----	----	----	----	----	----	----	----	----	----	----	----	----	----	----	----	----	----	----	----	----	----	----	----	----	----	----	----	----	----	----	----	----	----	----	----	----	----	----	----	----	----	----	----	----	----	----	----	----	----	----	----	----	----	----	----	----	----	----	----	----	----	----	----	----	----	----	----	-----	-----	-----	-----	-----	-----	-----	-----	-----	-----	-----

J CARTON 104.

Lado de la linterna.

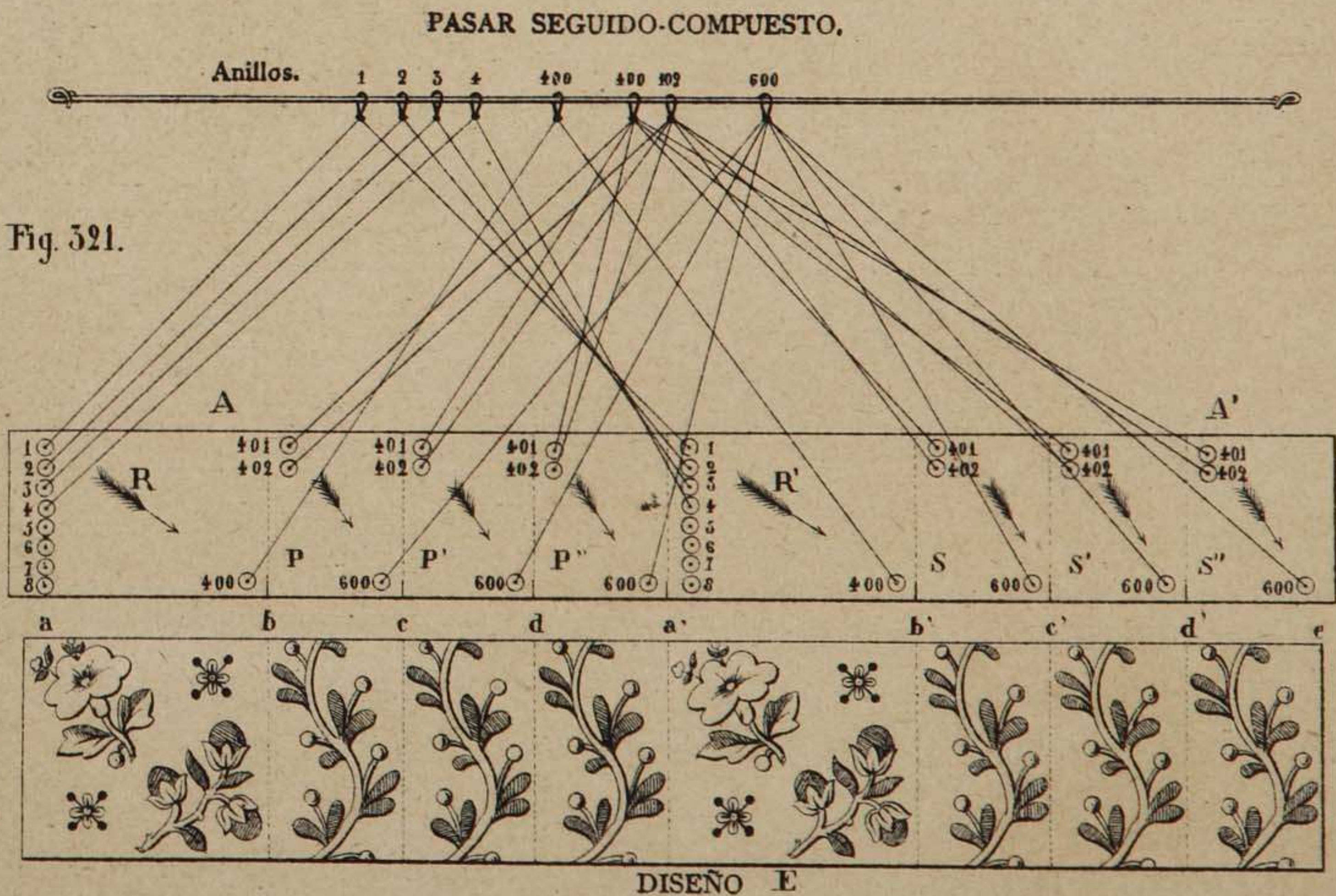
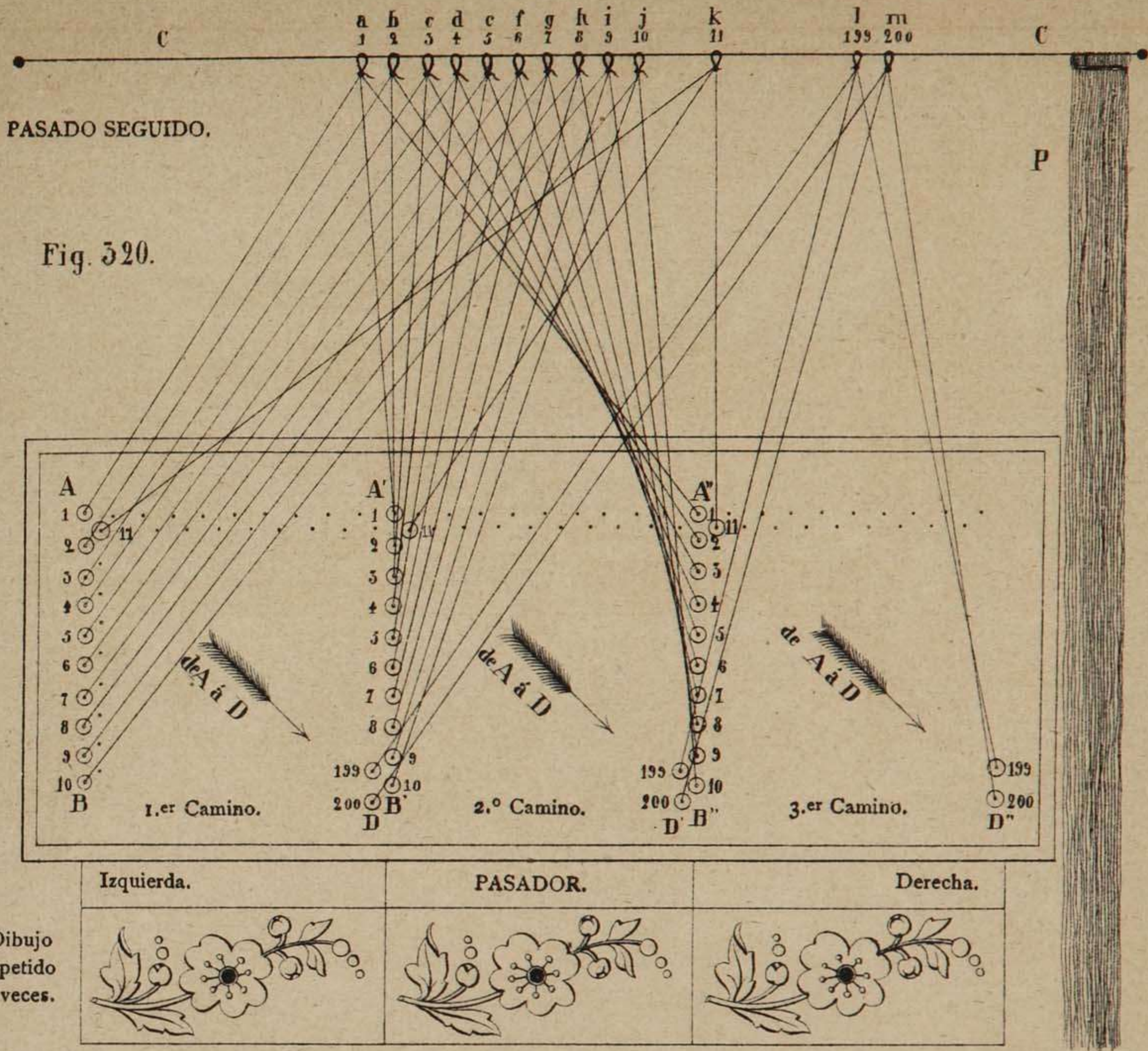


Fig. 327.

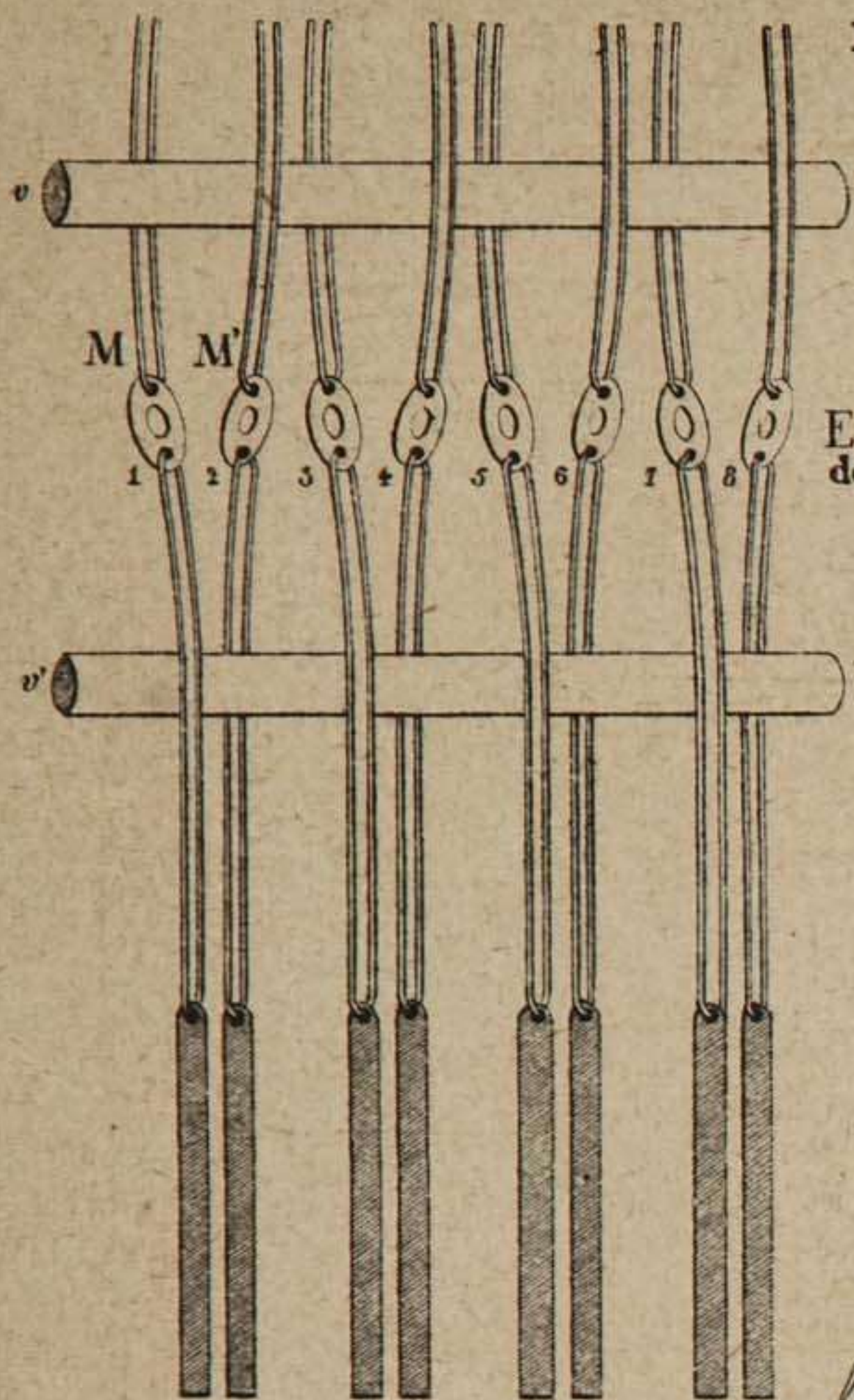


Fig. 325.

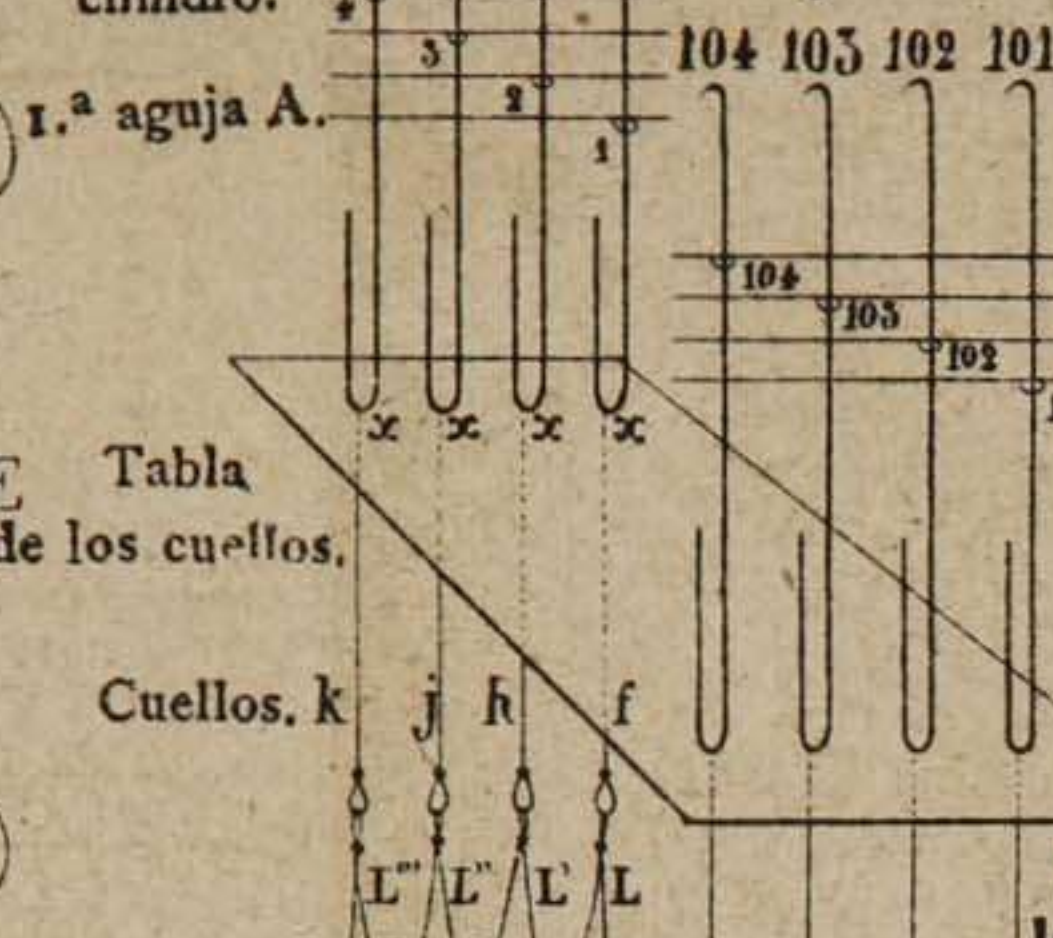


Fig. 331.

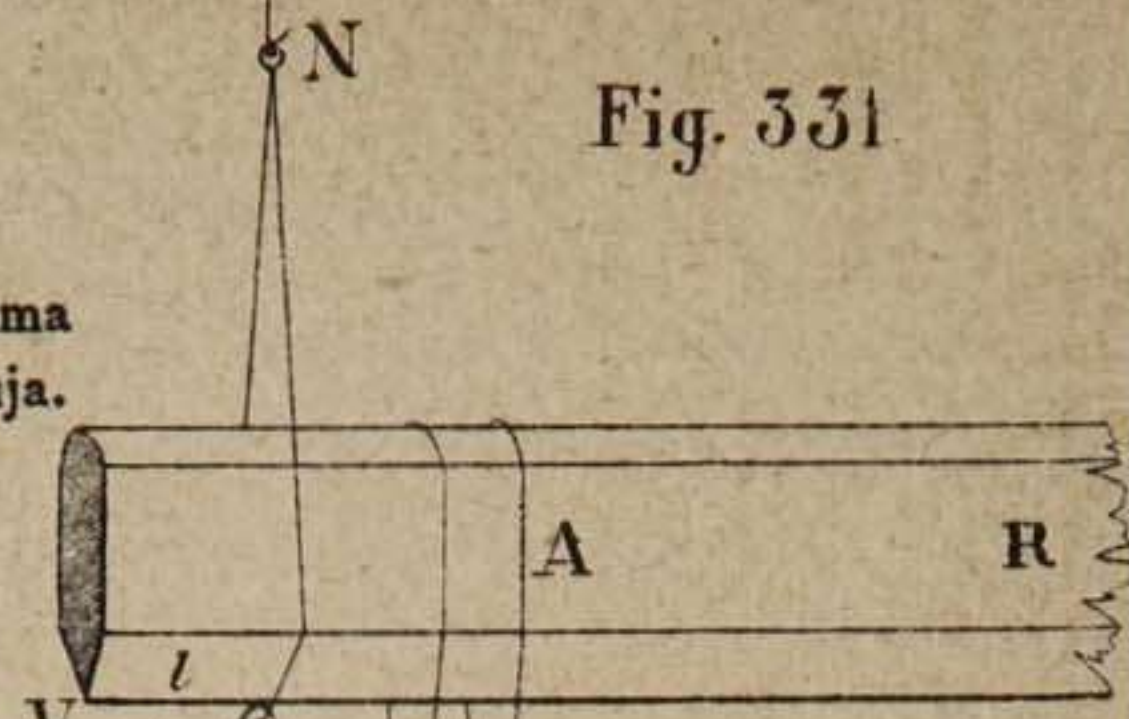


Fig. 330.

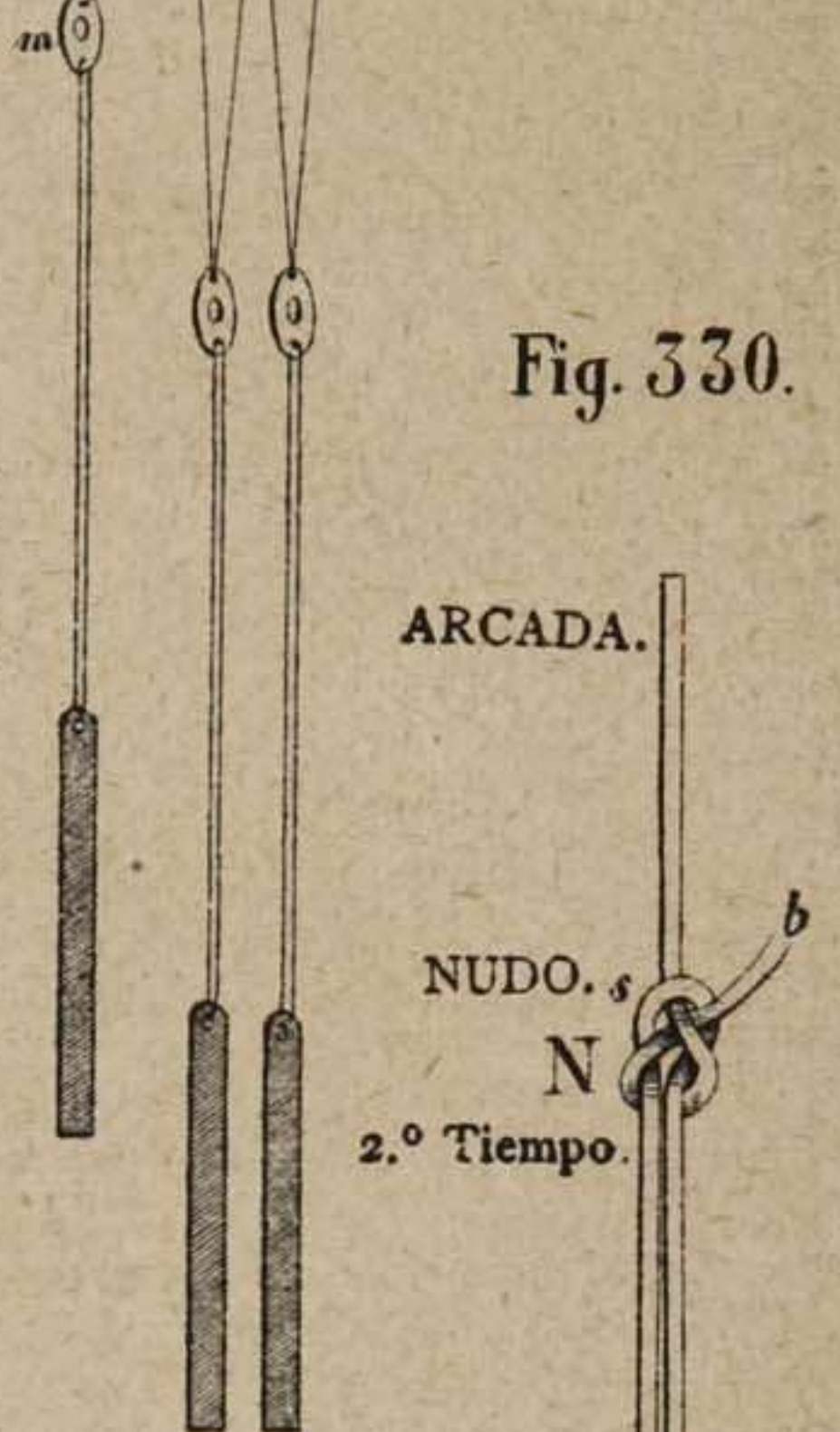


Fig. 332.

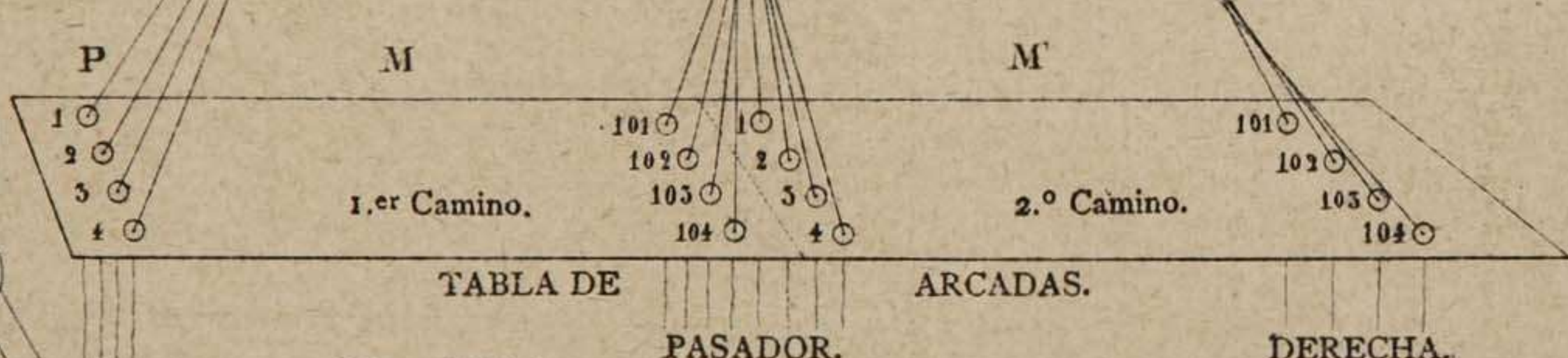
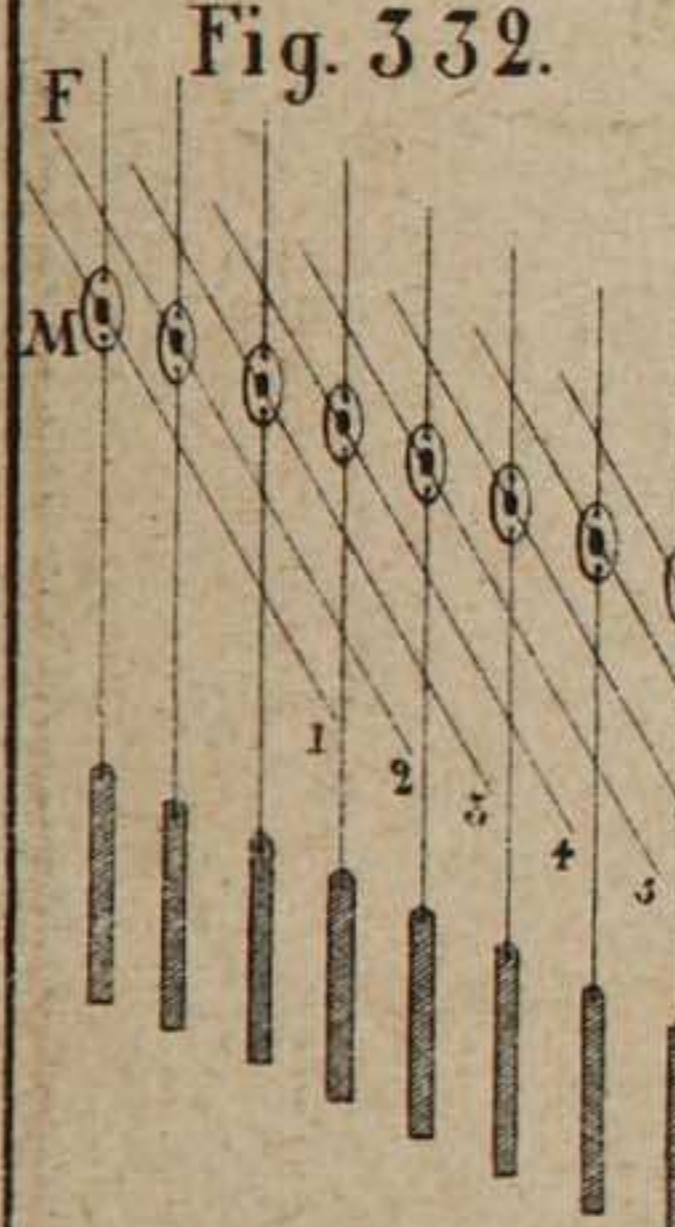
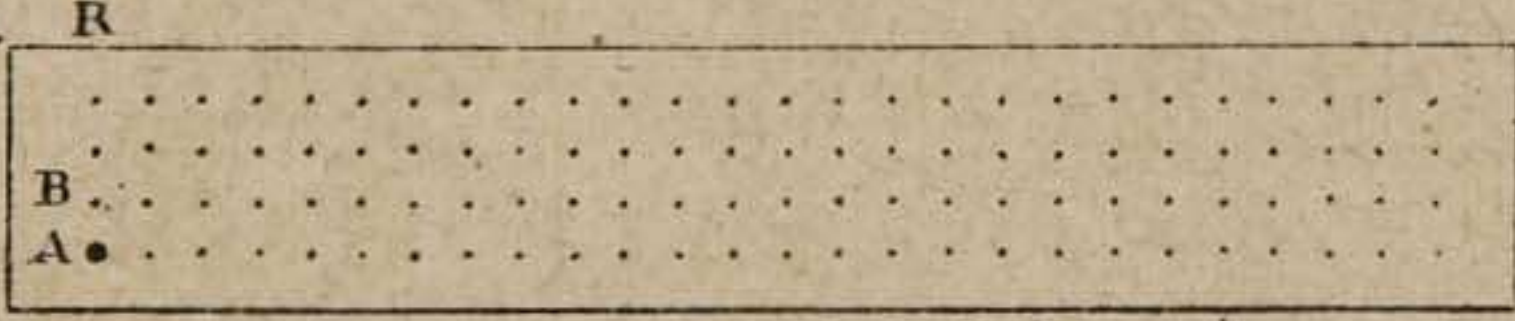


Fig. 325 bis.



ARCADA.

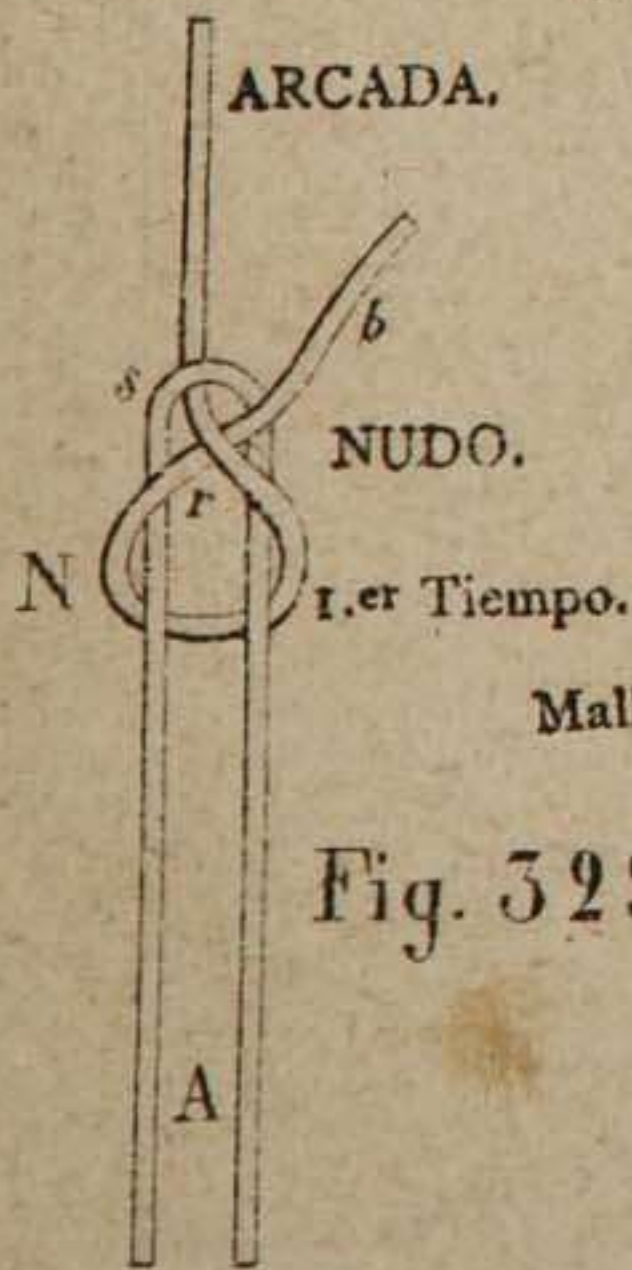


Fig. 329.

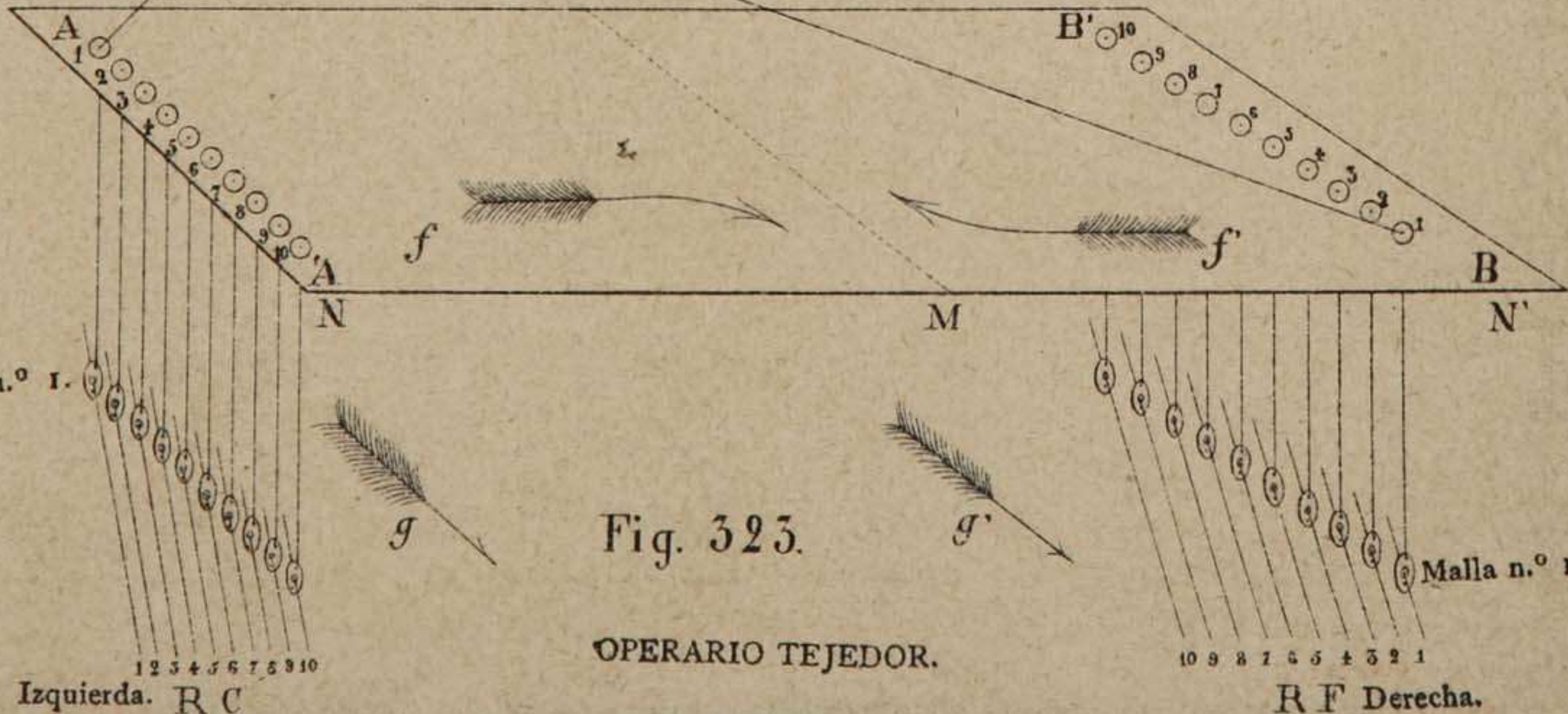
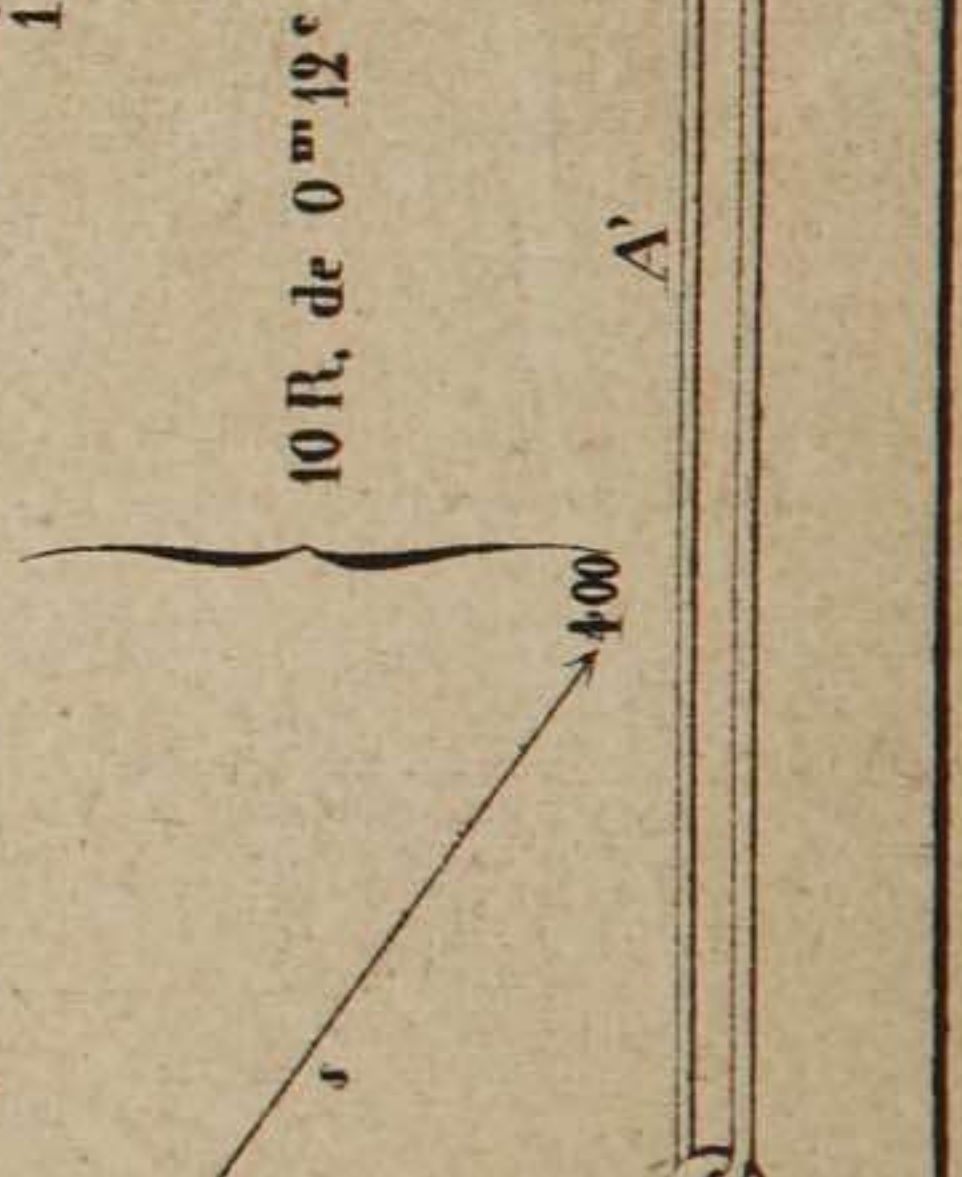
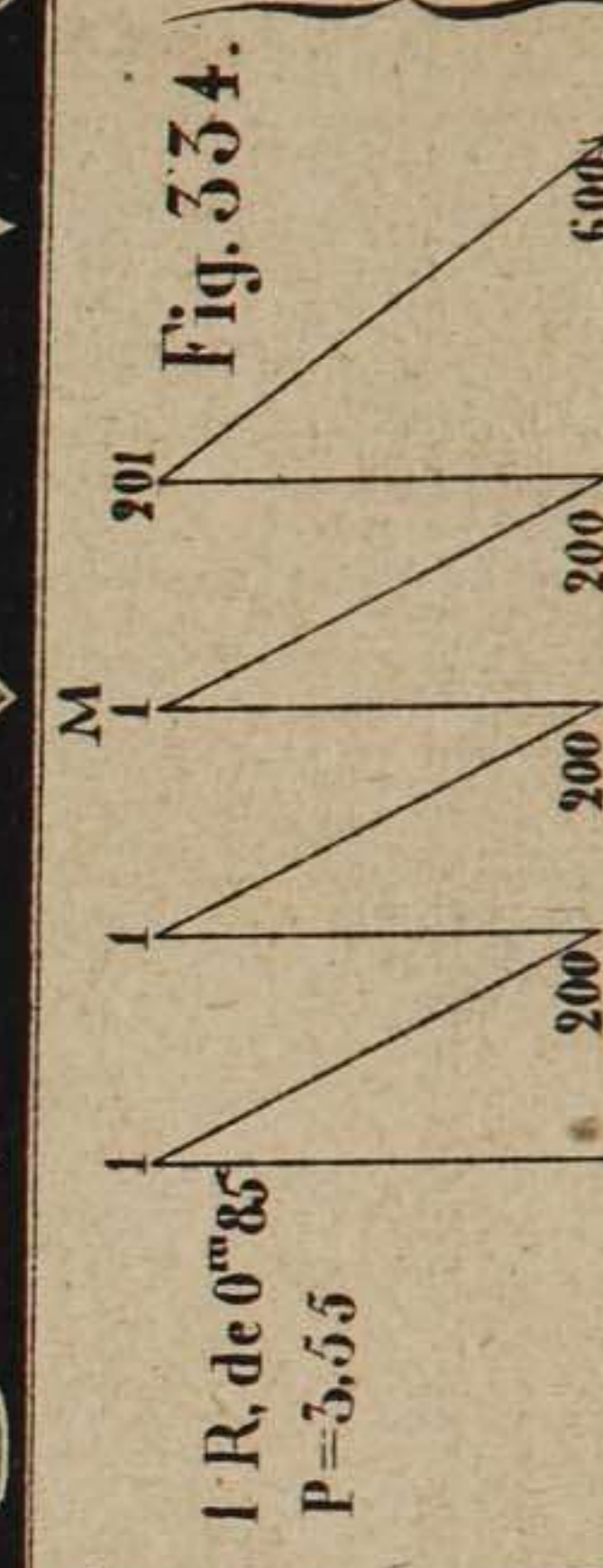
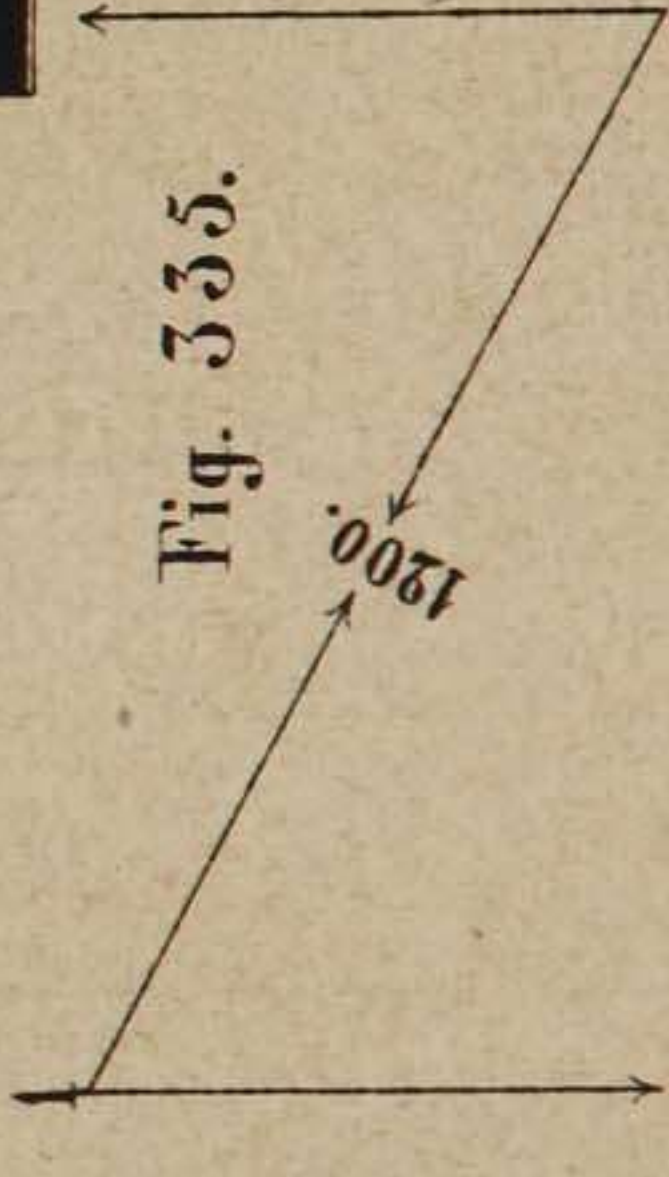
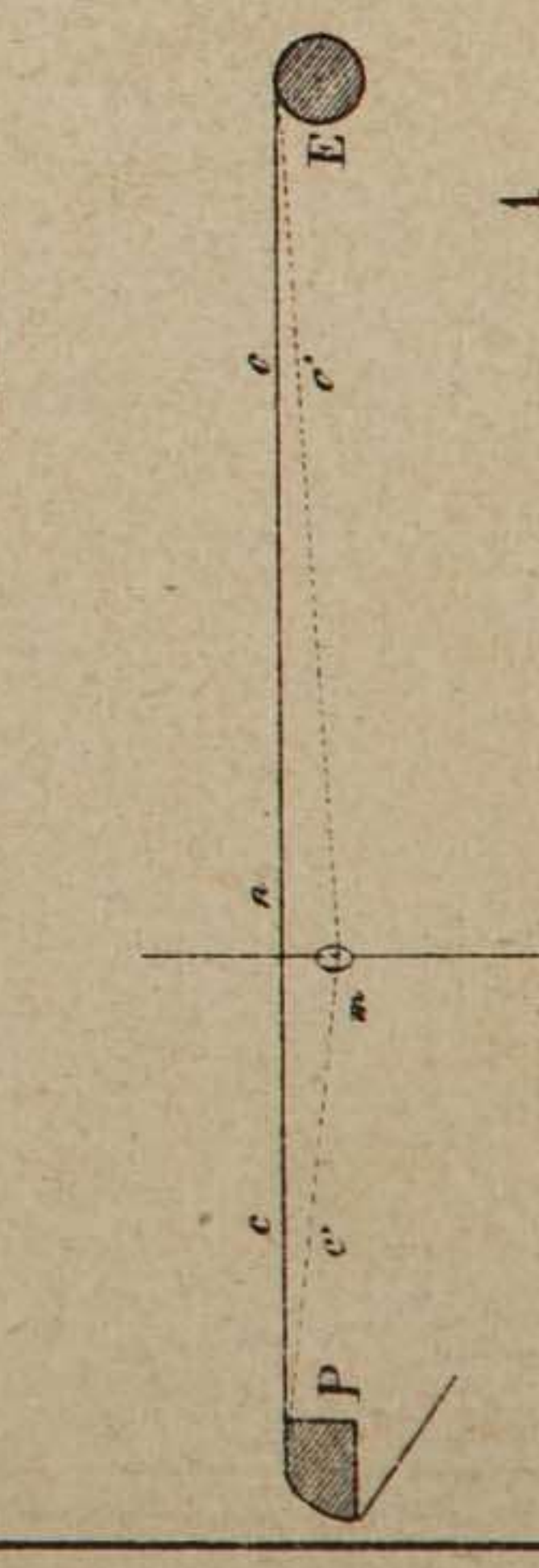
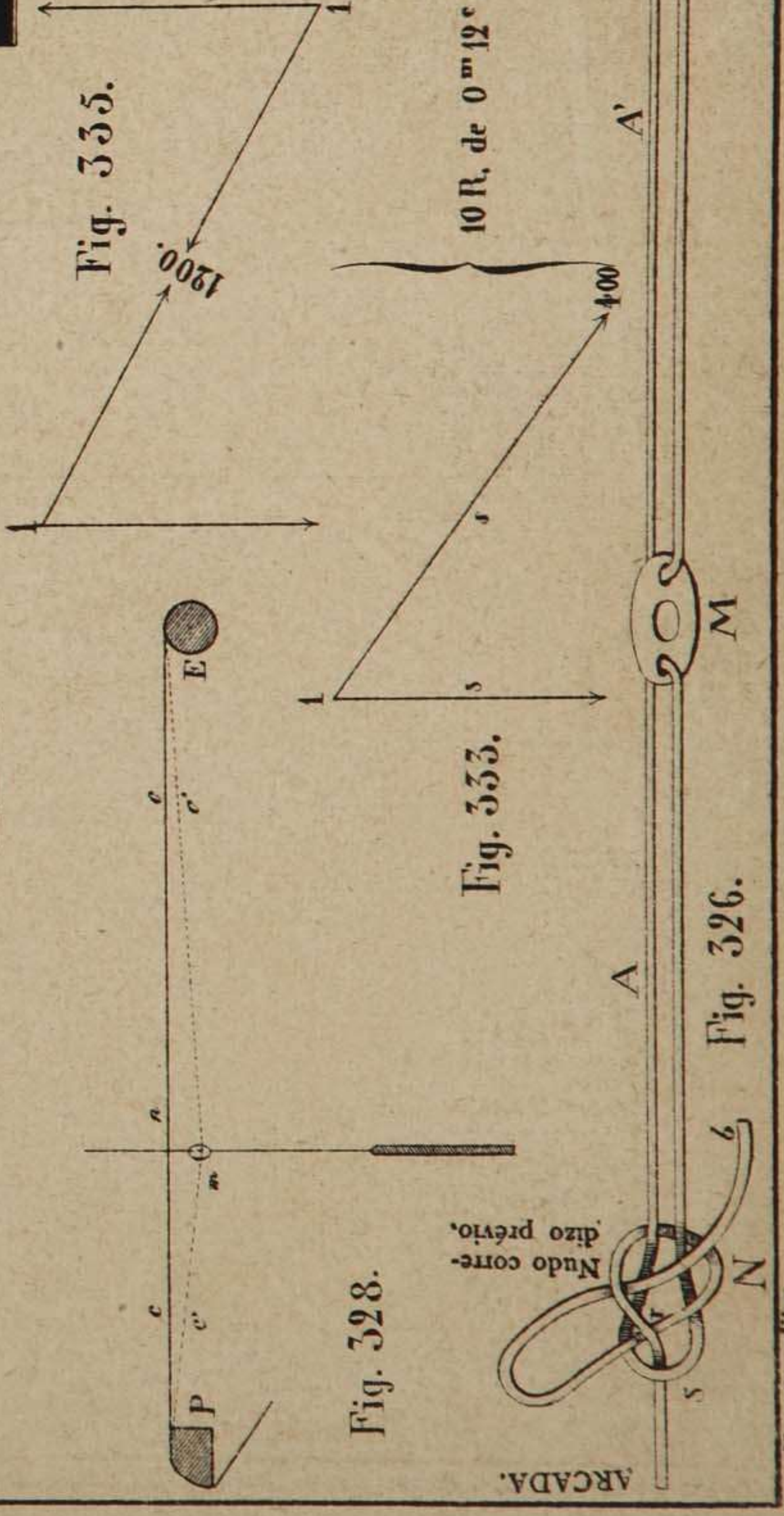
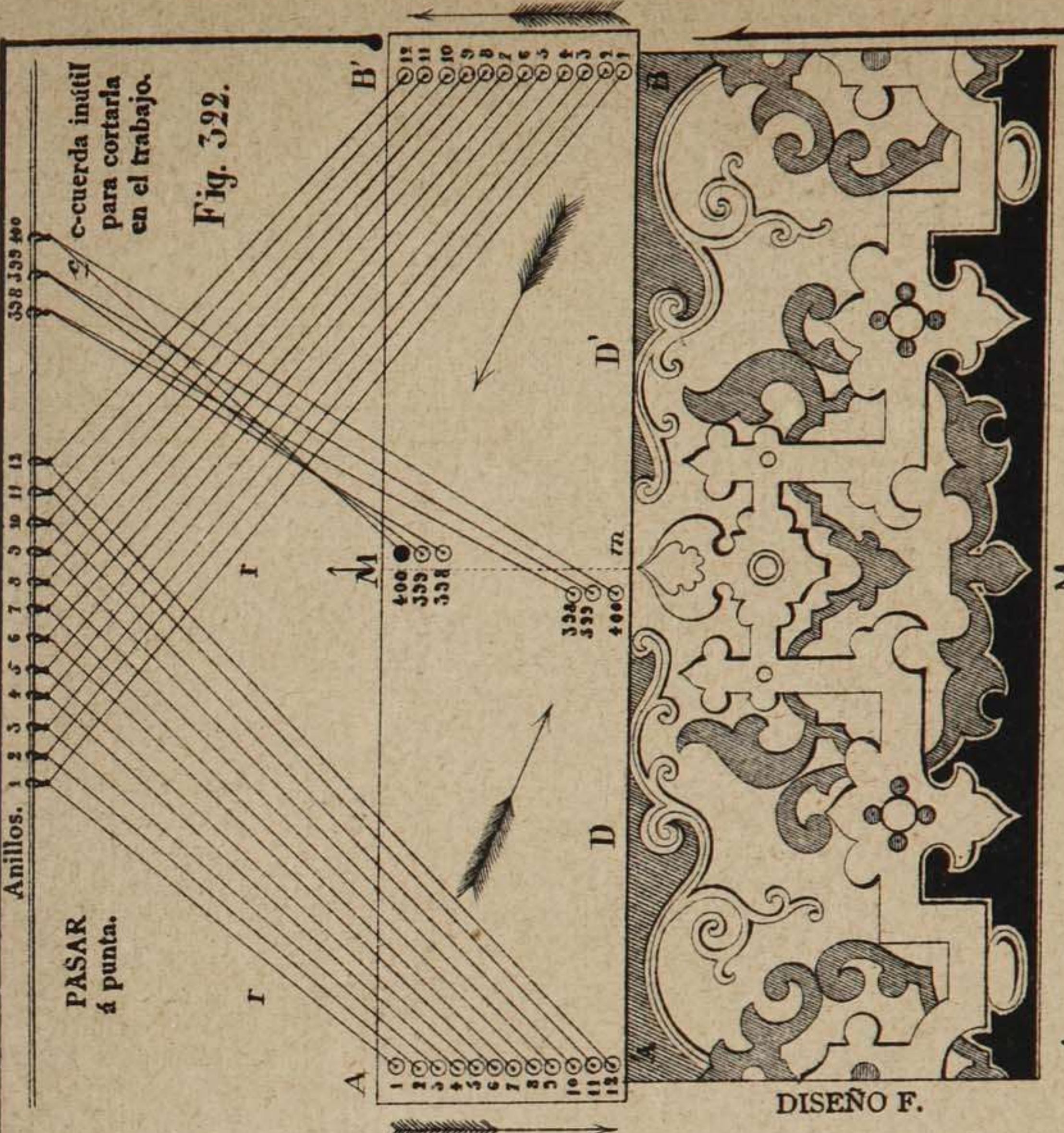
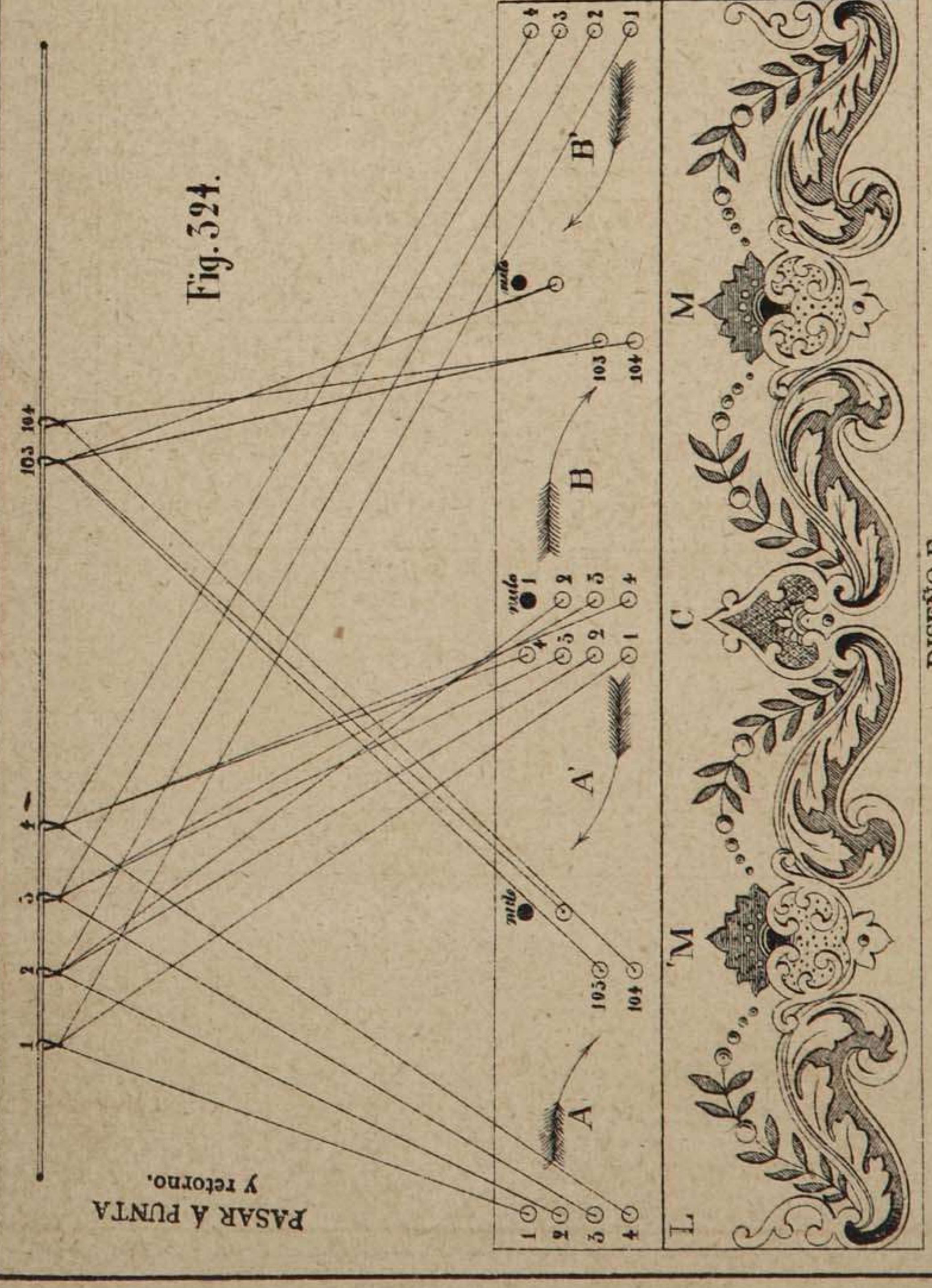


Fig. 323.



TEJIDO MECÁNICO.

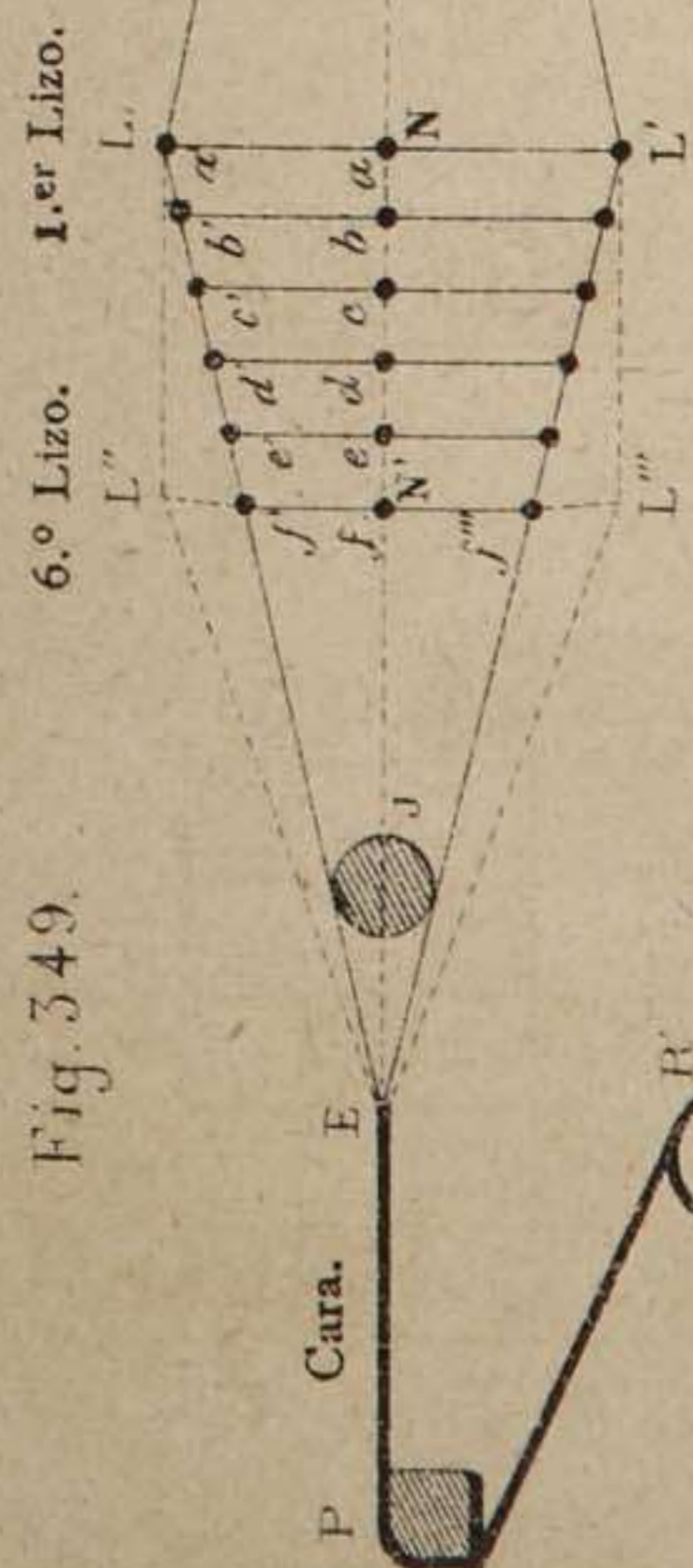


Fig. 347.

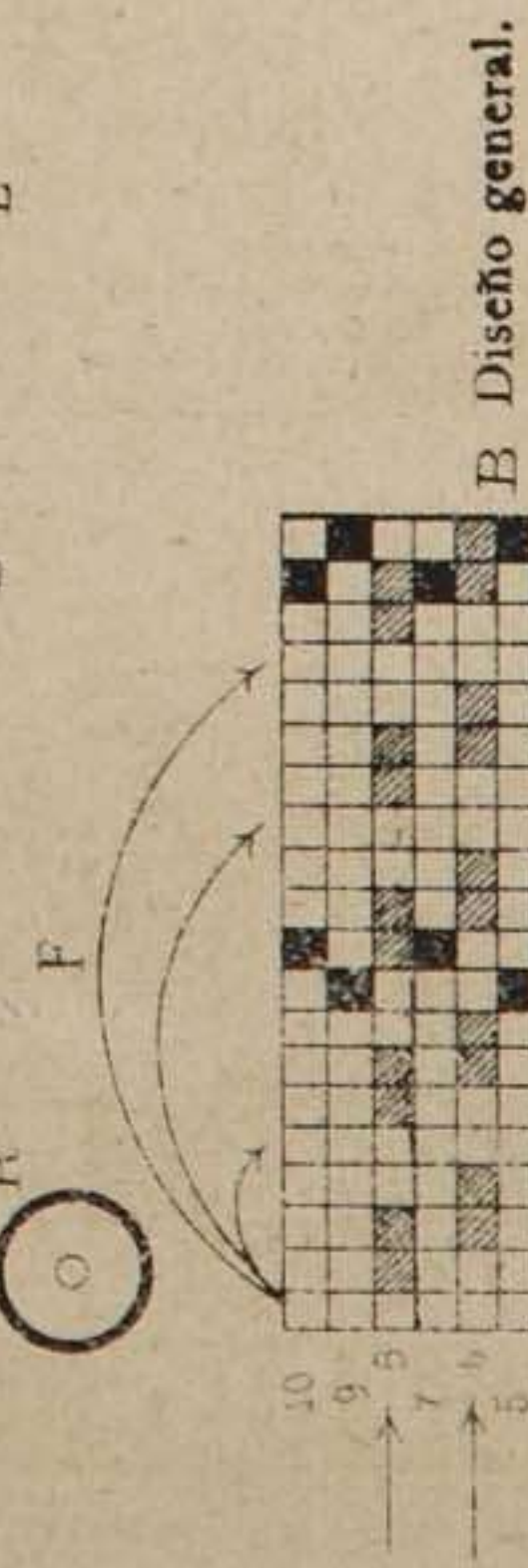
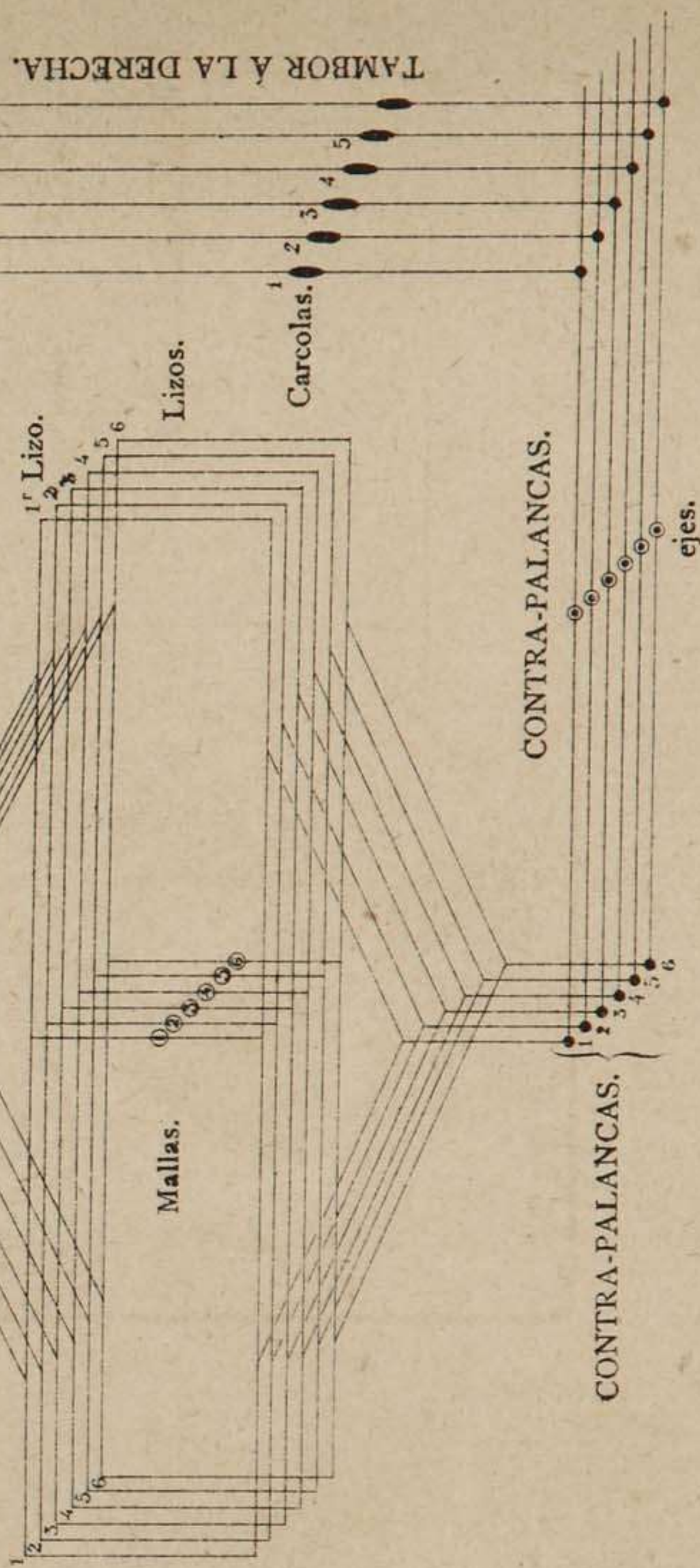


Fig. 346

Fig. 350.

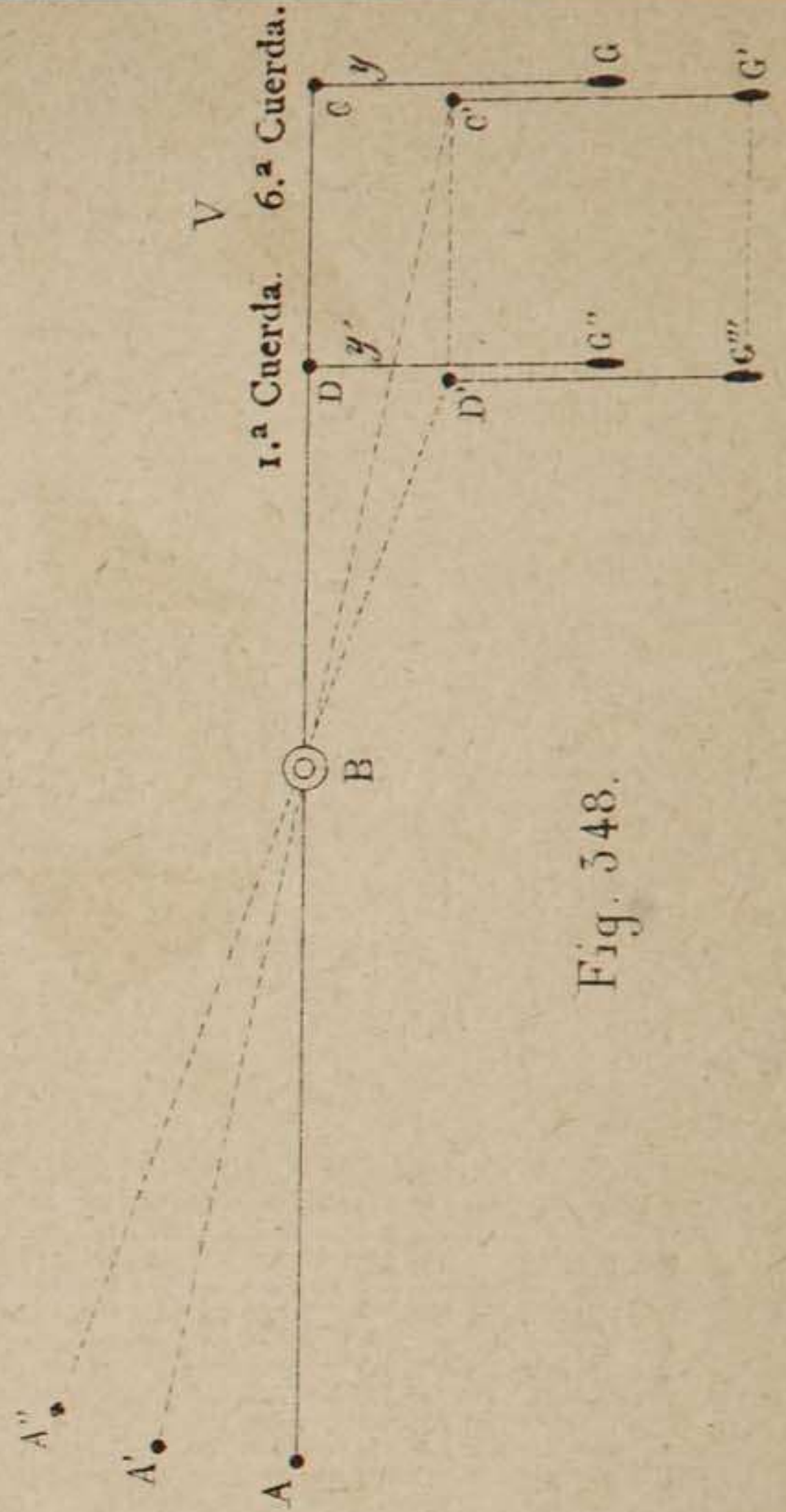
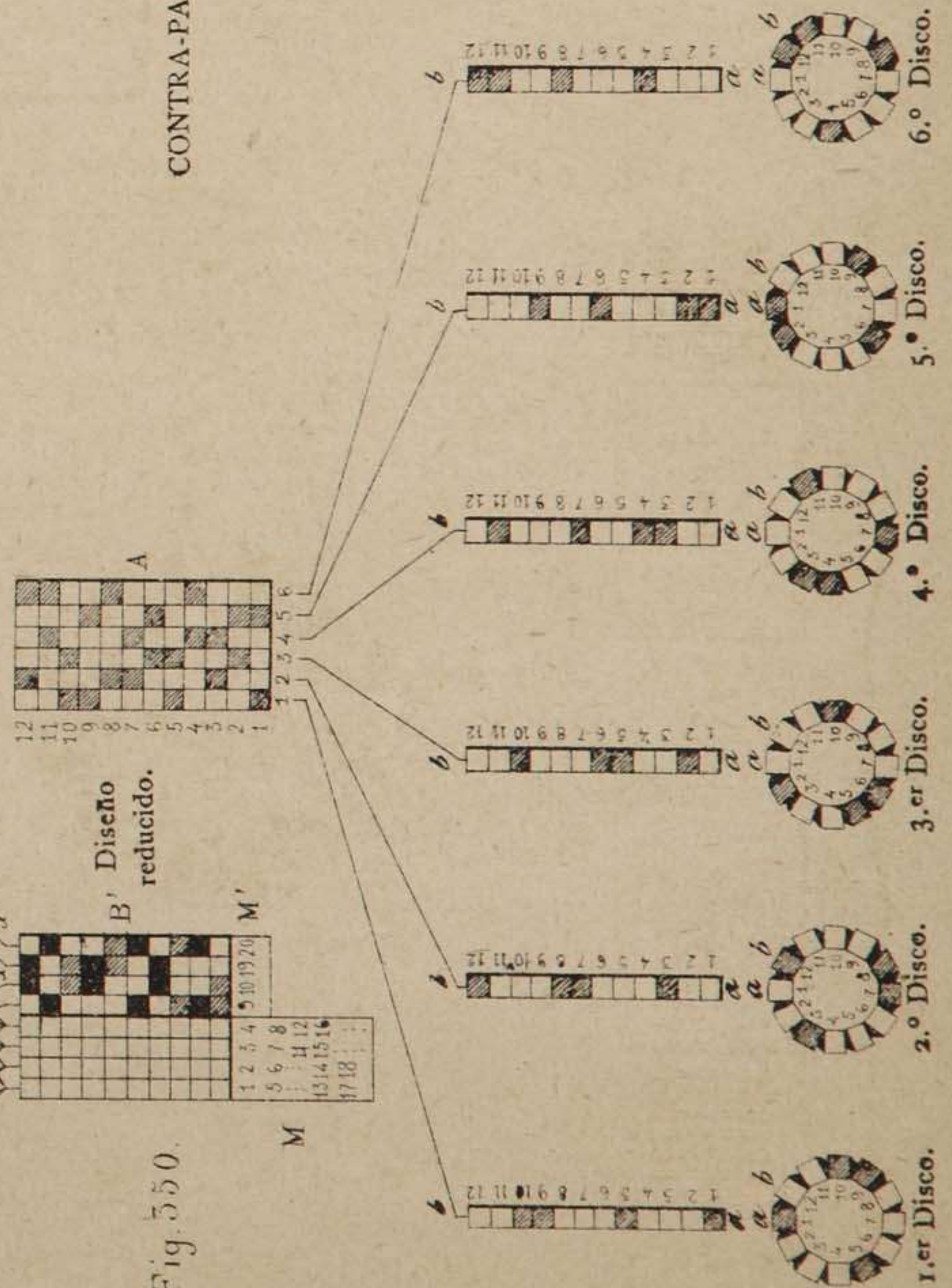
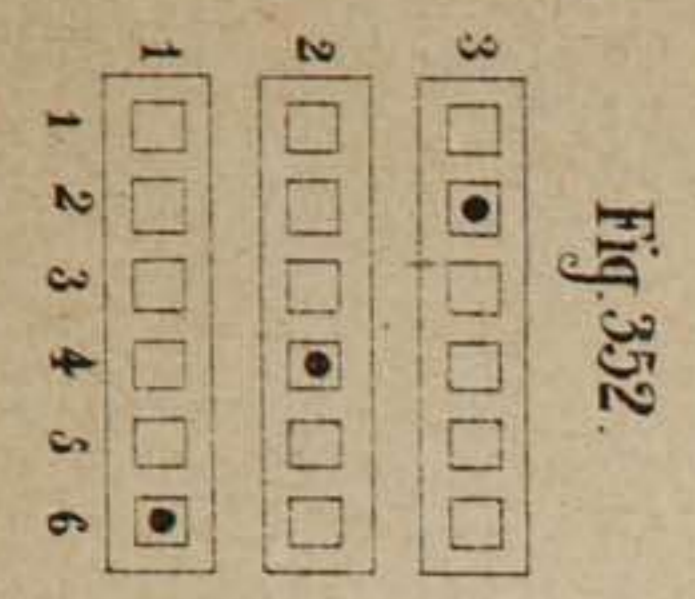
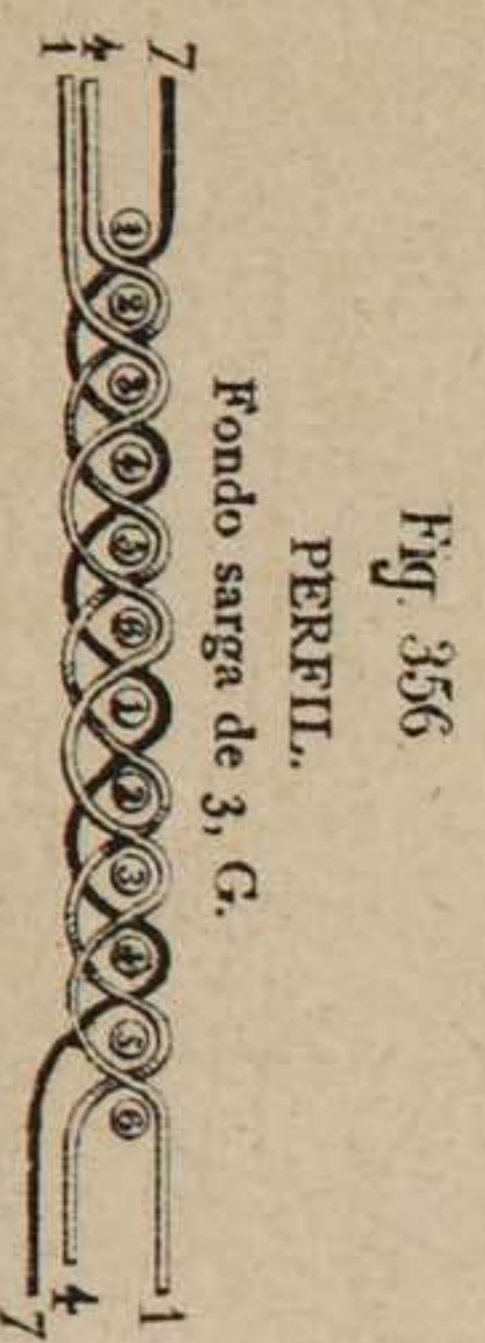
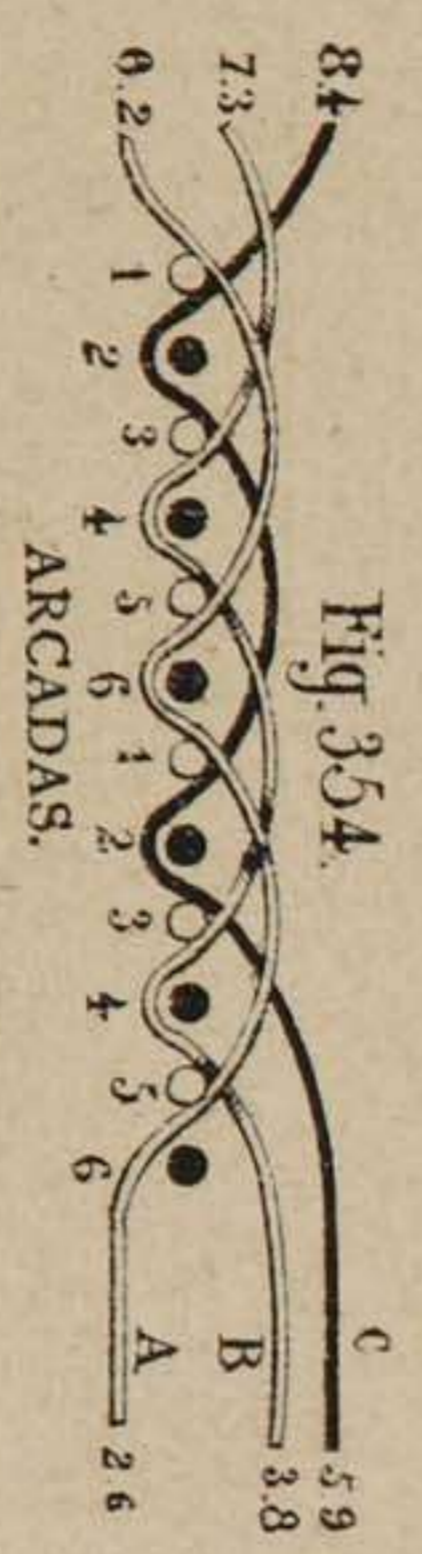
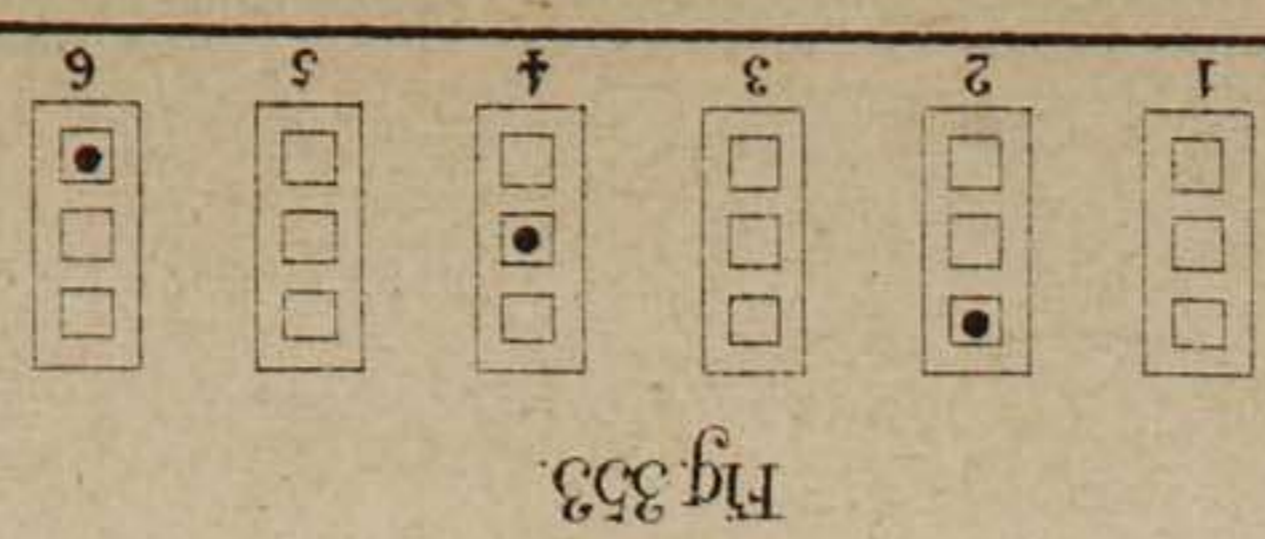
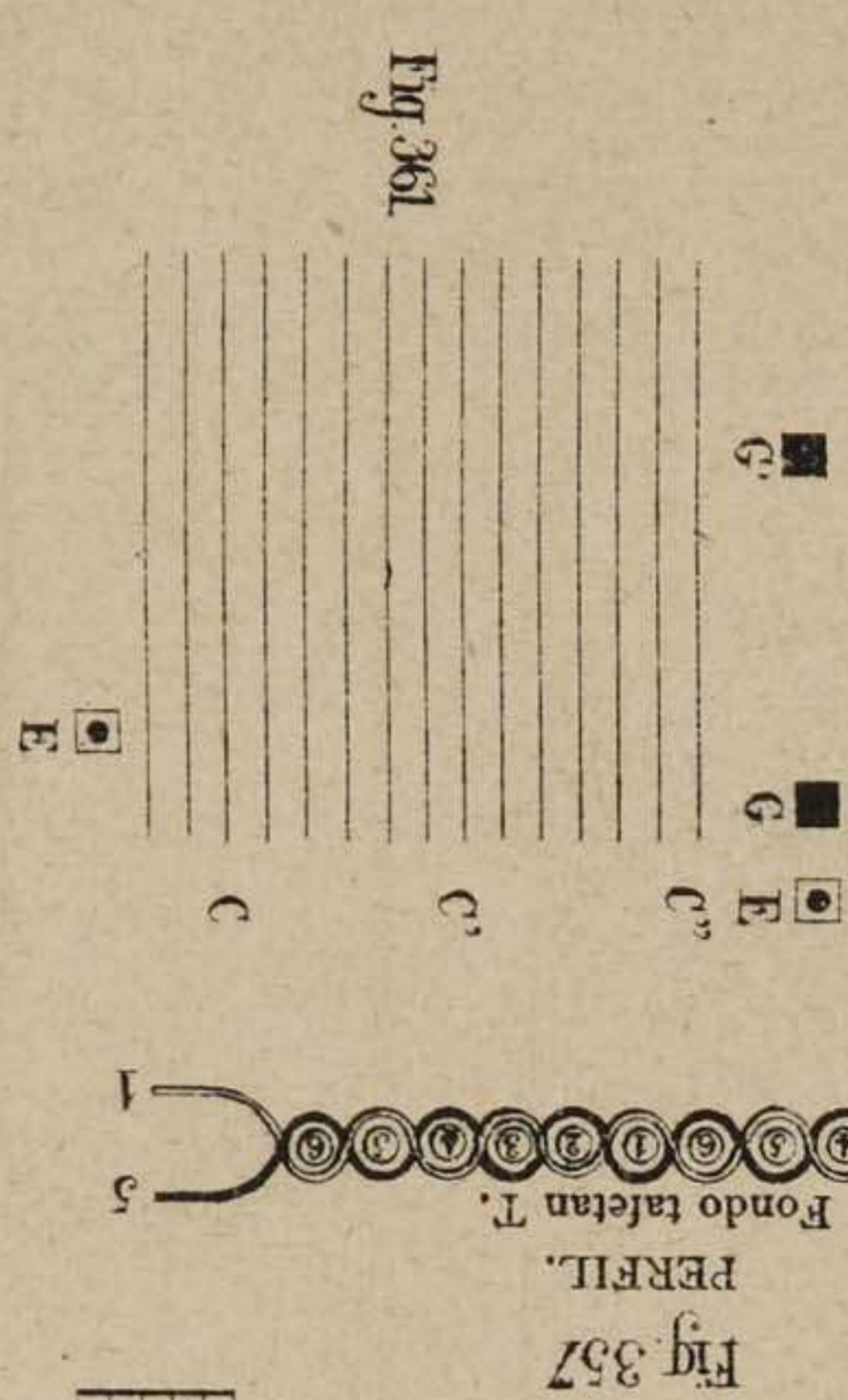
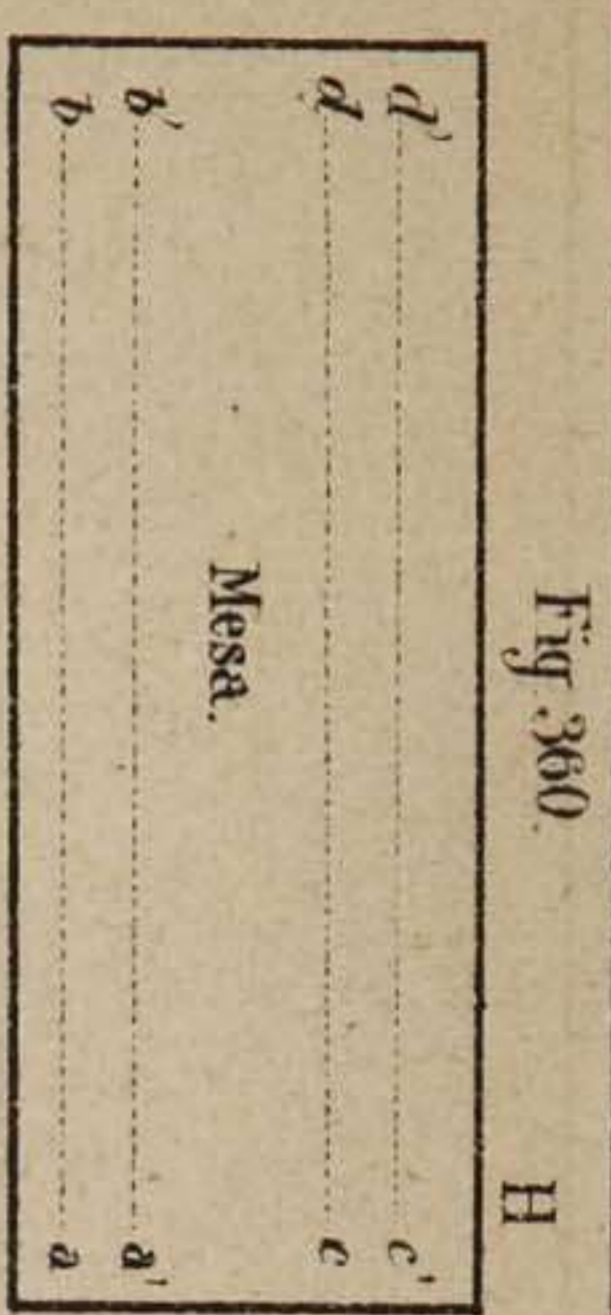


Fig. 348.



SÍMBOLO

COMPLETO

Fig. 351.

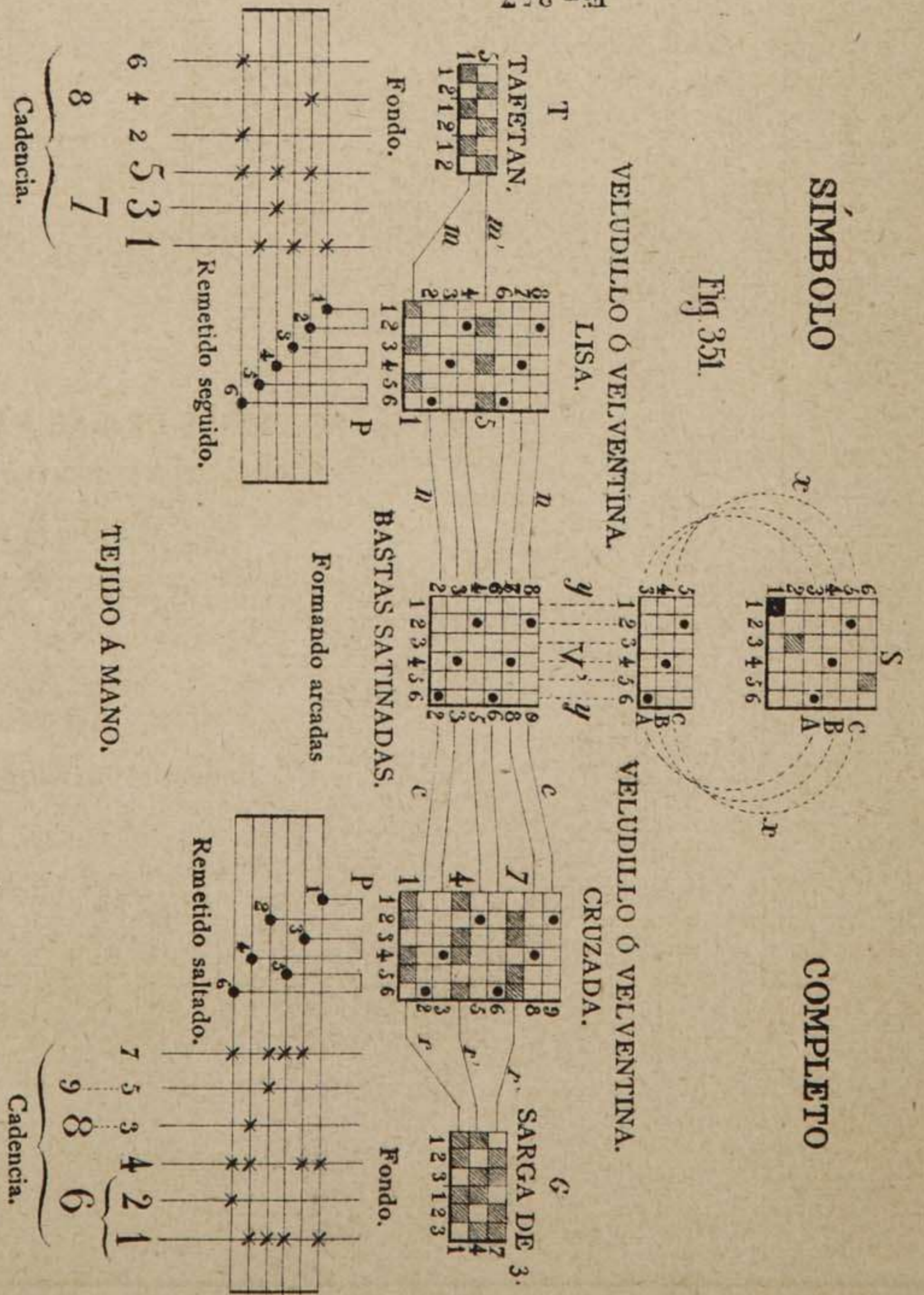
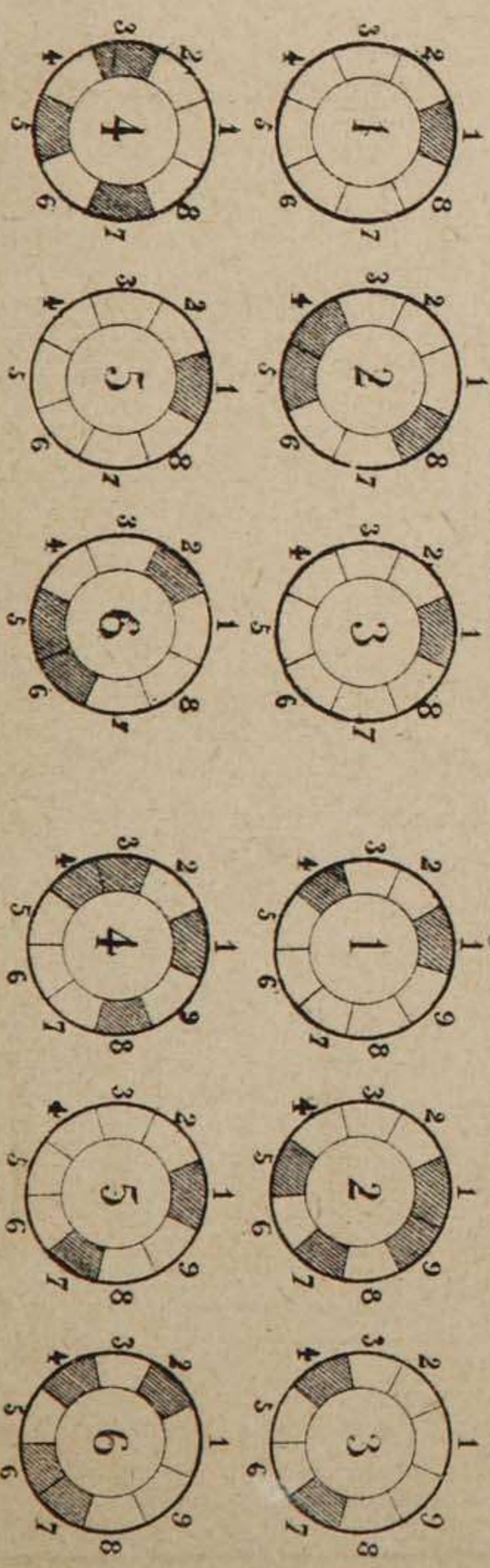


Fig. 358.

TEJIDO MECÁNICO



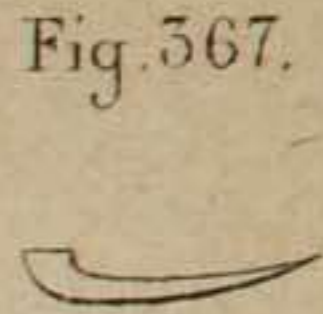
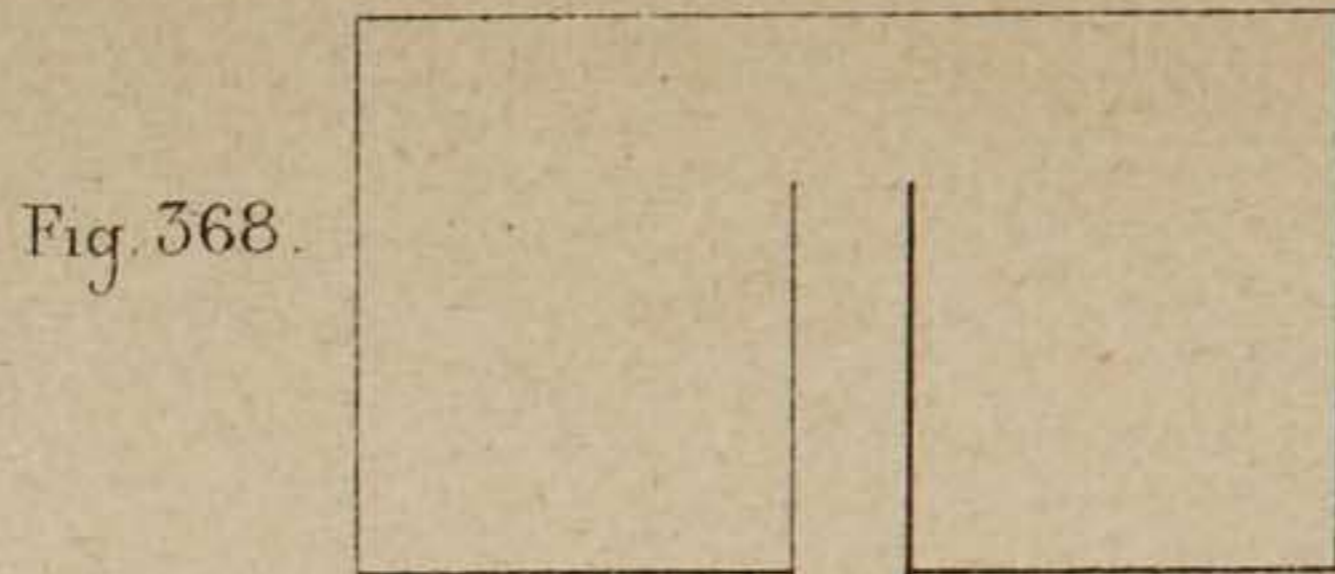
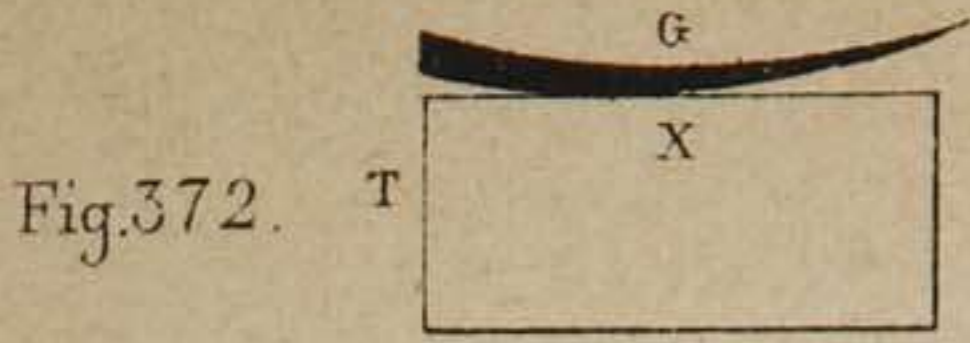


Fig. 362. 363.

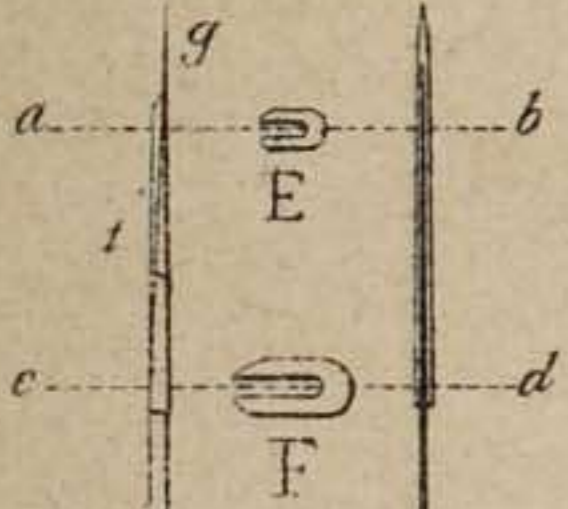


Fig. 364. A B



Fig. 365.

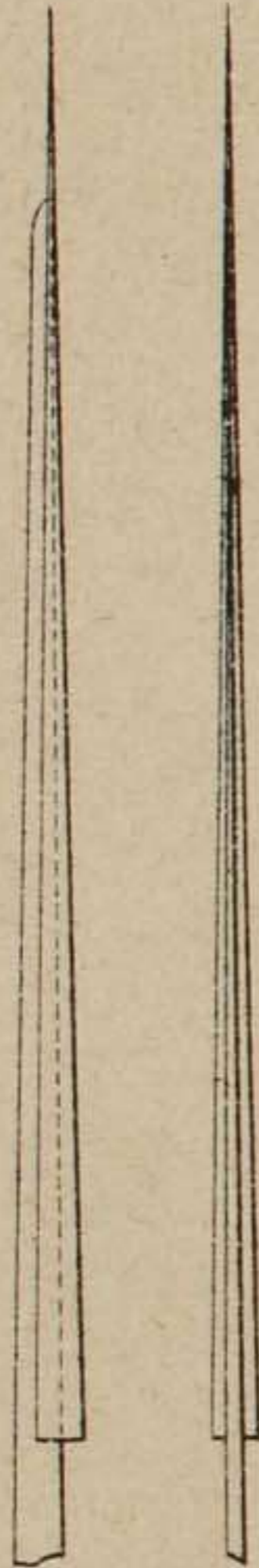


Fig. 369.



Fig. 366.

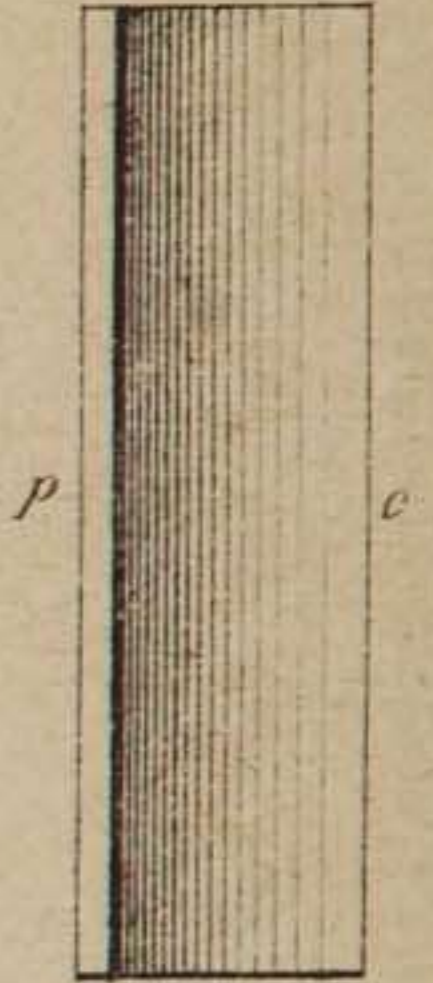


Fig. 370.

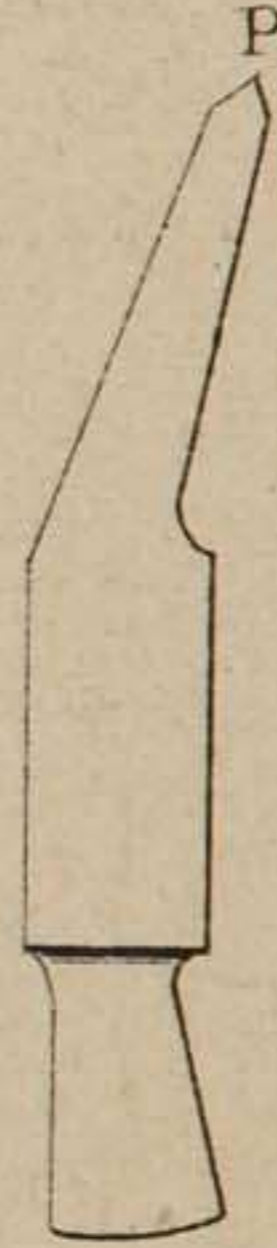


Fig. 371.

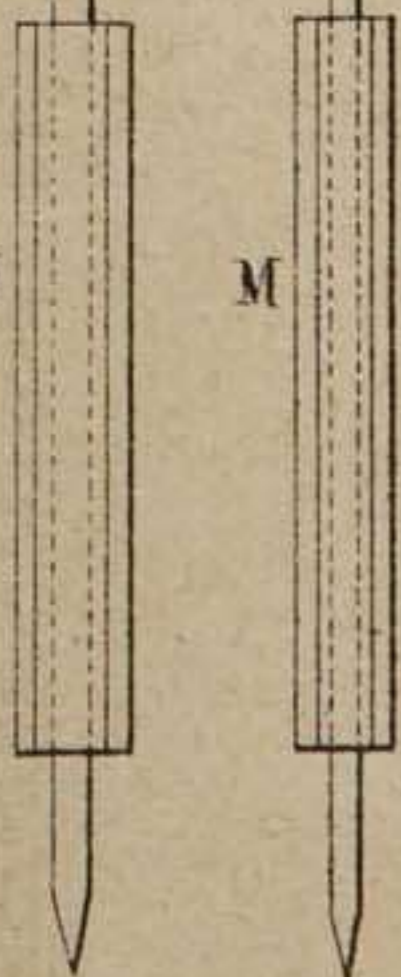


Fig. 362, 363, 368, 367, 368, 369. 1/5
 Fig. 370, 371. 1/2
 Fig. 364, 365. tamaño natural.

CUCHILLOS Y GUIAS.

Visto de perfil.

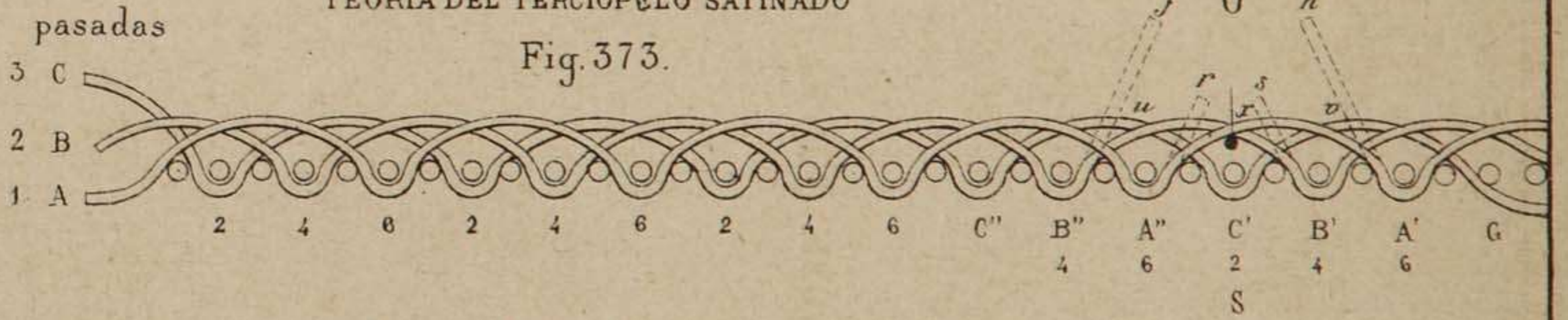
Visto de frente.



SECCIONES DE LAS VELVETINAS

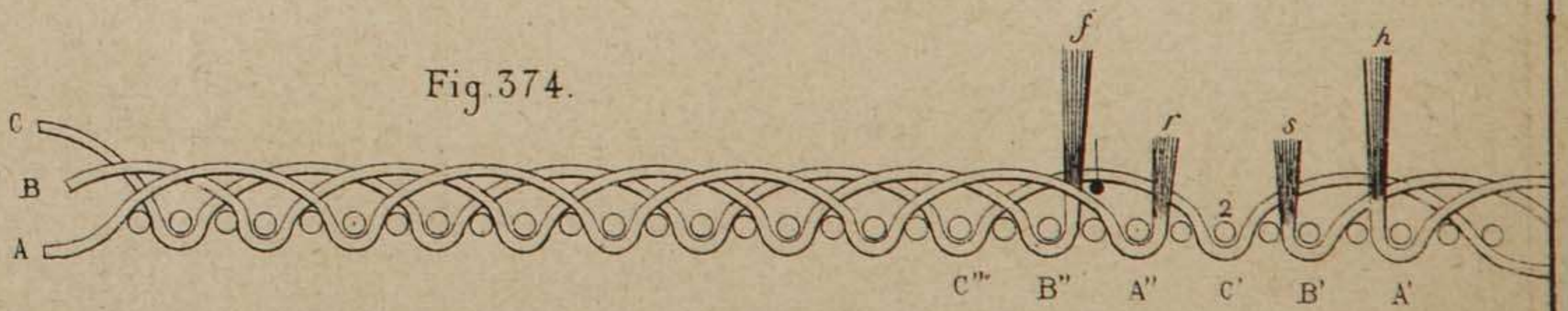
TEORIA DEL TERCIOPELO SATINADO

Fig. 373.



1º Golpe de Cuchillo

Fig. 374.



2º Golpe de Cuchillo.

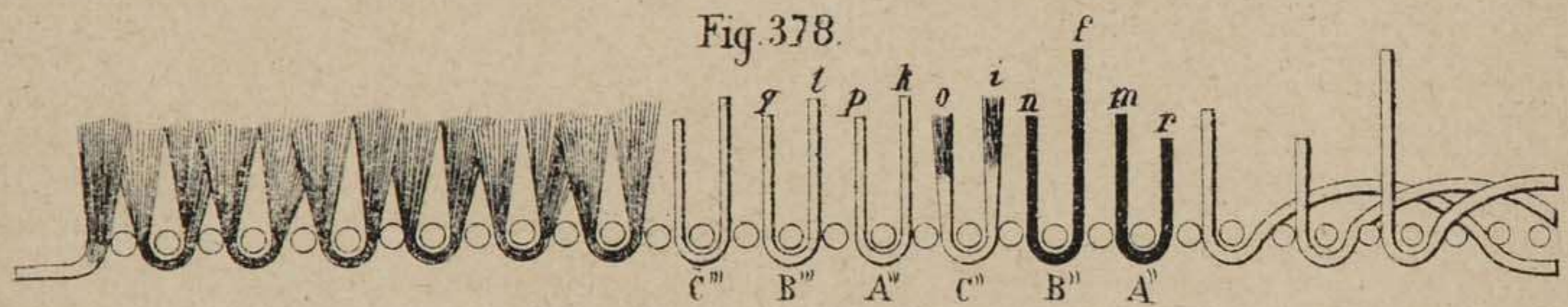
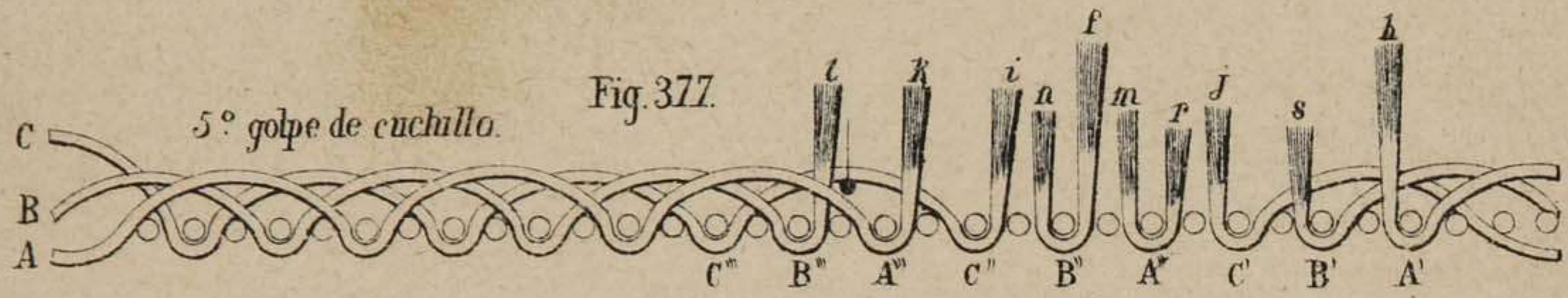
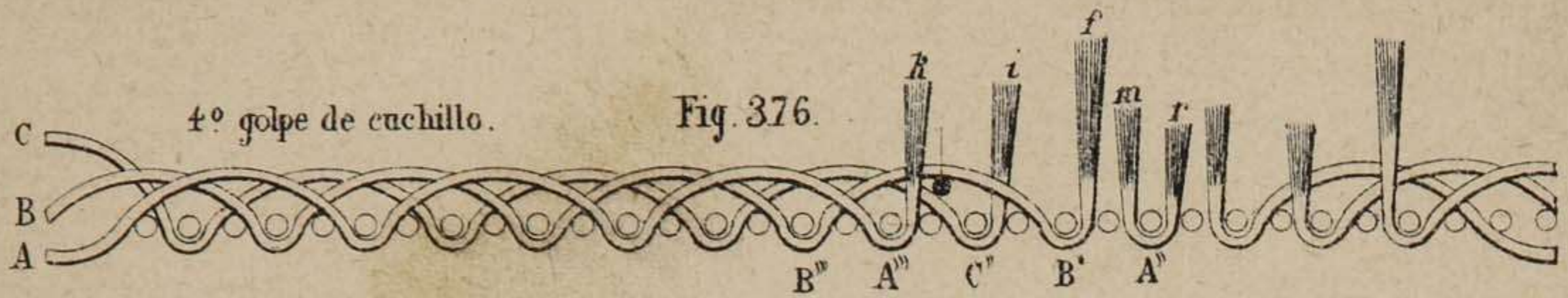
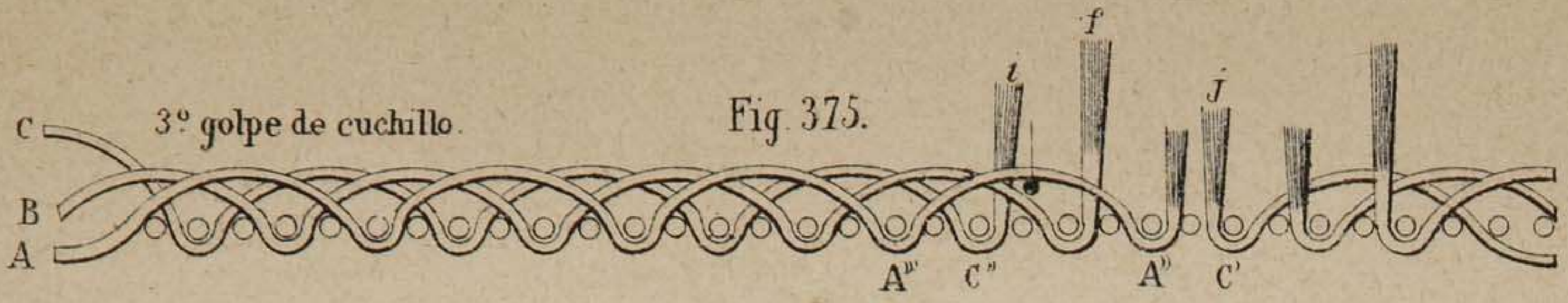
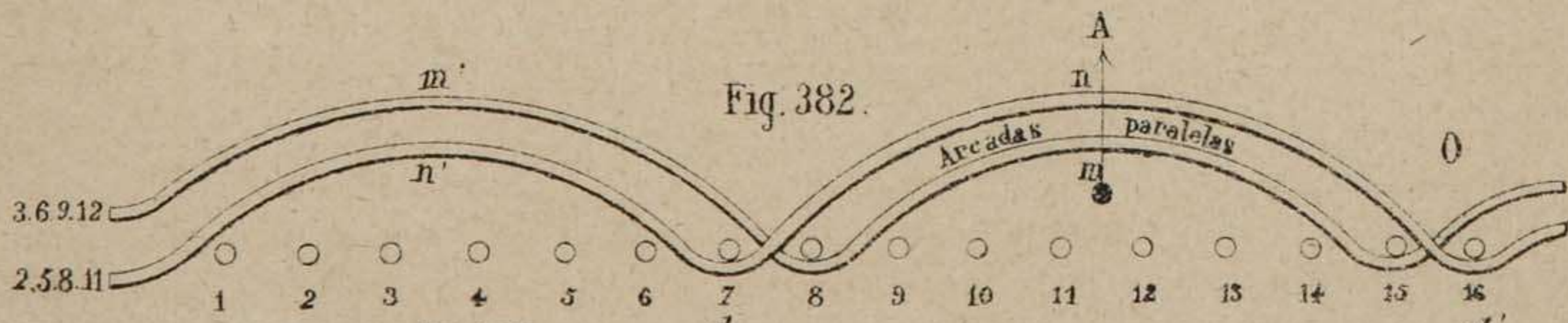
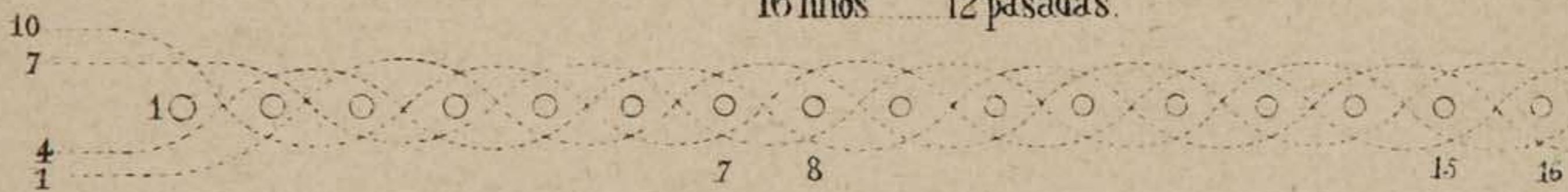


Fig. 381.
RAYADO RAGLAN

16 hilos 12 pasadas.



RAYADO RAGLAN
LIGAMIENTO

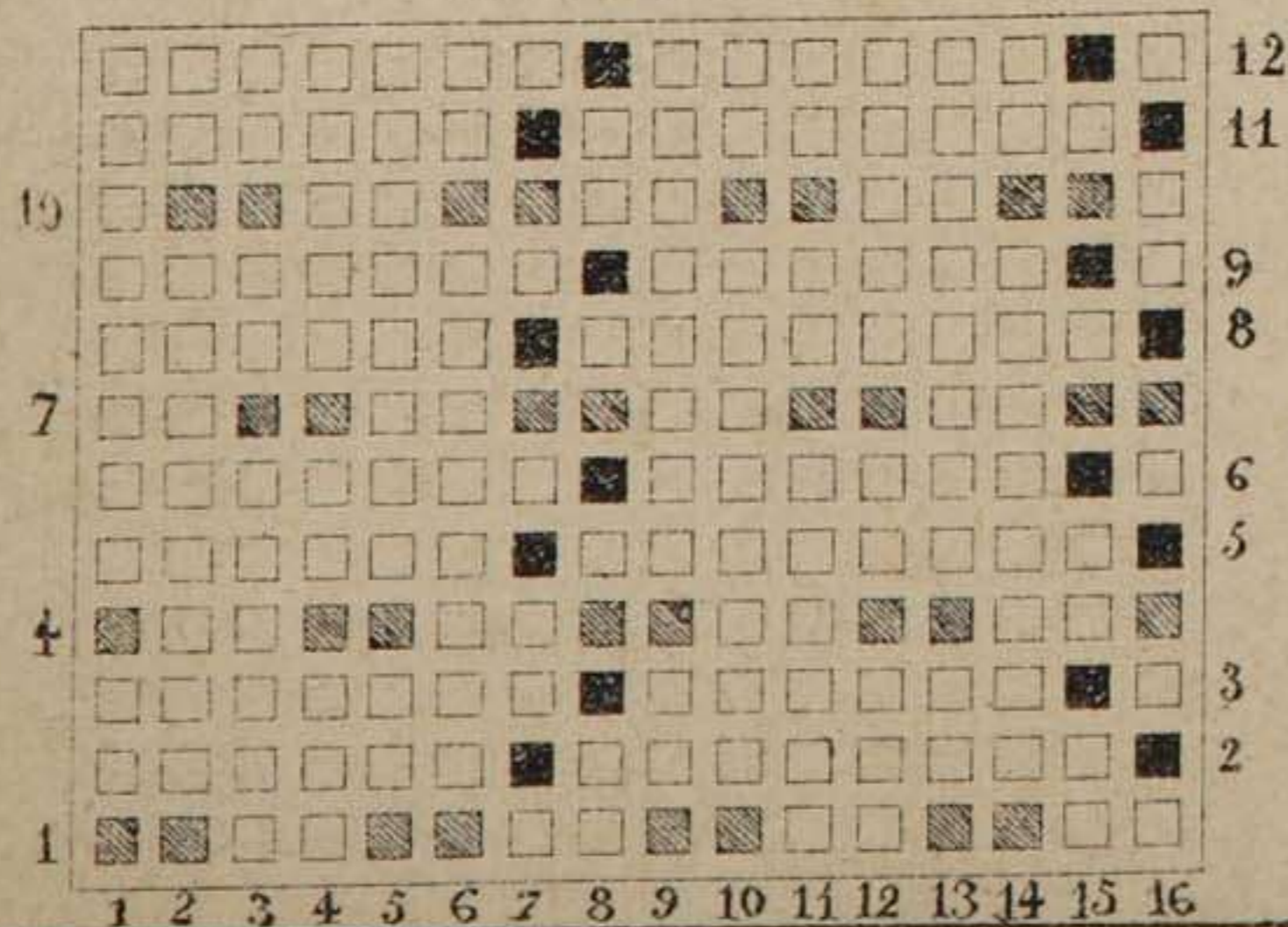
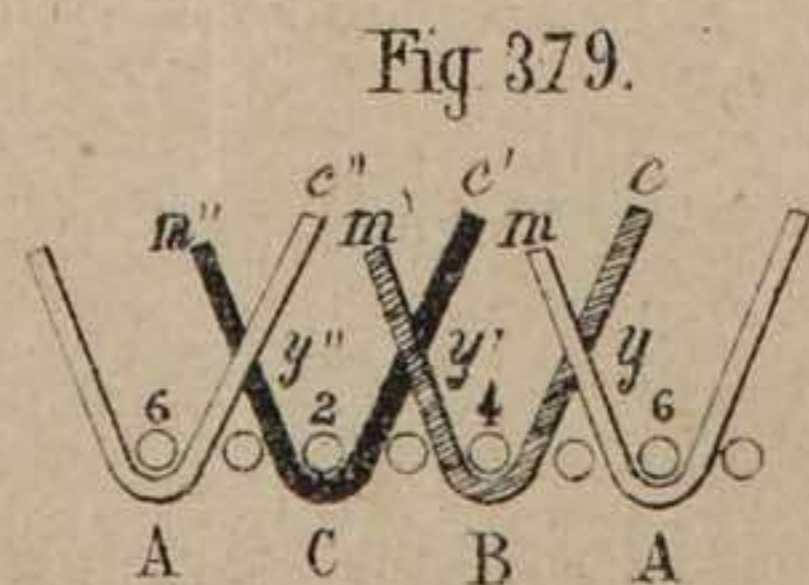
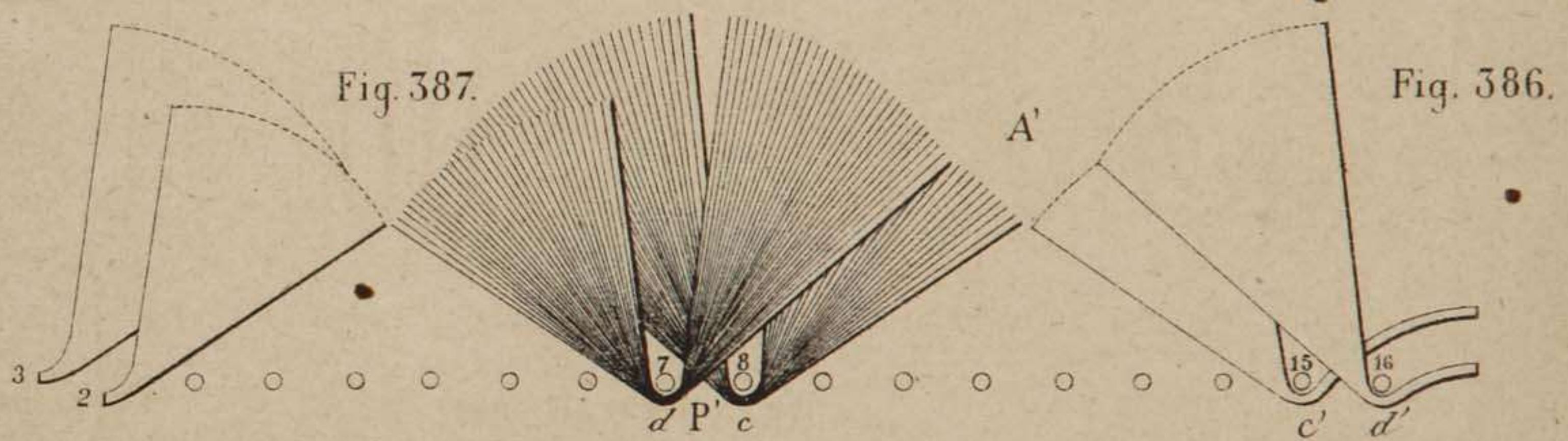
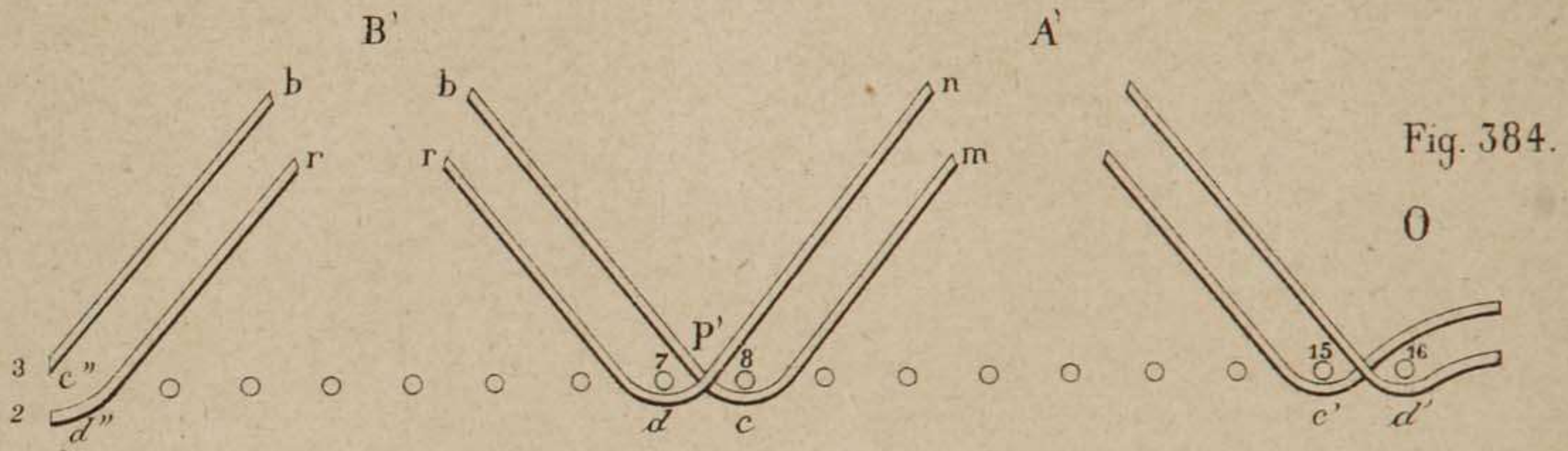
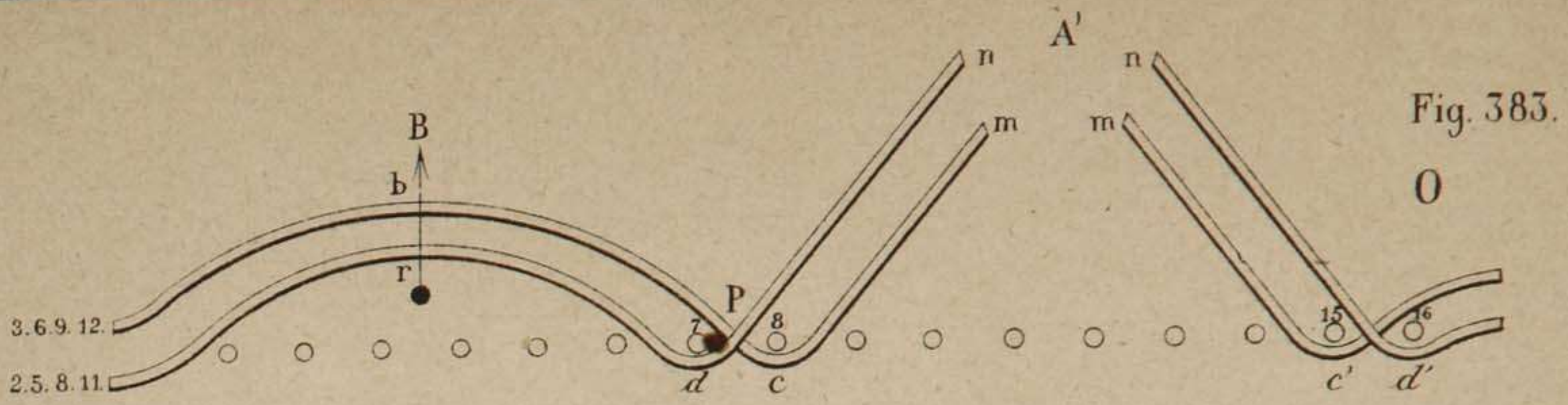


Fig. 380.





LIGAMIENTO MÍNIMO.

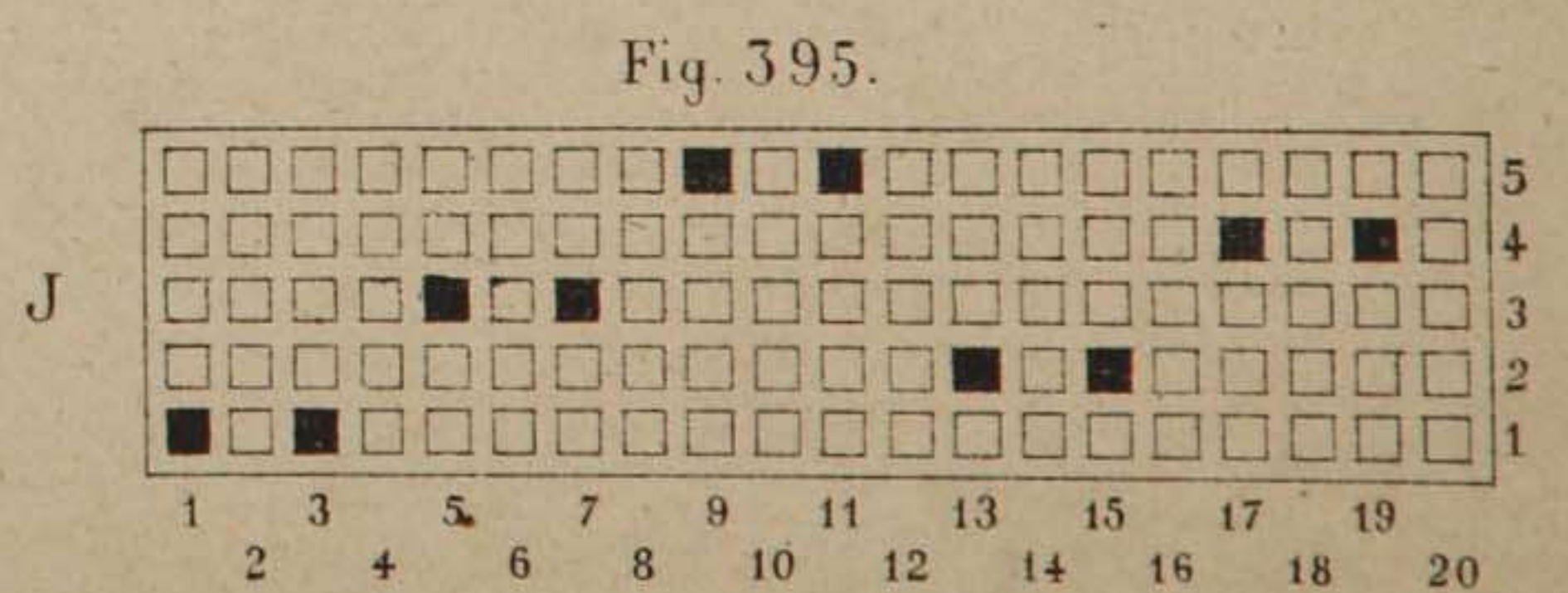
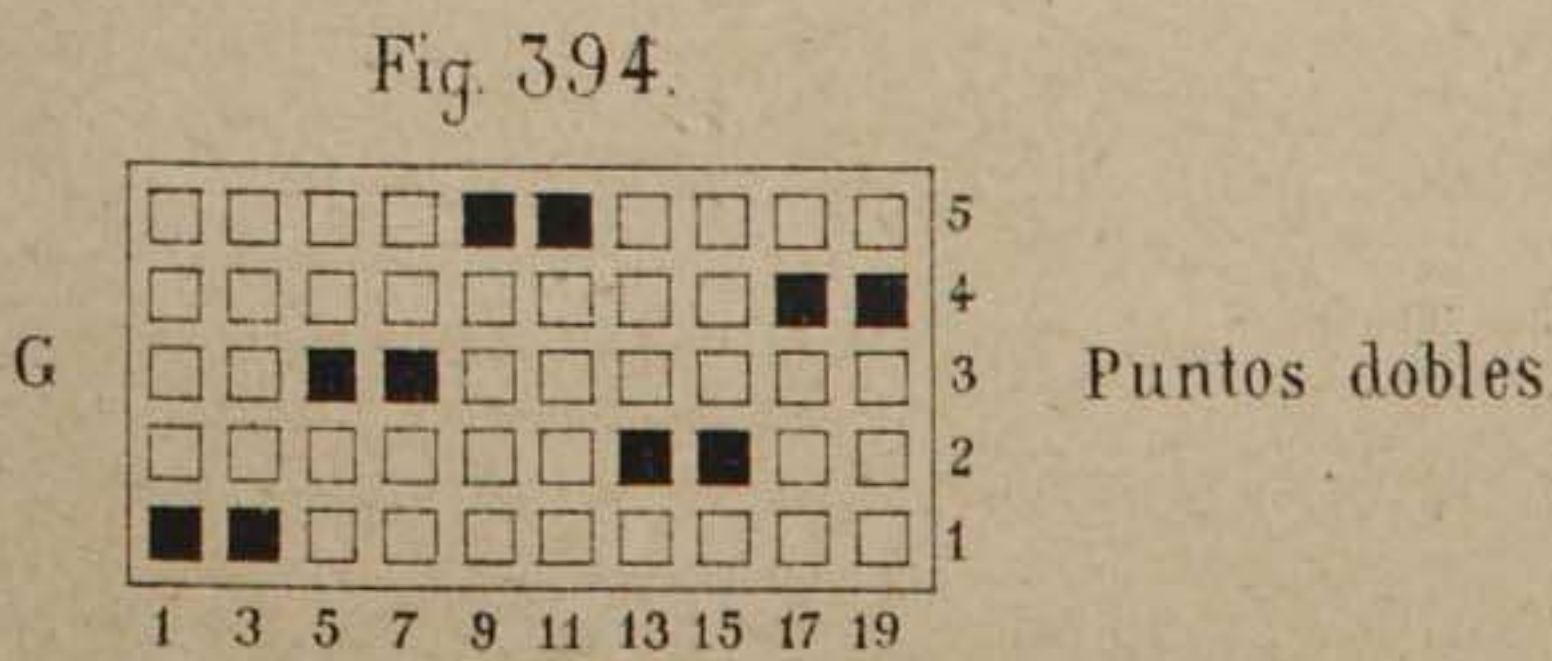
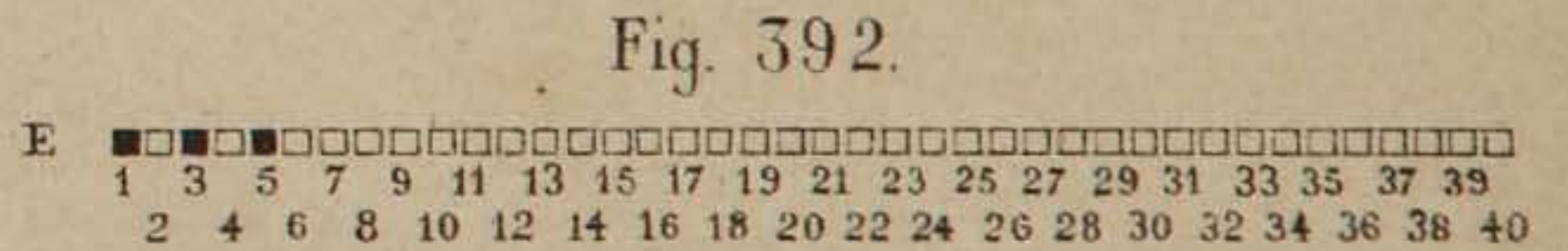
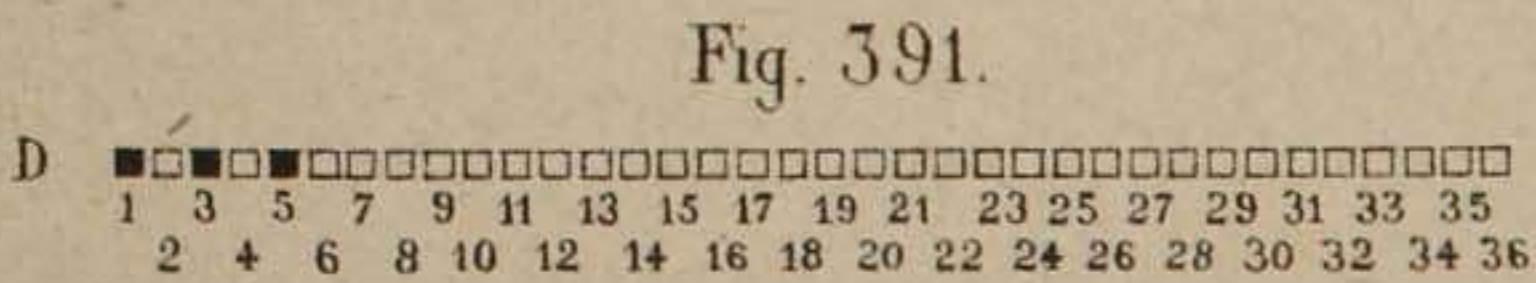
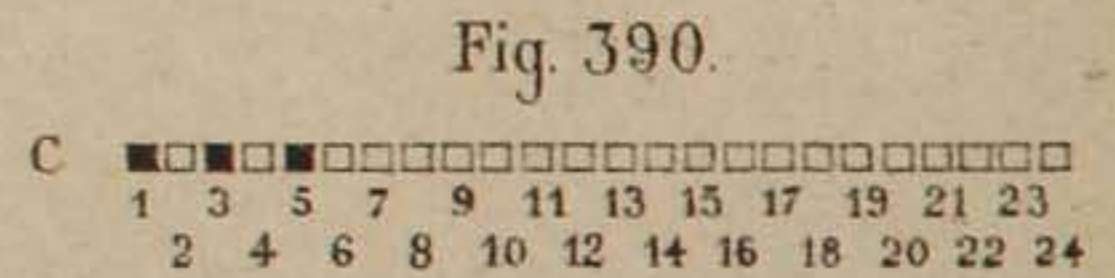
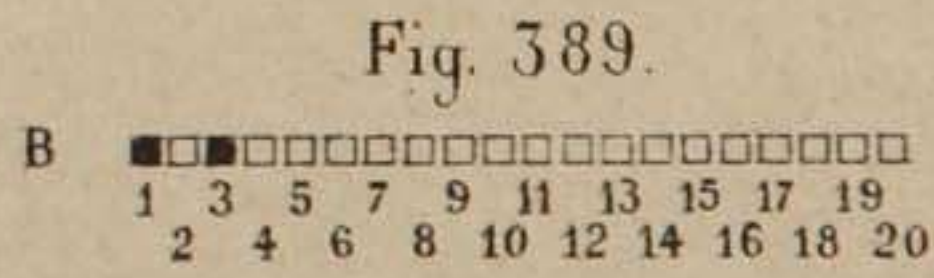
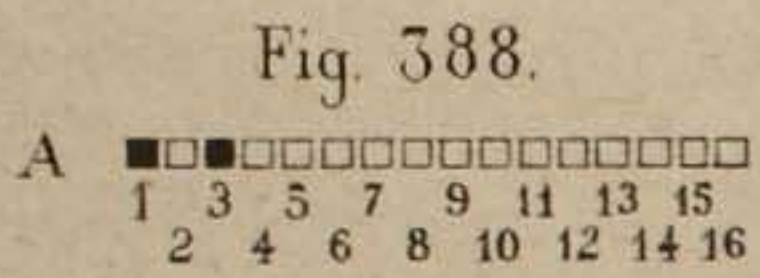
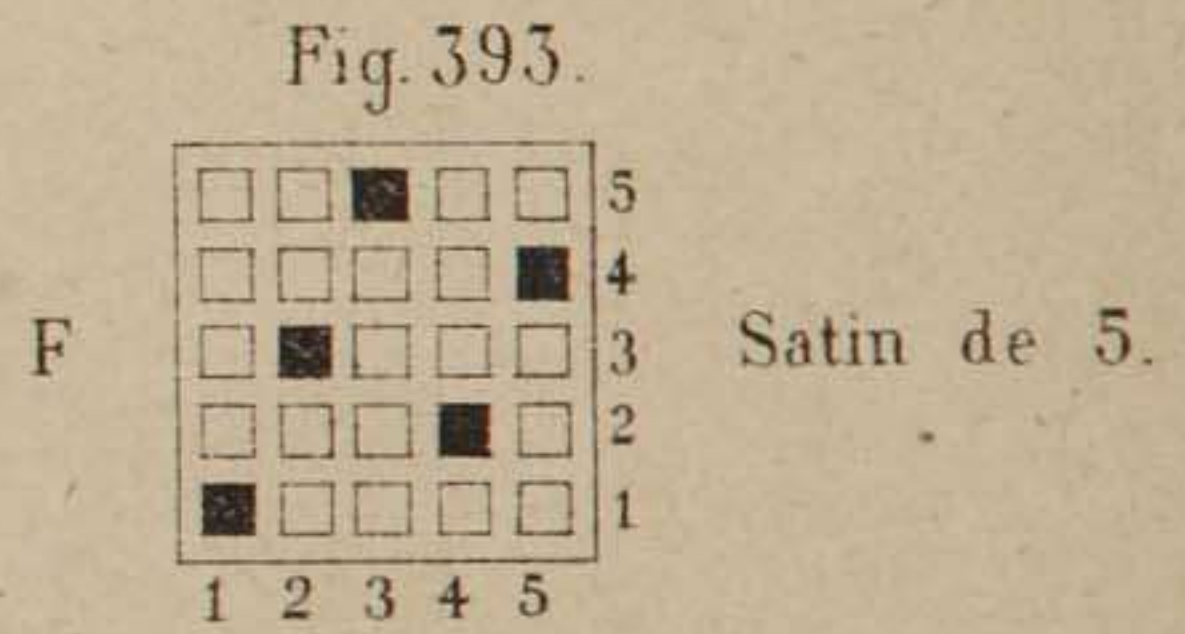
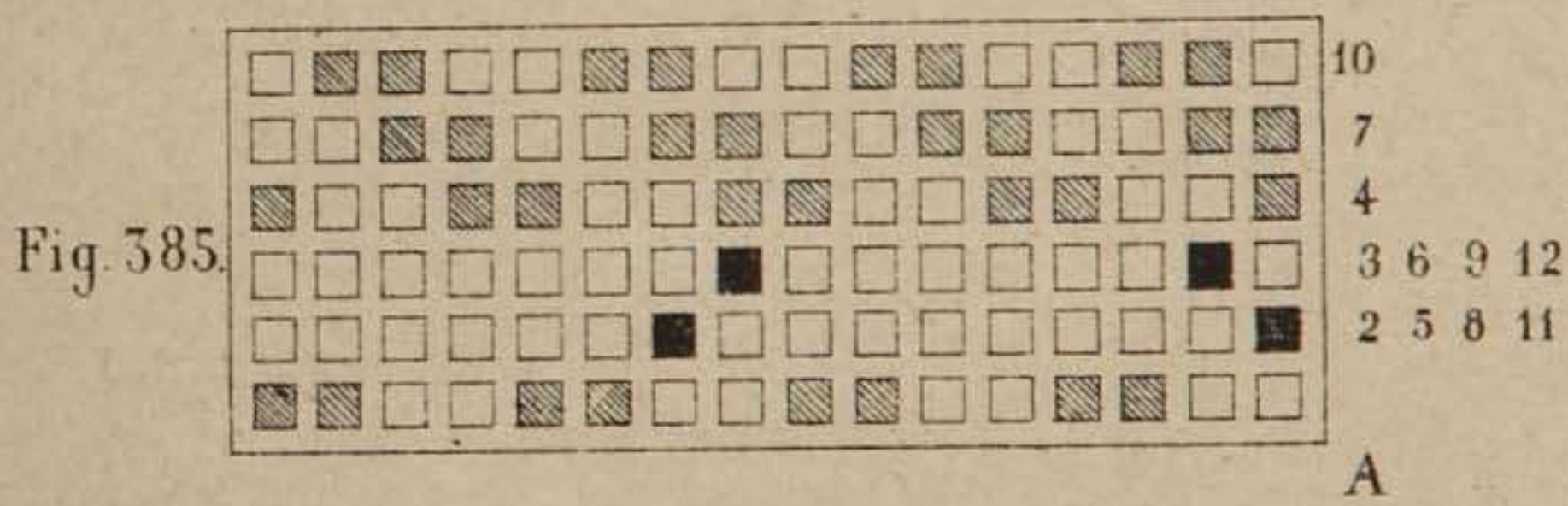


Fig. 400. N

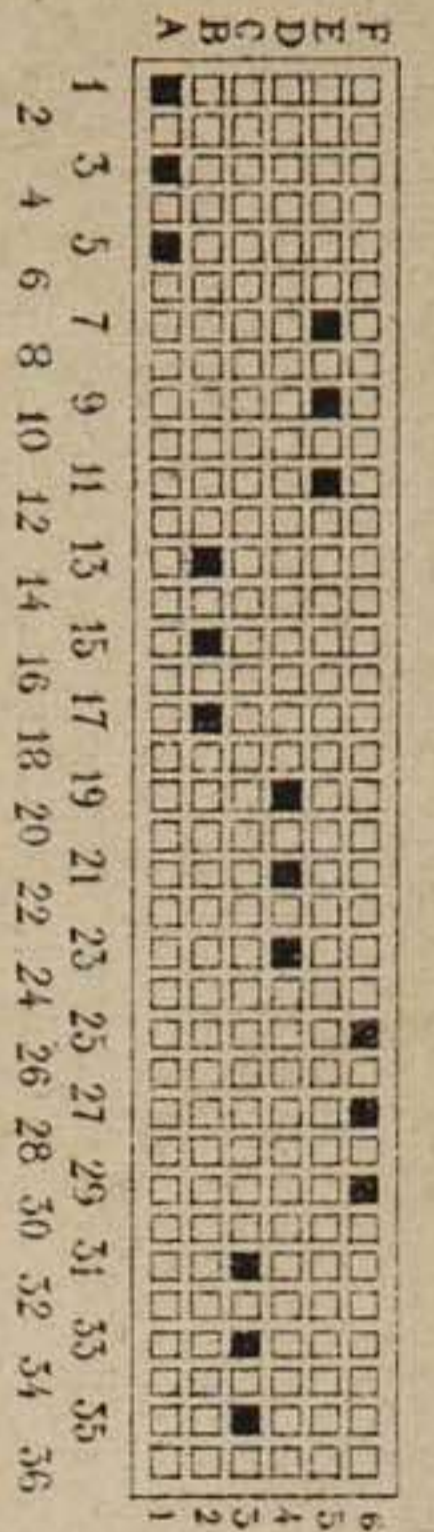


Fig. 396.

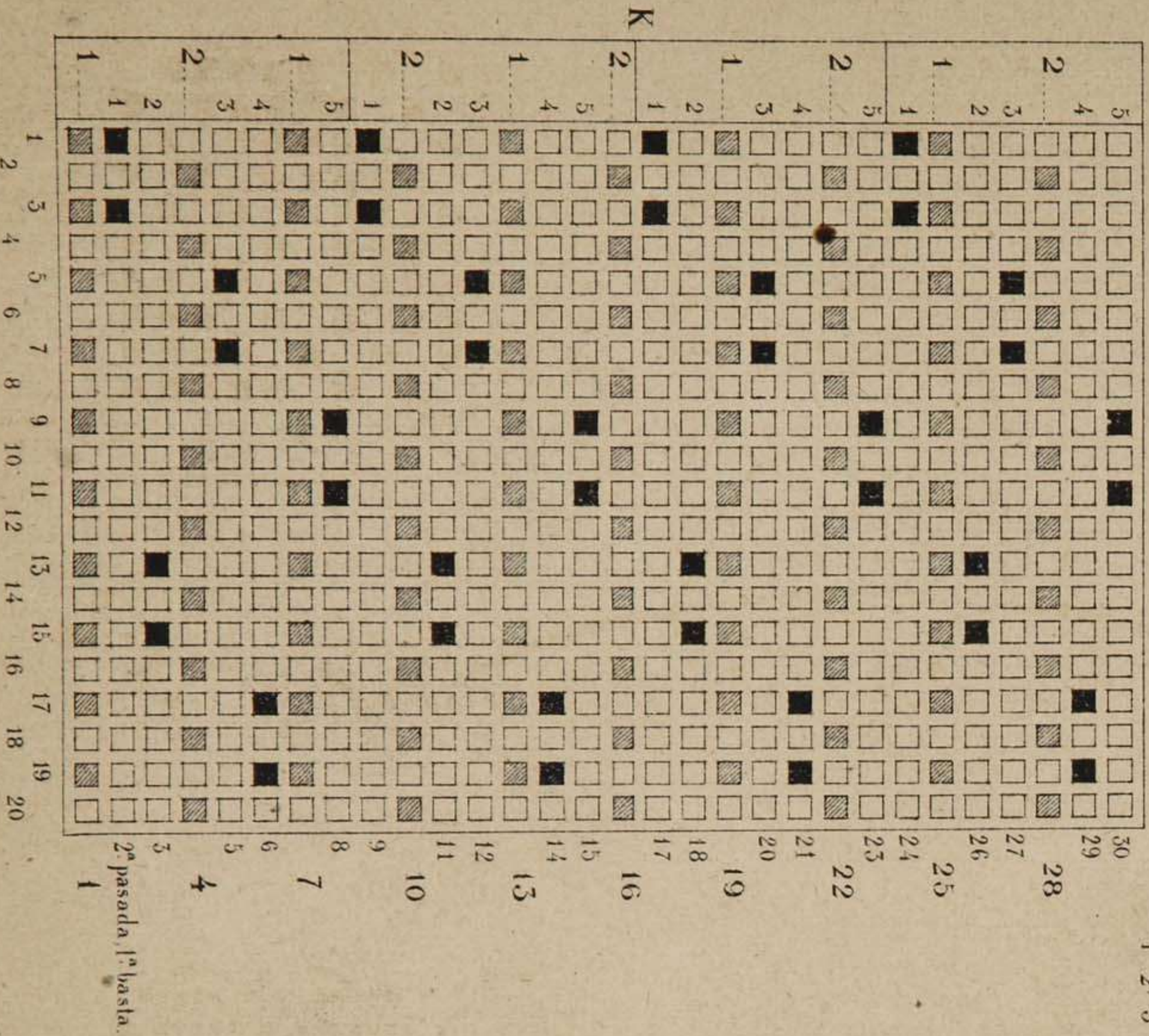
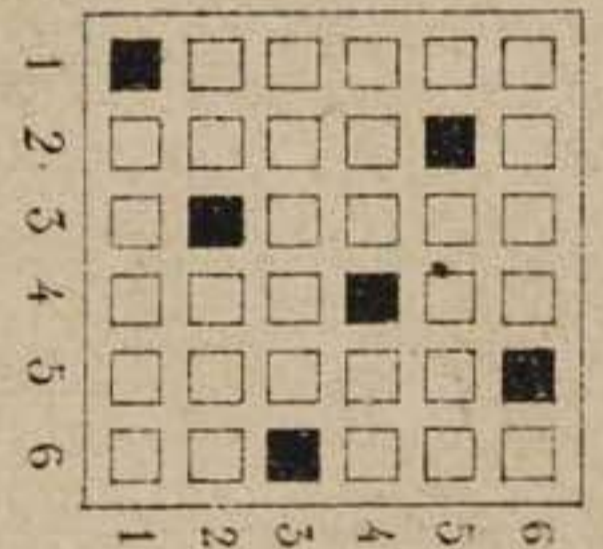


Fig. 398.



M

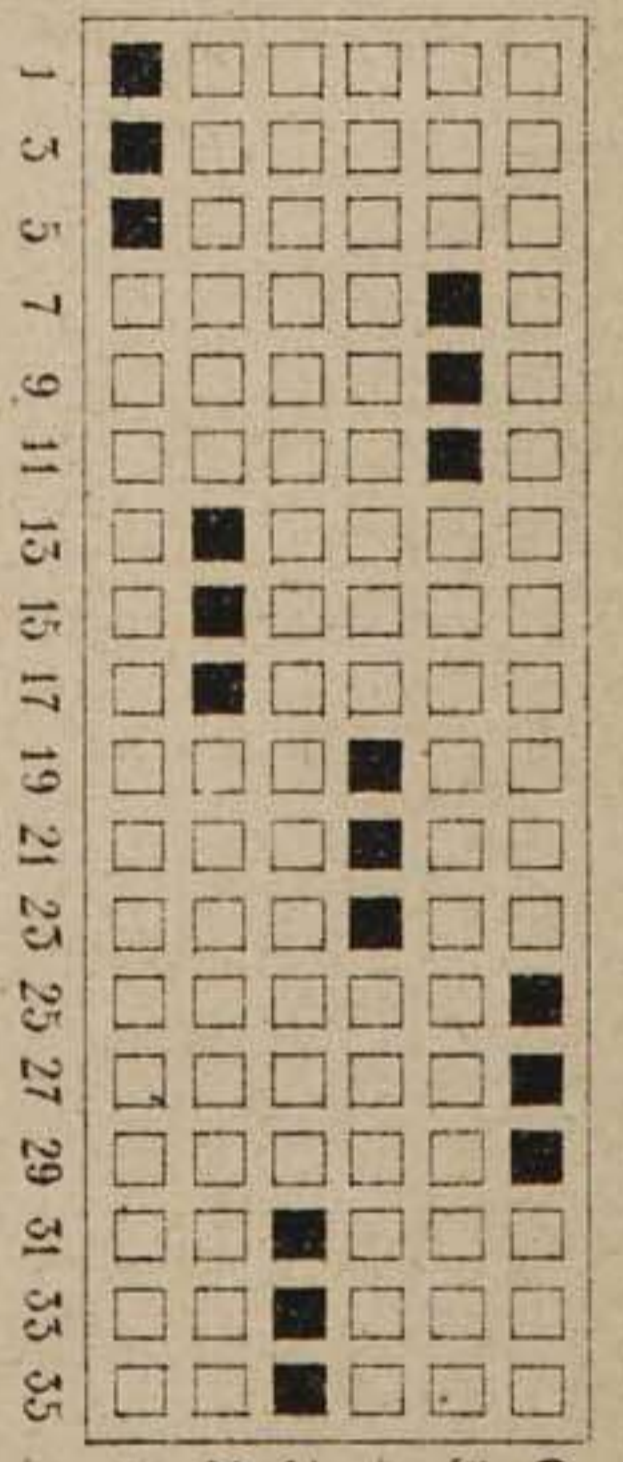


Fig. 399.

Puntos triples.

Fig. 401.

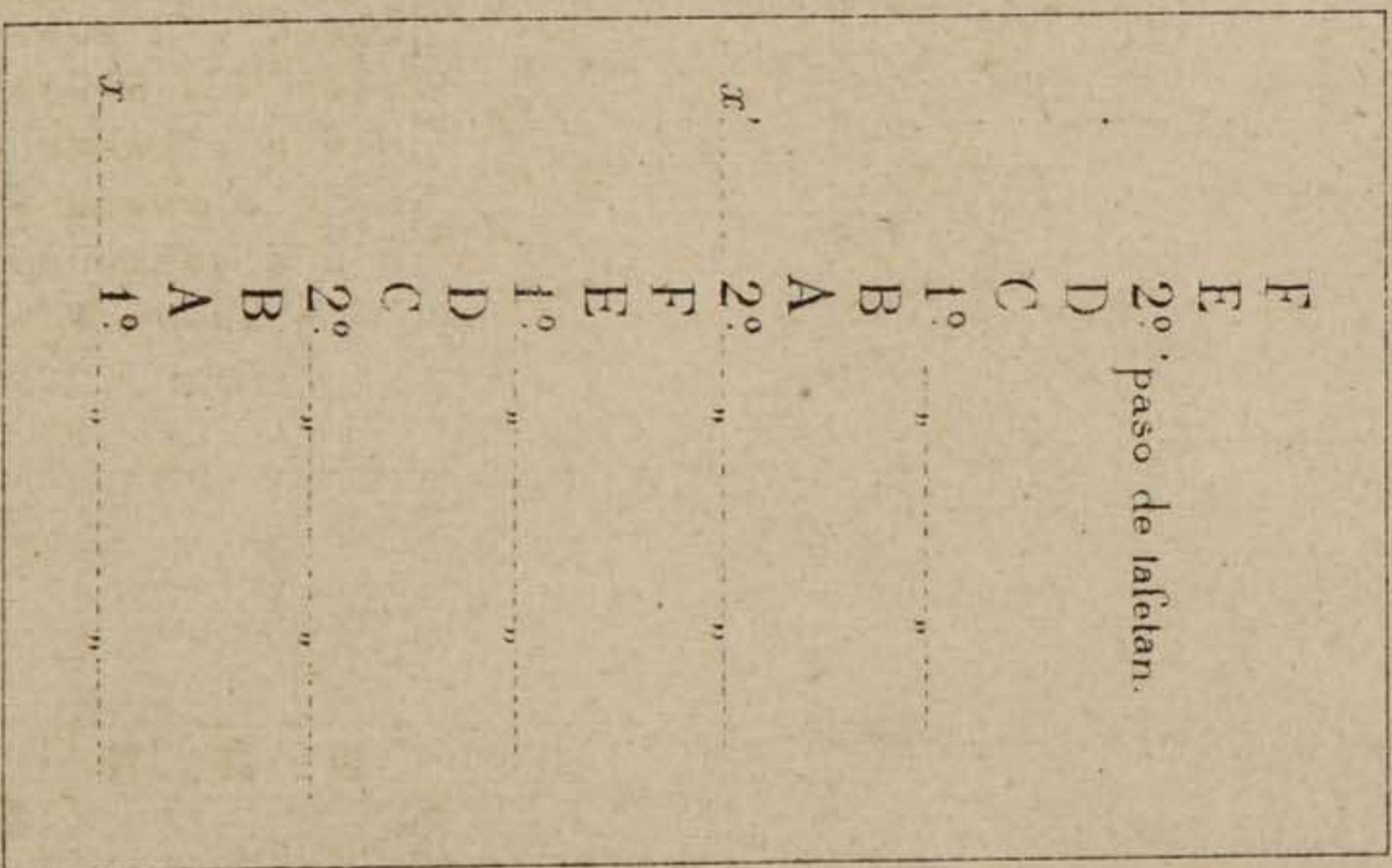


Fig. 397.

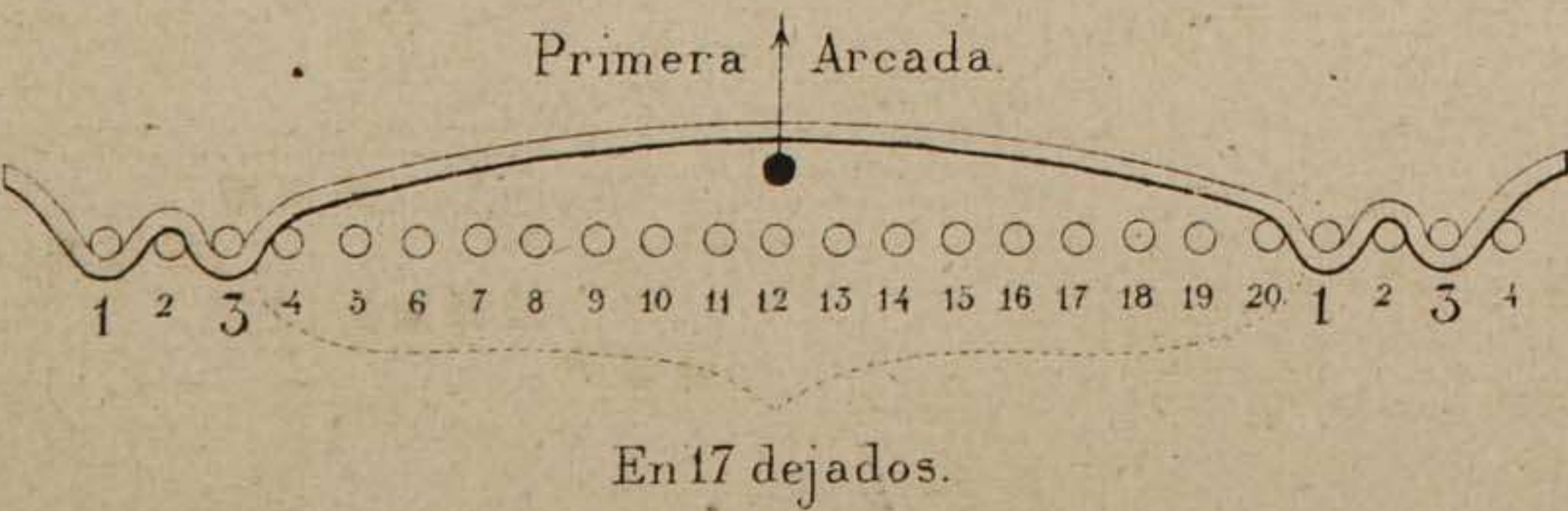


Fig. 404.

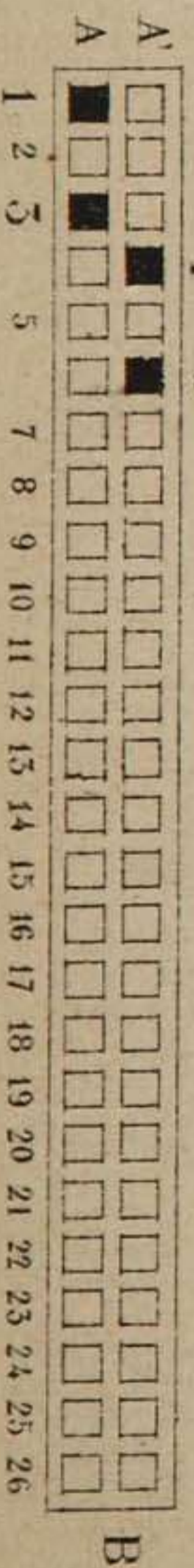


Fig.402.

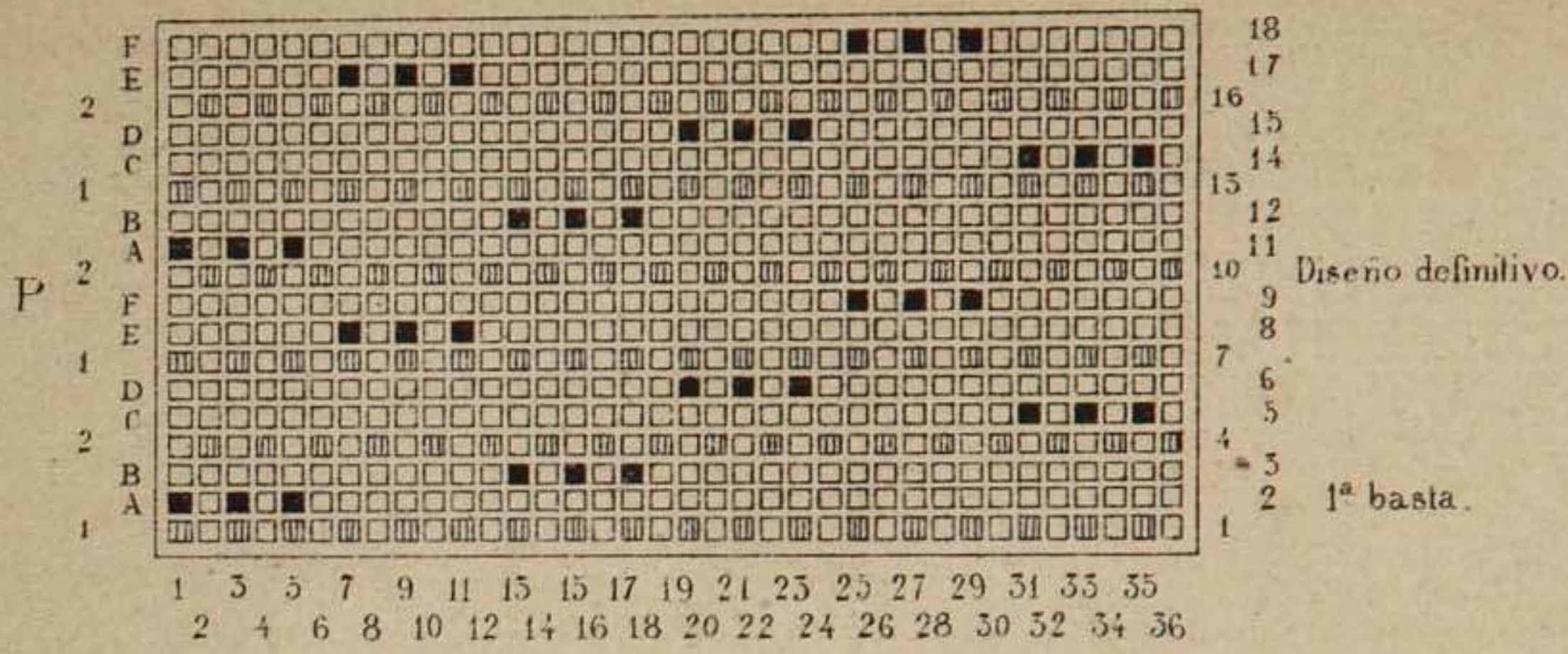


Fig.403.

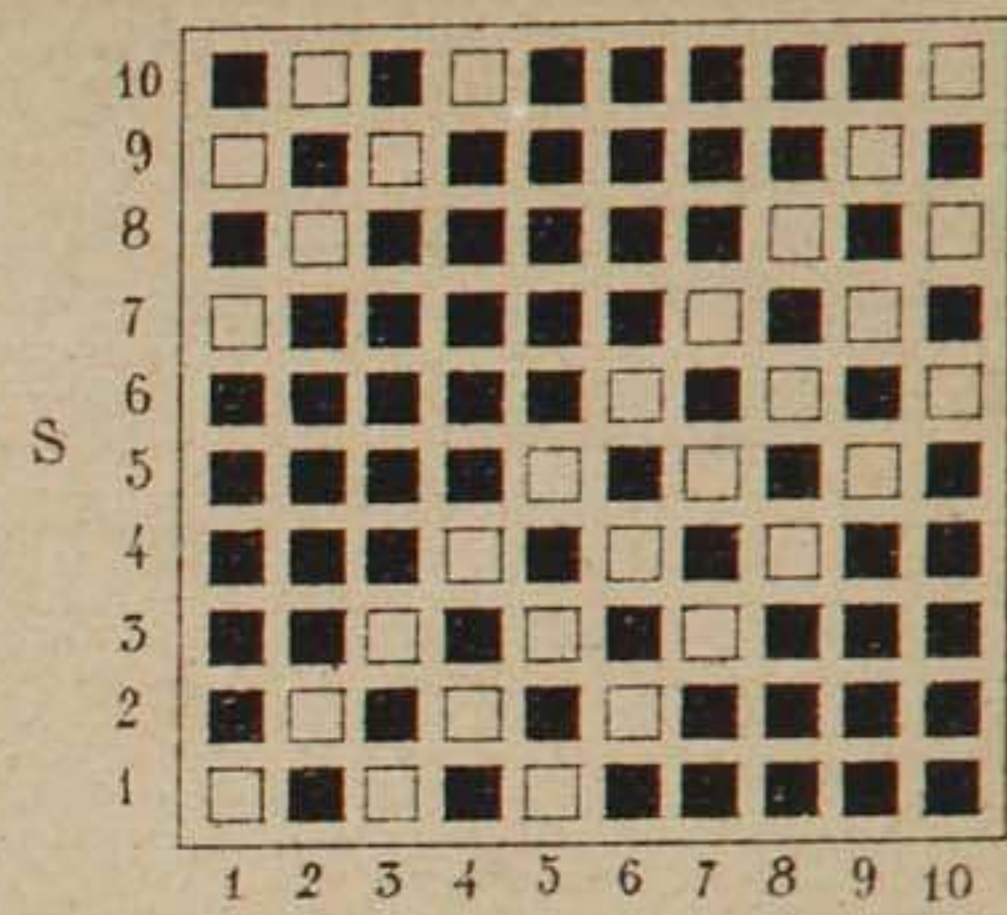


Fig.405.

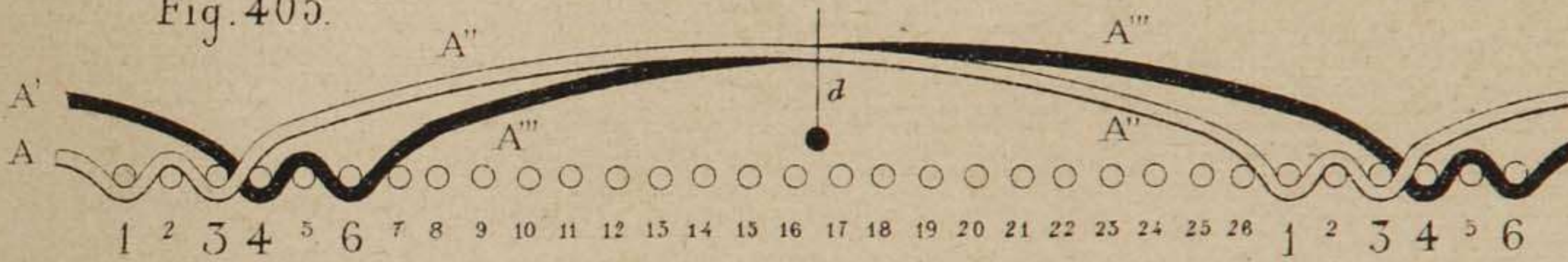


Fig.410.

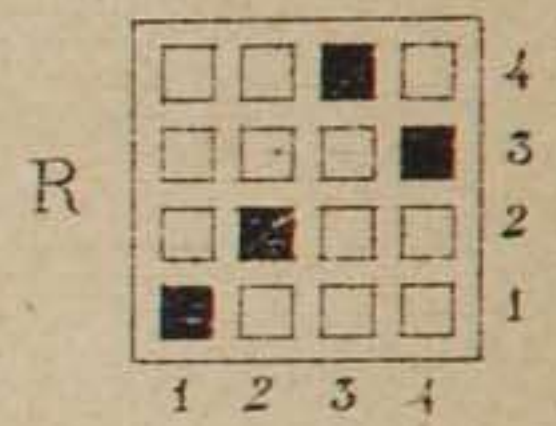


Fig.407.



Fig.406.

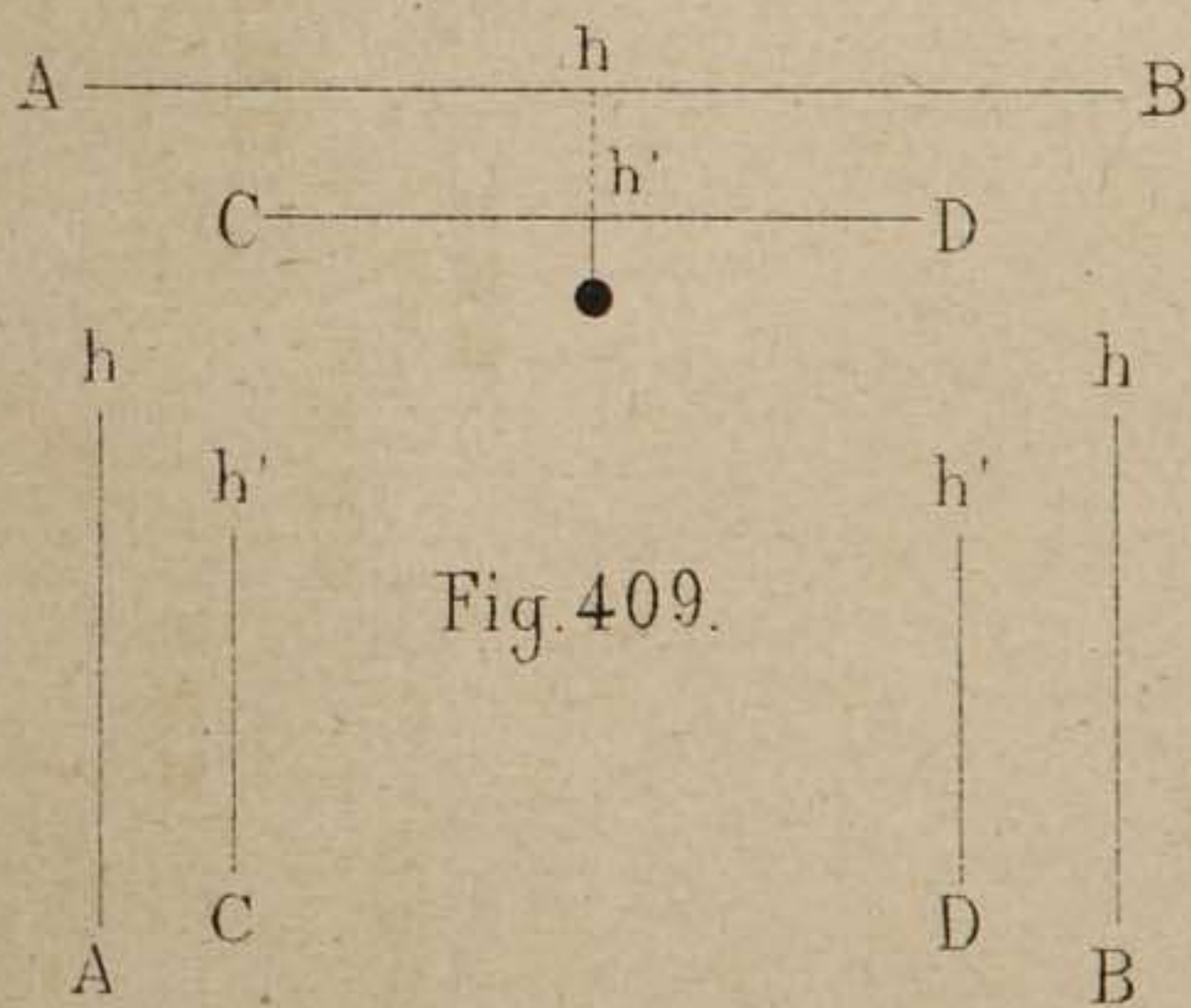
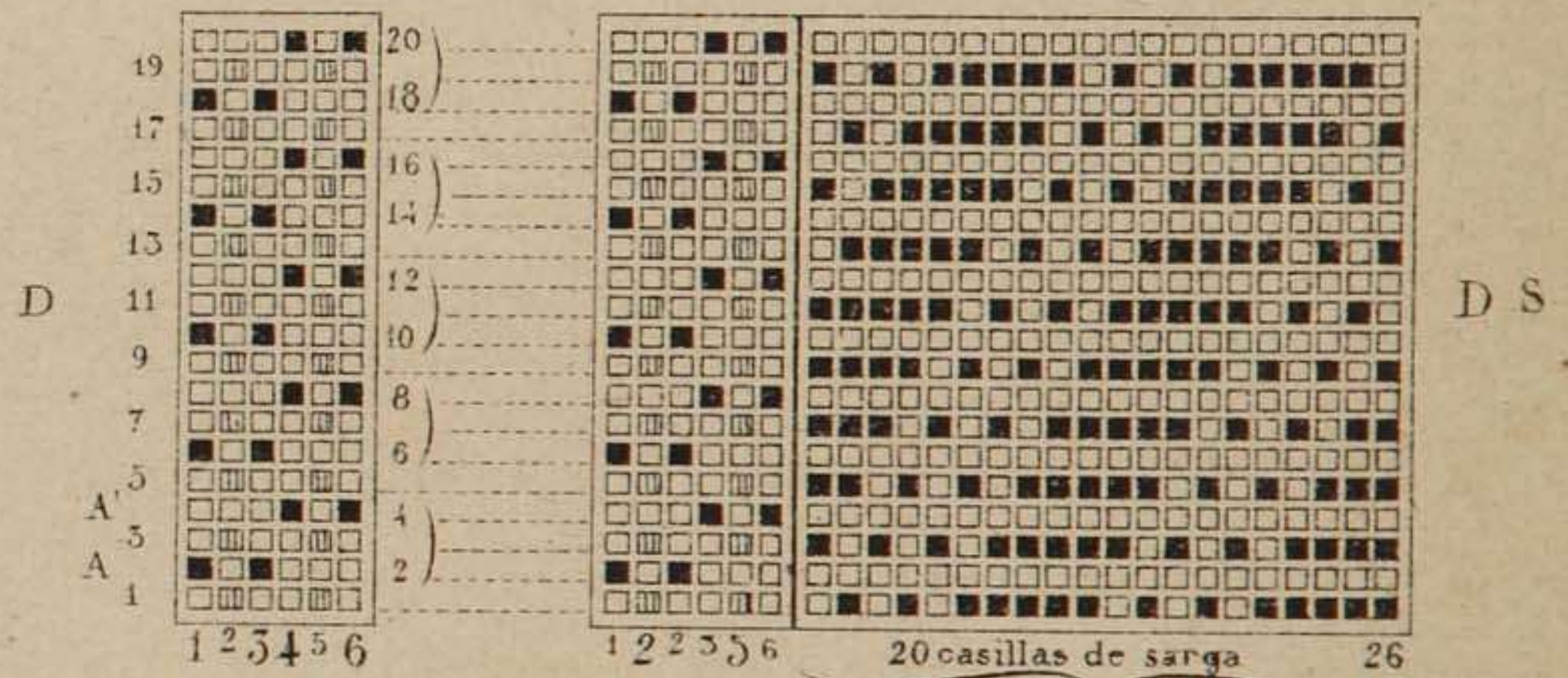


Fig.409.

Fig.412.

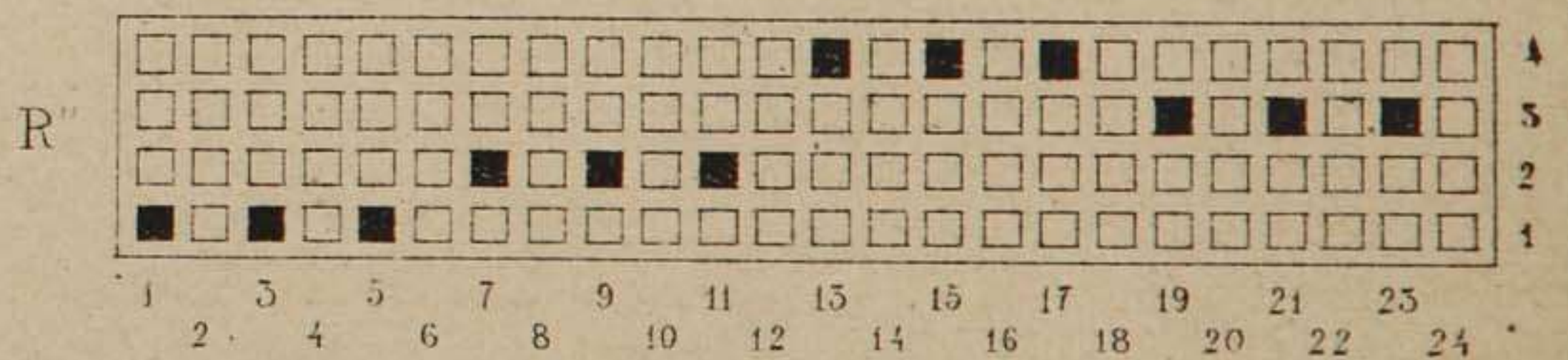


Fig.408.

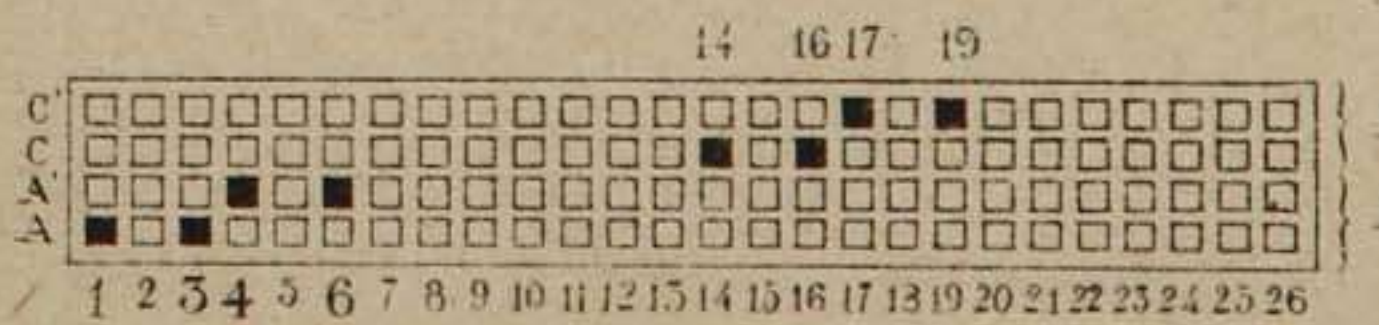
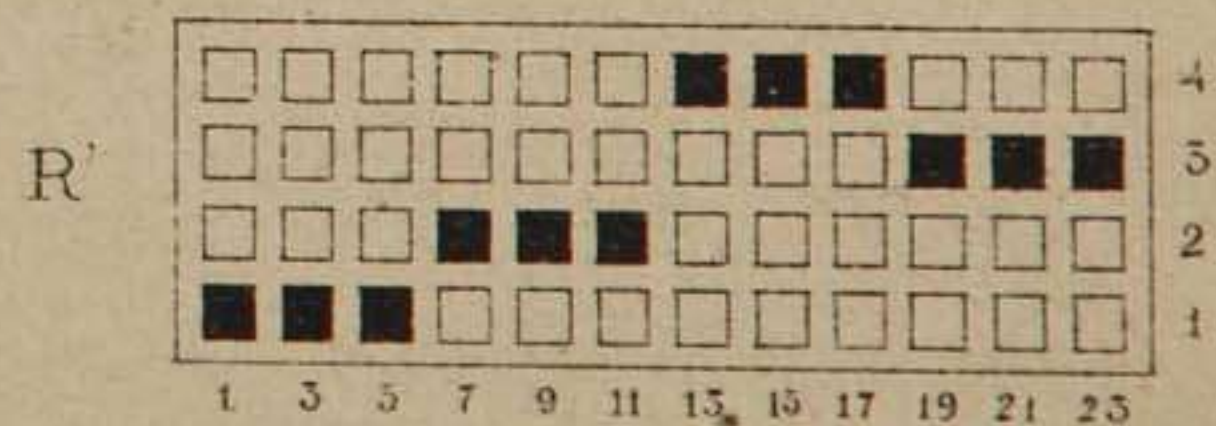


Fig.411.



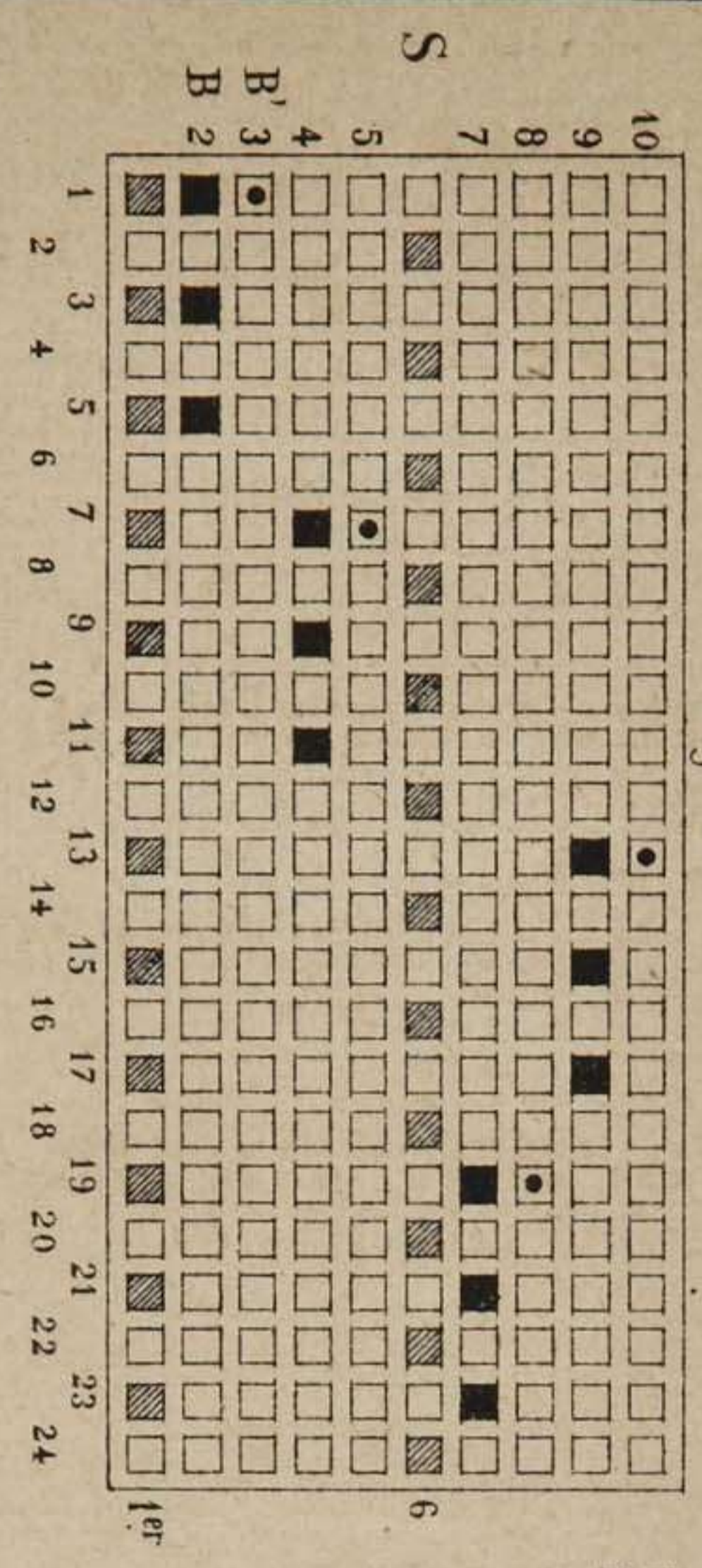


Fig. 413.

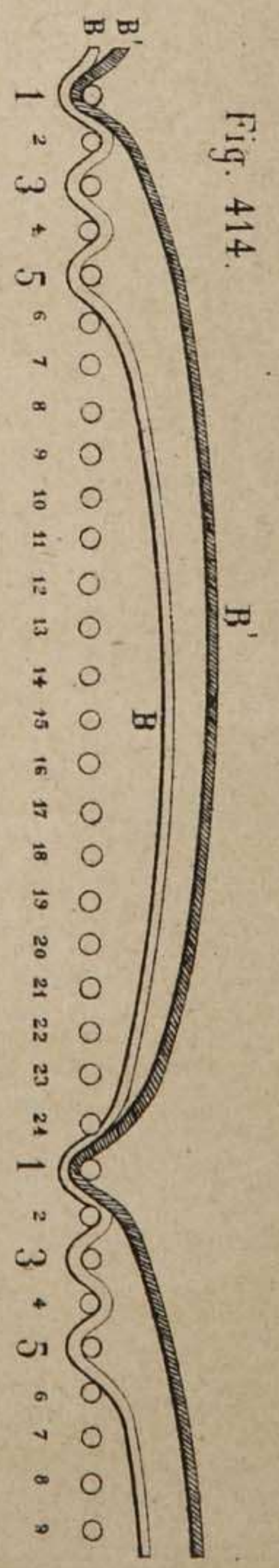


Fig. 414.

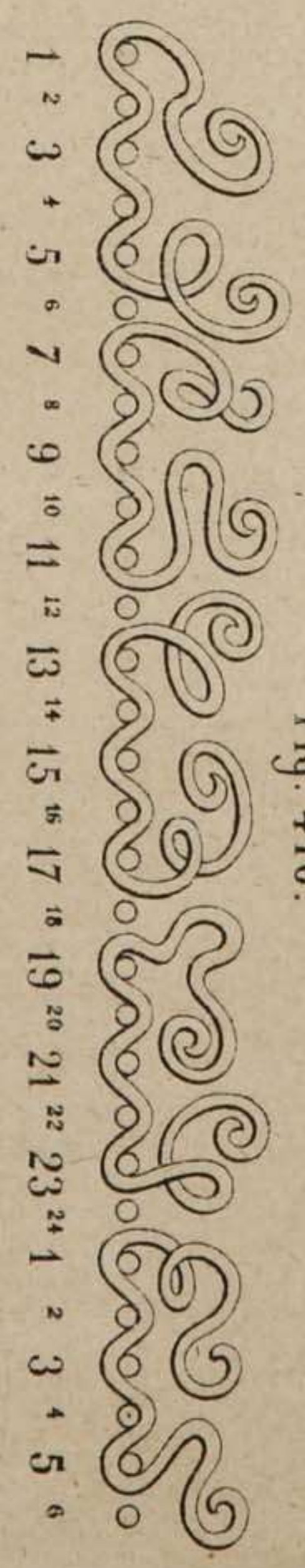


Fig. 416.

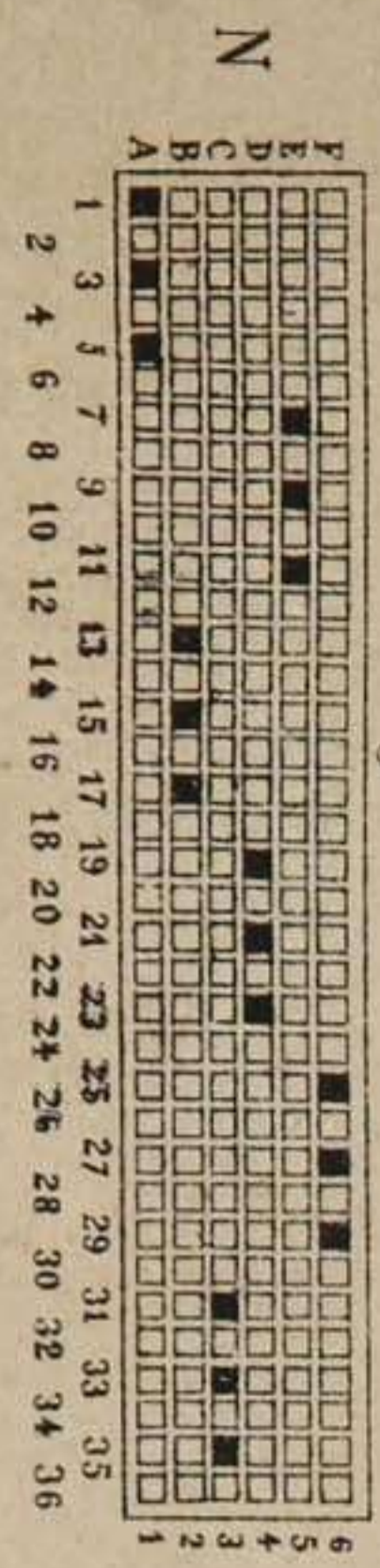


Fig. 418.

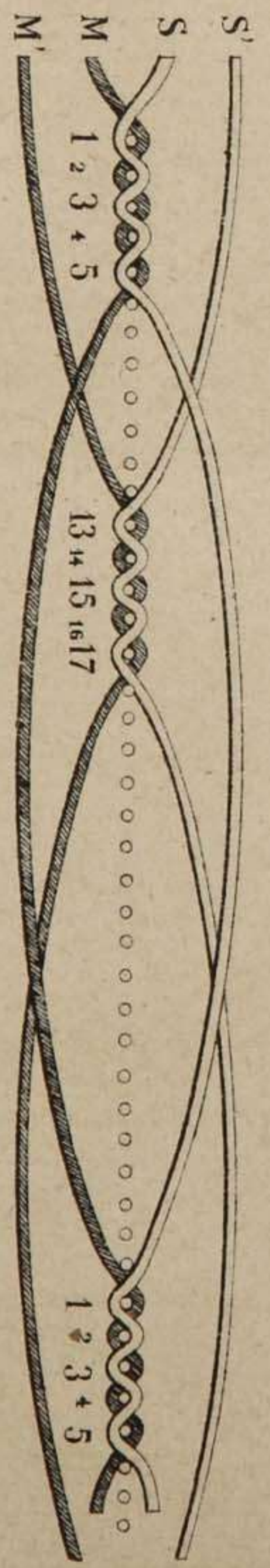


Fig. 421.



Fig. 415.

Fig. 420.

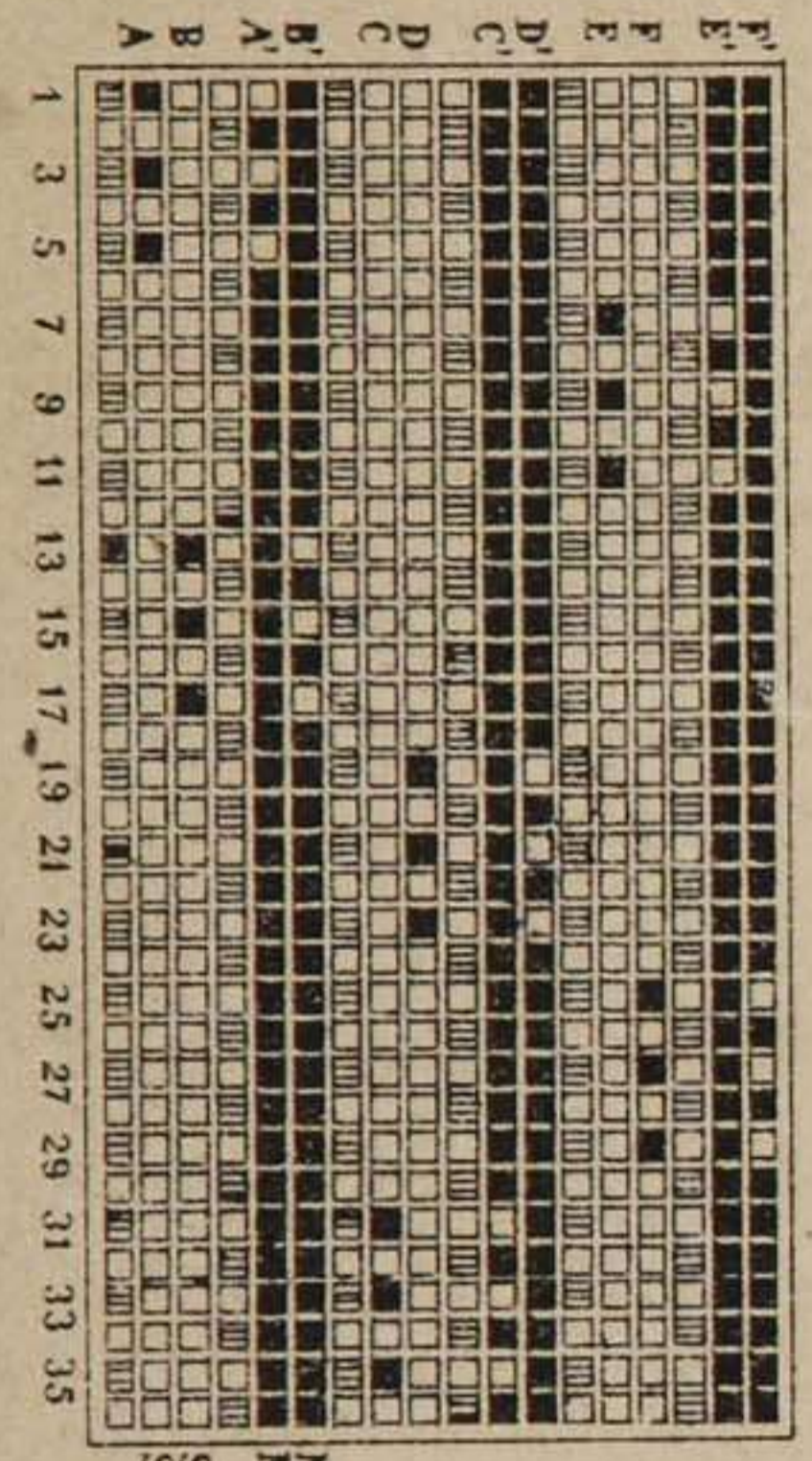


Fig. 417.

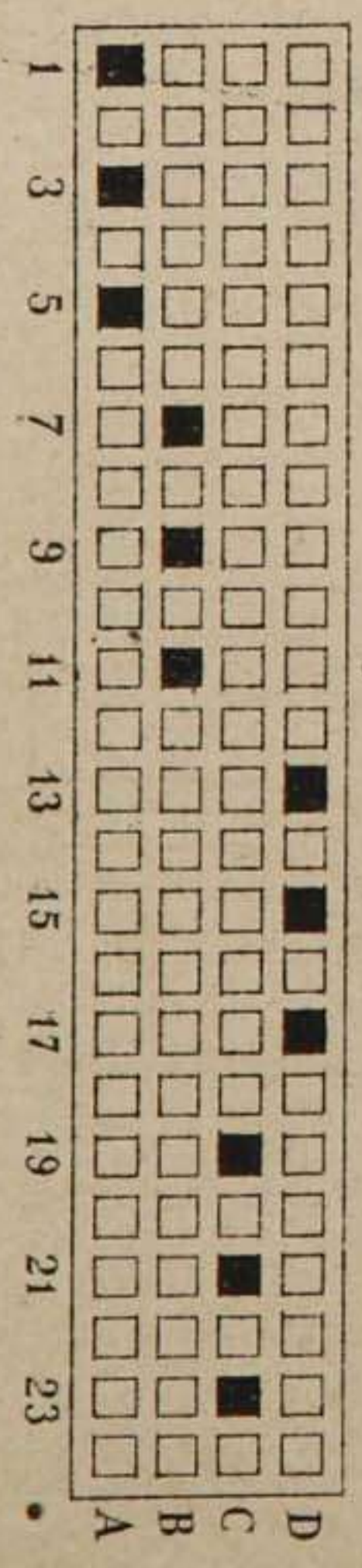
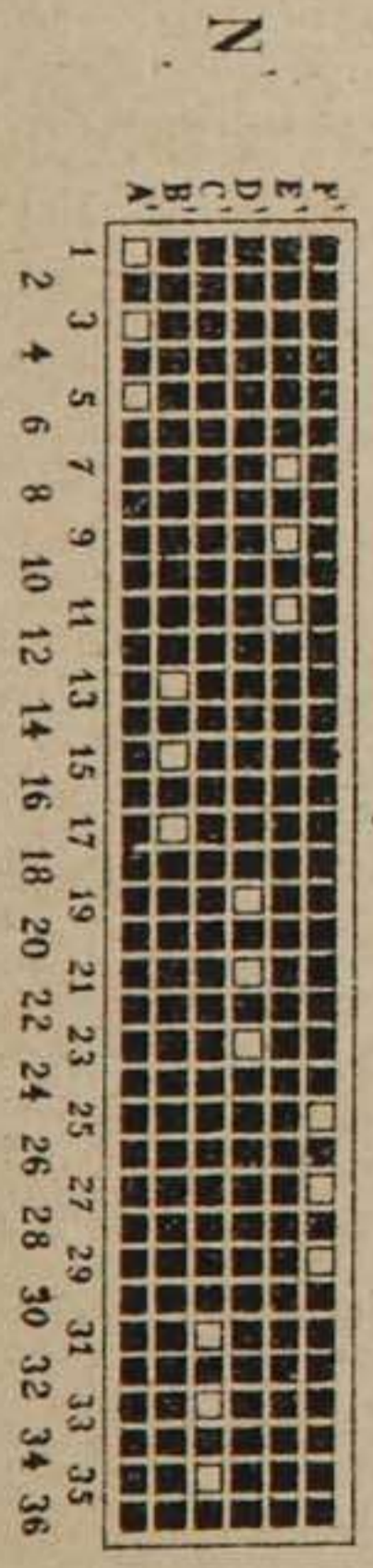


Fig. 419.



seis bastas.

Fig. 424.

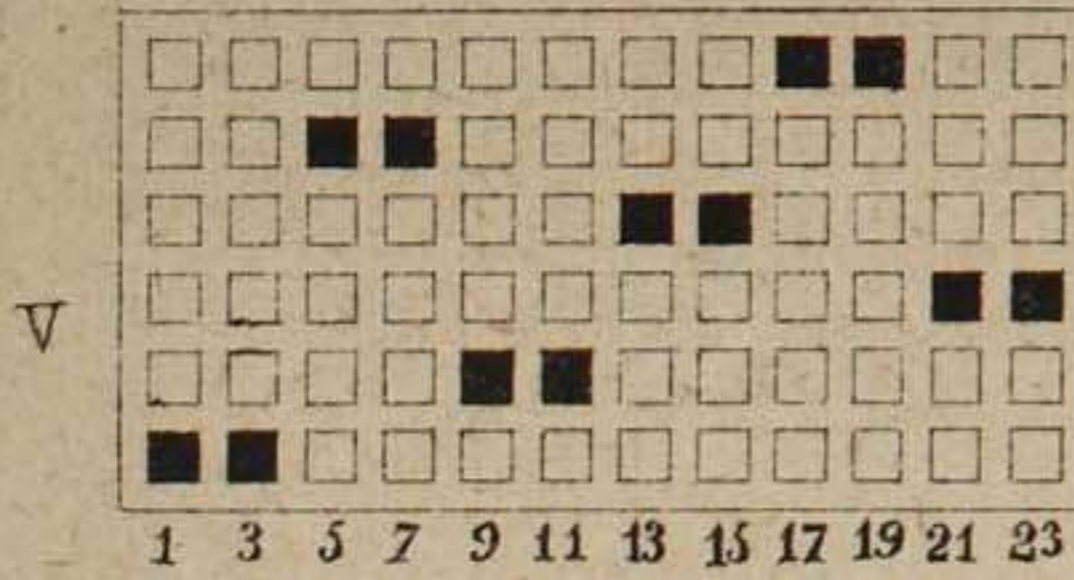


Fig. 426
Diseño GV.

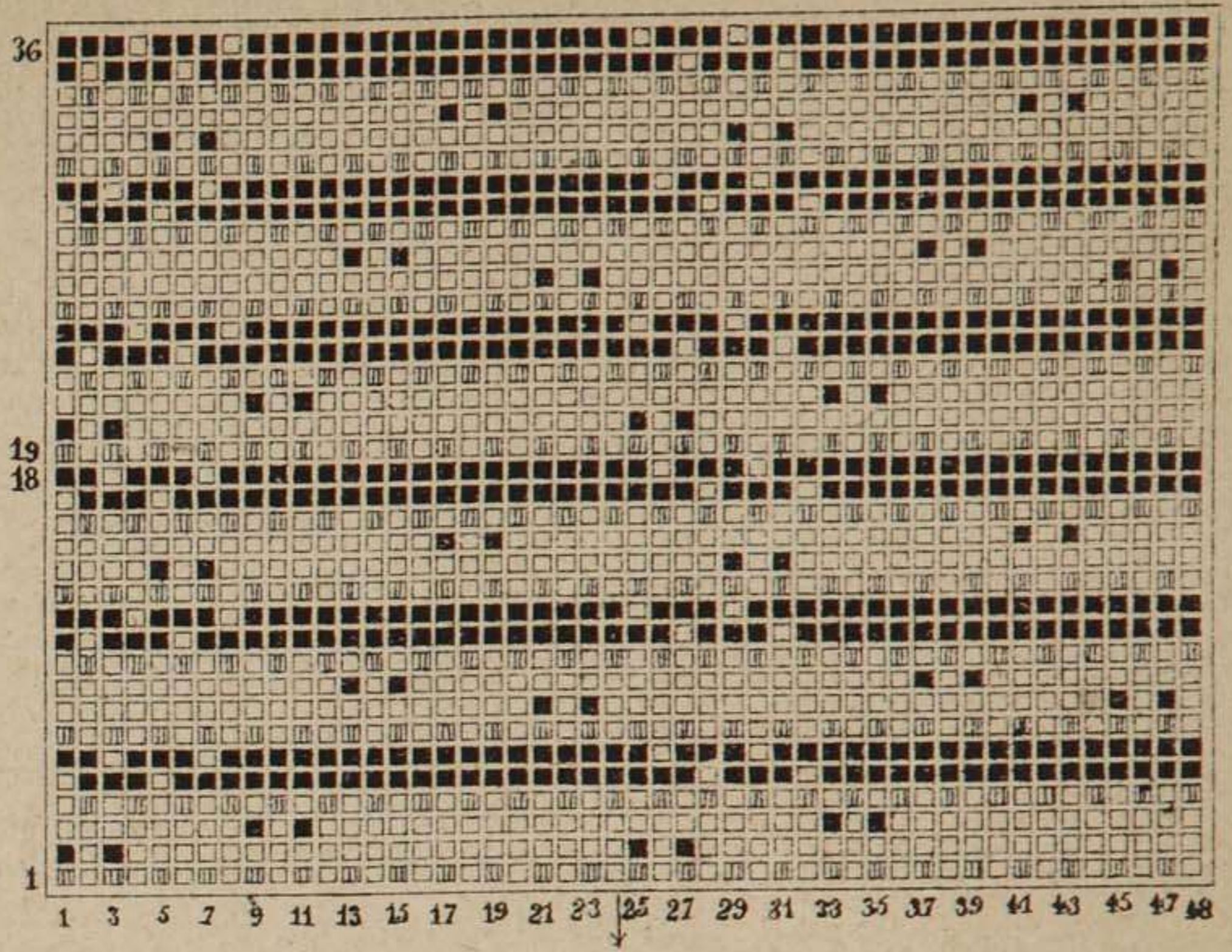


Fig. 427.

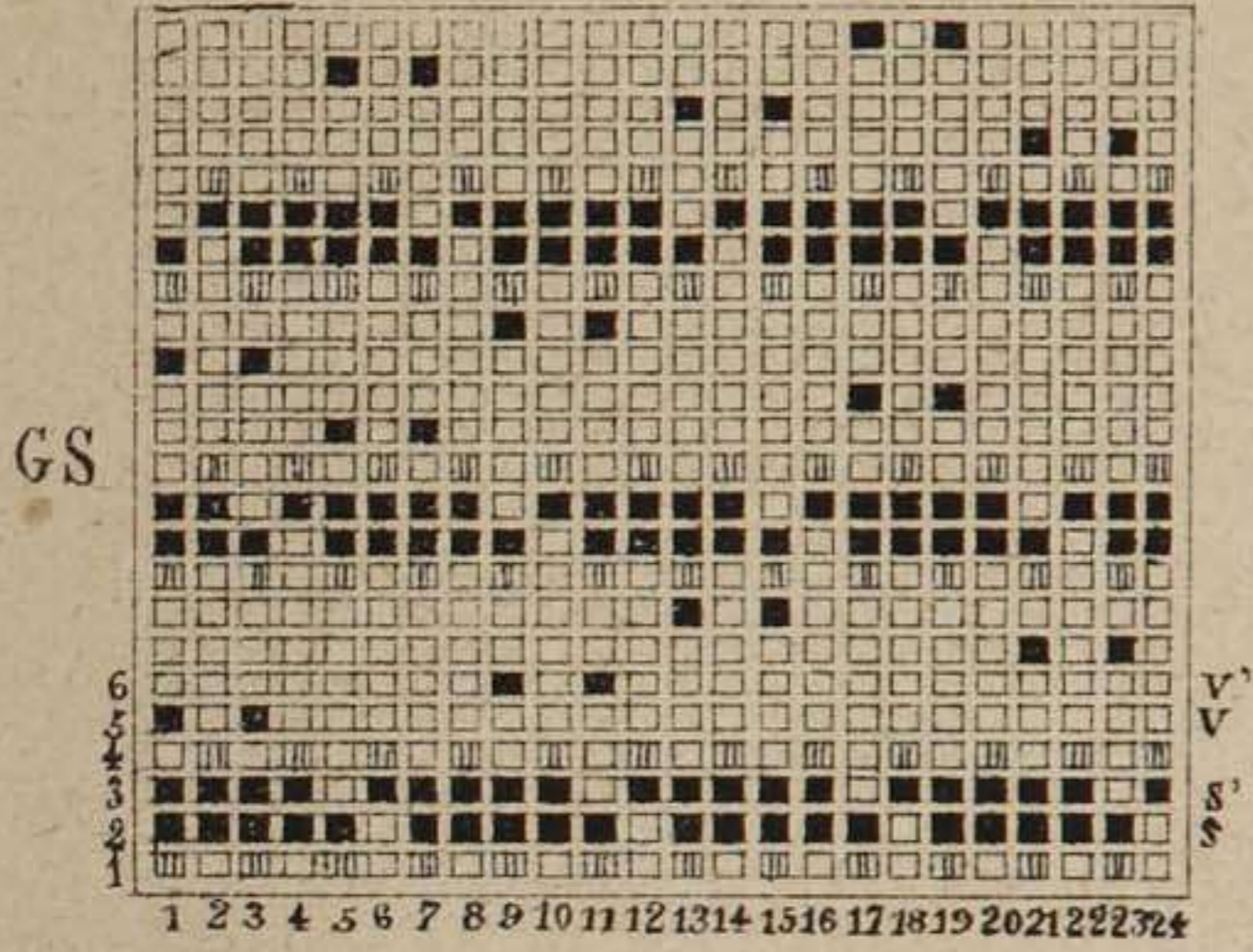


Fig. 425.

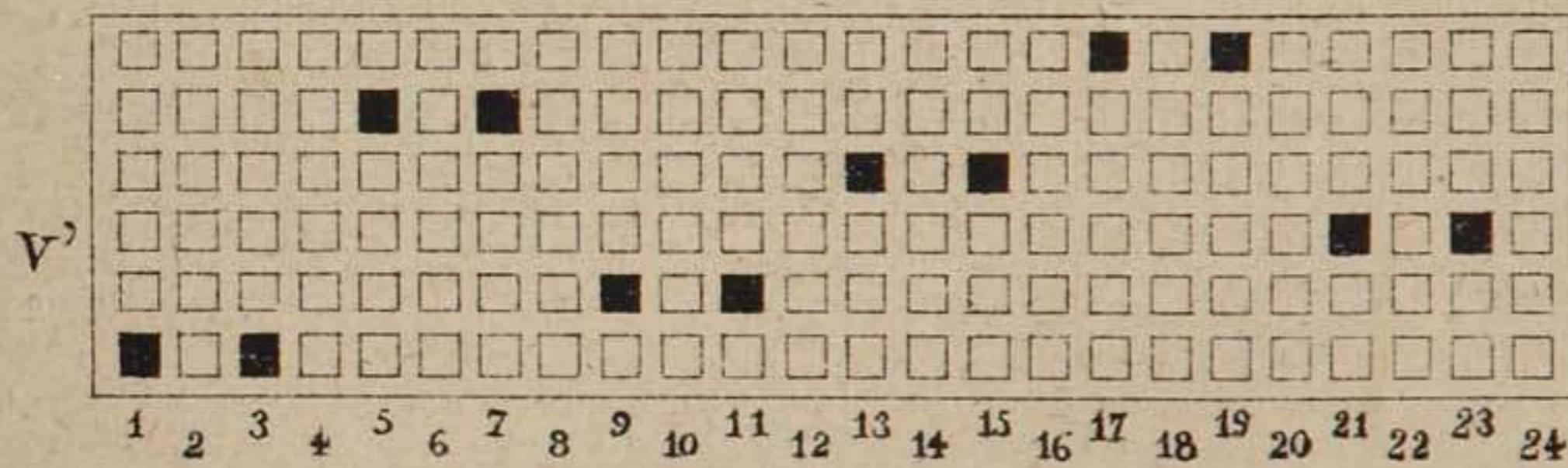


Fig. 430.

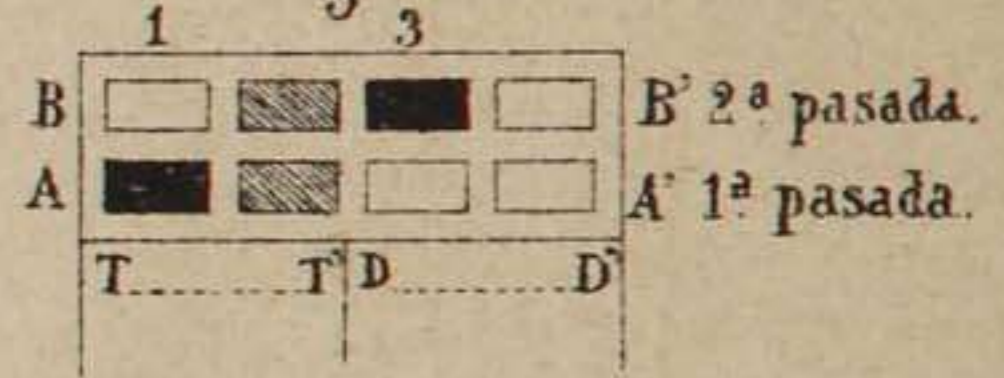


Fig. 422.

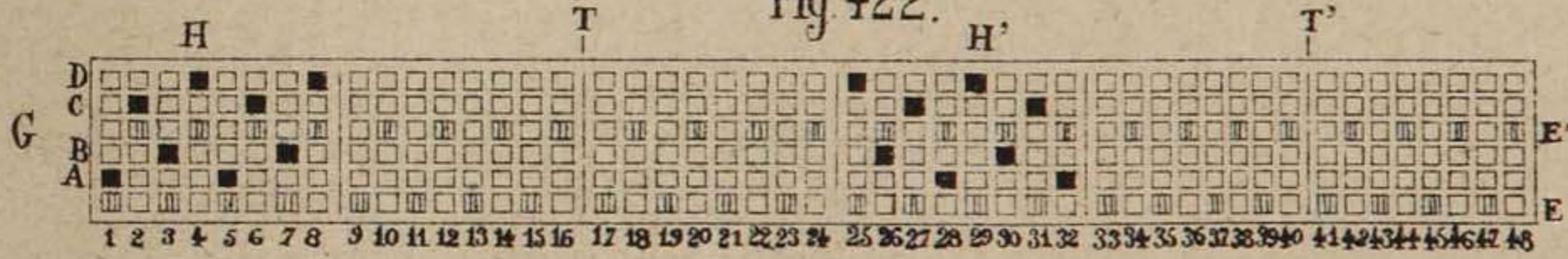
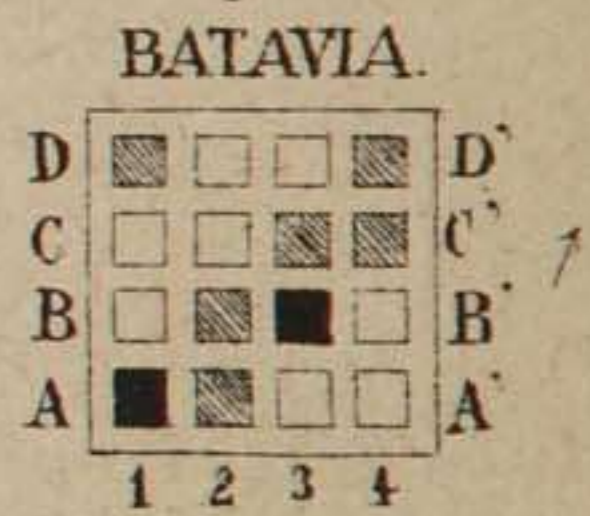


Fig. 429.



Leyenda

- A Rojo.
- B Verde.
- C Carmin en rojo.
- D Azul.

Fig. 423.

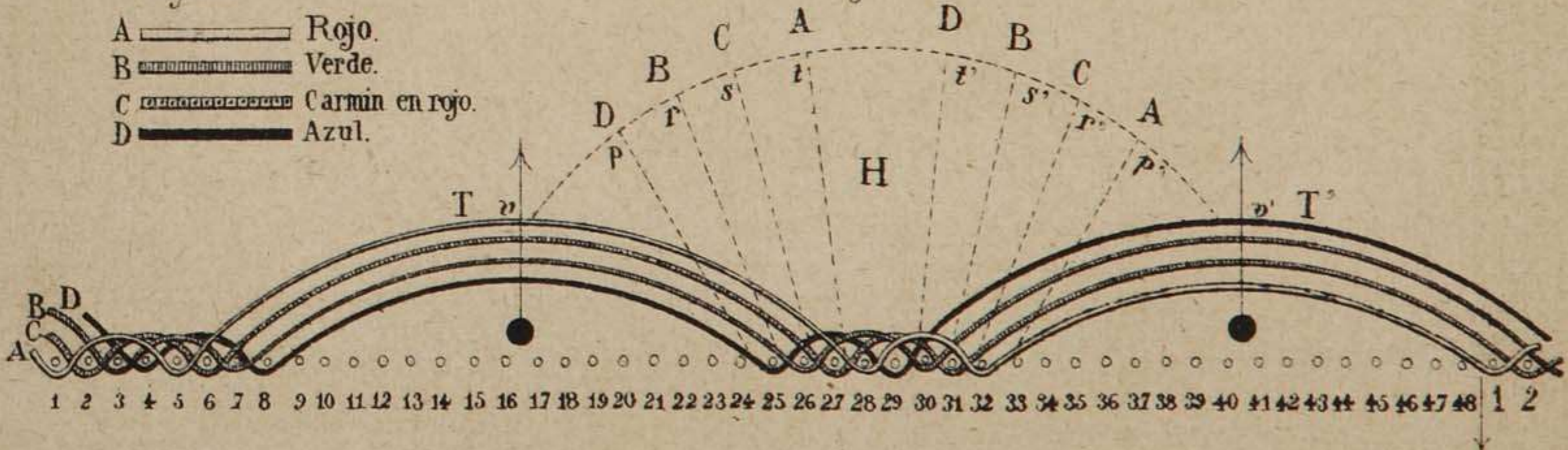


Fig. 428.

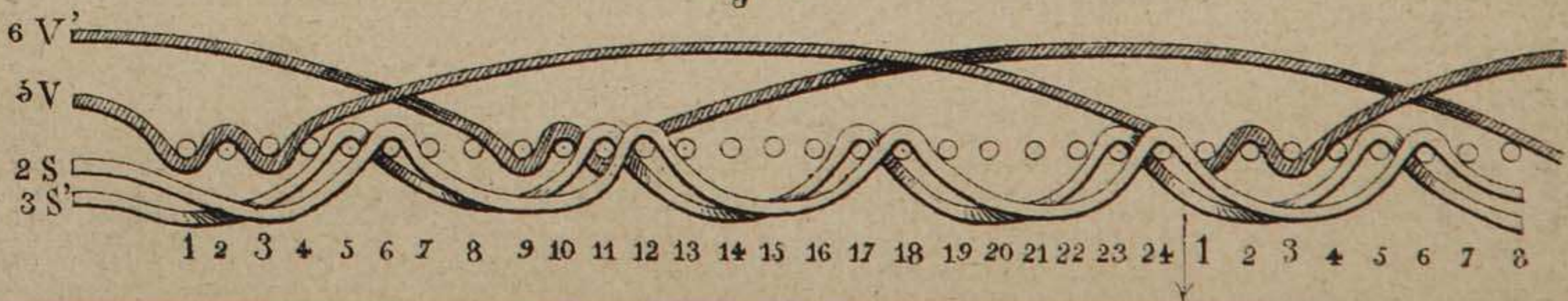


Fig. 434.

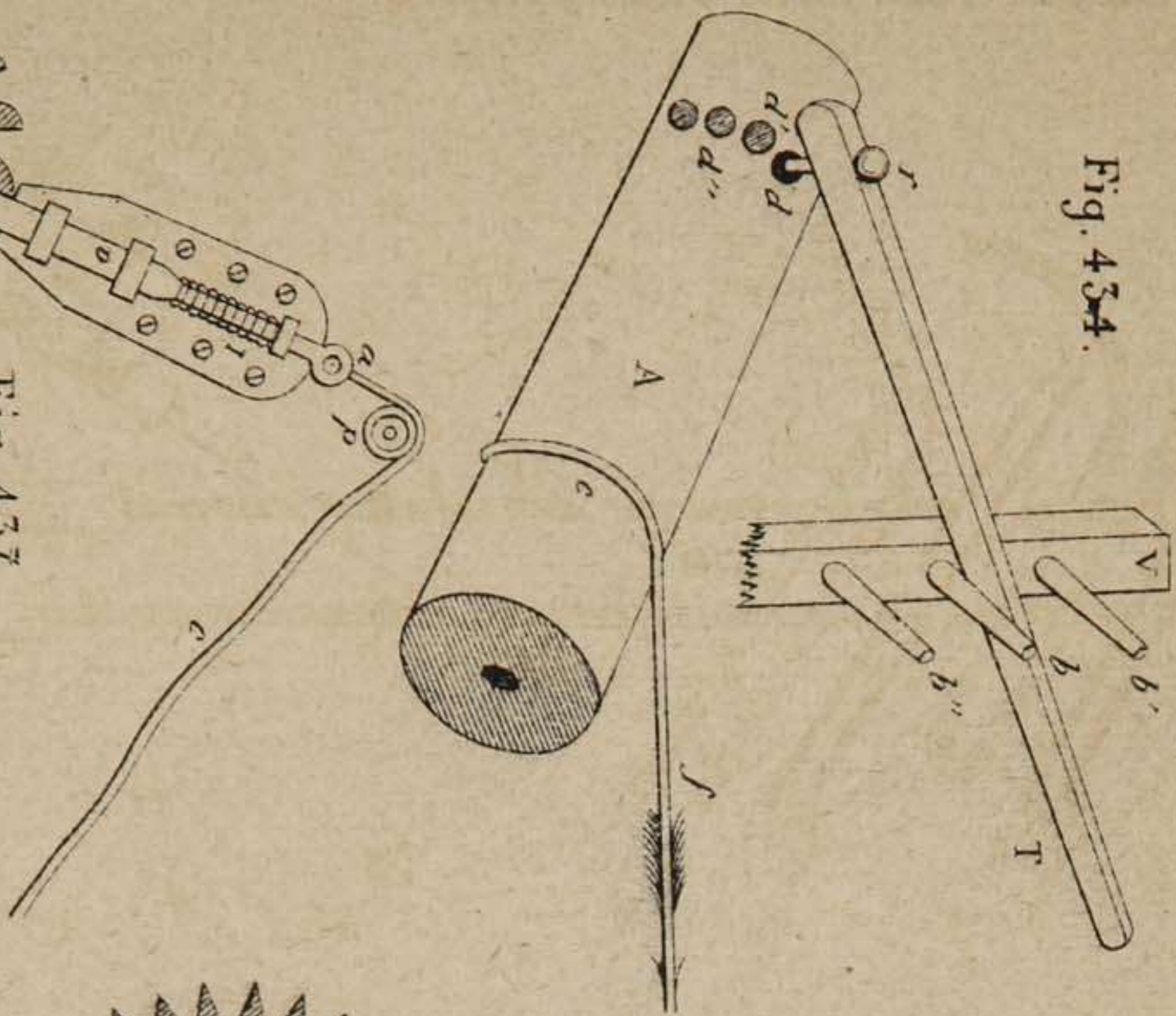


Fig. 437.

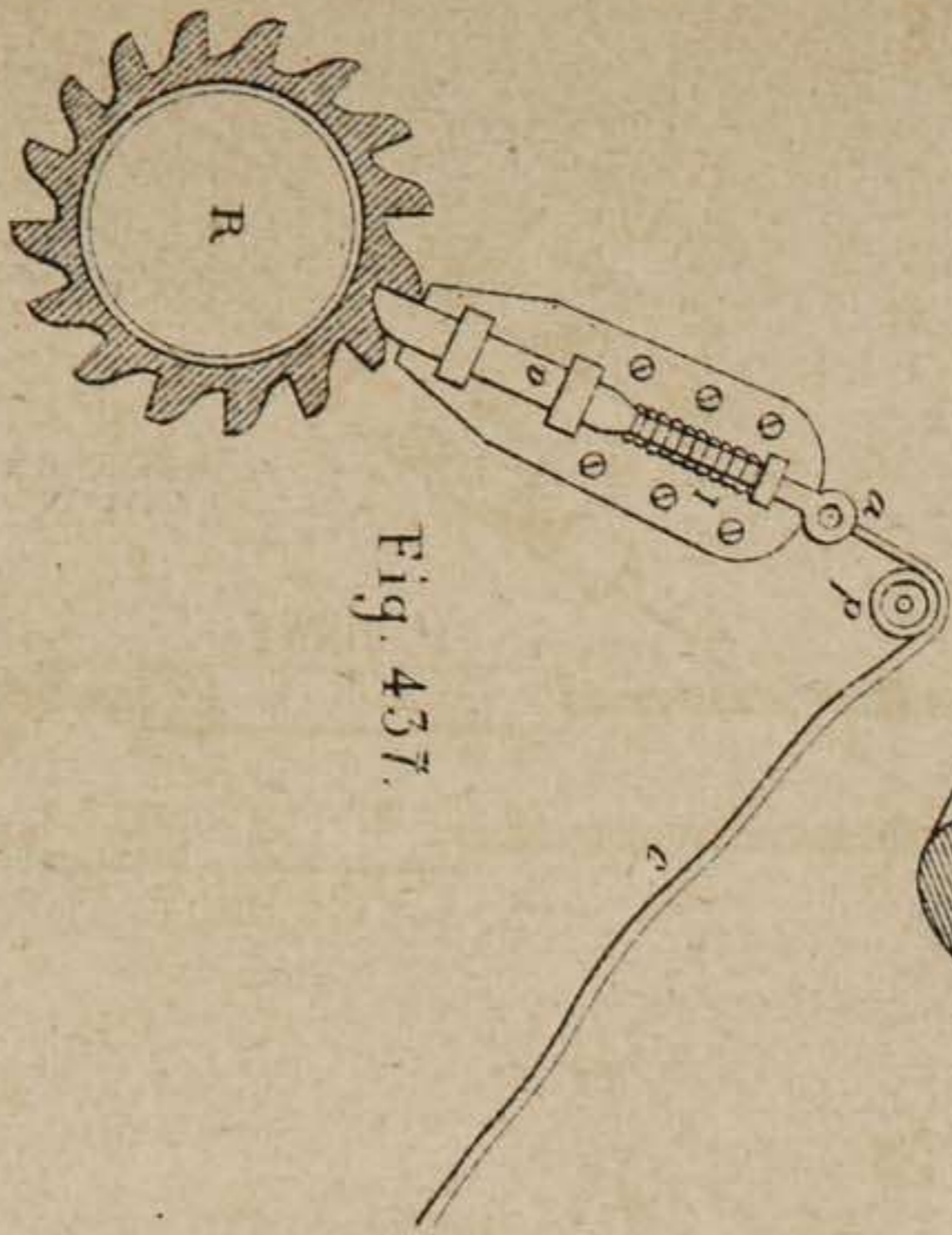


Fig. 436.

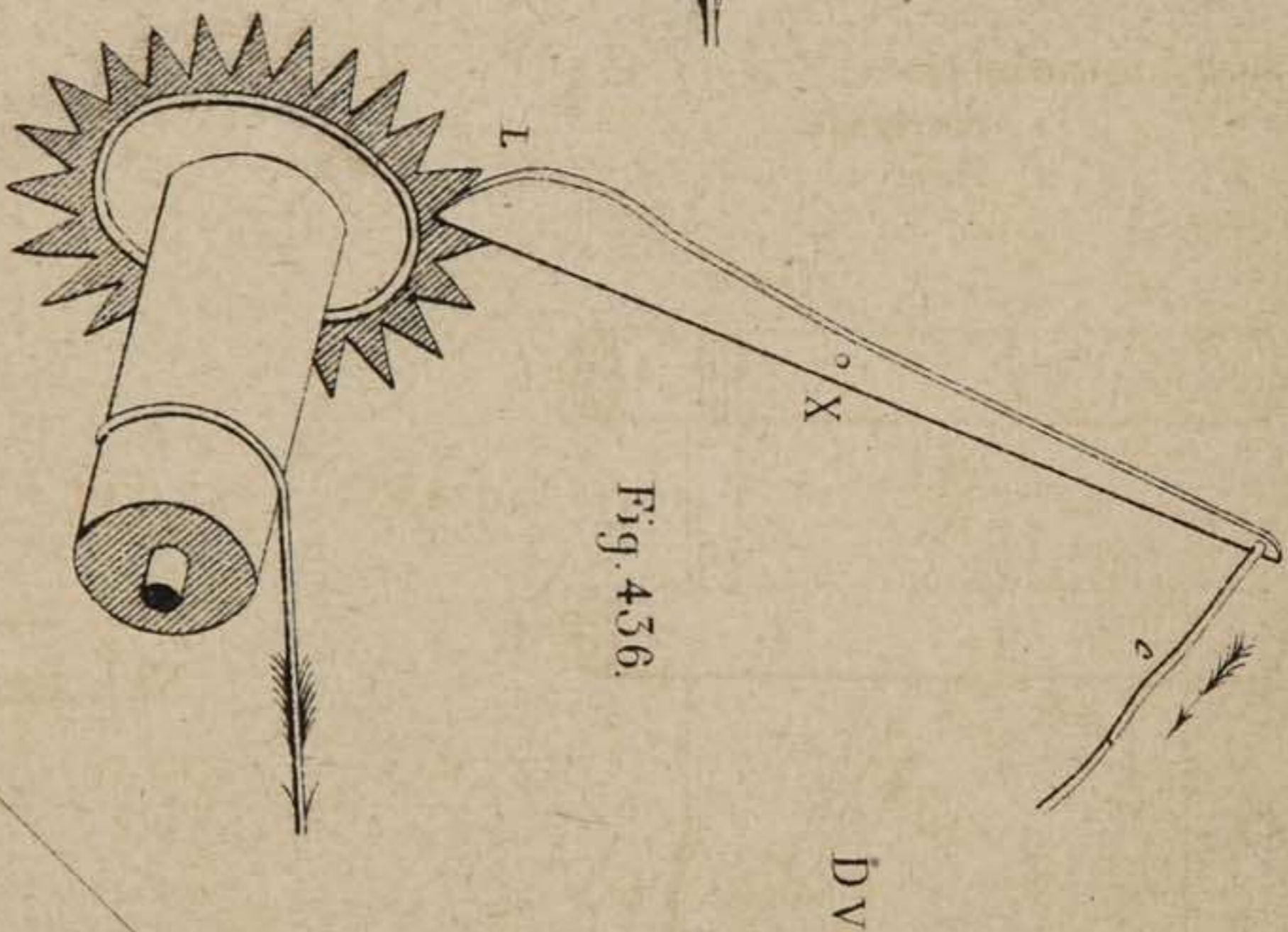


Fig. 435.

1	2	3	4	5	6	7	8	9	10	11	12	13	14	15	16	17	18	19	20	21	22	23	24	25	26	27	28	29	30	31	32	33	34	35	36	37	38	39	40	41	42	43	44	45	46	47	48	49	50
1	2	3	4	5	6	7	8	9	10	11	12	13	14	15	16	17	18	19	20	21	22	23	24	25	26	27	28	29	30	31	32	33	34	35	36	37	38	39	40	41	42	43	44	45	46	47	48	49	50

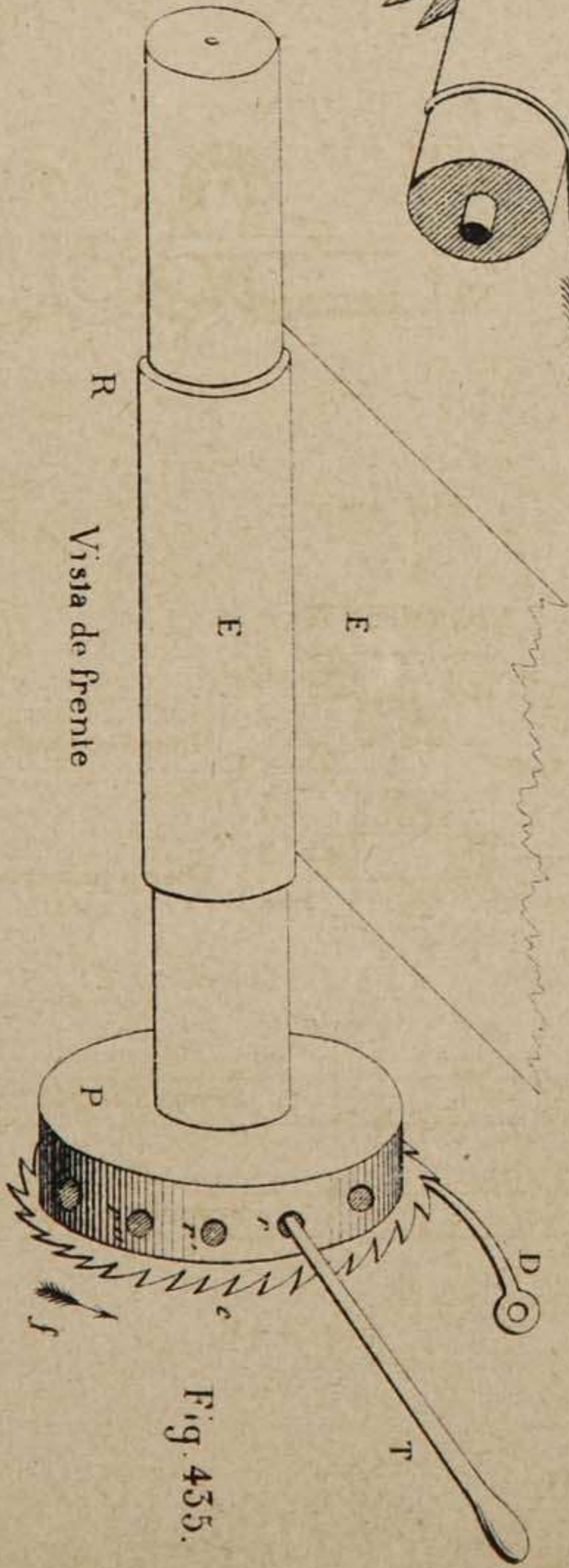


Fig. 435.

Fig. 432. Legenda ----- Rojo.

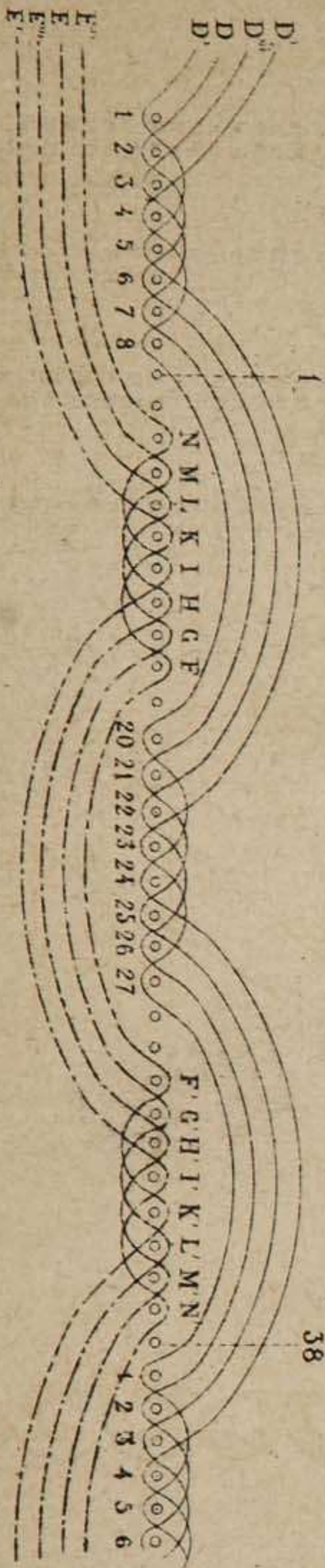
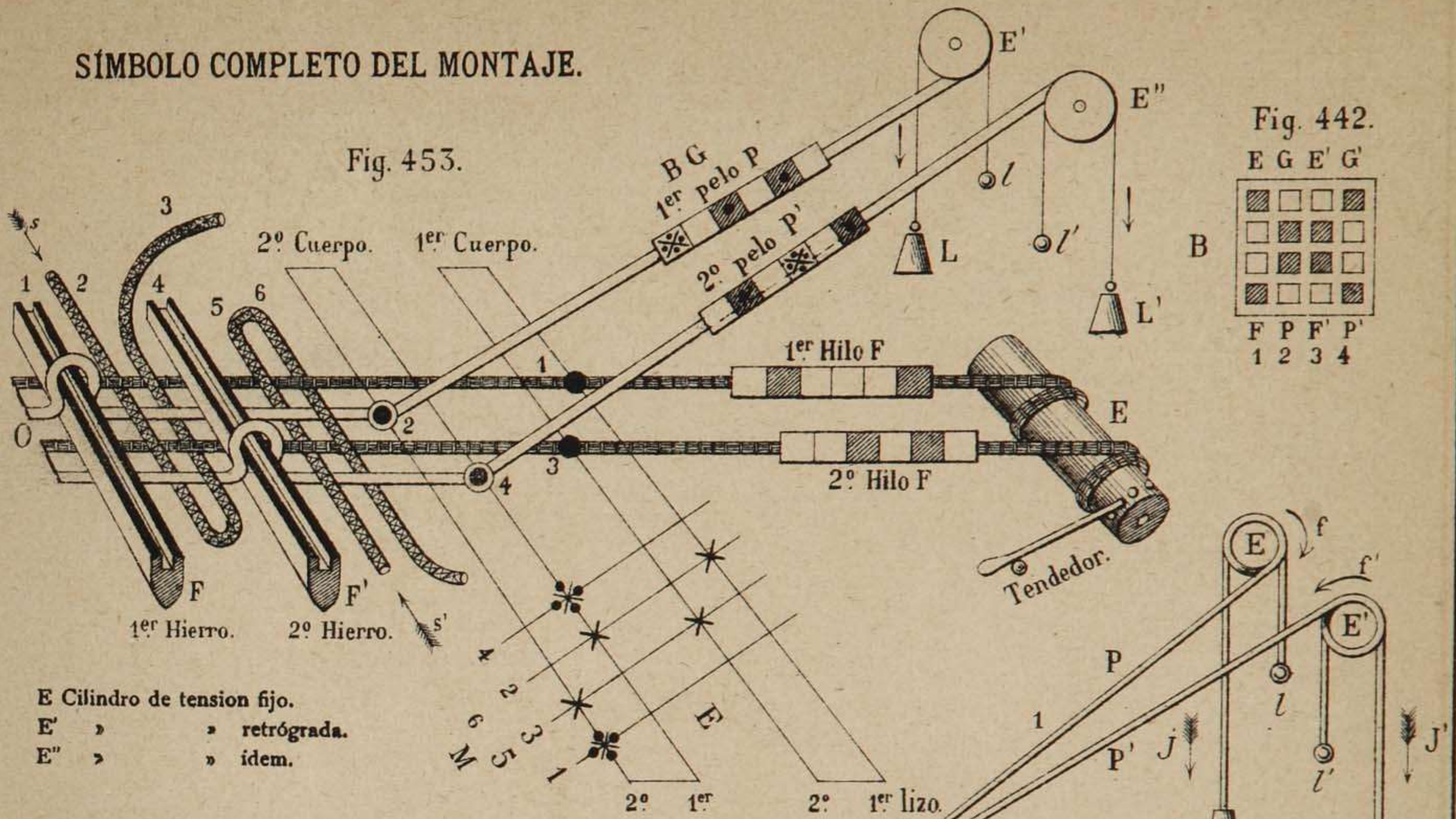


Fig. 431.

1	2	3	4	5	6	7	8	9	10	11	12	13	14	15	16	17	18	19	20	21	22	23	24	25	26	27	28	29	30	31	32	33	34	35	36	37	38	39	40	41	42	43	44	45	46	47	48	49	50
1	2	3	4	5	6	7	8	9	10	11	12	13	14	15	16	17	18	19	20	21	22	23	24	25	26	27	28	29	30	31	32	33	34	35	36	37	38	39	40	41	42	43	44	45	46	47	48	49	50

SÍMBOLO COMPLETO DEL MONTAJE.



E Cilindro de tension fijo.
 E' » » retrógrada.
 E'' » » idem.

Fig. 440.

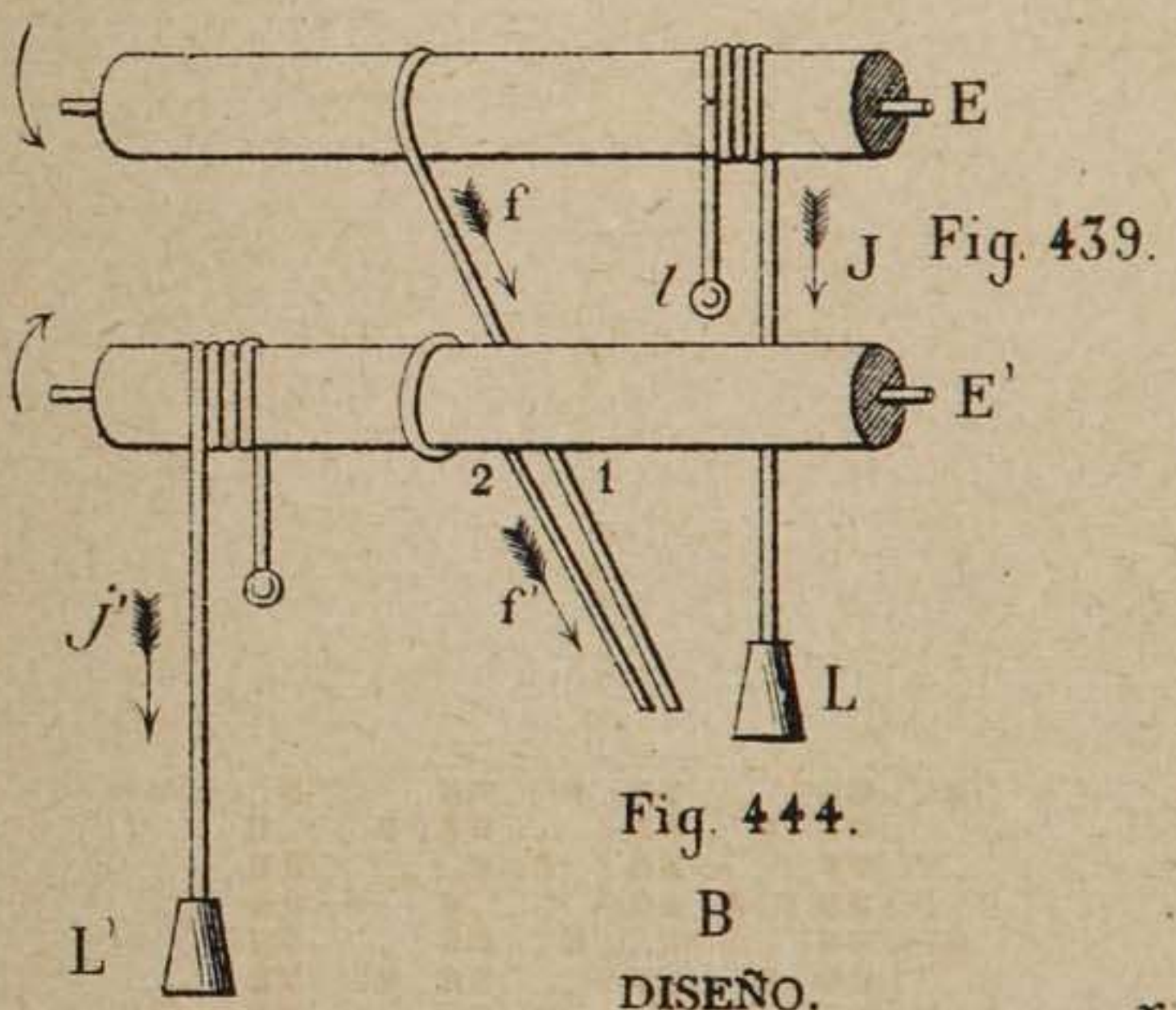


Fig. 438.

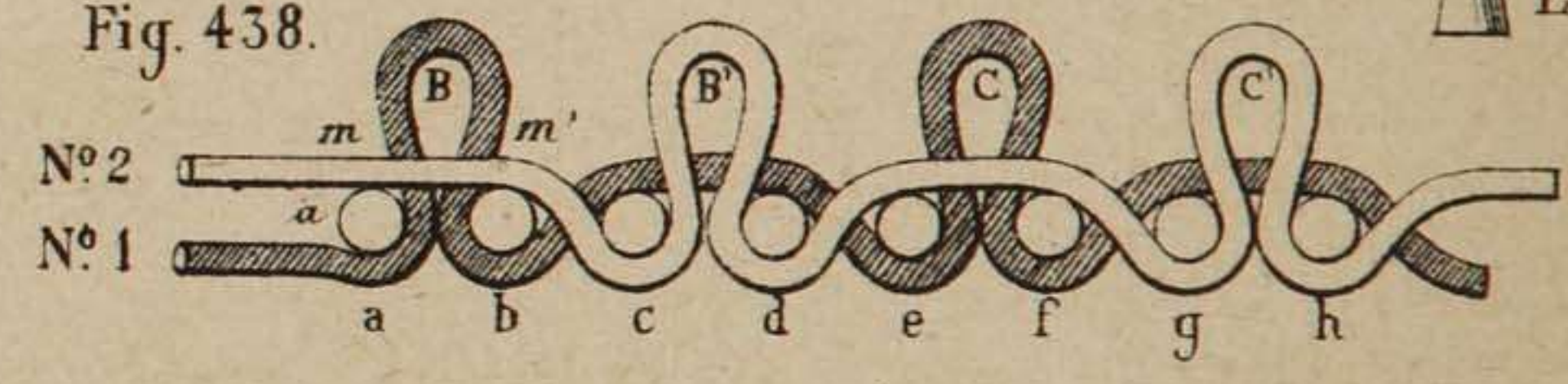


Fig. 445.

SÍMBOLO COMPLETO.
 6 síntesis de los elementos
 del montaje.

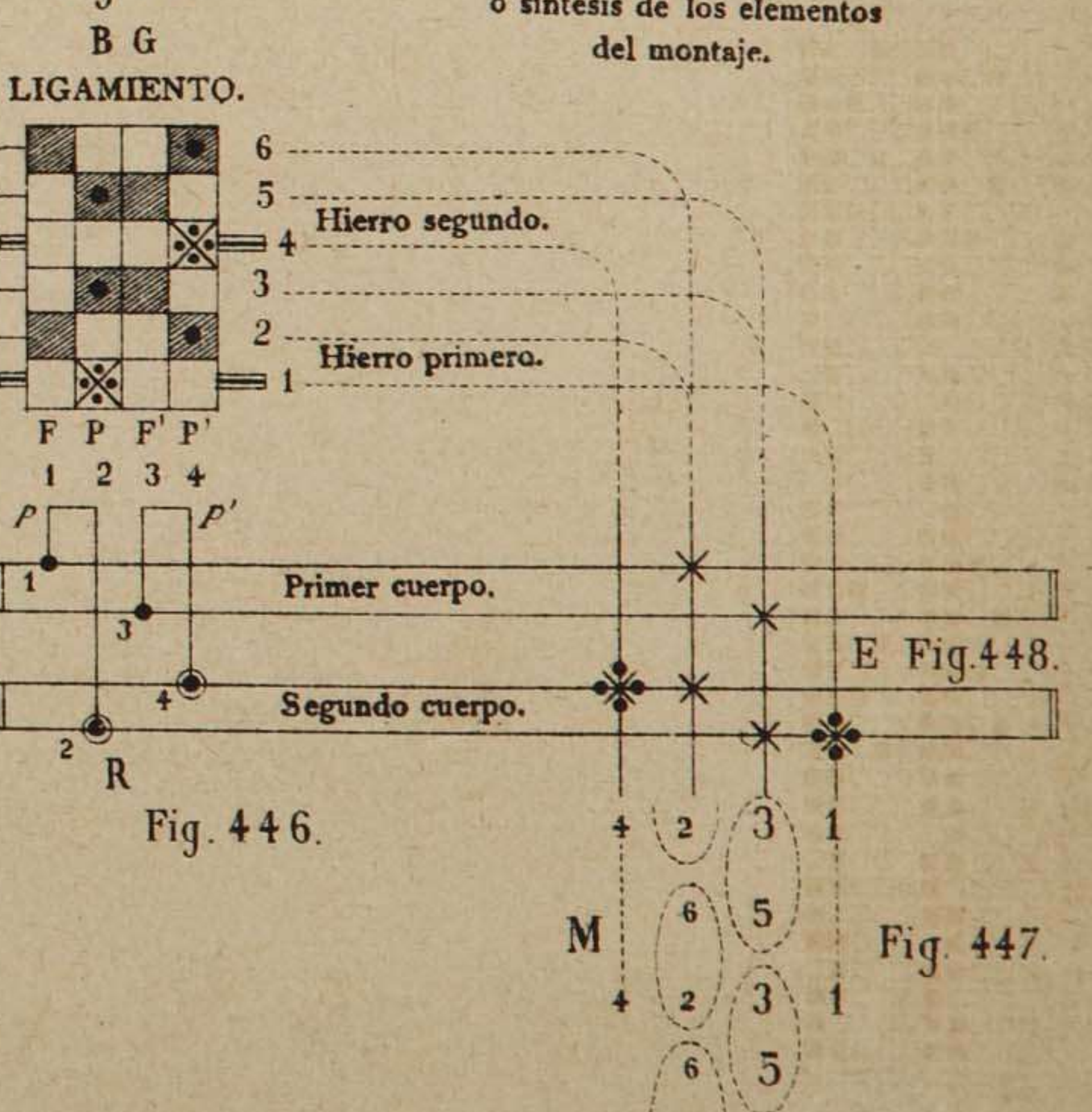
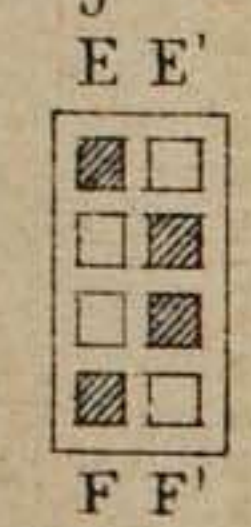


Fig. 443.



DISEÑO.

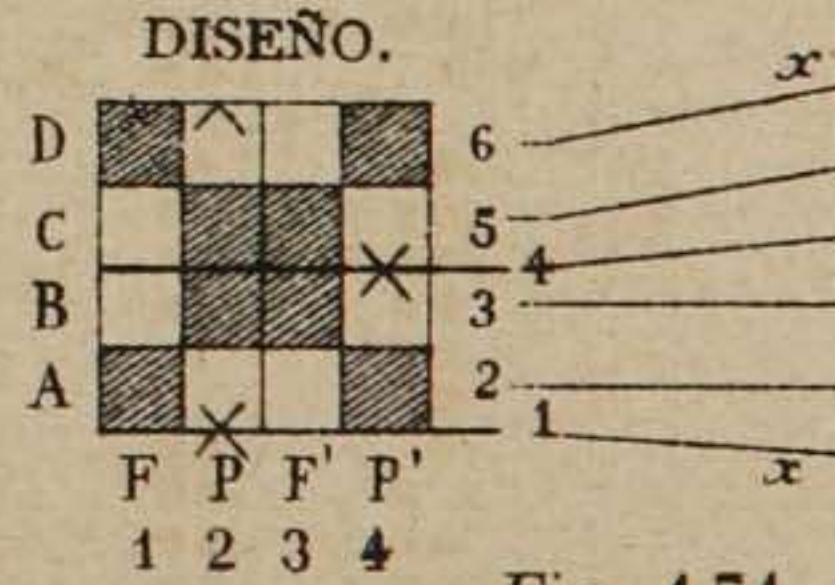


Fig. 441.

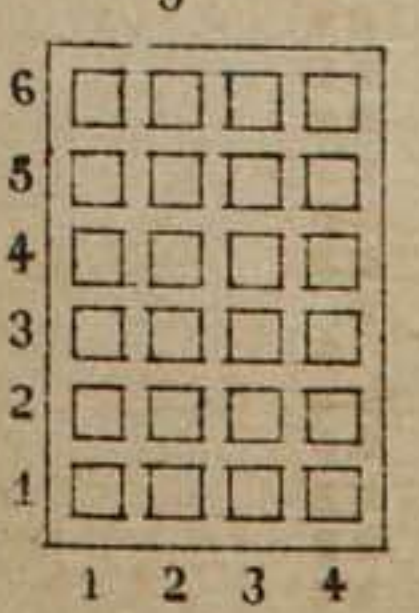


Fig. 449.

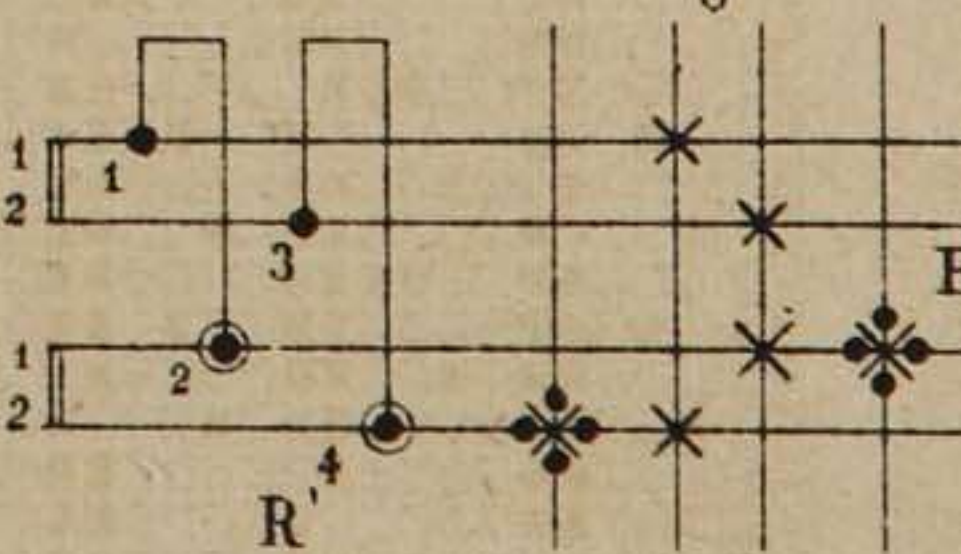
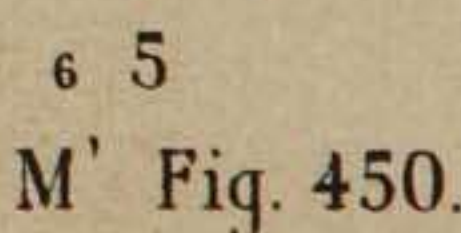


Fig. 450.



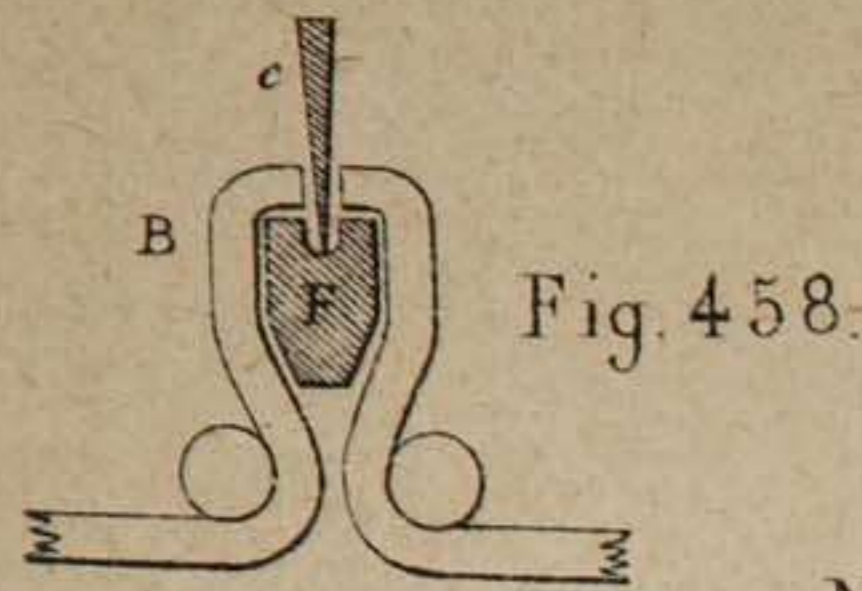


Fig. 458.

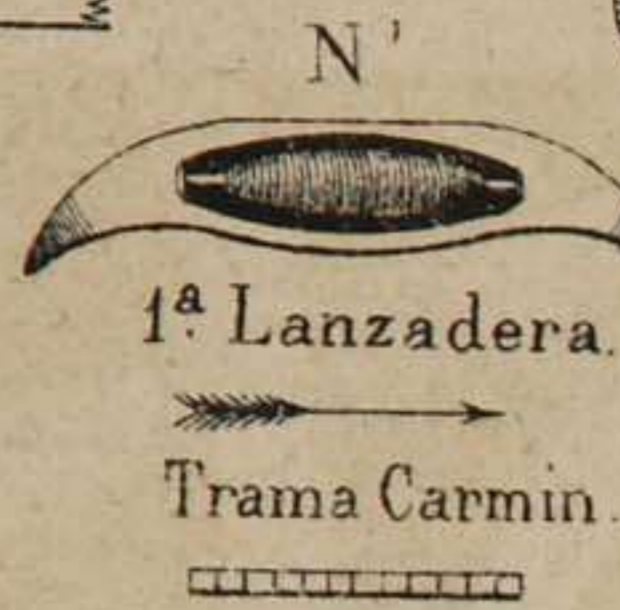


Fig. 452.

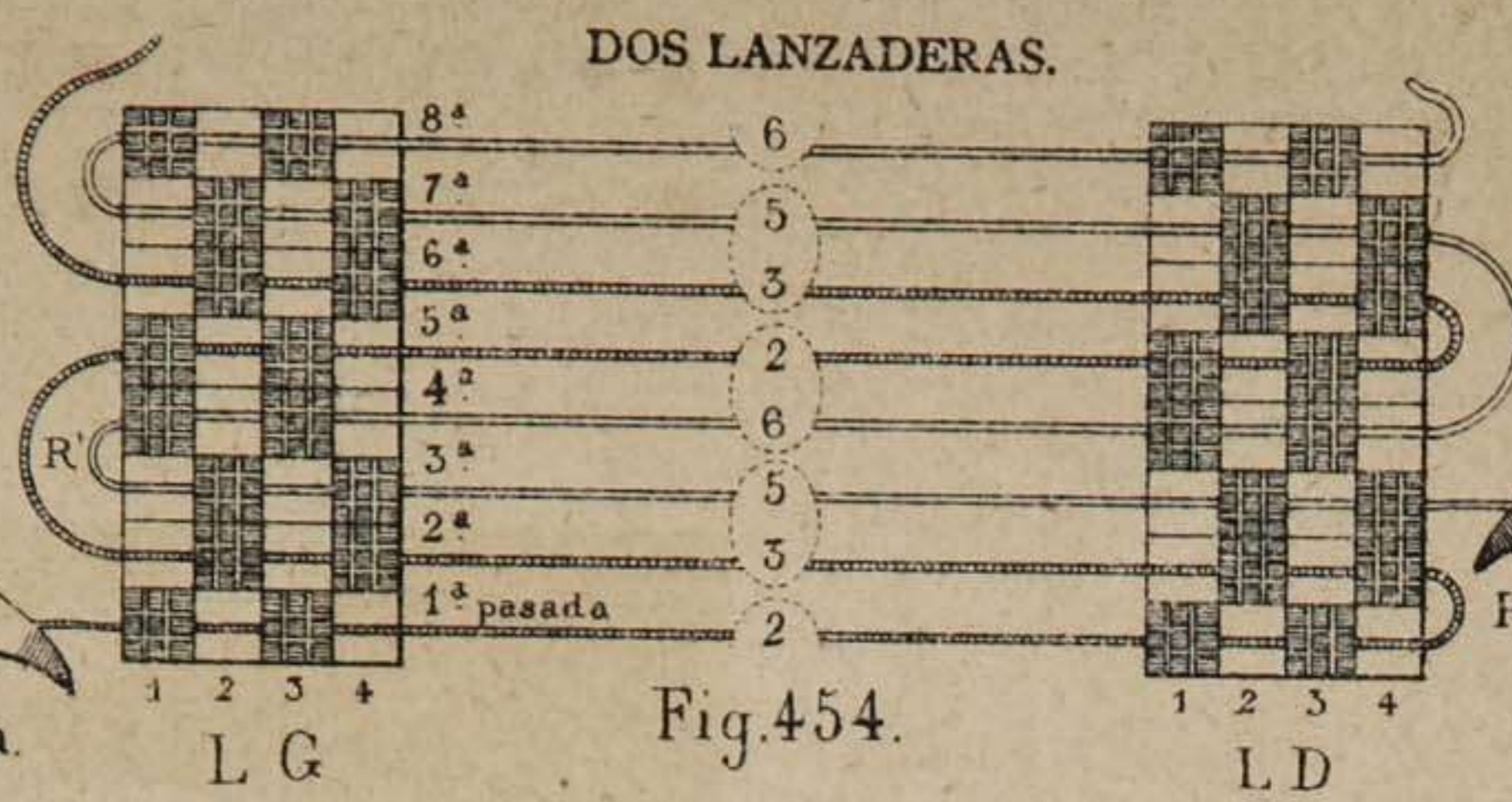
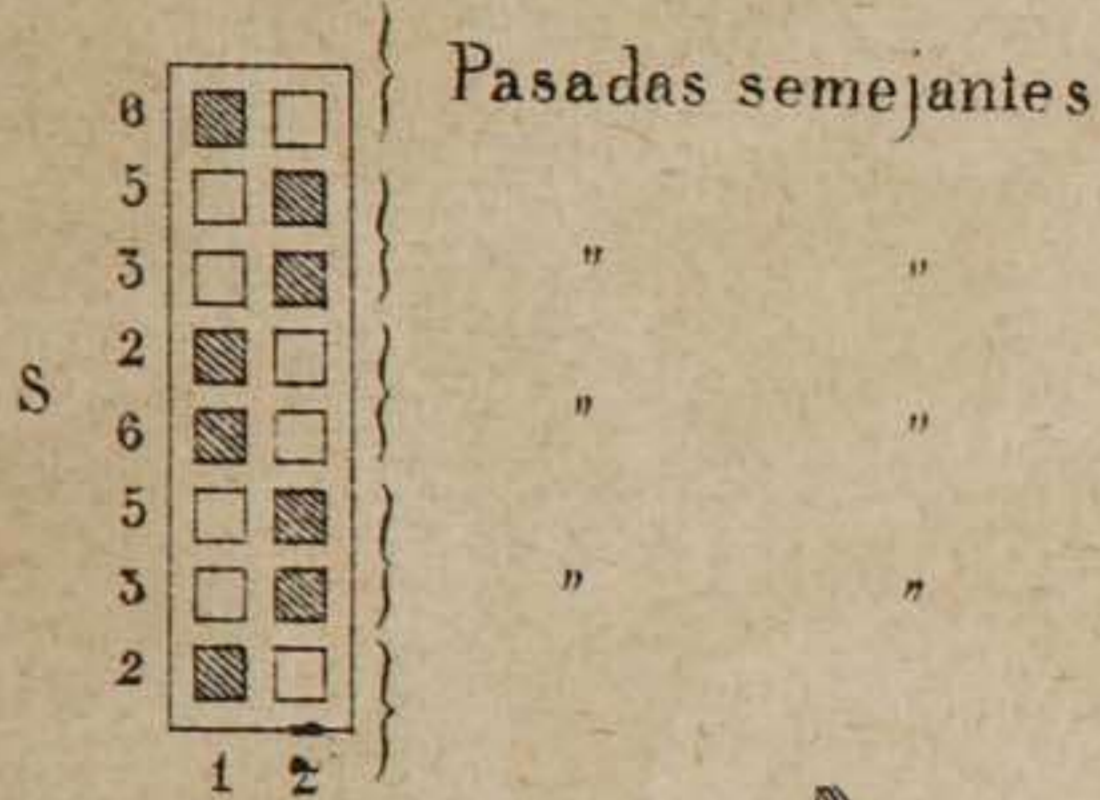


Fig. 454.

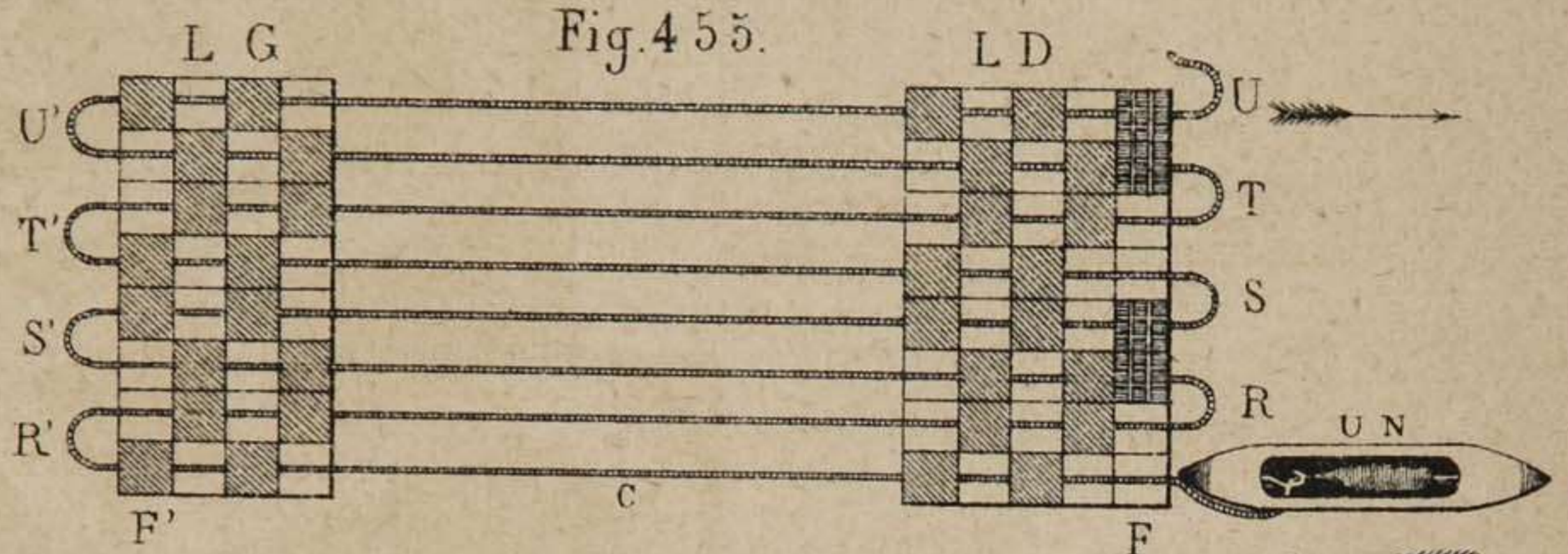
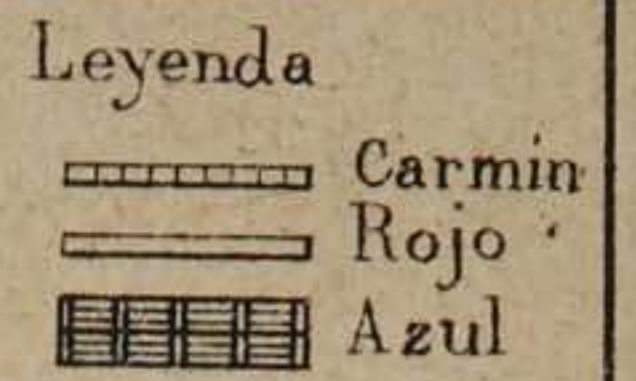


Fig. 455.

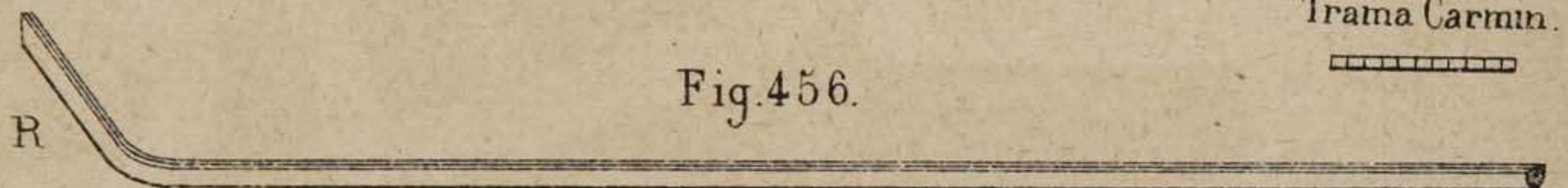


Fig. 456.

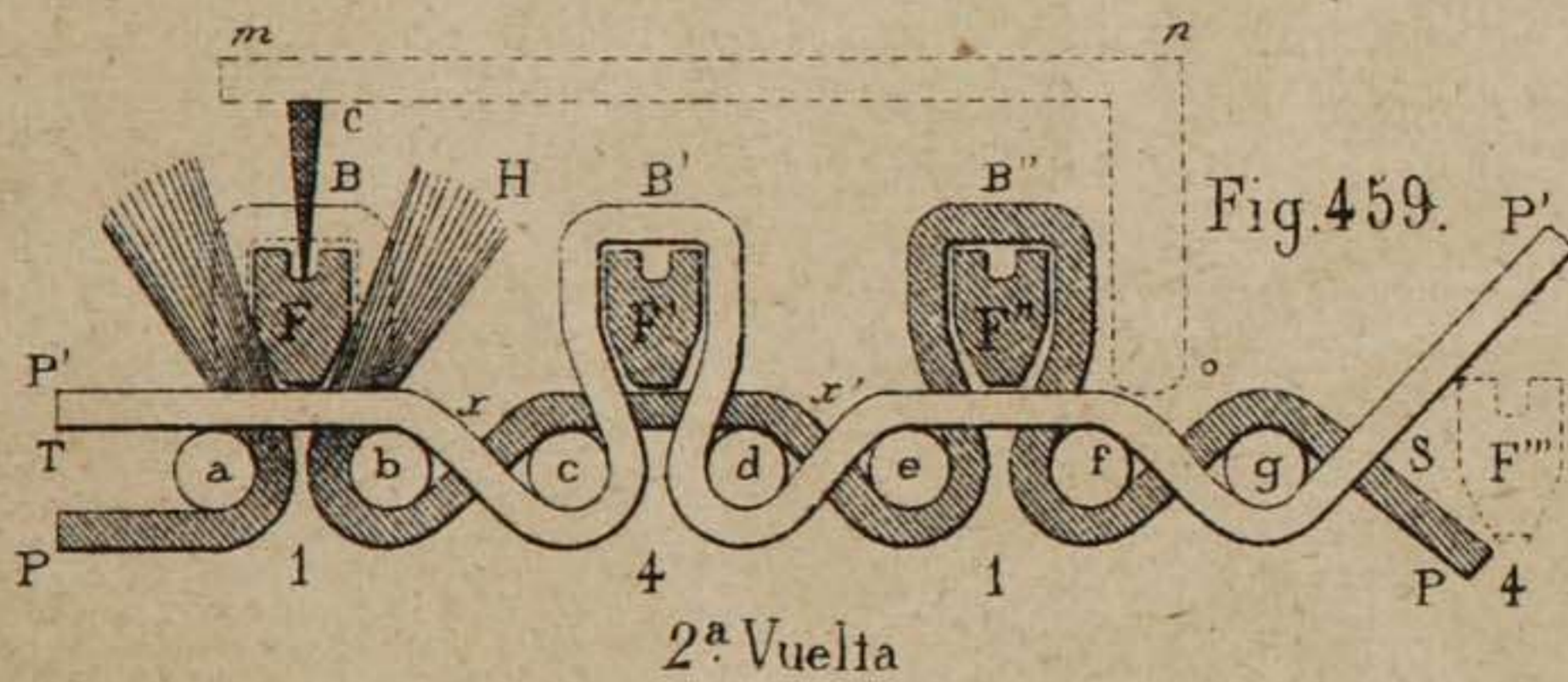


Fig. 459.

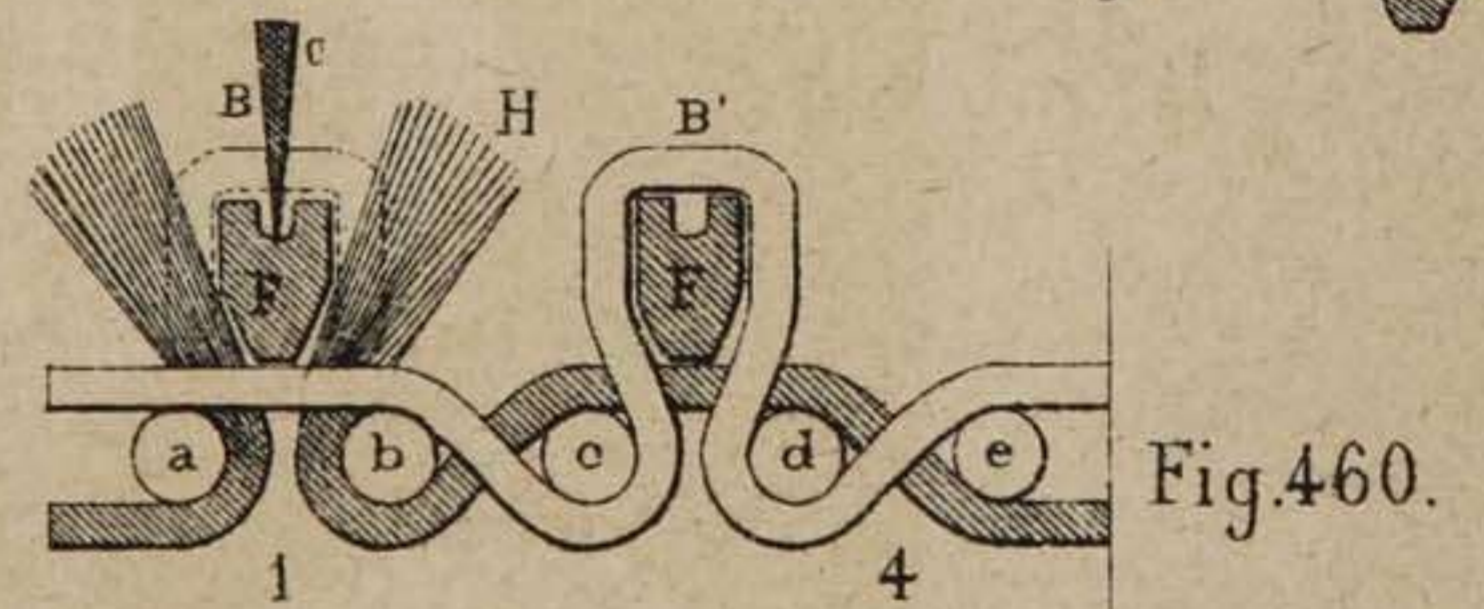


Fig. 460.

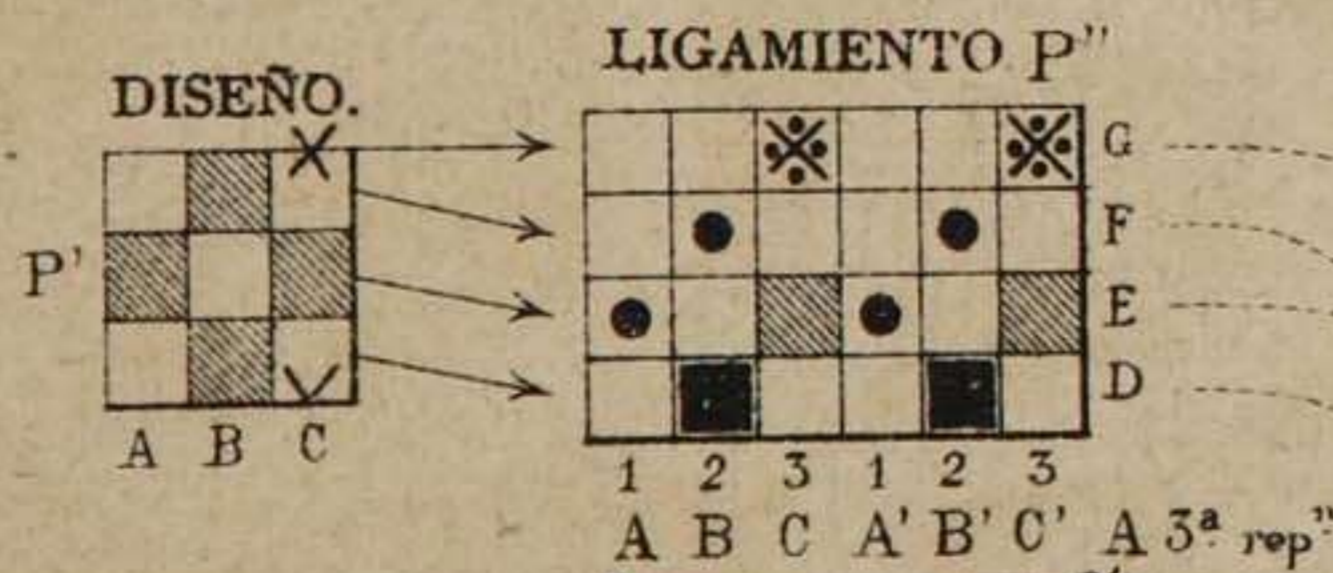


Fig. 468.

SÍMBOLO DE LOS ELEMENTOS.

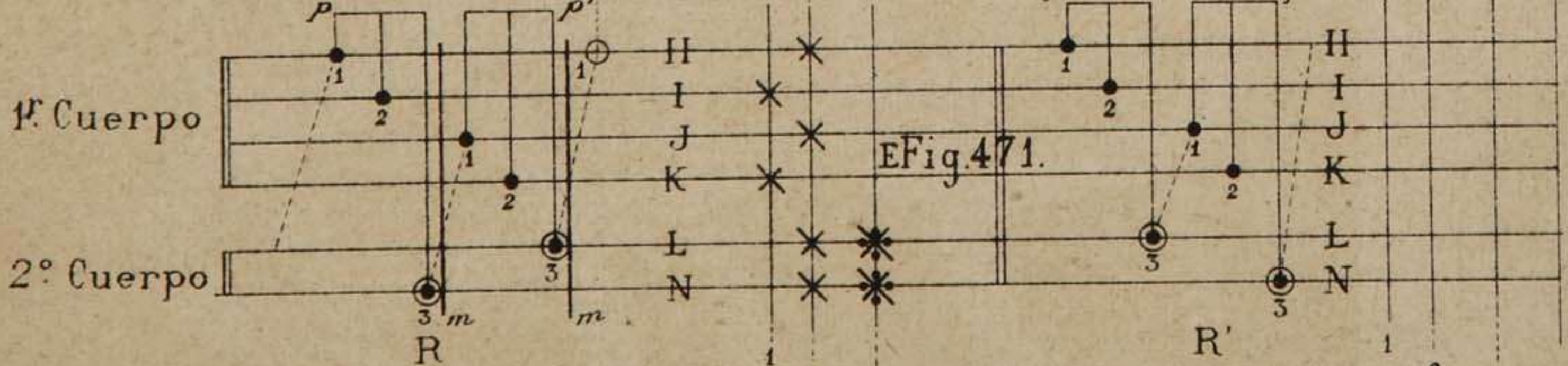


Fig. 469.

Fig. 470.

Fig. 477.

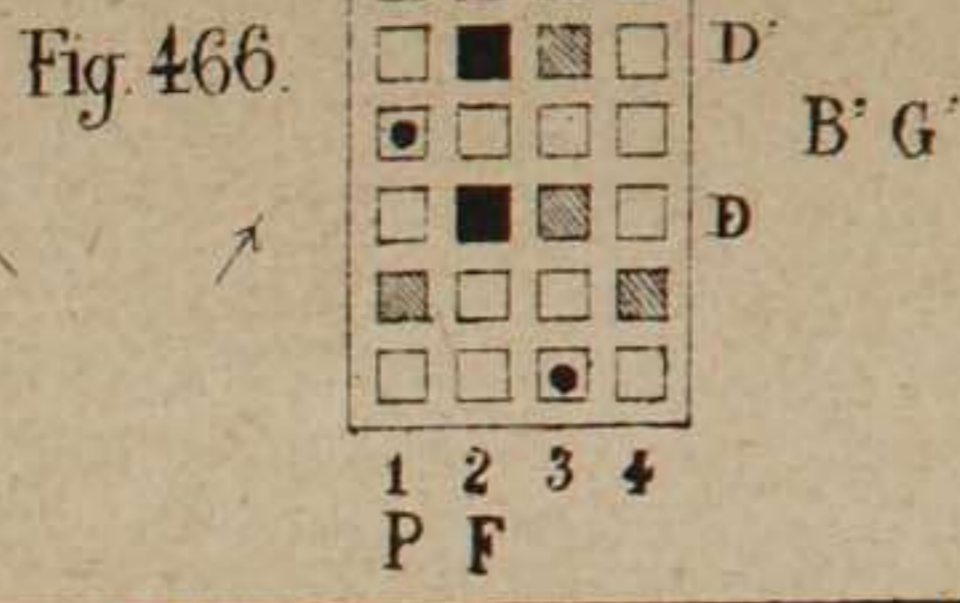
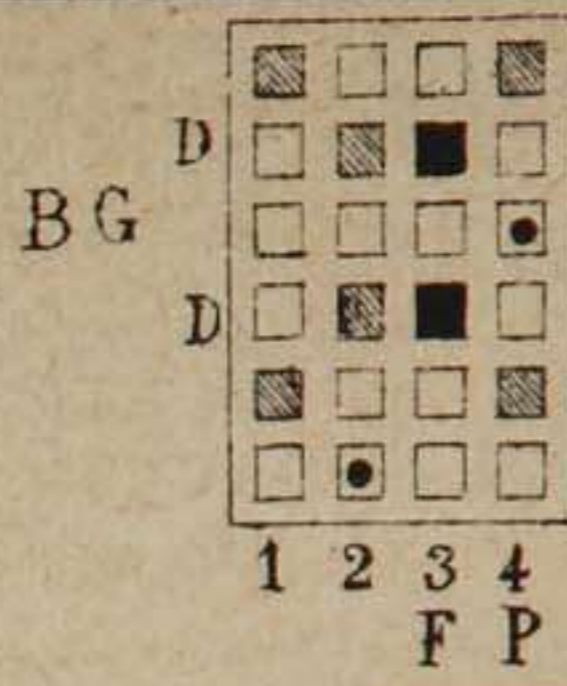
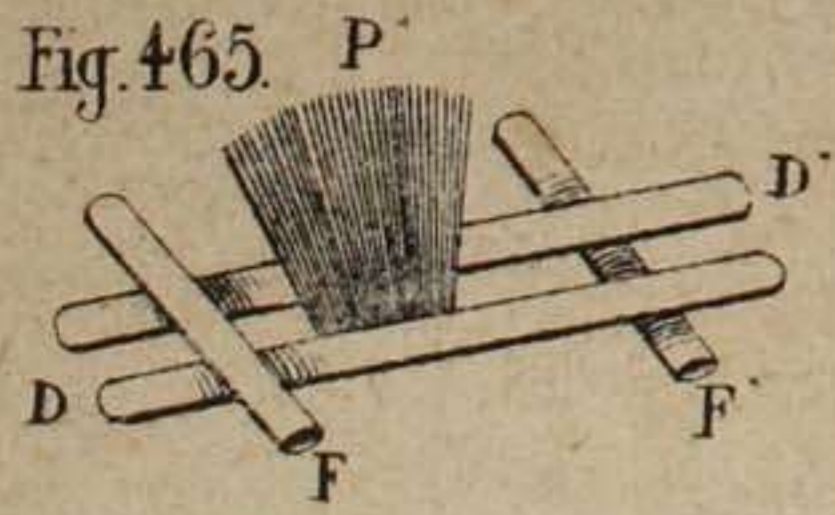
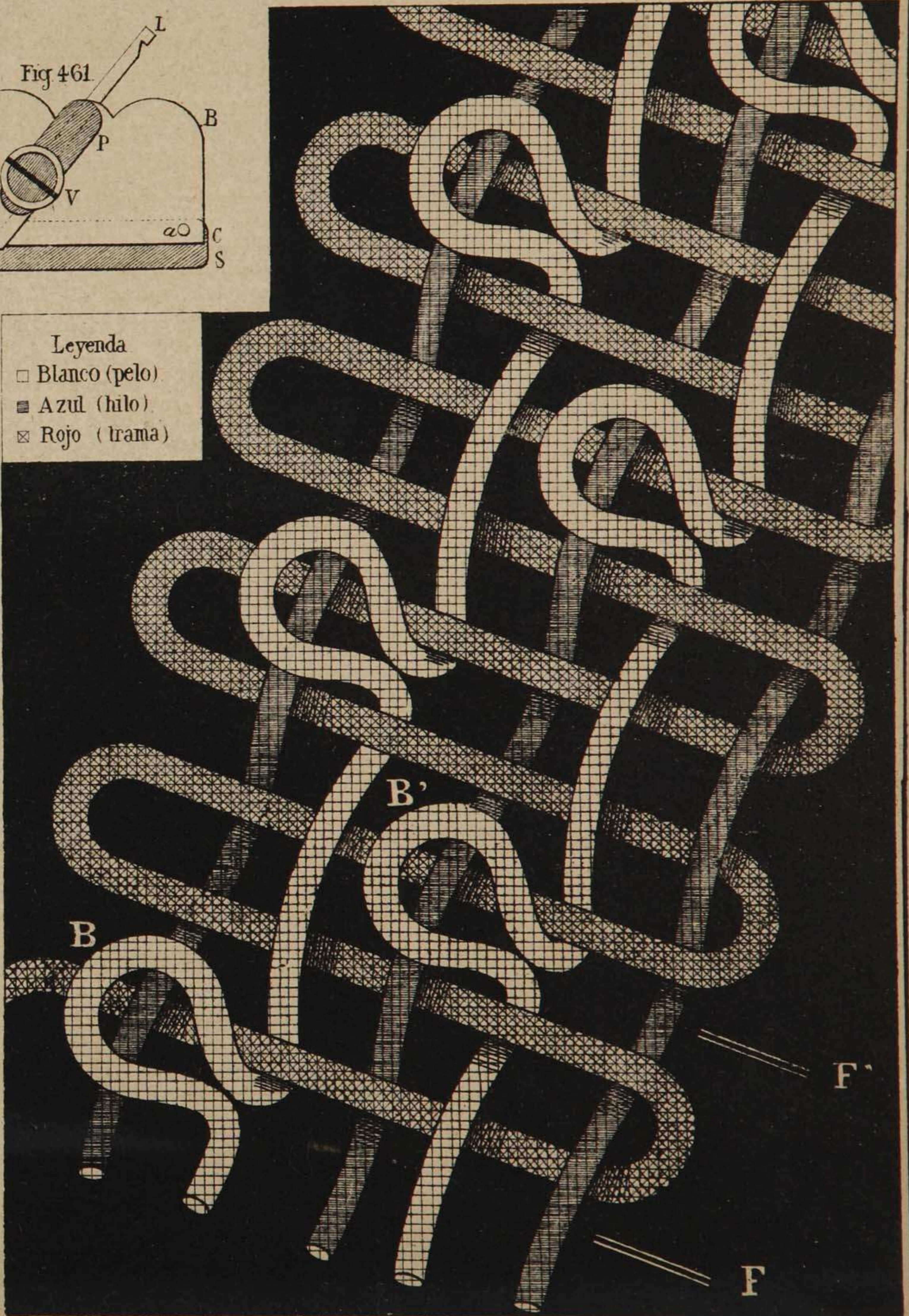
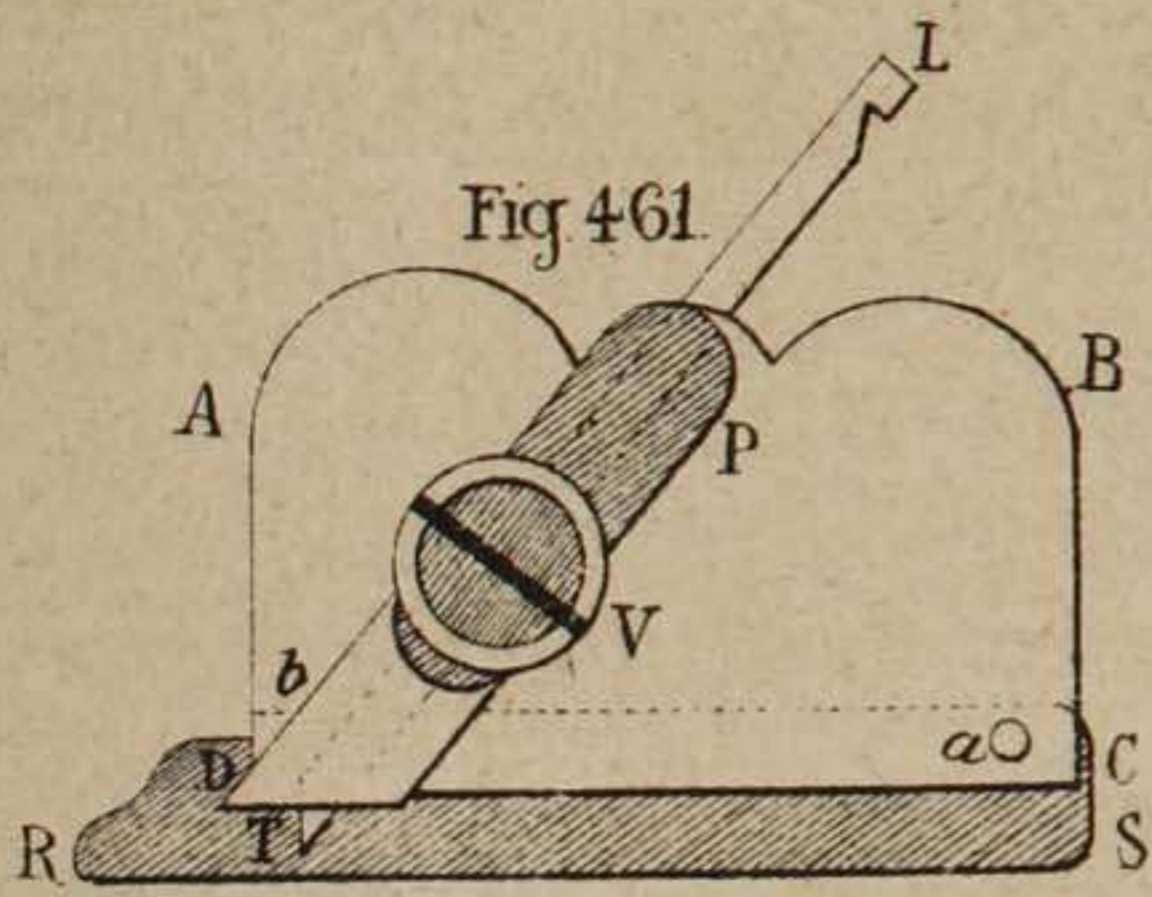
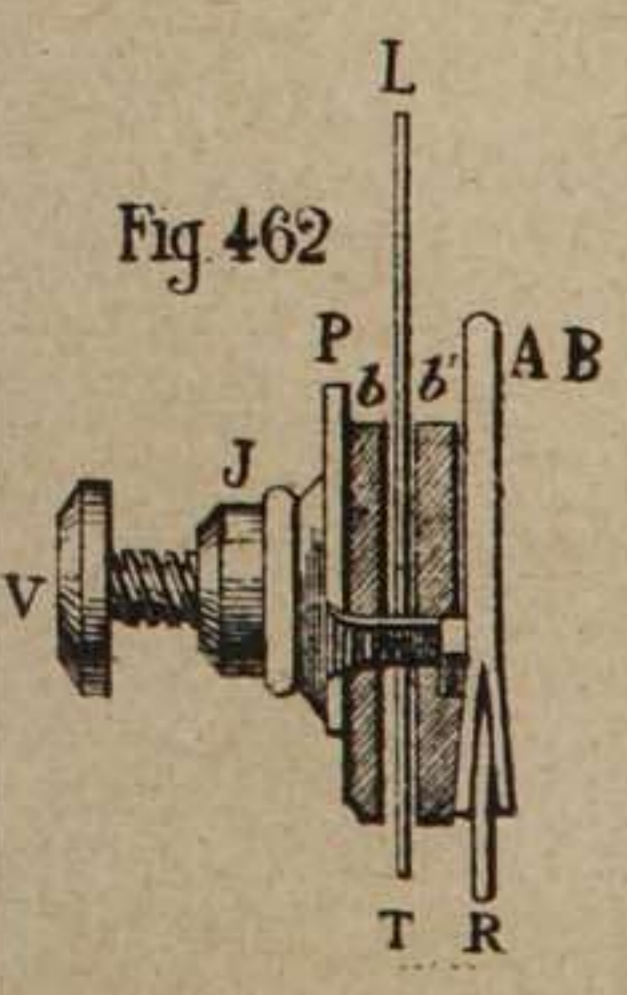
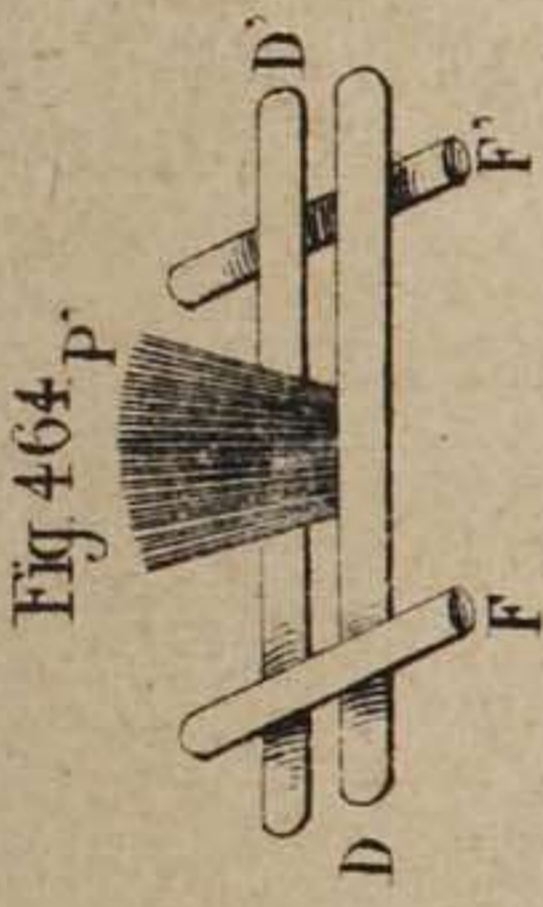


Fig. 463.



Leyenda
 □ Blanco (pelo)
 ■ Azul (hilo)
 ⊠ Rojo (trama)



SÍMBOLO COMPLETO DEL MONTAJE.

Fig. 467.

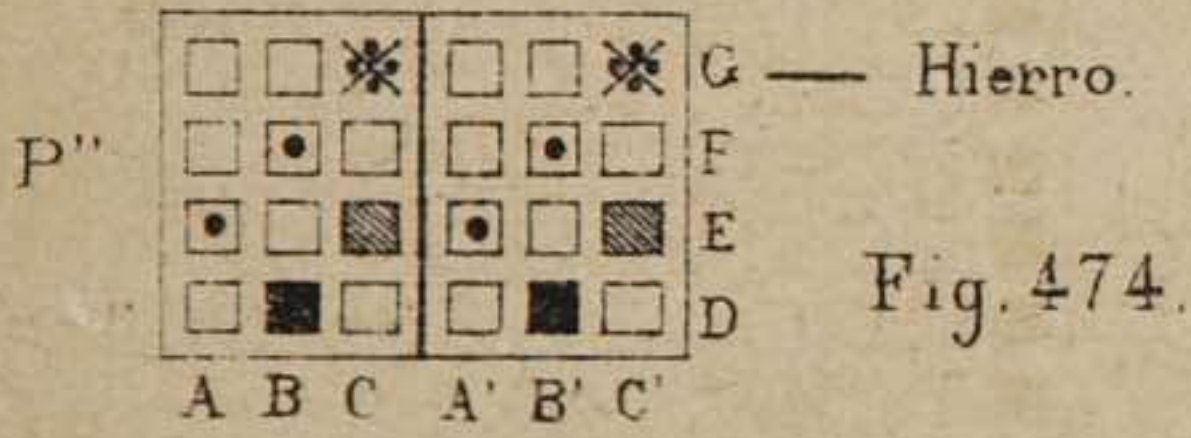
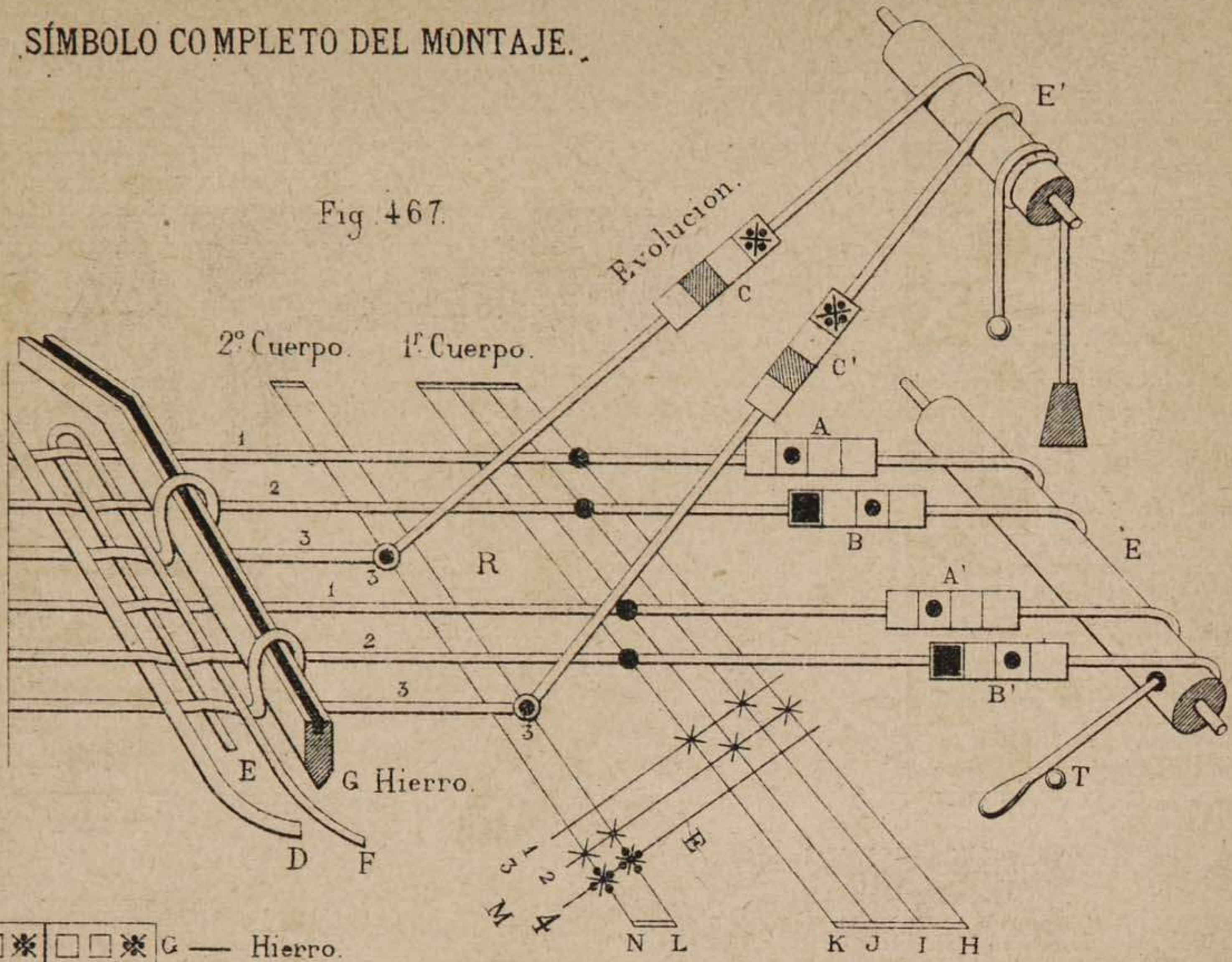


Fig. 479.

Fig. 475.

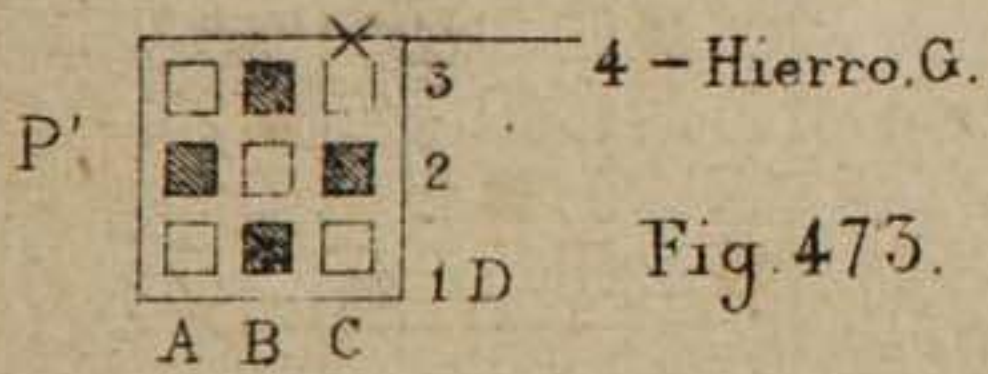
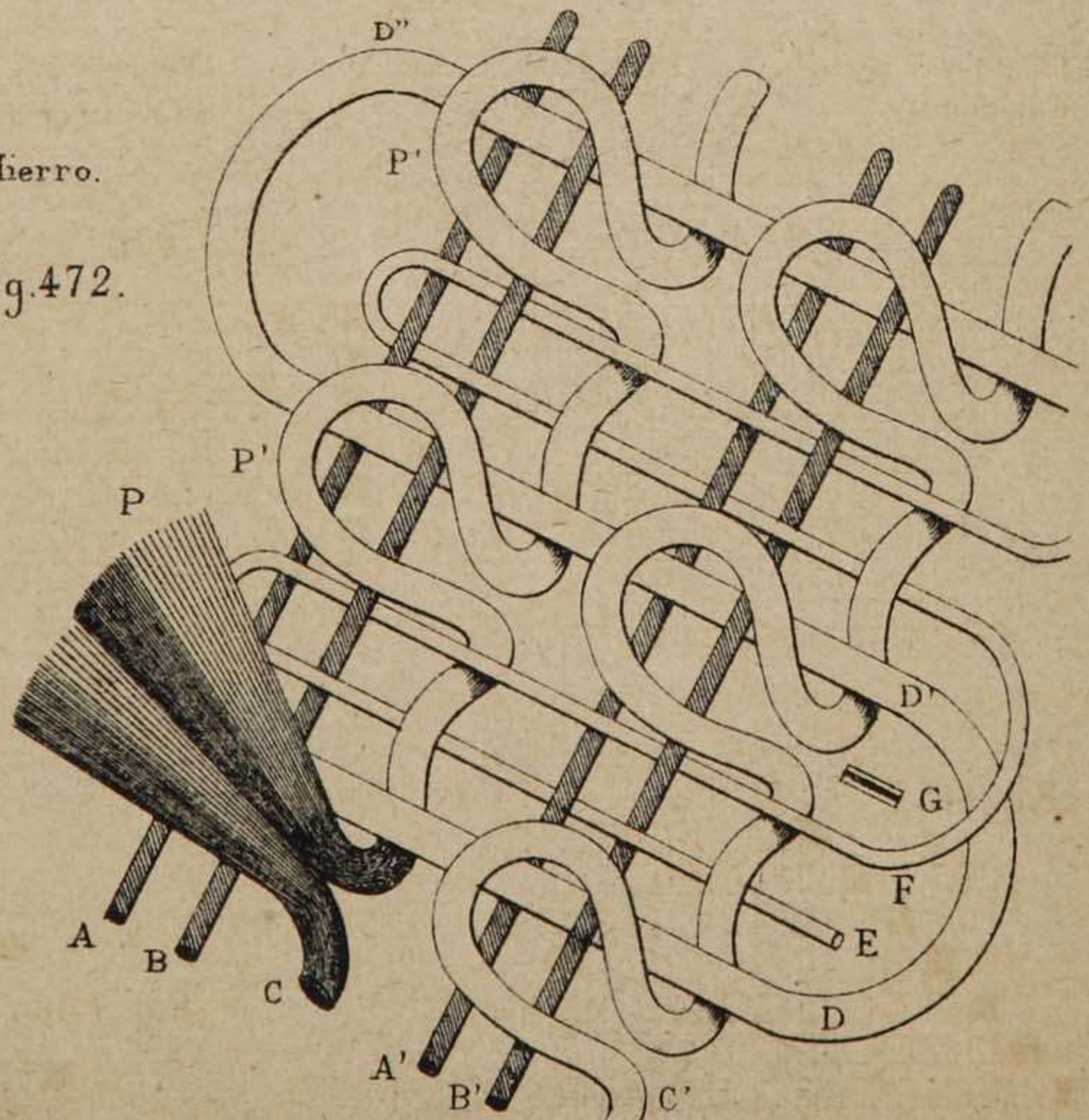
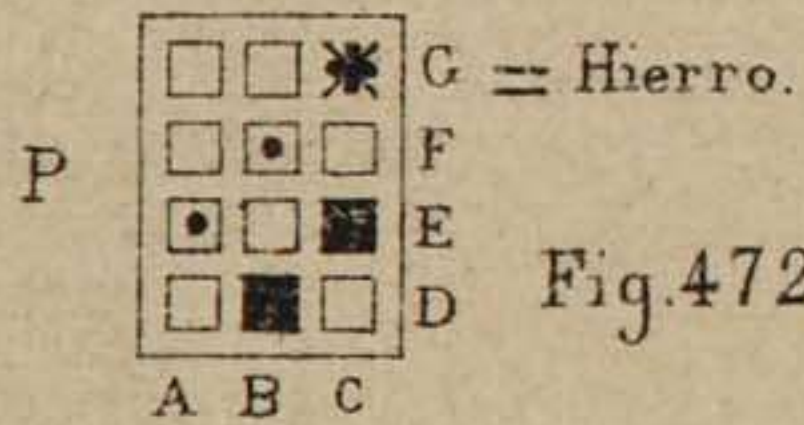
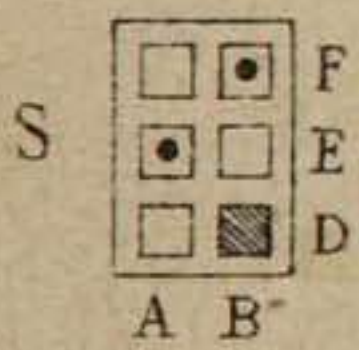
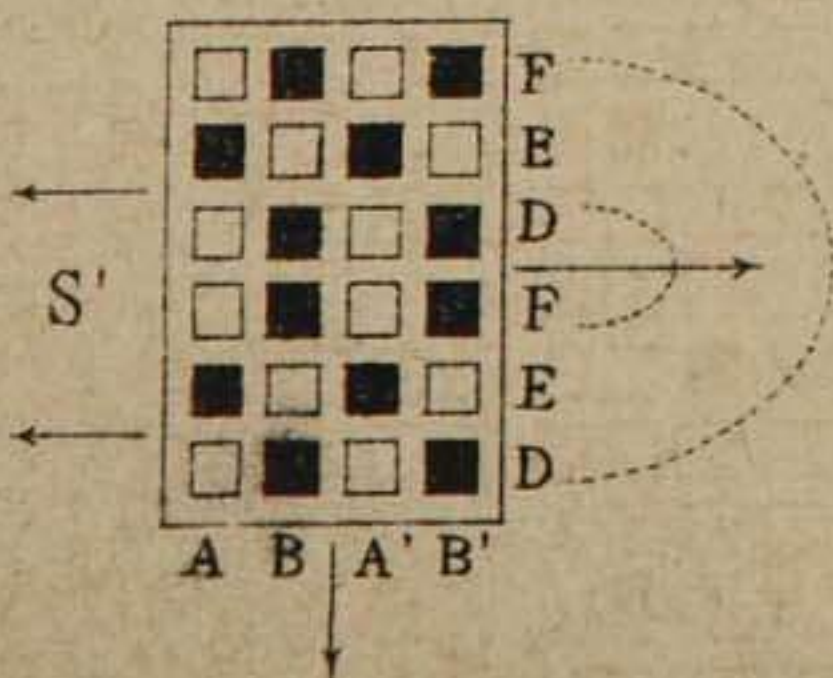


Fig. 476.



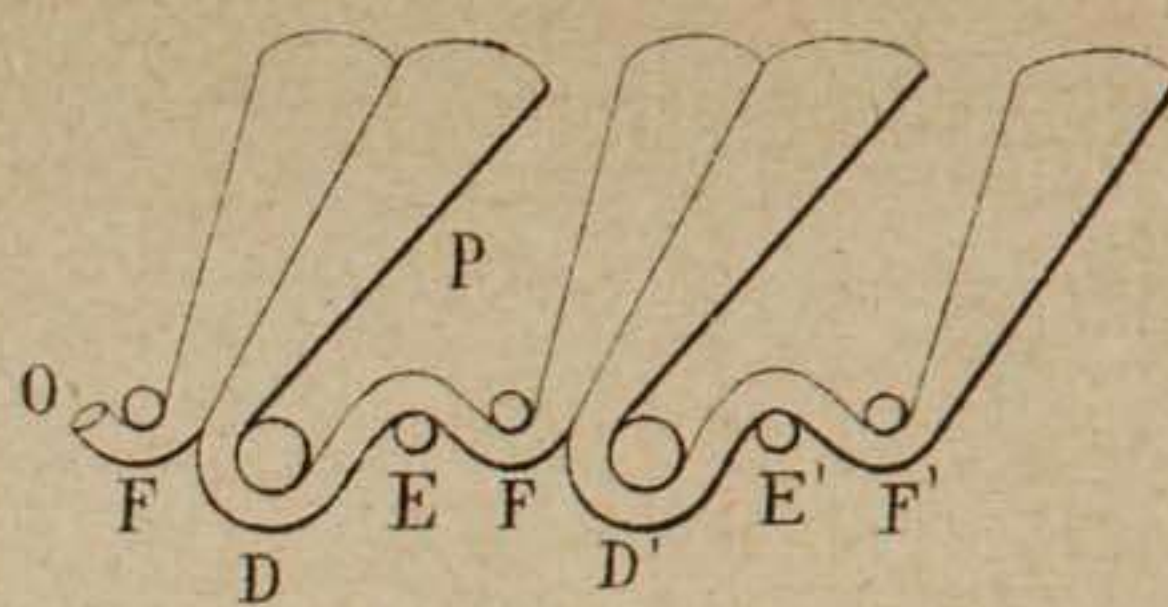
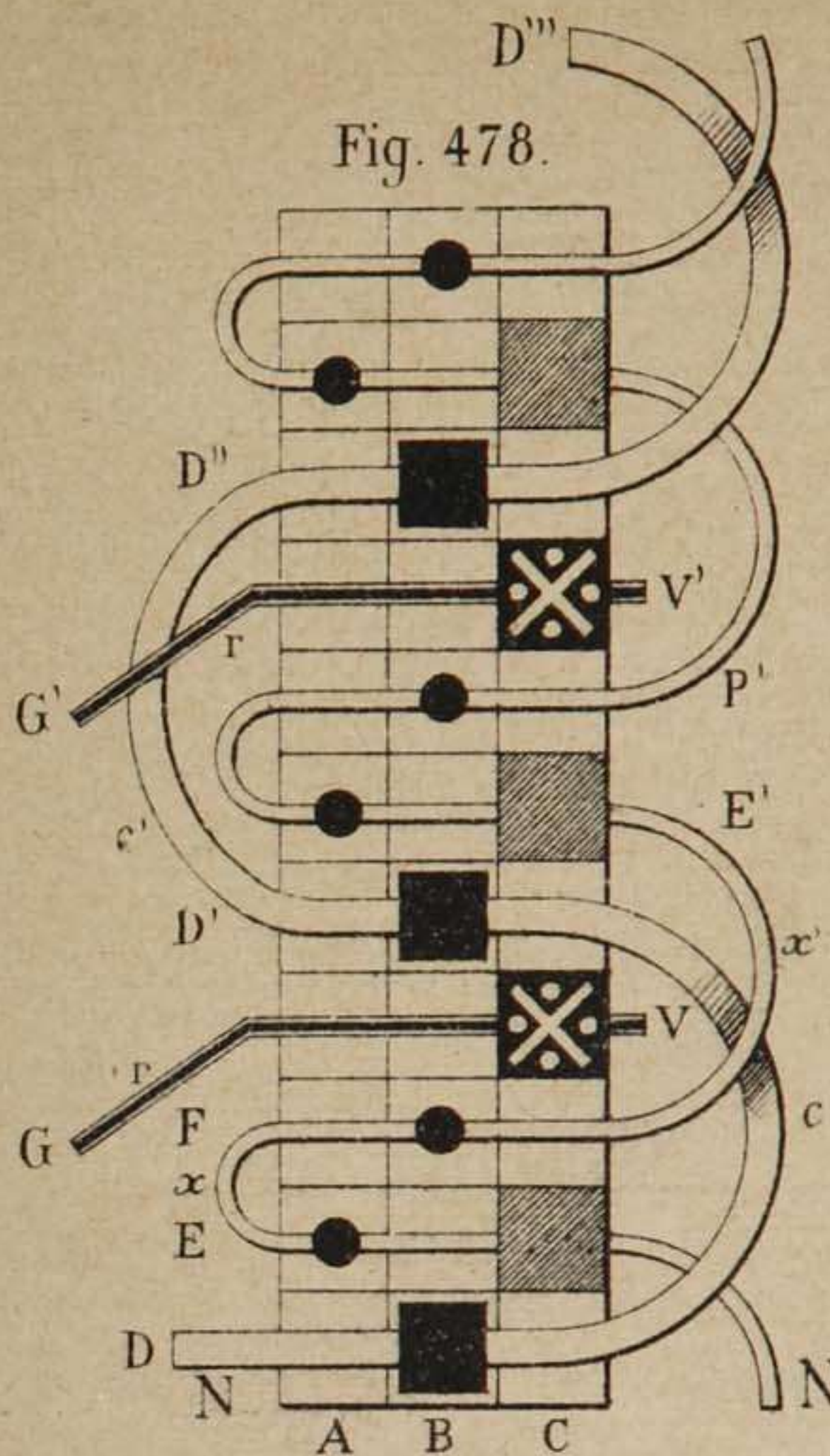


Fig. 481.

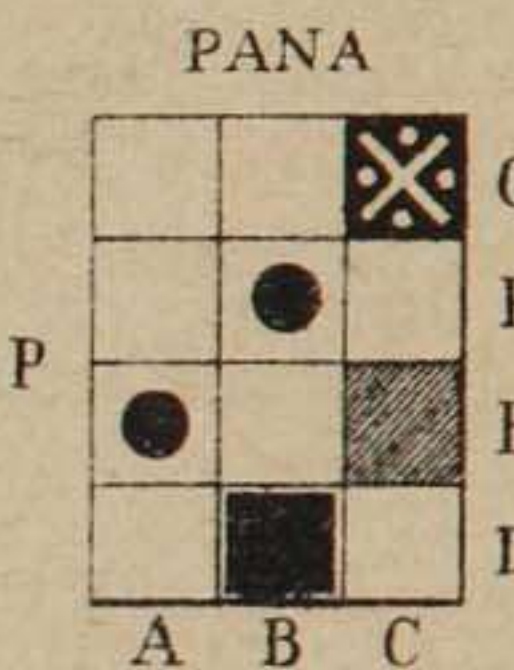


Fig. 480.

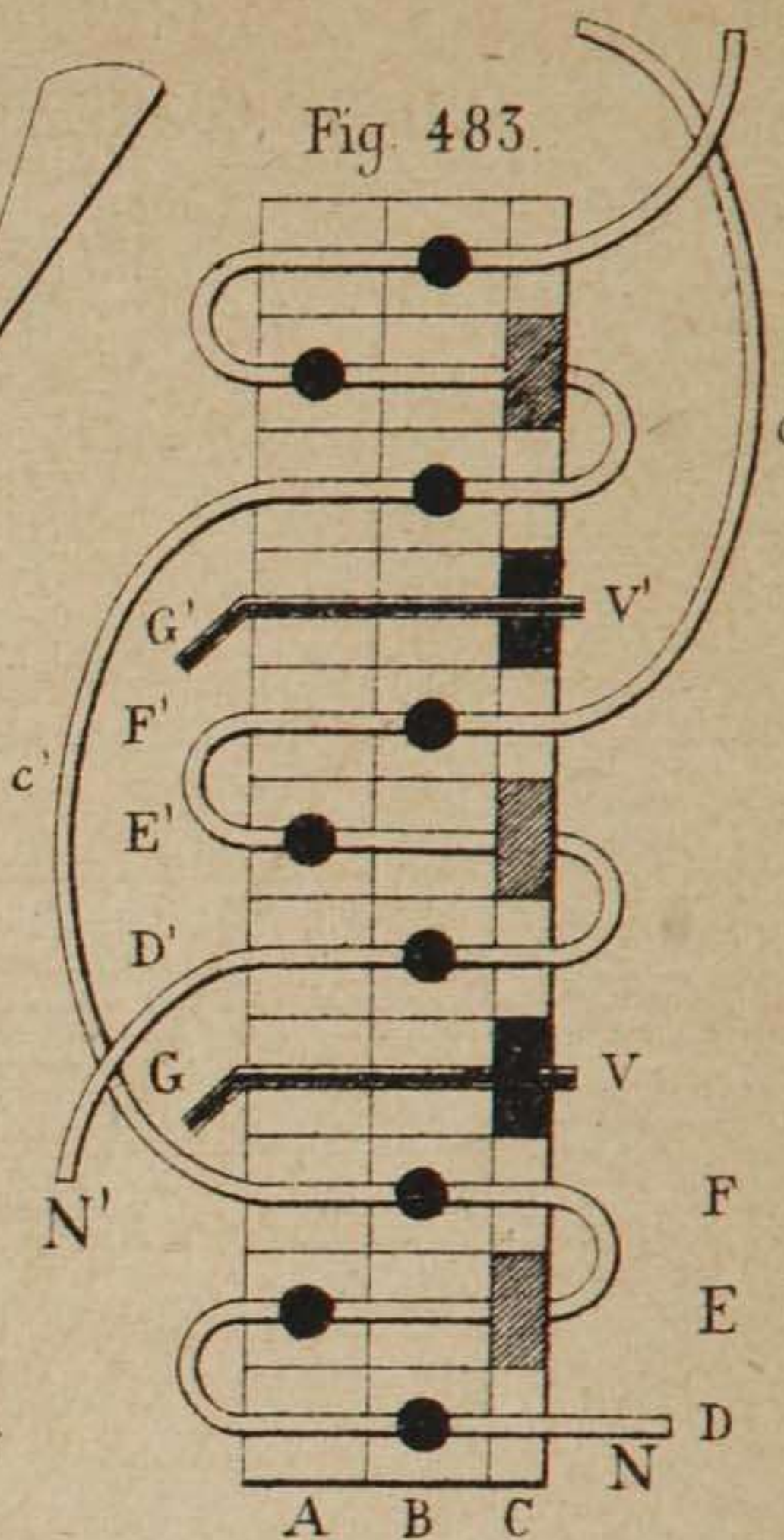
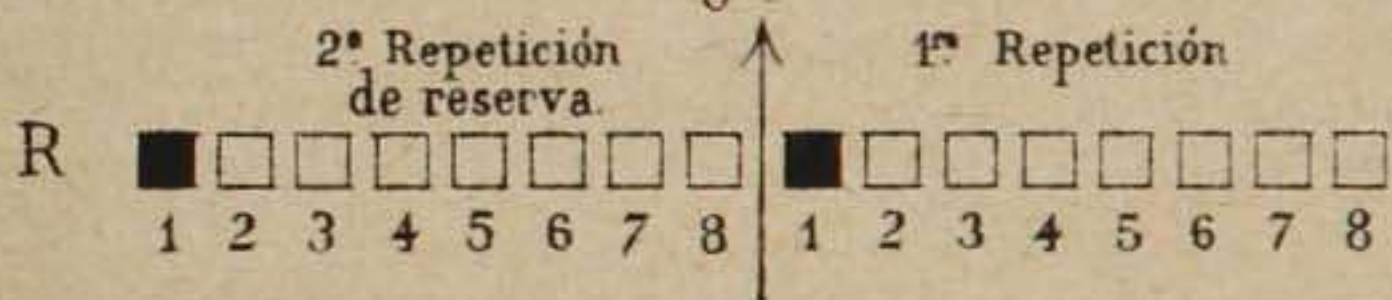


Fig. 483.

Fig. 490.



Pelo para pana de montar.

Fig. 482.

Pelo para Pana de librea.

Fig. 485.

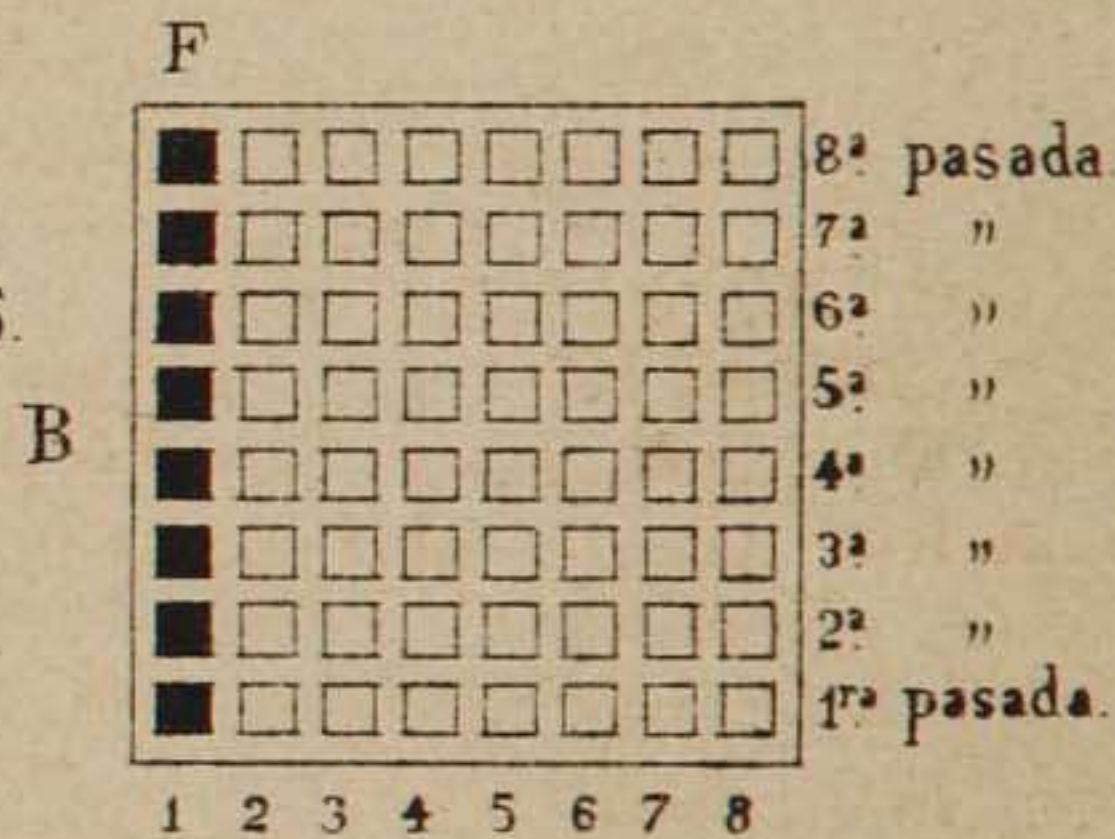


Fig. 484.

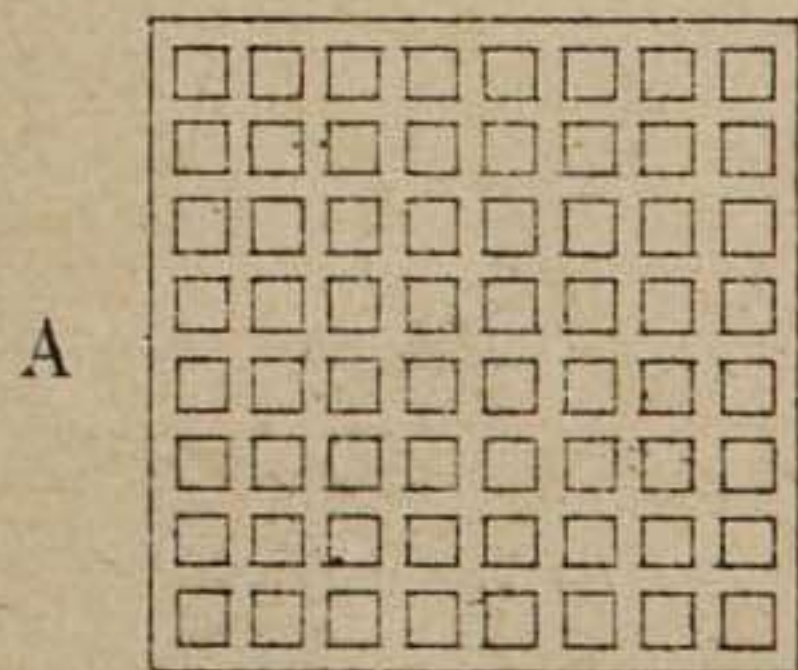


Fig. 486.

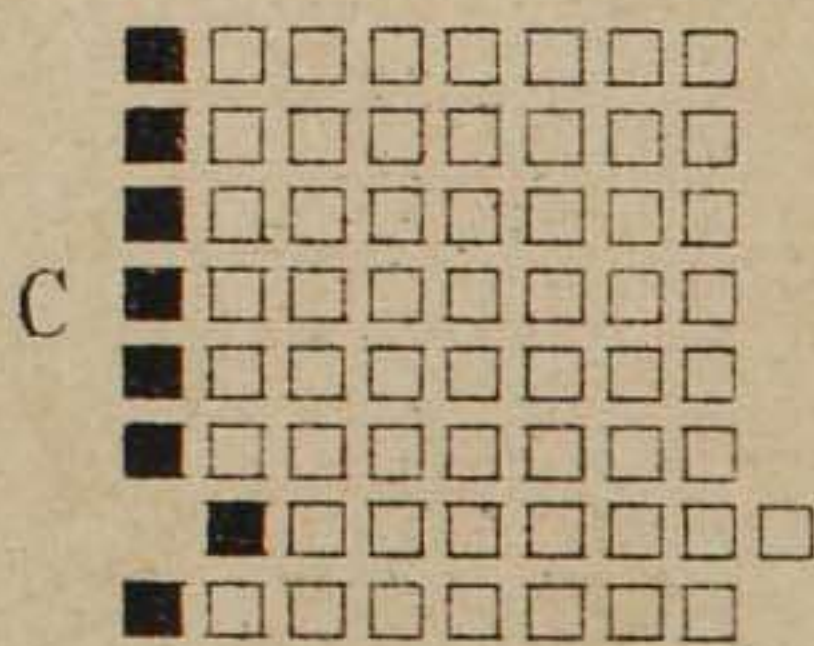


Fig. 489.

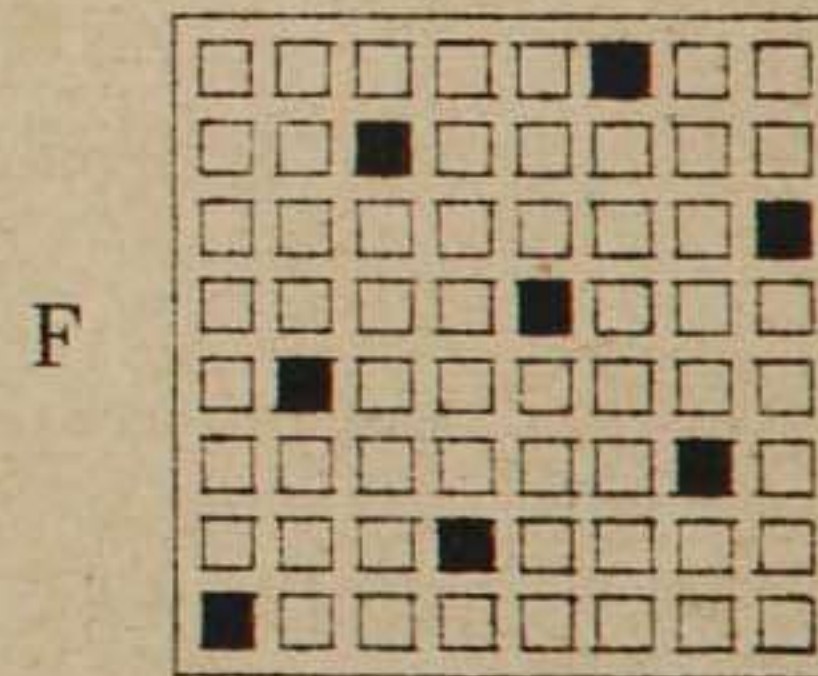


Fig. 487.

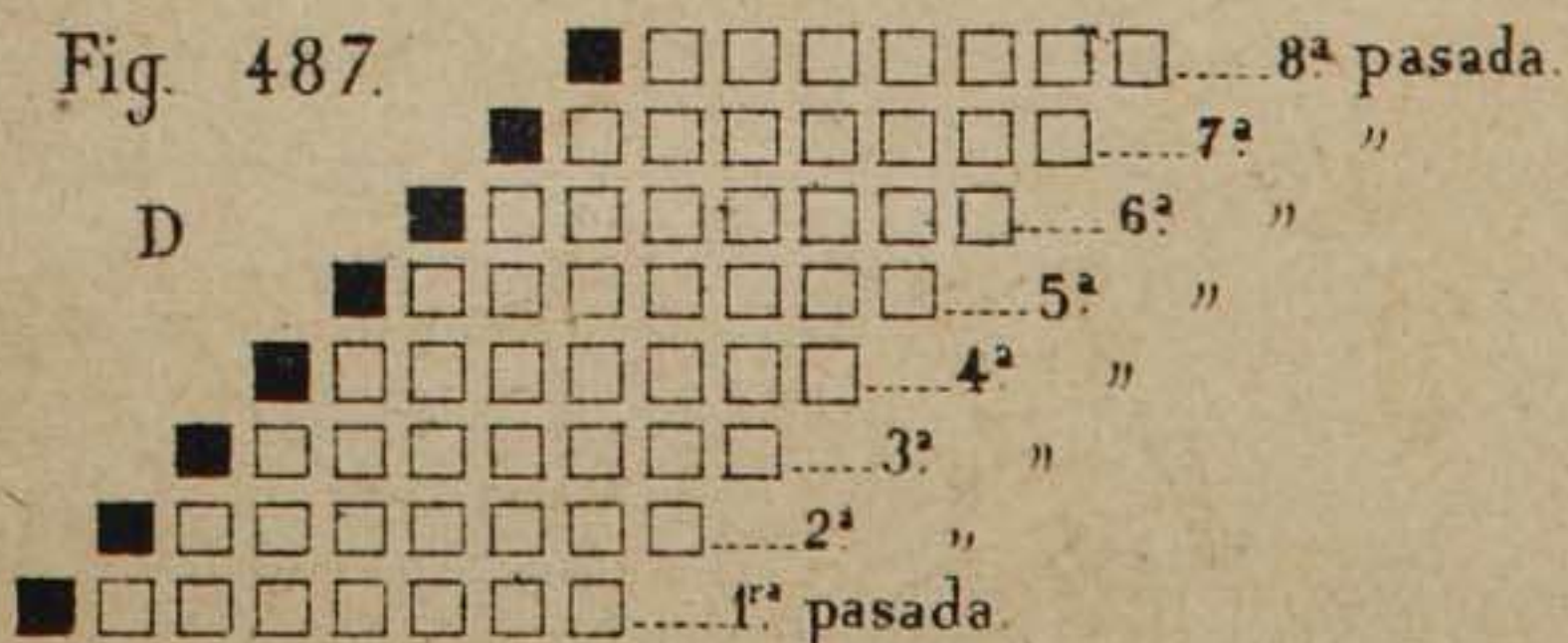
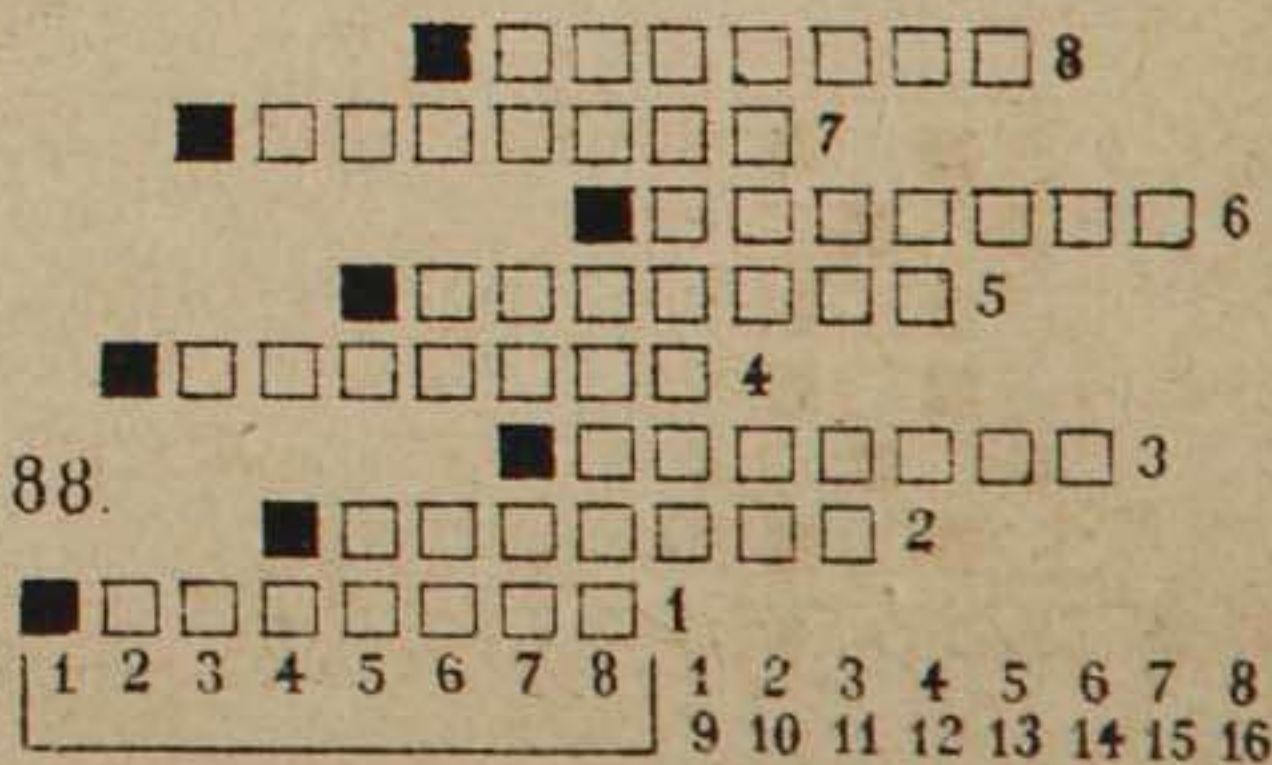


Fig. 488.



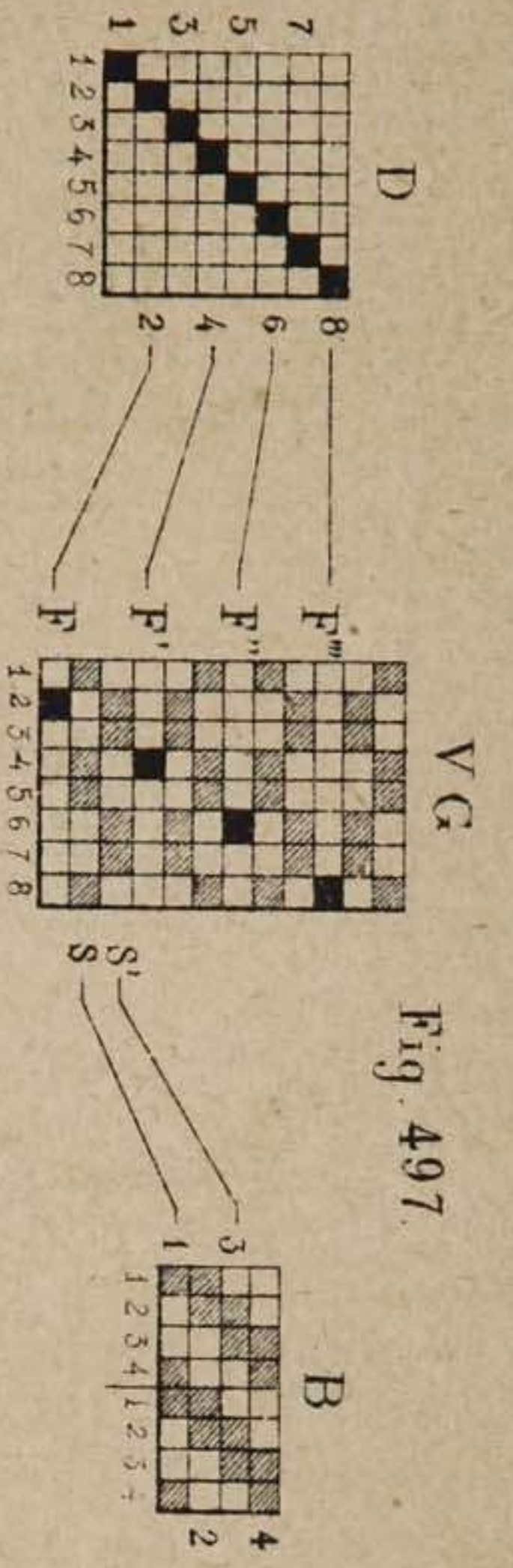


Fig. 497.

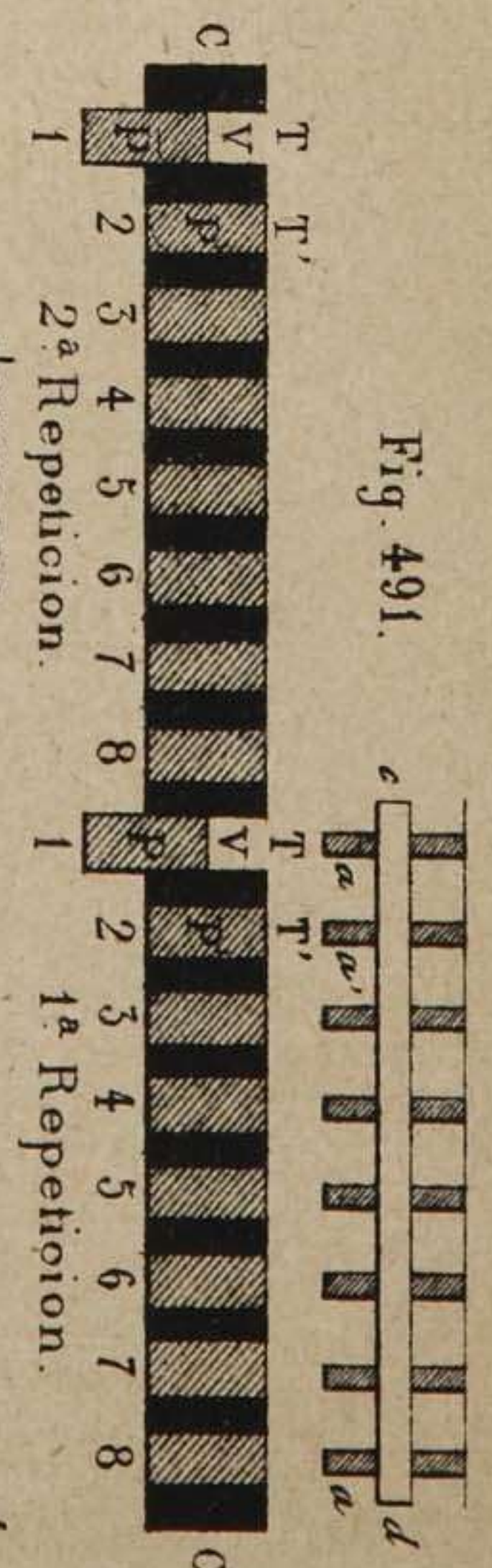


Fig. 491.

Fig. 500.

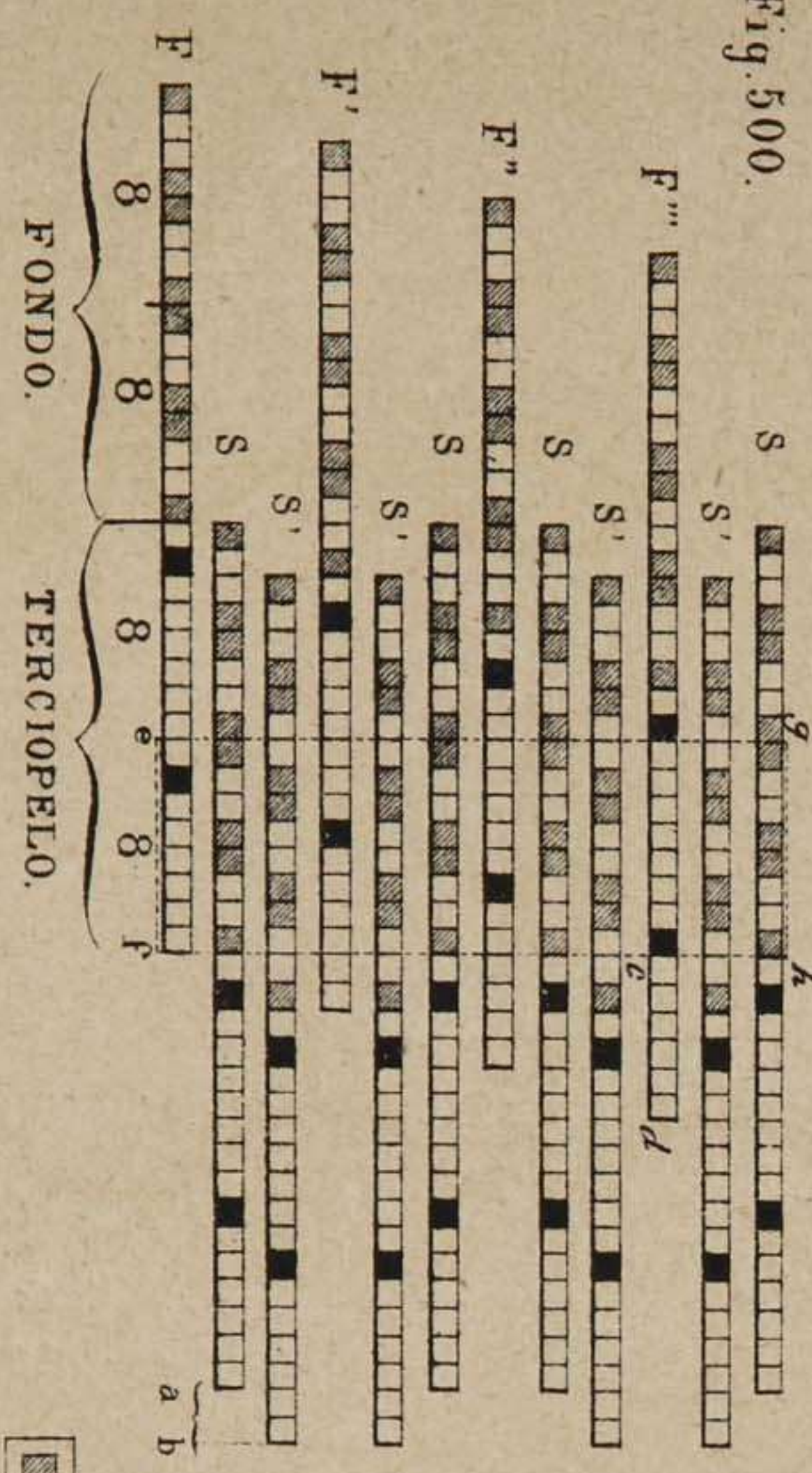


Fig. 492.

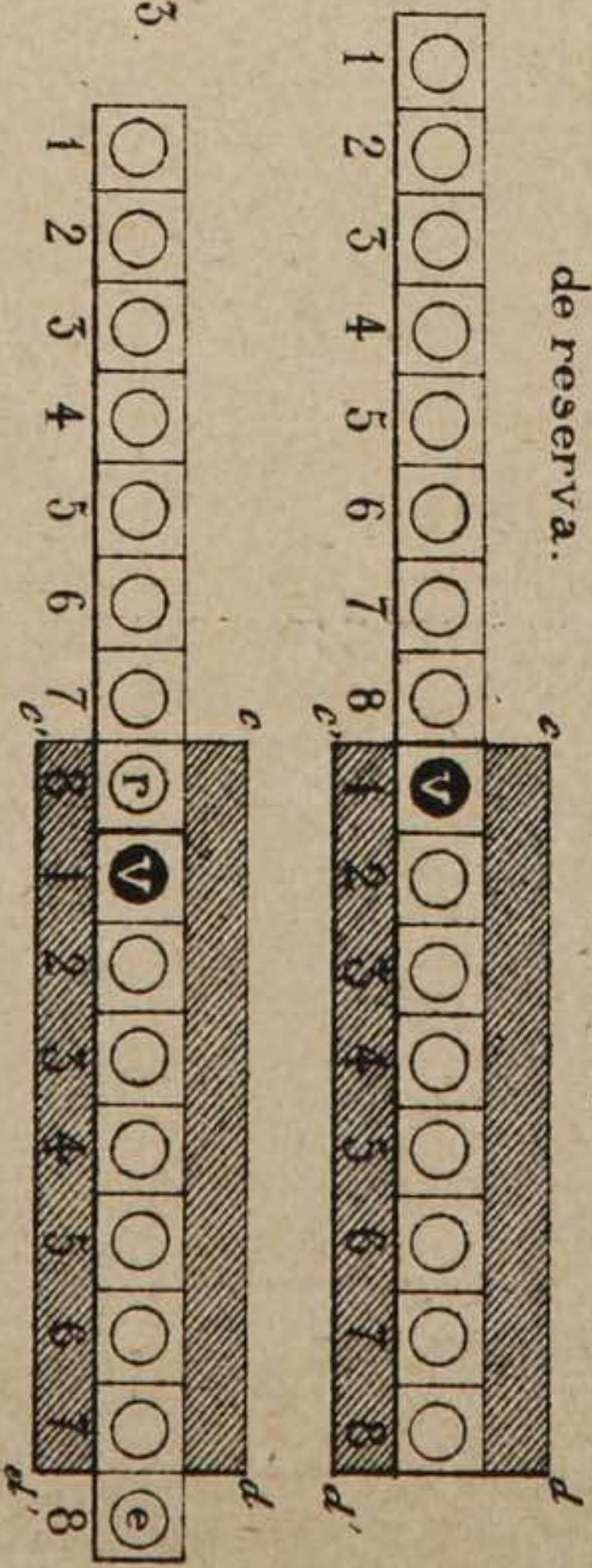


Fig. 493.

Fig. 499.

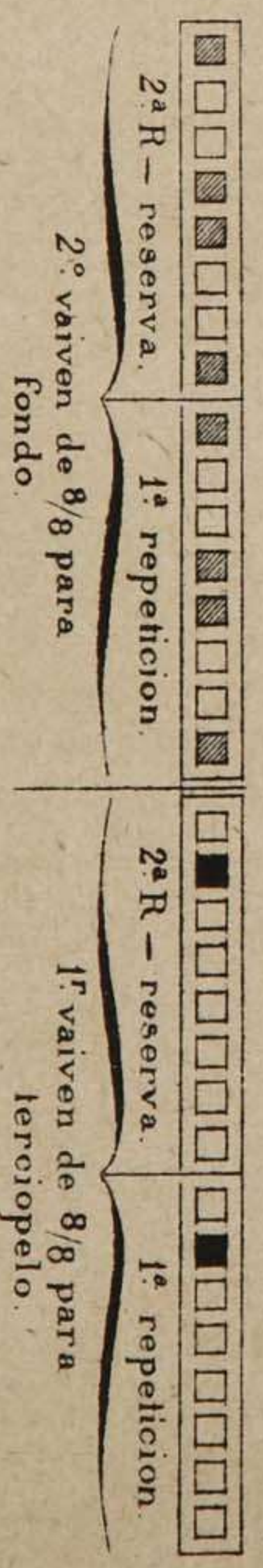


Fig. 495.

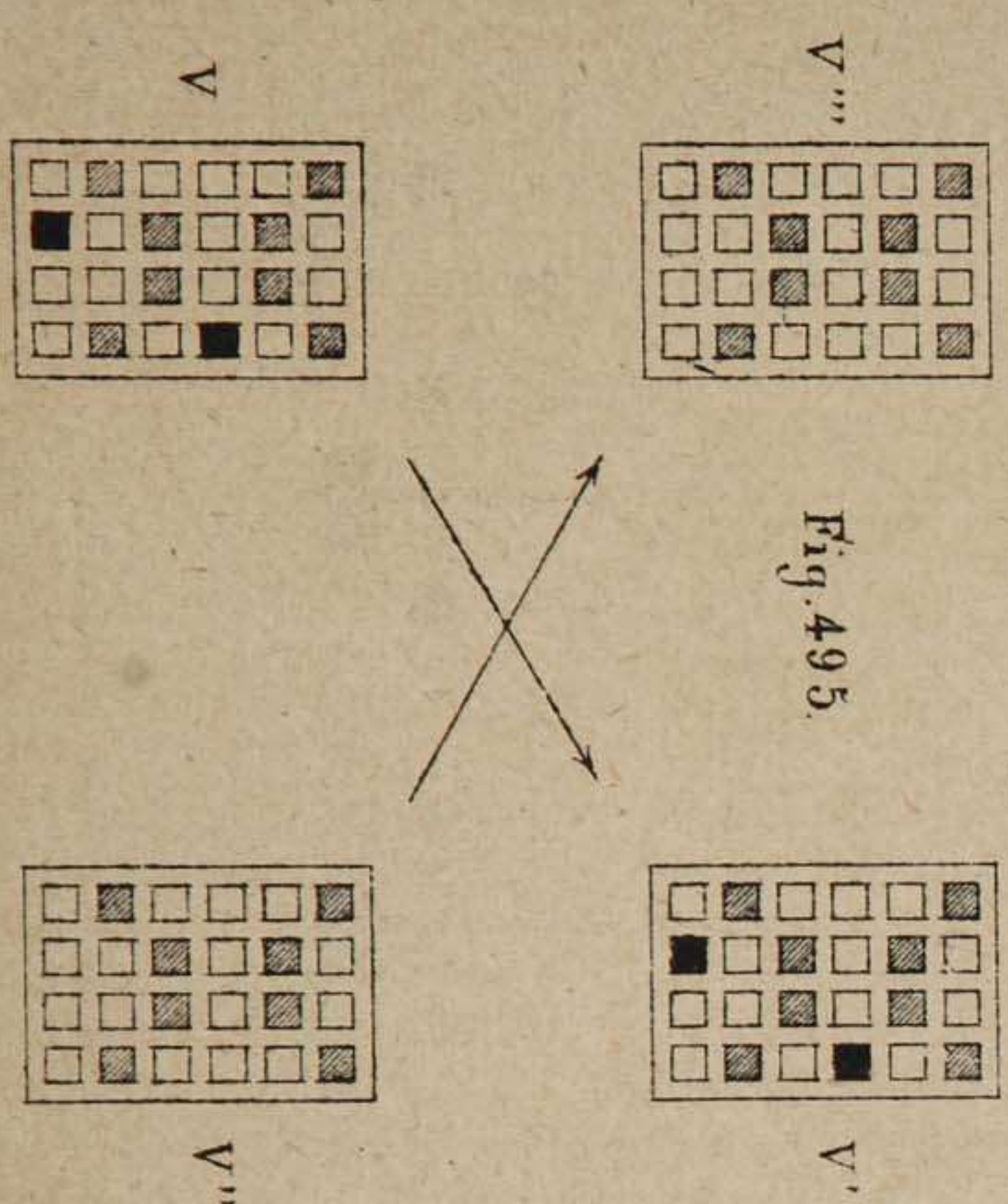


Fig. 496.

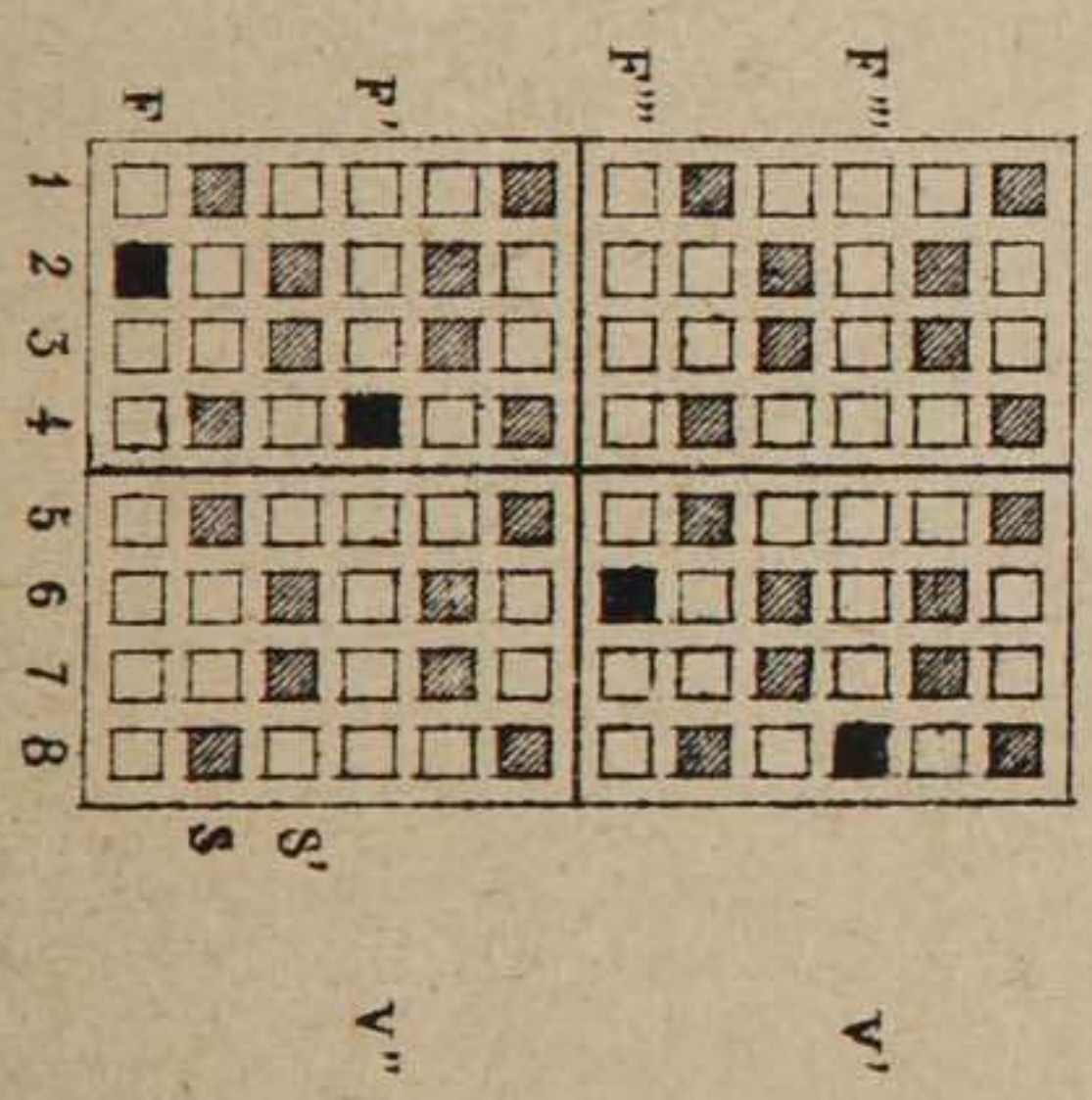


Fig. 494.

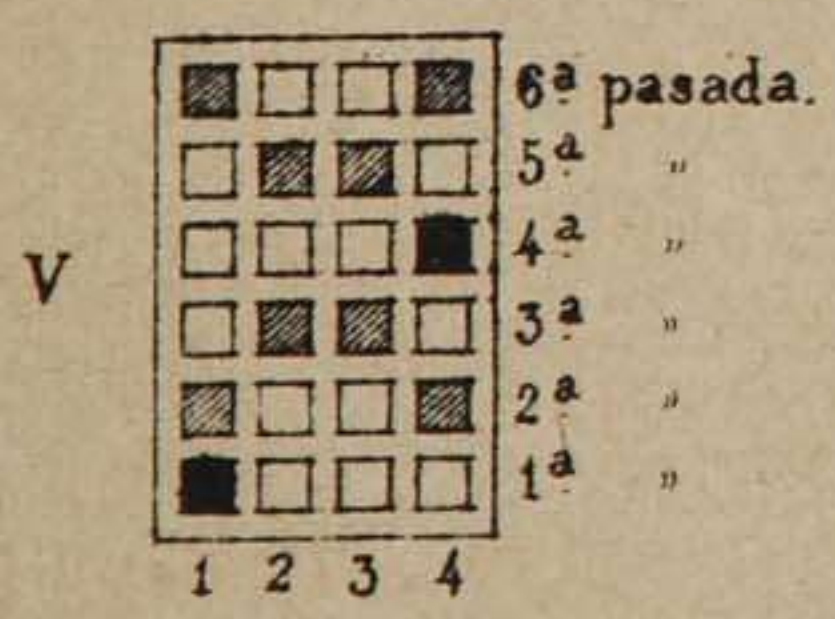
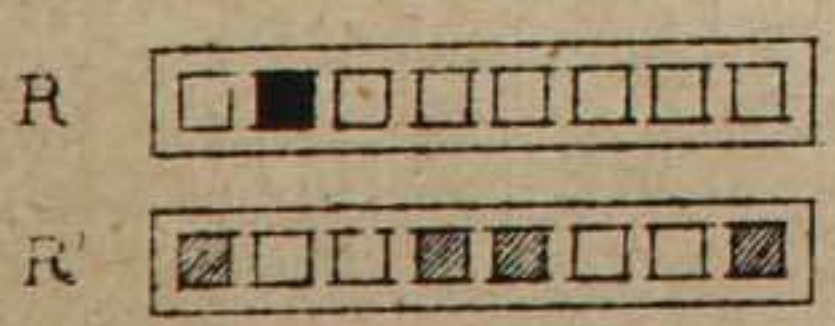


Fig. 498.



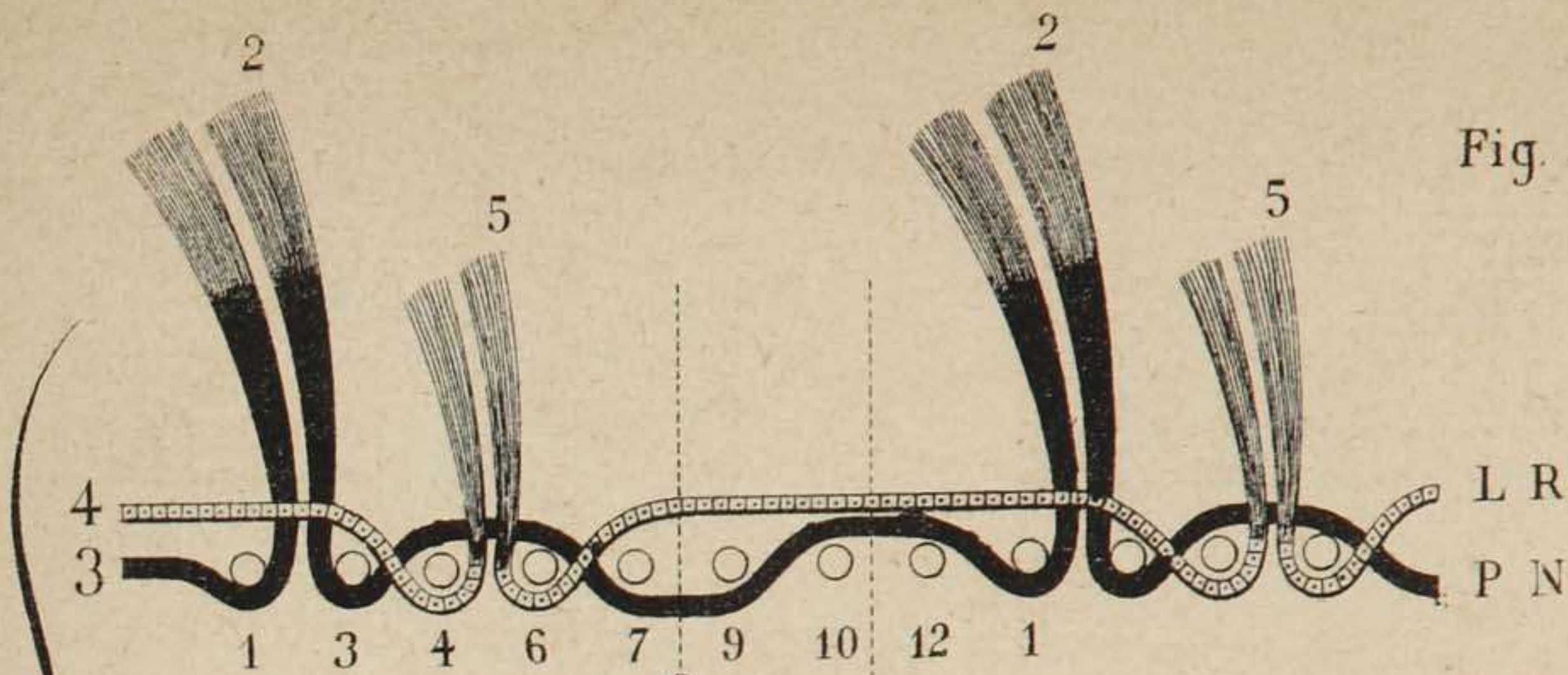


Fig. 504.

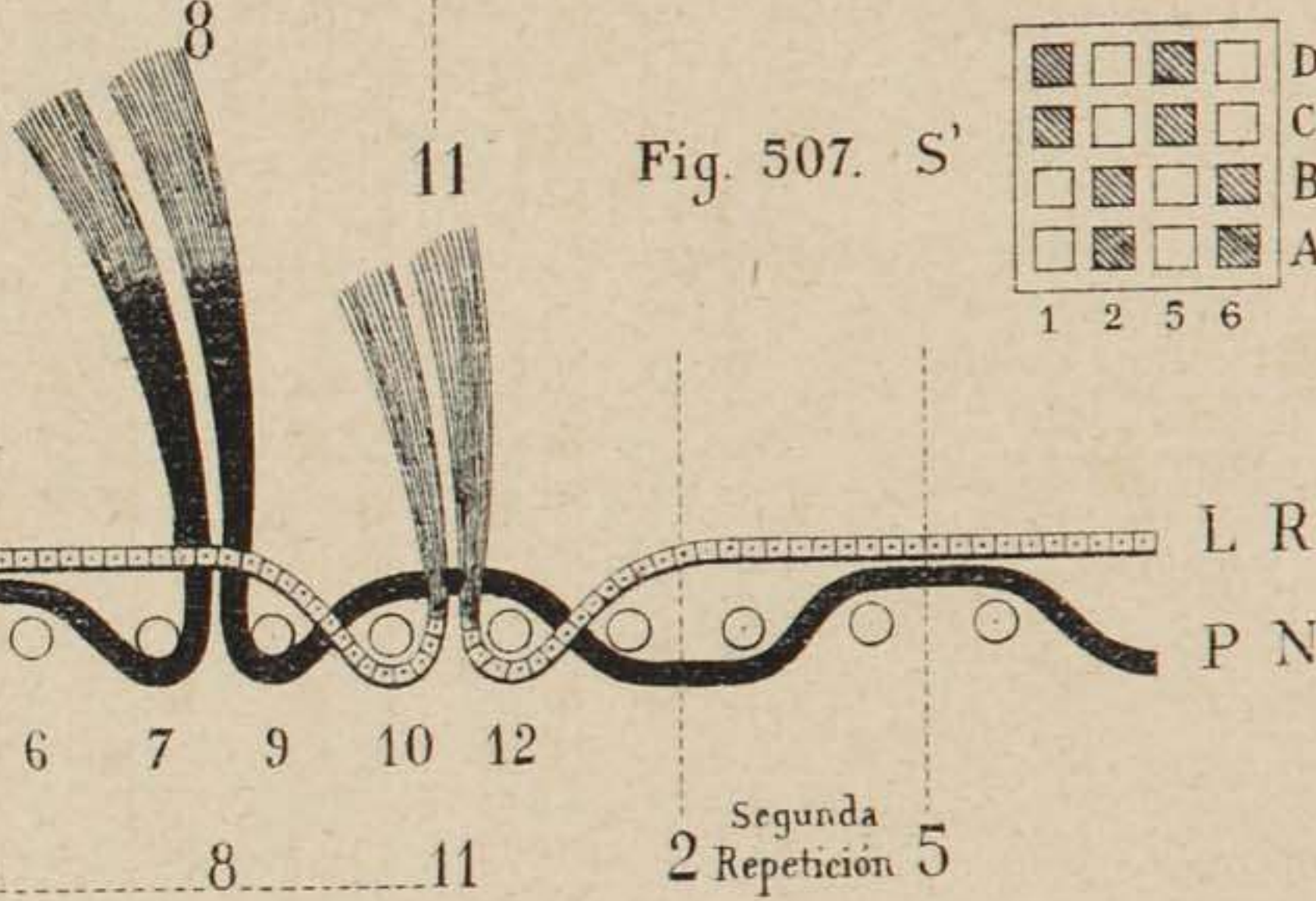


Fig. 507. S'

Paso de los Hierros 2 5 8 11 Segunda Repetición 5

Fig. 501.

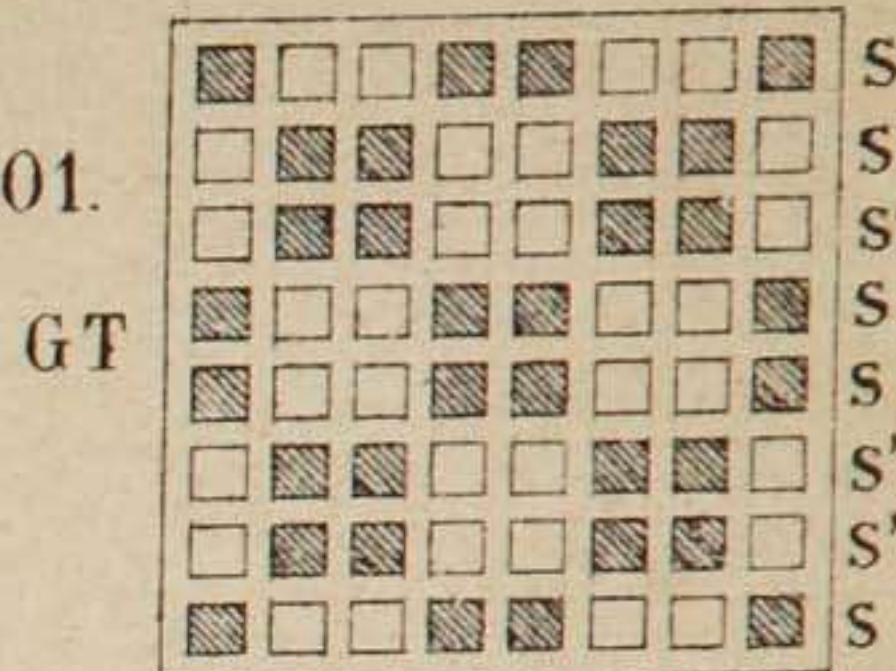


Fig. 508.

FONDO.

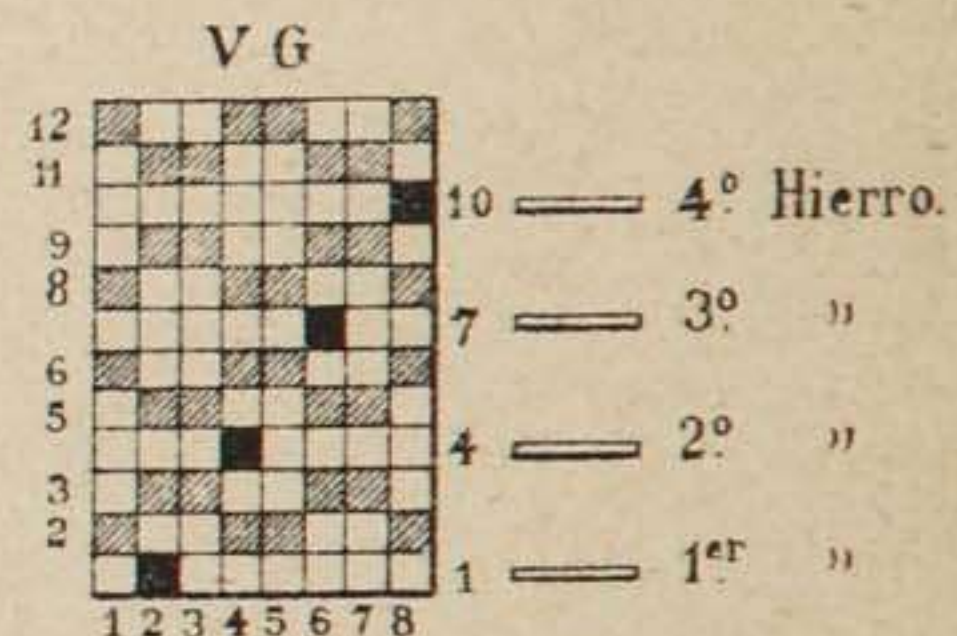
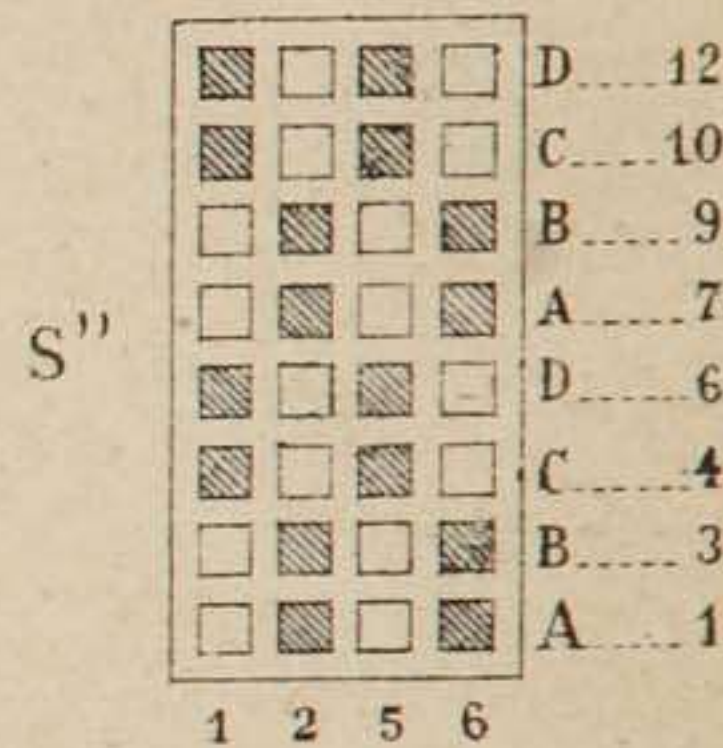


Fig. 503.

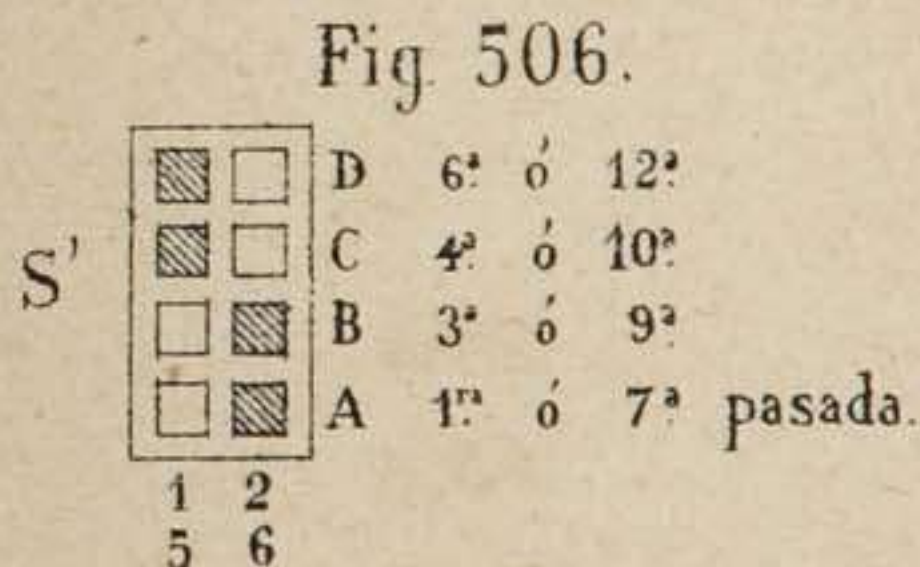


Fig. 506.

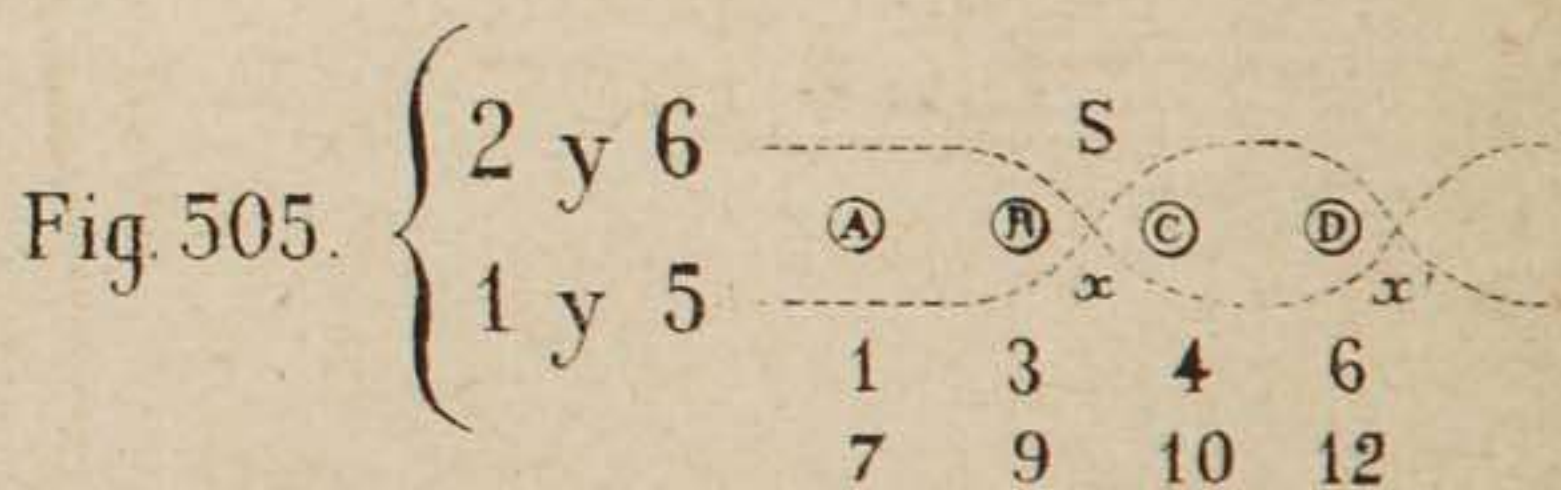
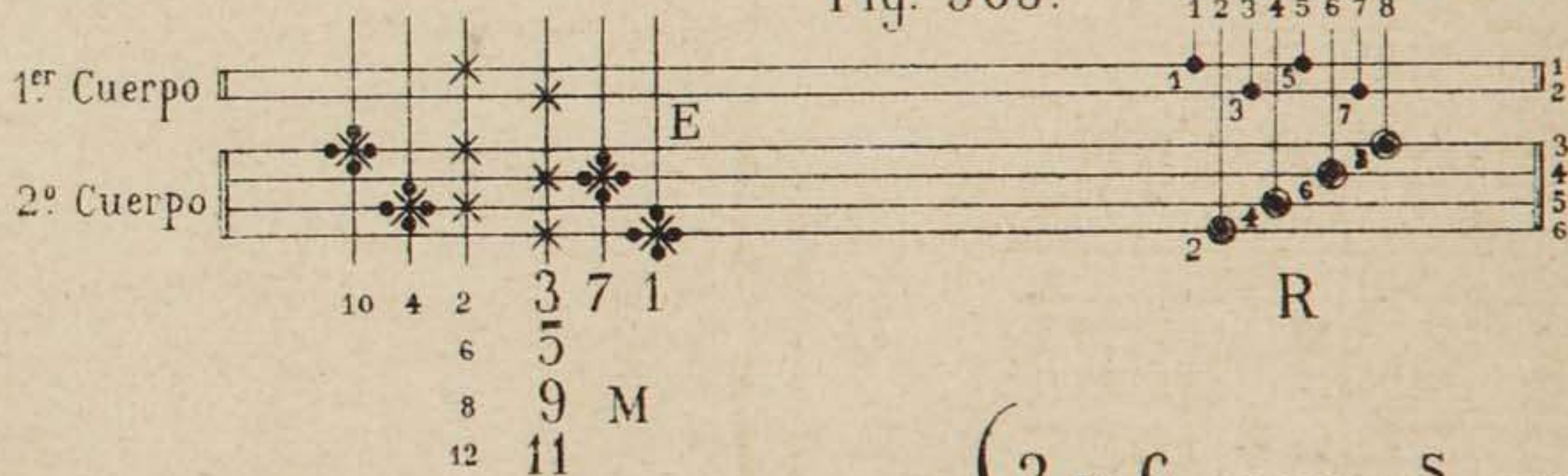


Fig. 505.

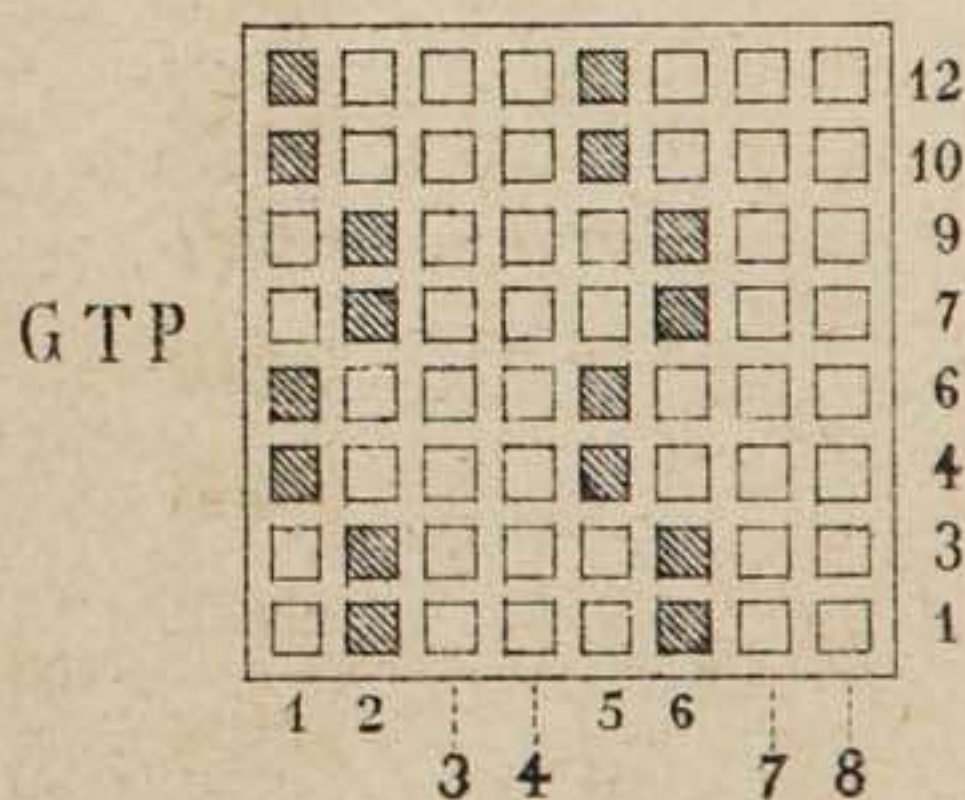


Fig. 510.

Fig. 512.

1.ºr Pelo negro, n.º 3.

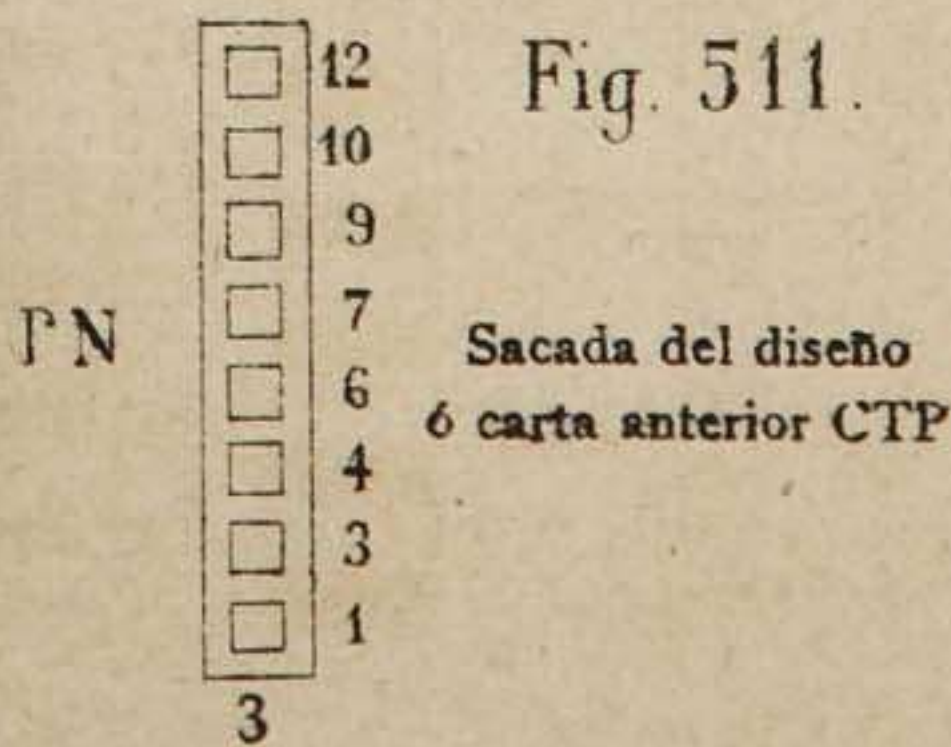
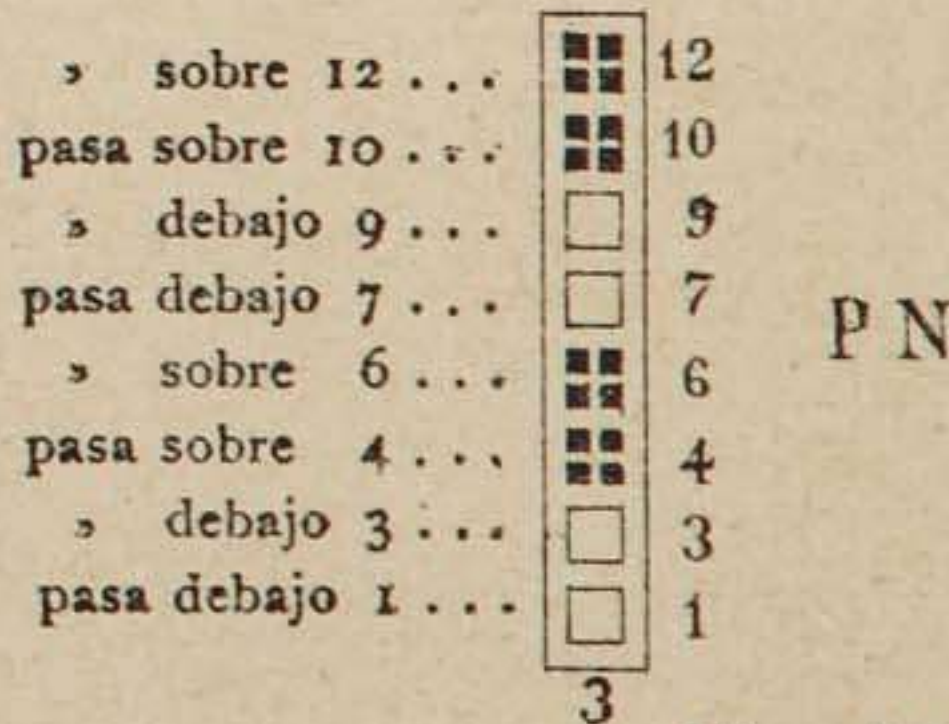
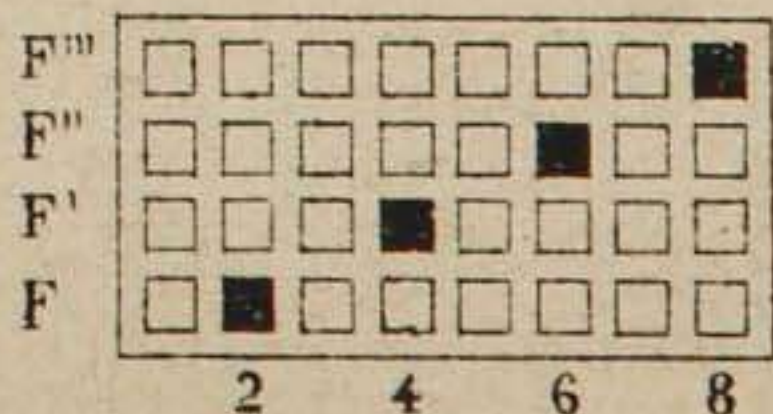


Fig. 511.

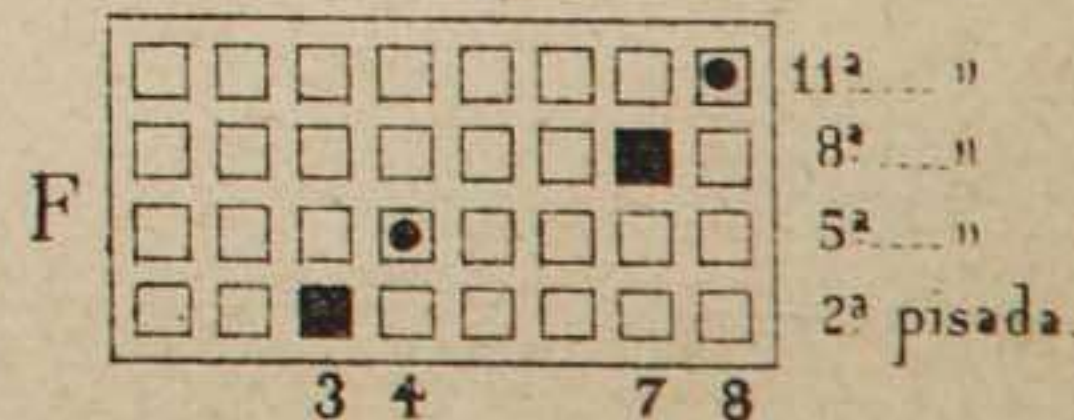
Sacada del diseño 6 carta anterior CTP

Fig. 502.



VP

Fig. 509.



Leyenda.
 ■ Pelo negro.
 ▨ Pelo rojo.

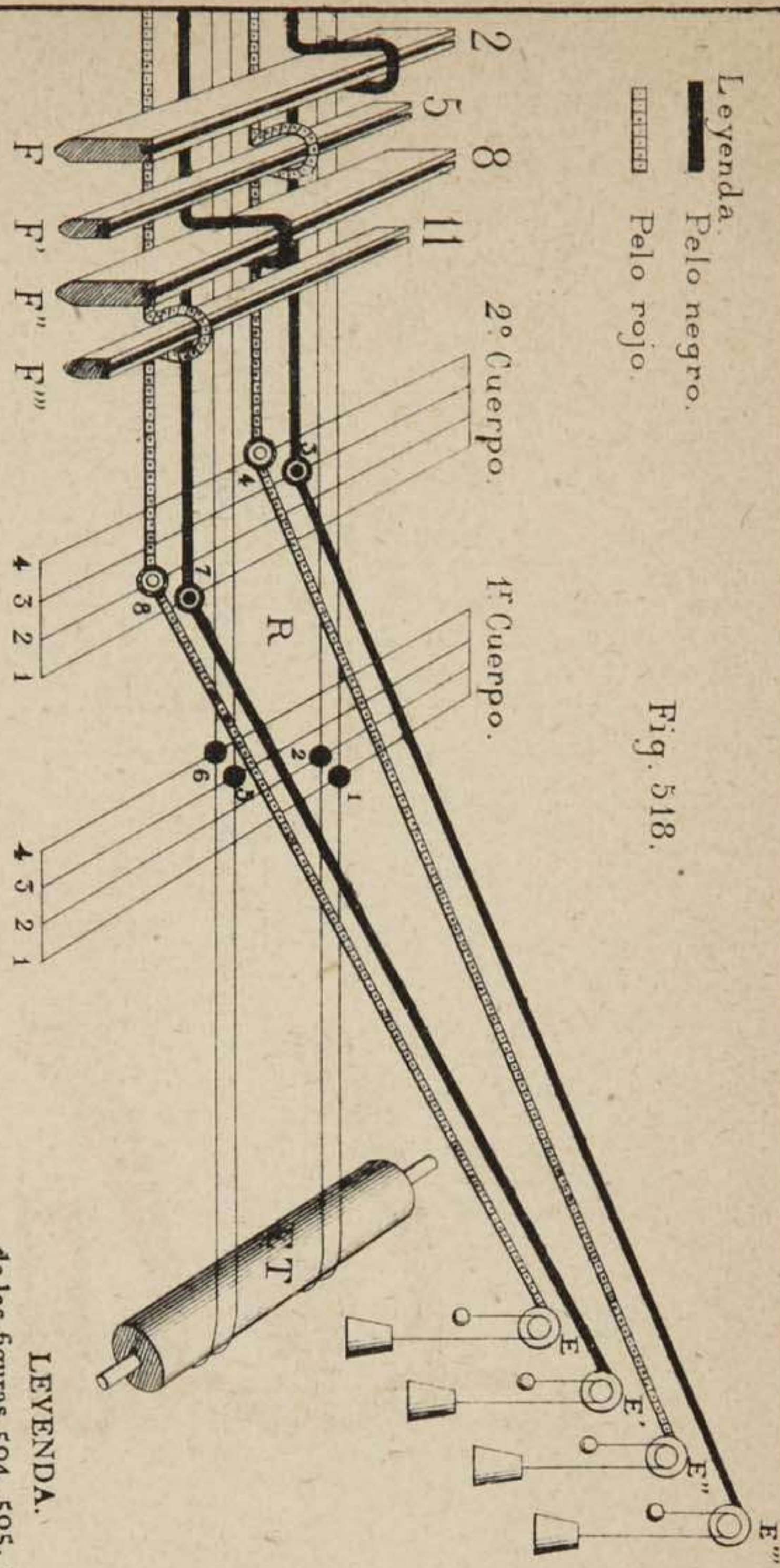


Fig. 518.

LEYENDA.
 de las figuras 504, 505, 517.

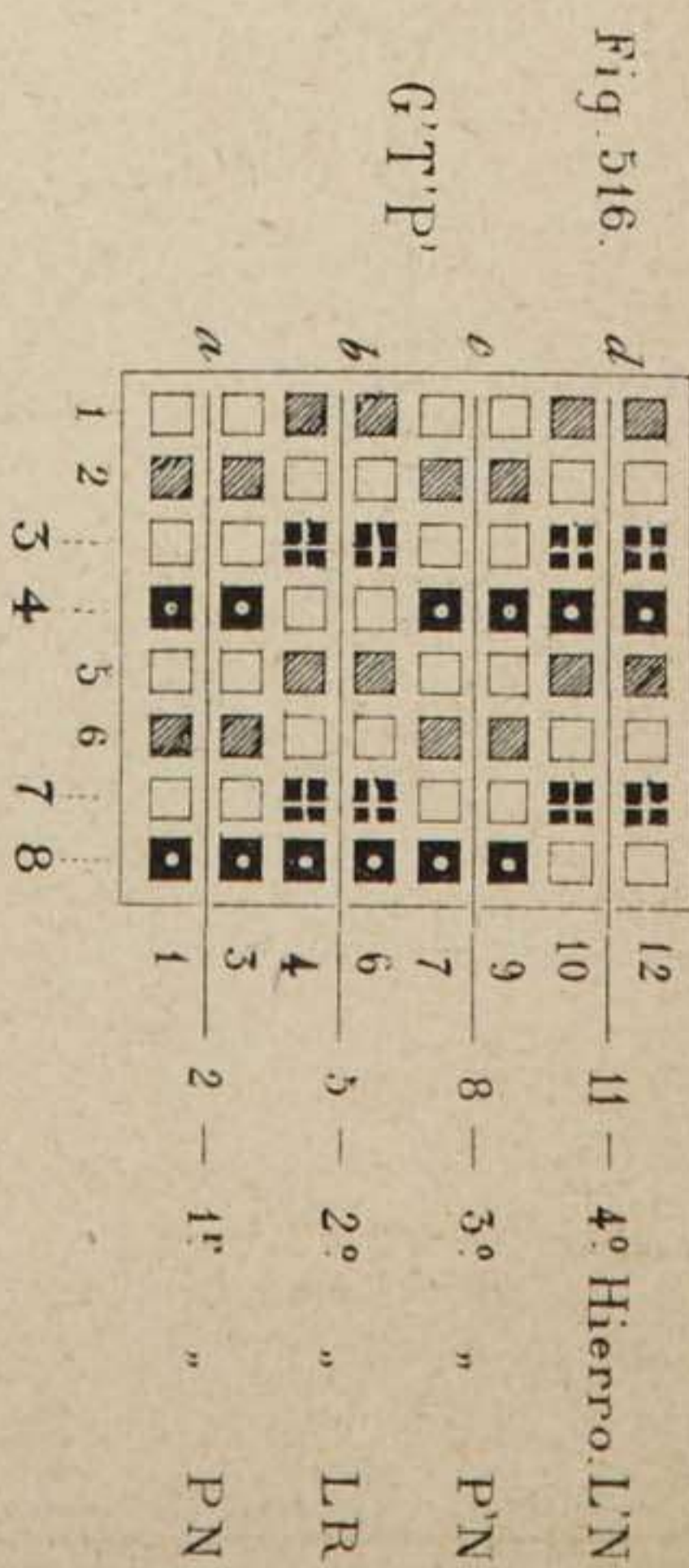
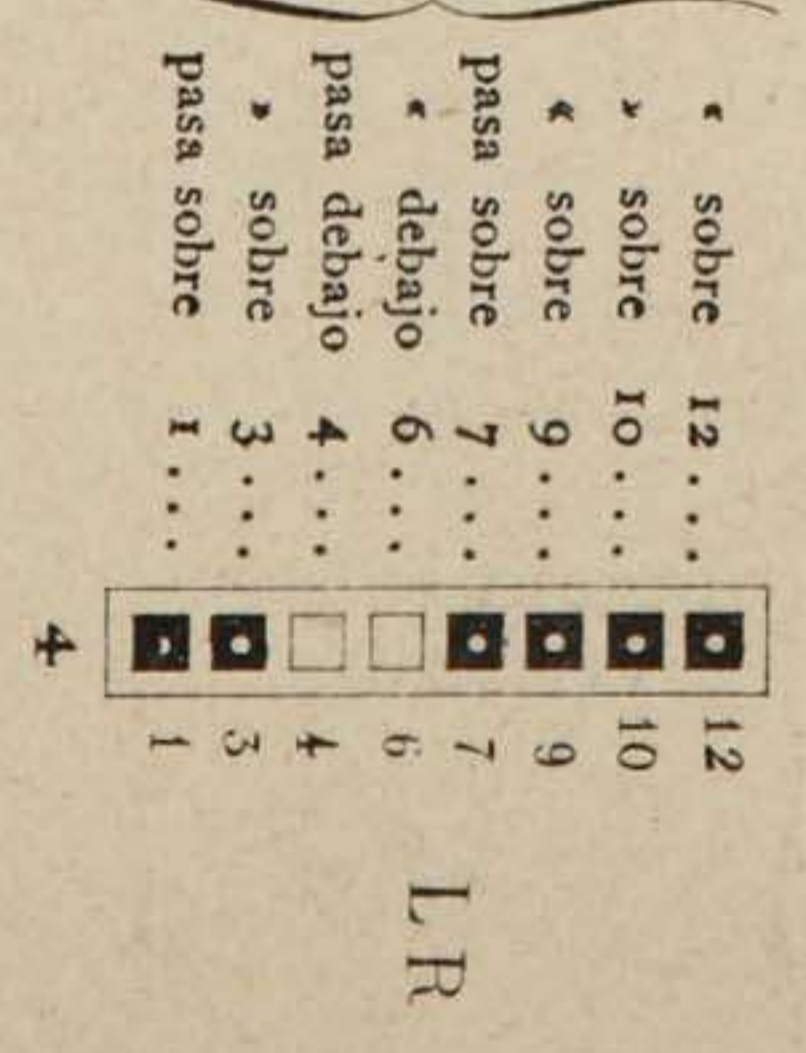


Fig. 516.

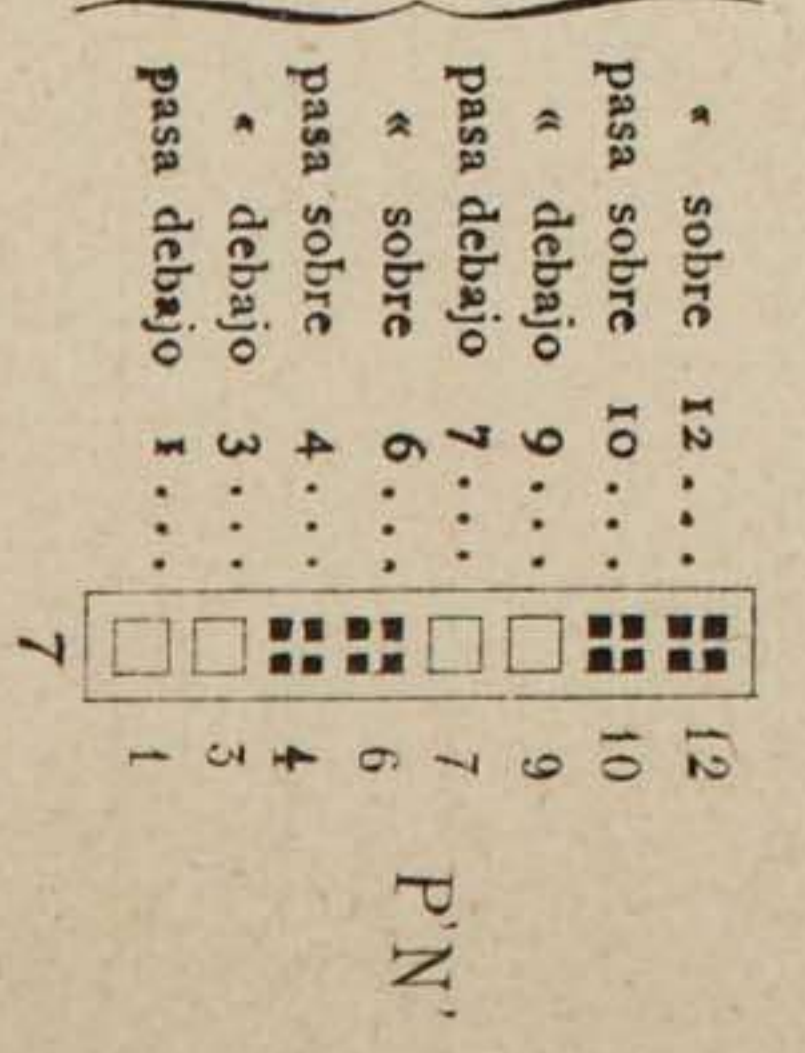
1.º Pelo rojo, n.º 4.

Fig. 513.



2.º Pelo negro, n.º 7.

Fig. 514.



2.º Pelo rojo, n.º 8.

Fig. 515.

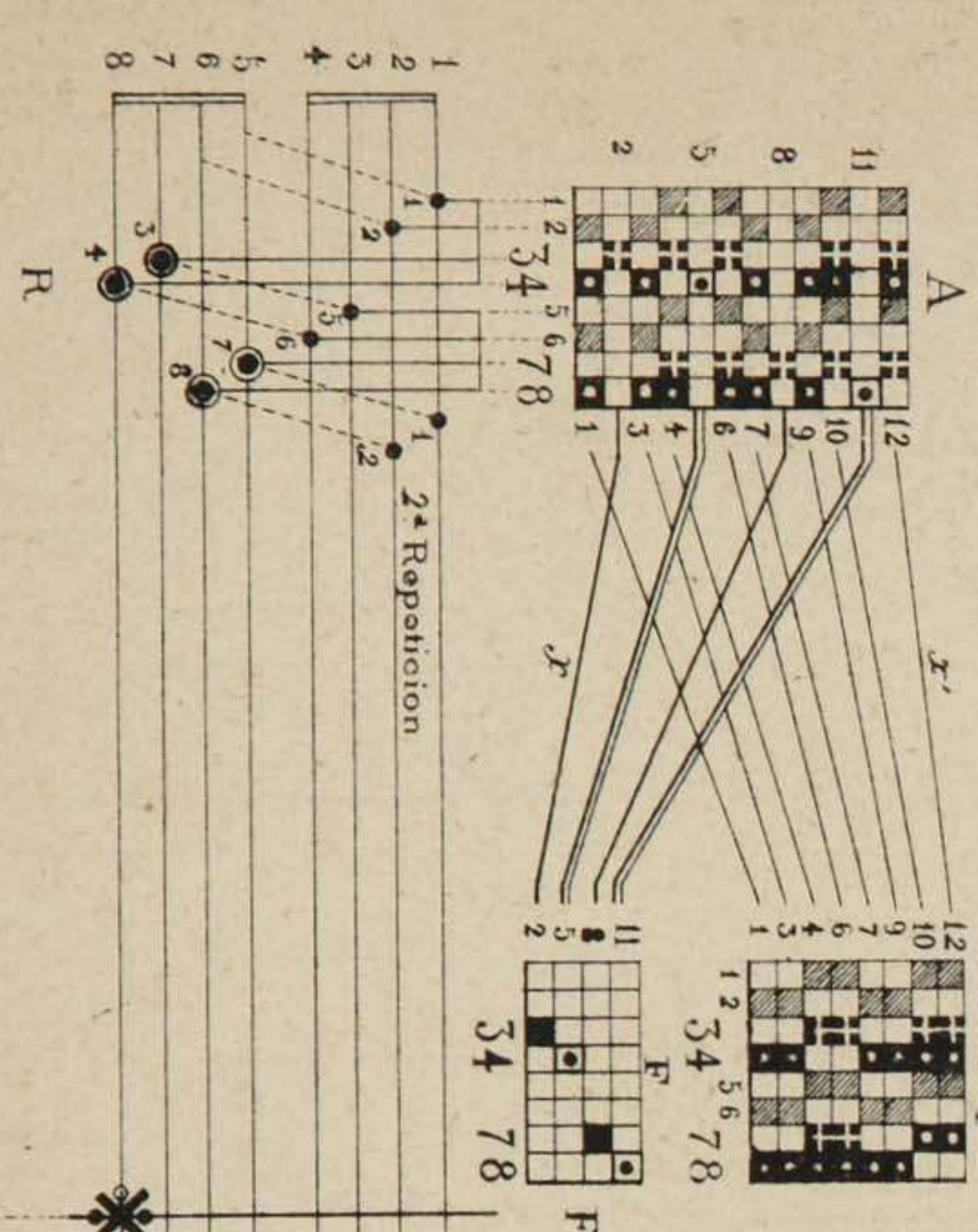
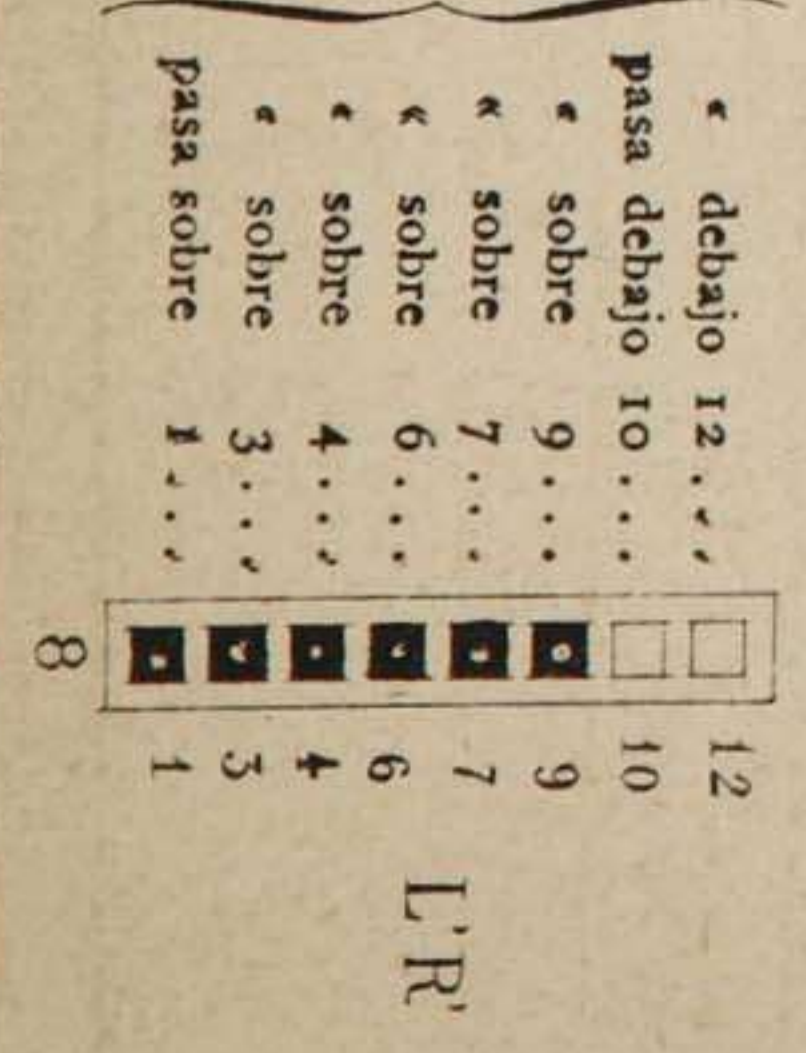
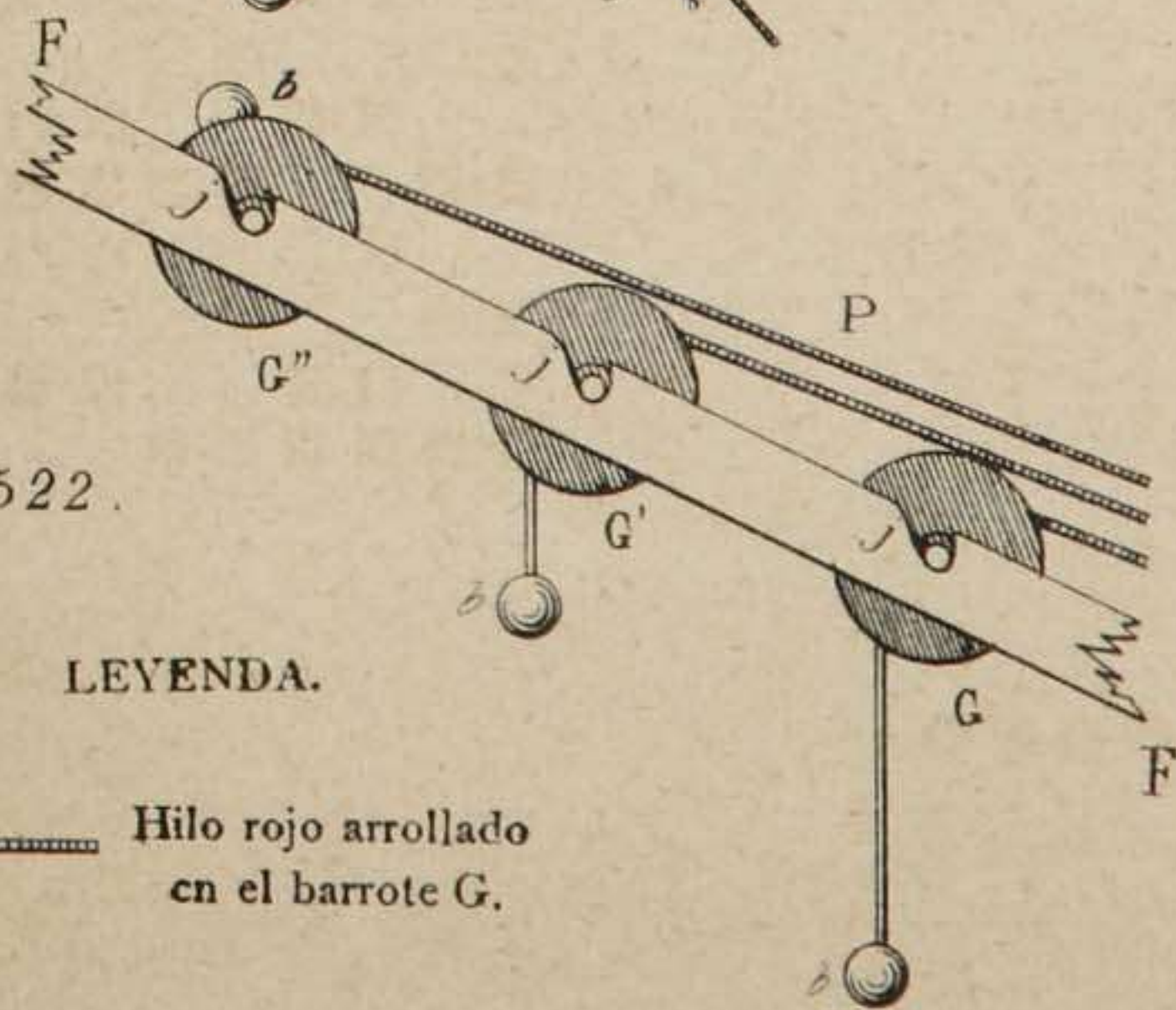
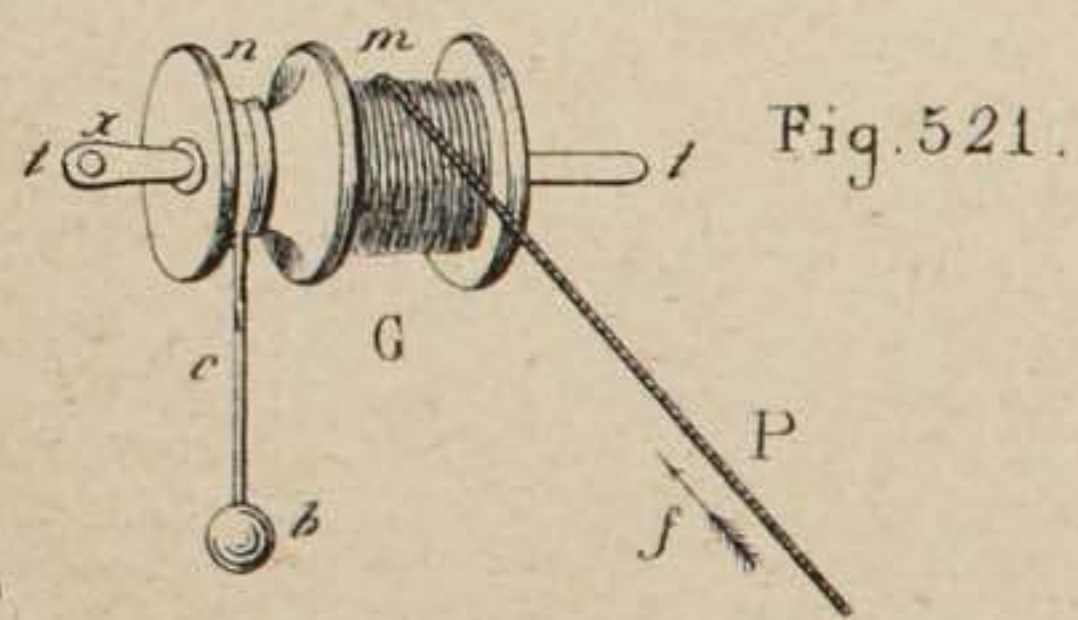
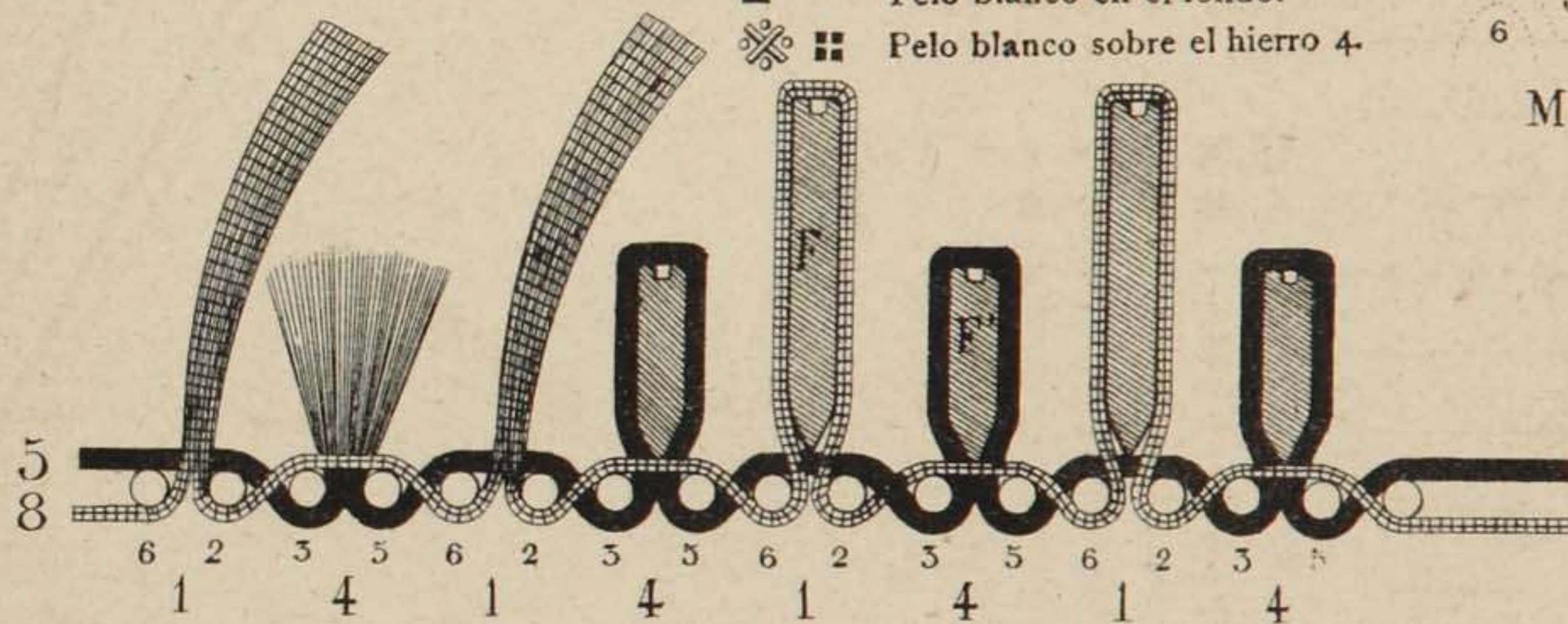
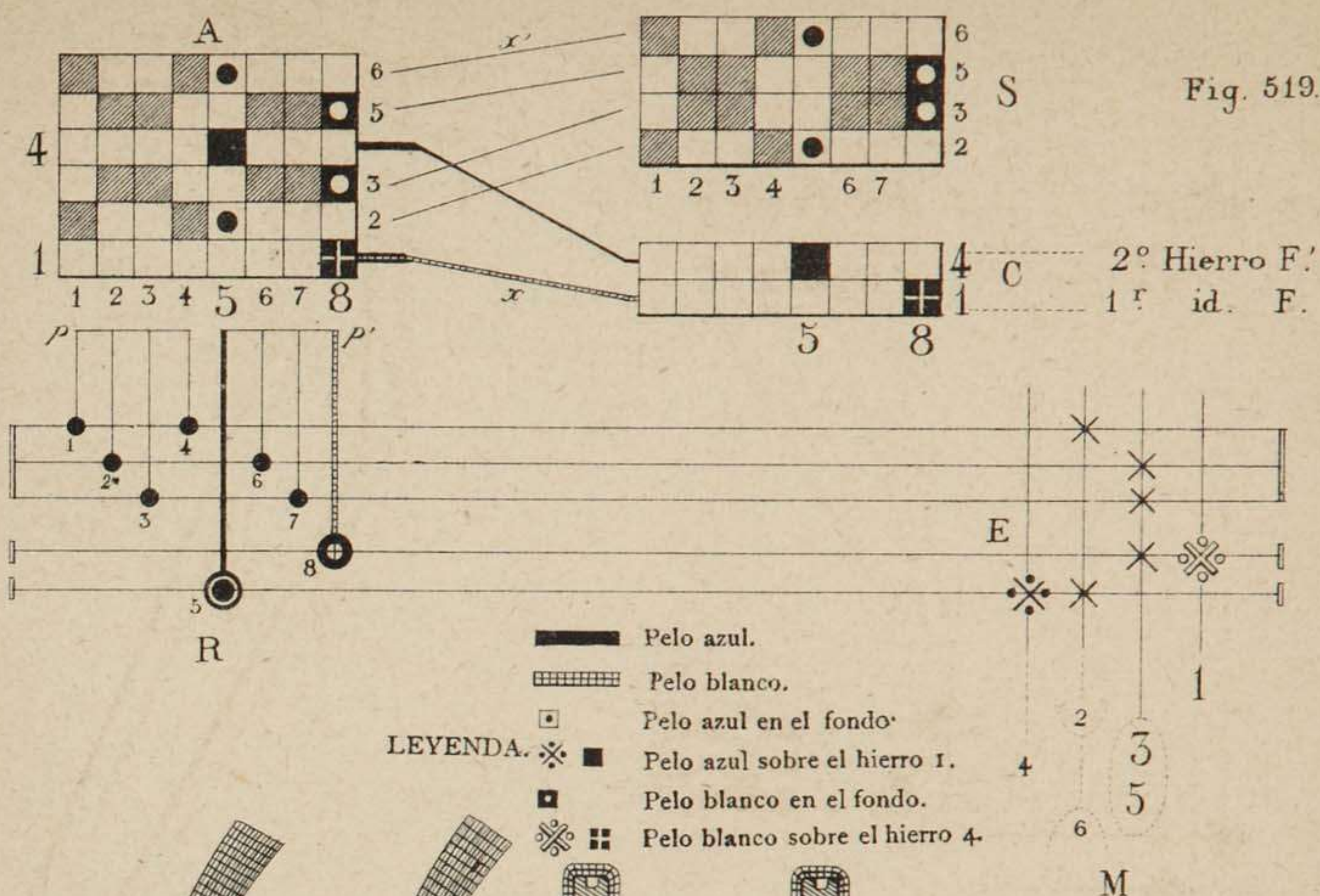


Fig. 517.



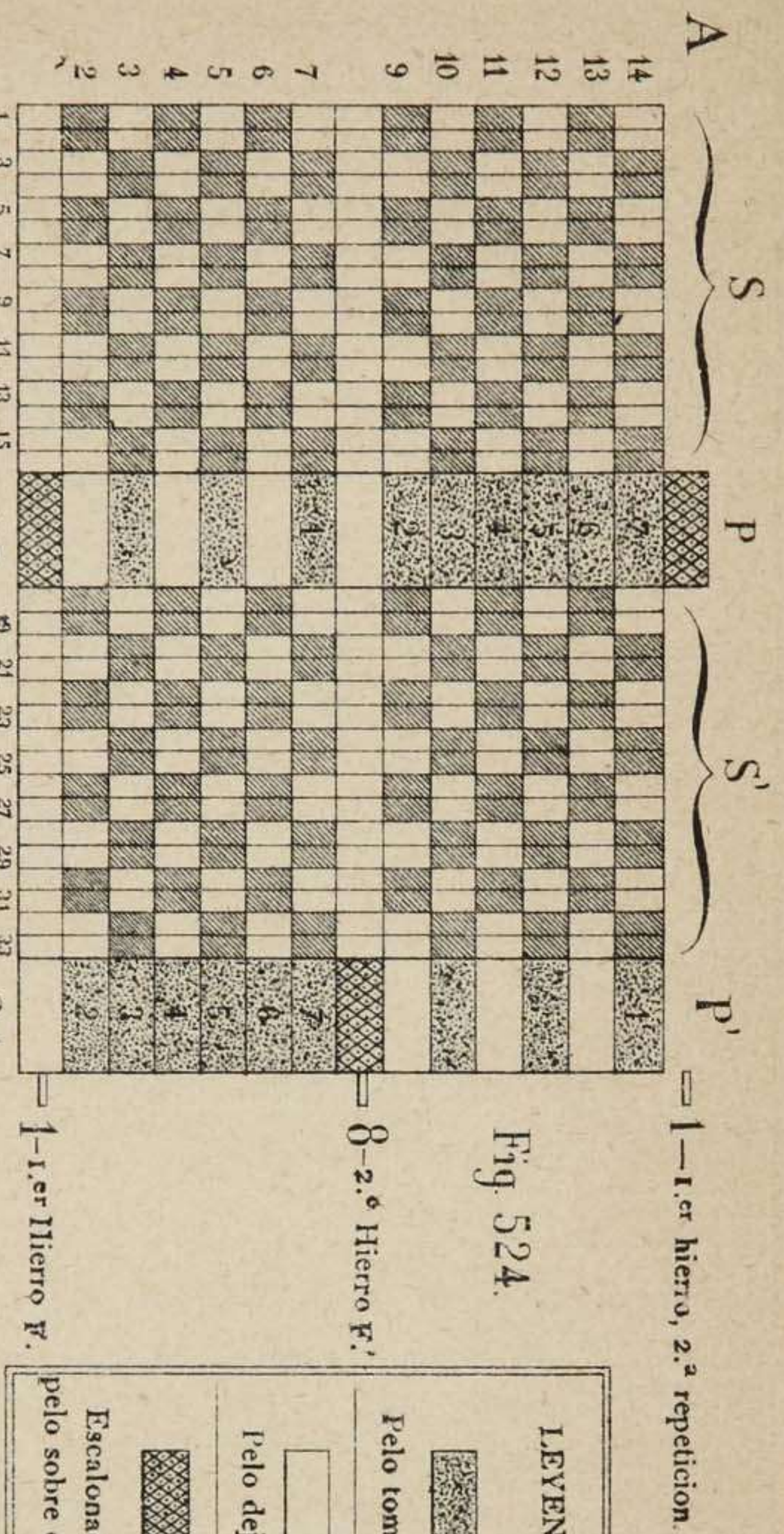


Fig. 524.

LEVENDA.	
Pelo tomado.	
Pelo dejado.	
Escalonado del pelo sobre el hierro.	

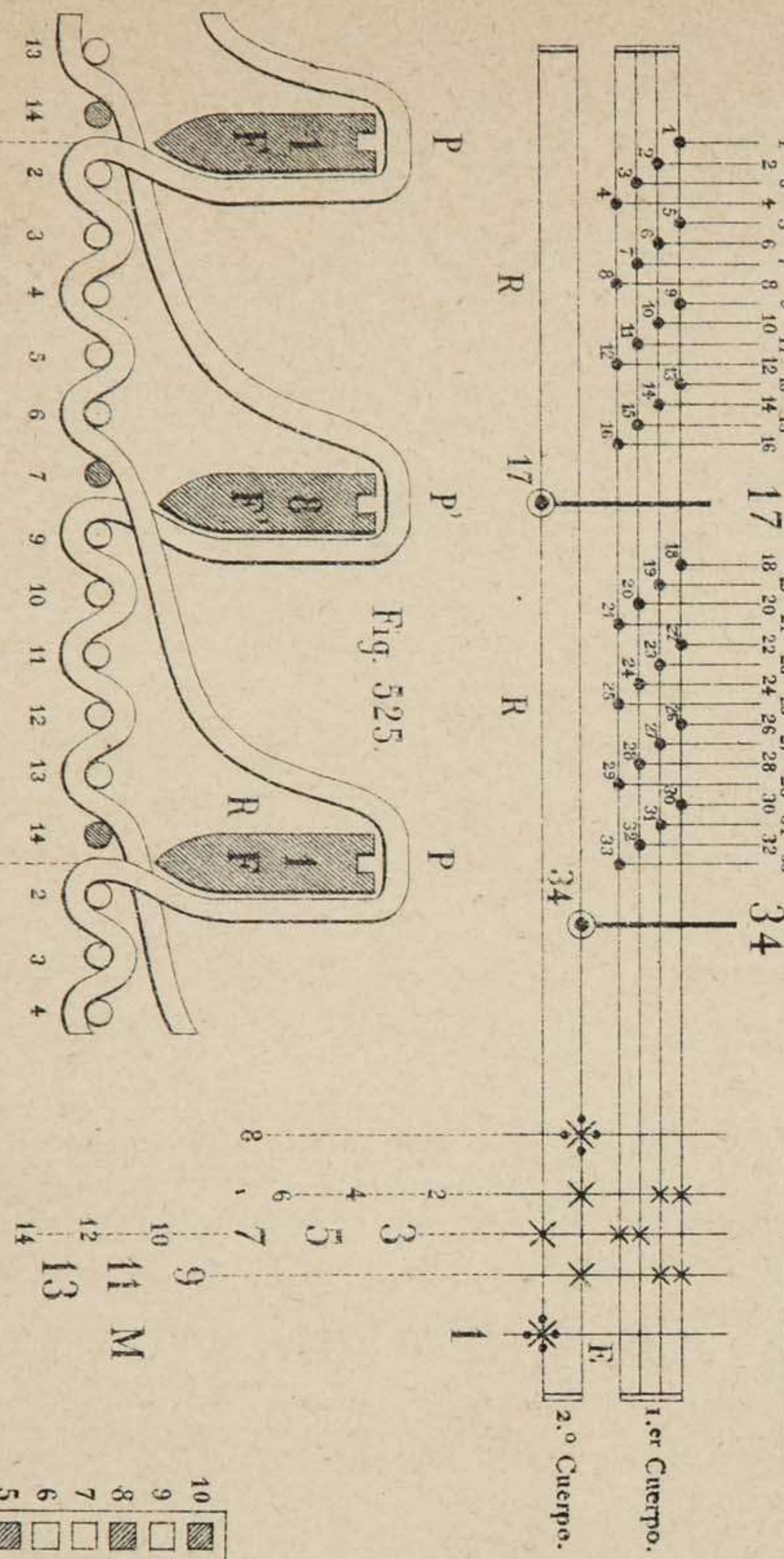


Fig. 525.

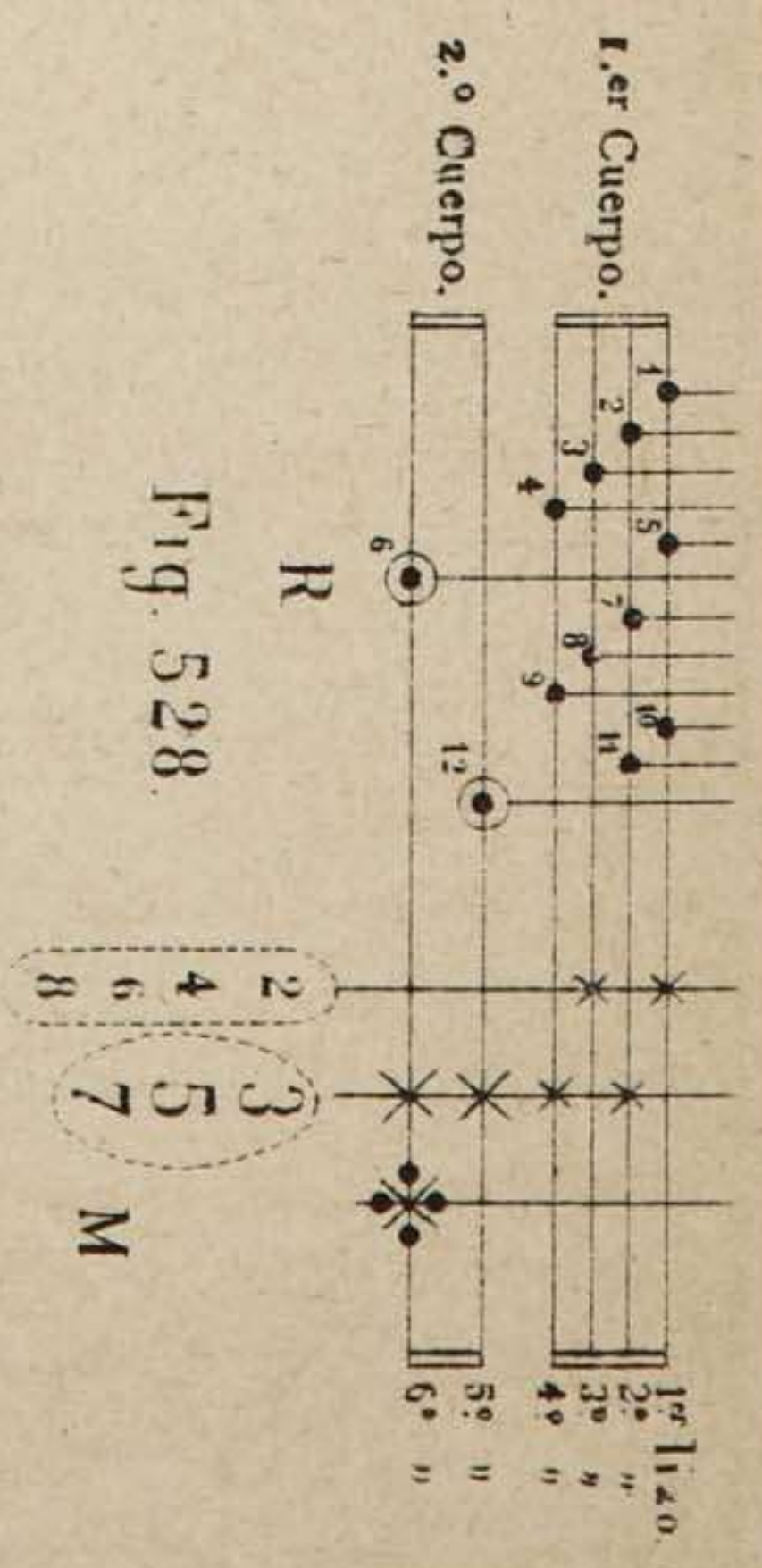


Fig. 528.

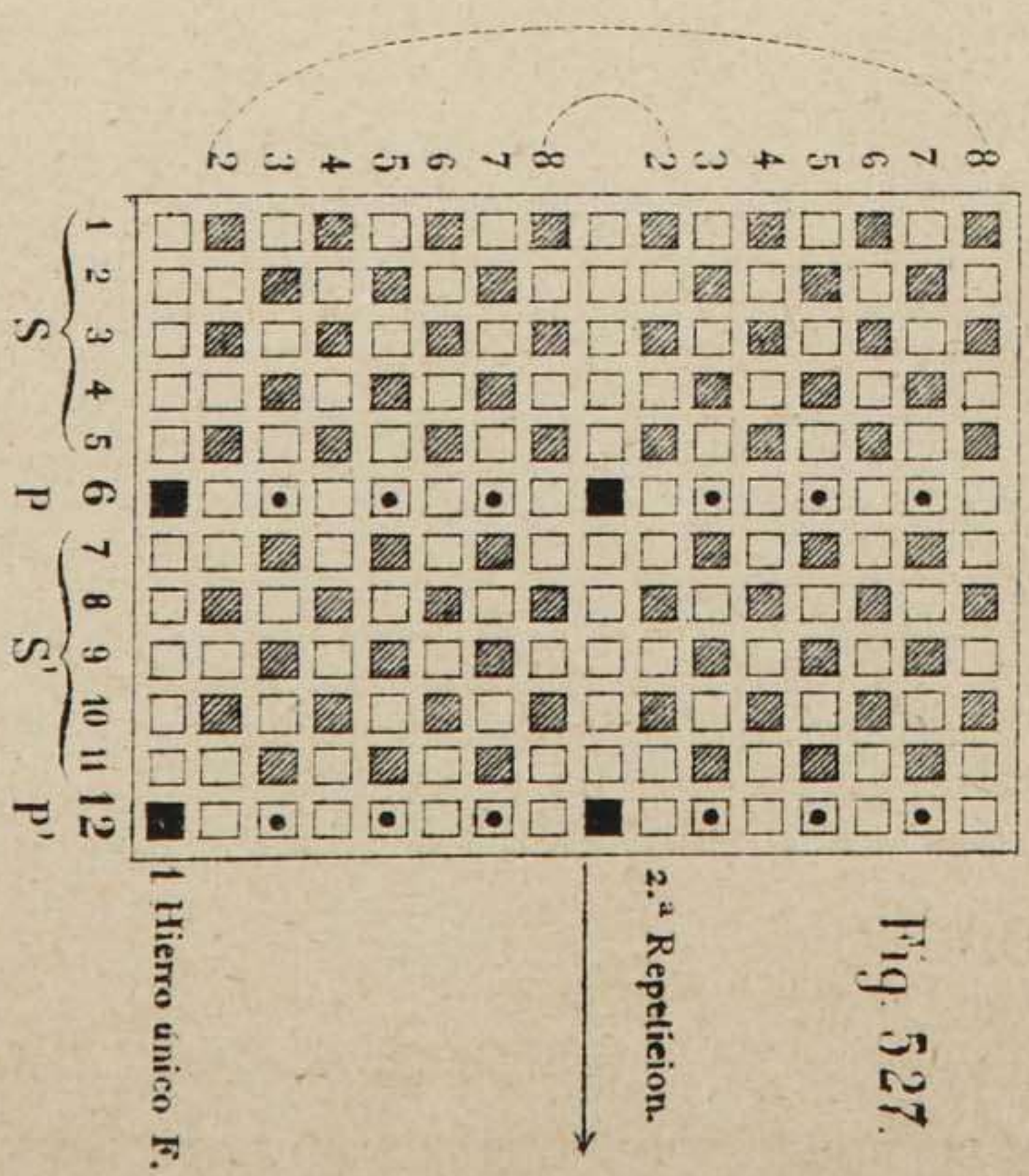


Fig. 527.

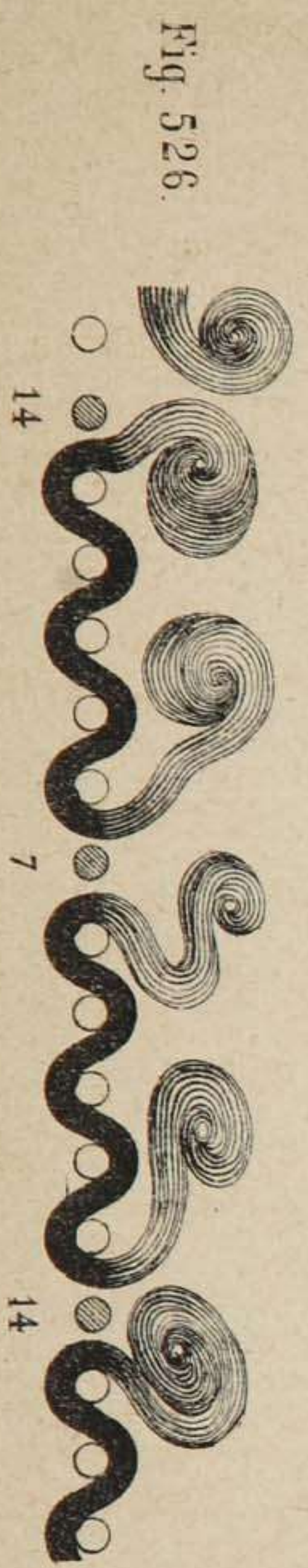


Fig. 526.

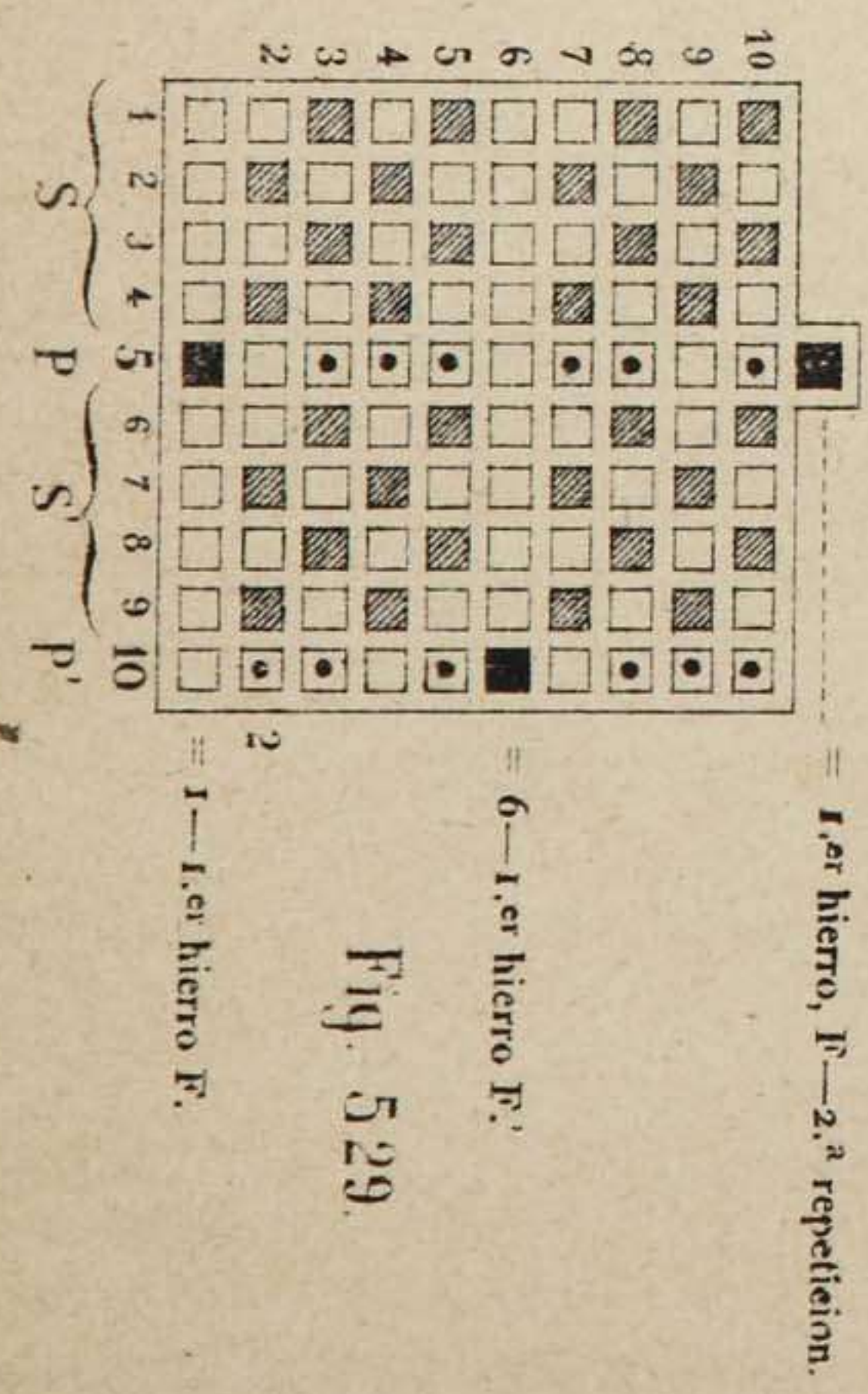


Fig. 529.

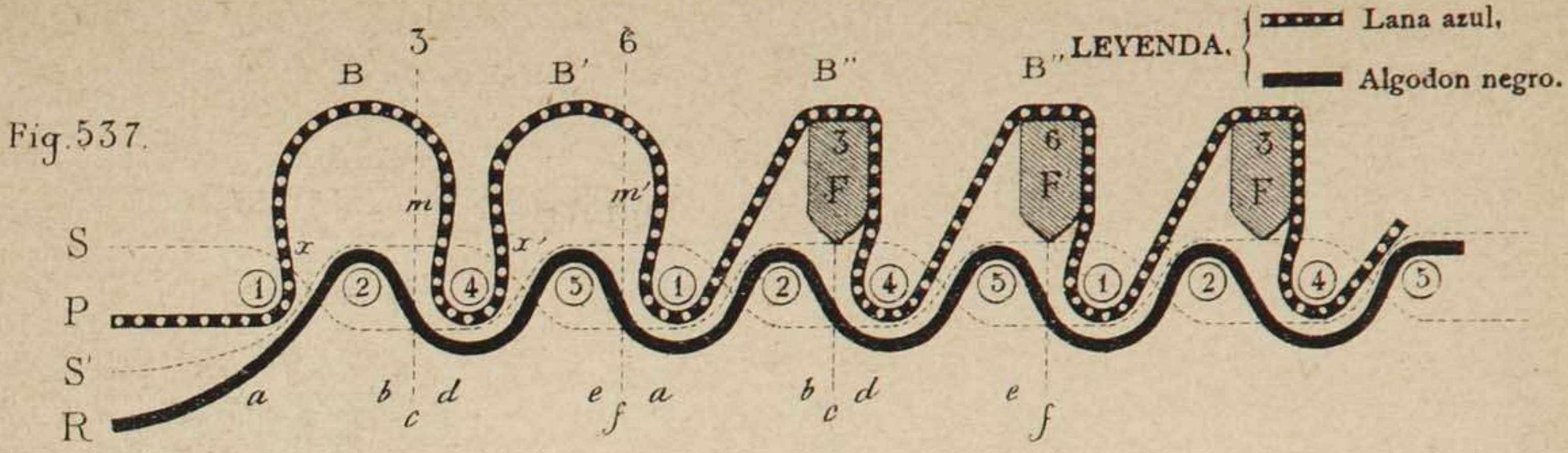


Fig. 533.

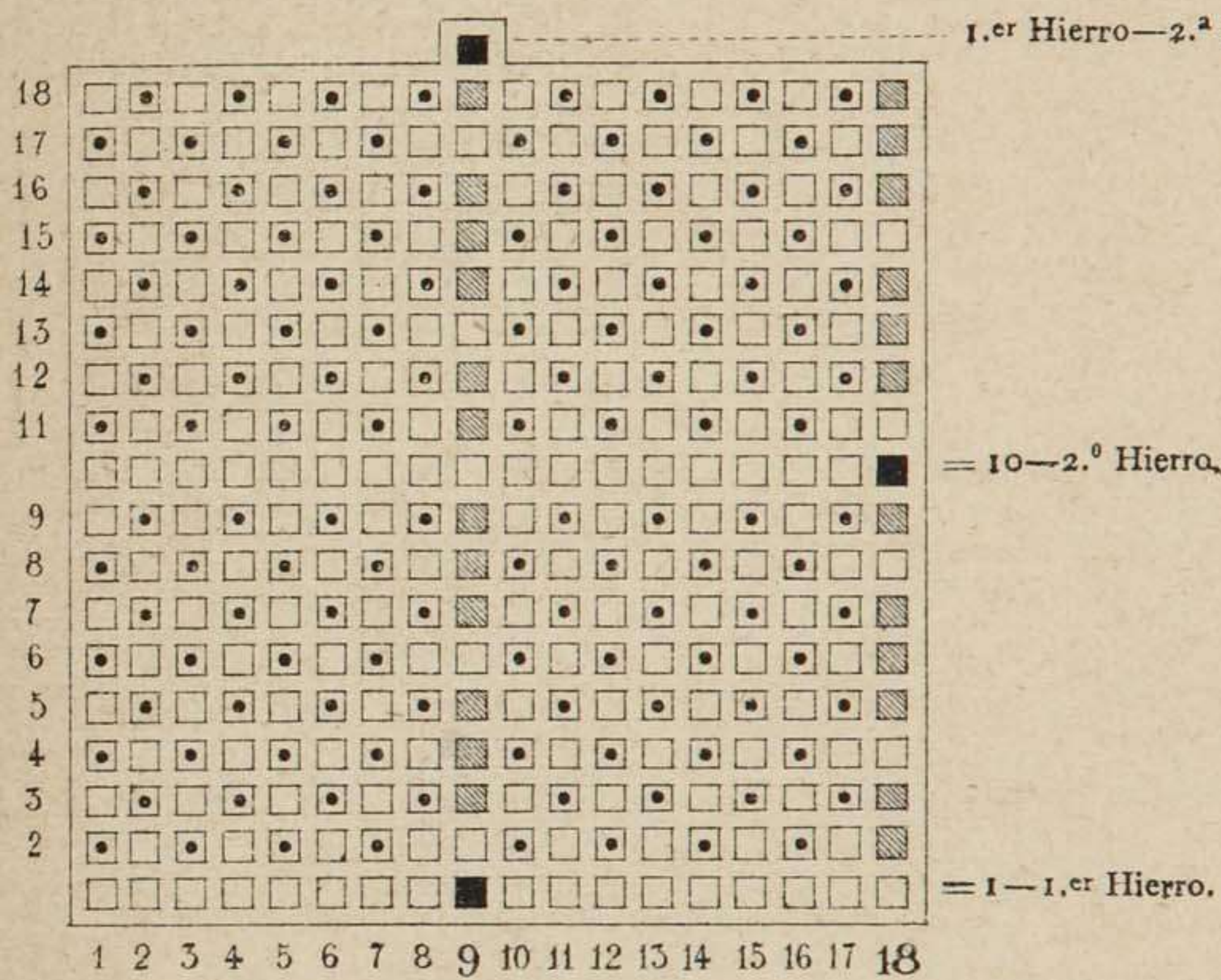


Fig. 532.

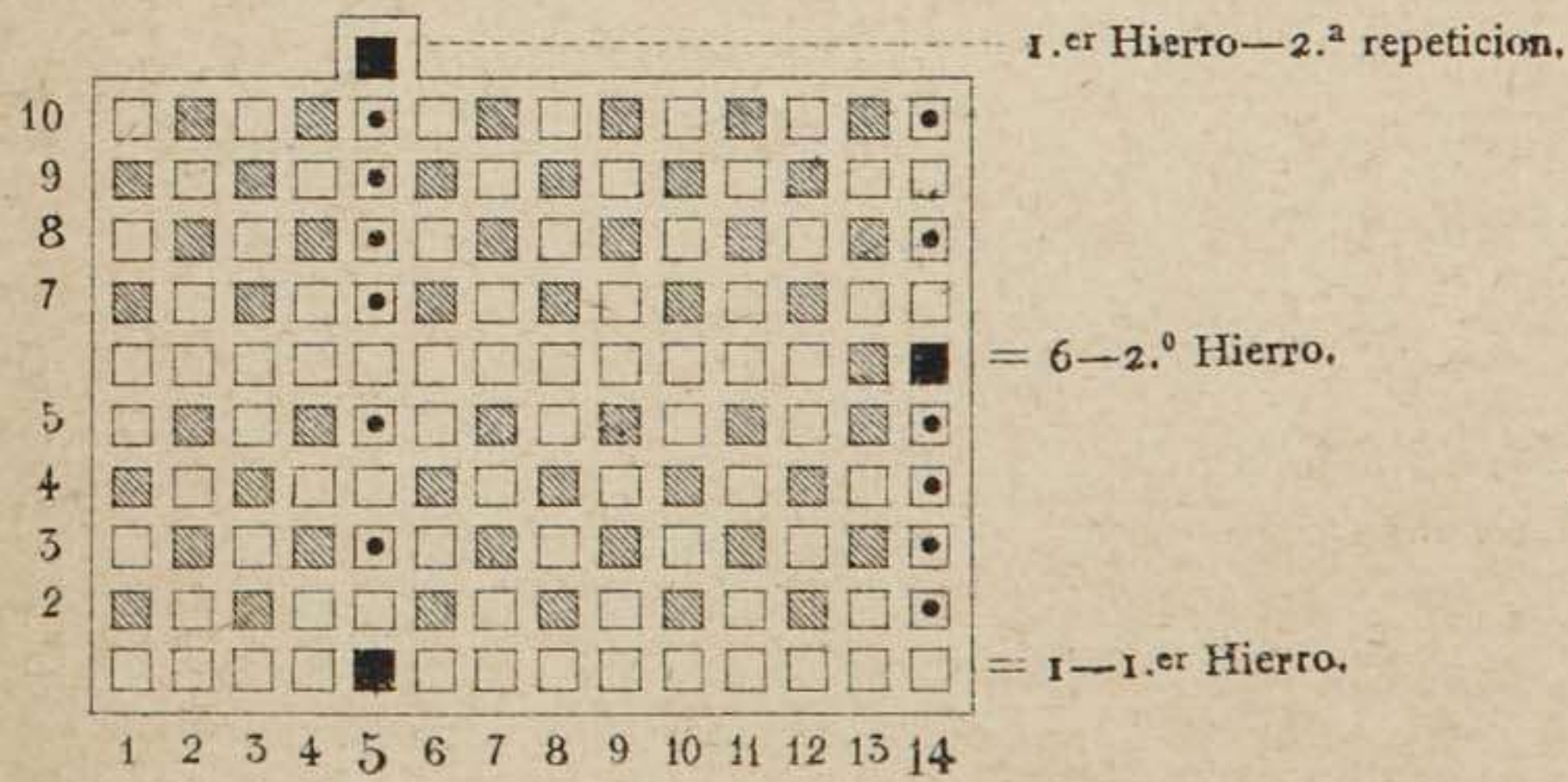


Fig. 530.

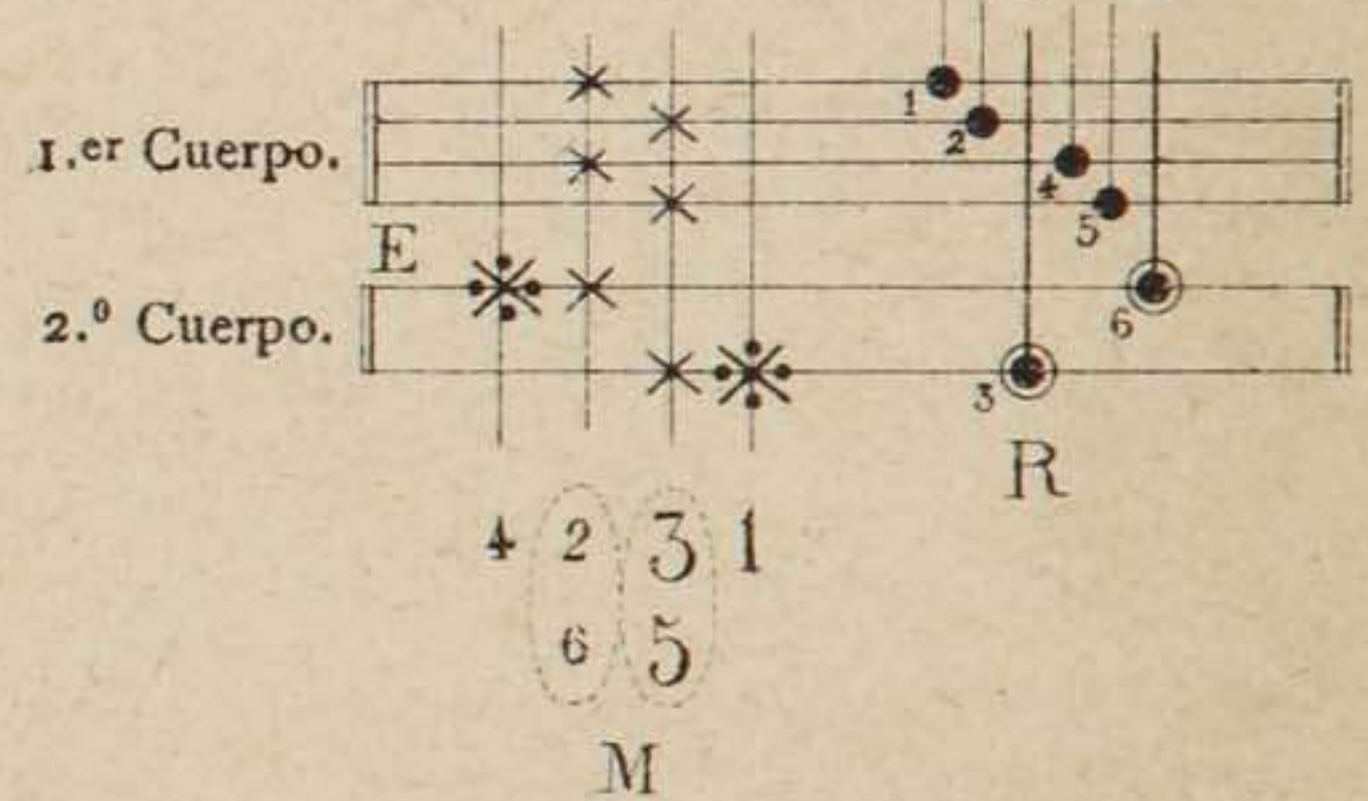
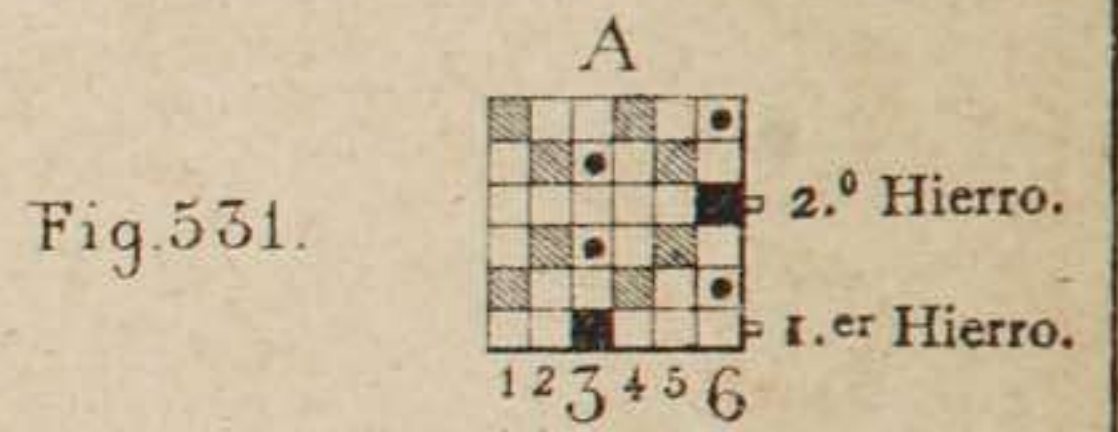
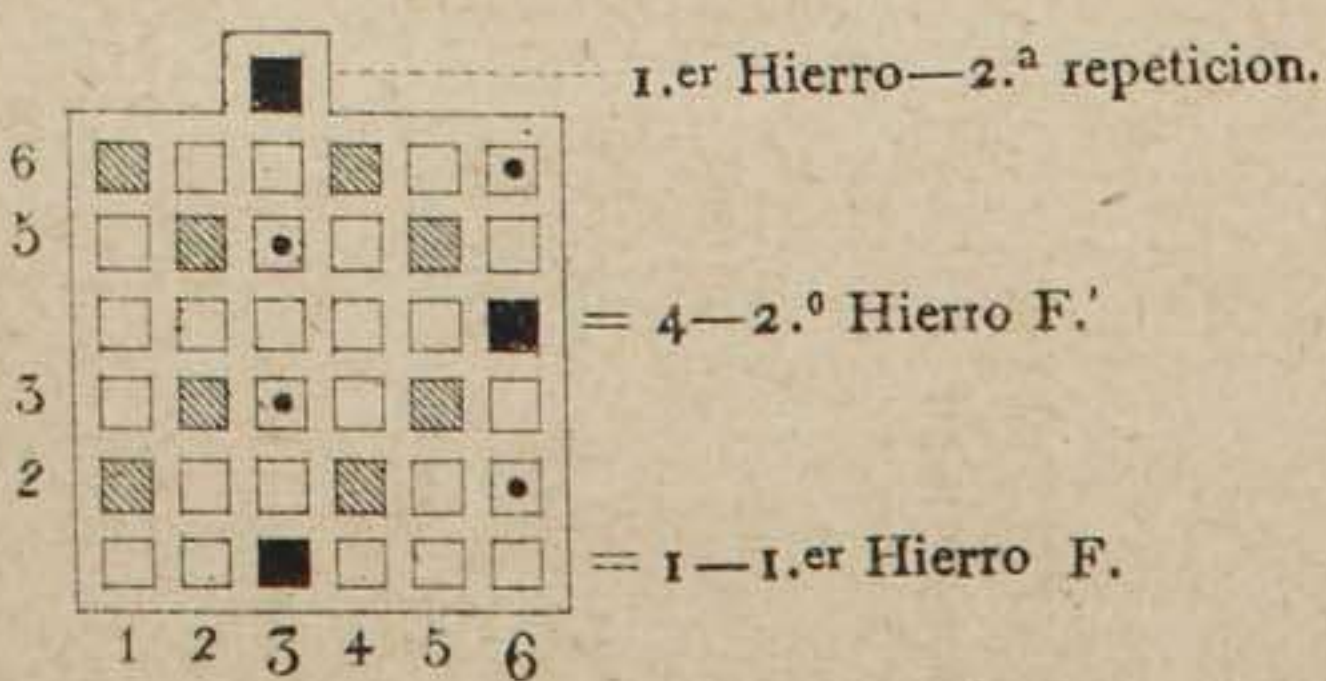


Fig. 536.

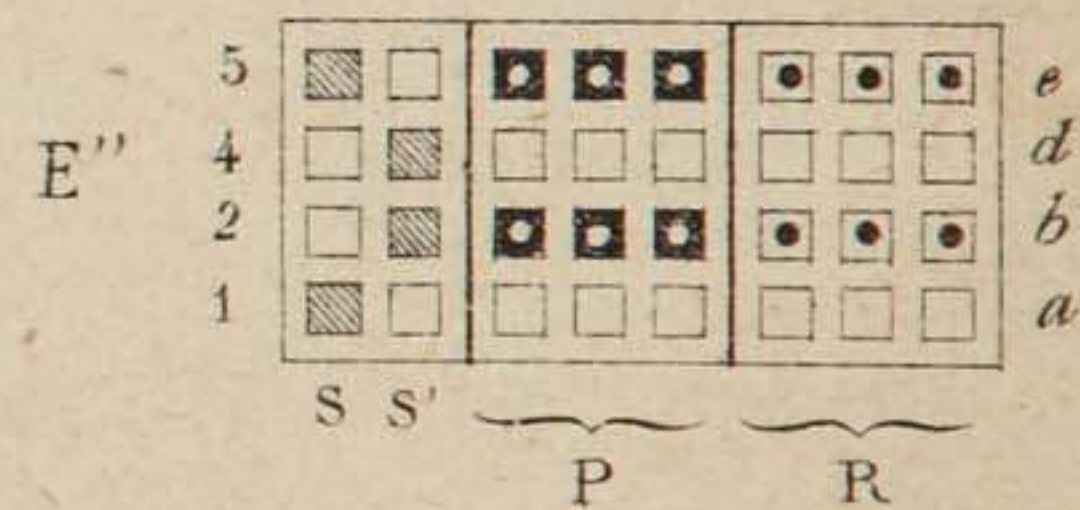


Fig. 535.

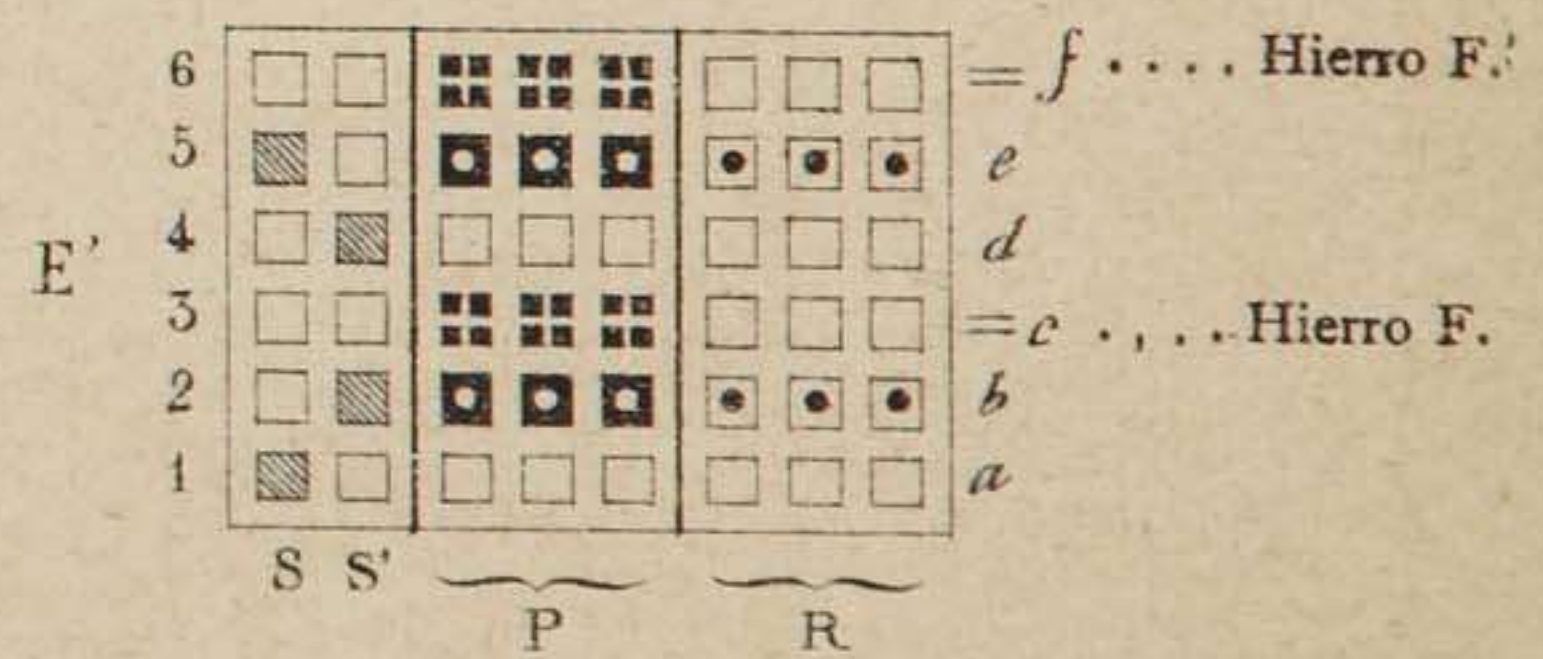
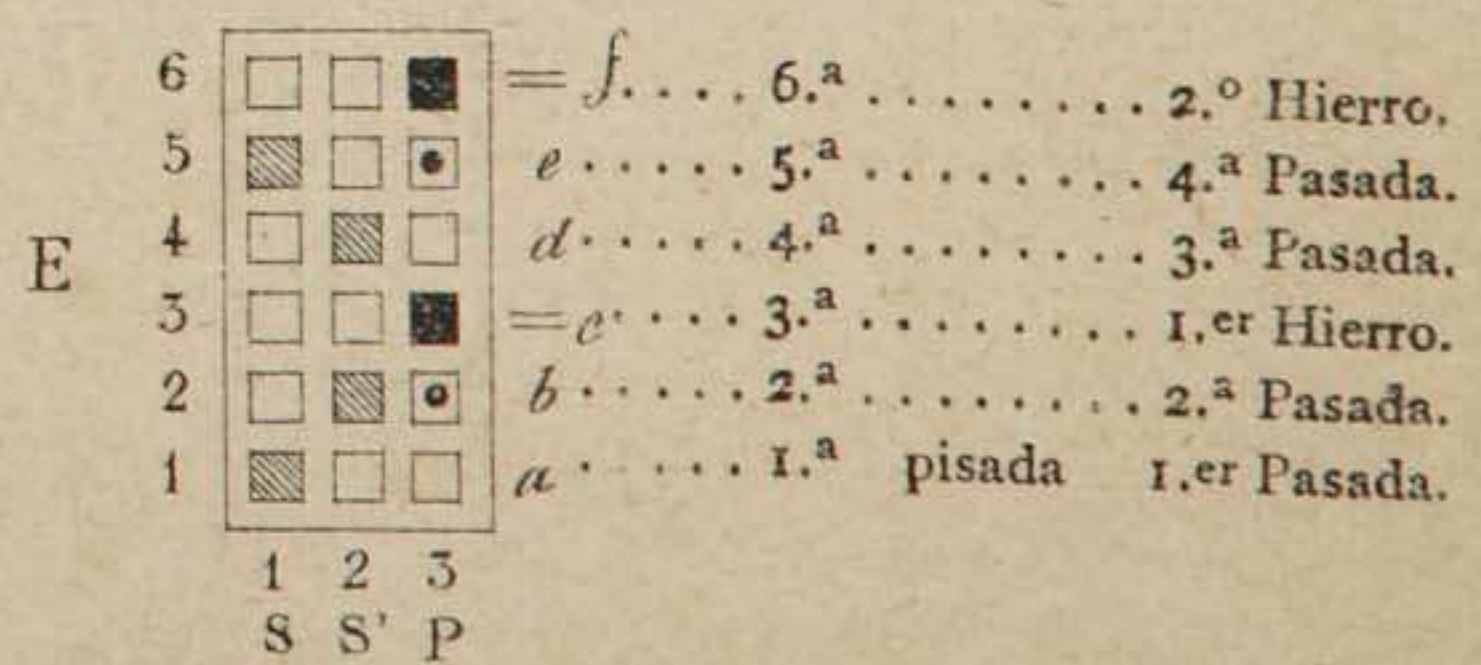


Fig. 534.



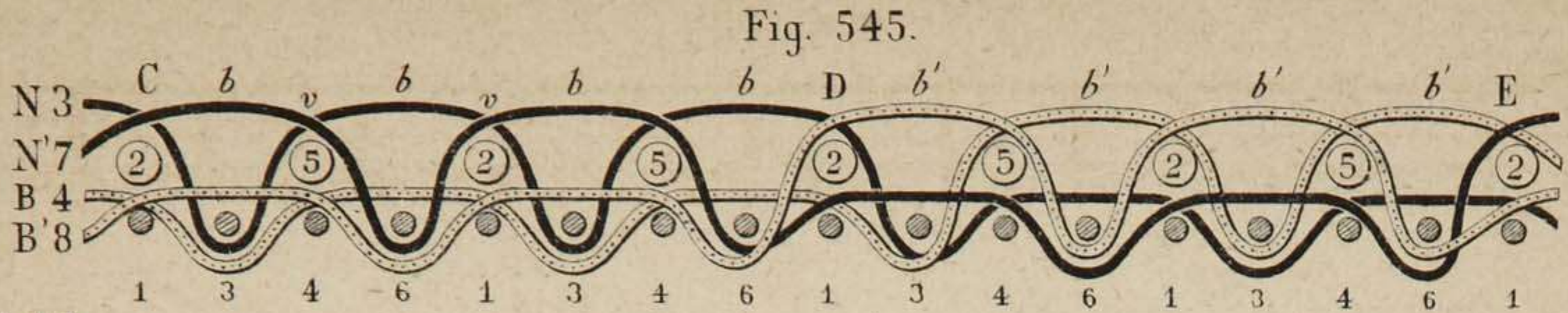
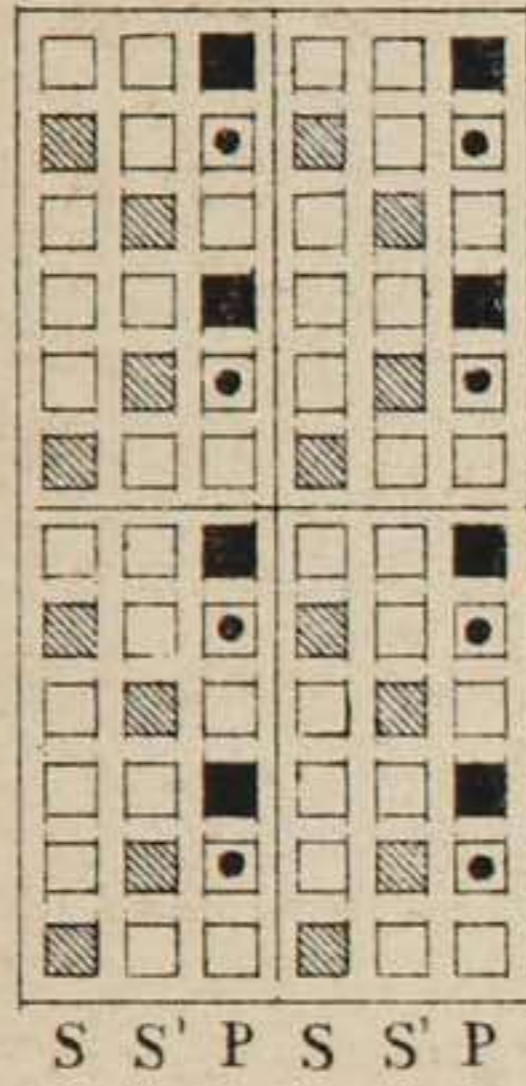


Fig. 543.



S'''

Fig. 542.



f... 2.º Hierro.
e
d
c... 1.er Hierro.
b
a

LEYENDA.

- Fig. 549. Lana negra.
- Lana azul.
- Fig. 545. Lana negra.
- Lana azul.

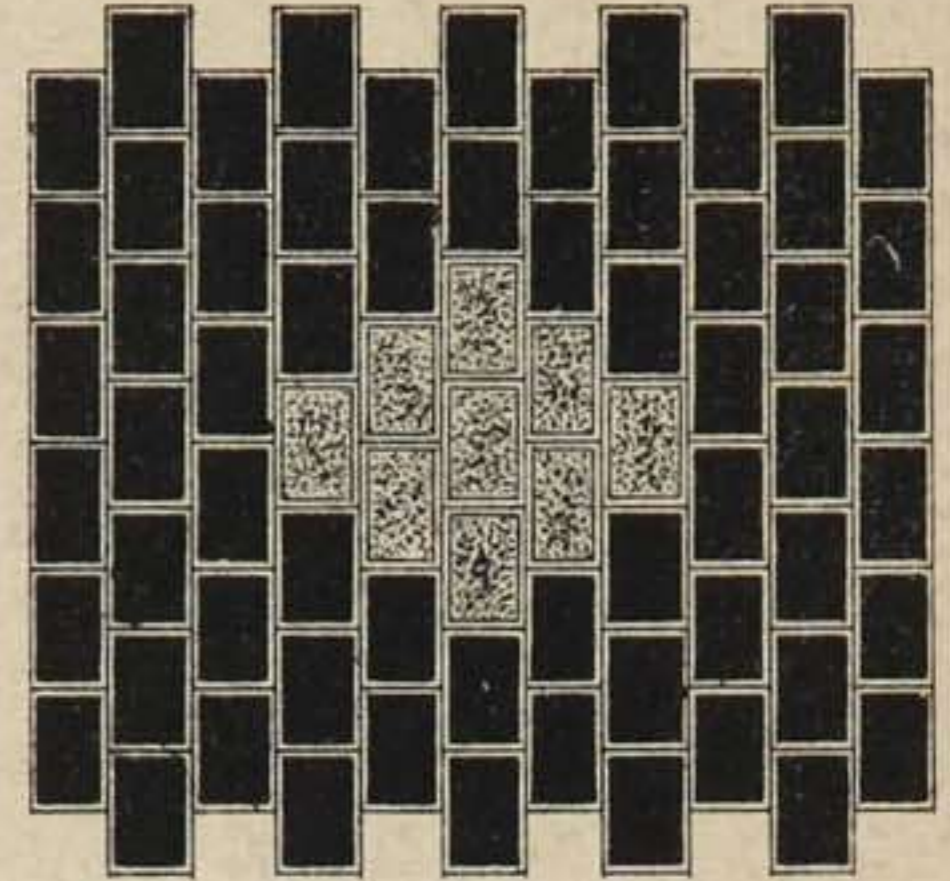
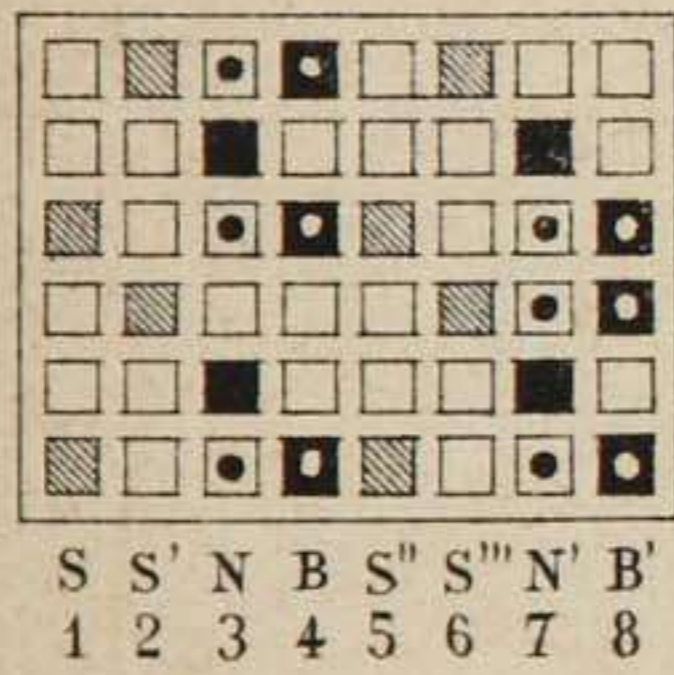


Fig. 549.

T



6
5... 2.º Hierro.
4
3
2... 1.er Hierro.
1

Fig. 544.

E

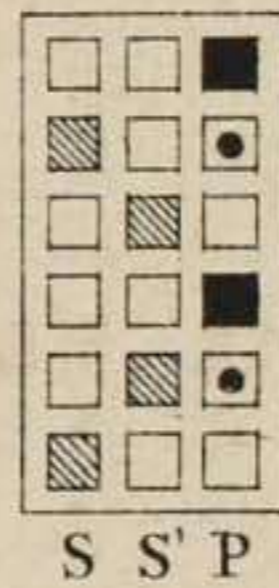
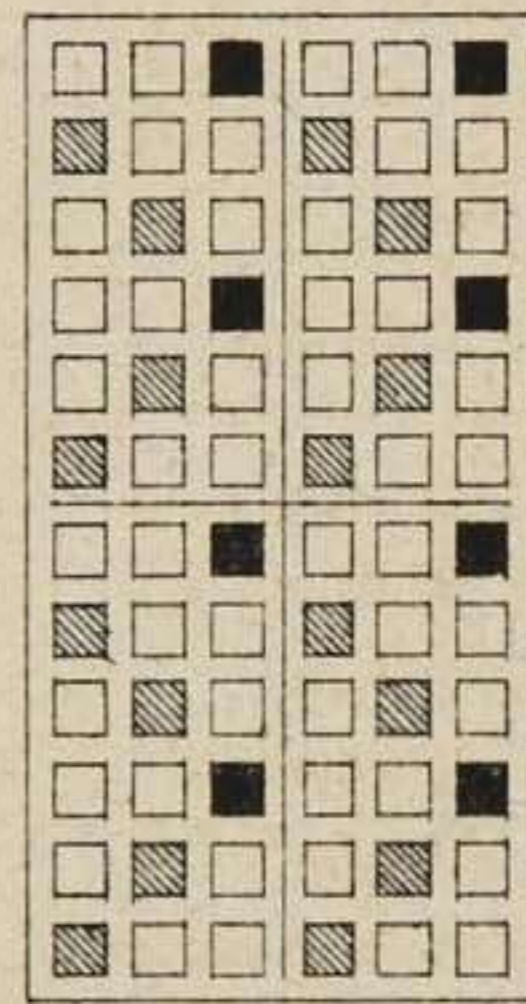


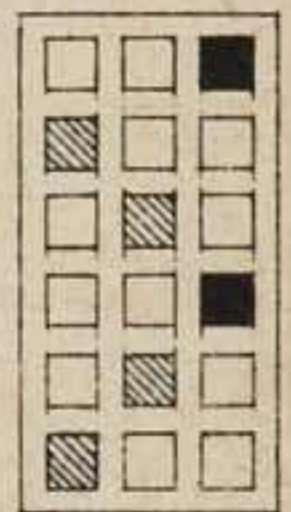
Fig.

S'

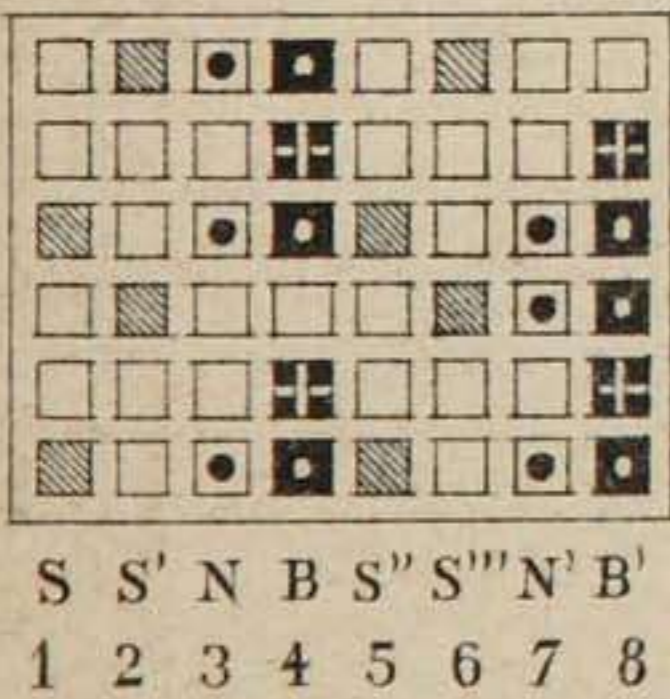


541.

S''



T'



6
5... 2.º Hierro.
4
3
2... 1.er Hierro.
1

Fig. 546.

FONDO DEL DISEÑO T.

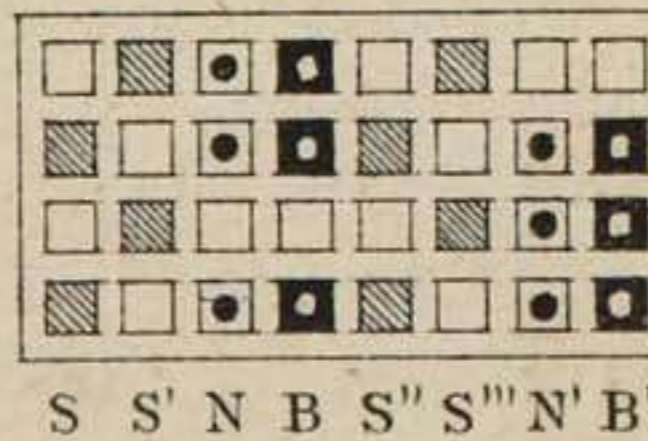


Fig. 547.

FONDO DEL DISEÑO T'.

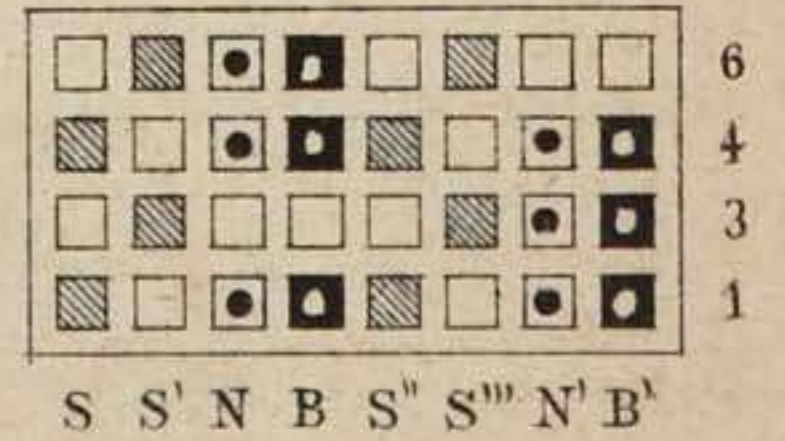


Fig. 538.

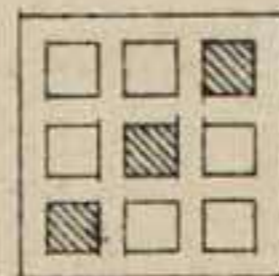


Fig. 539.

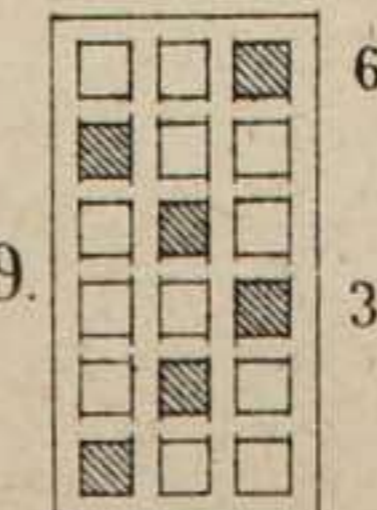
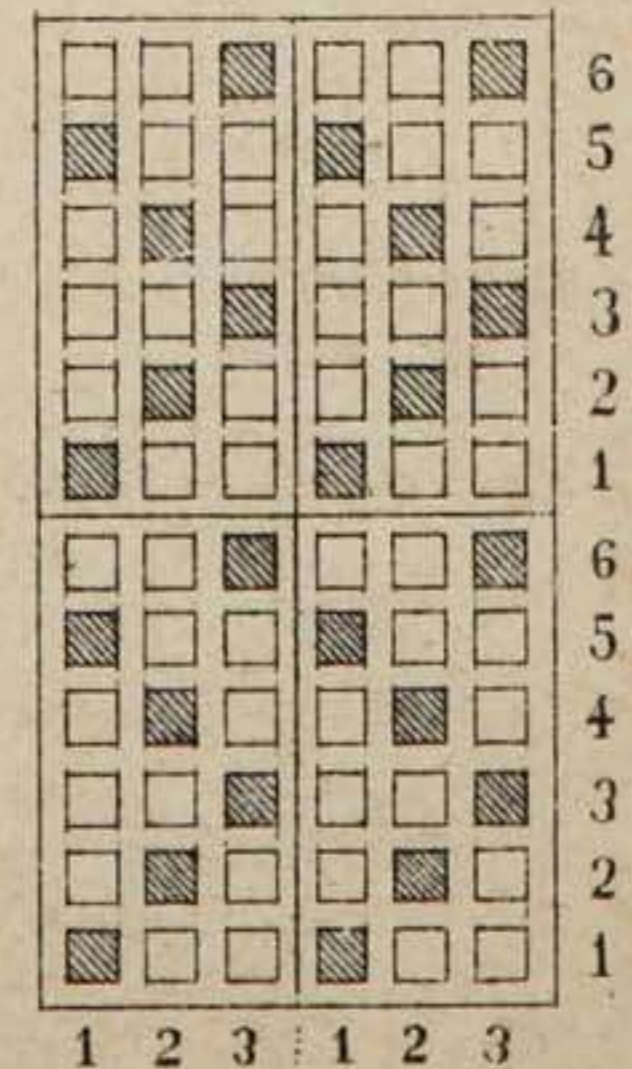


Fig. 540.



T''

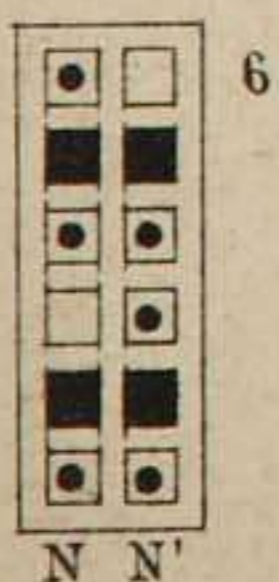


Fig. 548.

T'''

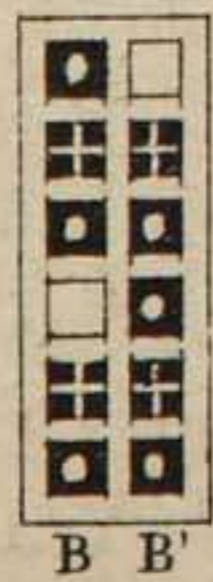


Fig. 559.

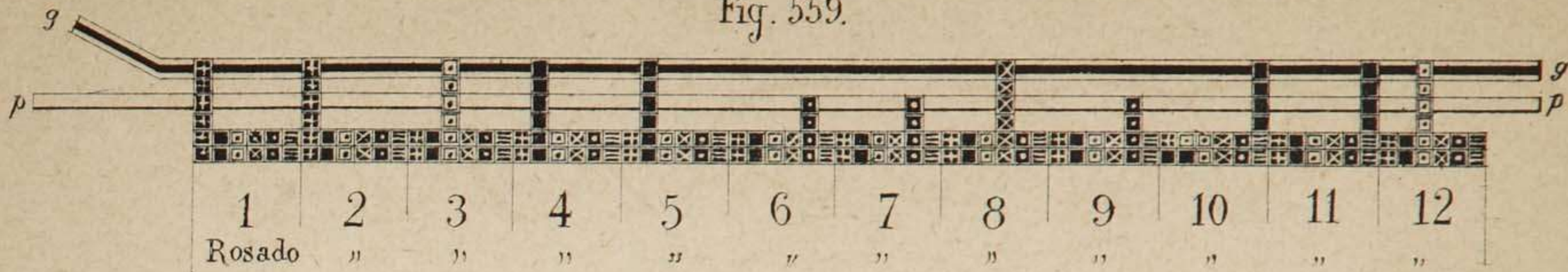


Fig. 554.

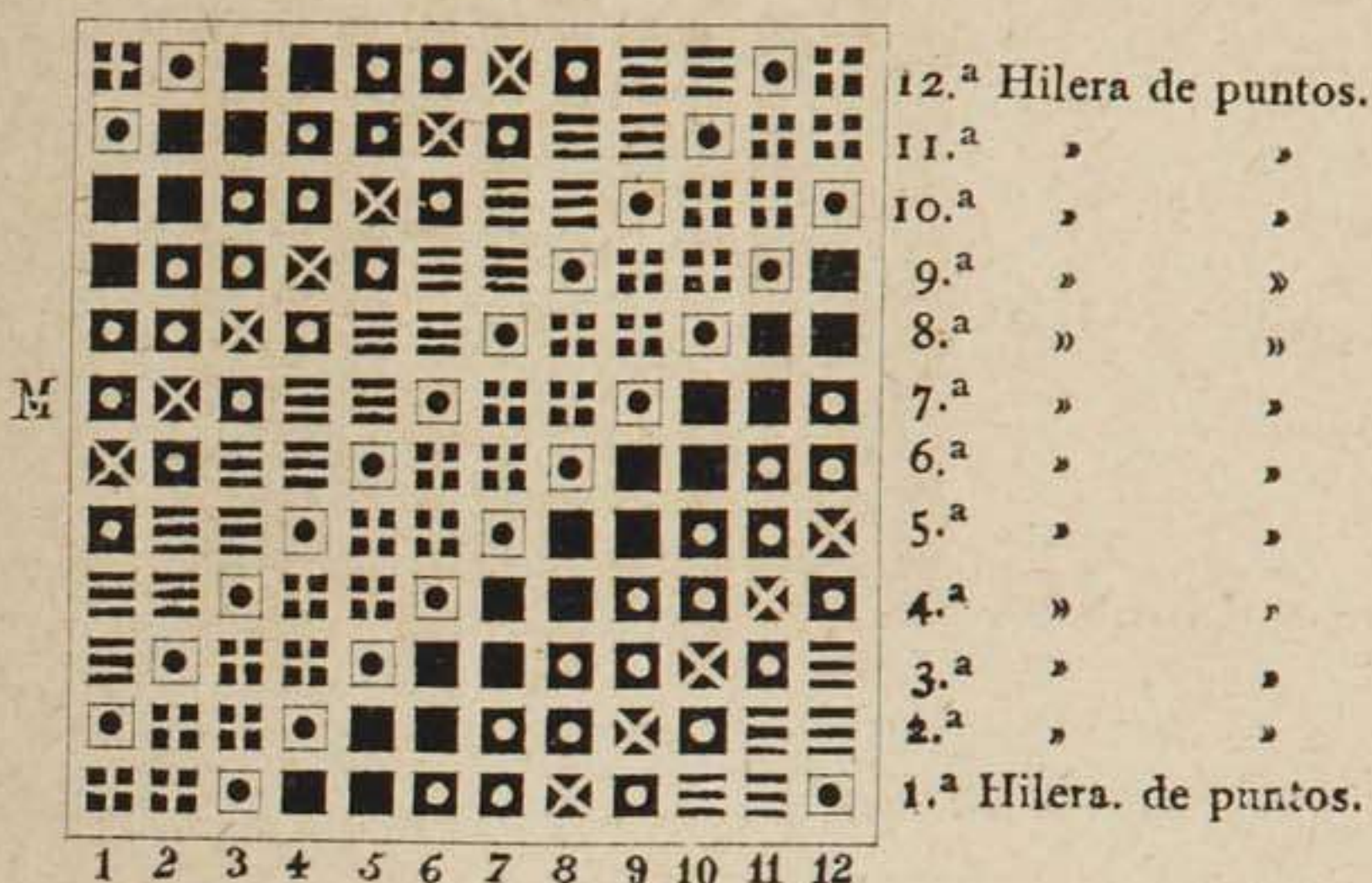


Fig. 552.

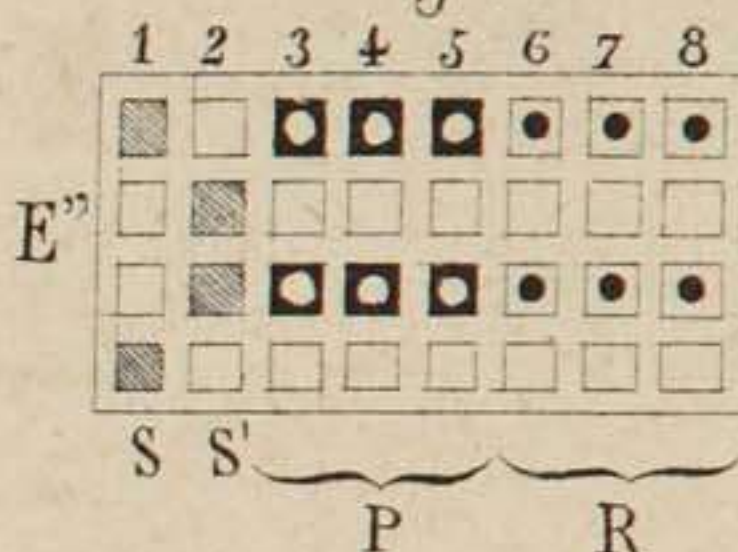


Fig. 553.

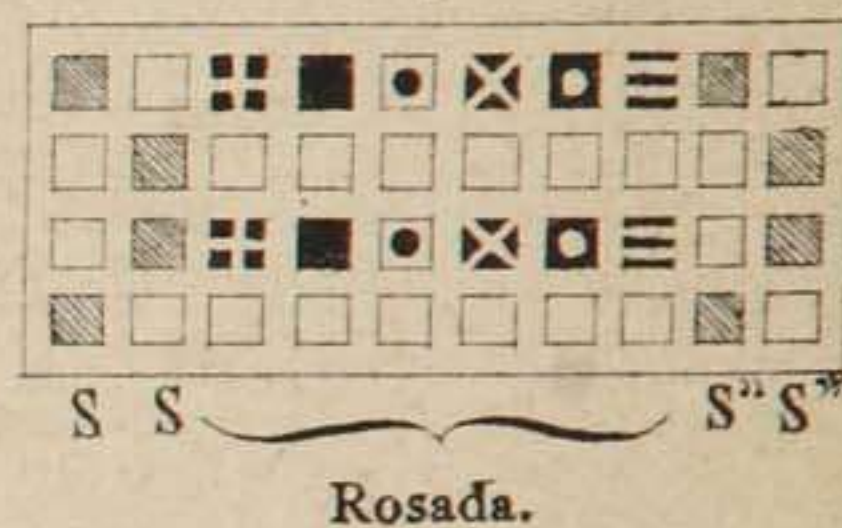


Fig. 551.

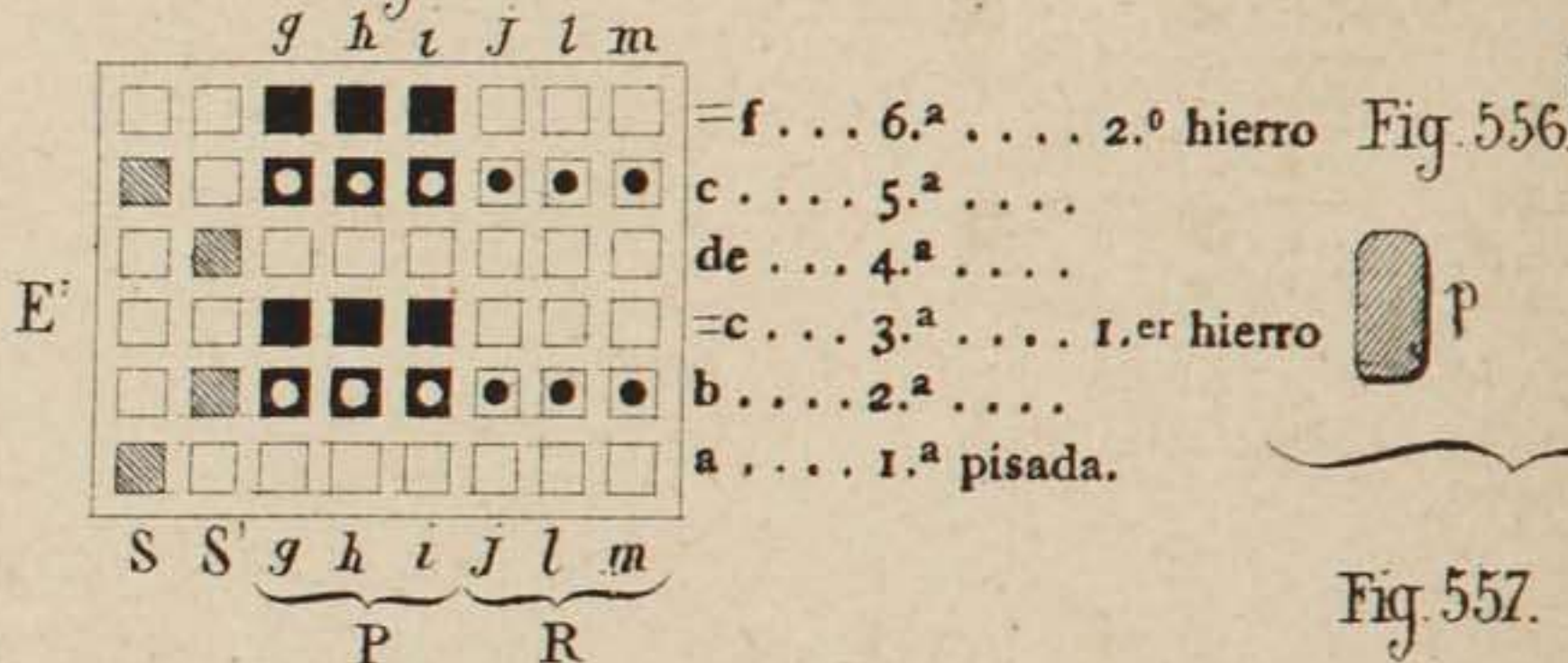


Fig. 555.

LEYENDA DE LOS COLORES.

- 1º ■■ Signo convencional del rojo.
- 2º ■ " " del negro.
- 3º ● " " del verde.
- 4º ⊗ " " del amarillo.
- 5º ◻ " " del azul.
- 6º ≡ " " del de la madera.

Fig. 558.

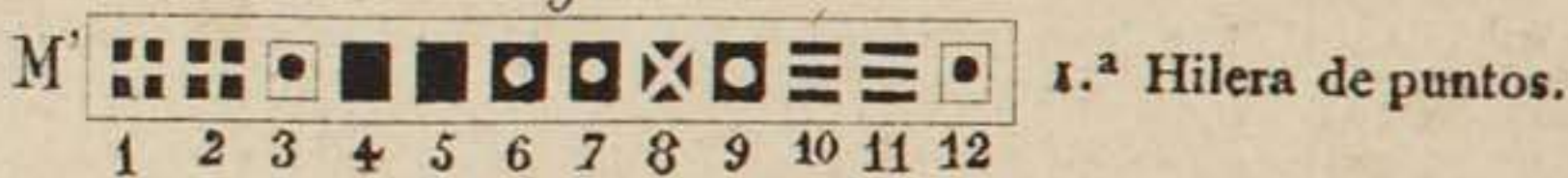
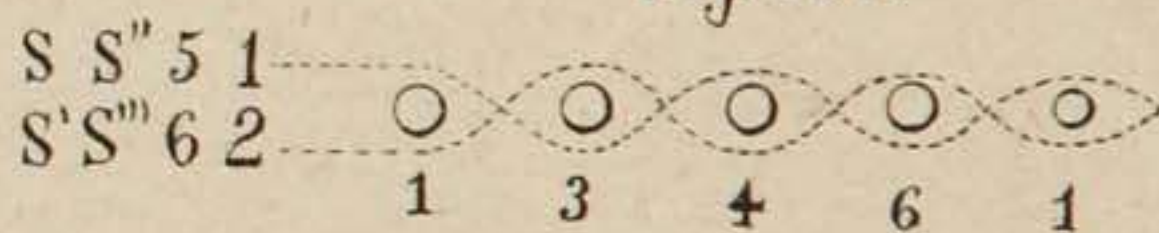


Fig. 550.



LEYENDA de los colores.

- Rojo.
- Negro.
- Verde.
- ⊗ Amarillo.
- ◻ Azul.
- ≡ Madera.

Fig. 560.

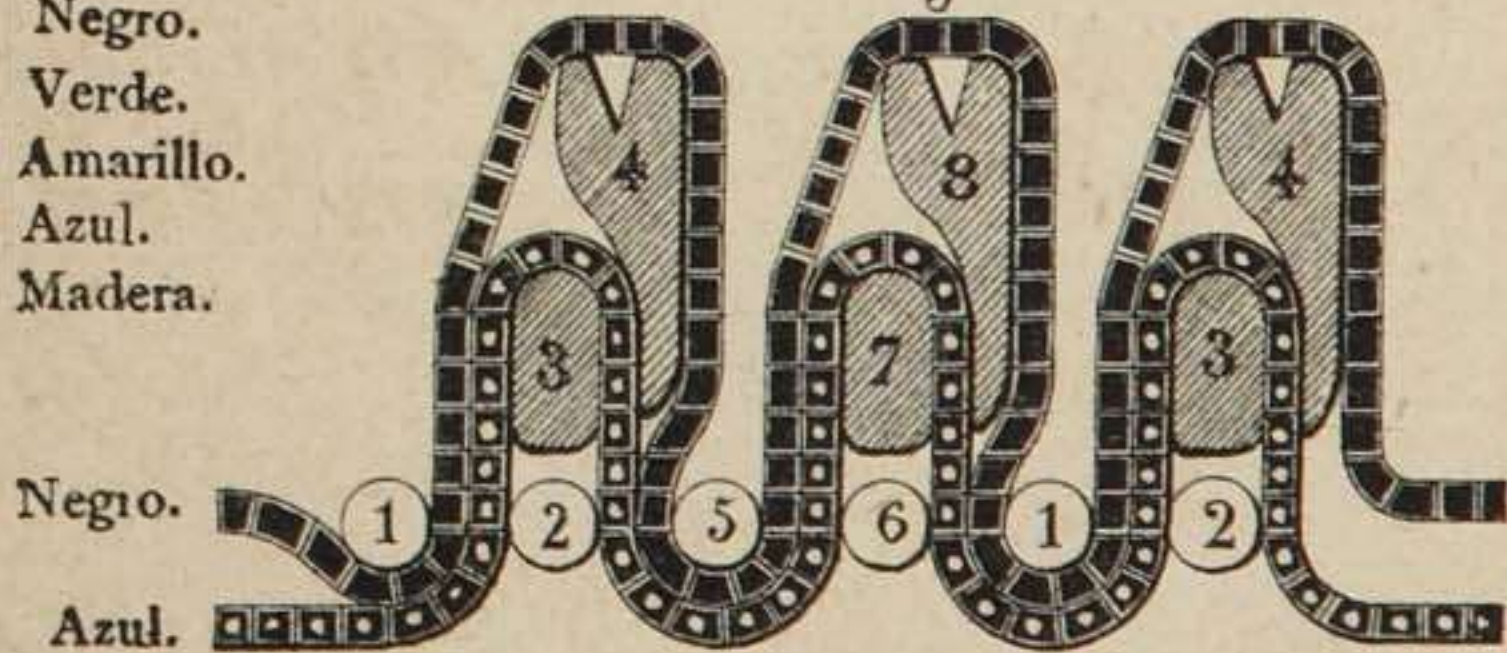


Fig. 561.

LEYENDA DE LOS COLORES.

- 1º ■■ Signo convencional del rojo.
- 2º ■ " " del negro.
- 3º ● " " del verde.
- 4º ⊗ " " del amarillo.
- 5º ◻ " " del azul.
- 6º ≡ " " del de la madera.

Fig. 564.

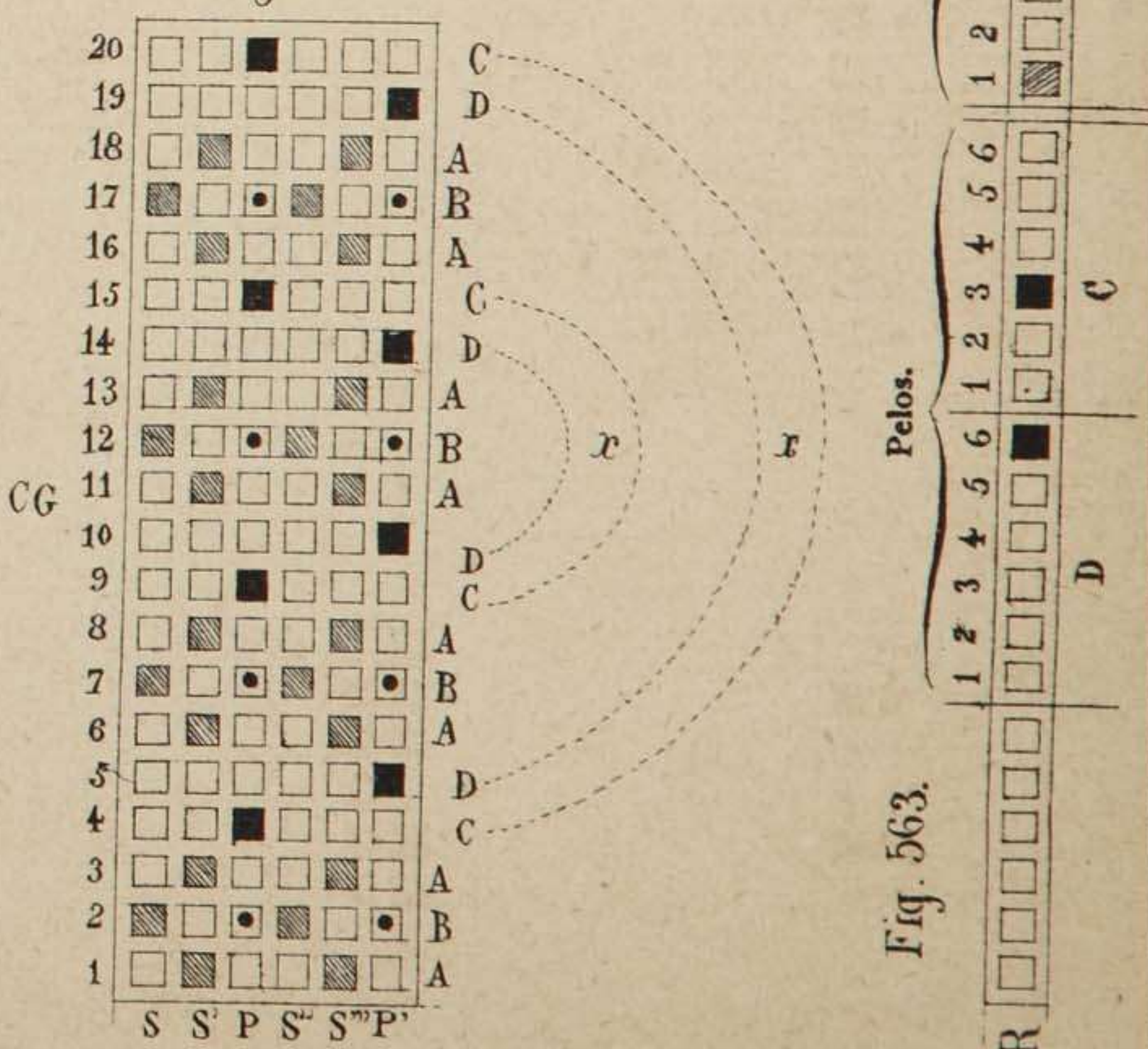
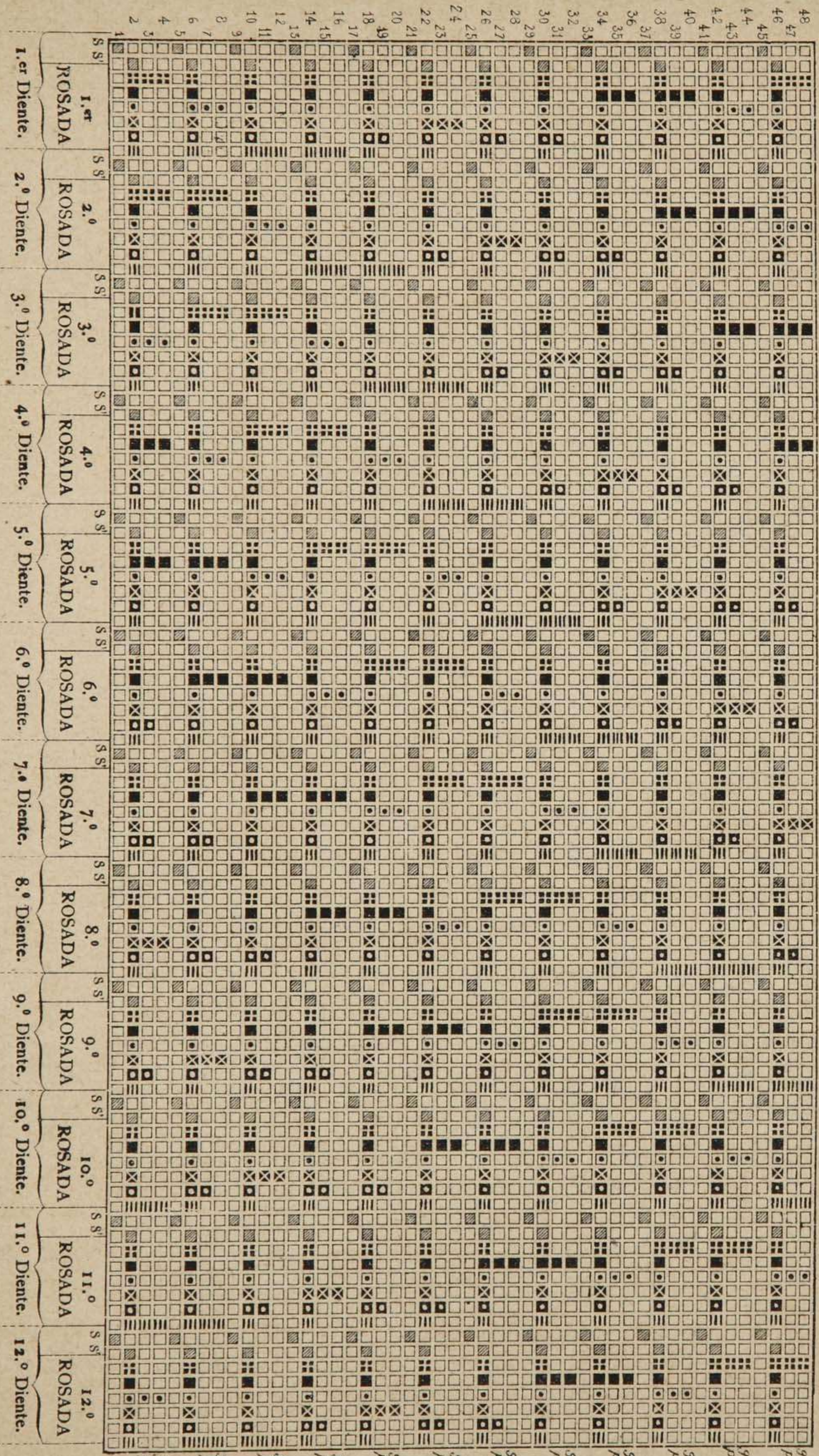


Fig. 563.

Fig. 562.

DISEÑO SINTETICO. M. G.



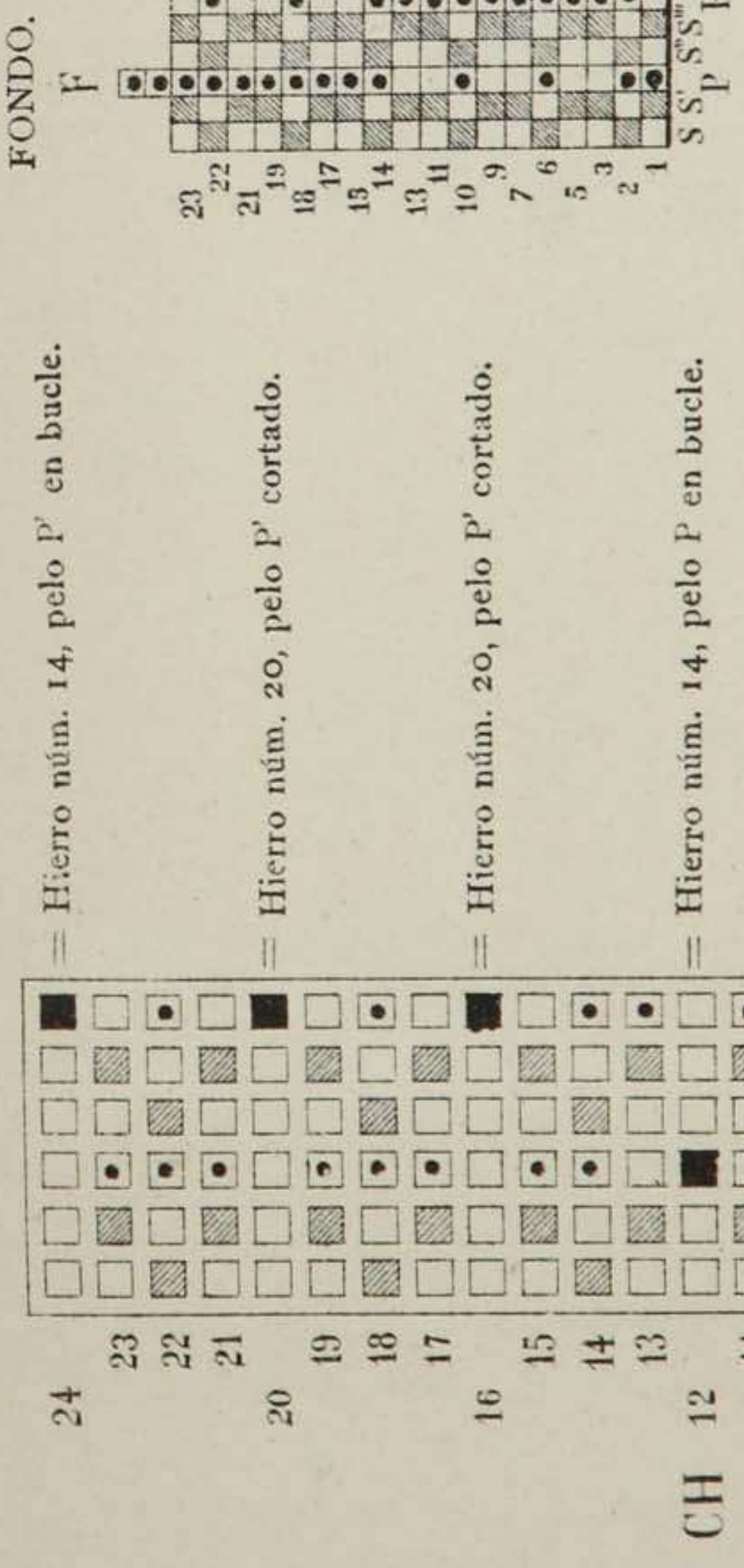


Fig. 570.

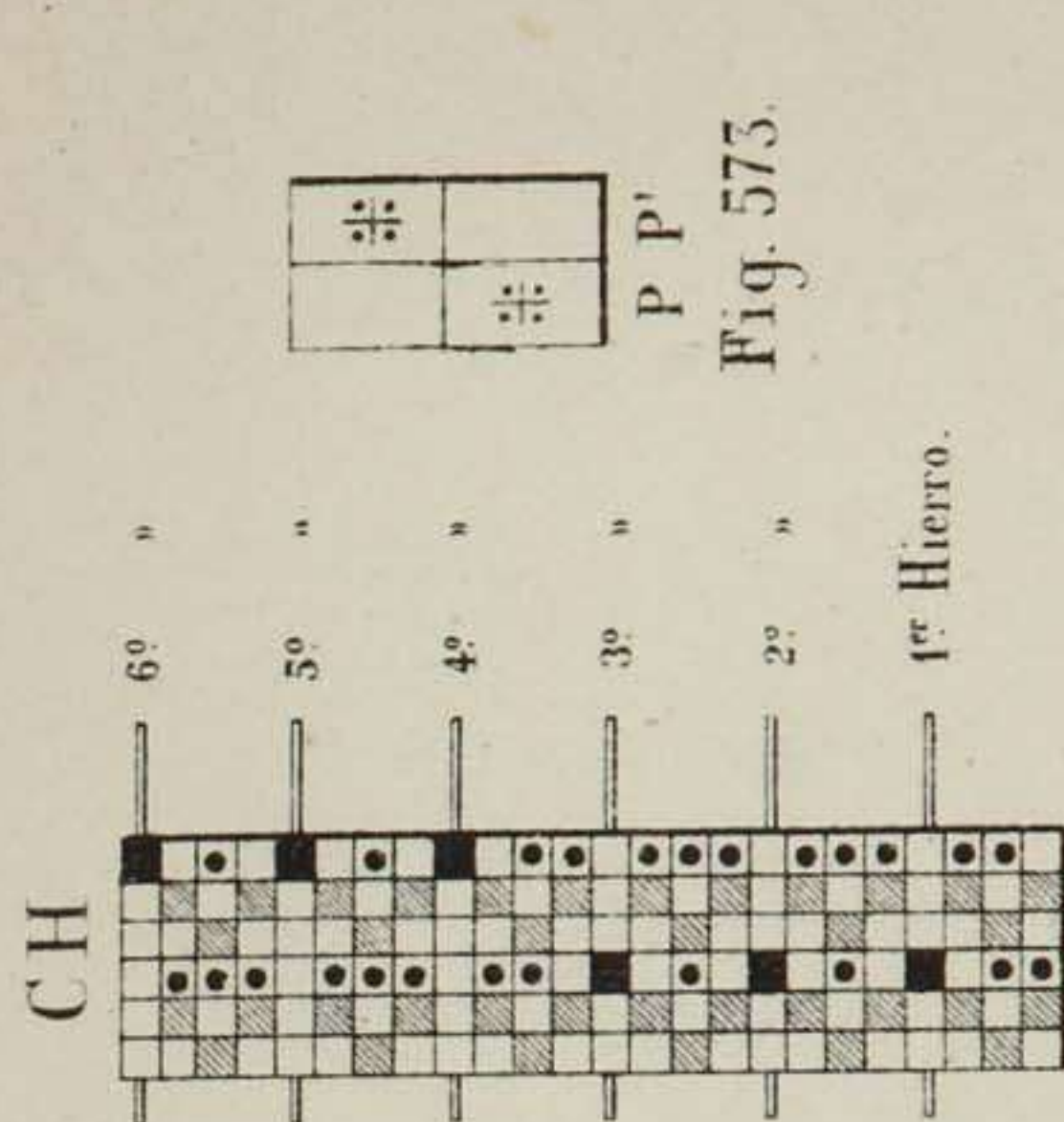


Fig. 573.

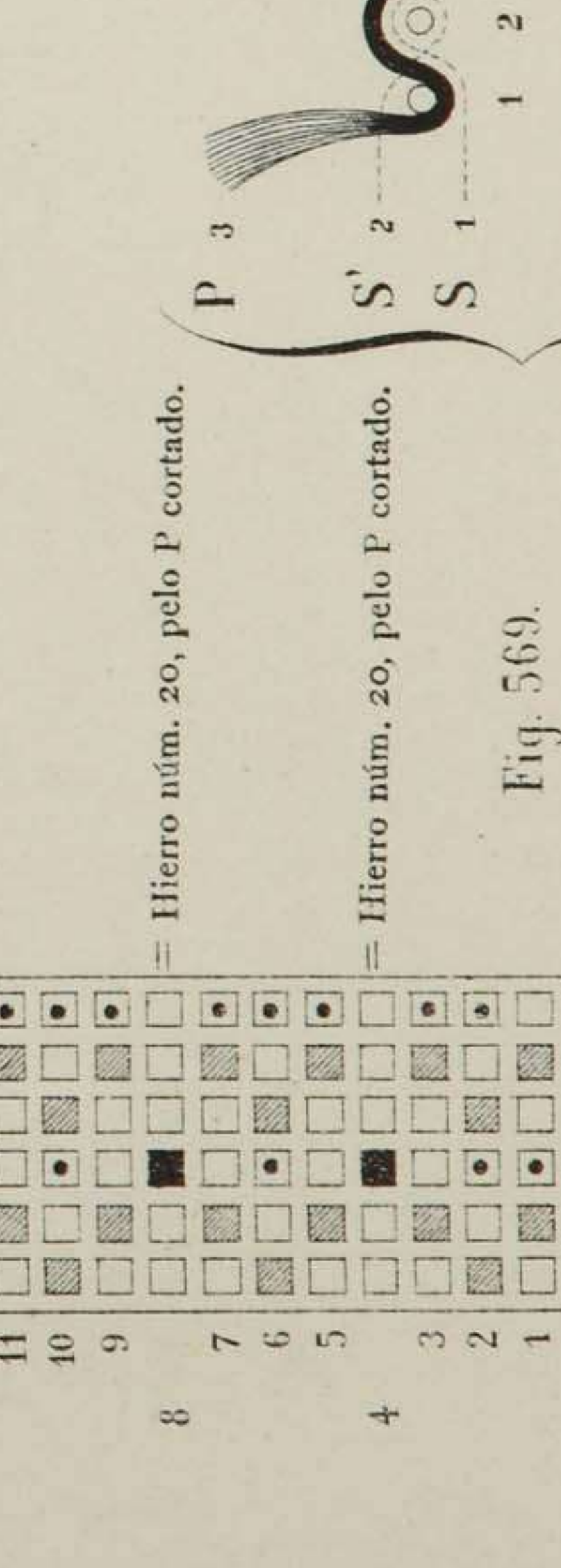


Fig. 569.

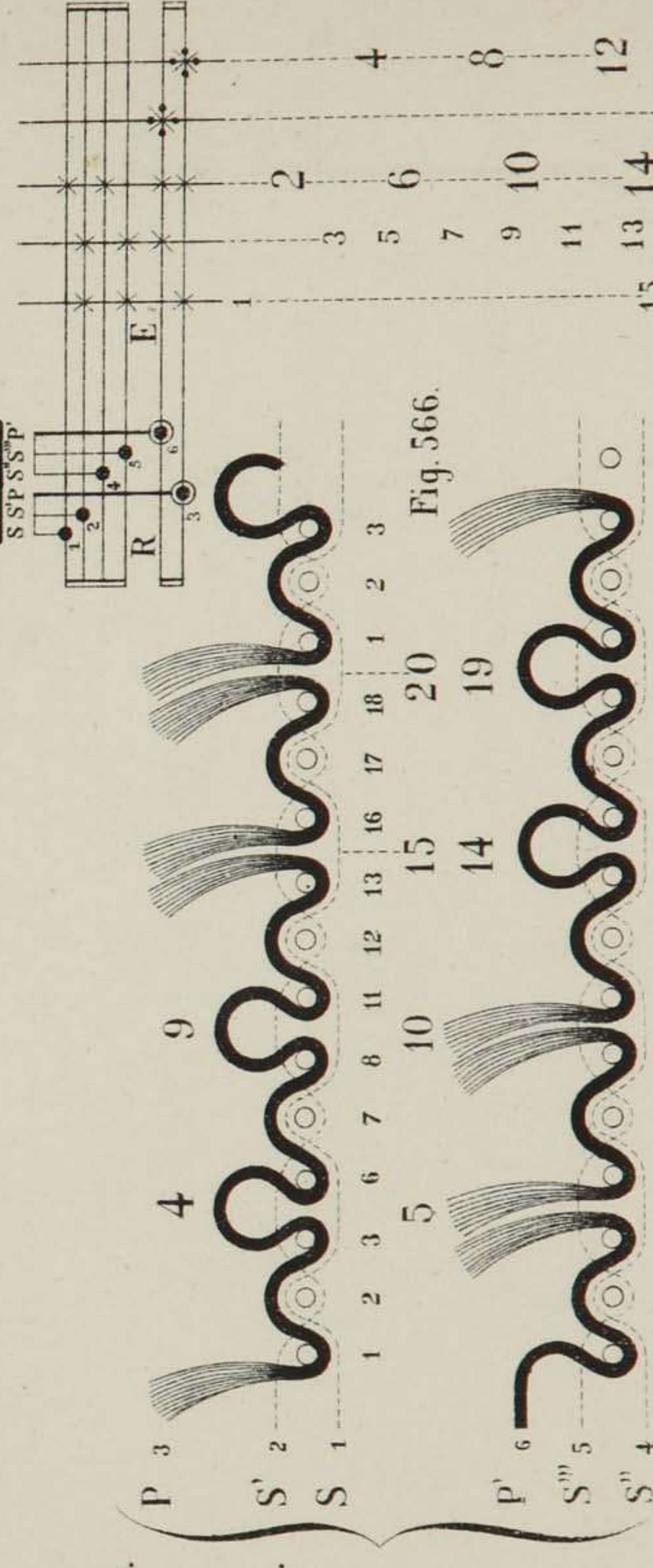


Fig. 566.

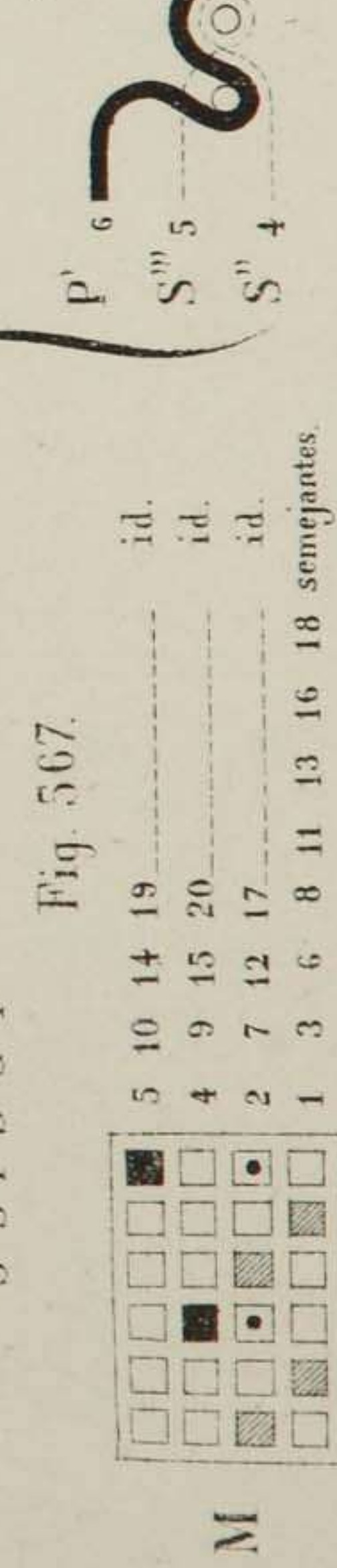


Fig. 567.

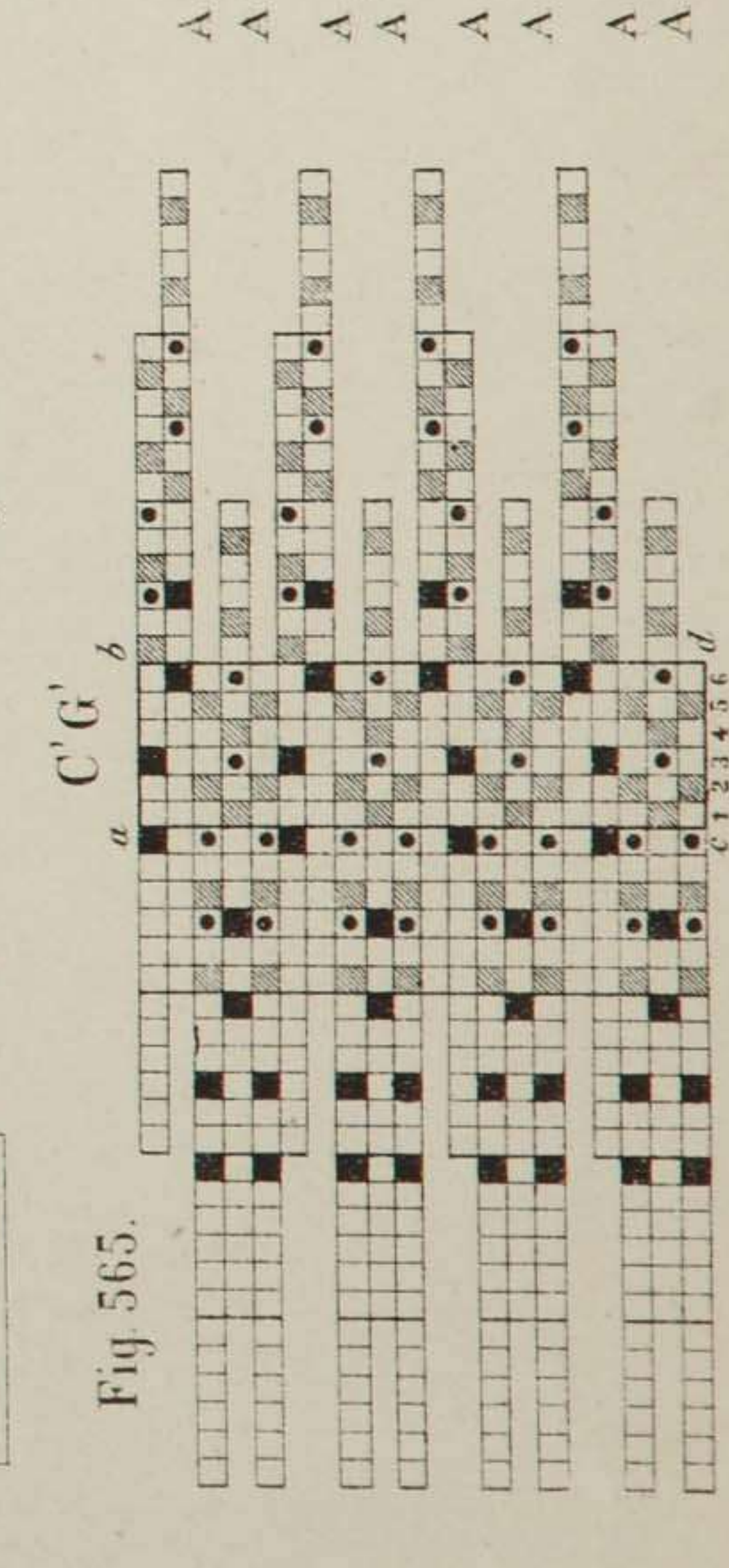


Fig. 565.

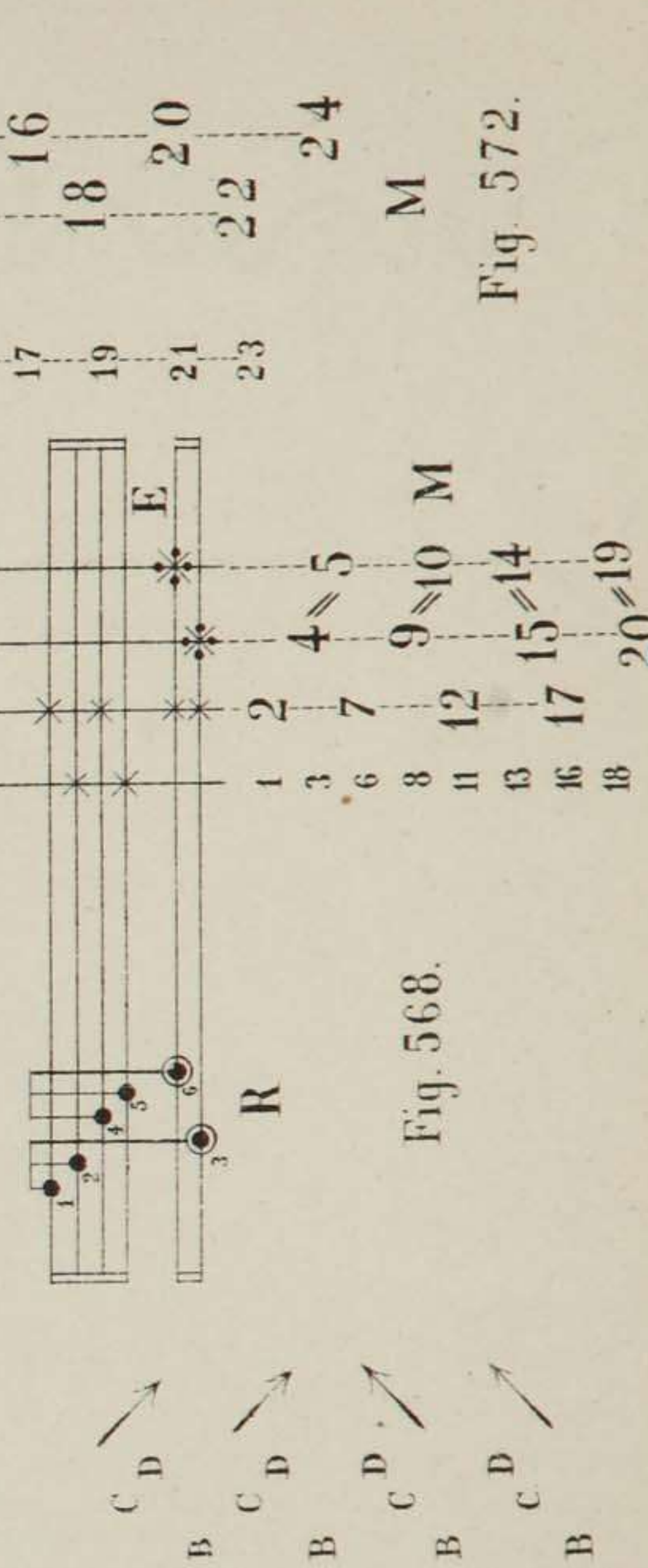


Fig. 568.

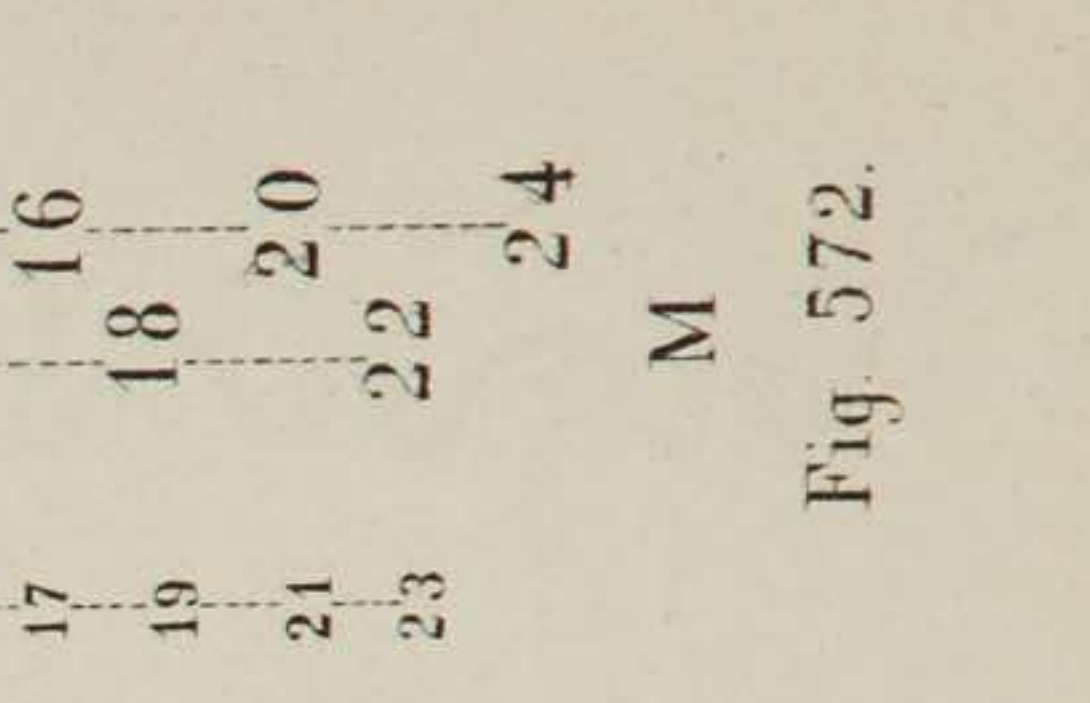


Fig. 572.

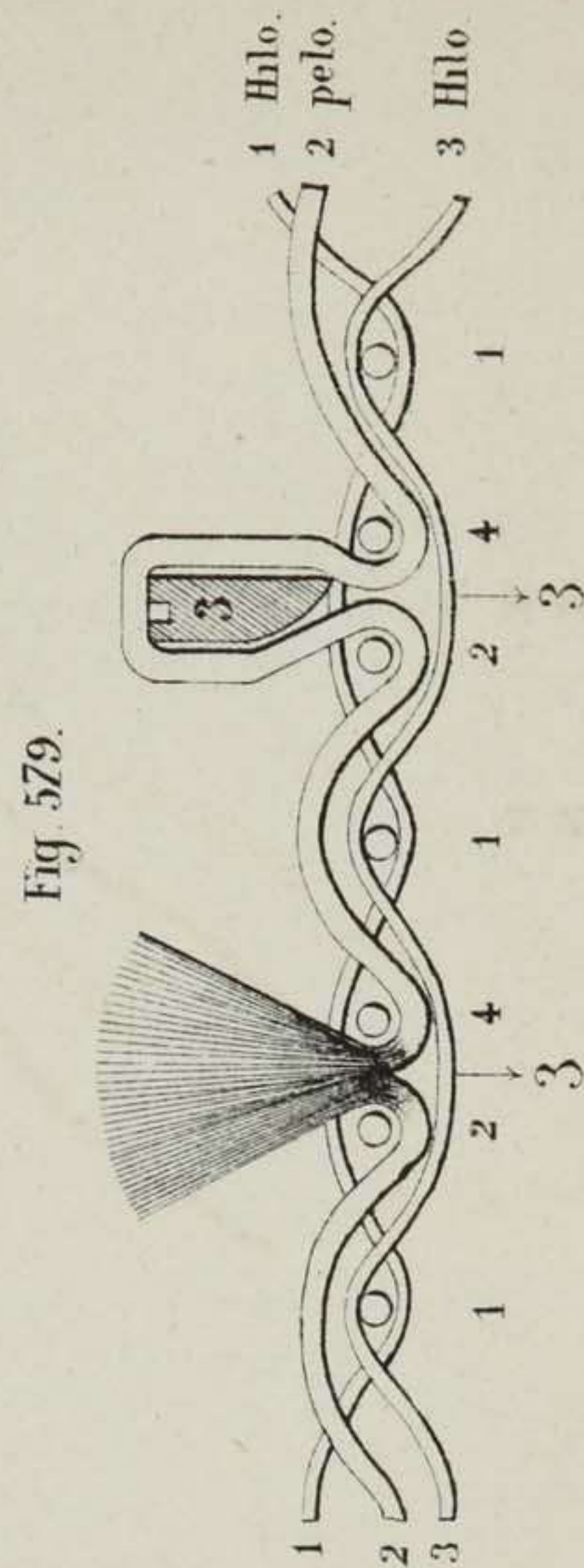
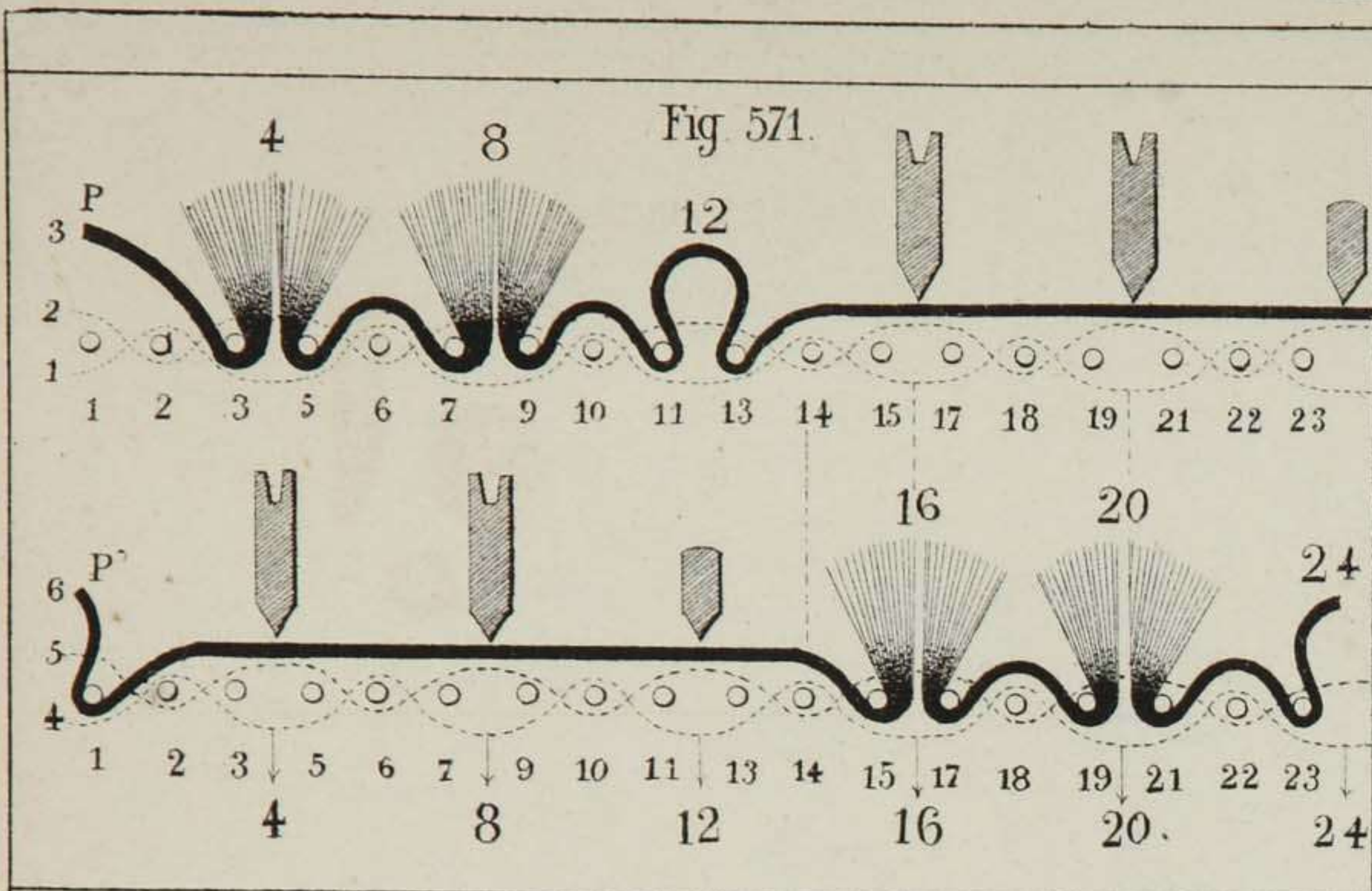


Fig. 579.

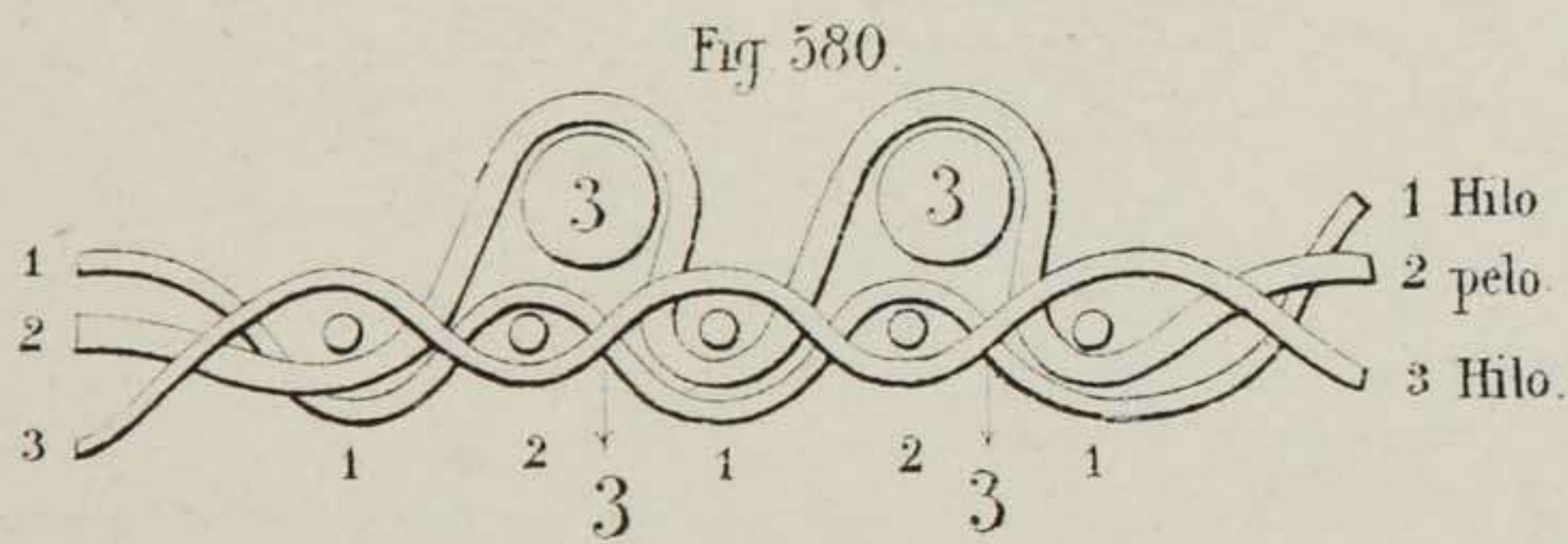
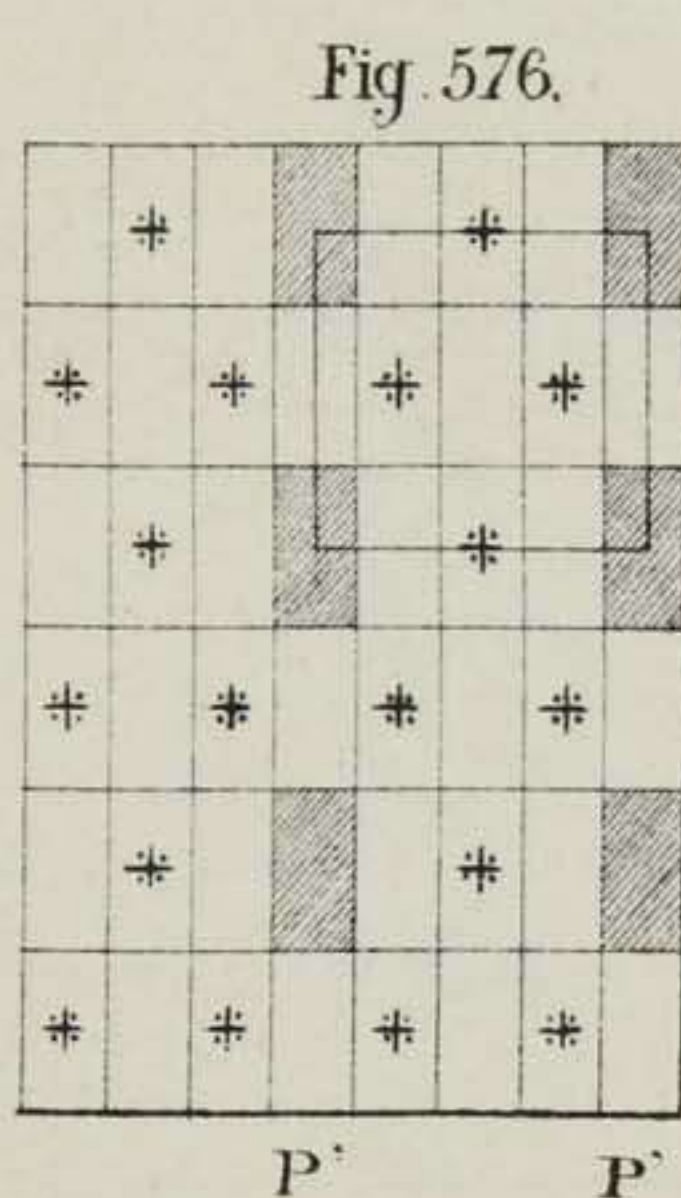
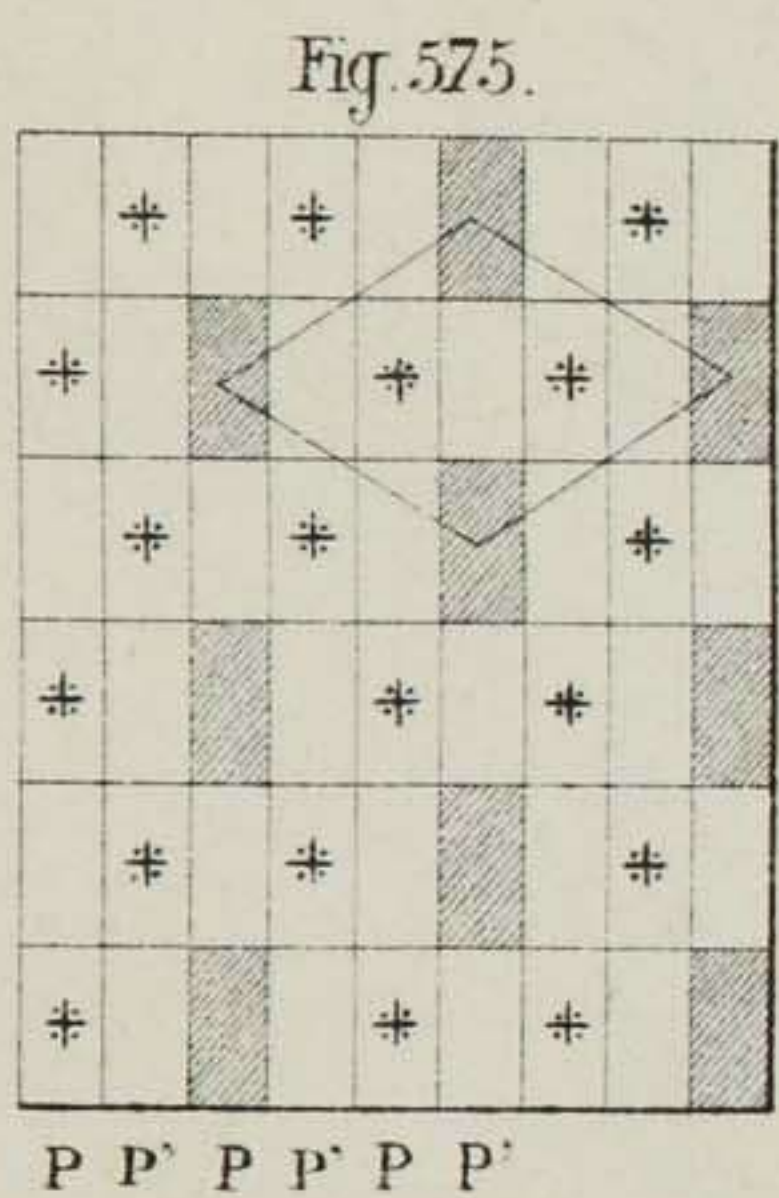
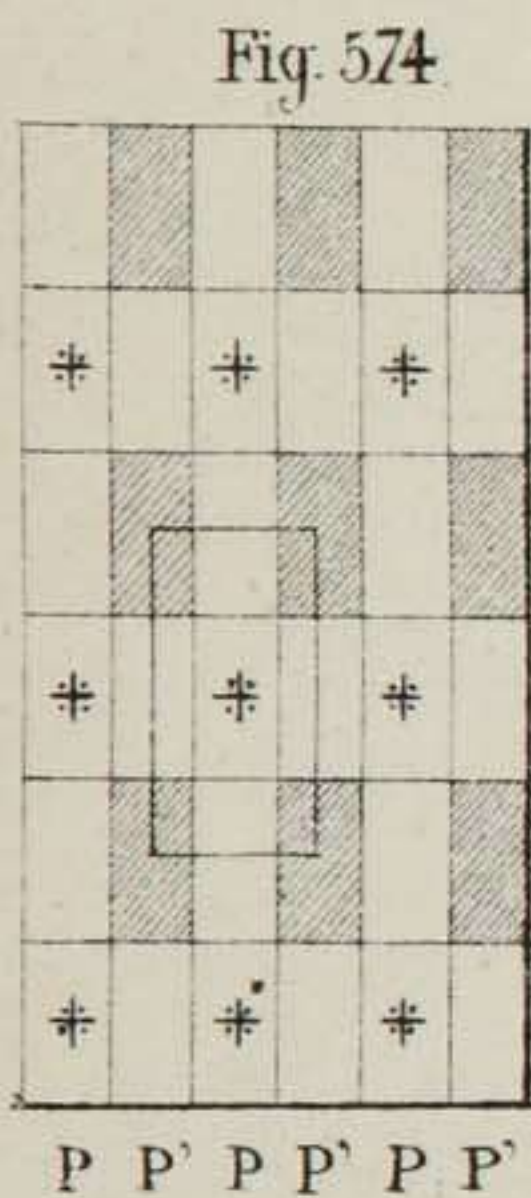


Fig. 578.

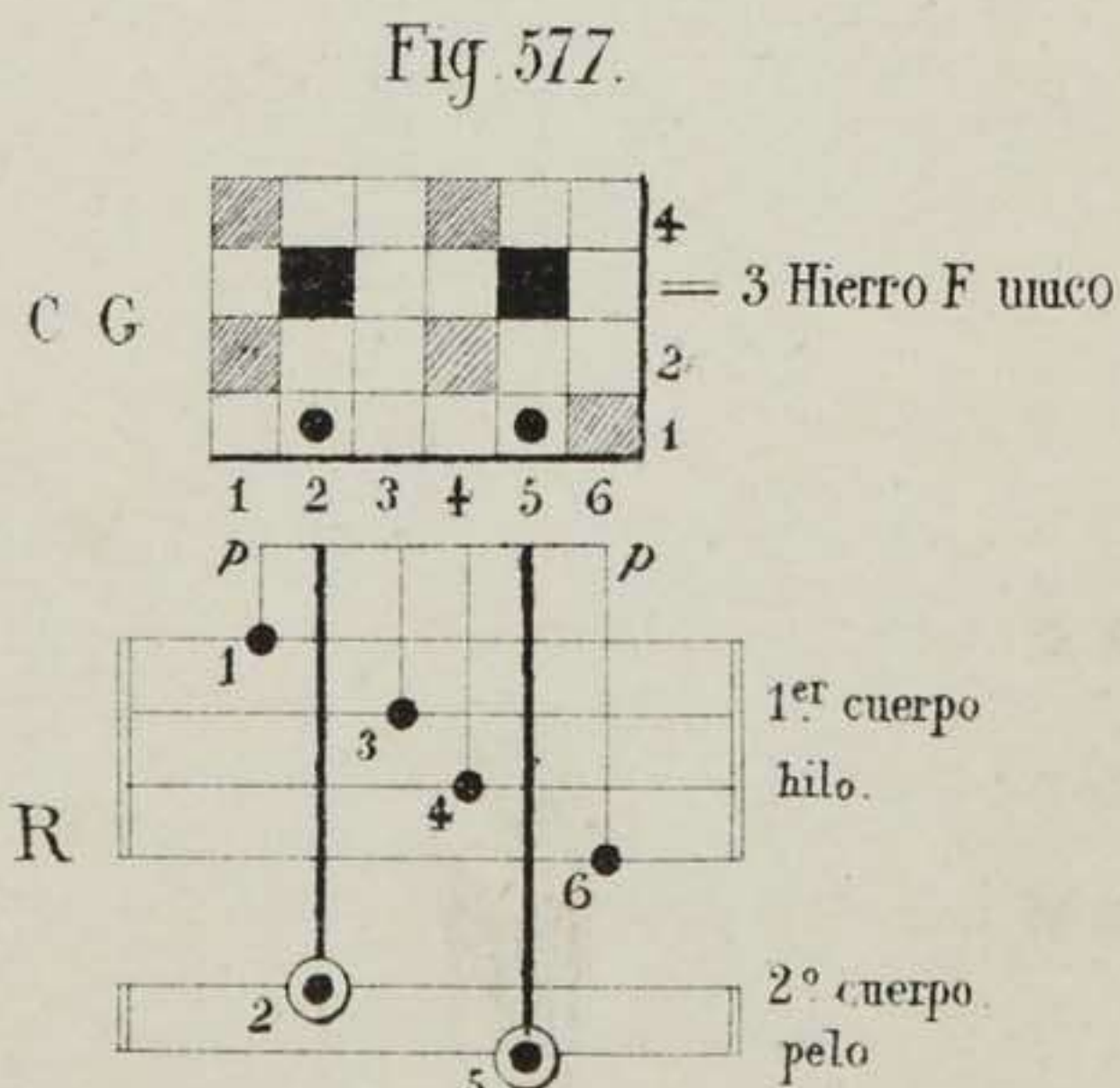
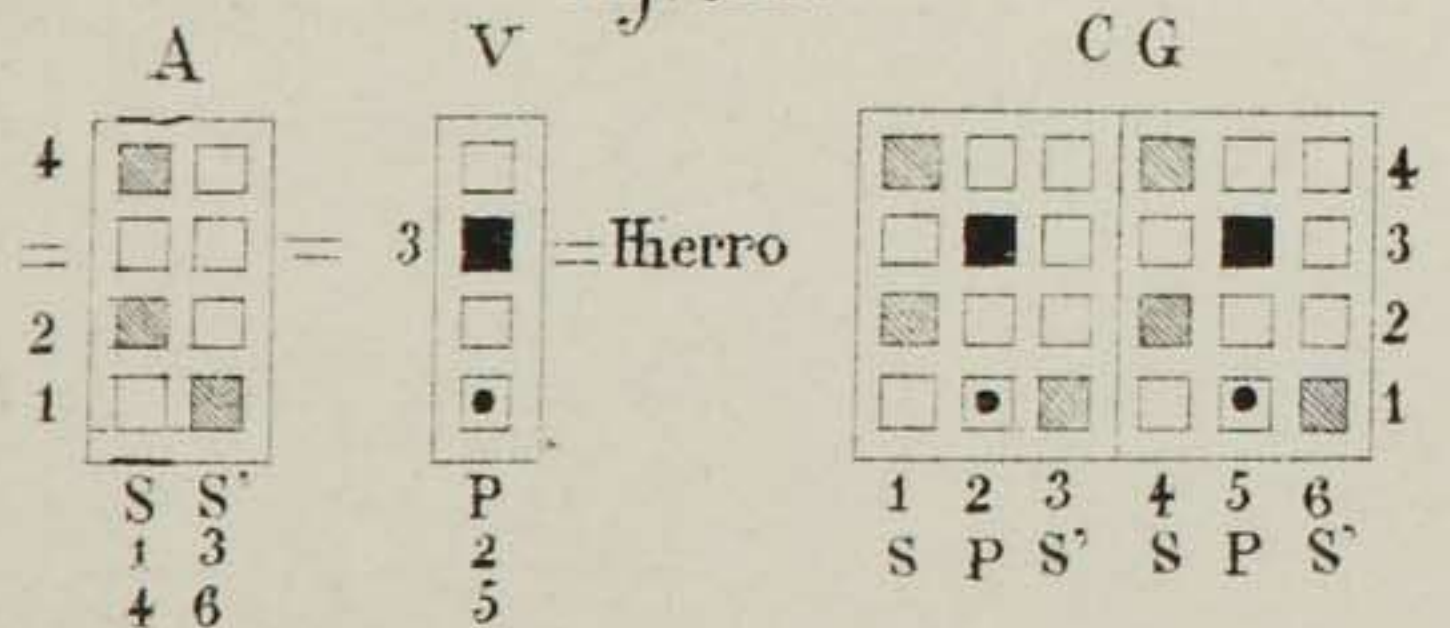


Fig. 582.

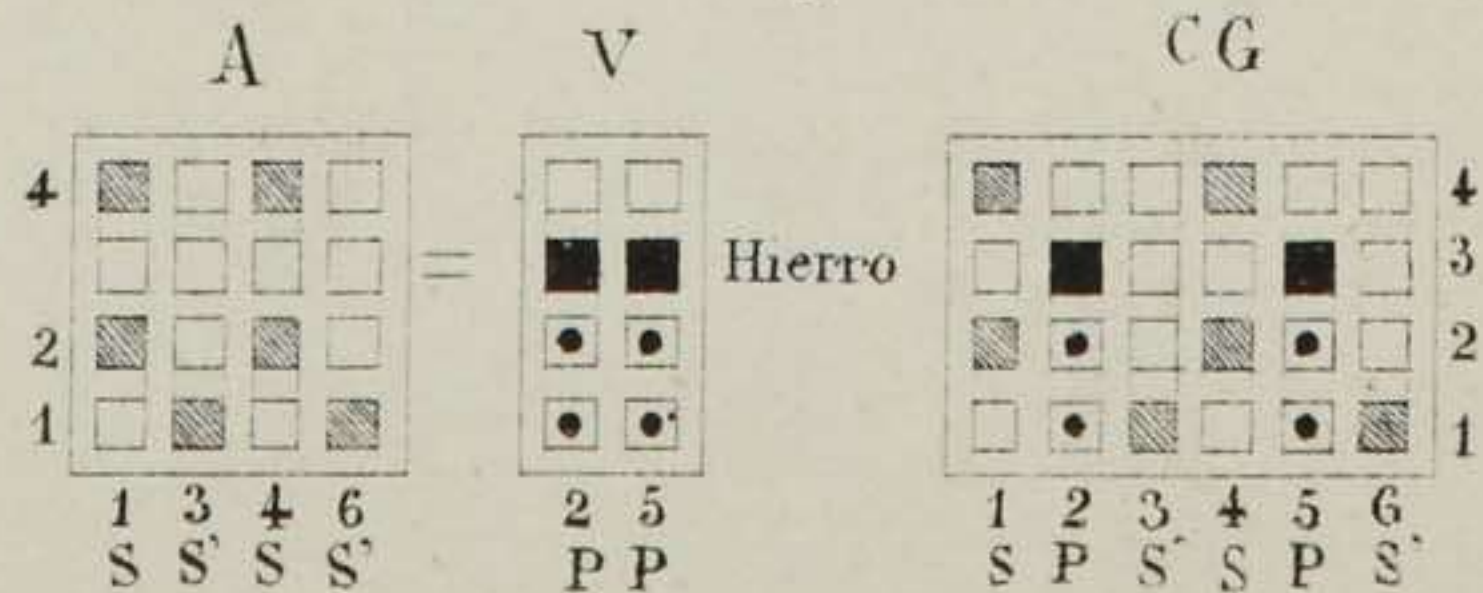
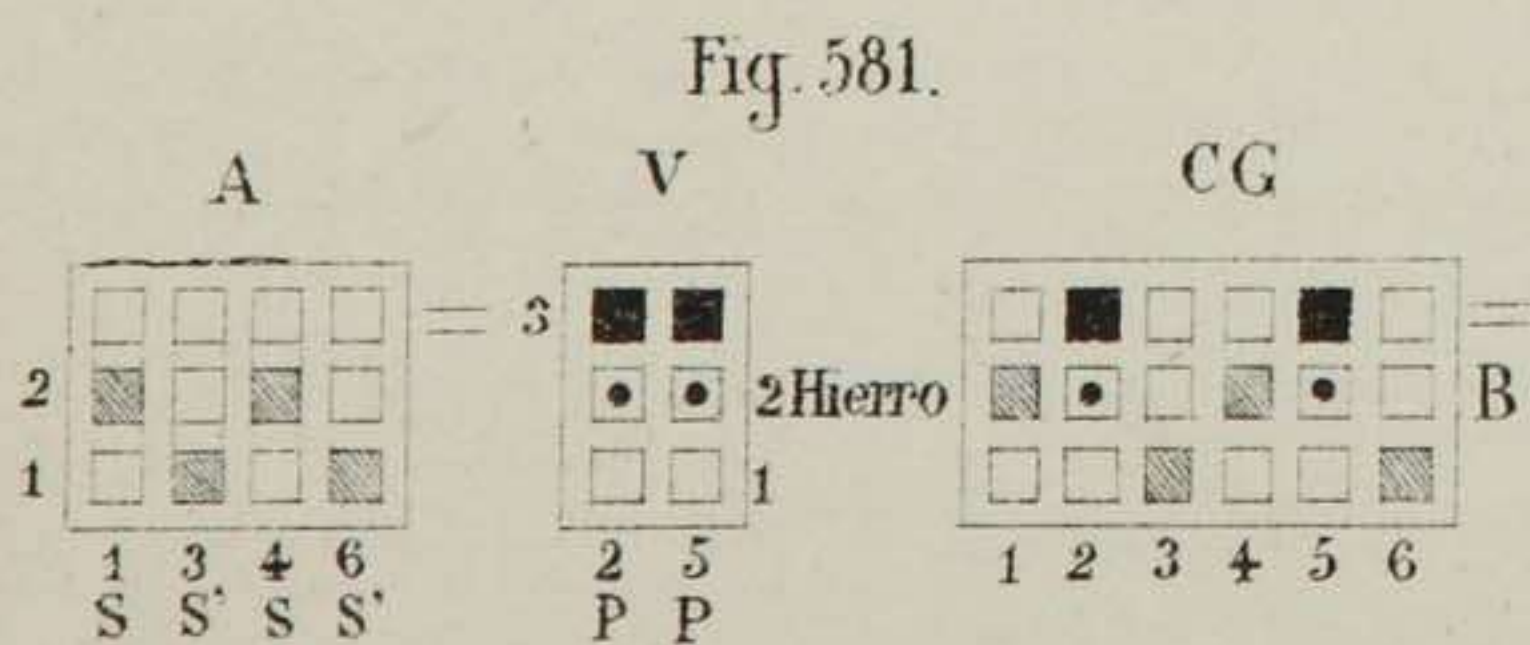


Fig. 584.

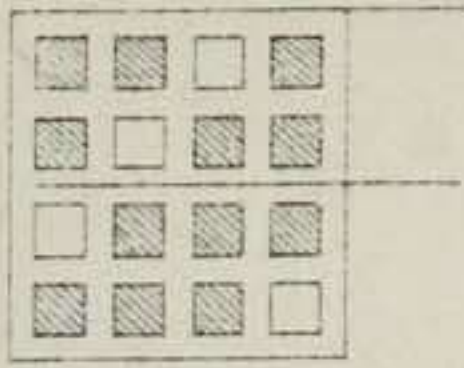


Fig. 593.

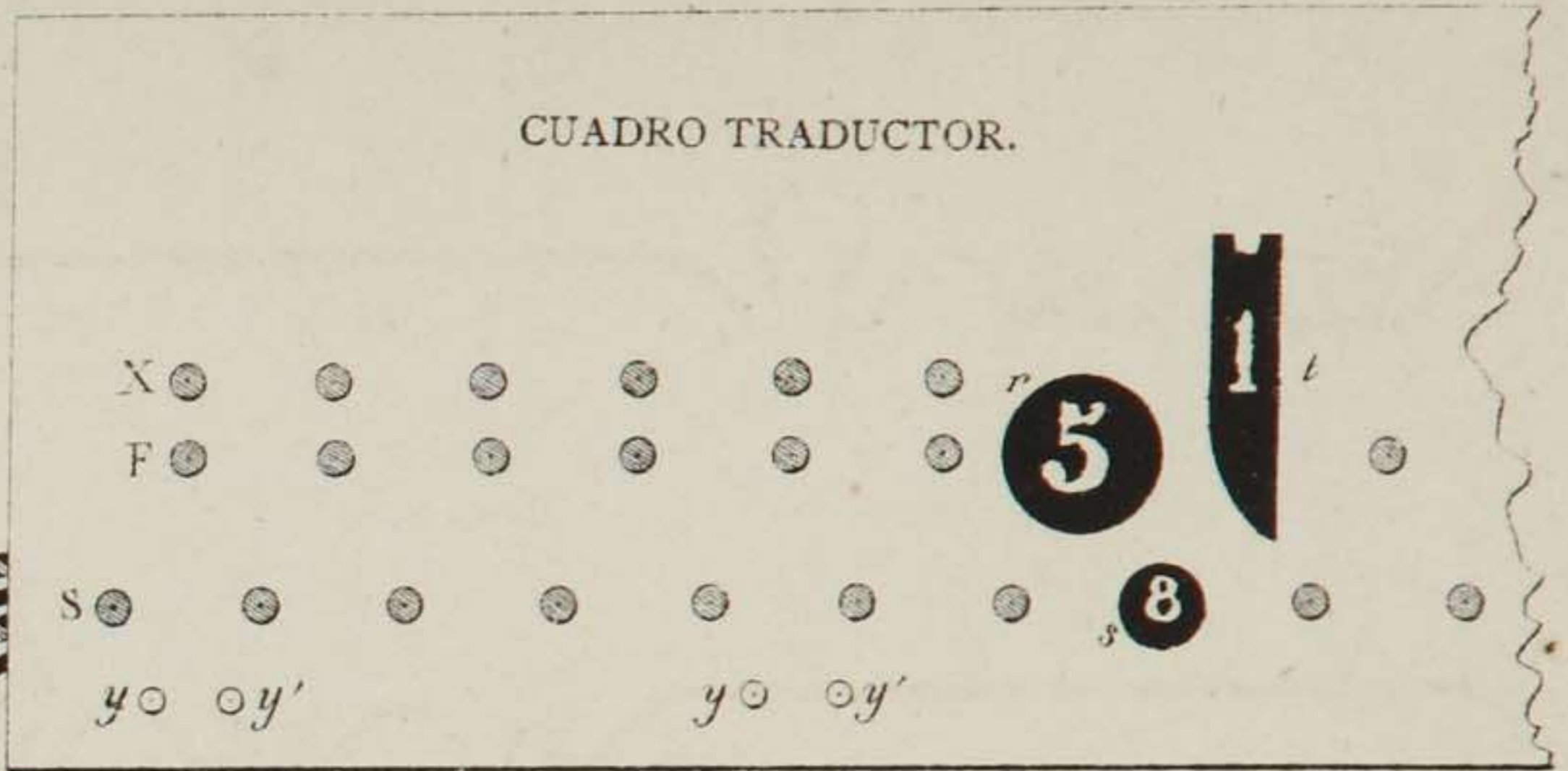


Fig. 588.

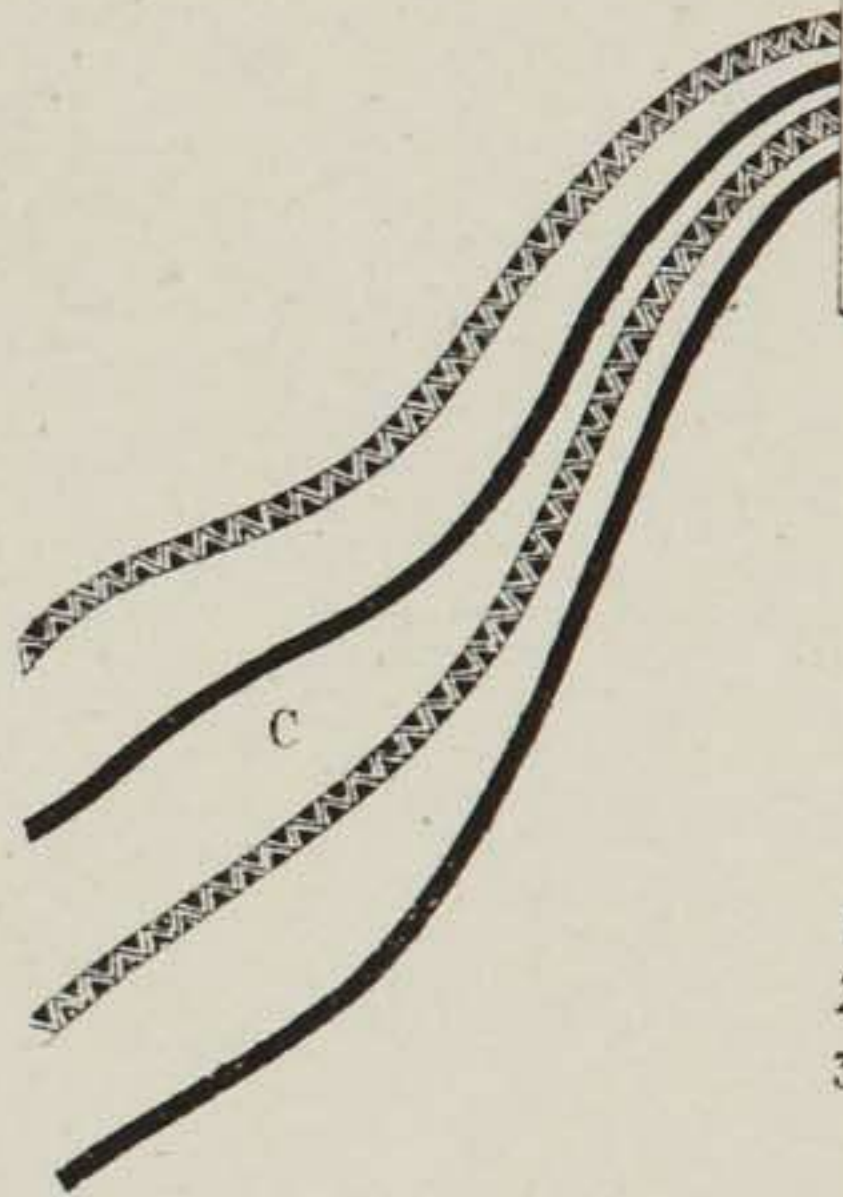
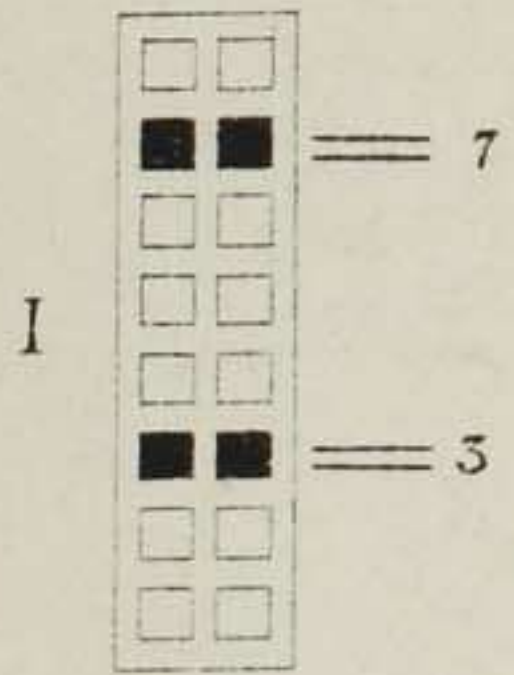


Fig. 586.

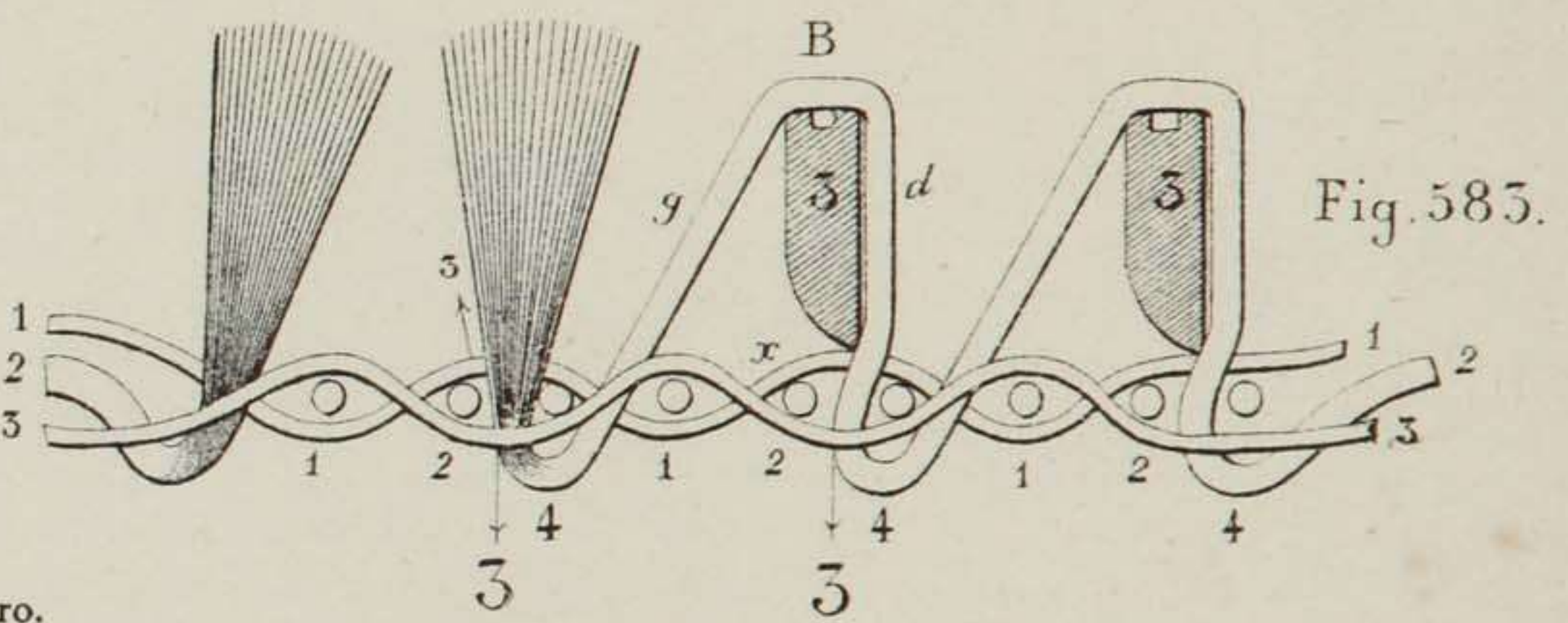
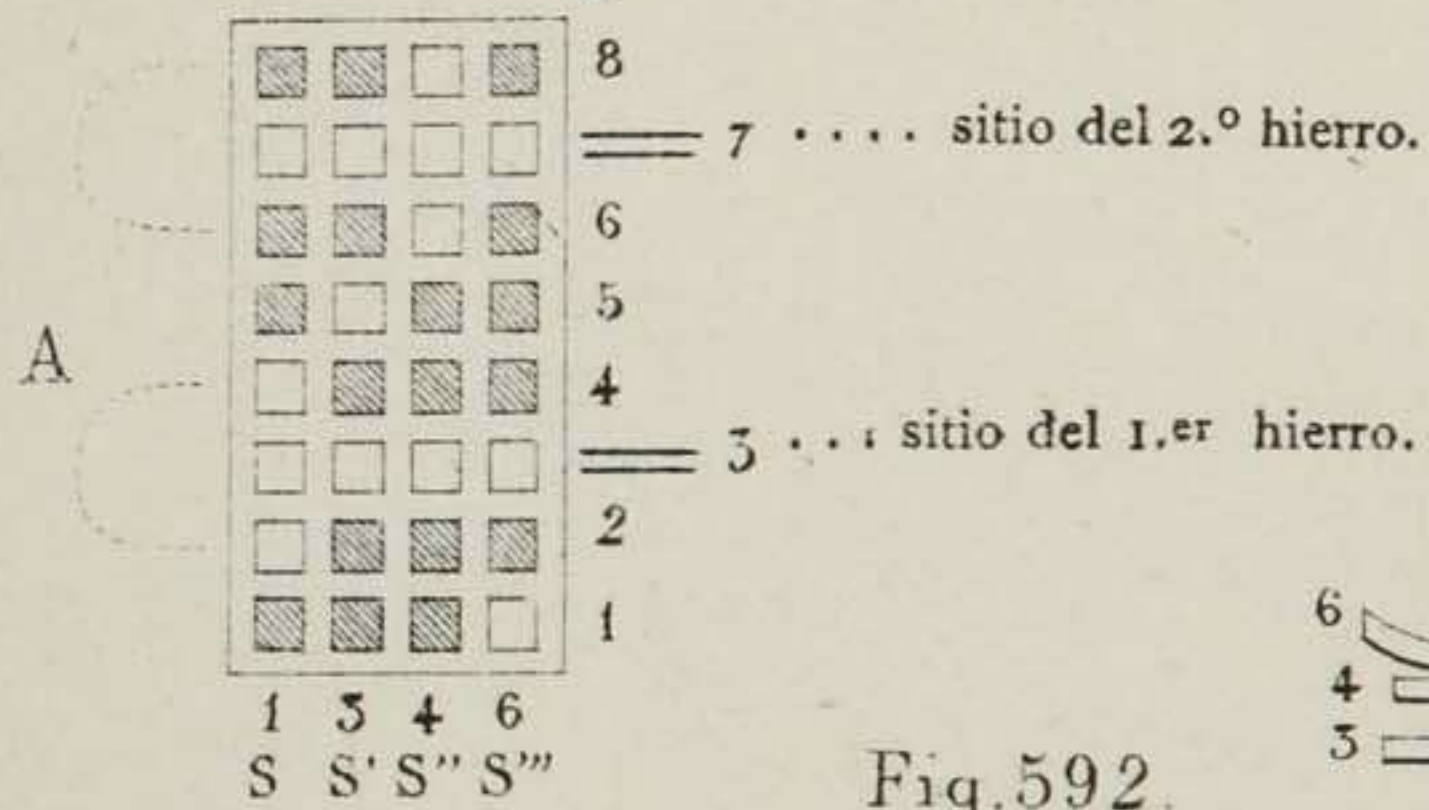


Fig. 585.

Fig. 592.

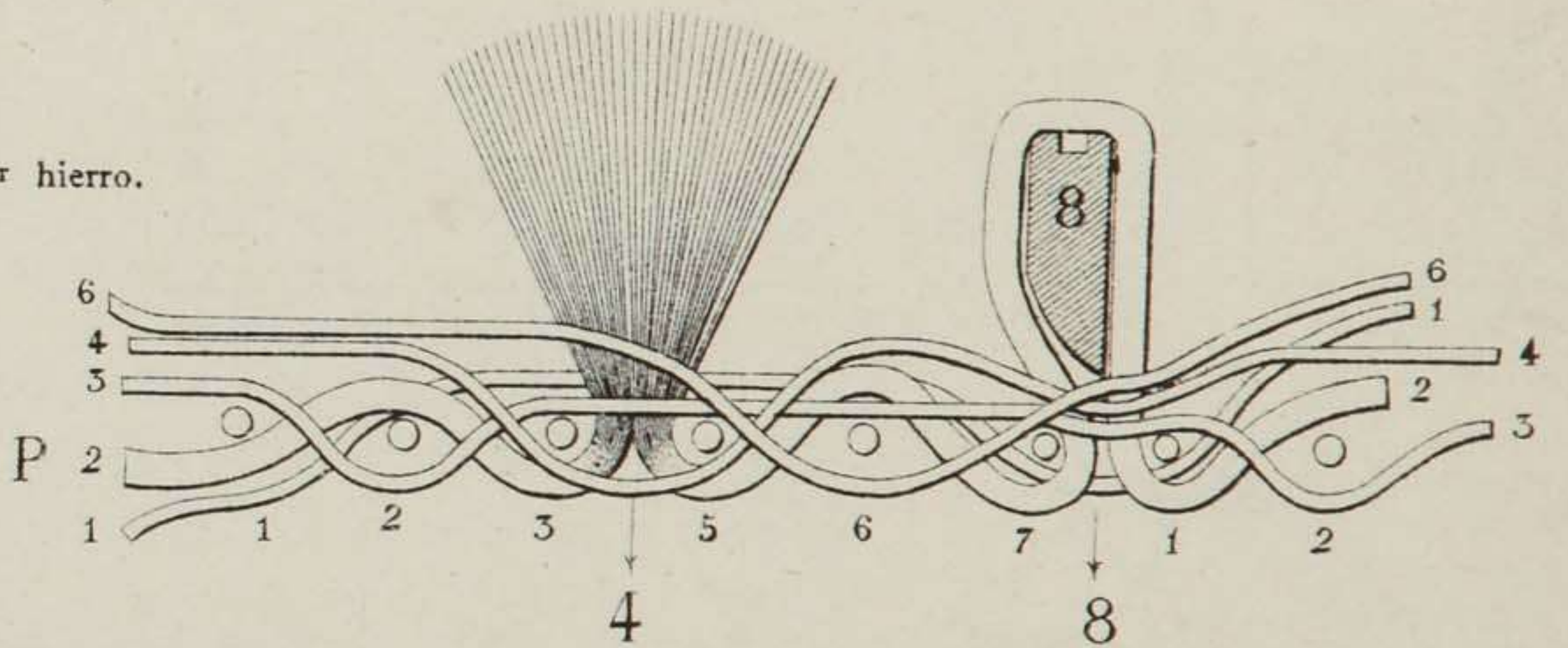


Fig. 589.

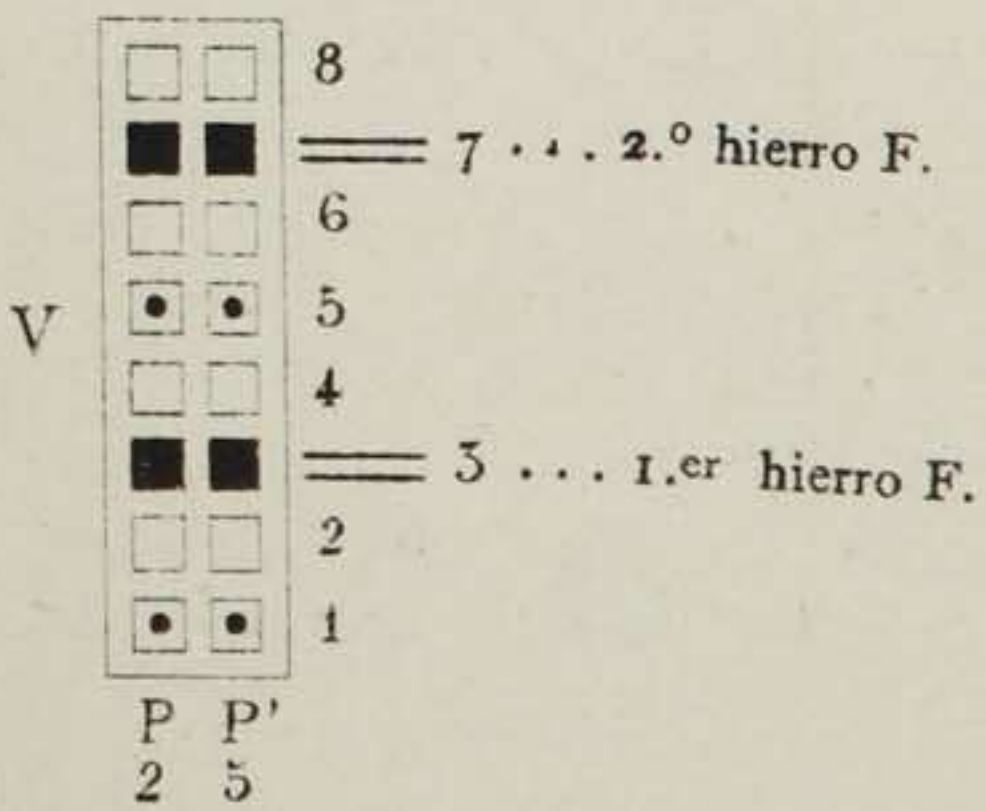


Fig. 590.

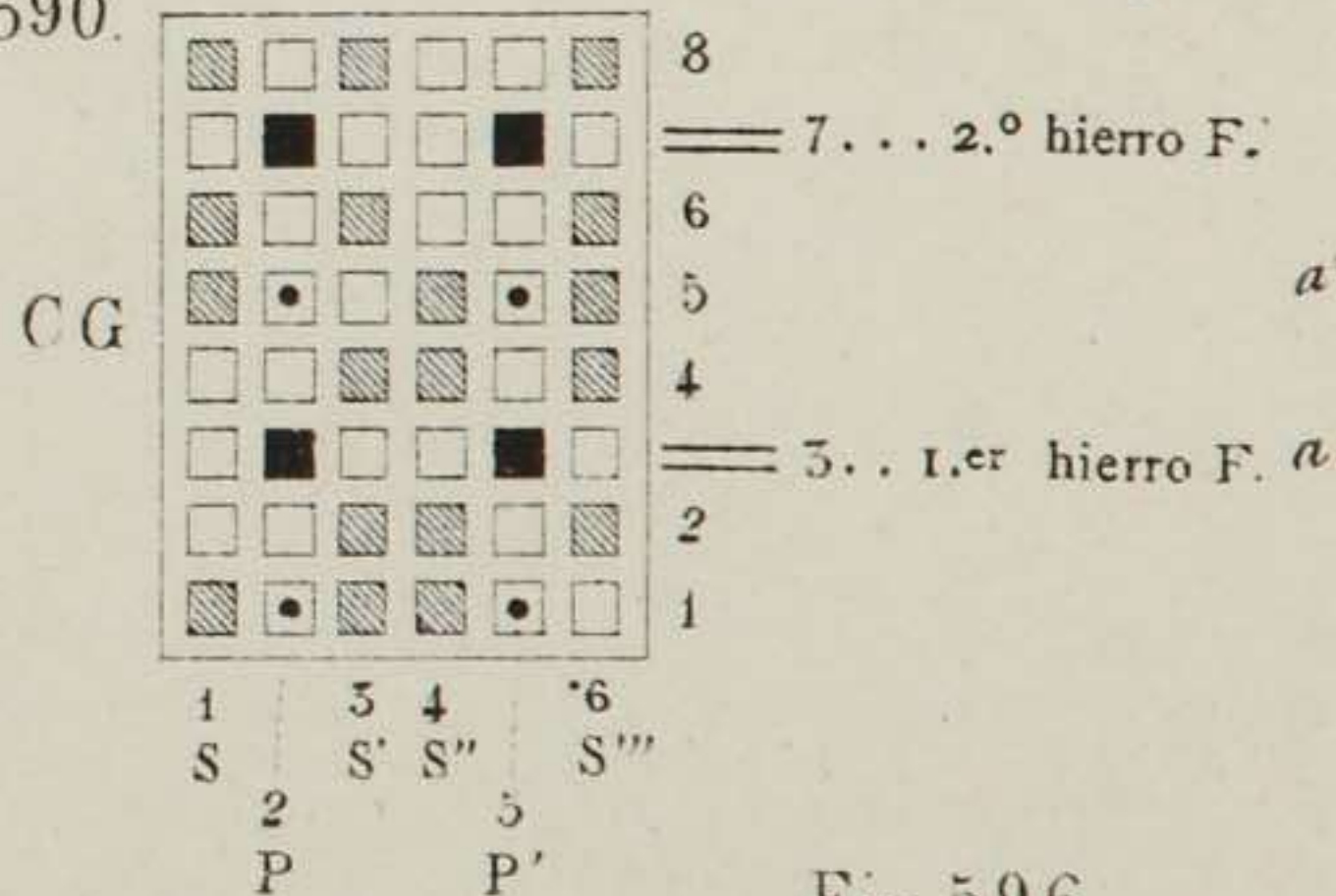


Fig. 585.

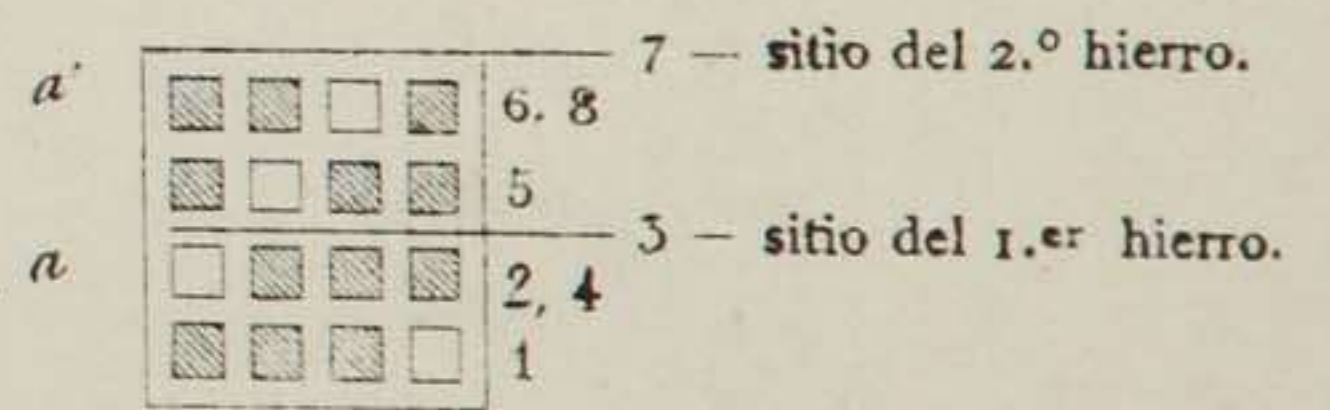


Fig. 591.

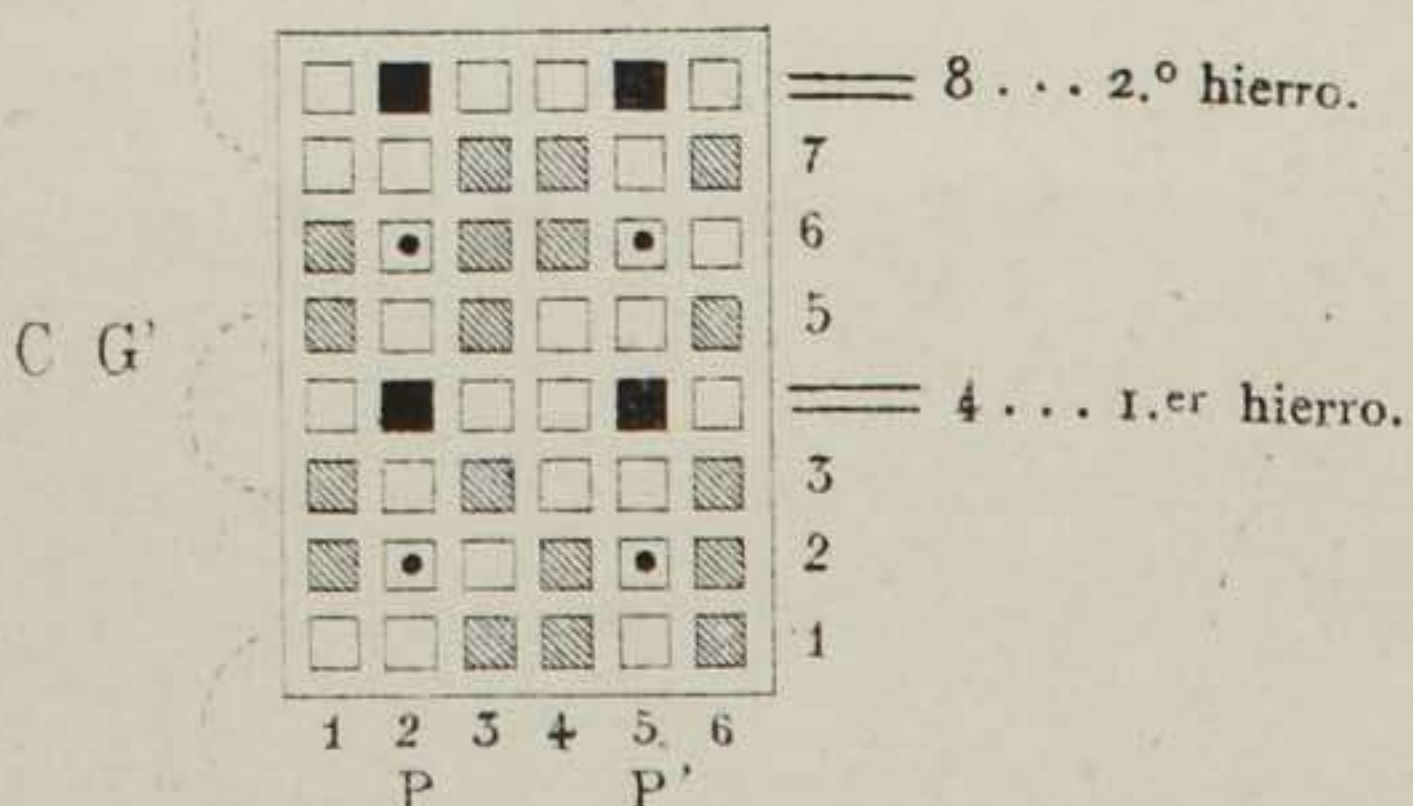


Fig. 596.

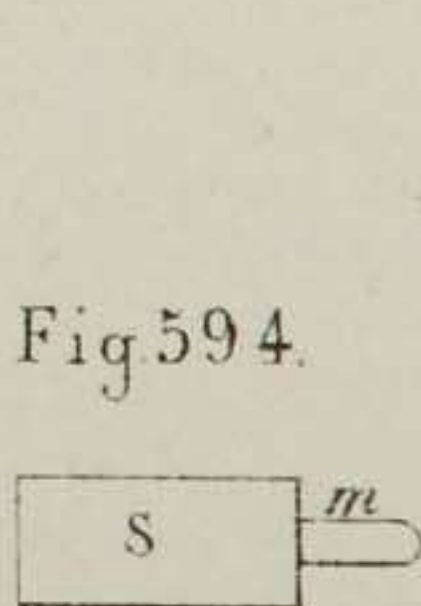


Fig. 594.



Fig. 595.

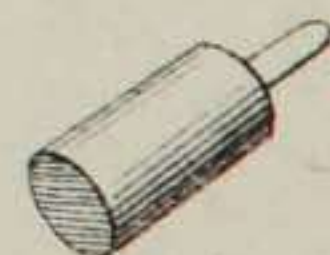


Fig. 587.

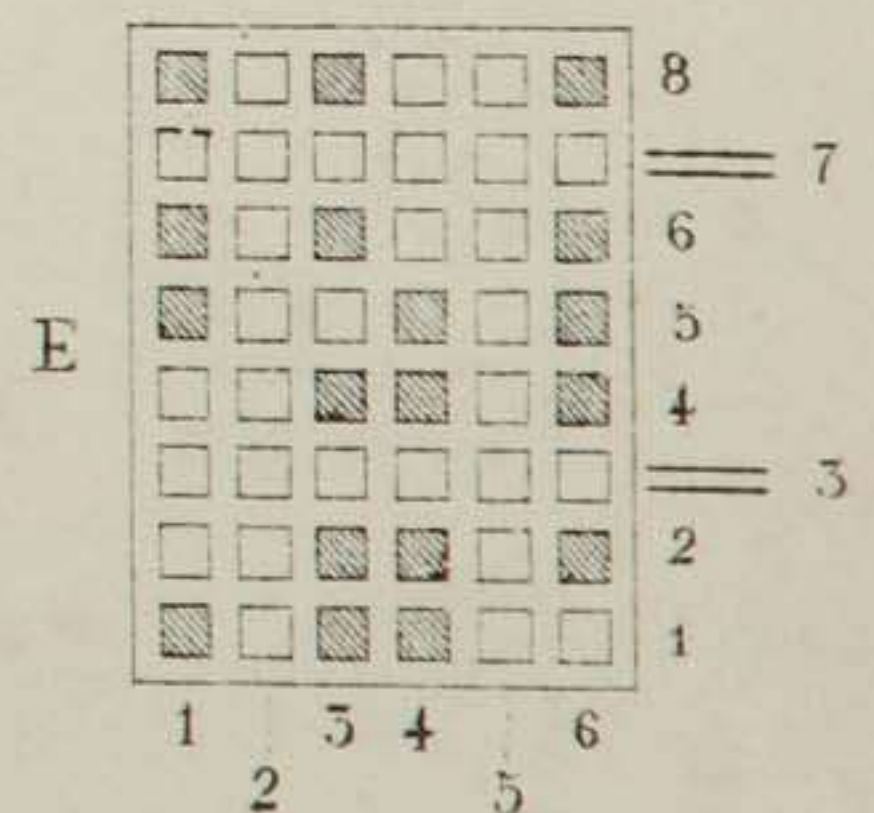
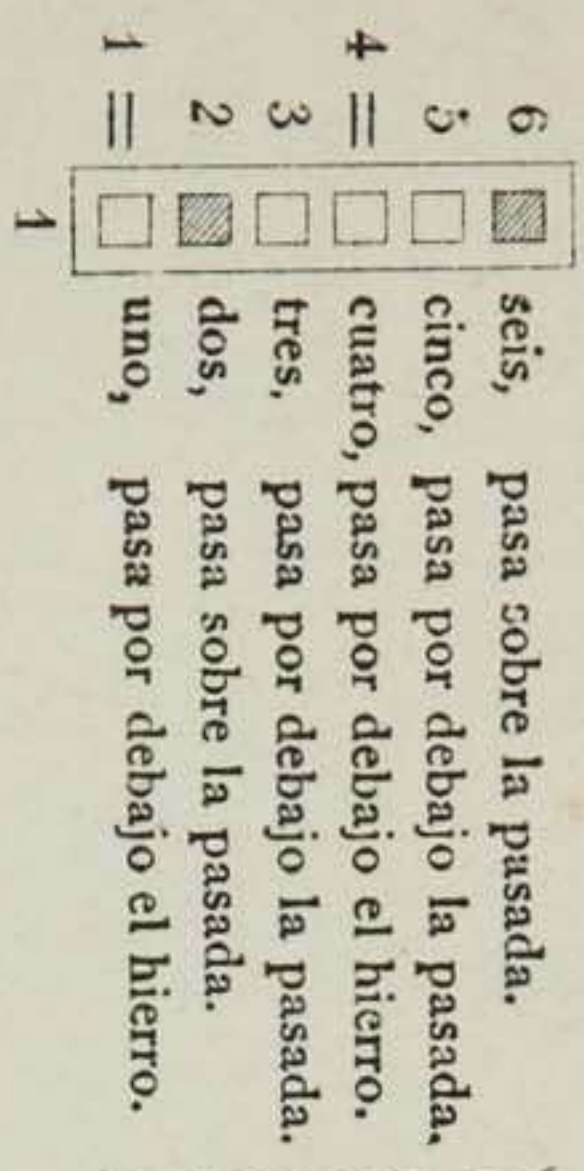
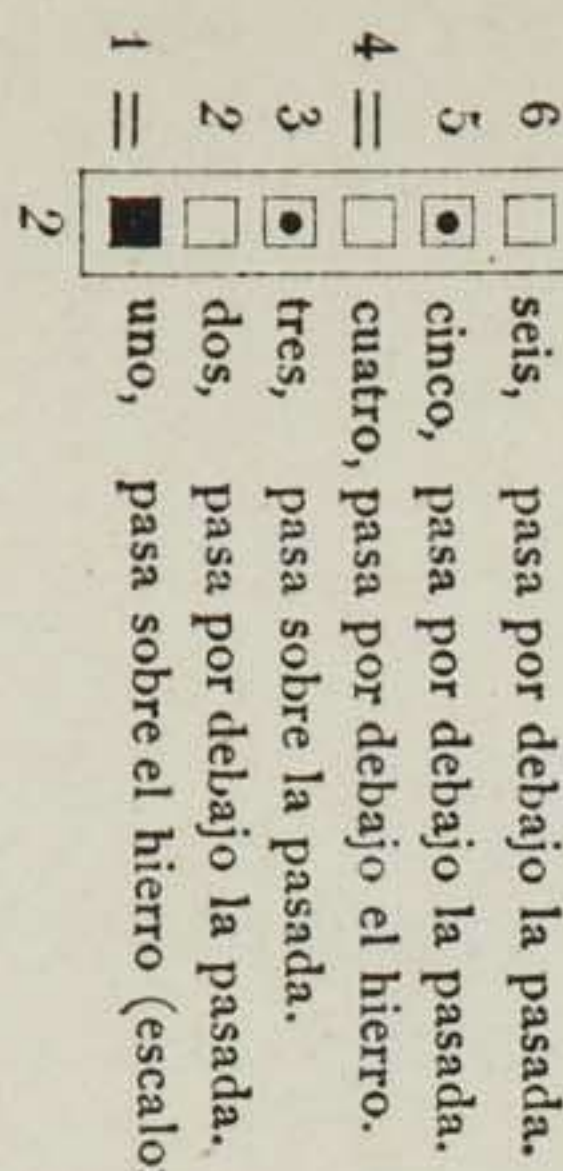


Fig. 608.



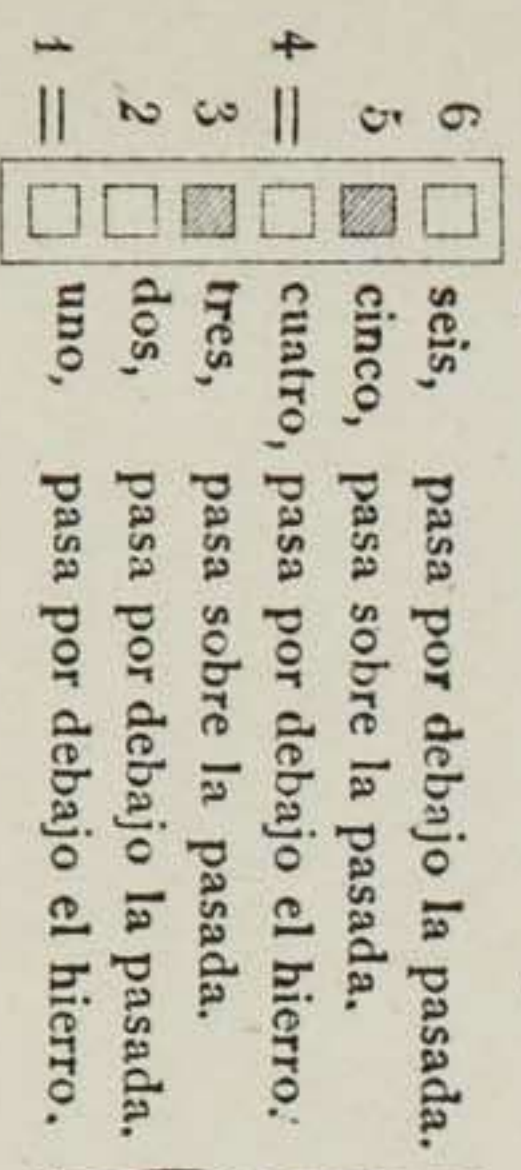
1.ª FÓRMULA
Cuerda negra C, para tejido de alma.

Fig. 609.



2.ª FÓRMULA
Cuerda roja para terciopelo.

Fig. 614.



3.ª FÓRMULA
Cuerda negra para tejido de alma.

Fig. 597.

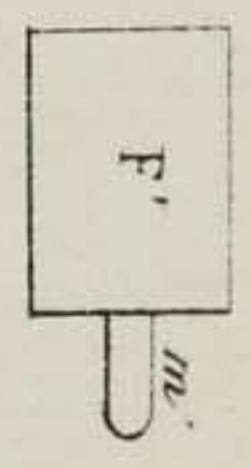


Fig. 598.

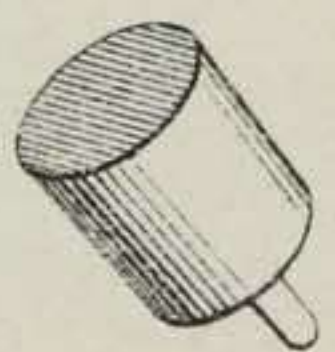


Fig. 599.

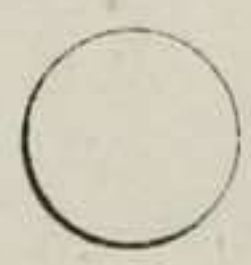


Fig. 605.



Fig. 603.

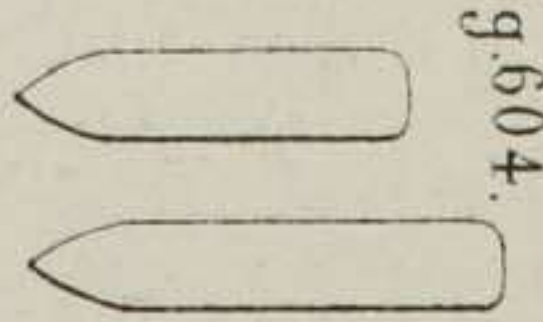


Fig. 600.

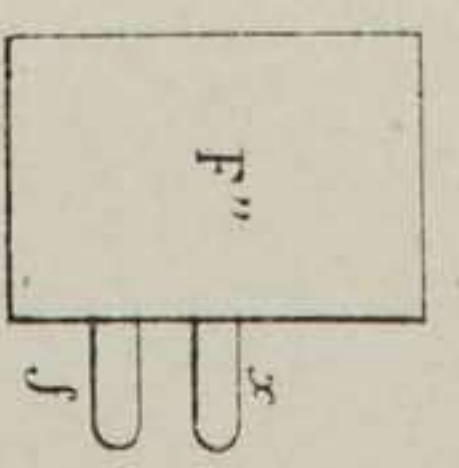


Fig. 601.

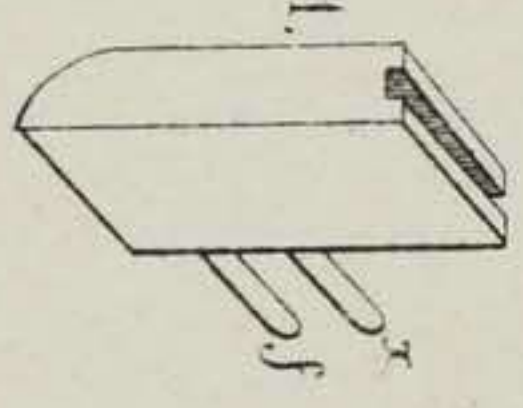


Fig. 602.

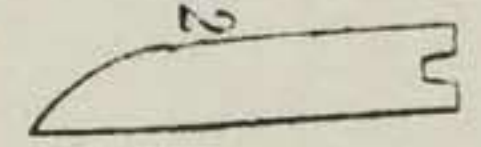


Fig. 611.

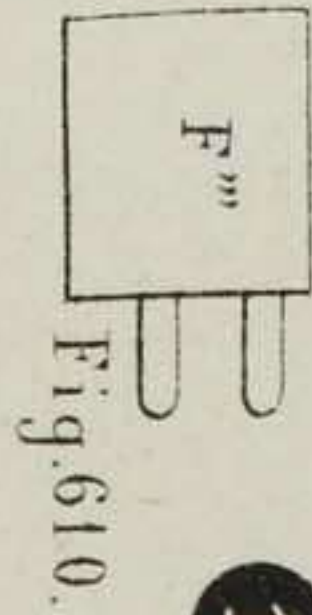


Fig. 607.

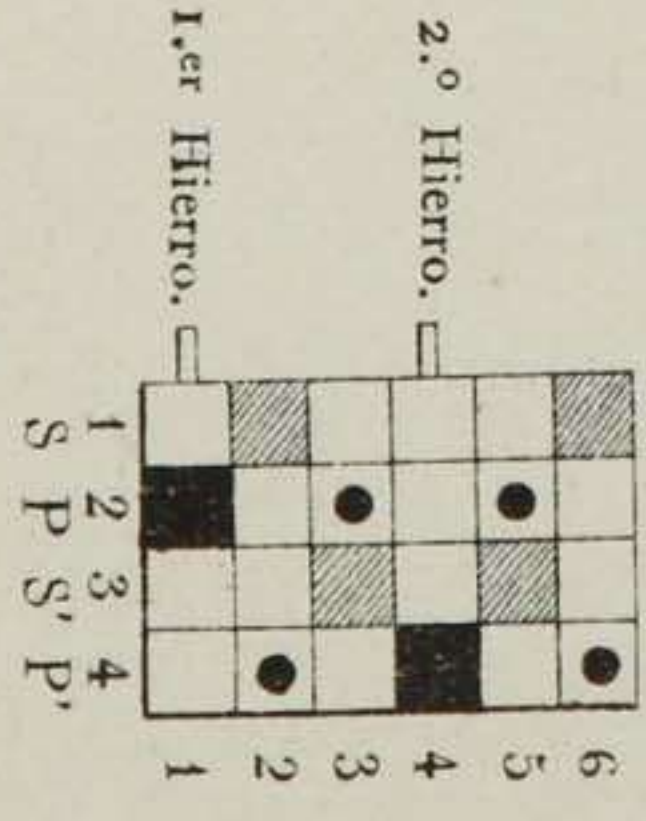
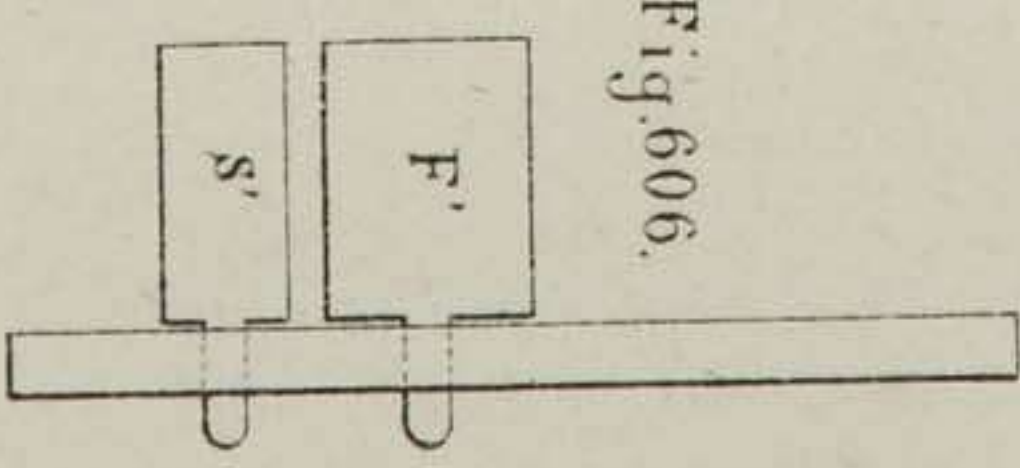


Fig. 606.



(Corte simultáneo de los pelos P P' sobre el hierro único).

Fig. 613.

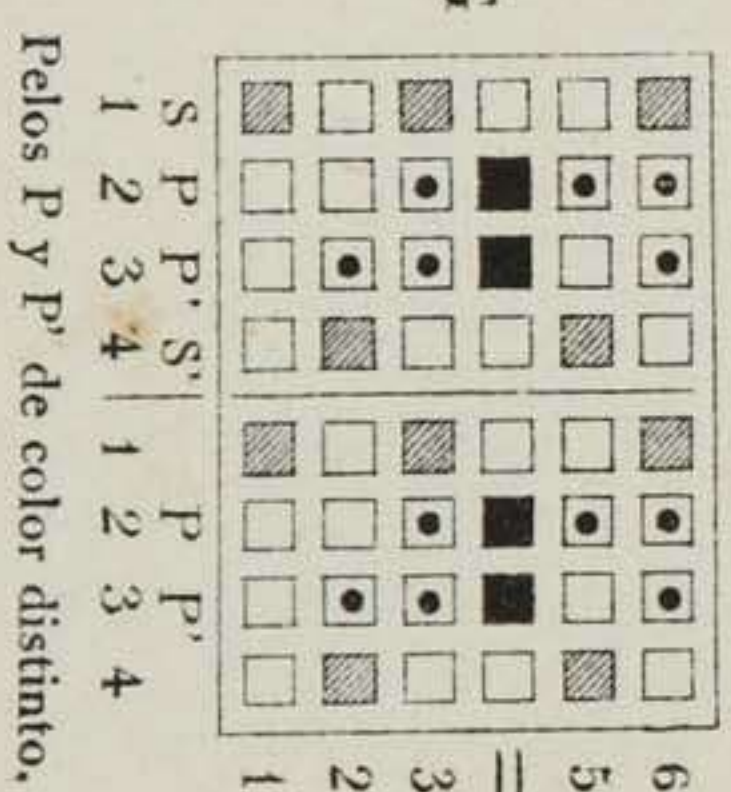


Fig. 612.

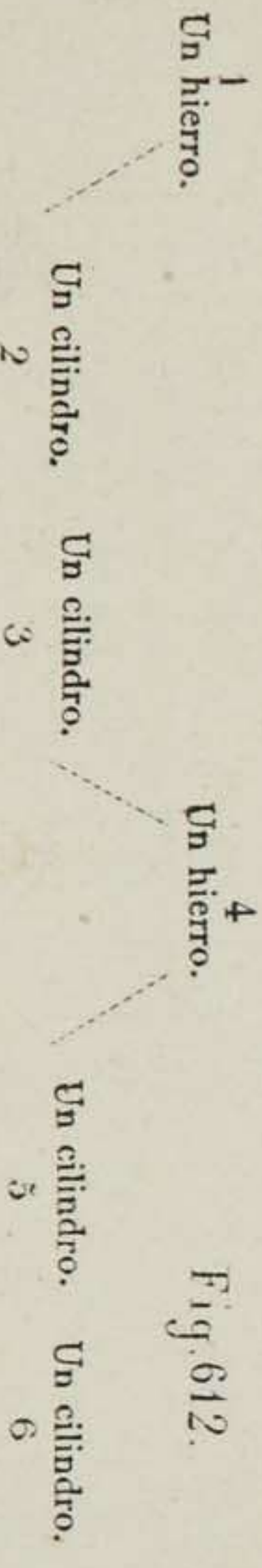
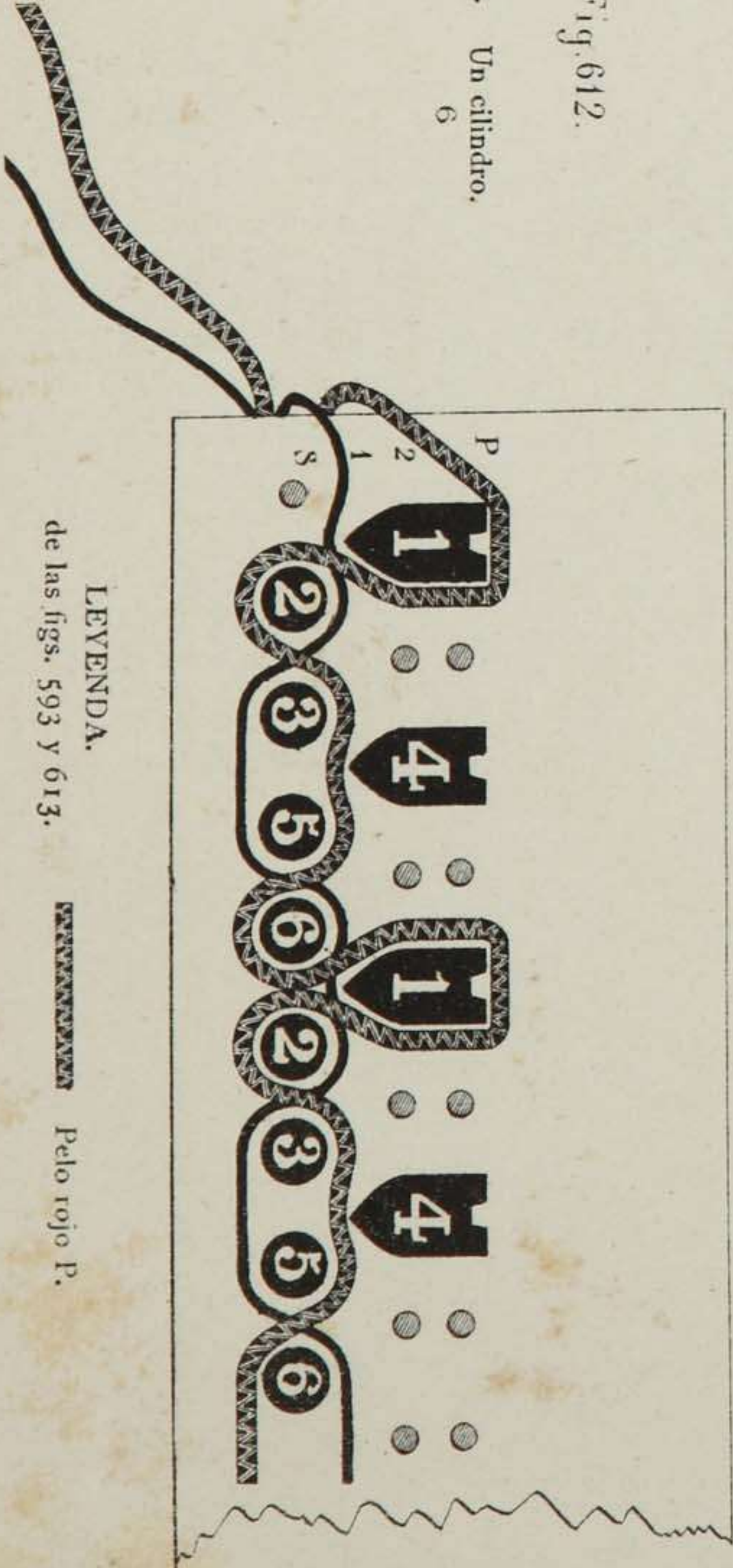
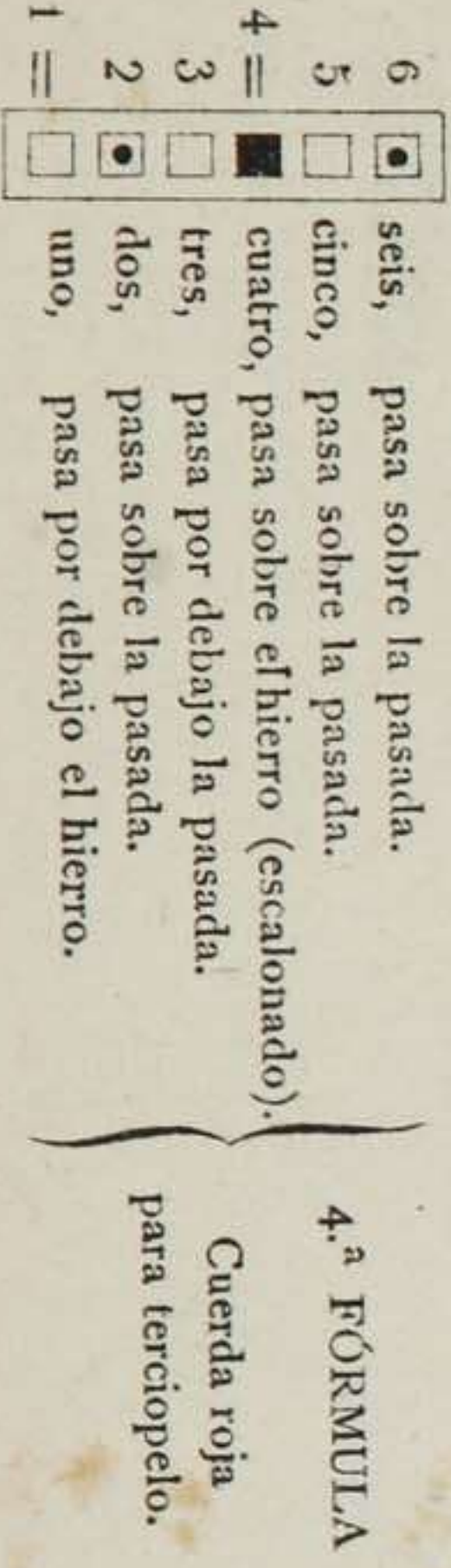
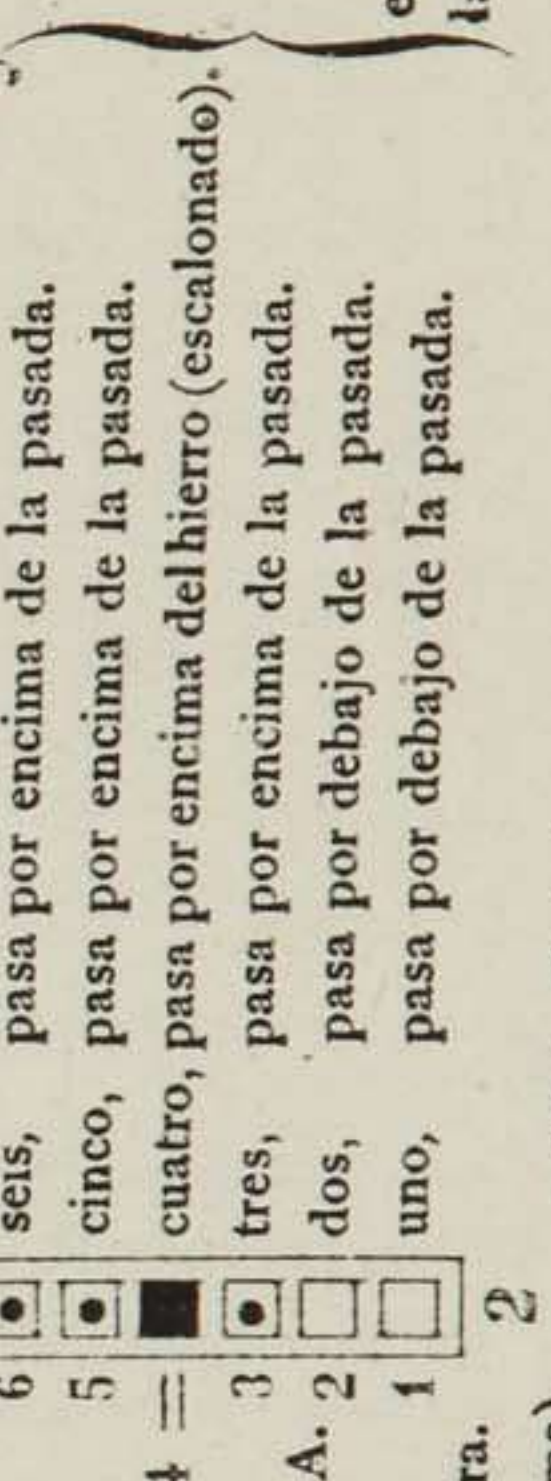
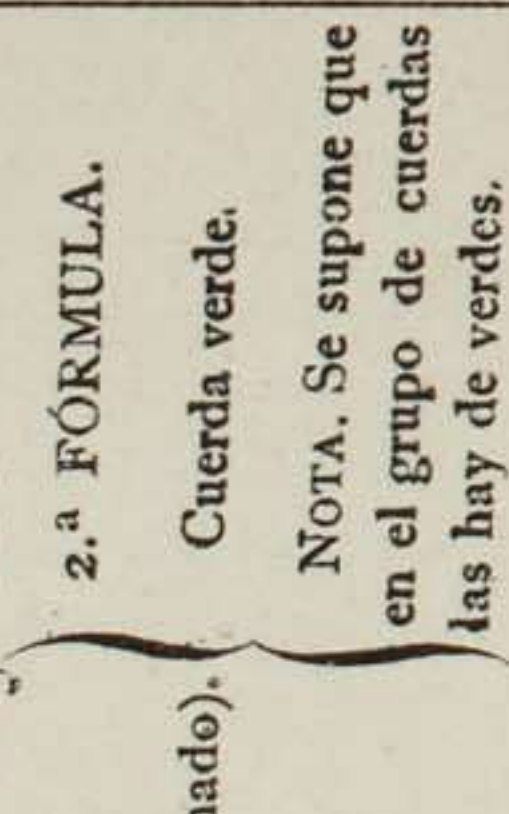
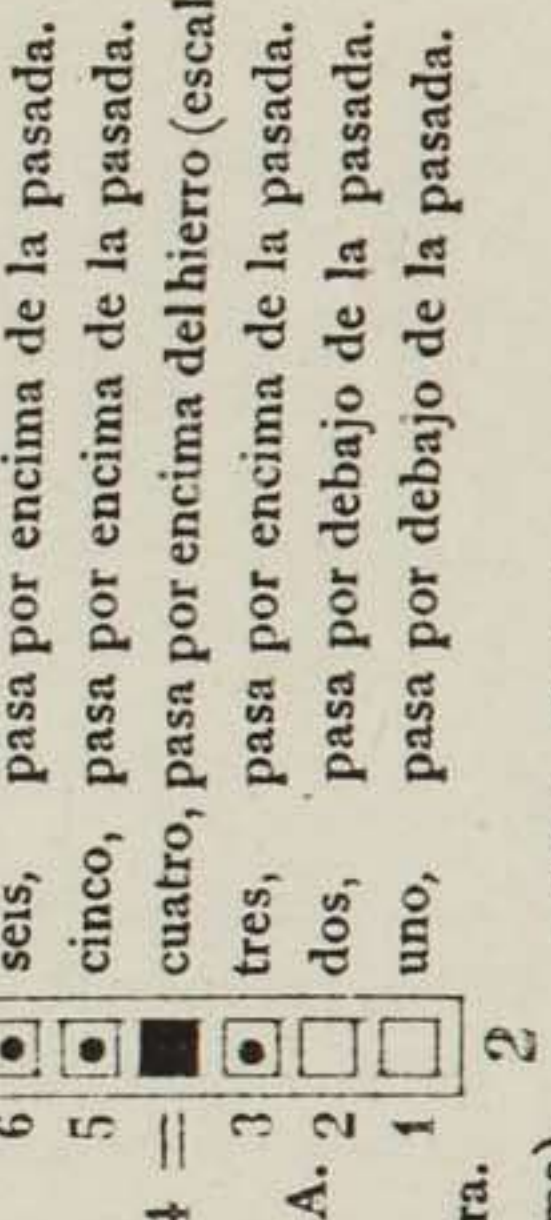
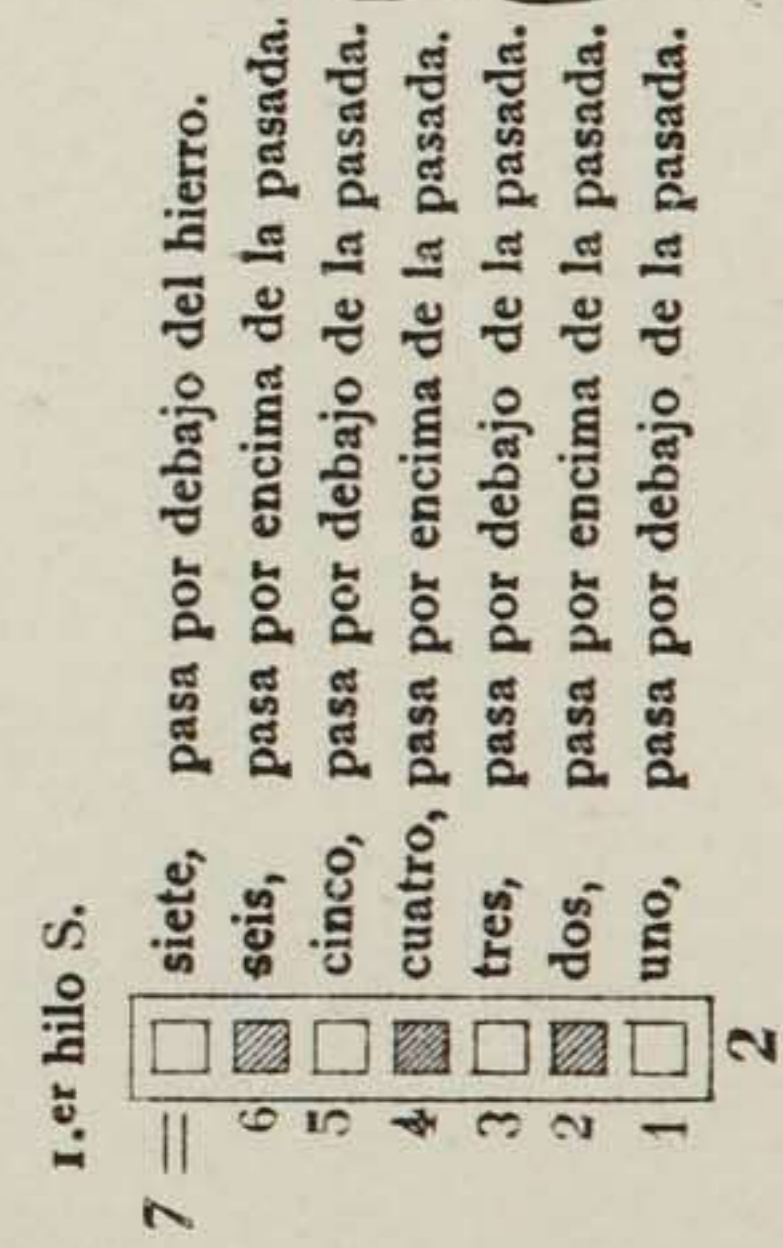
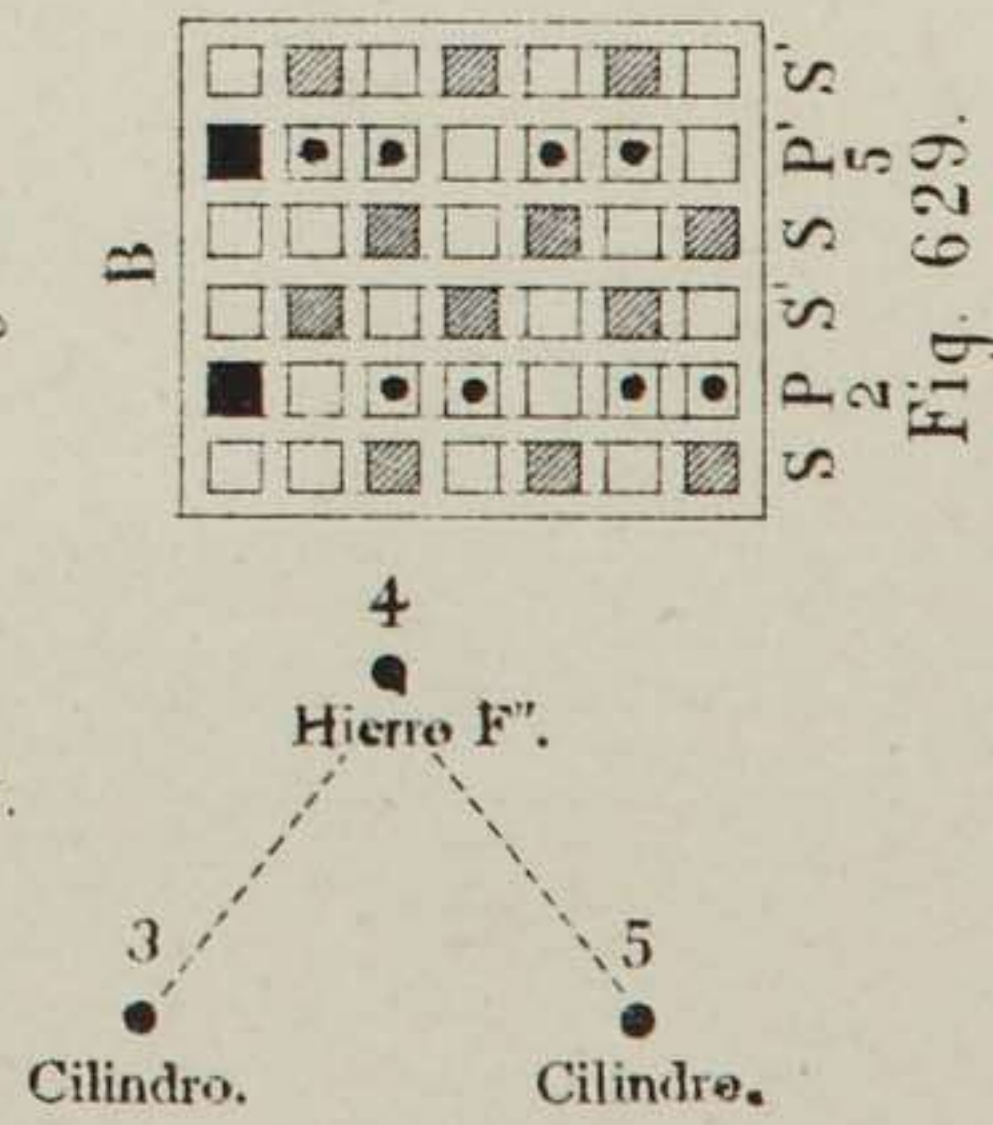
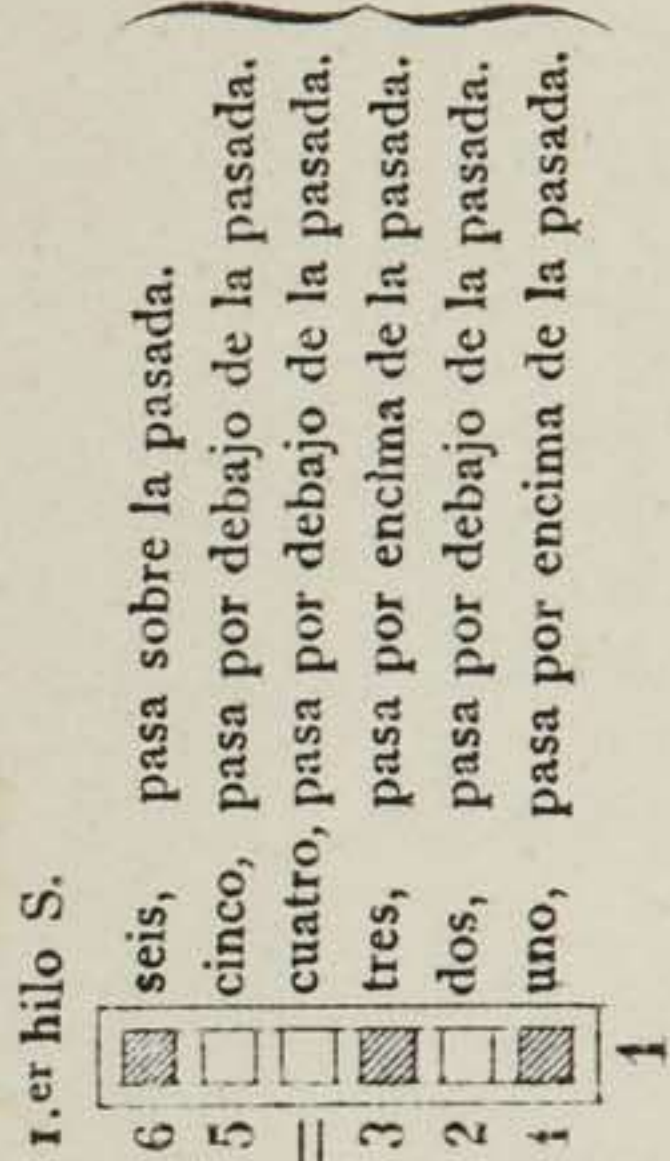
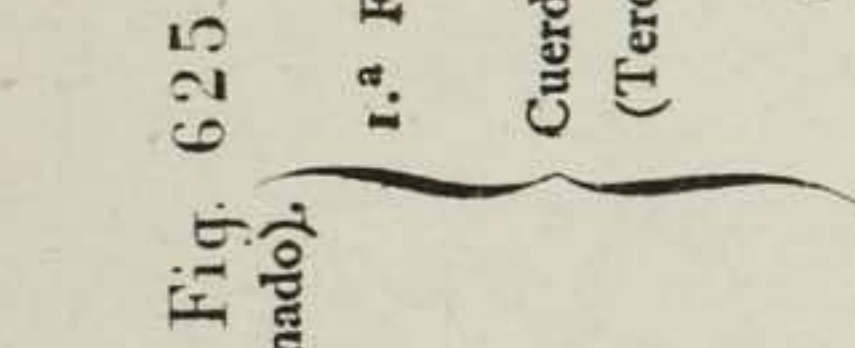
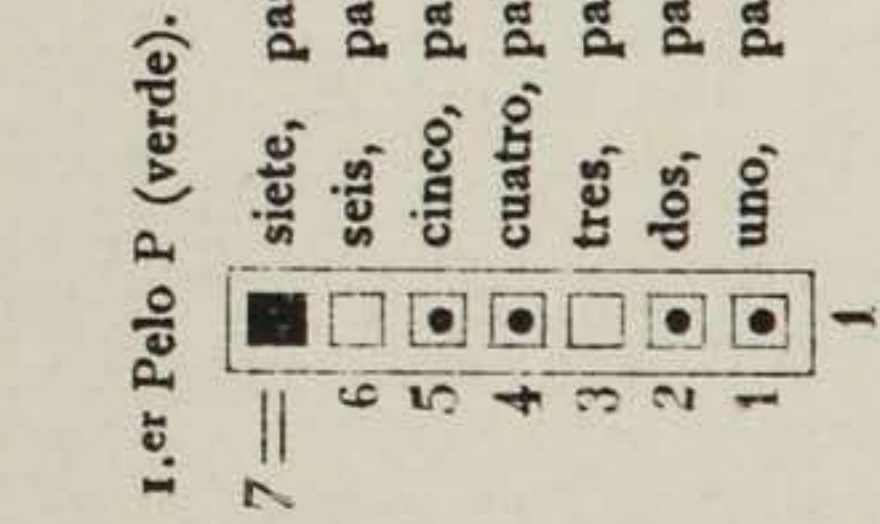
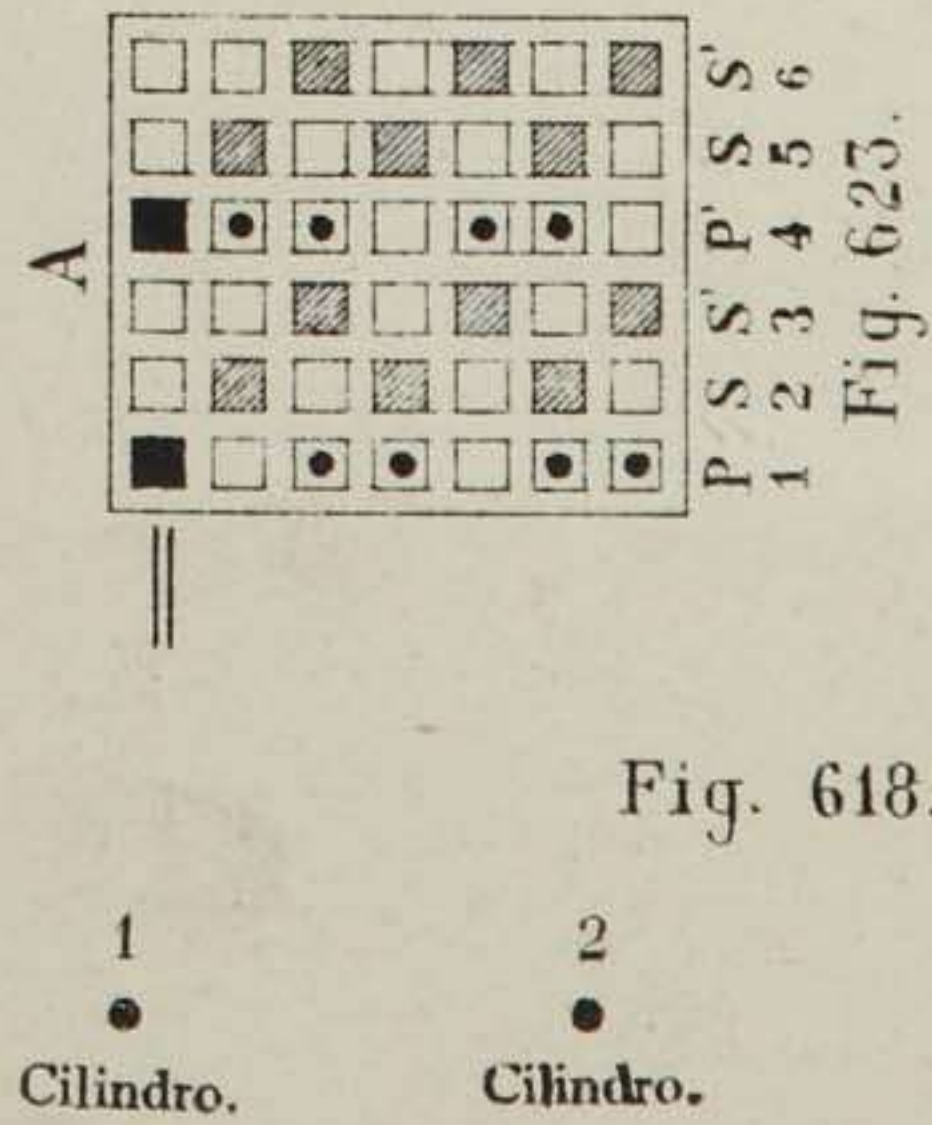


Fig. 615.

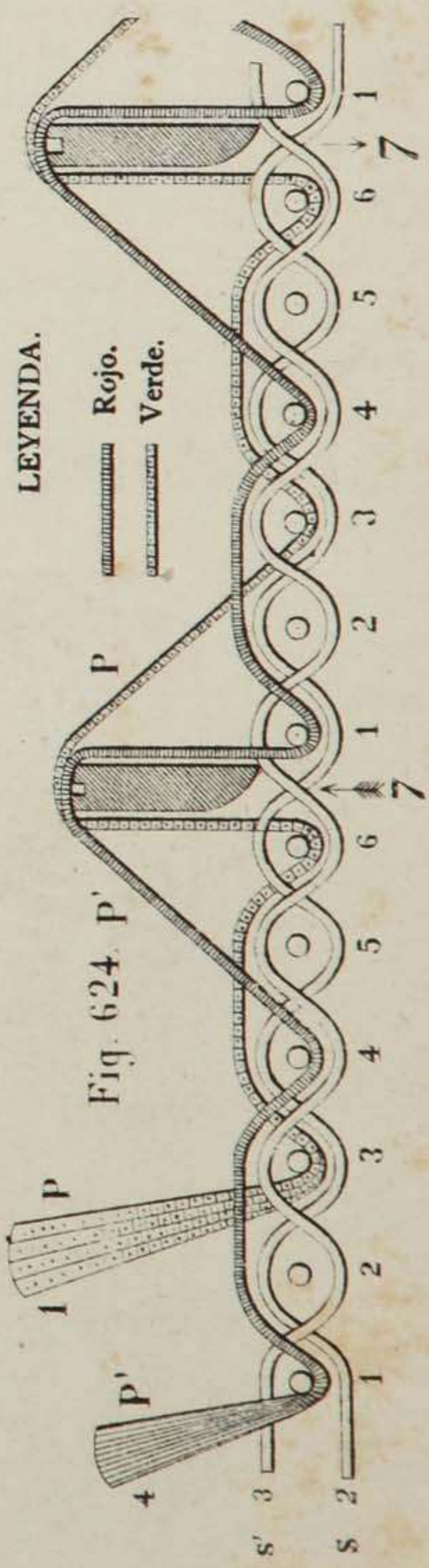
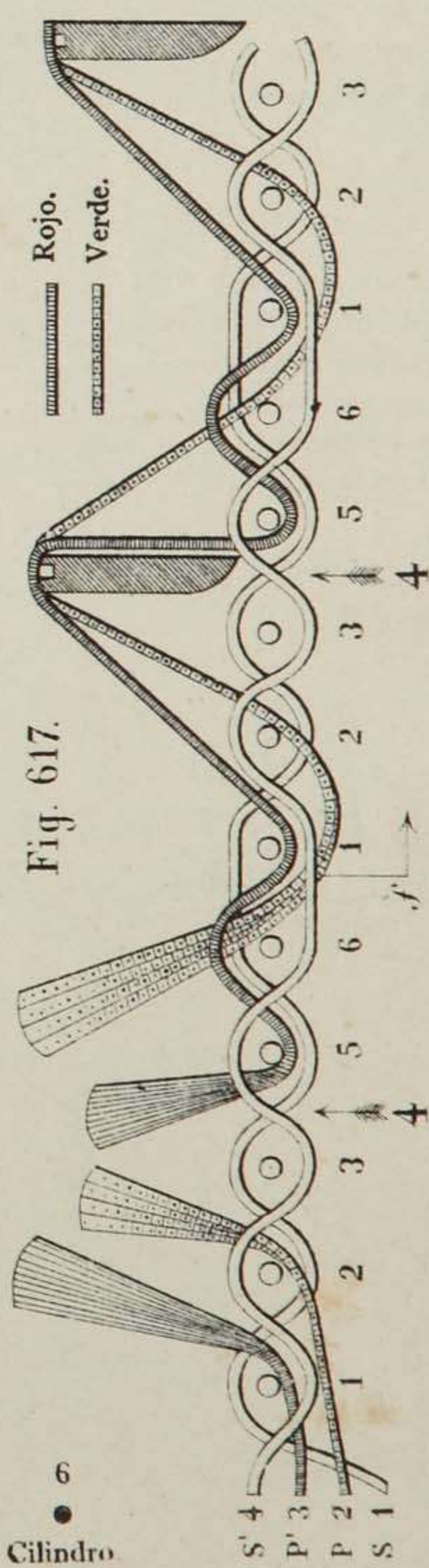


LEYENDA.
de las figs. 593 y 613.

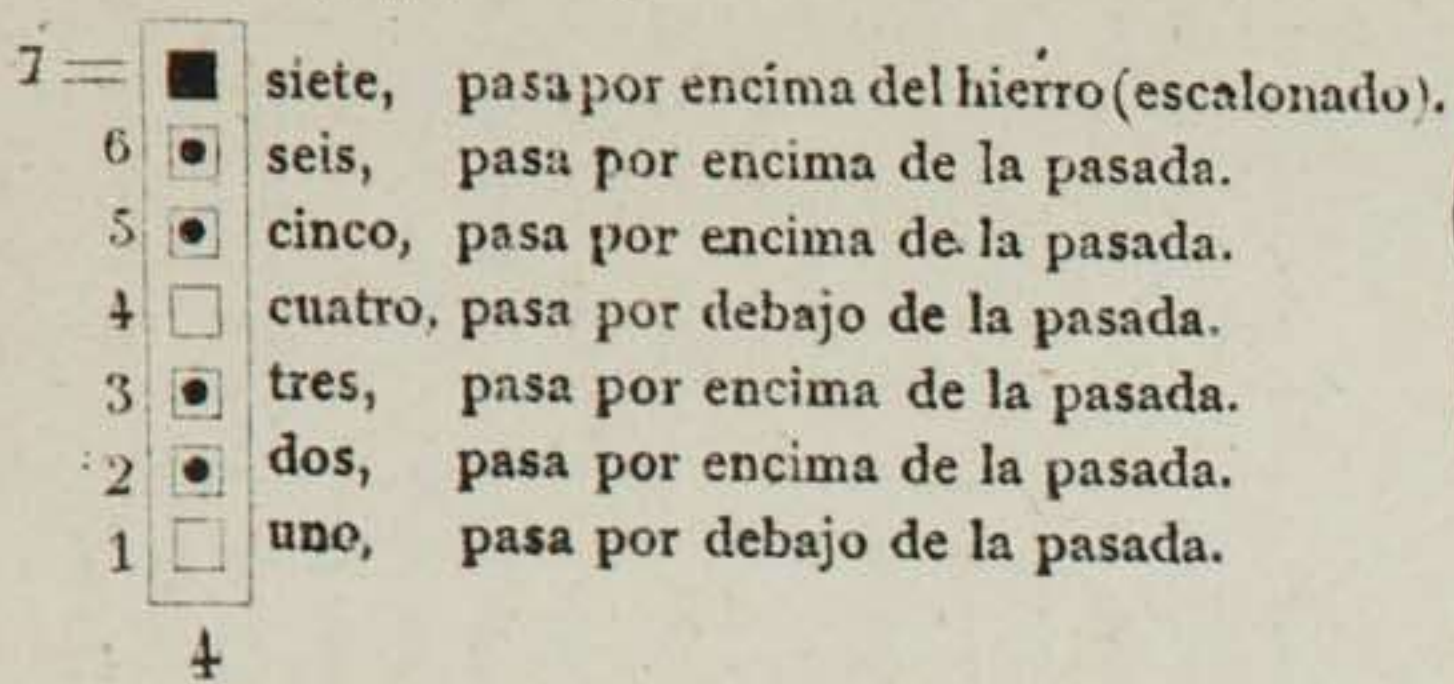
Pelo rojo P.



LEYENDA.



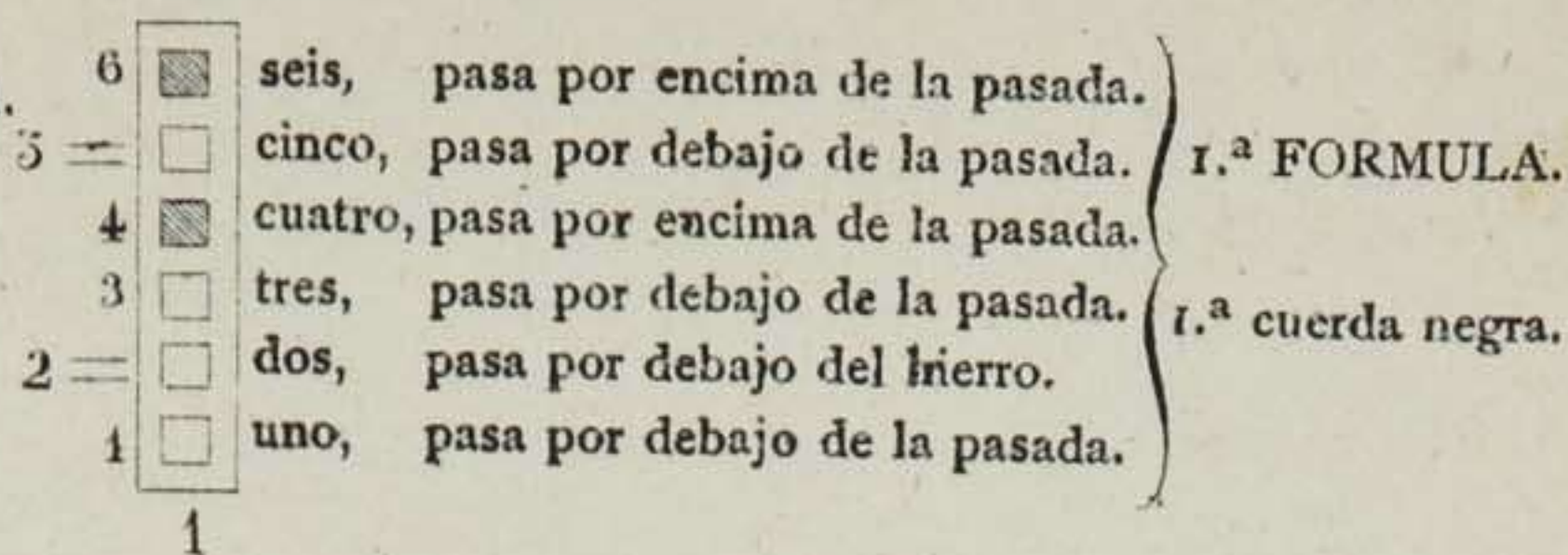
2.º Pelo P (rojo). Fig. 628.



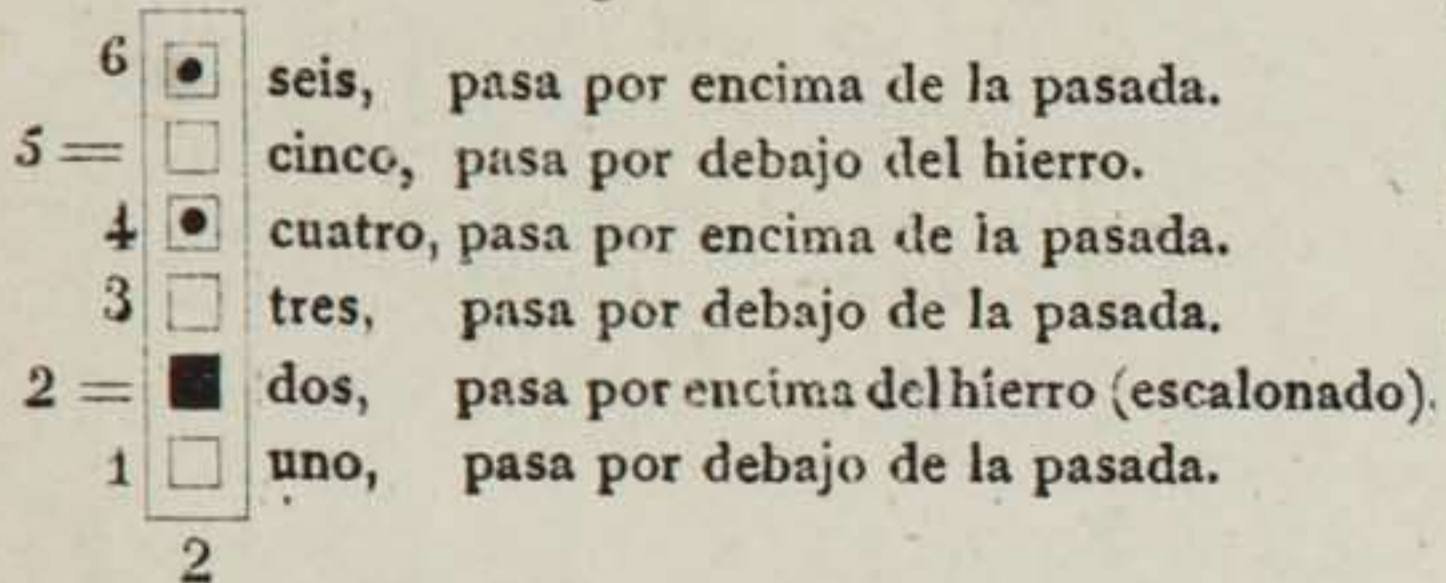
4.ª FORMULA.

Cuerda roja.
(Terciopelo).

1.er hilo S. Fig. 633.



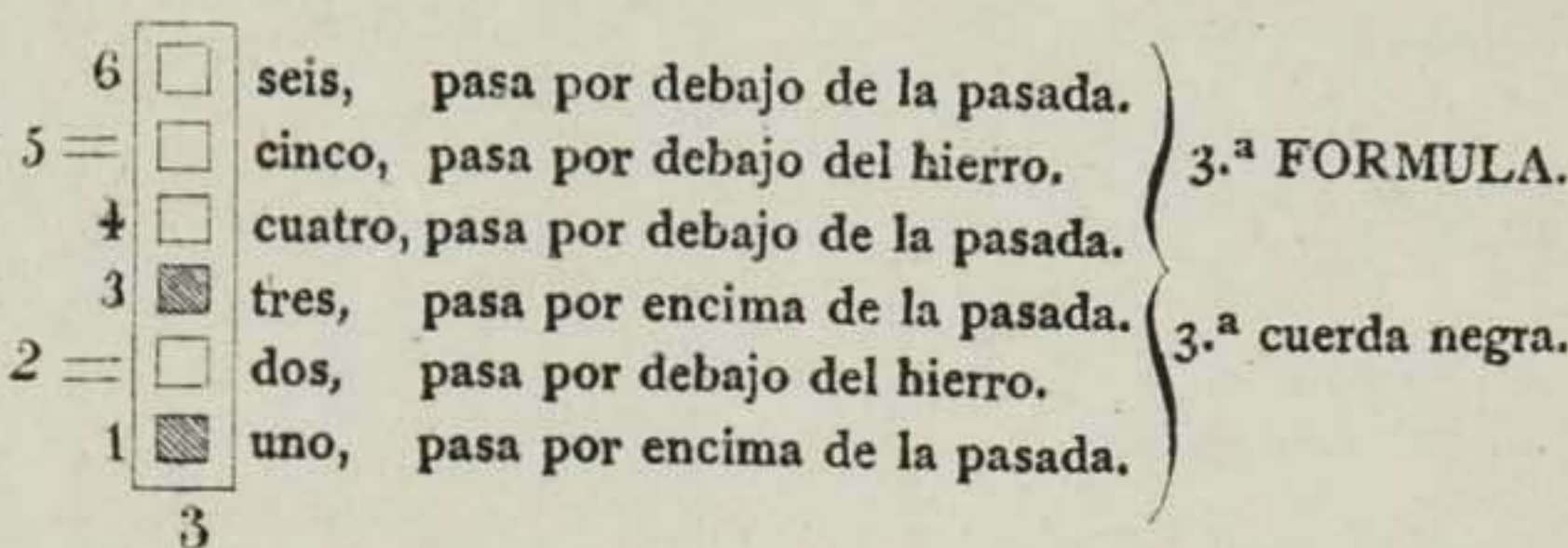
1.er Pelo P. Fig. 634.



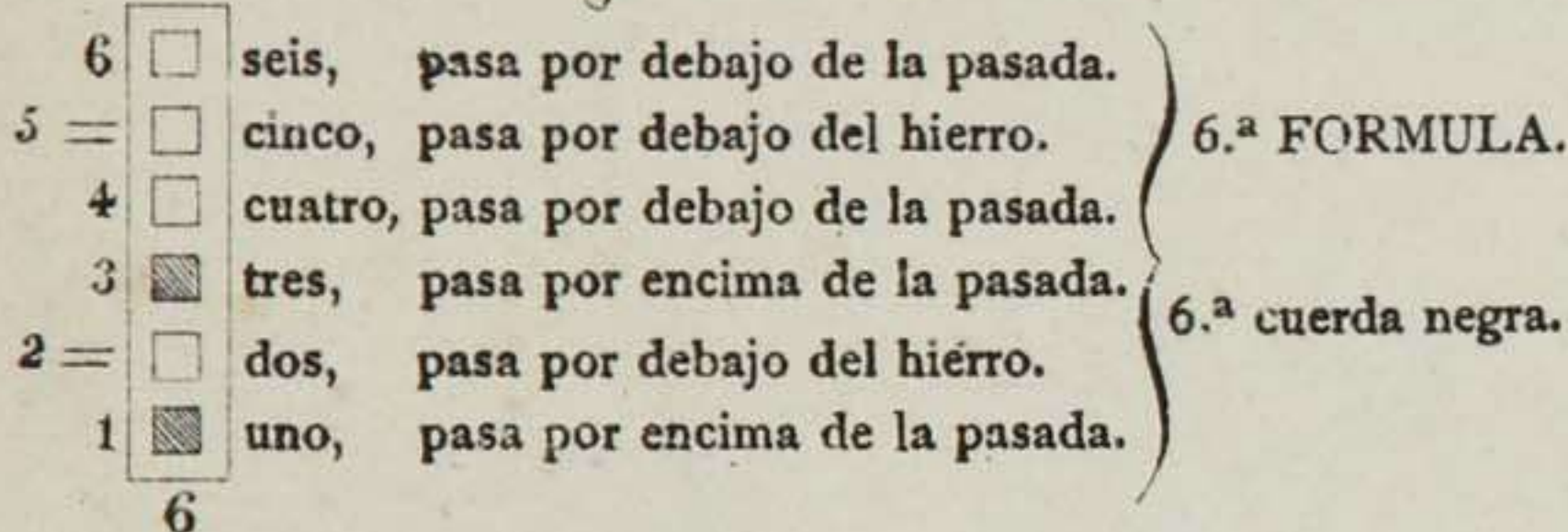
2.ª FORMULA.

2.ª cuerda roja.

2.º hilo S'. Fig. 635.

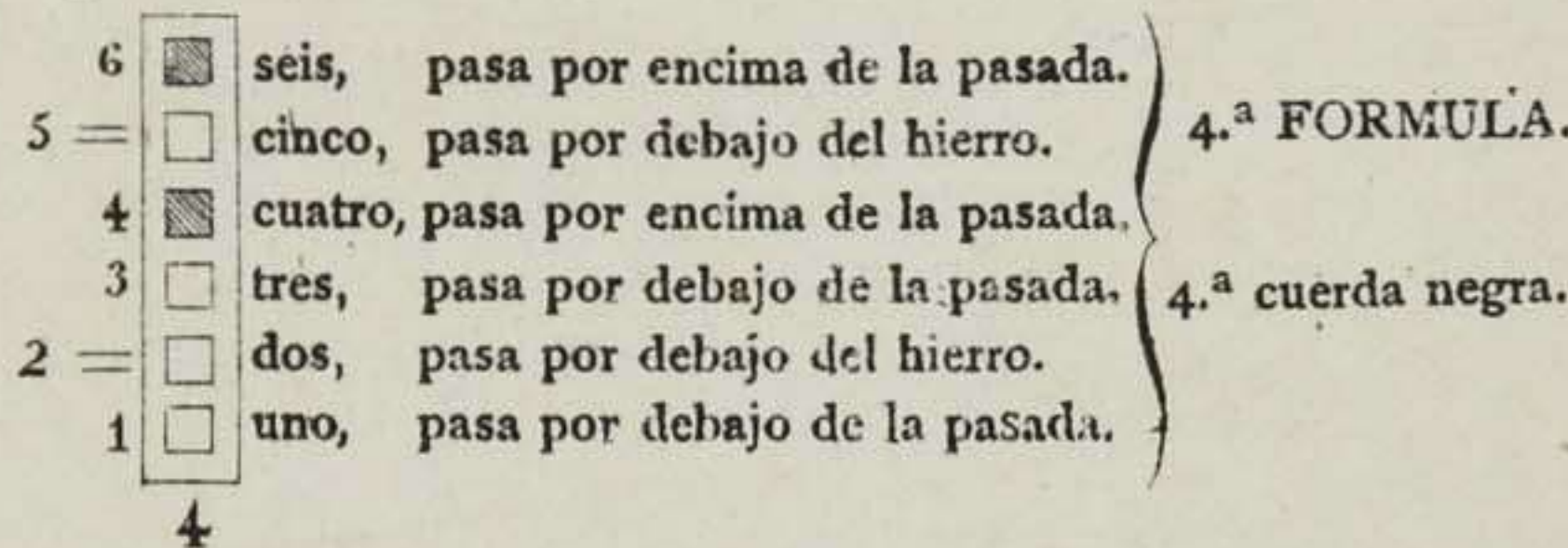


4.º hilo S'. Fig. 638.

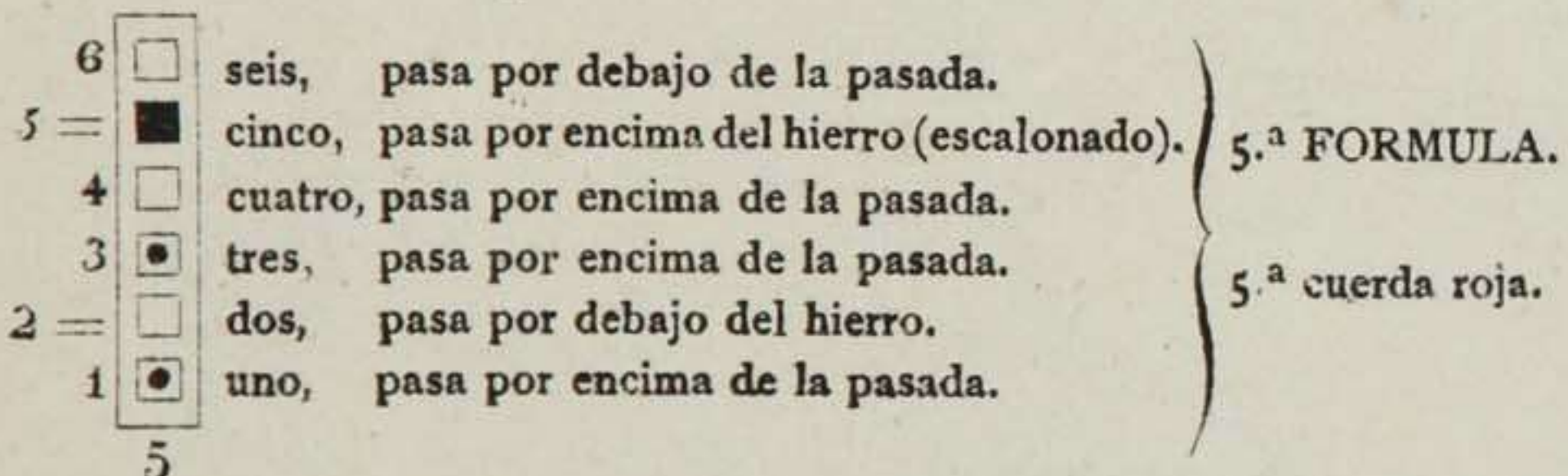


6.ª cuerda negra.

3.er hilo S. Fig. 636.



2.º Pelo P'. Fig. 637.



5.ª cuerda roja.

Fig. 632.
V

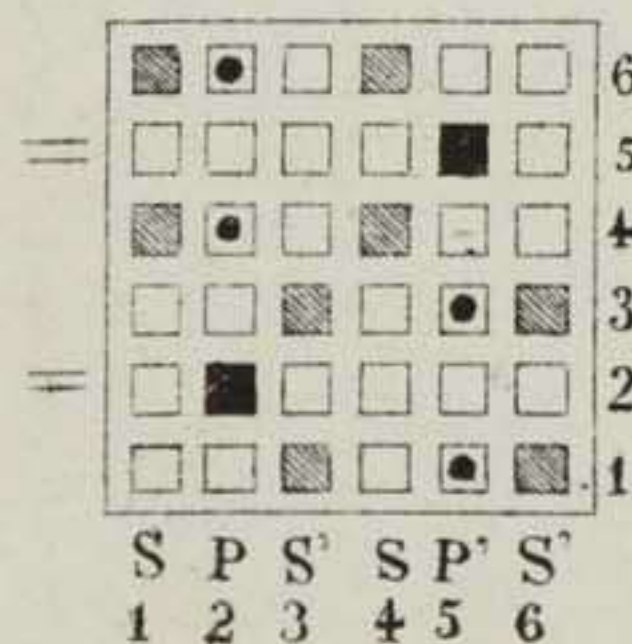


Fig. 639.
V'

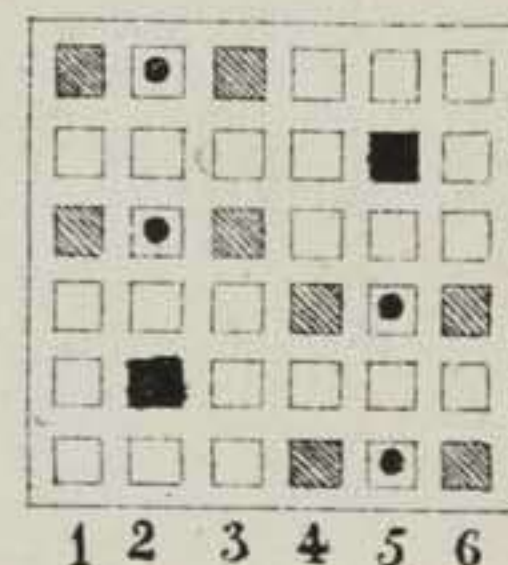


Fig. 630.

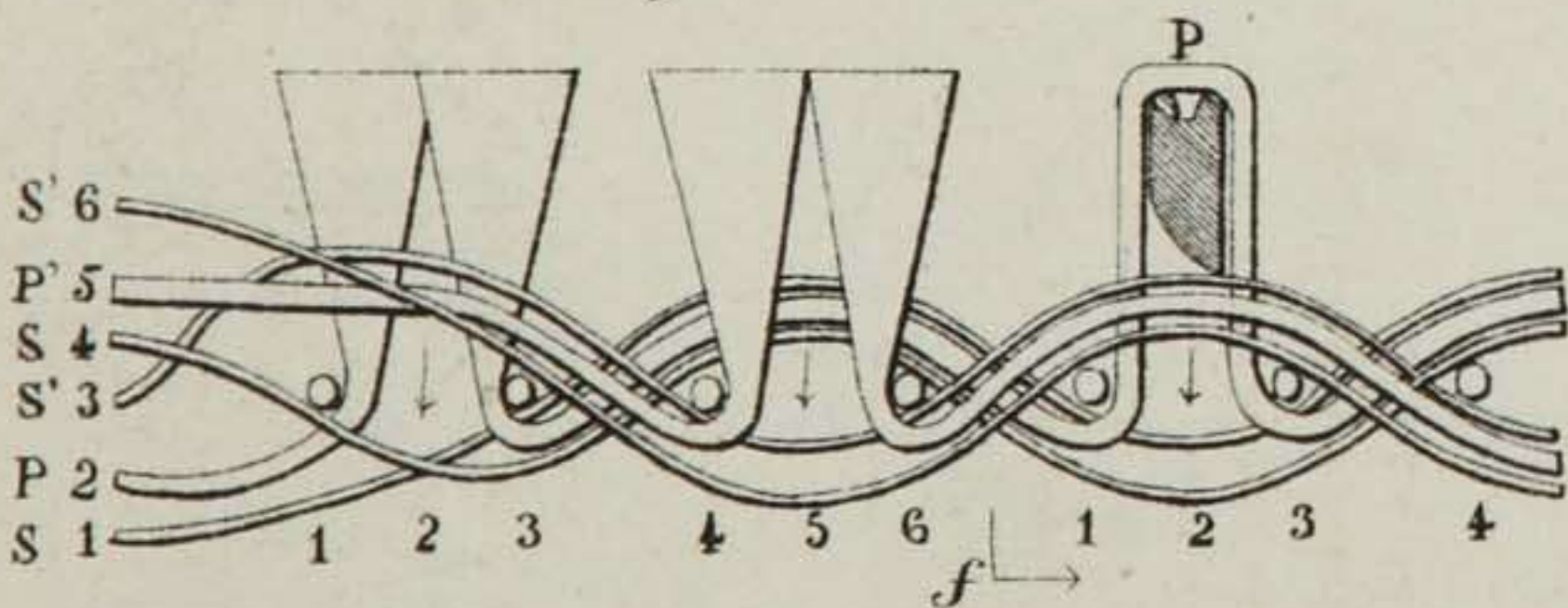


Fig. 631.

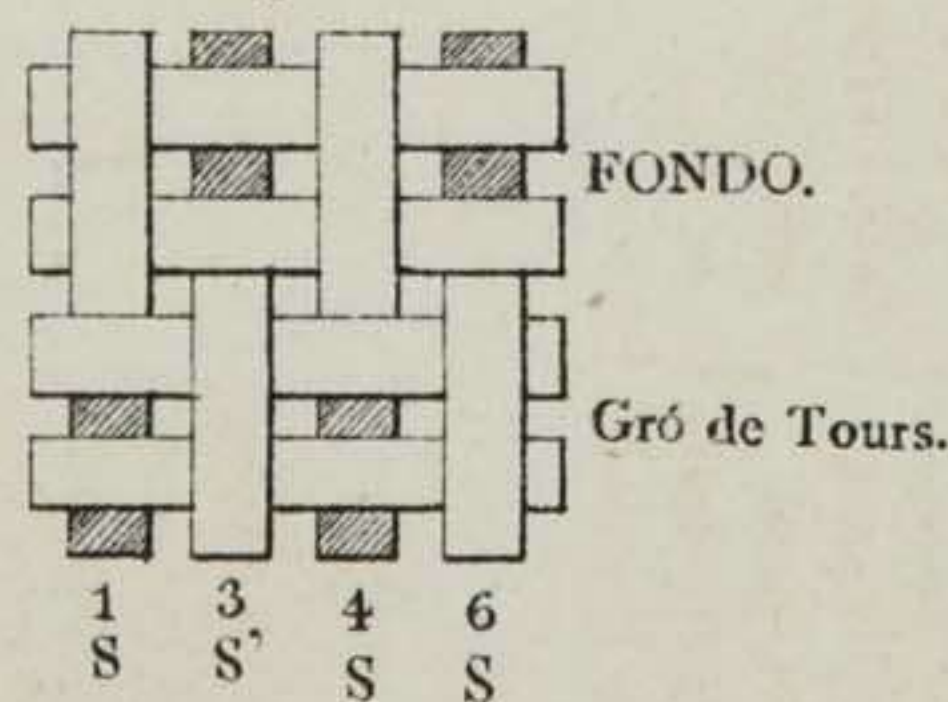


Fig. 641.

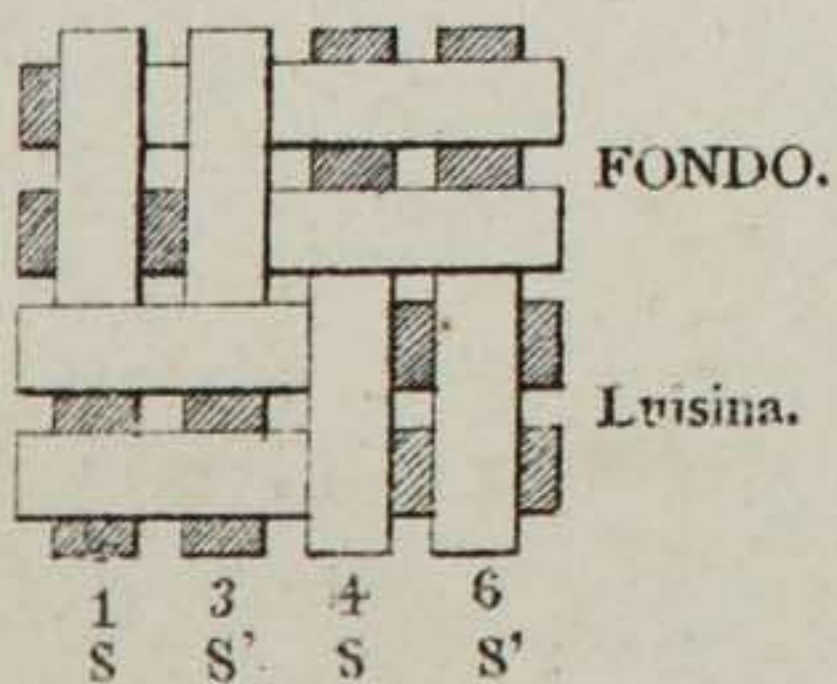


Fig. 640.

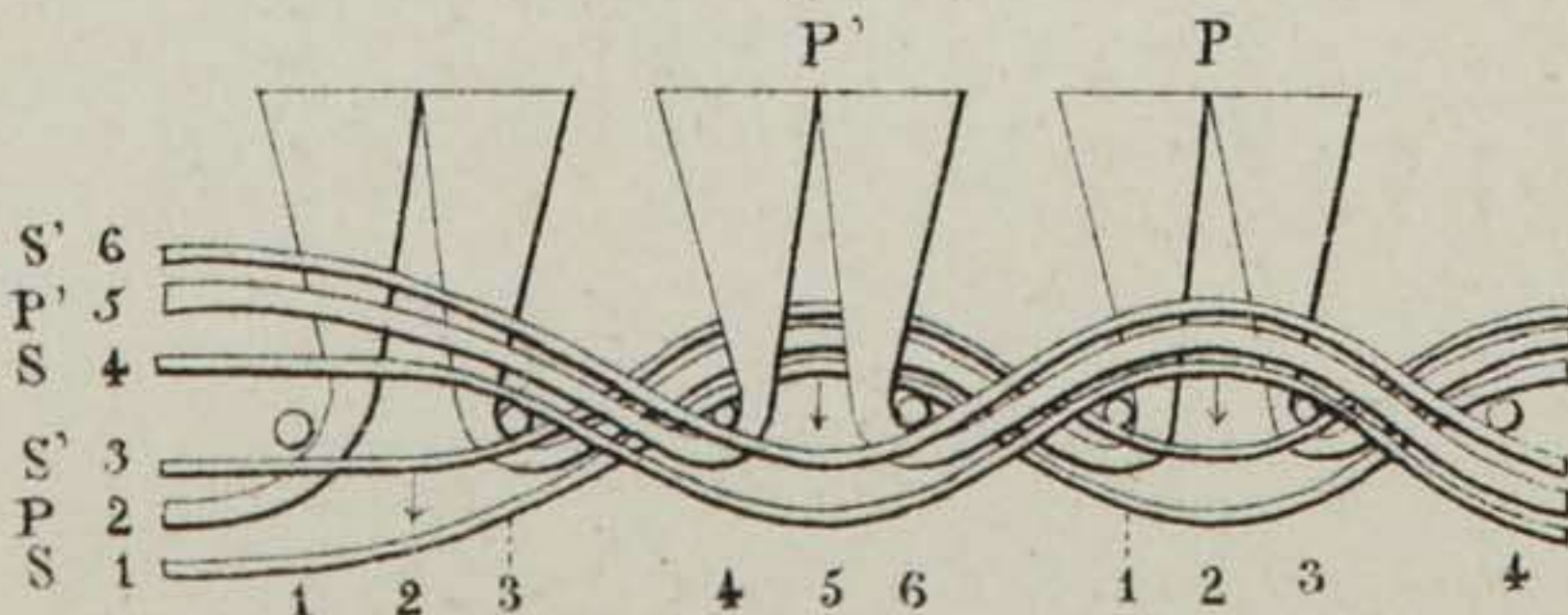


Fig. 645.

1.º er hilo S.

7	□
6	■
5	□
4	■
3	□
2	■
1	□

1.ª FORMULA.

Cuerda negra para tejido de alma.

7 siete, pasa por debajo de la pasada.
 6 seis, pasa por encima de la pasada.
 5 cinco, pasa por debajo de la pasada.
 4 cuatro, pasa por encima de la perdida.
 3 tres, pasa por debajo del hierro.
 2 dos, pasa por encima de la perdida.
 1 uno, pasa por encima de la pasada.

Fig. 646.

1.º er Pelo P verde.

7	□
6	■
5	□
4	■
3	□
2	■
1	□

2.ª FORMULA.

Cuerda verde para terciopelo.

7 siete, pasa por debajo de la pasada.
 6 seis, pasa por debajo de la pasada.
 5 cinco, pasa por encima de la pasada.
 4 cuatro, pasa por debajo de la perdida.
 3 tres, pasa por encima del hierro (escalonado).
 2 dos, pasa por debajo de la perdida.
 1 uno, pasa por debajo de la pasada.

Fig. 647.

2.º hilo S'.

7	■
6	□
5	■
4	□
3	■
2	□
1	■

3.ª FORMULA.

Cuerda negra para tejido de alma.

7 siete, pasa por encima de la pasada.
 6 seis, pasa por debajo de la pasada.
 5 cinco, pasa por encima de la pasada.
 4 cuatro, pasa por encima de la perdida.
 3 tres, pasa por debajo del hierro.
 2 dos, pasa por encima de la perdida.
 1 uno, pasa por encima de la pasada.

Fig. 648.

A

8	■
7	□
6	■
5	□
4	■
3	□
2	■
1	□

2.º Pelo P' rojo.

7 siete, pasa por debajo de la pasada.
 6 seis, pasa por encima de la pasada.
 5 cinco, pasa por debajo de la pasada.
 4 cuatro, pasa por encima de la perdida.
 3 tres, pasa por encima del hierro (escalonado).
 2 dos, pasa por encima de la perdida.
 1 uno, pasa por encima de la pasada.

Fig. 644.

3	●	Hierro
1	●	Pasada
2	●	Perdida

1.ª Repeticion.

7	●	Pasada
6	●	Pasada
5	●	Pasada
4	●	Perdida
3	●	Hierro
2	●	Perdida
1	●	Perdida

2.ª Repeticion.

Fig. 643.

LEVENDA. --- Rojo. --- Verde.

Fig. 642.

1.ª Repeticion. 2.ª Repeticion.

7	□	□	□	□	□	□	□	□
6	□	□	□	□	□	□	□	□
5	□	□	□	□	□	□	□	□
4	□	□	□	□	□	□	□	□
3	□	□	□	□	□	□	□	□
2	□	□	□	□	□	□	□	□
1	□	□	□	□	□	□	□	□

3.ª. Hierro único F.

1 2 3 4 | 1 2 3 4
 S P S' P' | S P S' P'

Fig. 650.

C

9	■	□	□	□	□	□	□	□
8	□	□	□	□	□	□	□	□
7	□	□	□	□	□	□	□	□
6	□	□	□	□	□	□	□	□
5	□	□	□	□	□	□	□	□
4	□	□	□	□	□	□	□	□
3	□	□	□	□	□	□	□	□
2	□	□	□	□	□	□	□	□
1	□	□	□	□	□	□	□	□

1 2 3 4
 S S' S' P

Fig. 649.

B D F

6	■	□	□	□	□	□	□	□
5	□	□	□	□	□	□	□	□
4	□	□	□	□	□	□	□	□
3	□	□	□	□	□	□	□	□
2	□	□	□	□	□	□	□	□
1	□	□	□	□	□	□	□	□

4.ª FORMULA.

Cuerda roja para terciopelo.

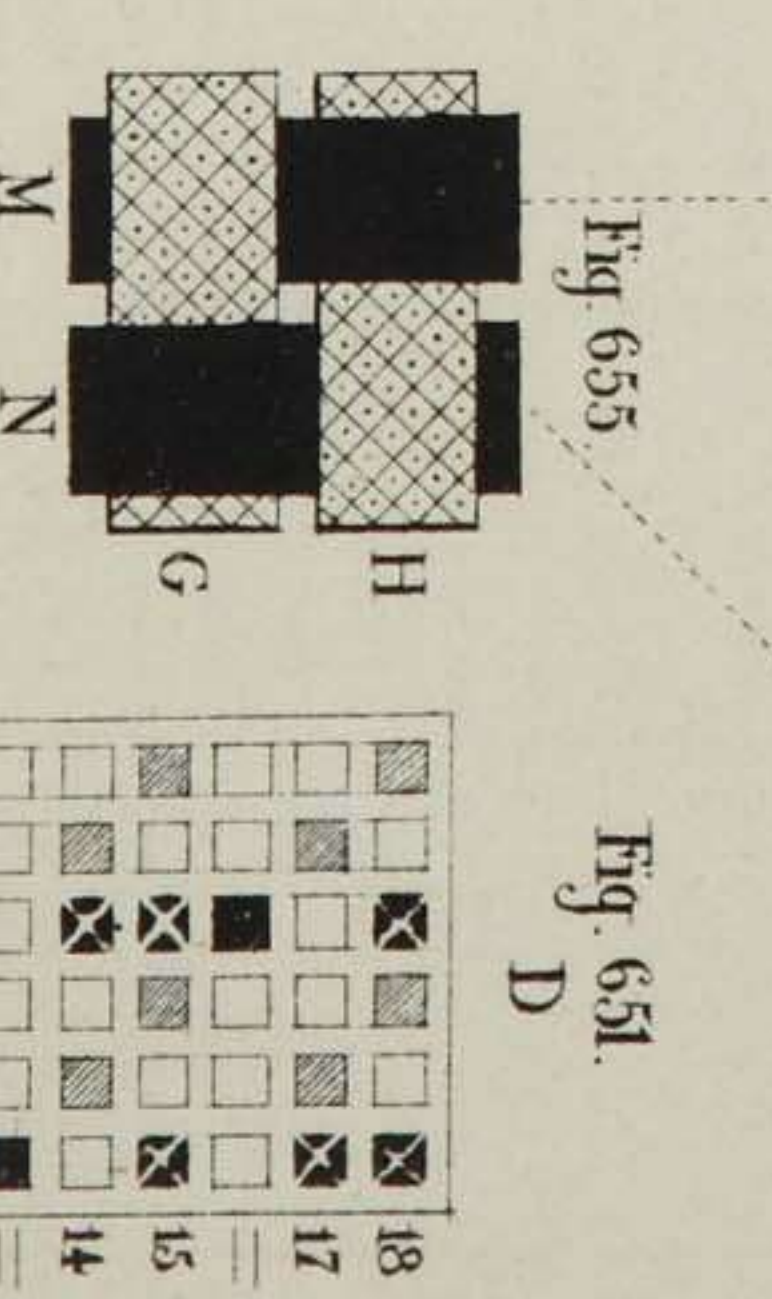
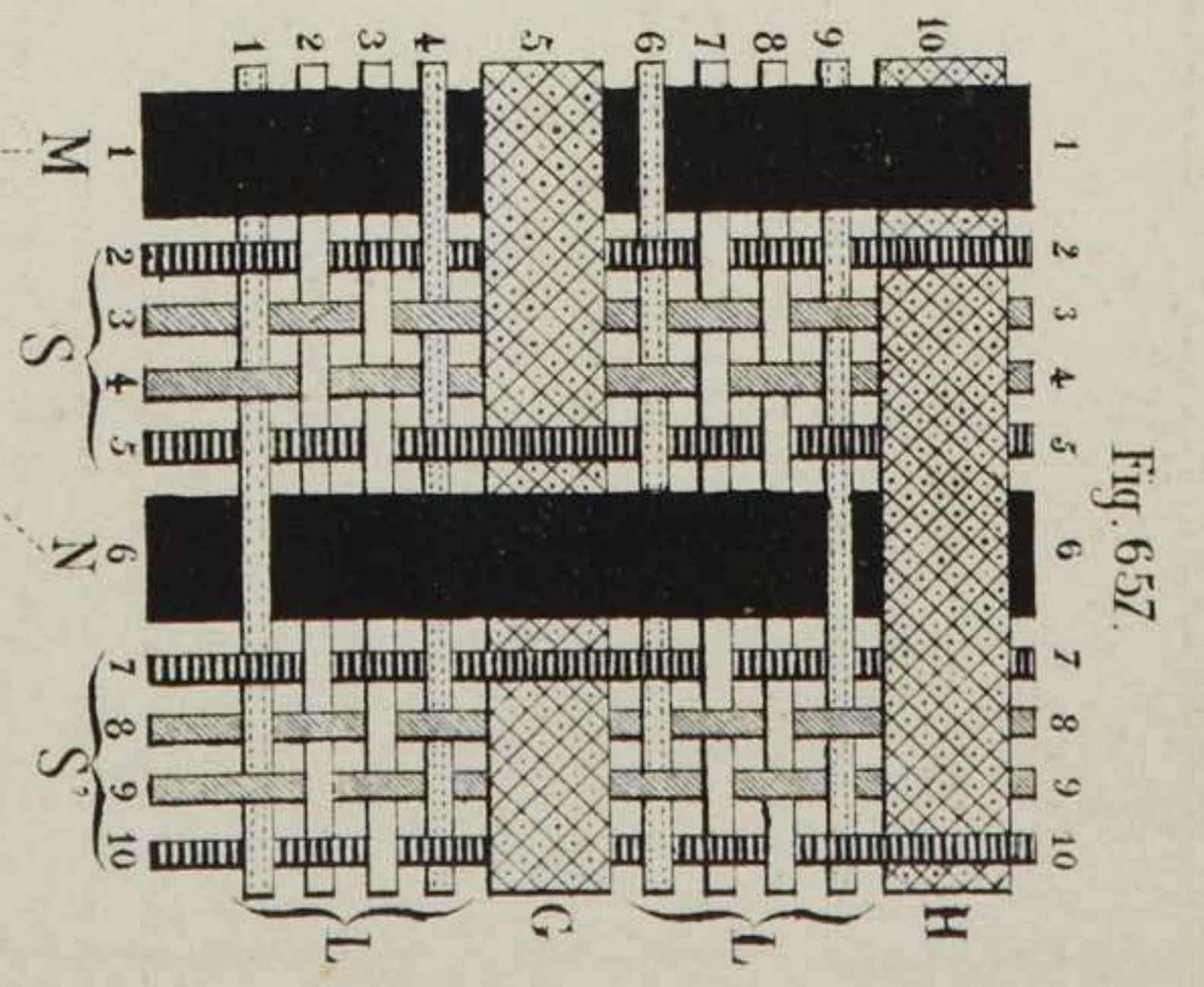
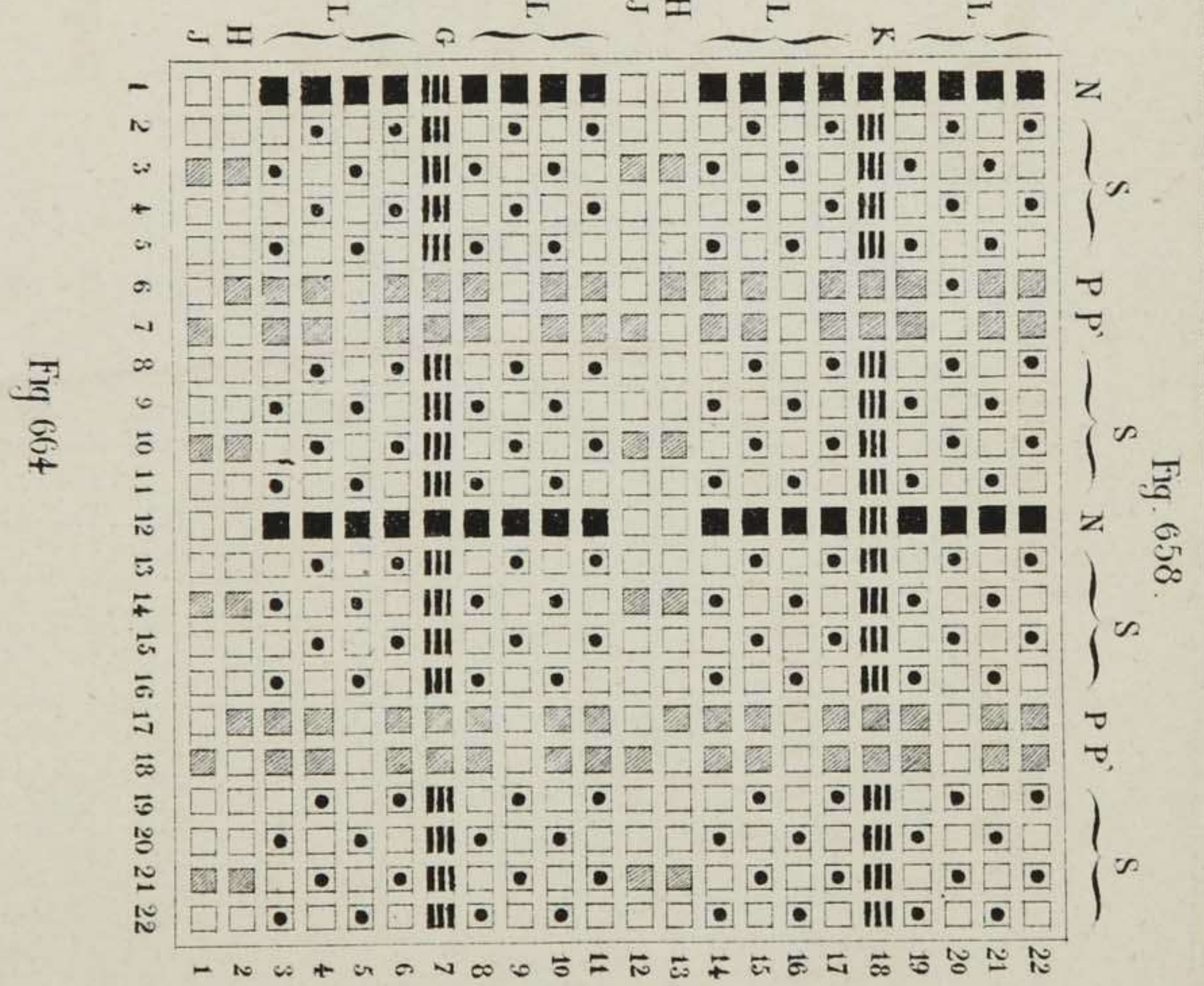
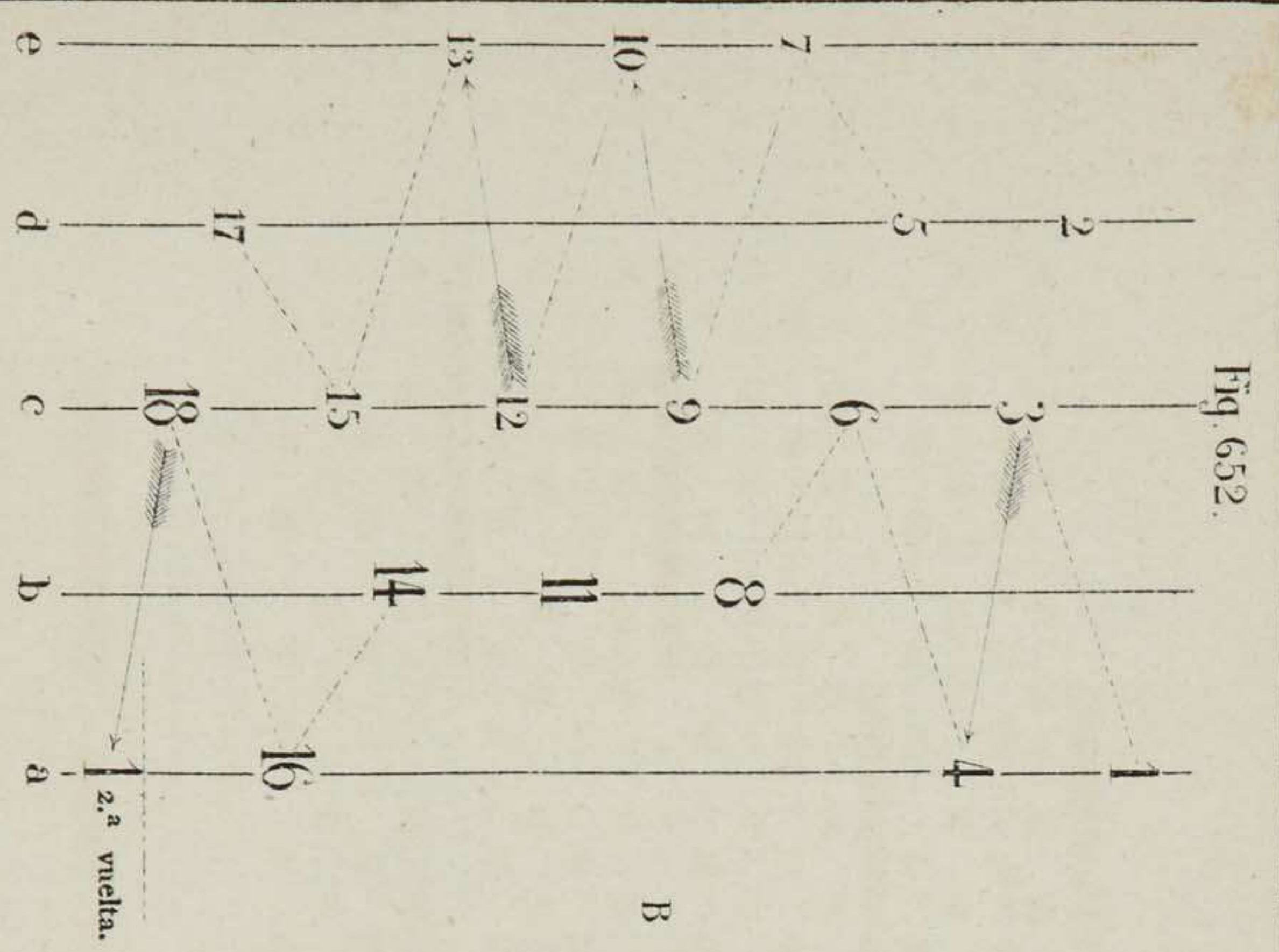


Fig. 656. LEYENDA de los colores de las figs. 654, 655 y 657.

- Pasada blanca.
- Pasada roja gruesa.
- Pasada amarilla.
- Hilo gris.
- Hilo negro grueso.
- » carmin.

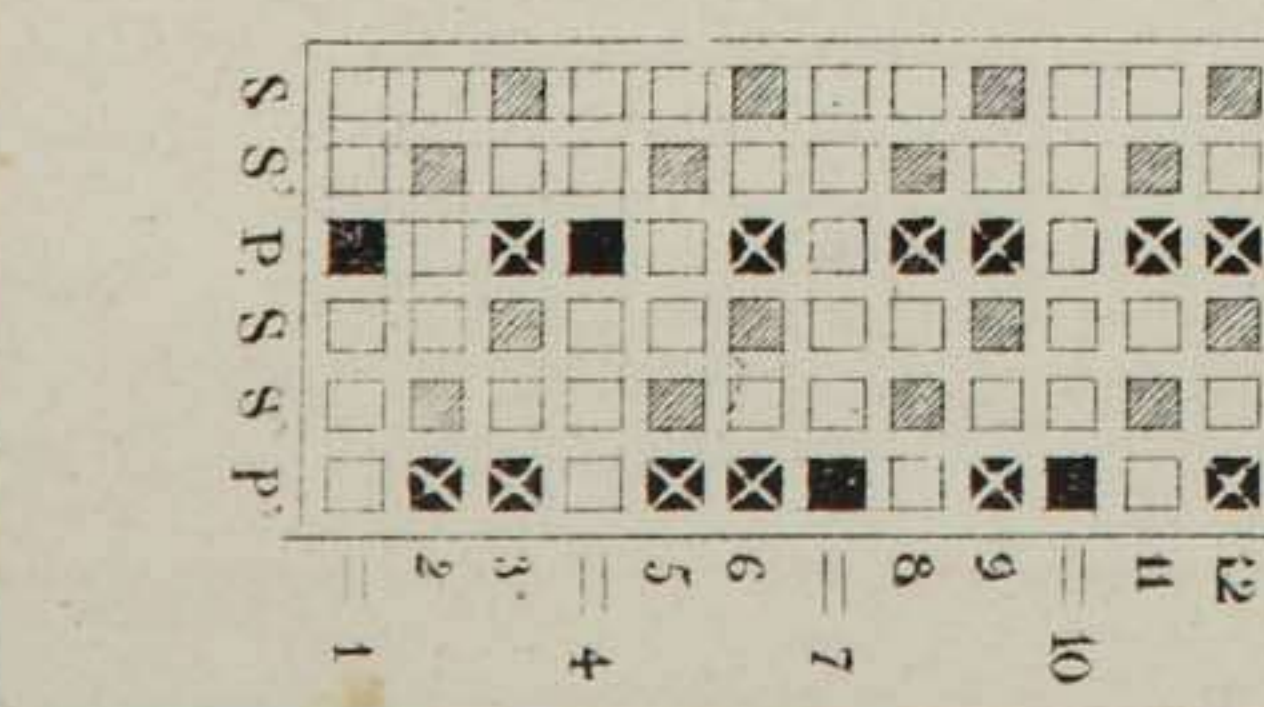
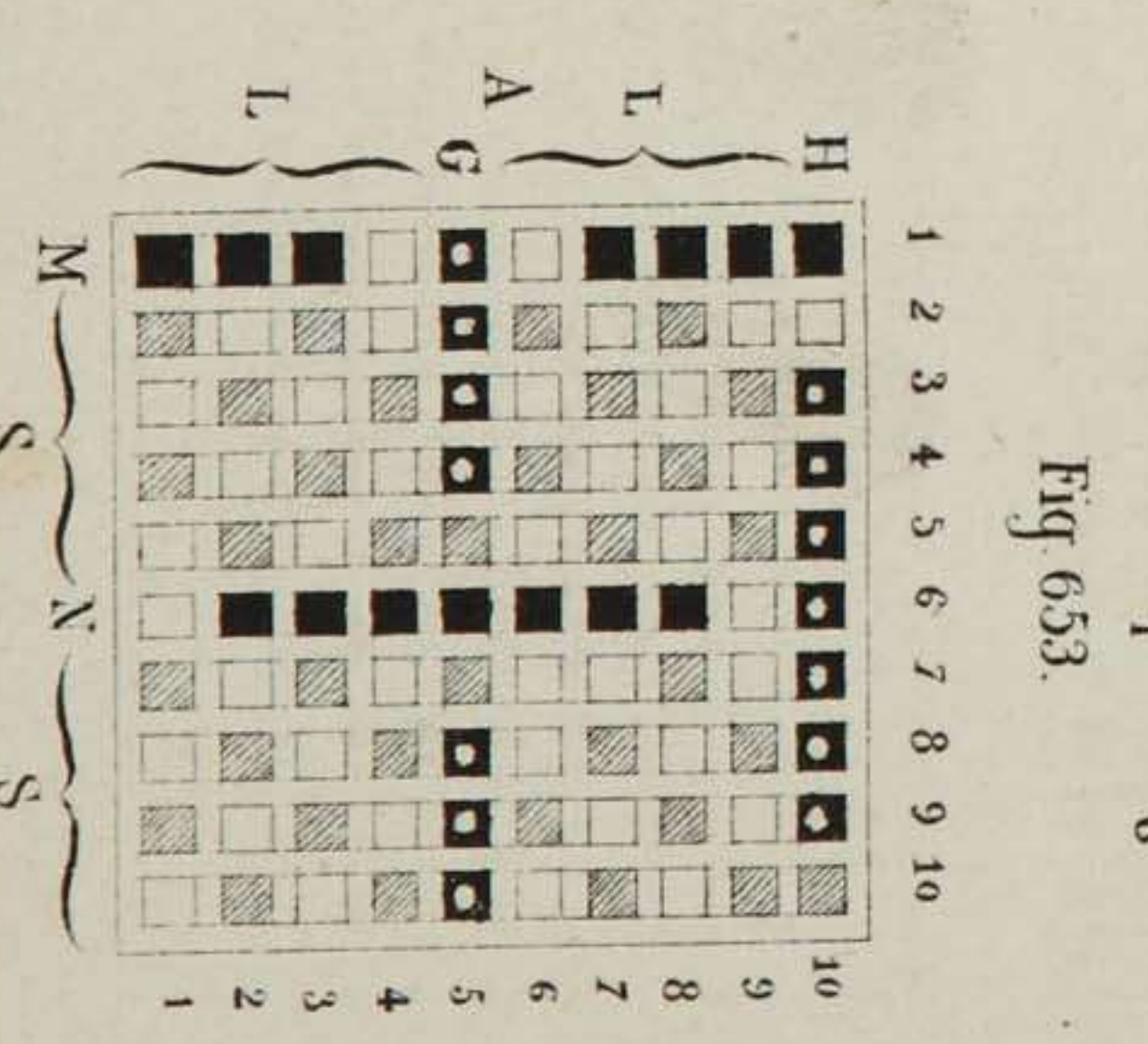
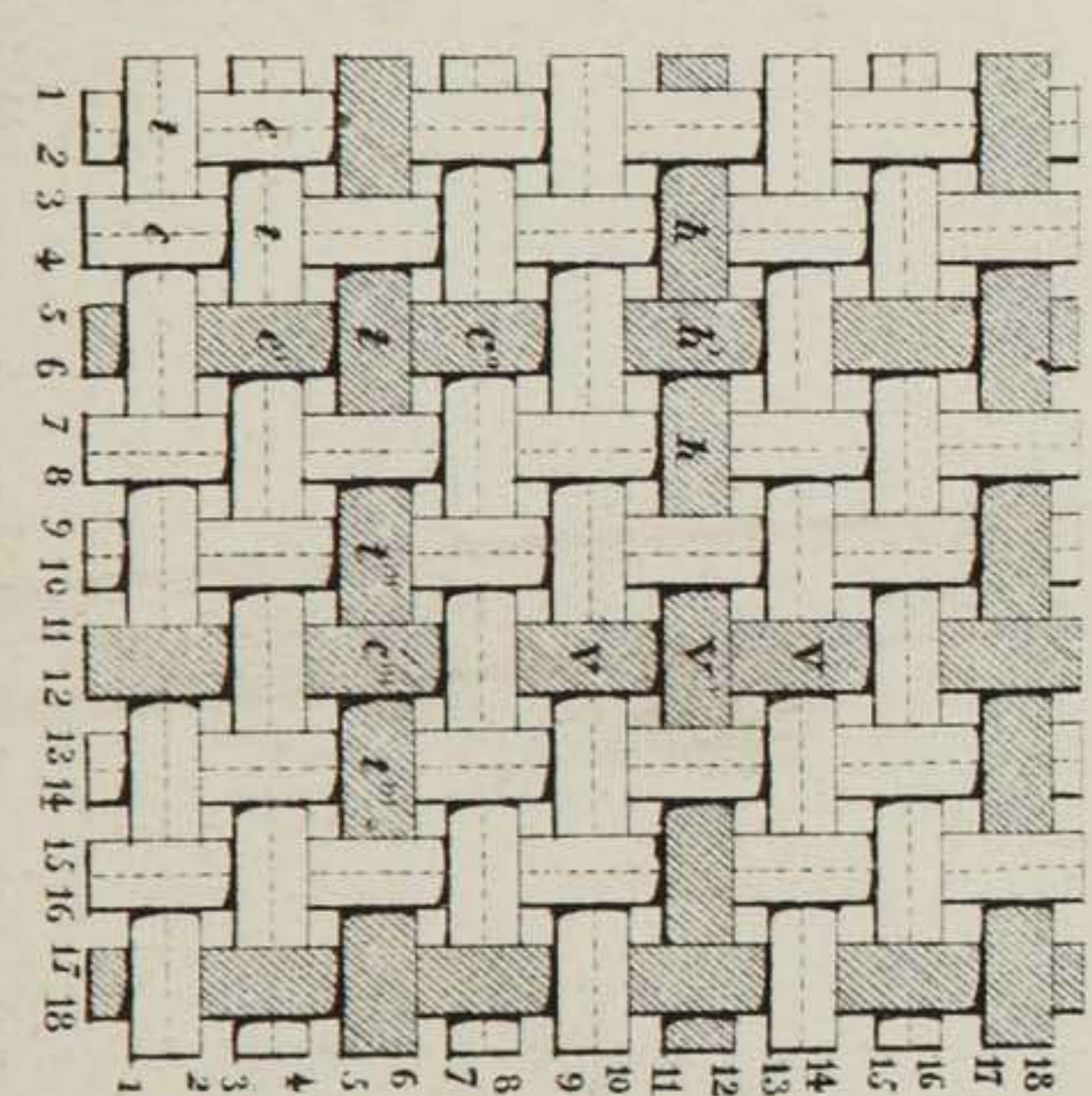
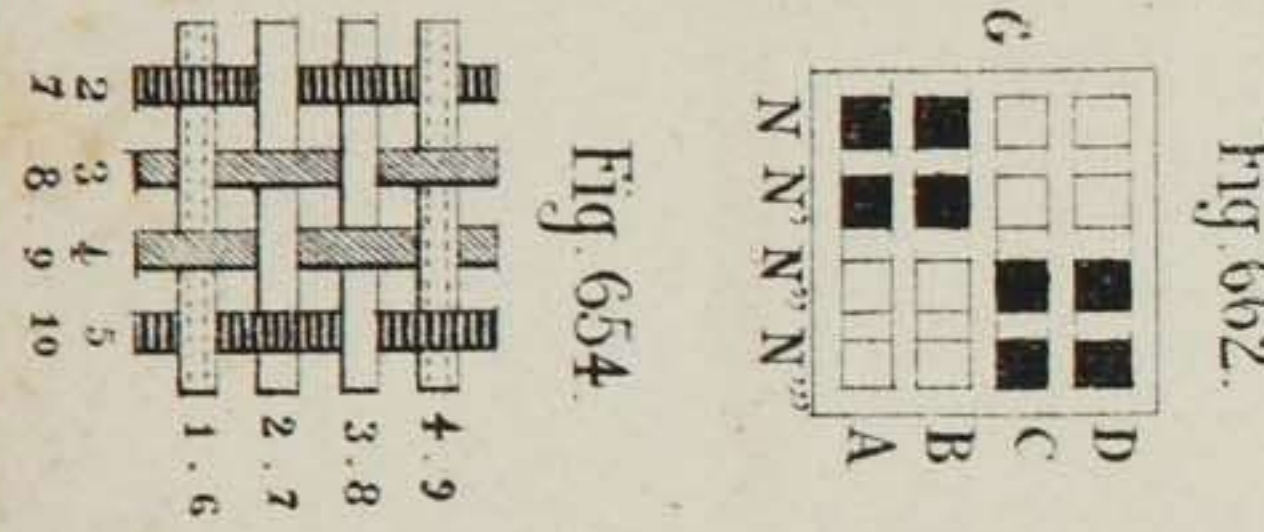
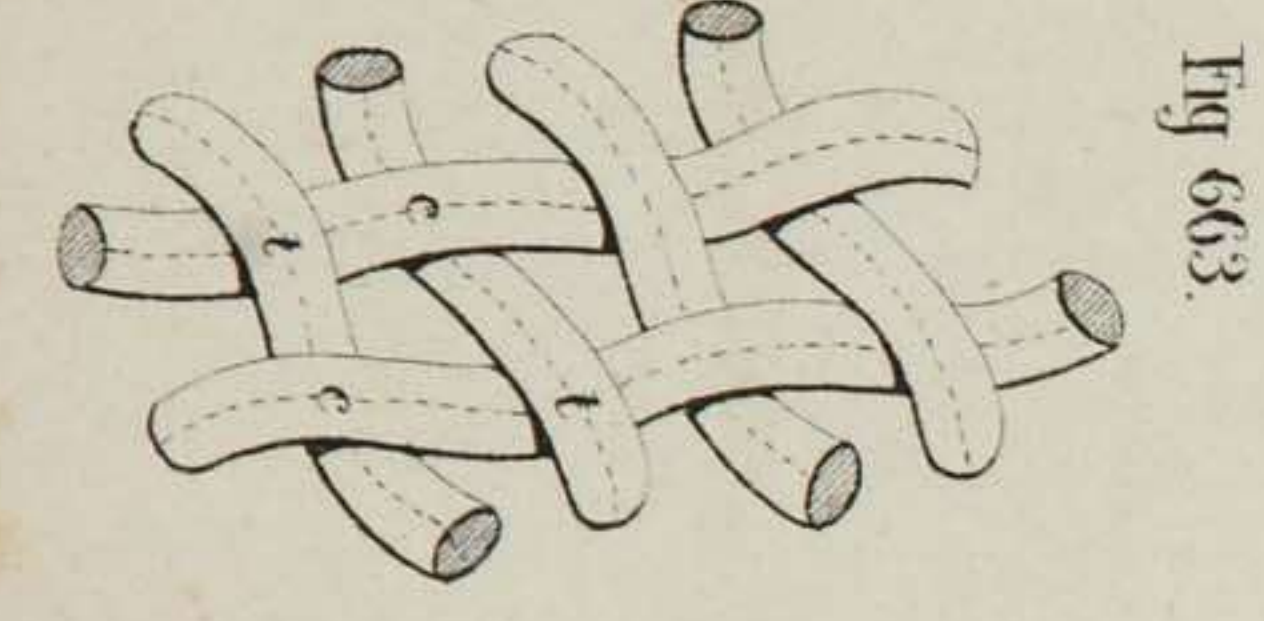


Fig.661.

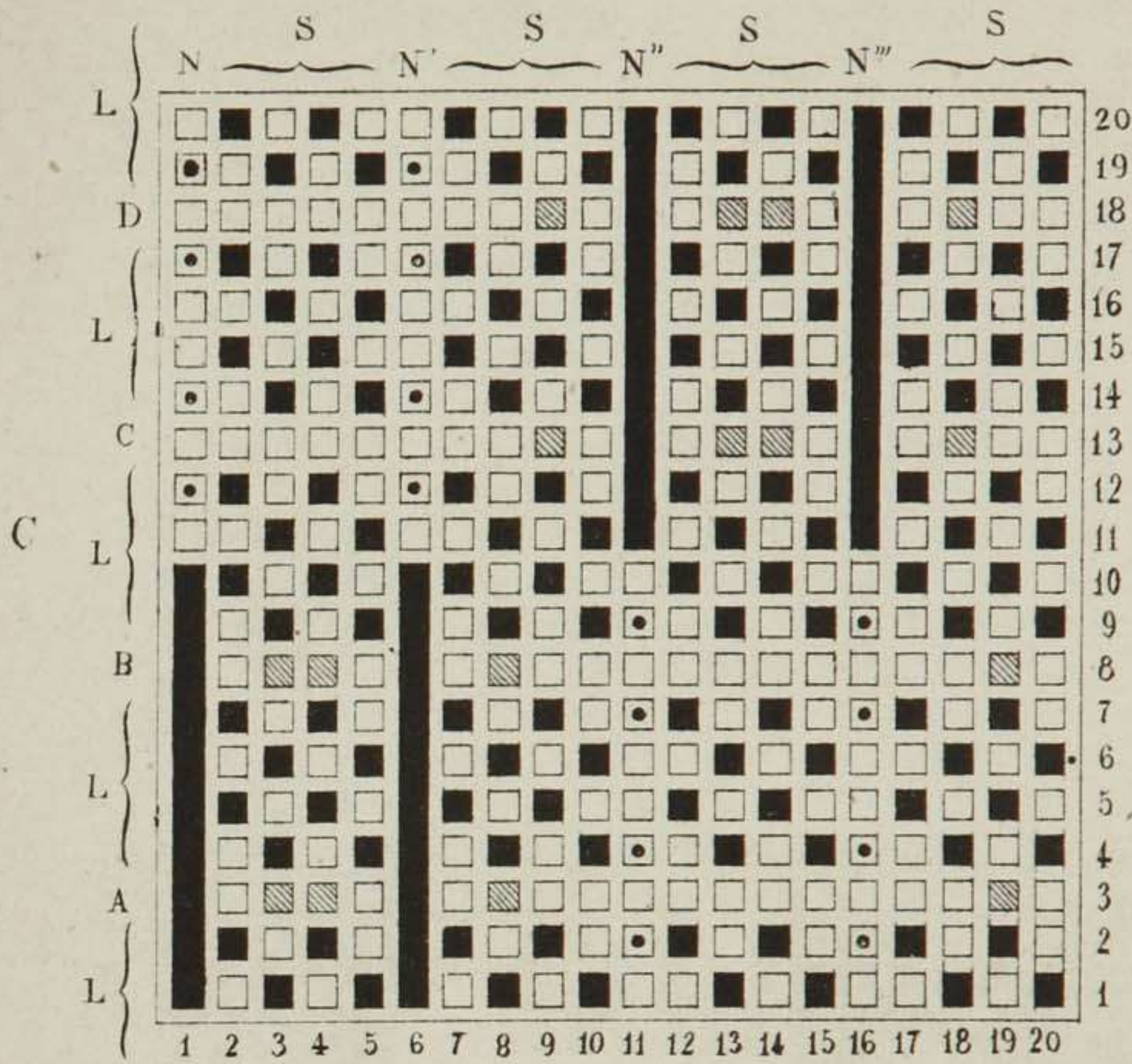


Fig.659.

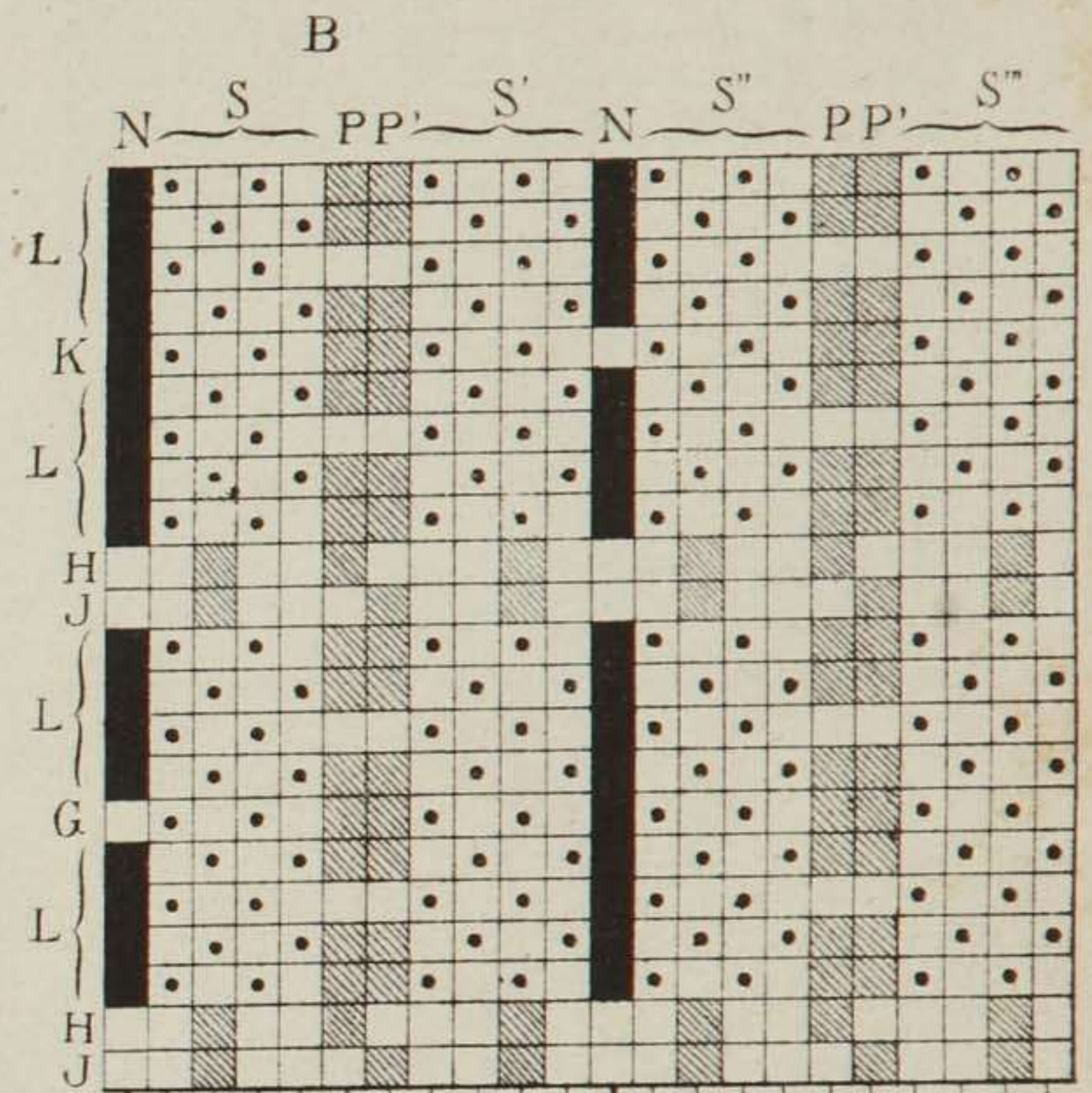


Fig.665.

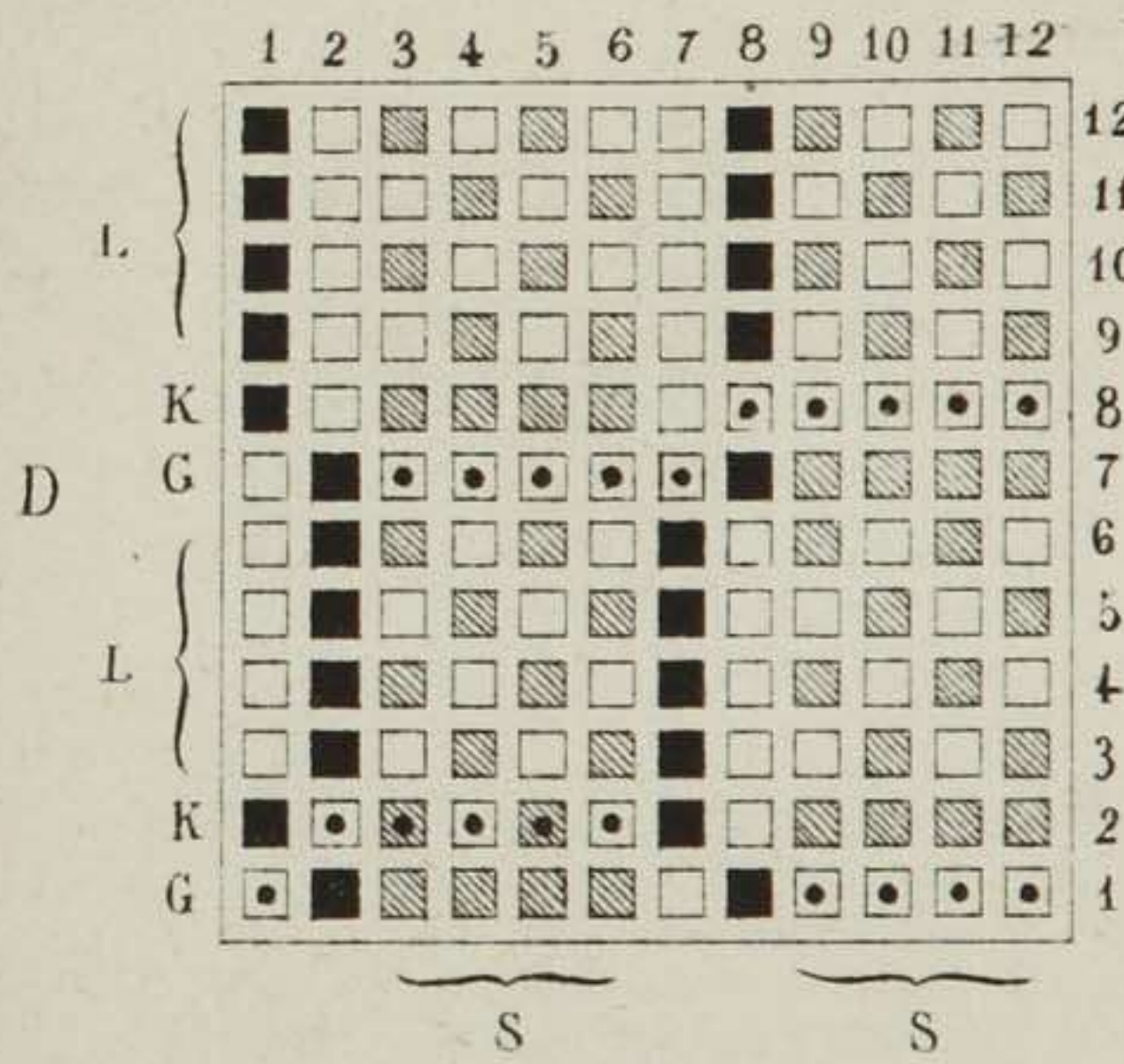


Fig.666.

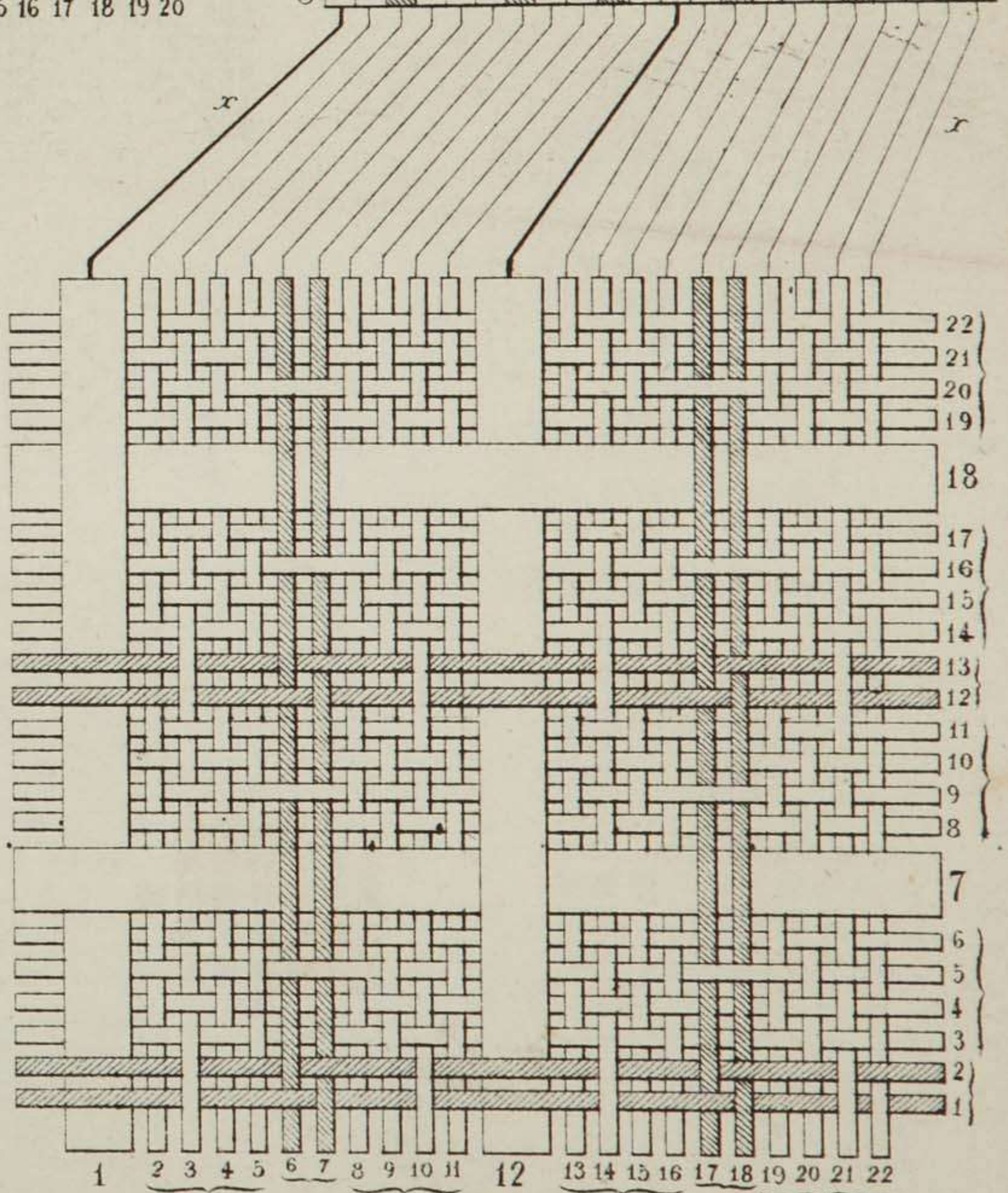
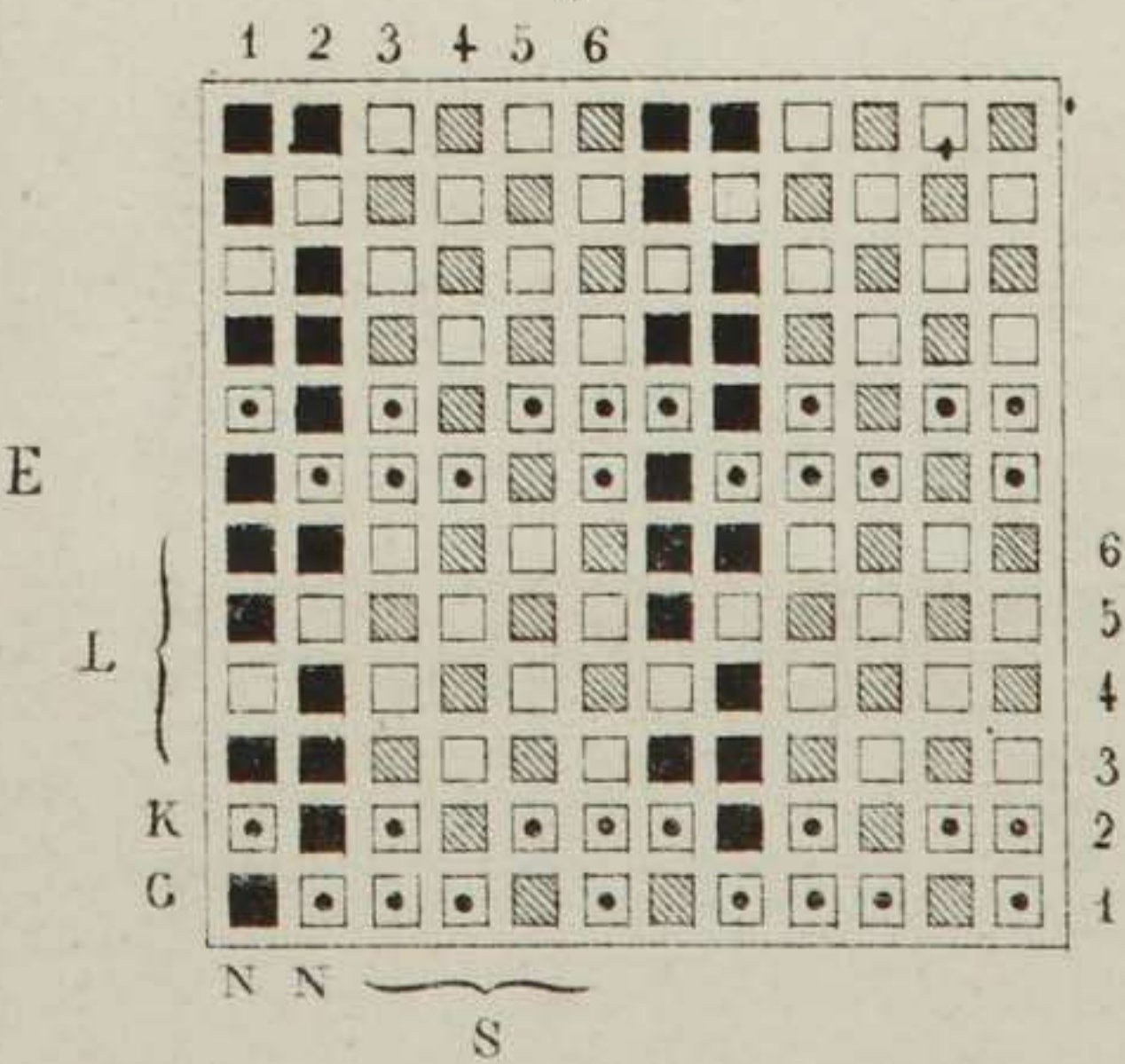


Fig.660.

Fig. 670. A

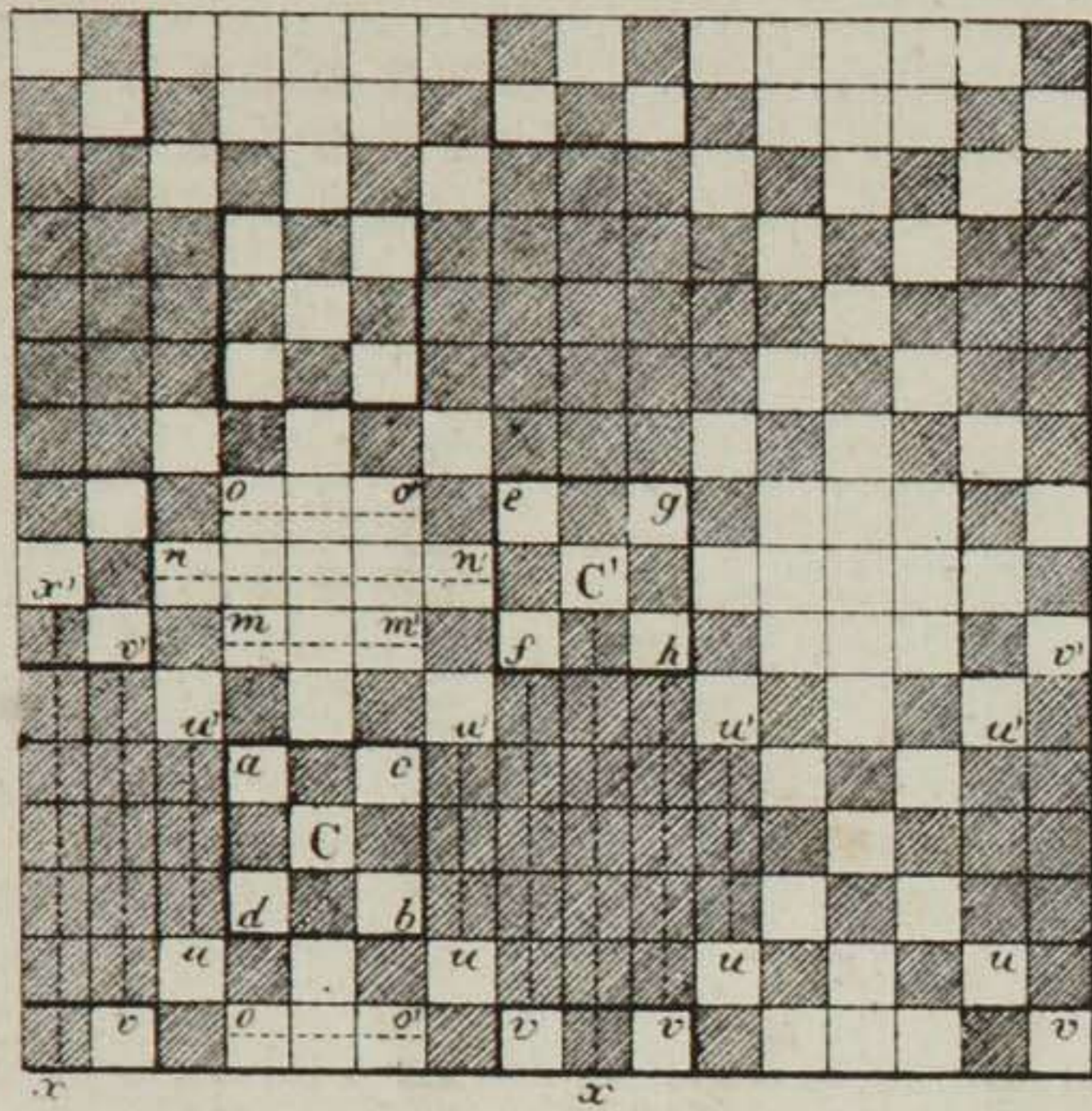


Fig. 672.

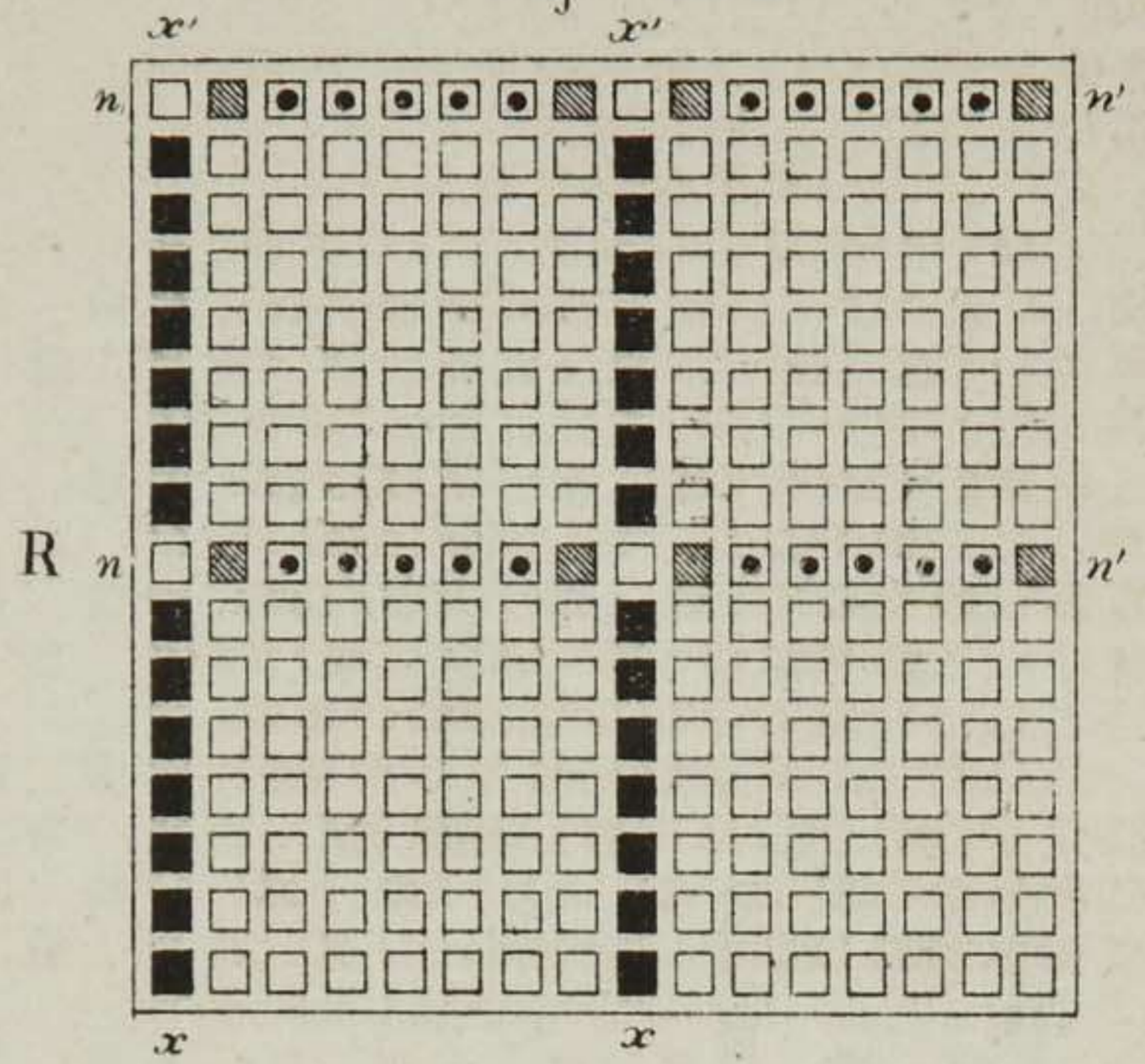


Fig. 669.

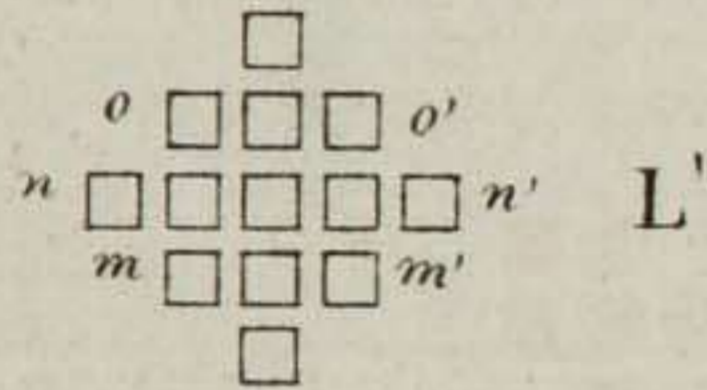


Fig. 676.

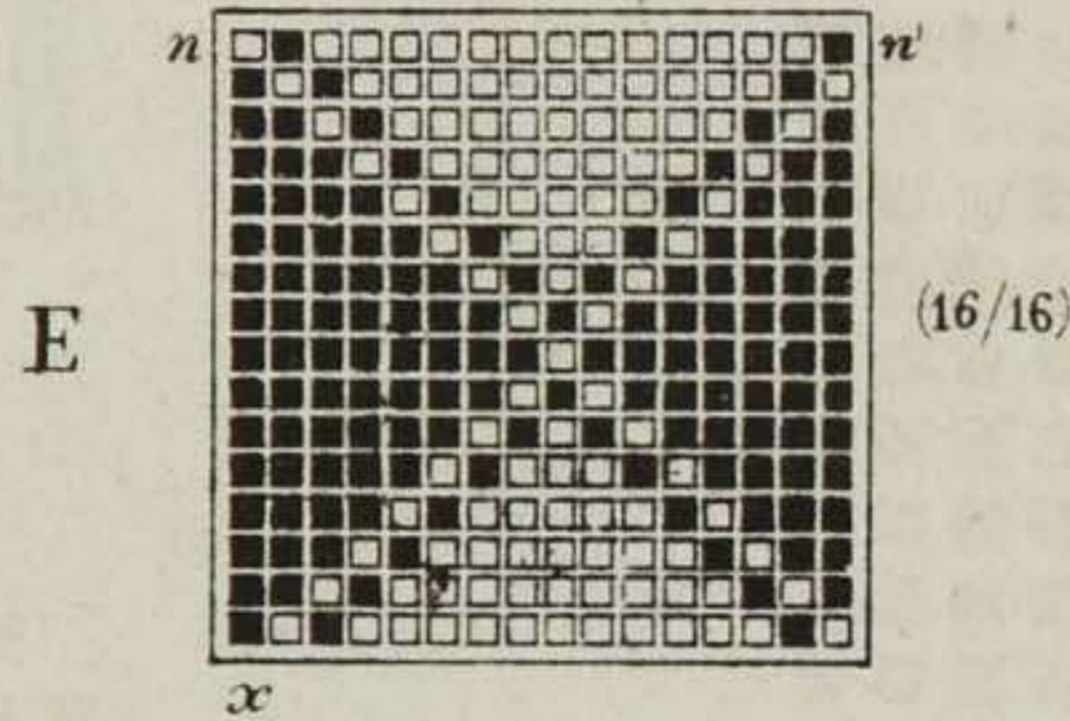


Fig. 673.

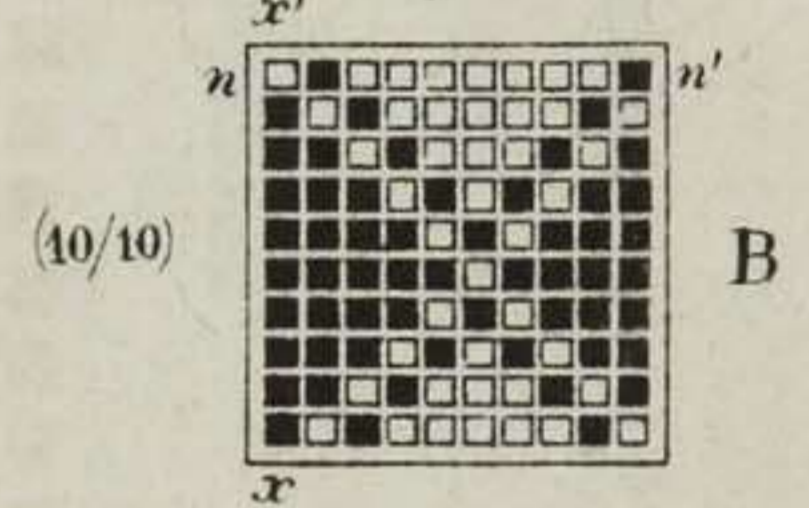


Fig. 677.

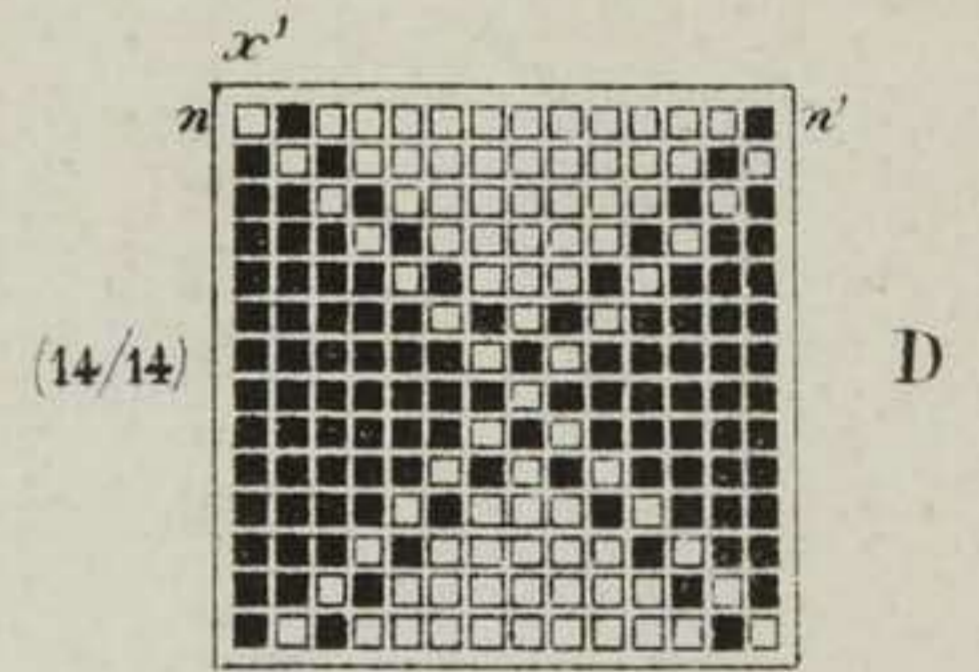
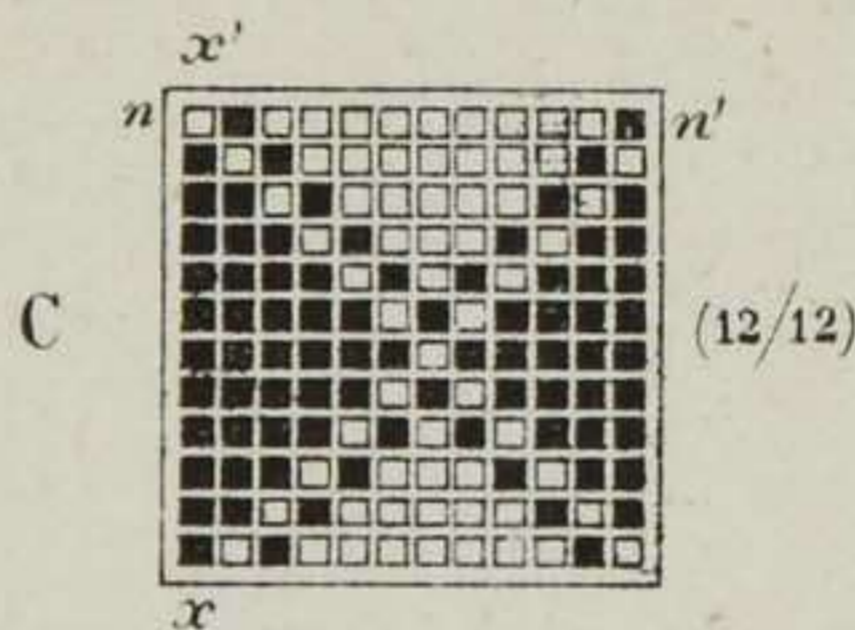
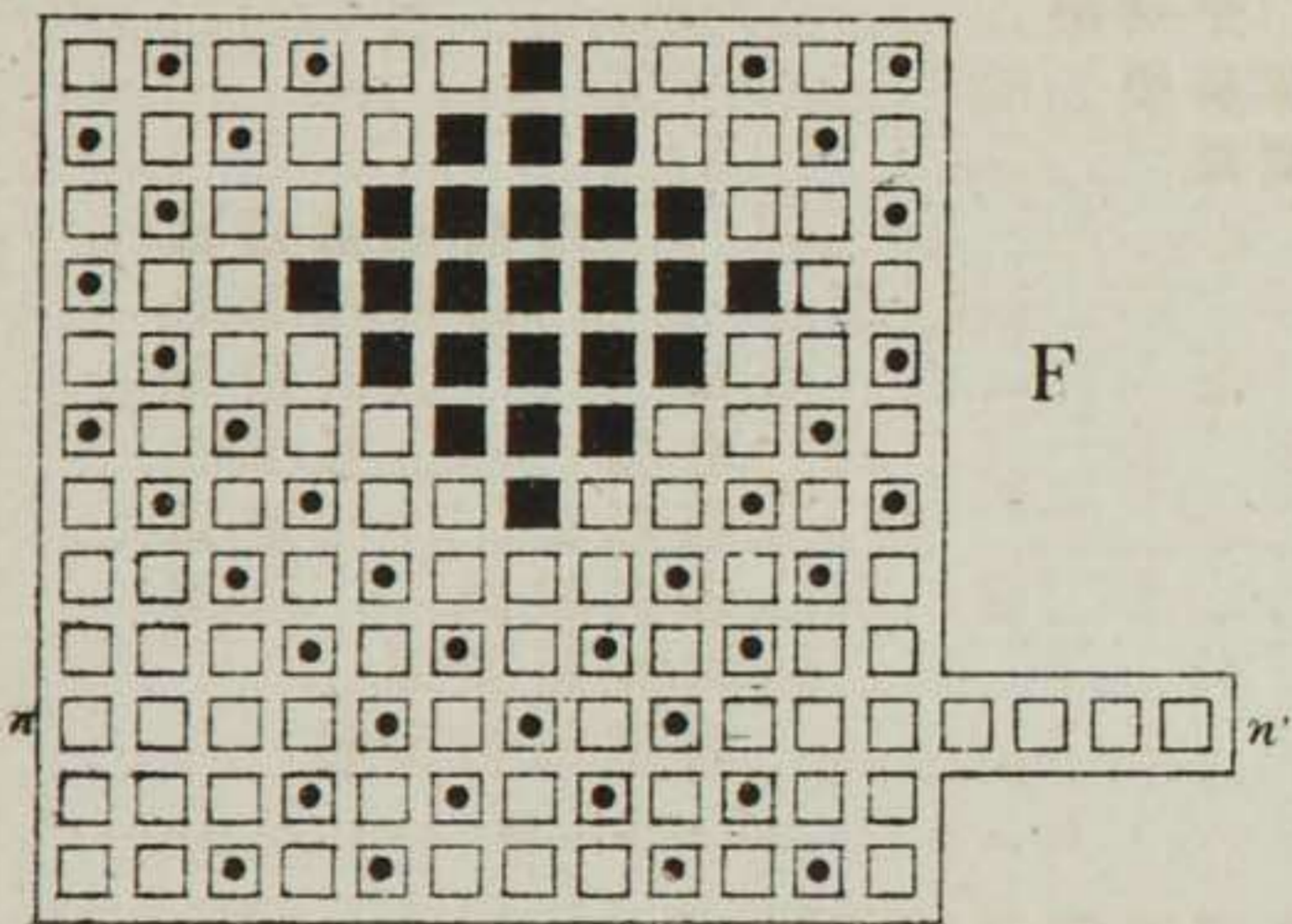


Fig. 674.

Fig. 675.

Fig. 678.

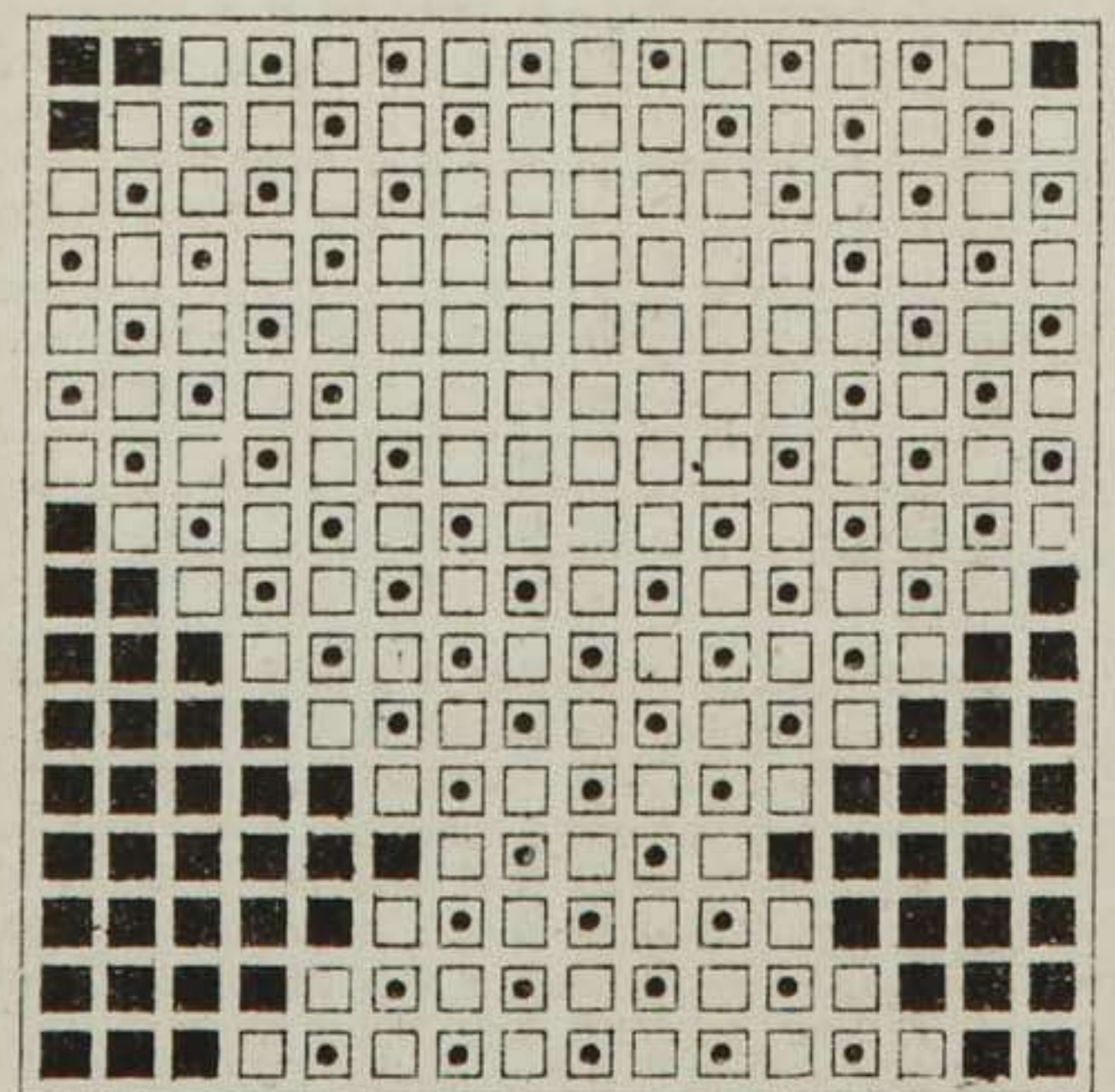


Fig. 667.

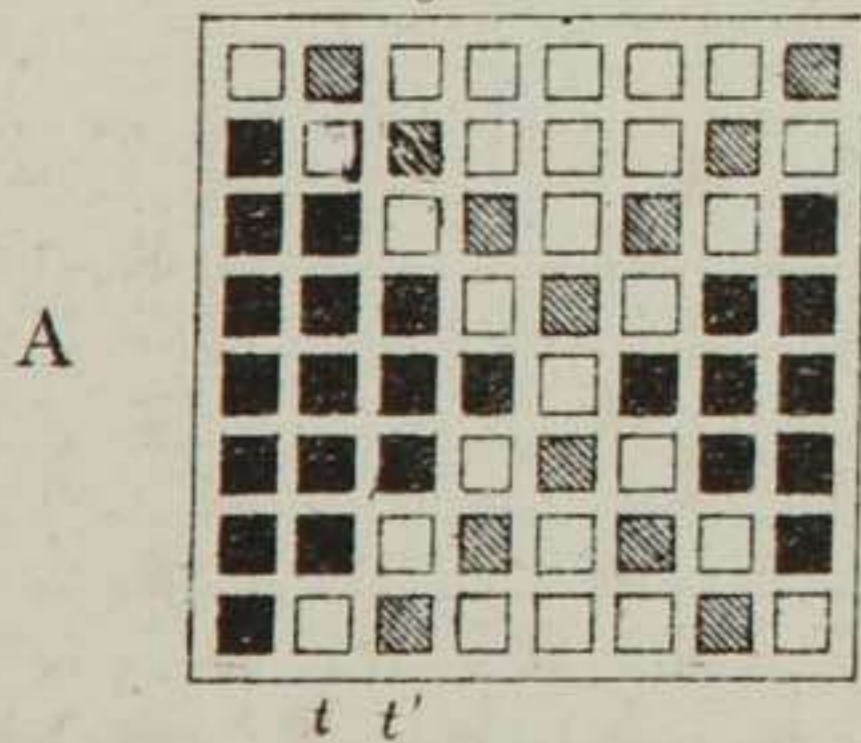


Fig. 668.

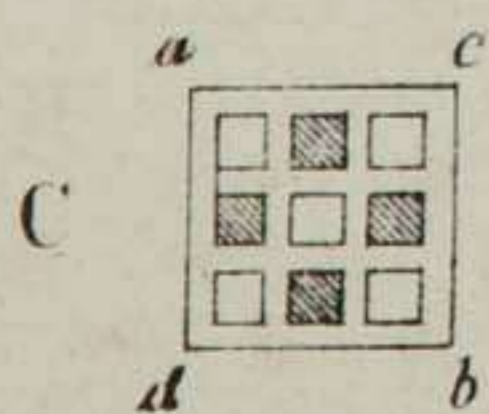
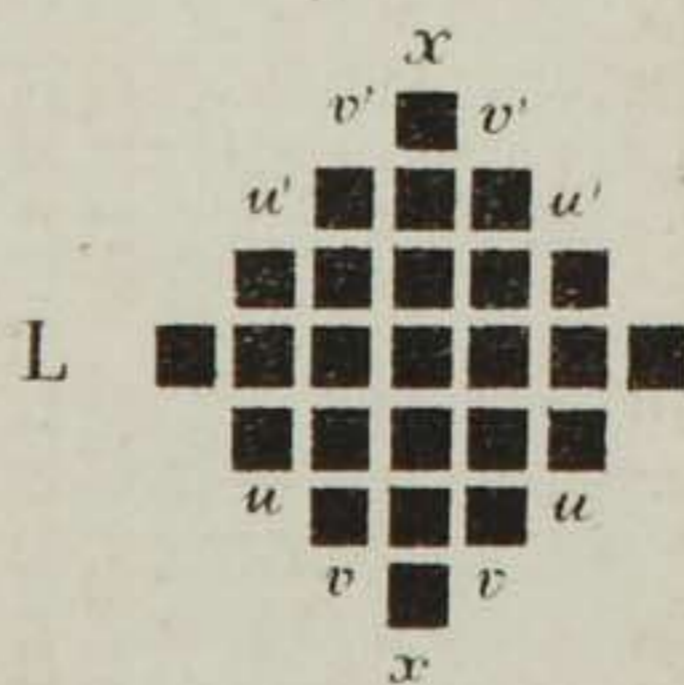


Fig. 671.

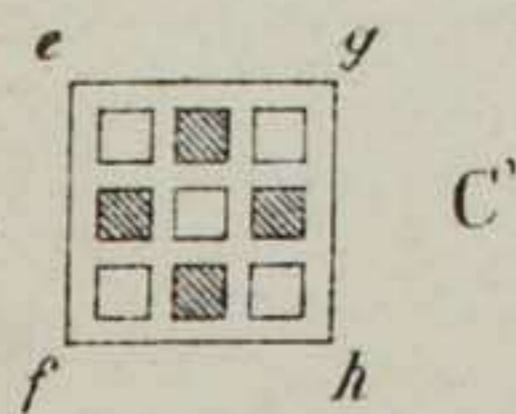


Fig. 685.

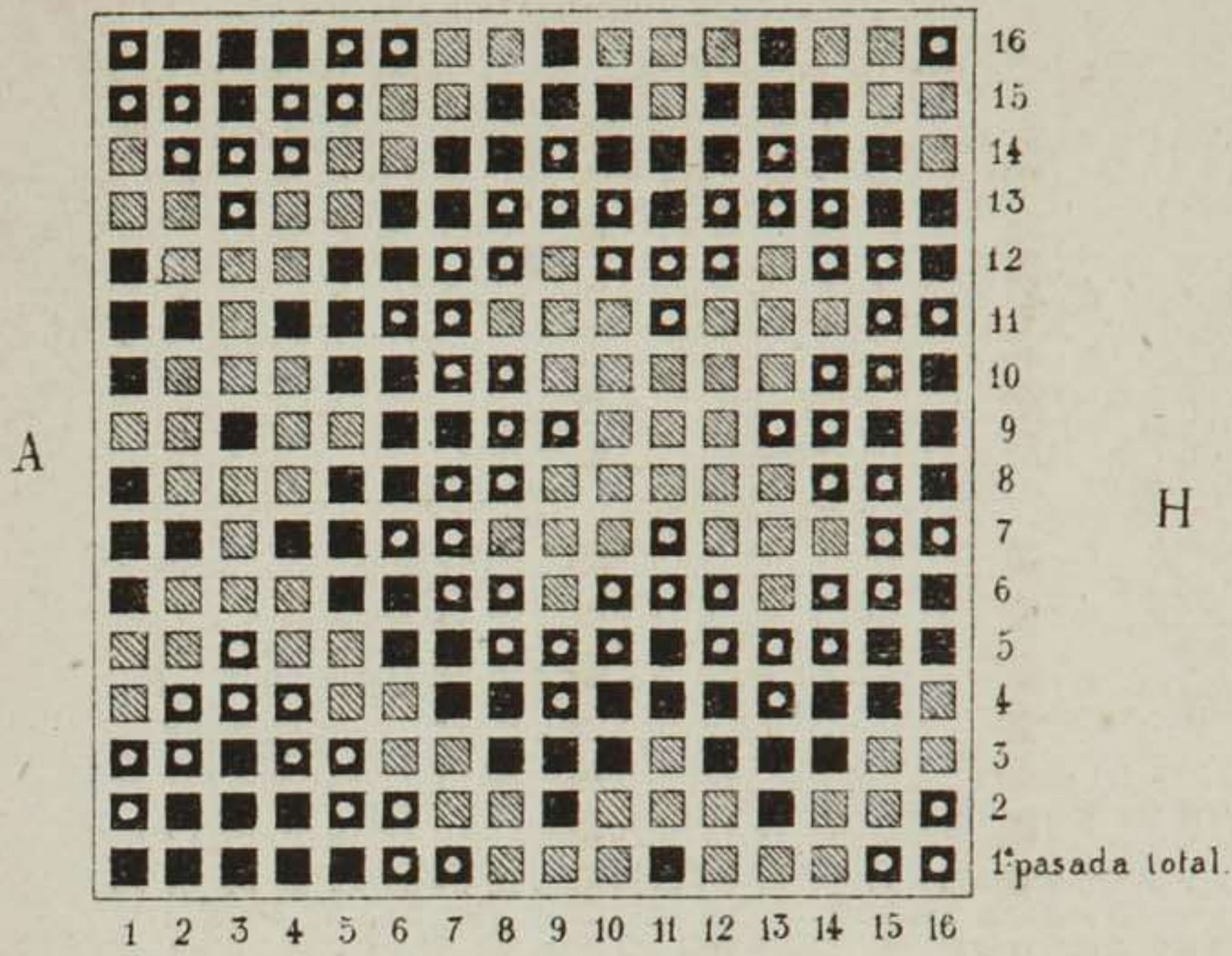


Fig. 679.

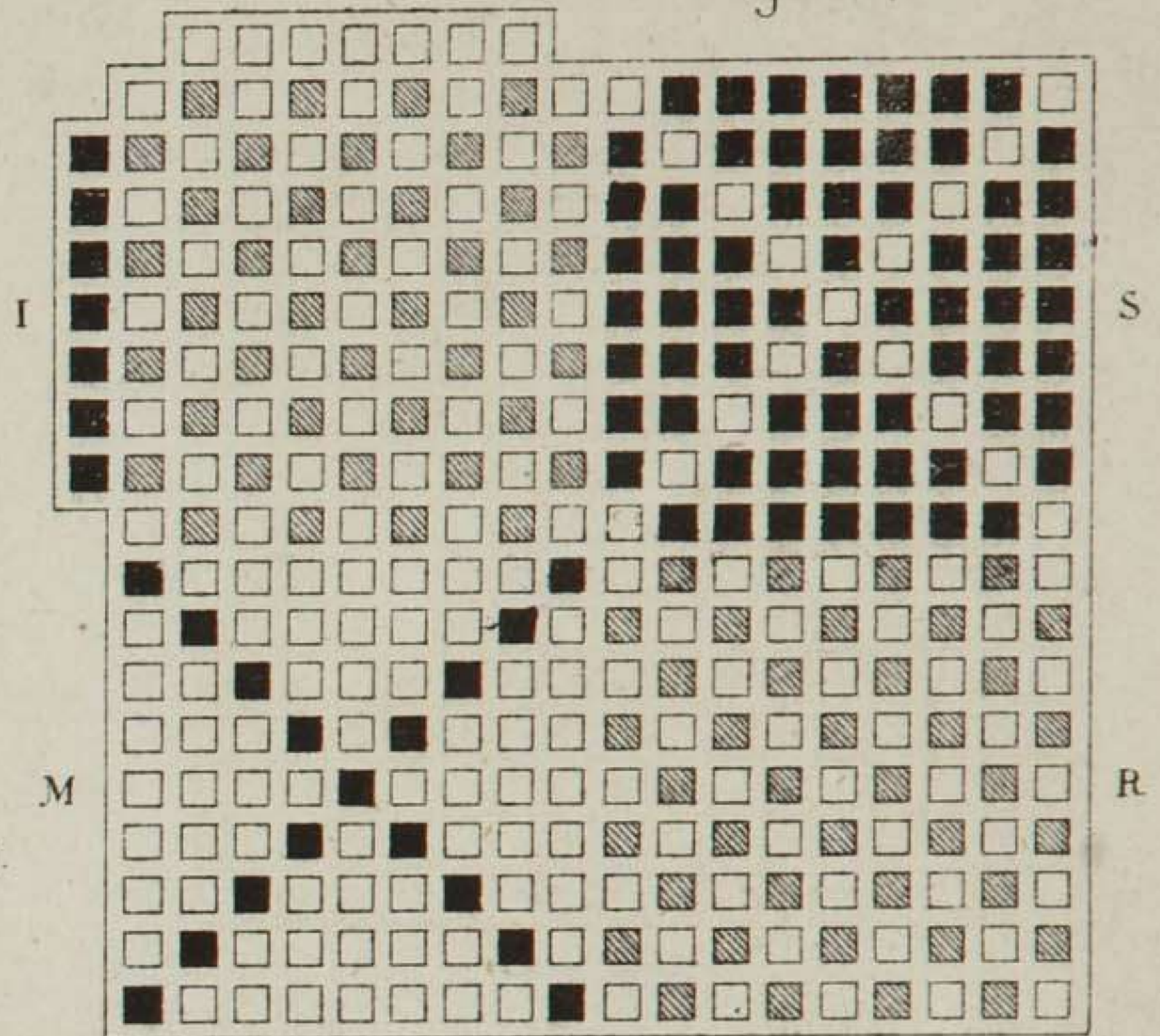
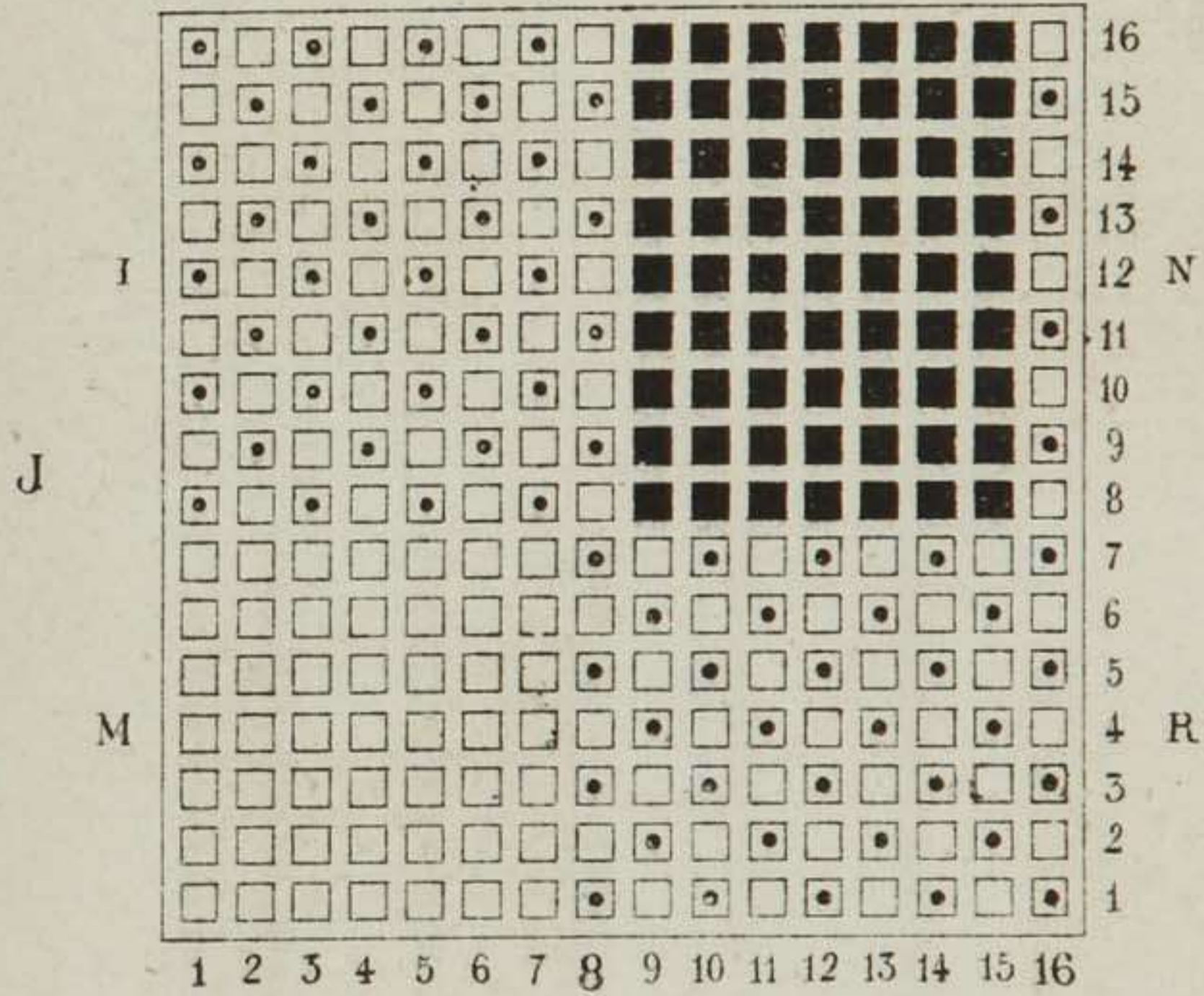


Fig. 680. c



(7º Ejemplo) Fig. 682.

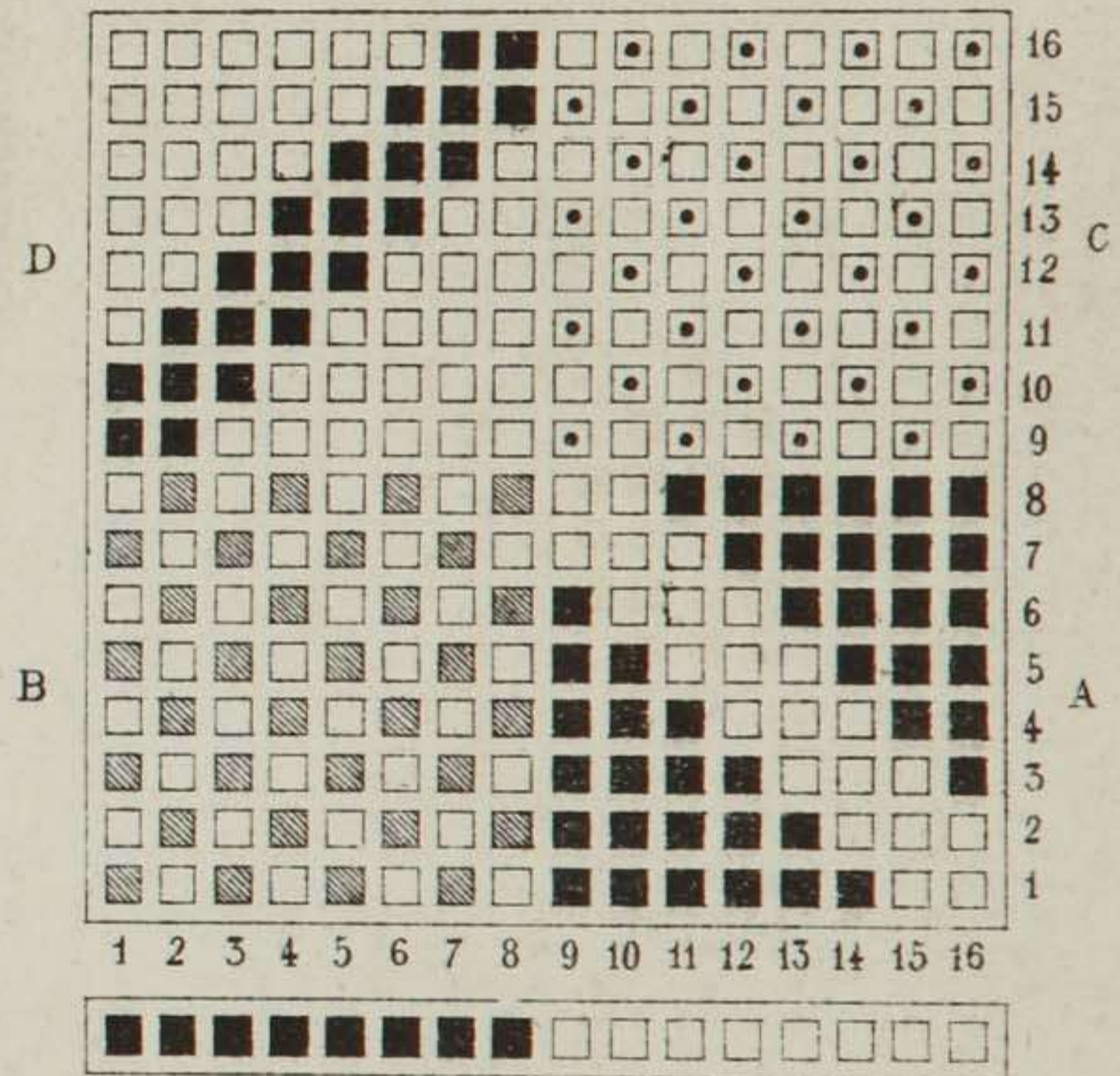
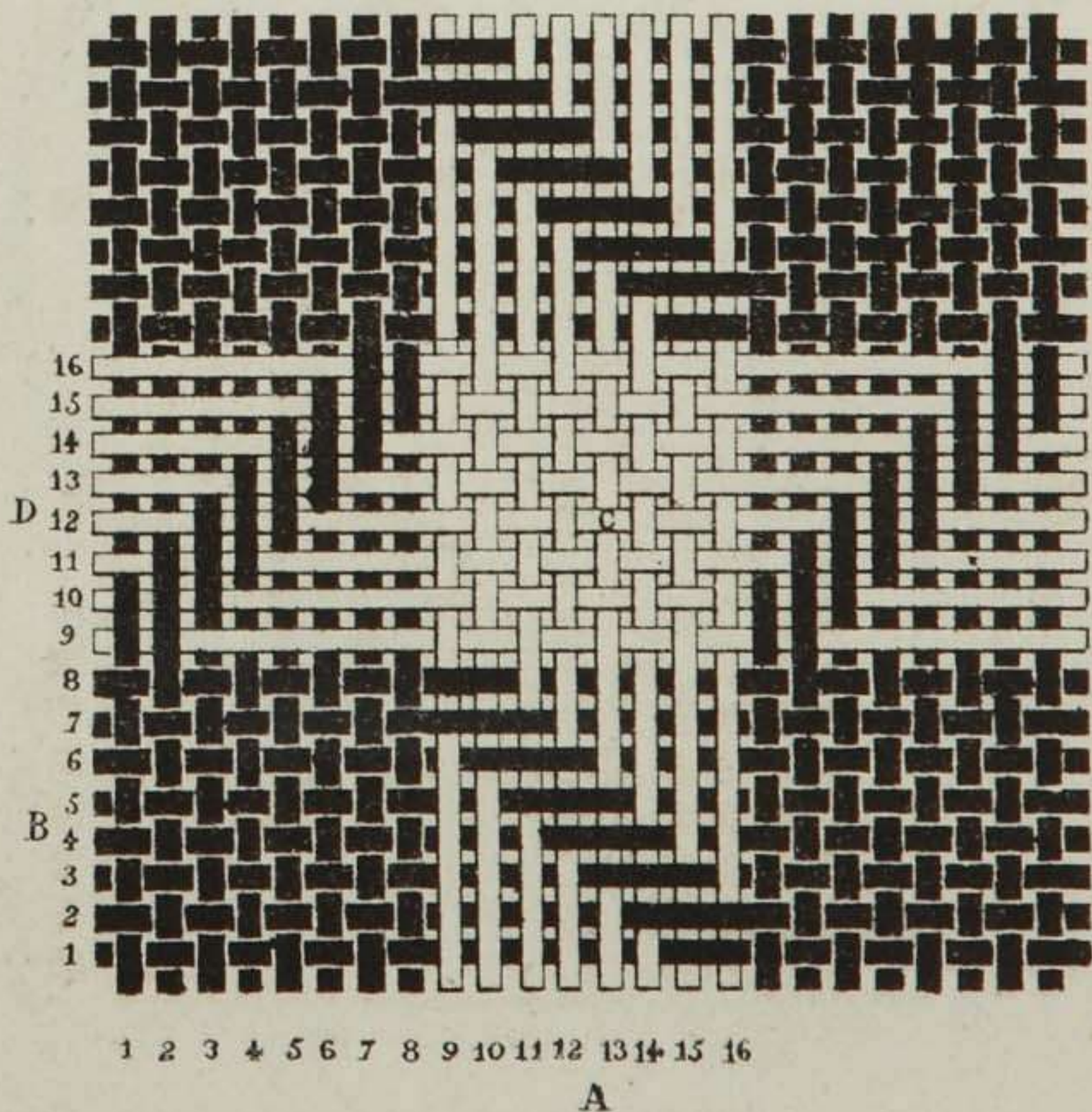


Fig. 683.



(6º Ejemplo) Fig. 681.

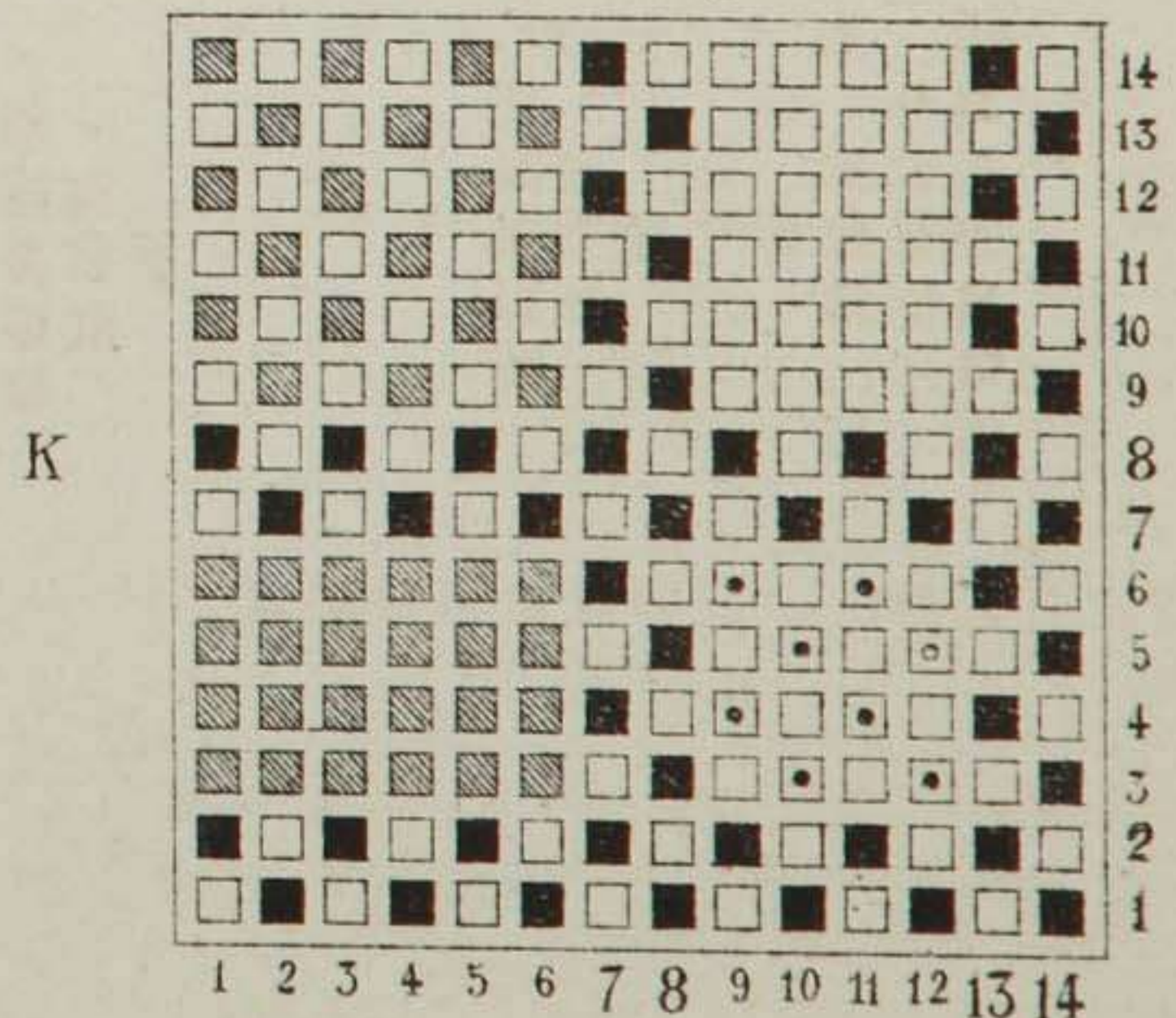
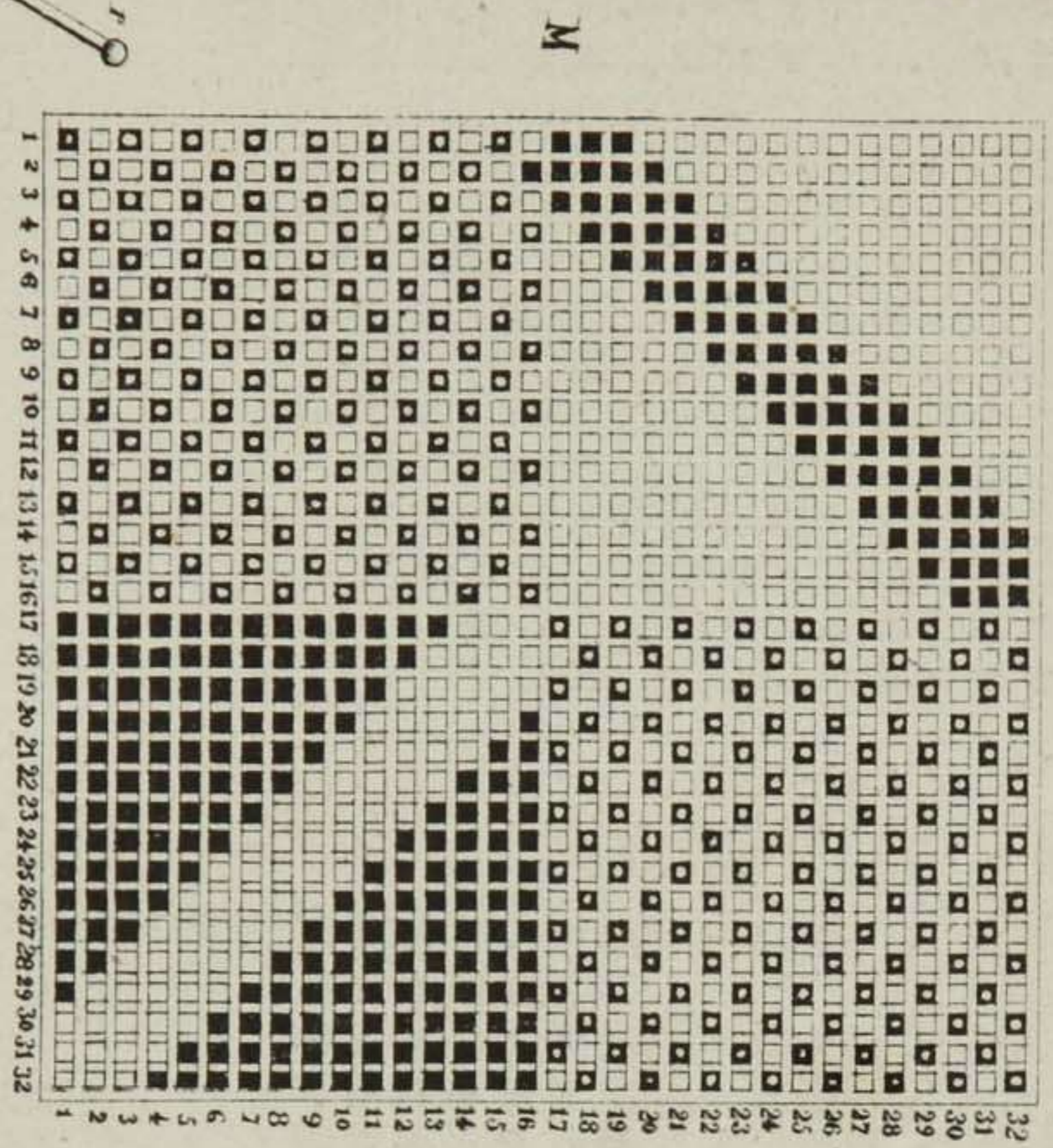


Fig. 684.



LEYENDA.

Negro. N

Verde. V

Rojo. R

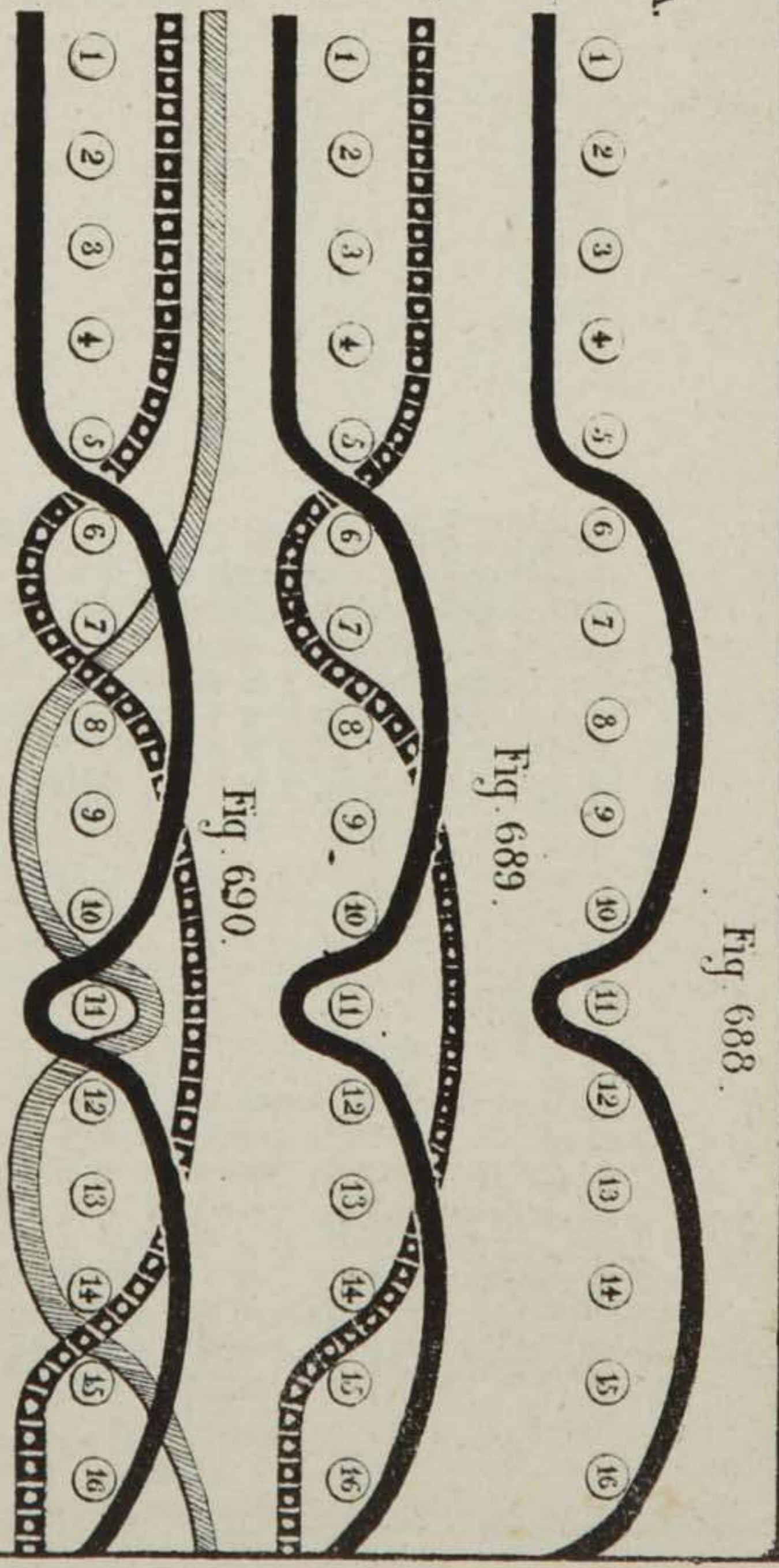


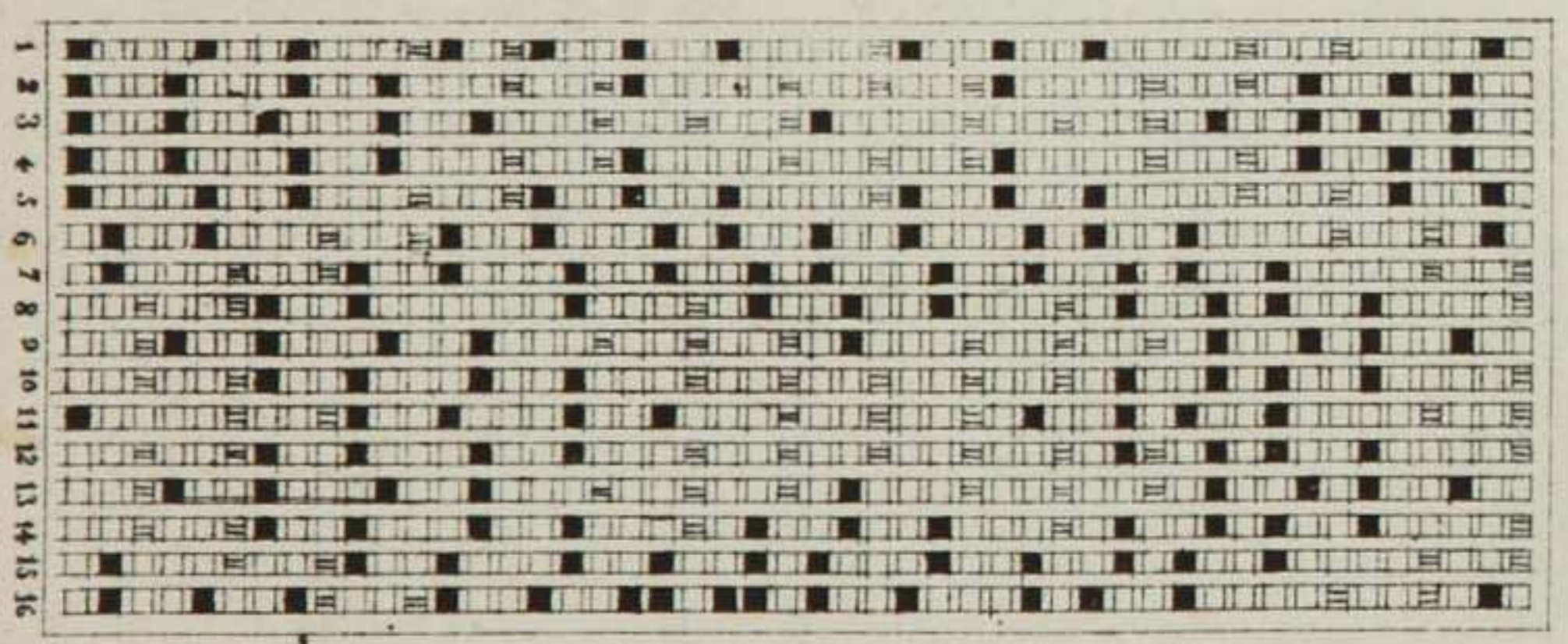
Fig. 688.

Fig. 689.

Fig. 690.

Fig. 691.

B TRASLÁTAGE.



- Trama negra N.
- ◻ Trama verde V.
- ▨ Trama roja R.

Fig. 686.

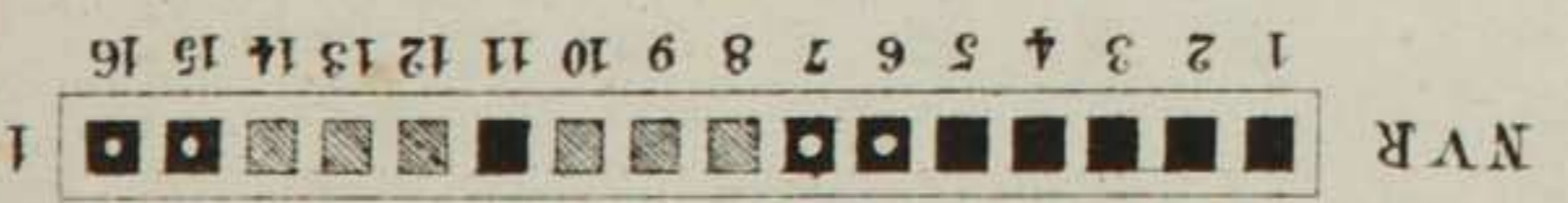


Fig. 687.

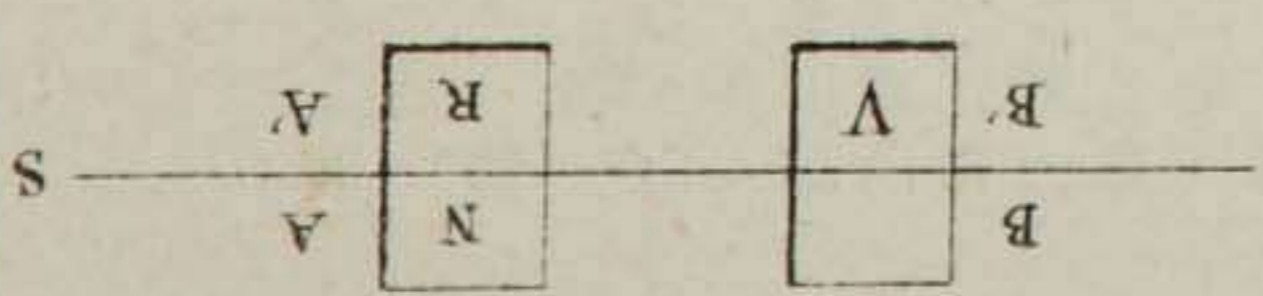


Fig. 694.

Fig. 692.

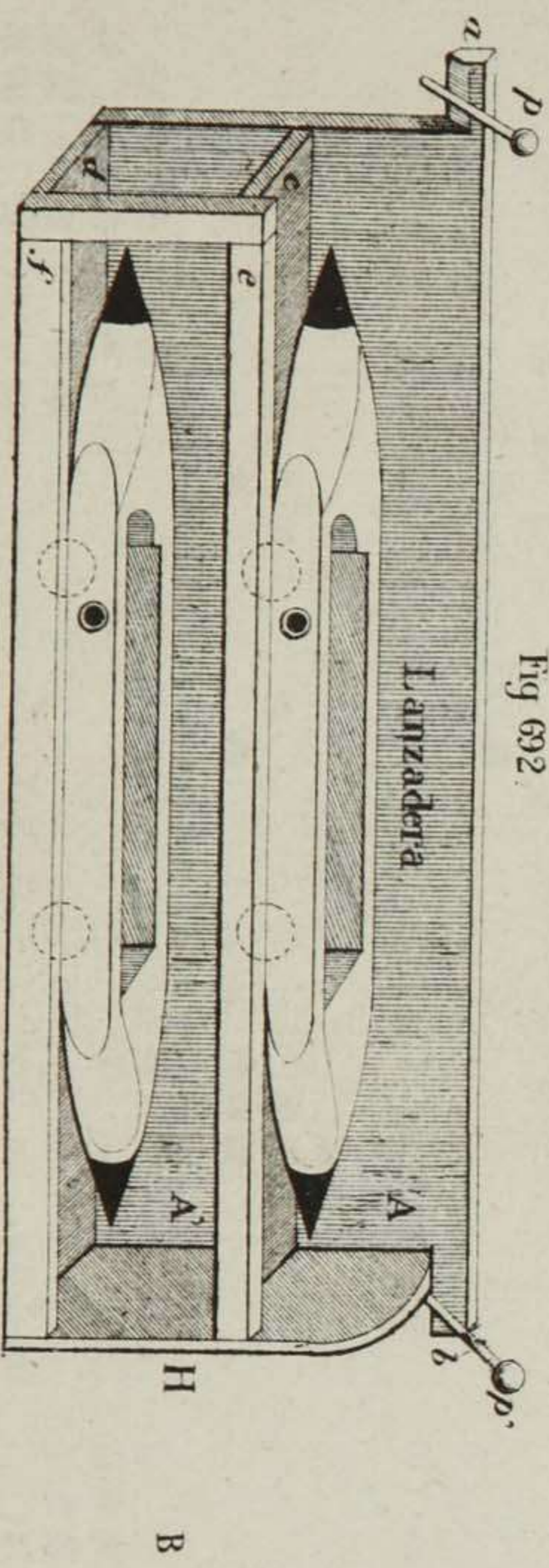
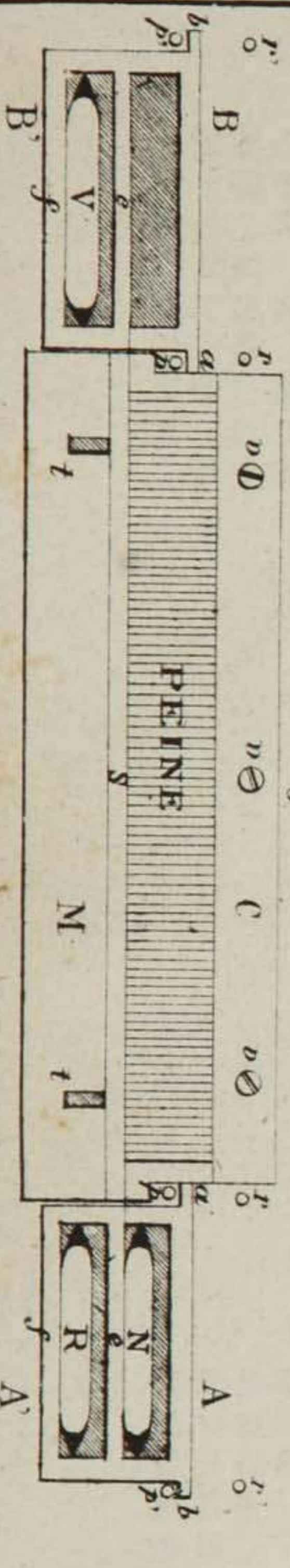


Fig. 693.



Nacemle, editor.

Paseo de Gracia, 149.

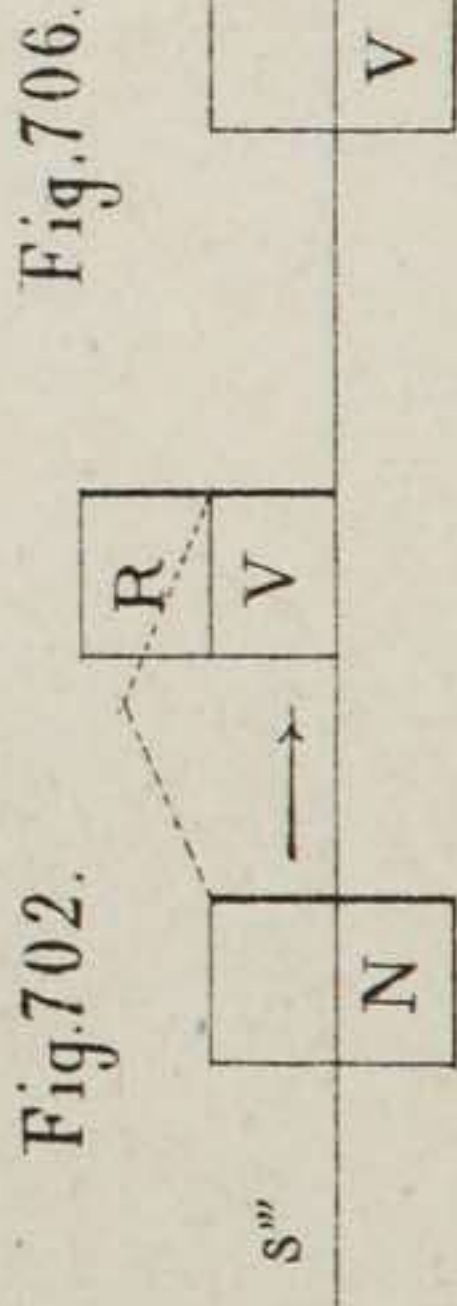
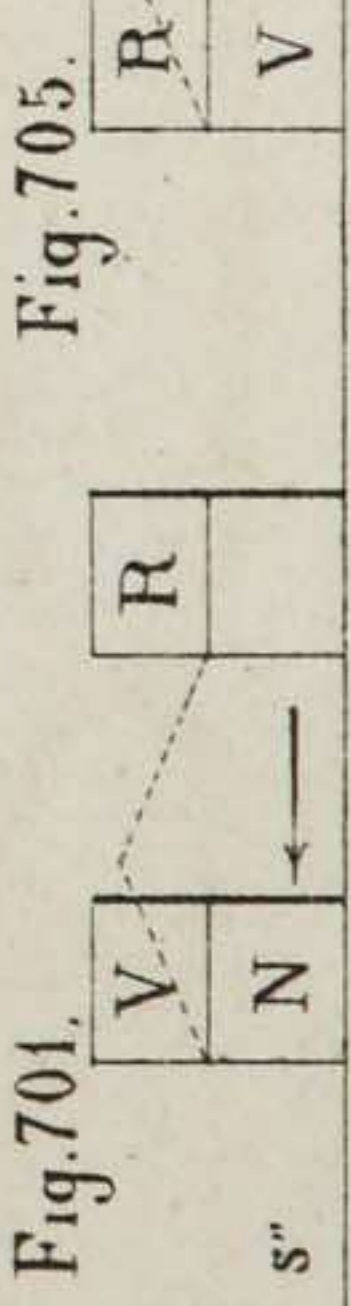
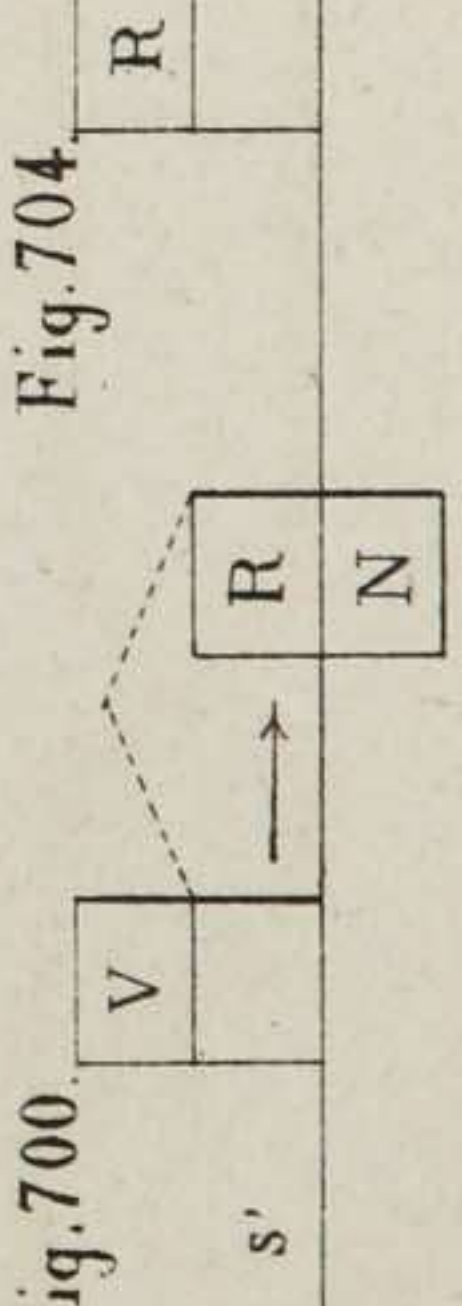
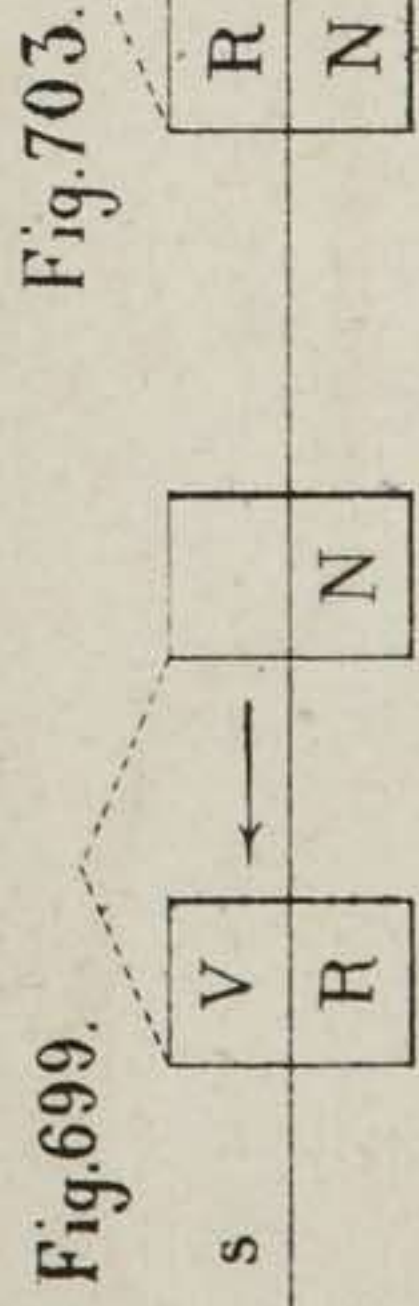
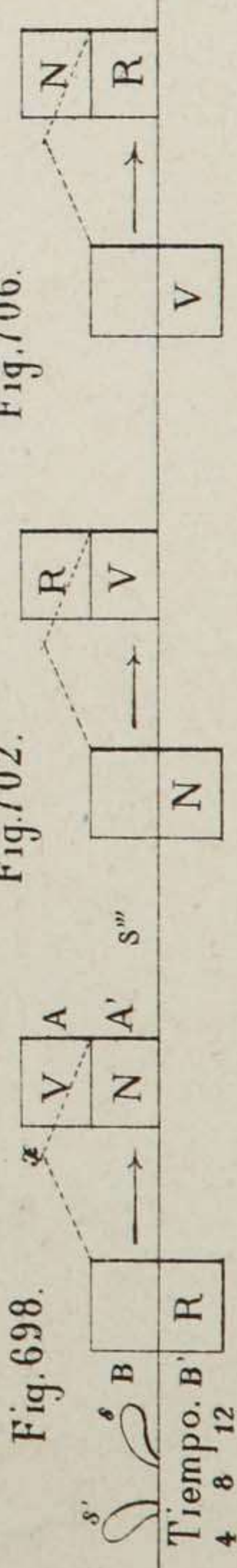
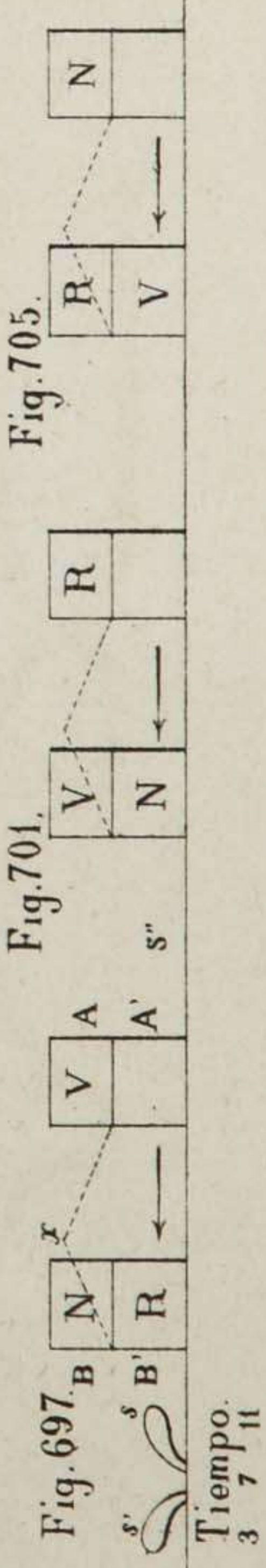
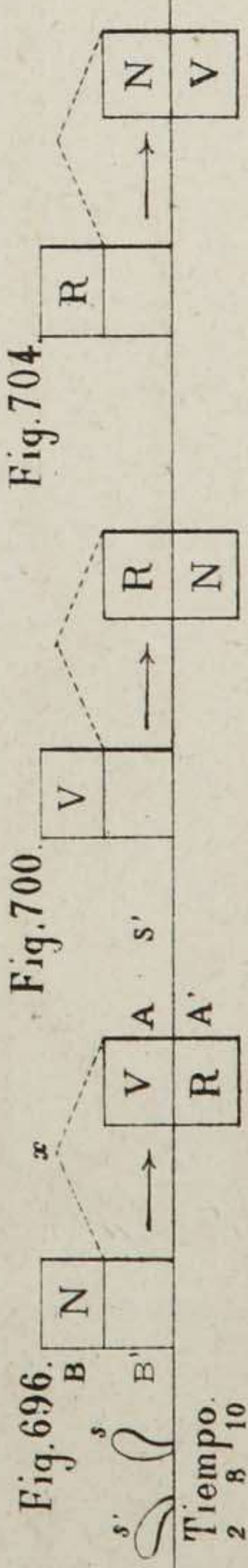
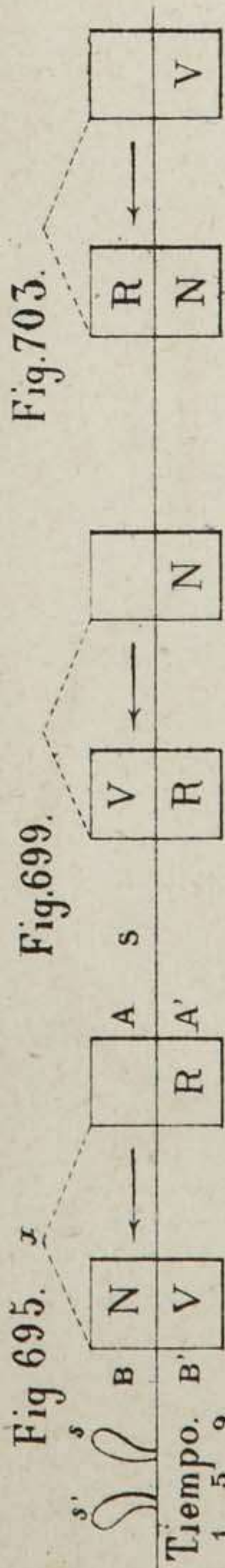


Fig. 711.

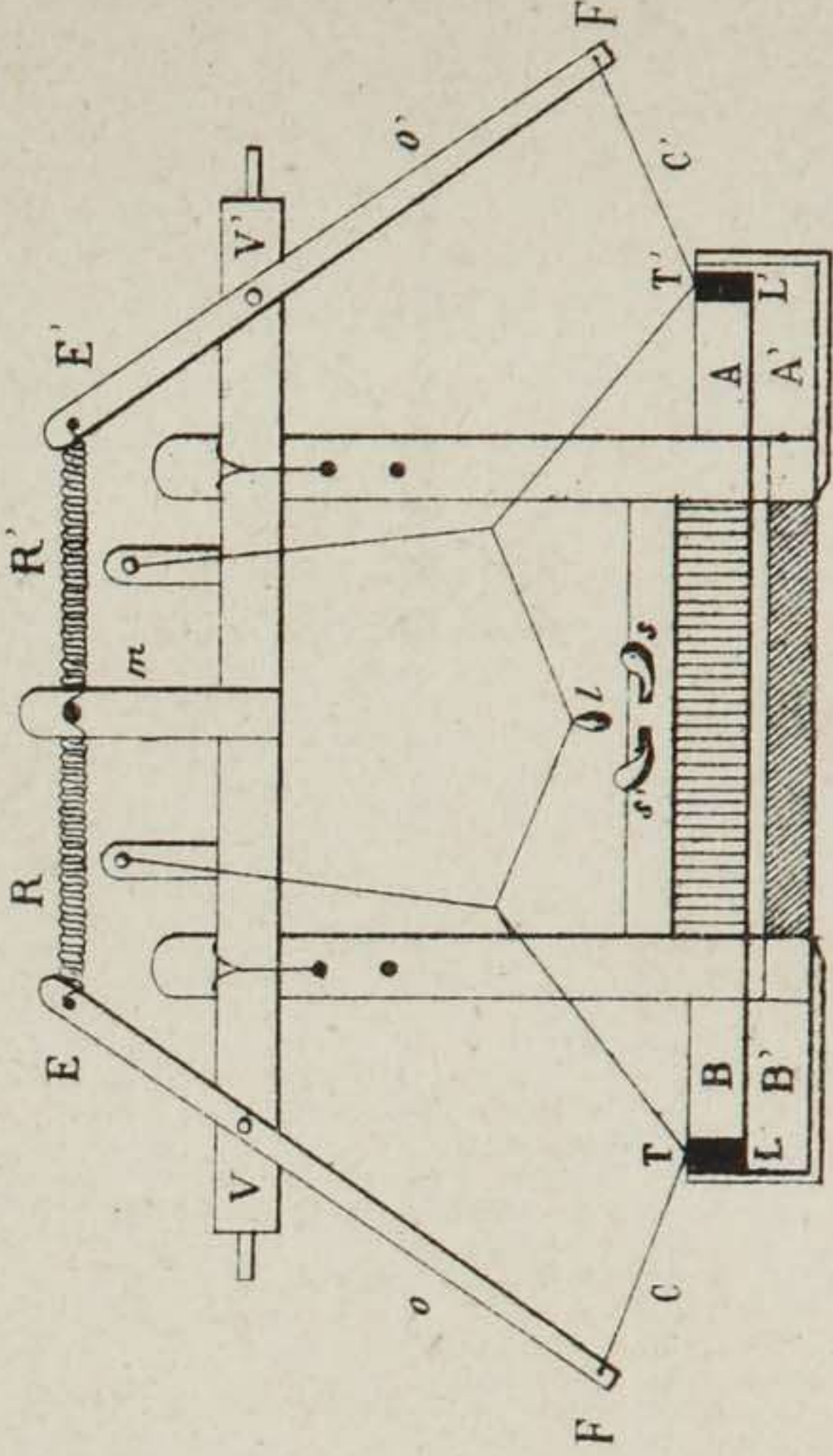
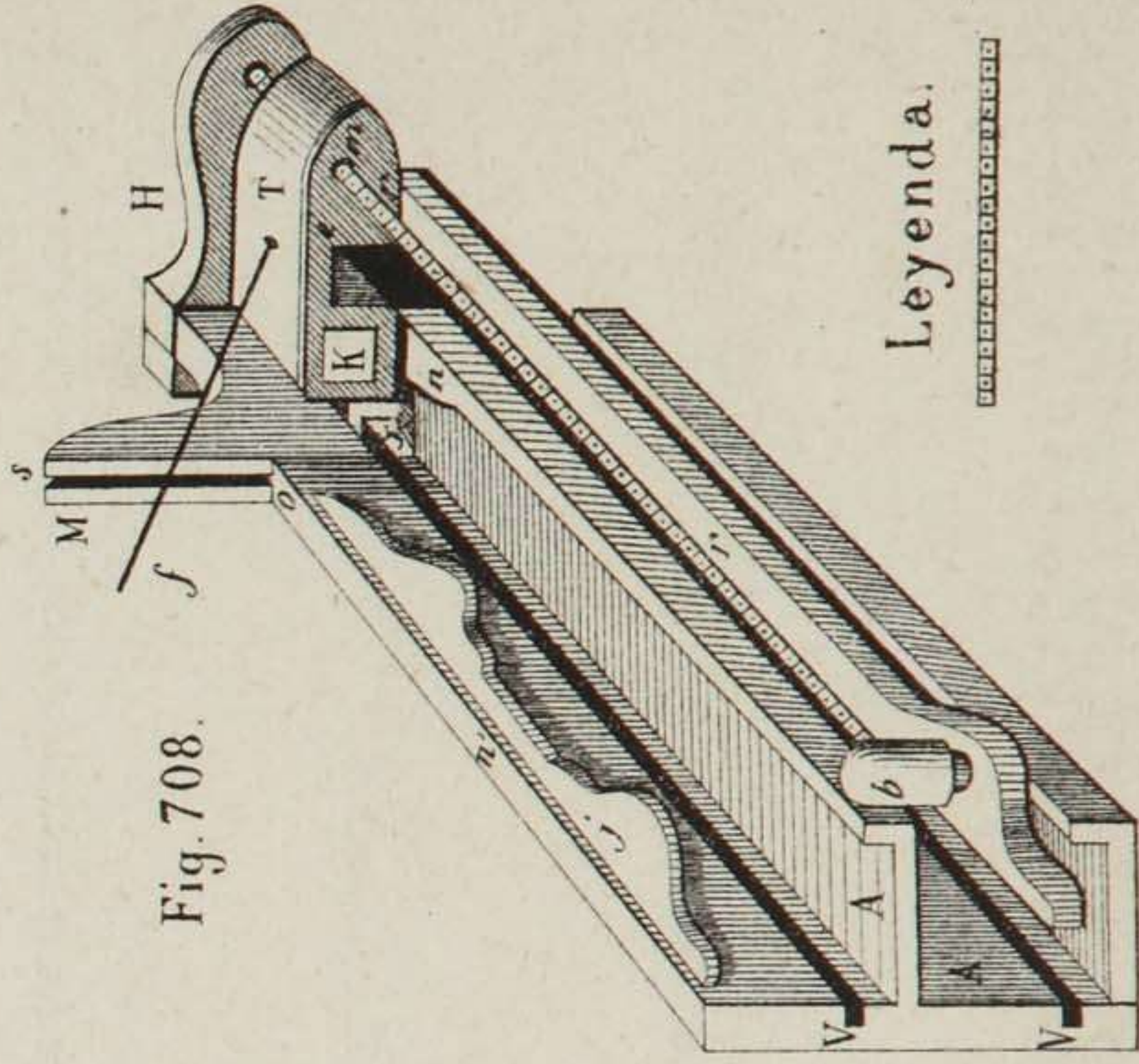
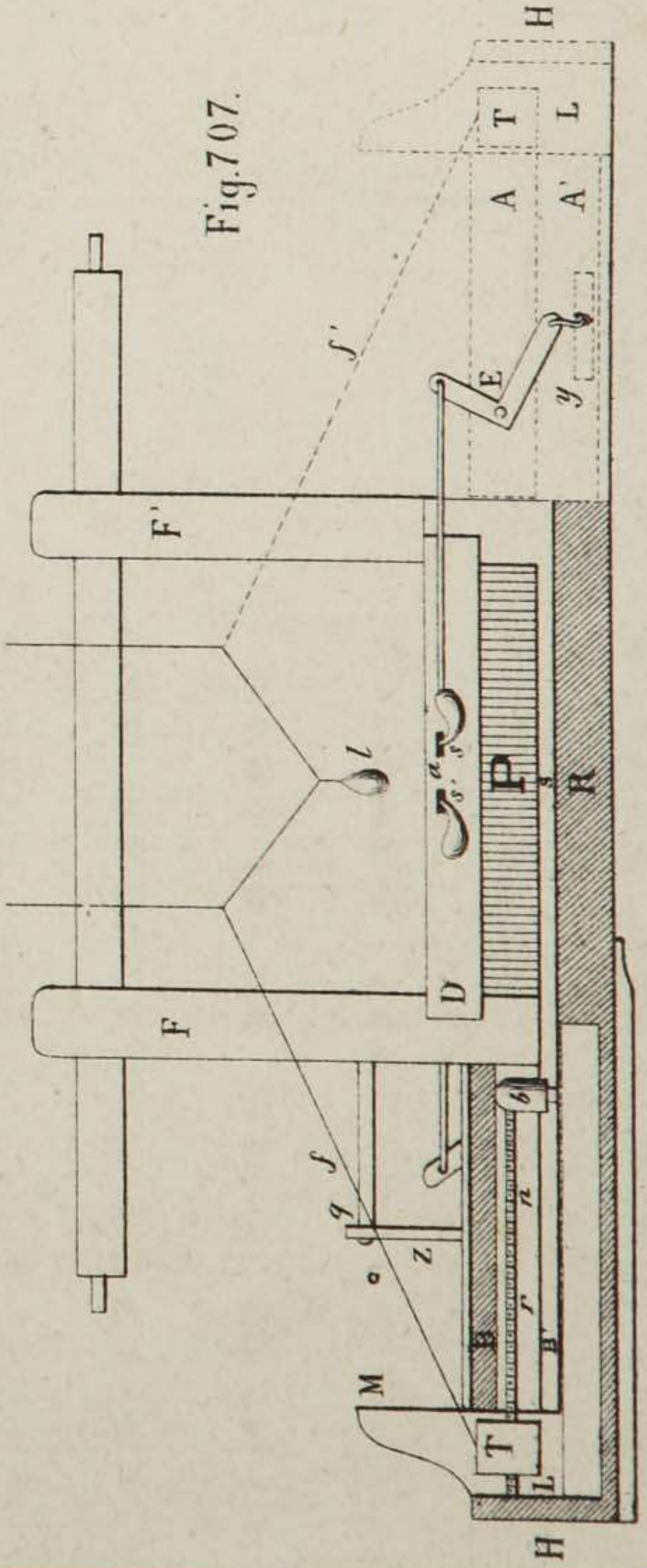


Fig. 708.



Leyenda. Rojo.



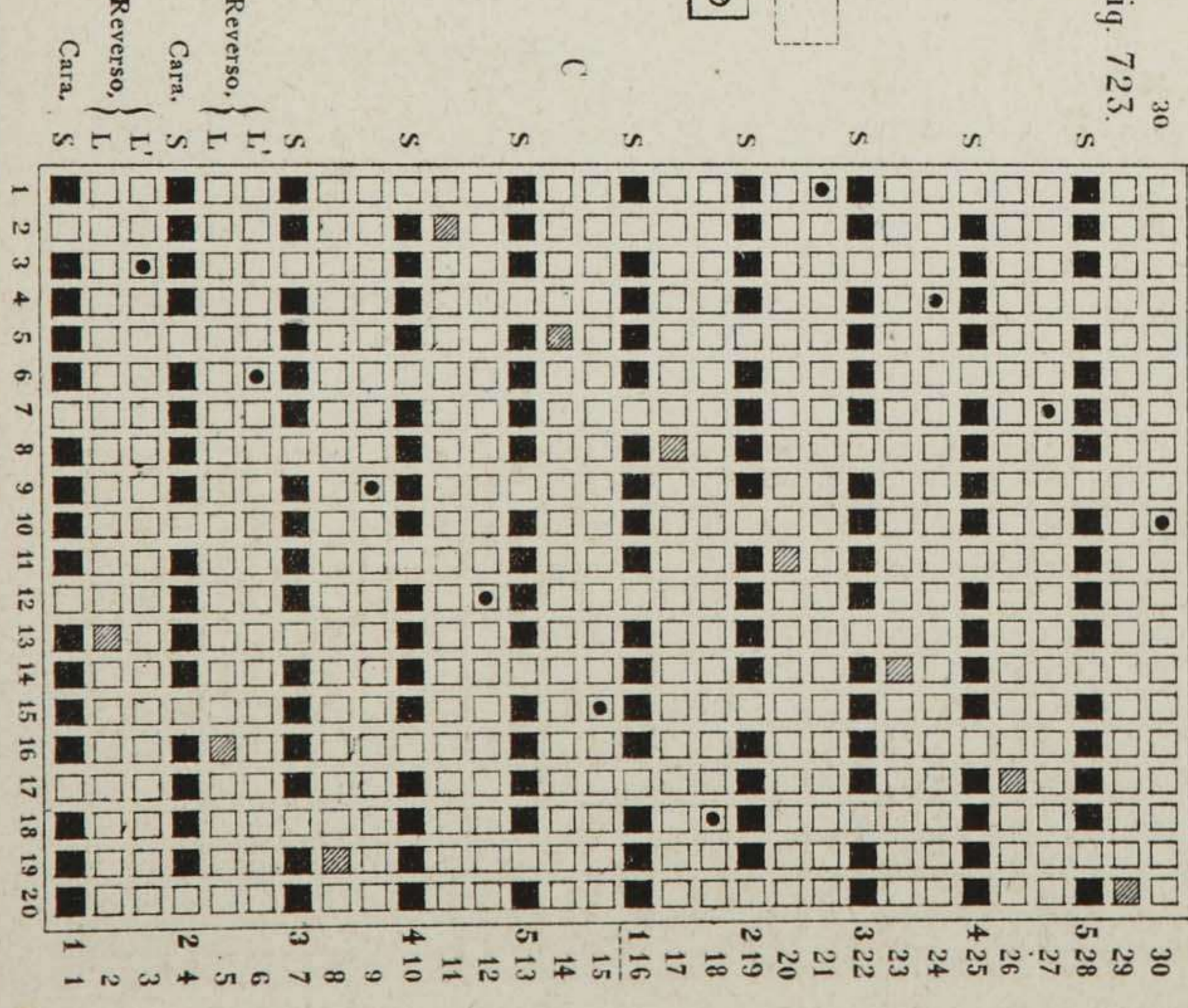
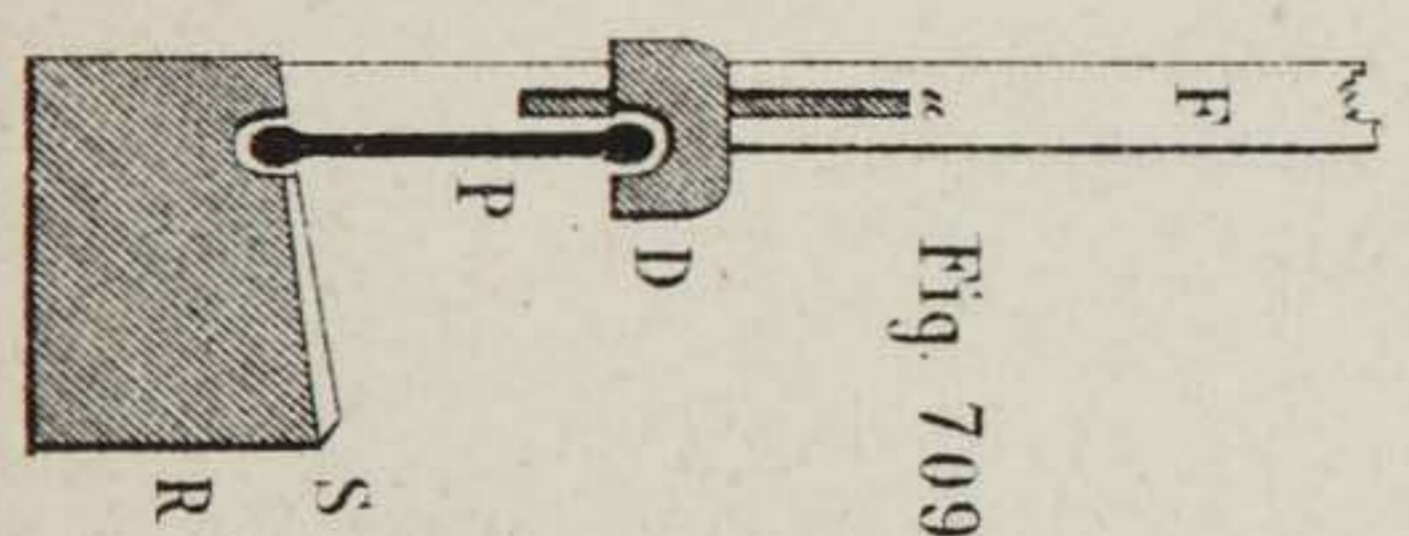
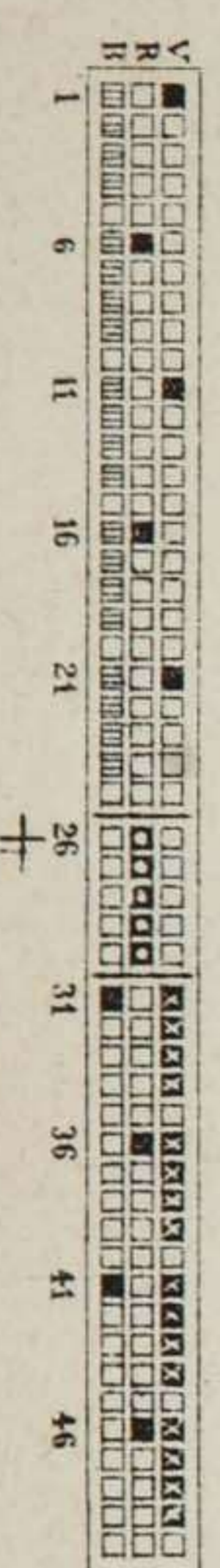
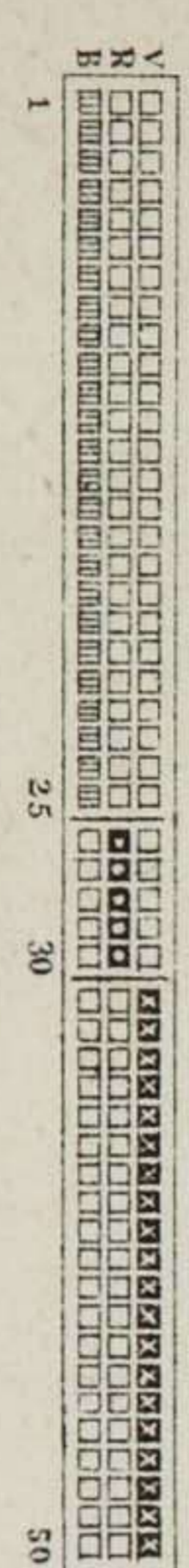
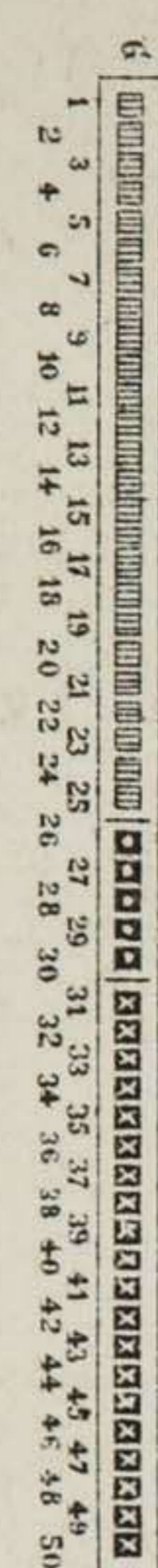
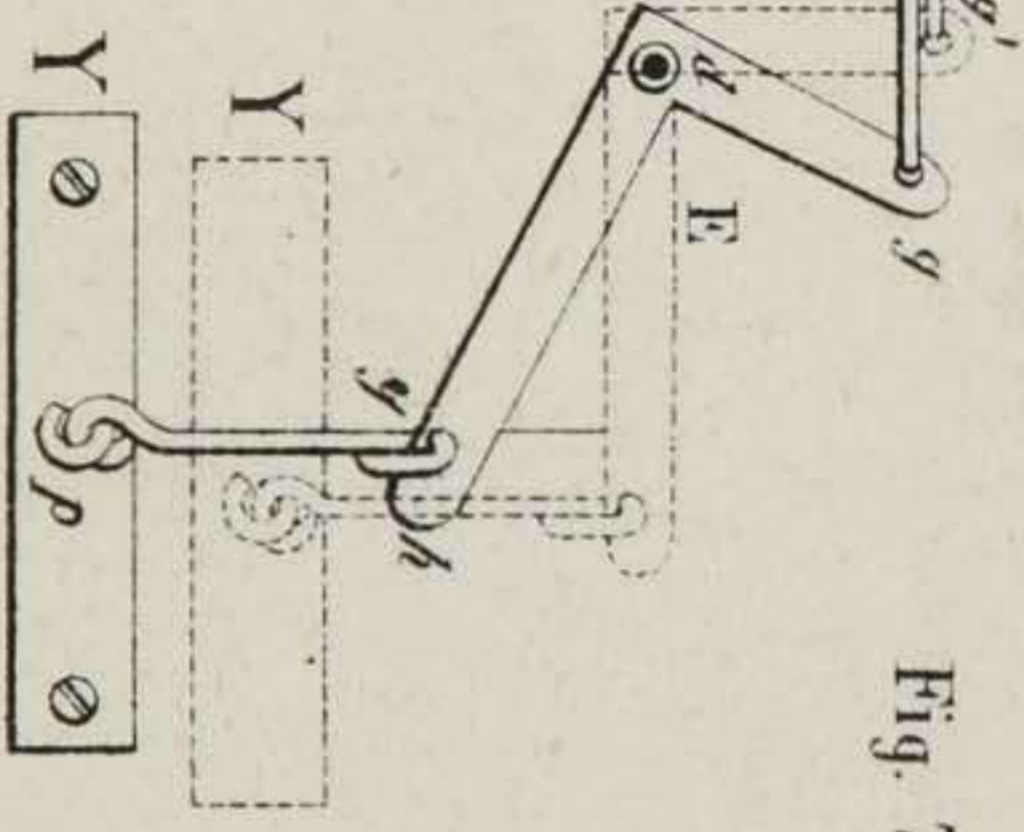
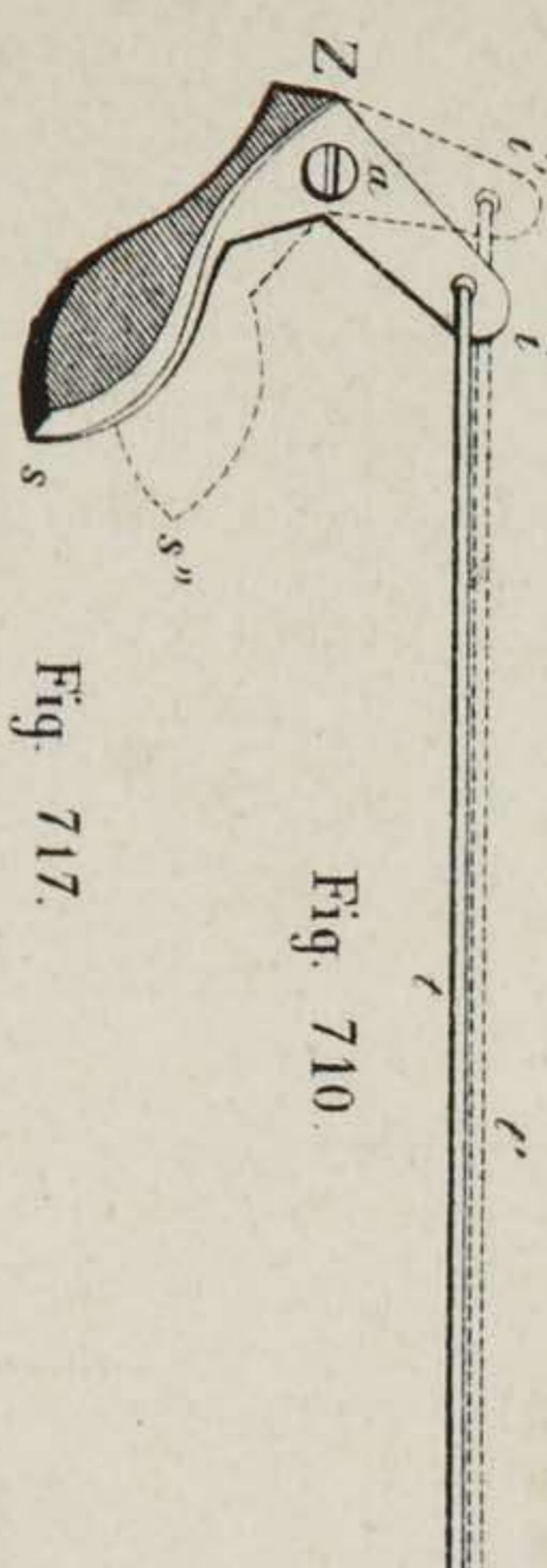
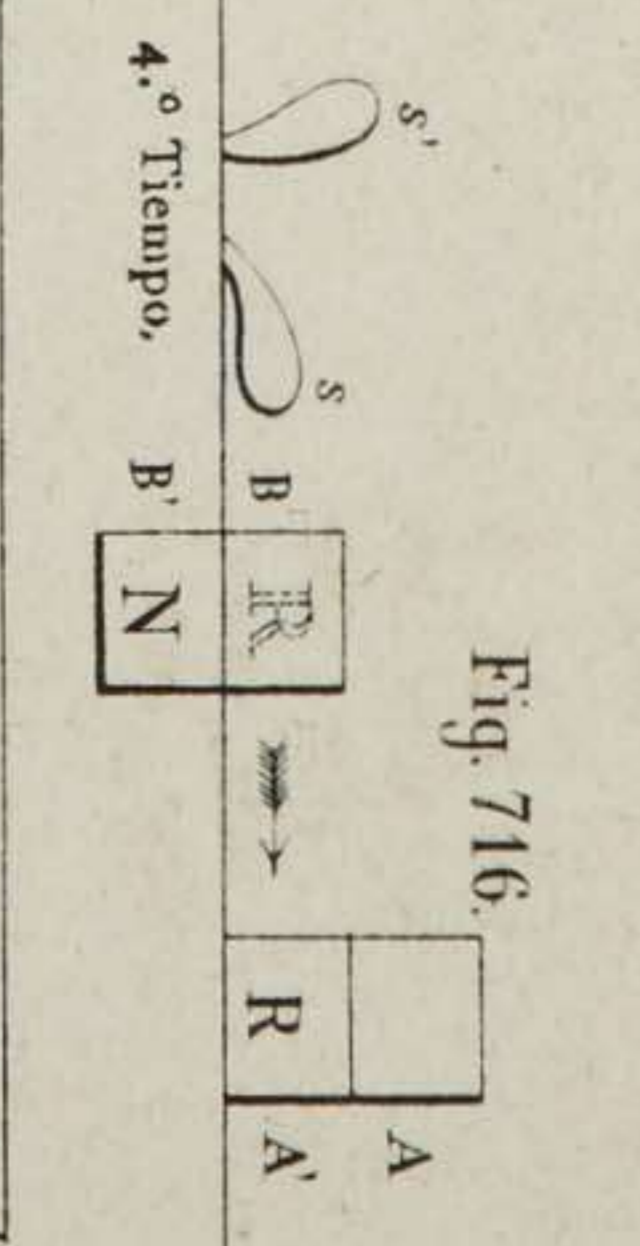
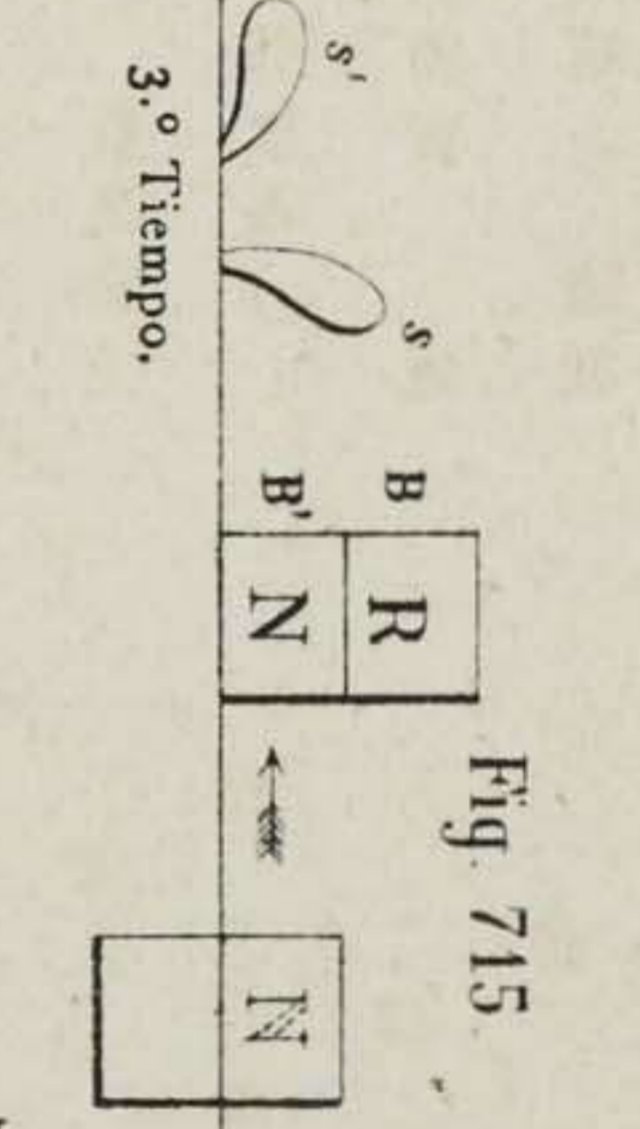
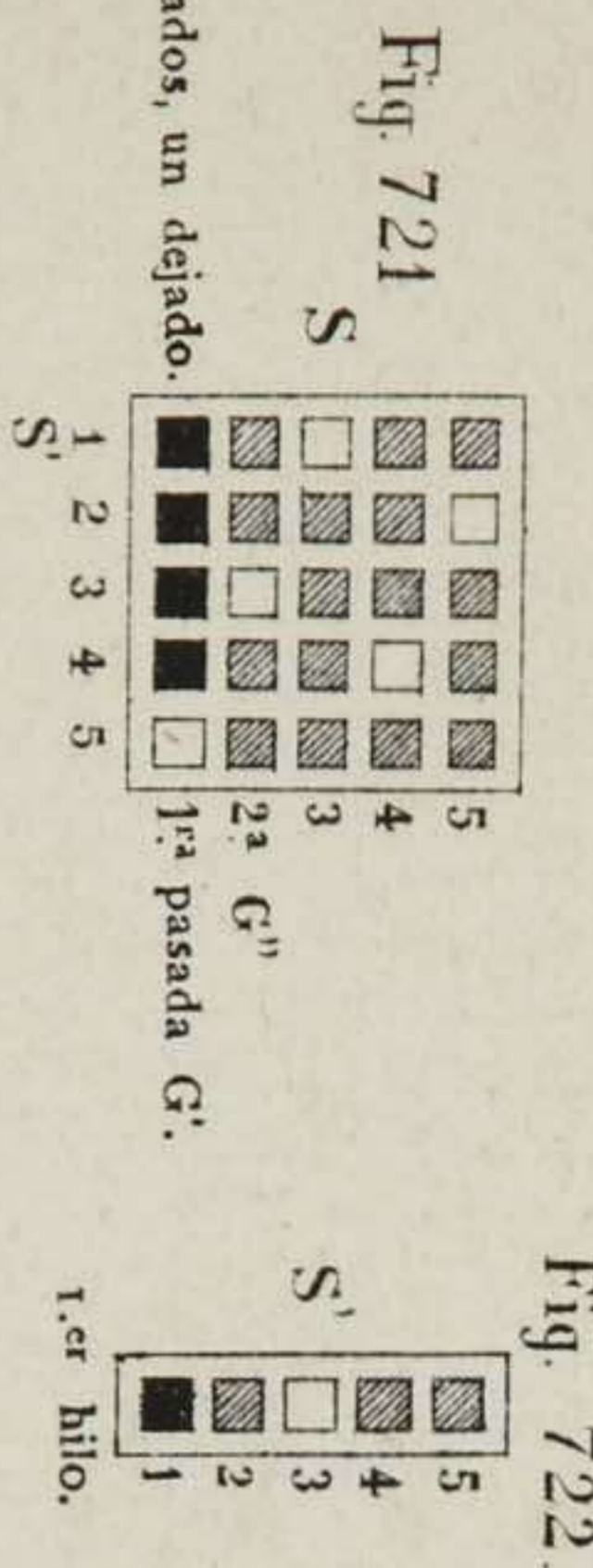
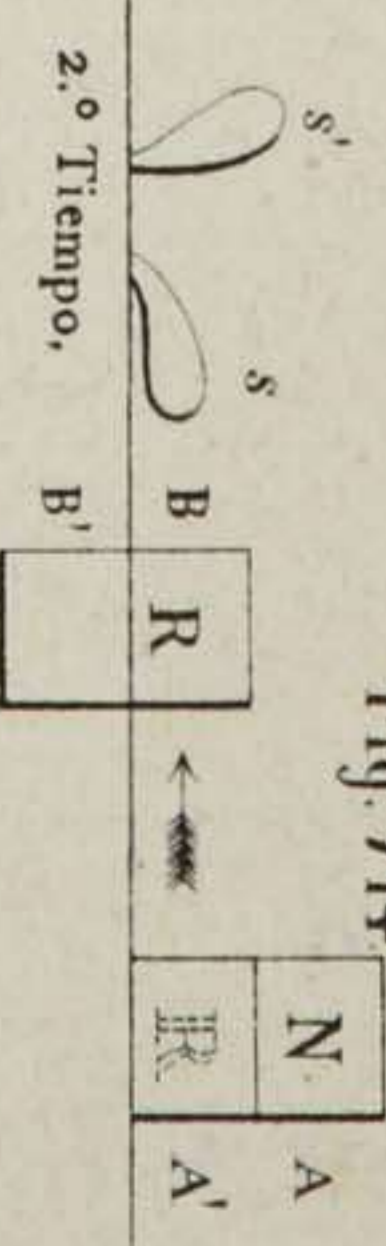
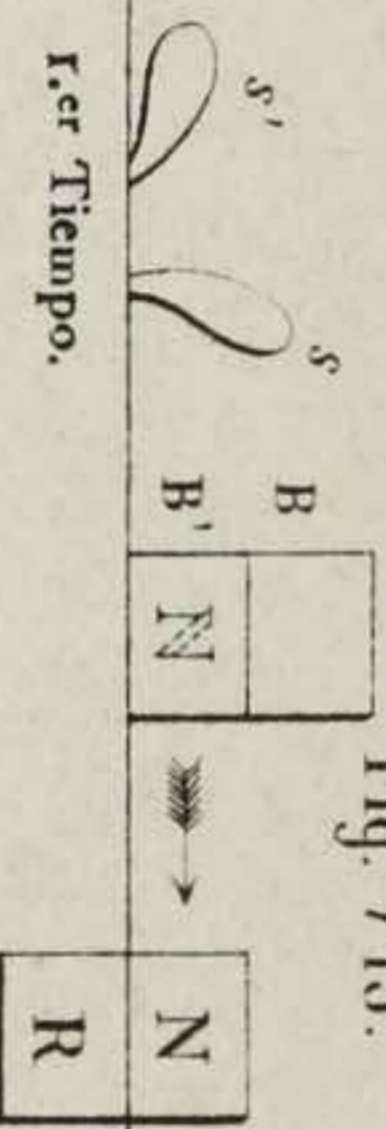
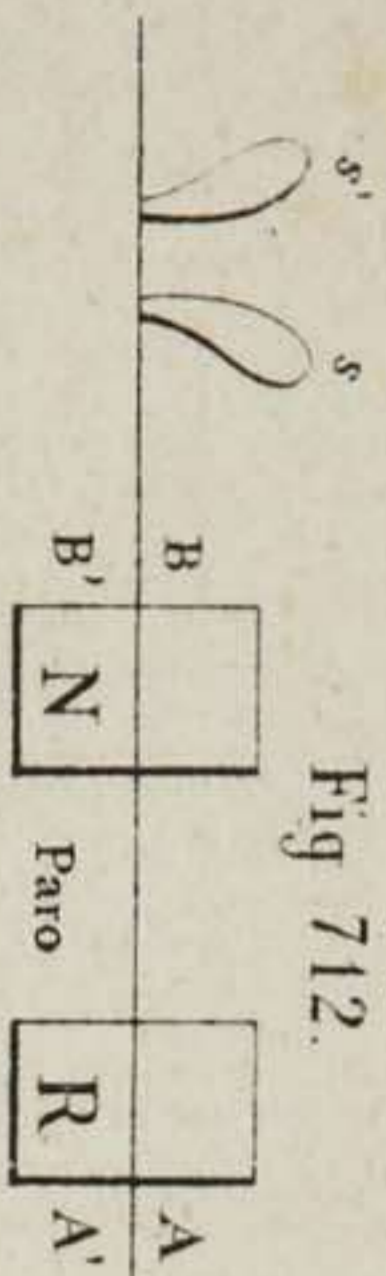
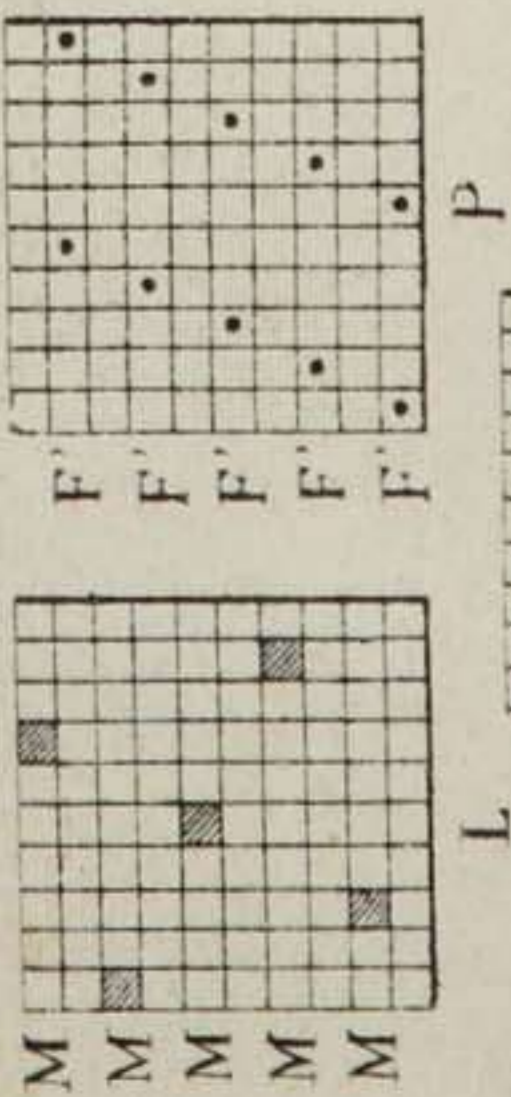


Fig 726. bis.



L P D

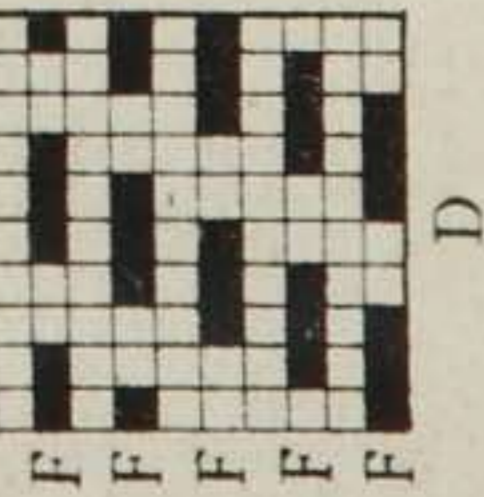
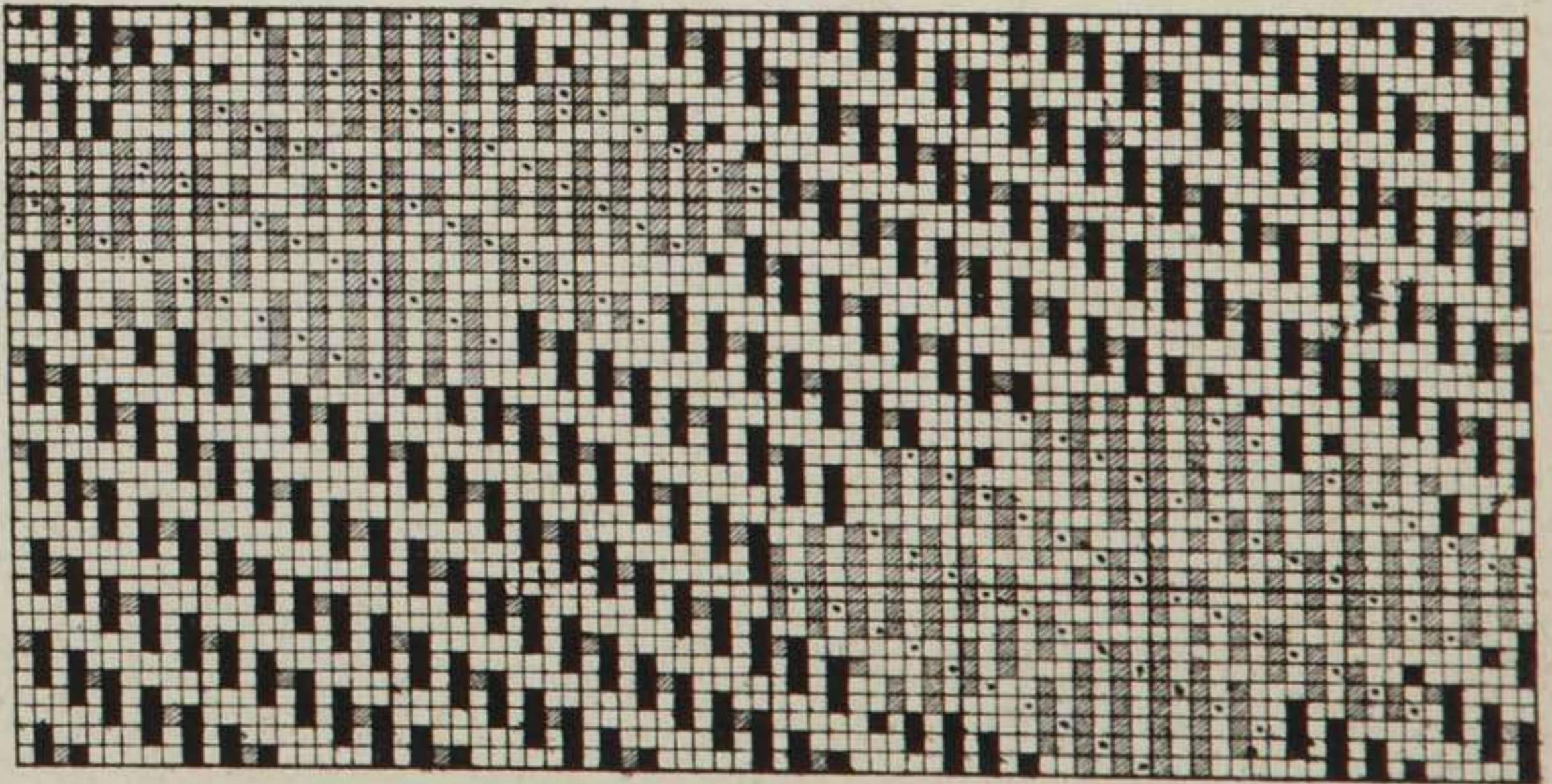


Fig.727.

LEYENDA: ■ Azul.



Diseño sustitutivo.

Fig.724.

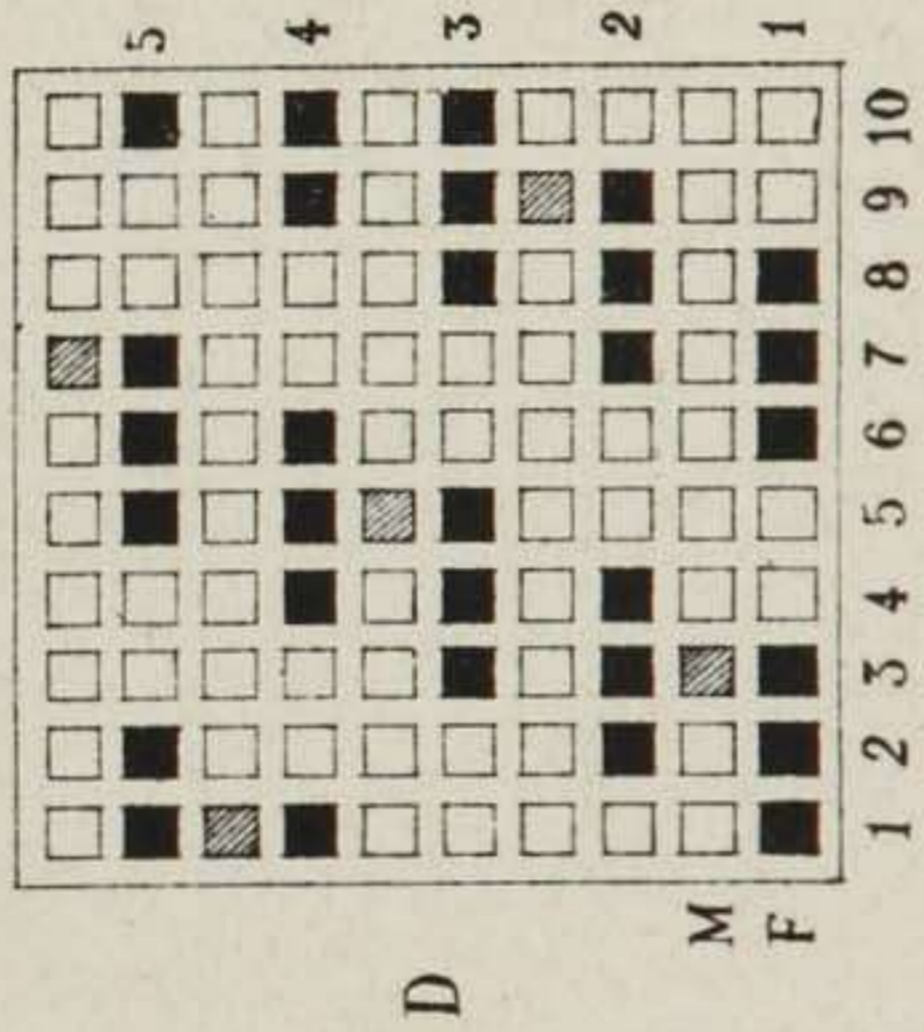


Fig.728.

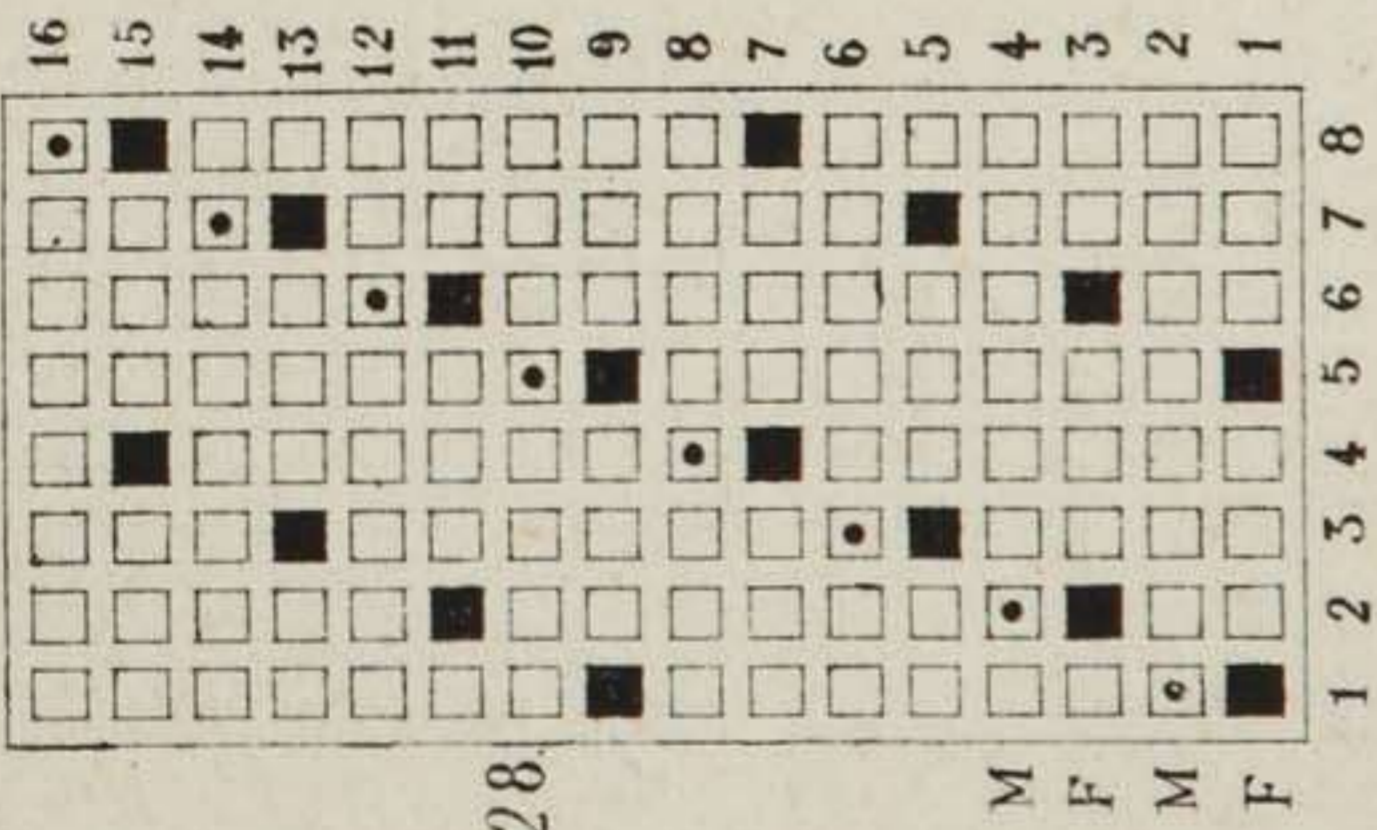


Fig.725:

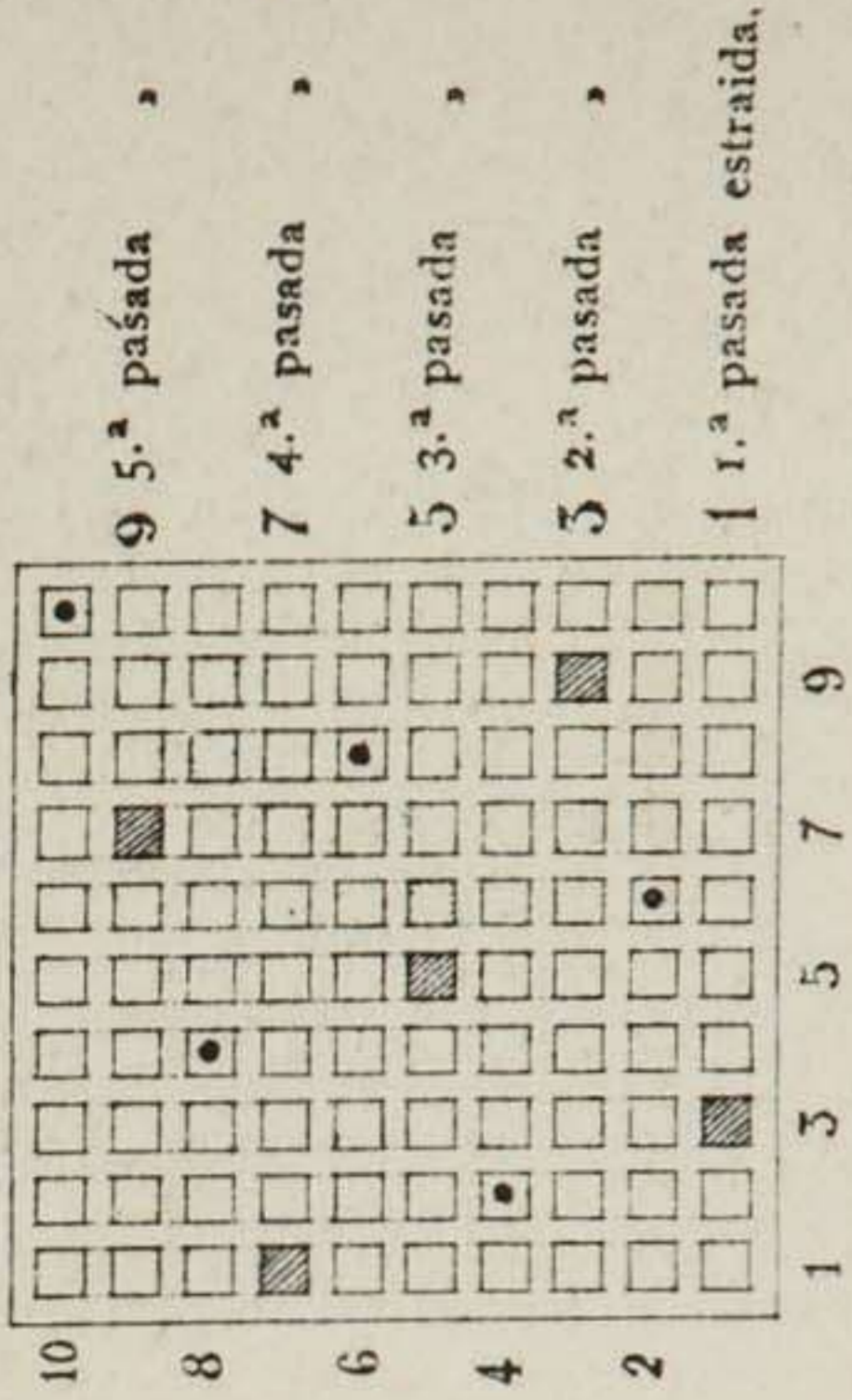


Fig.729.

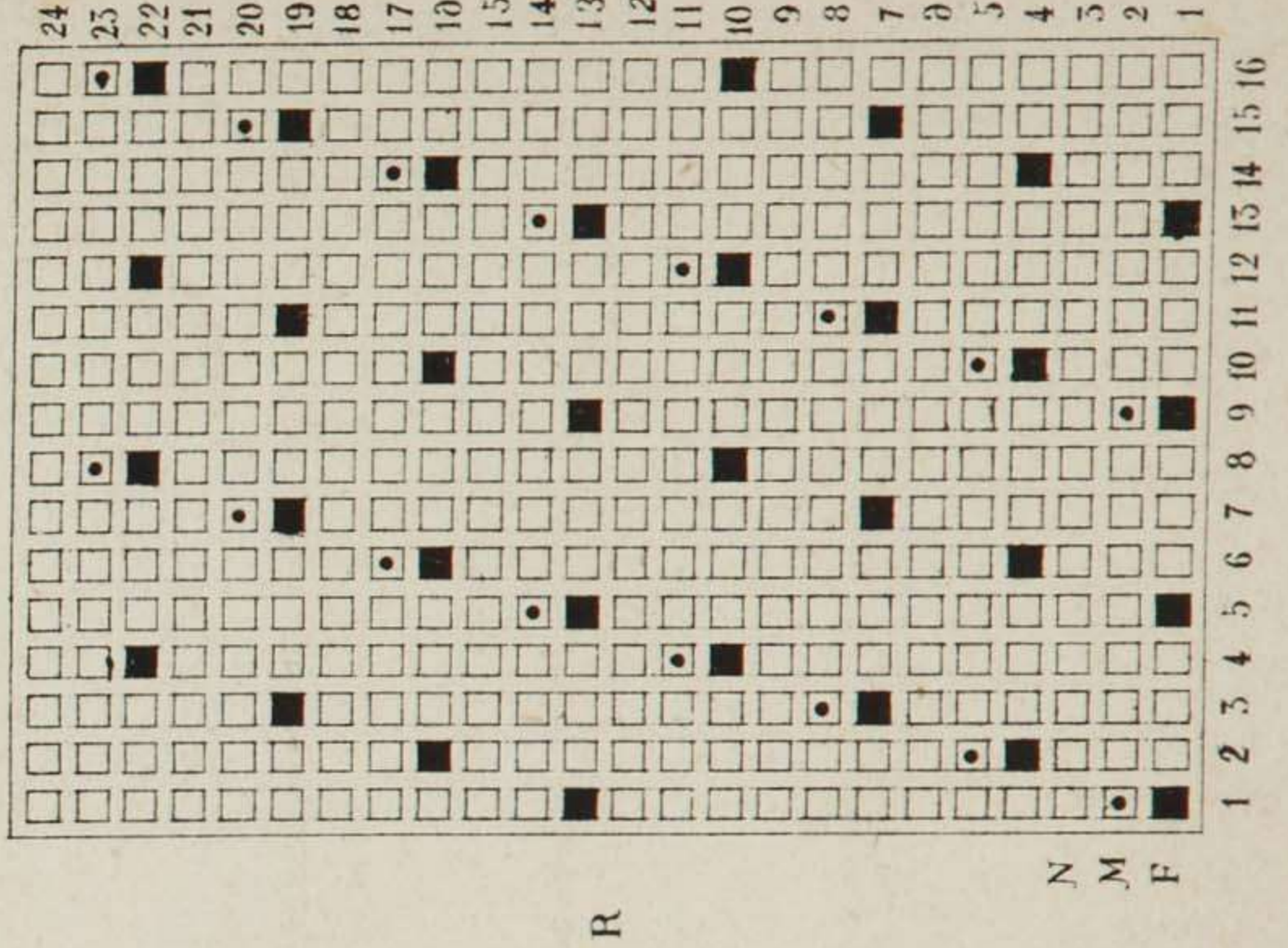
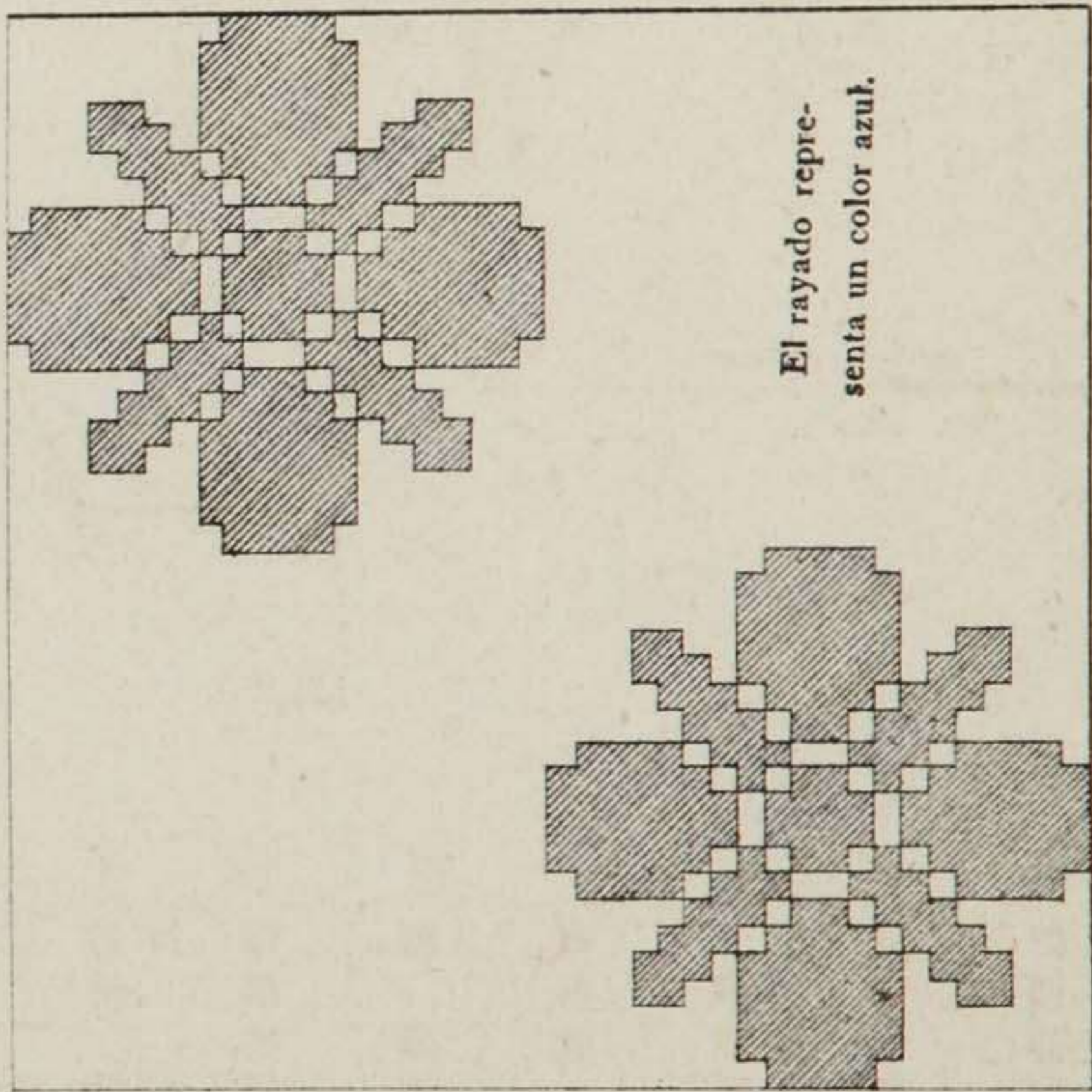


Fig.726.



DISEÑO.

Fig. 730.

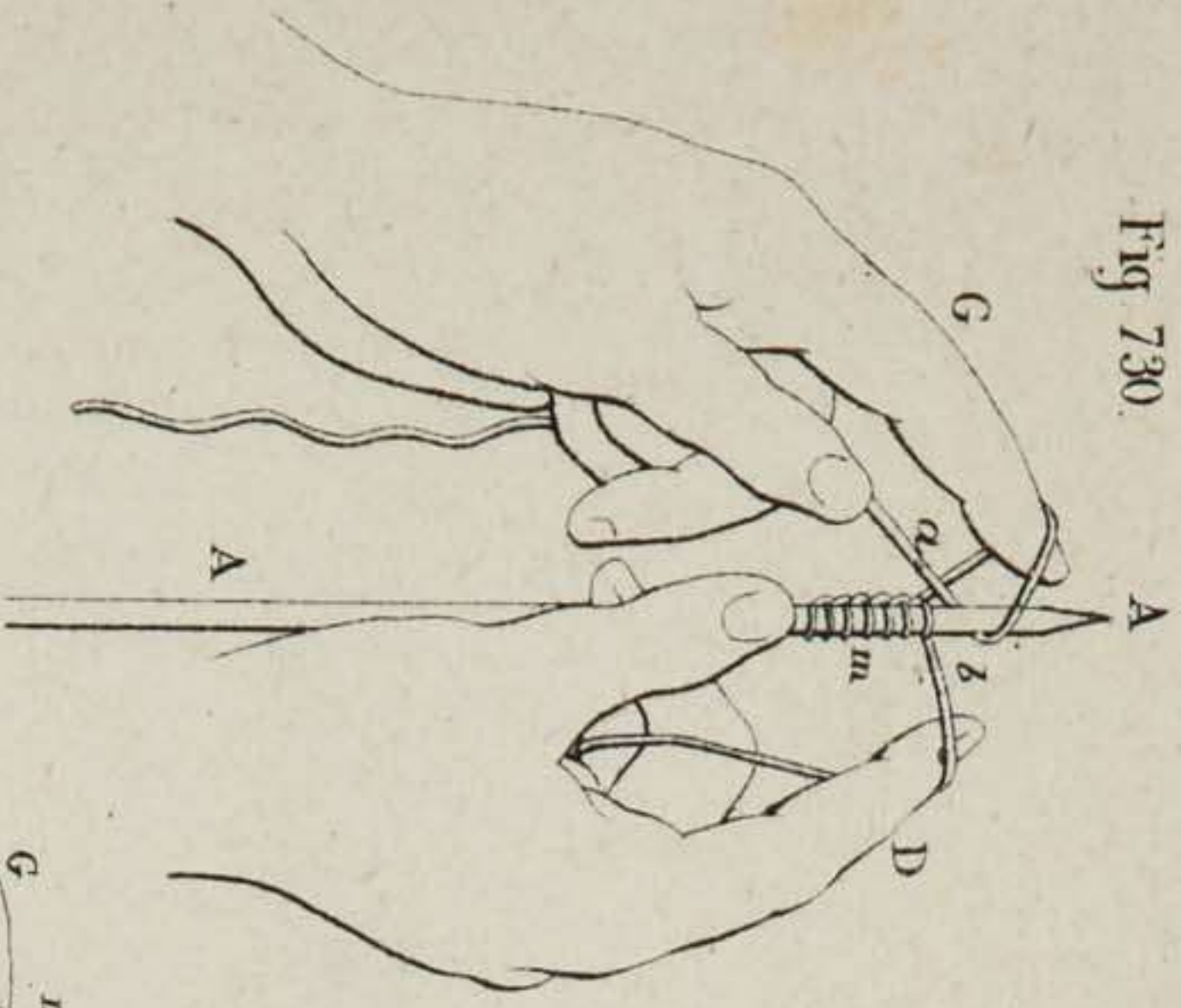


Fig. 731.

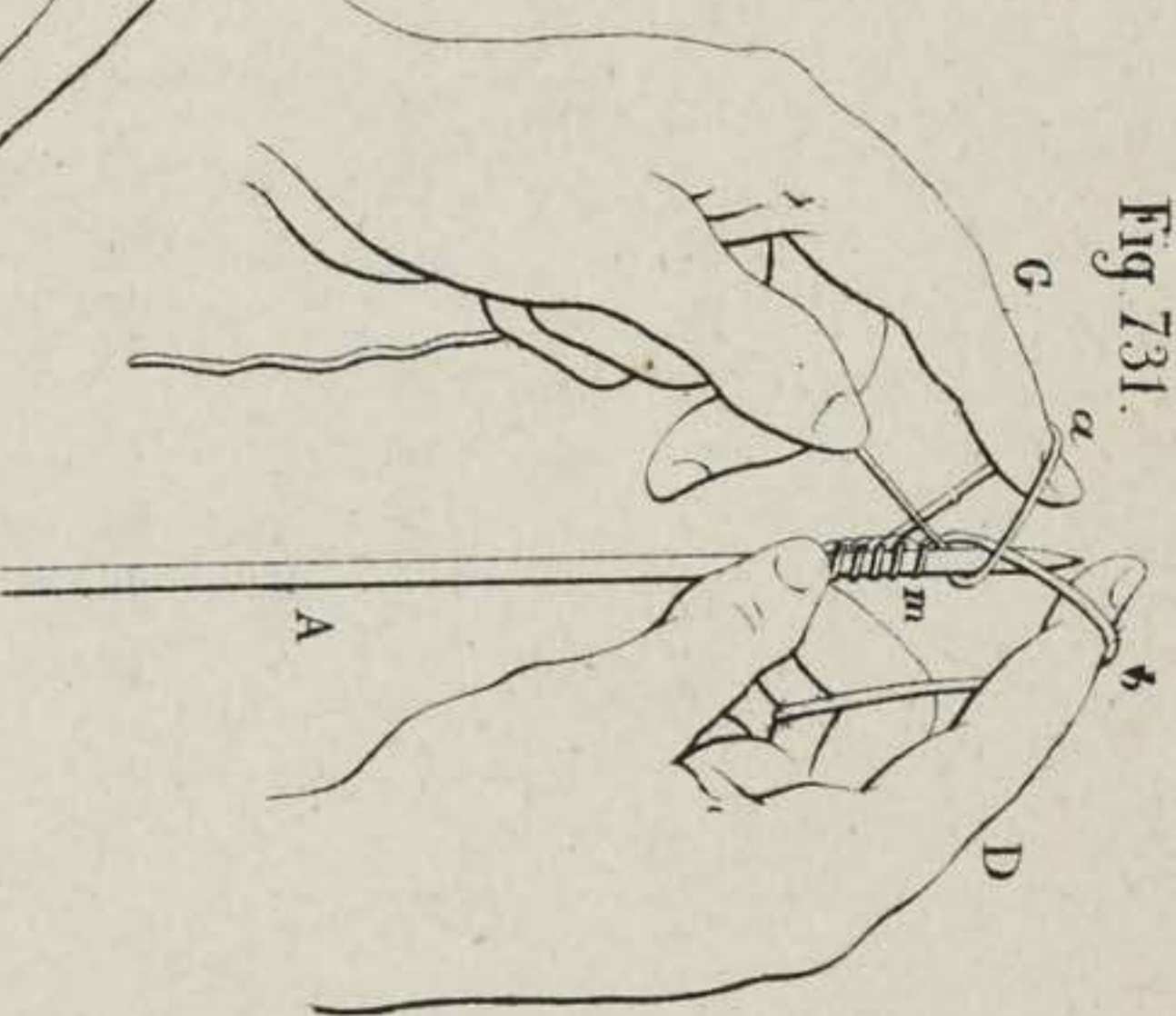


Fig. 732.

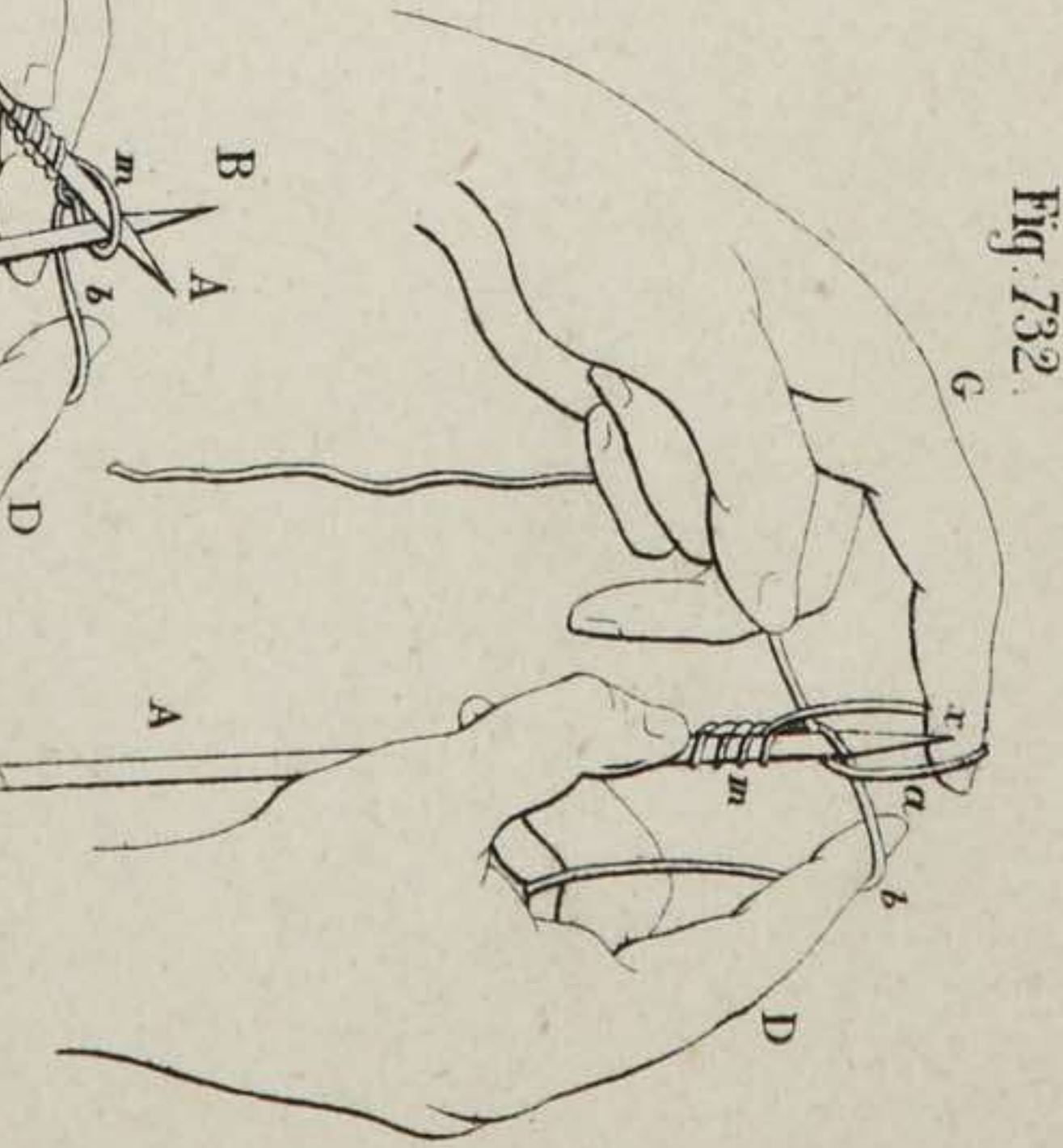


Fig. 735.

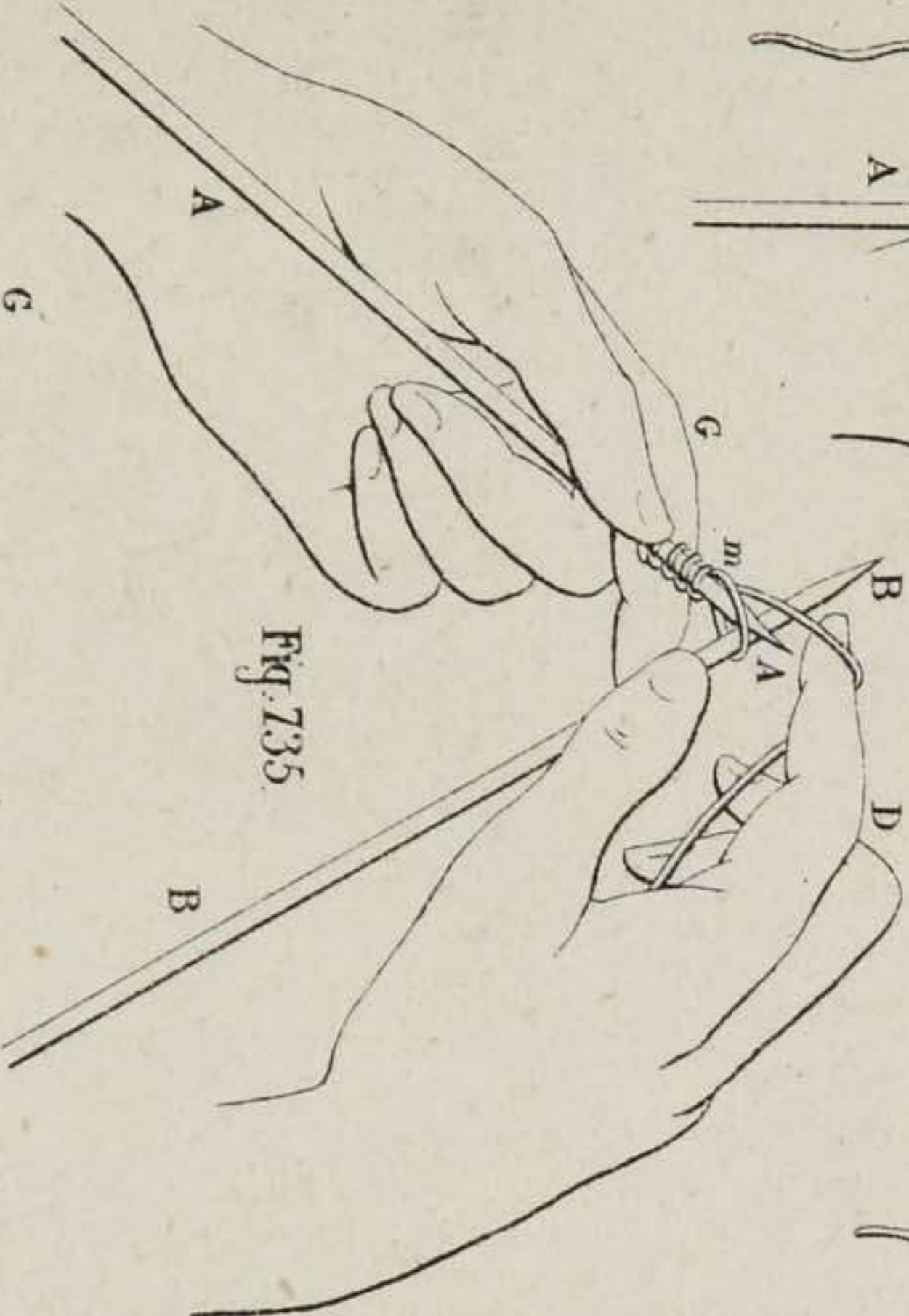


Fig. 734.

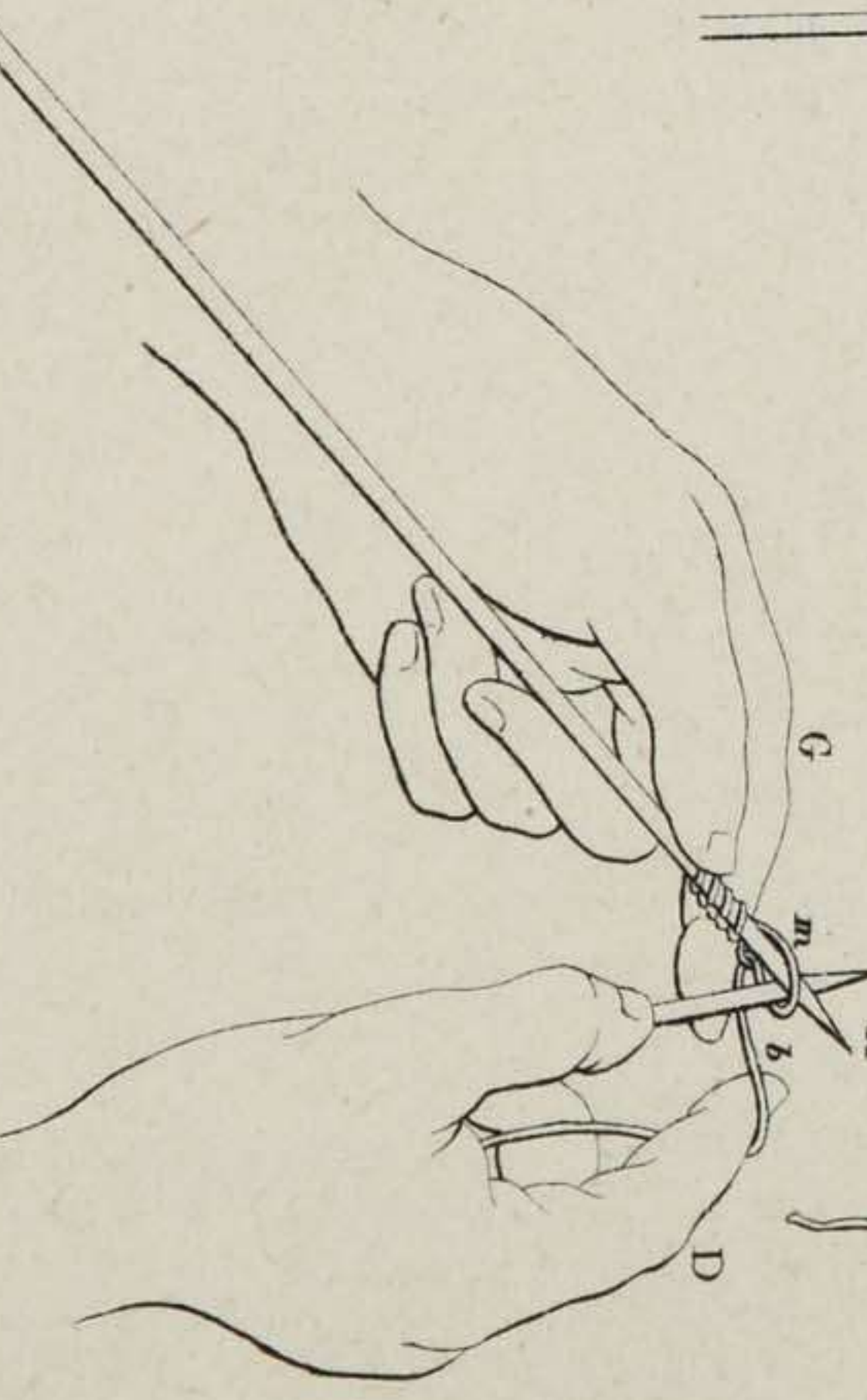


Fig. 733.



Fig. 736.



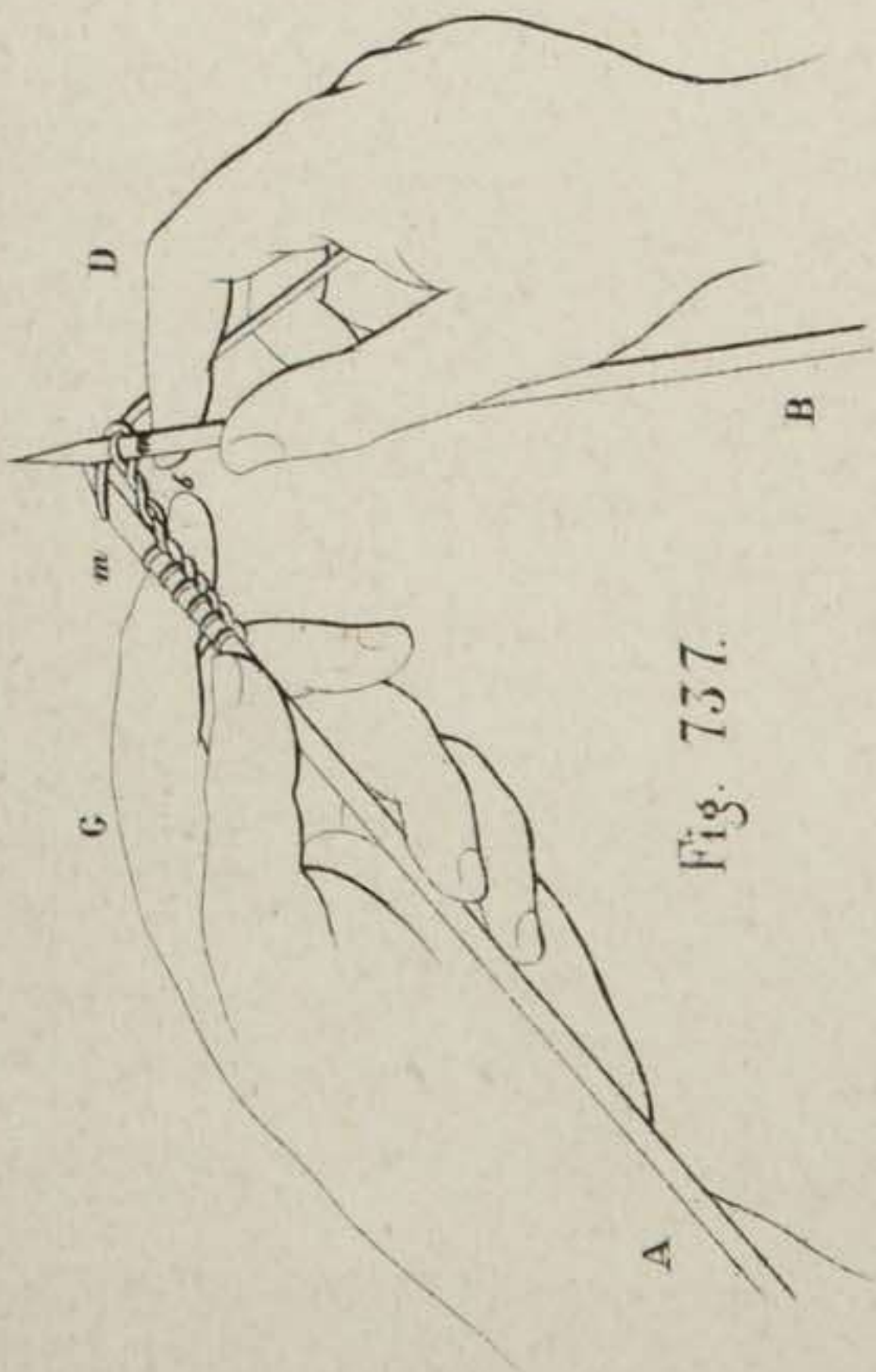


Fig. 737.

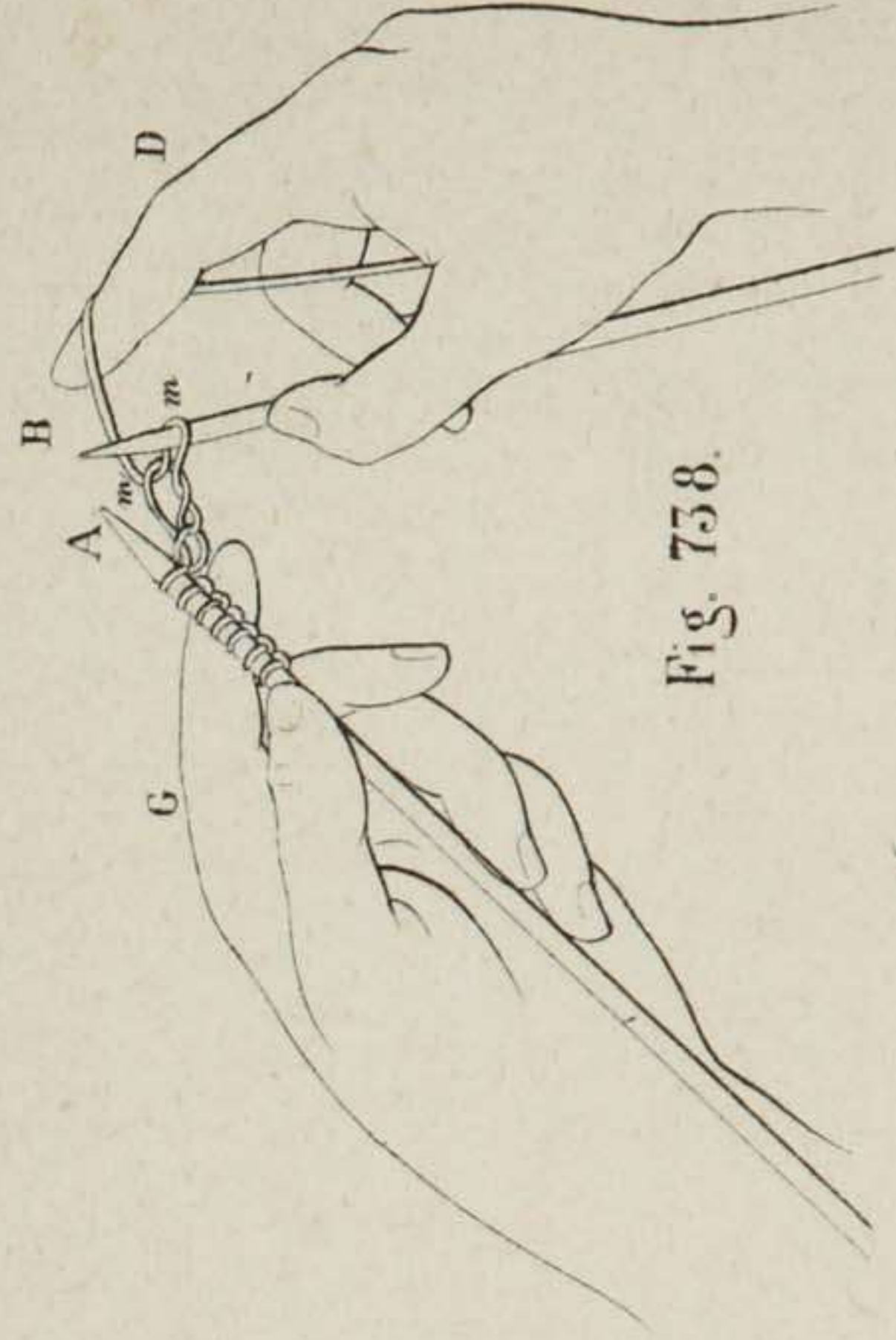


Fig. 738.

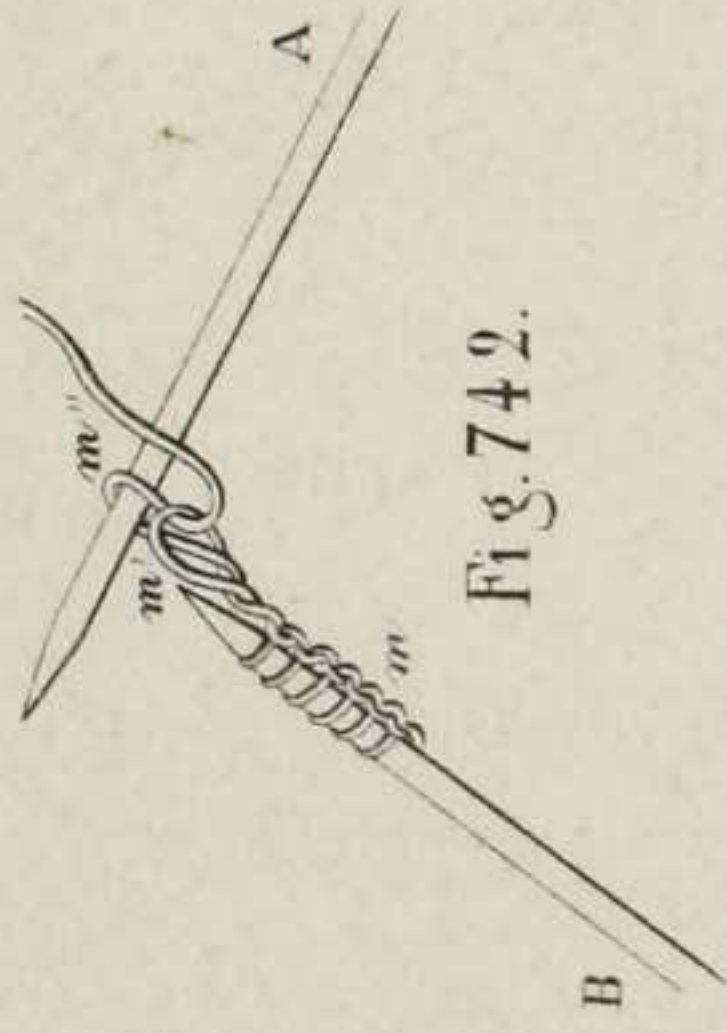


Fig. 742.

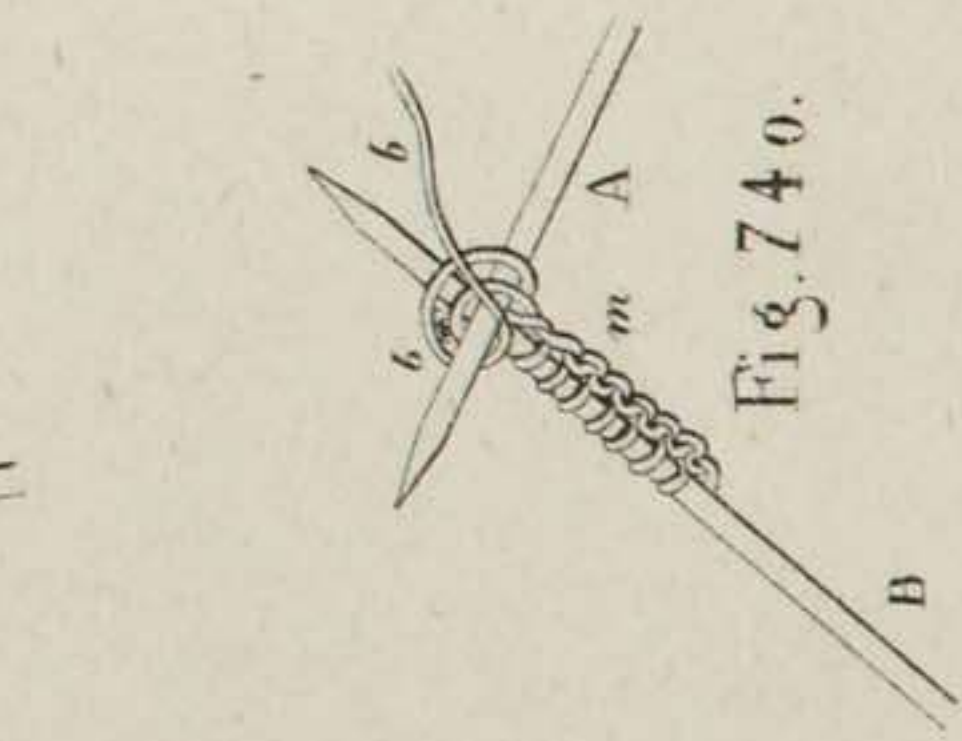


Fig. 740.

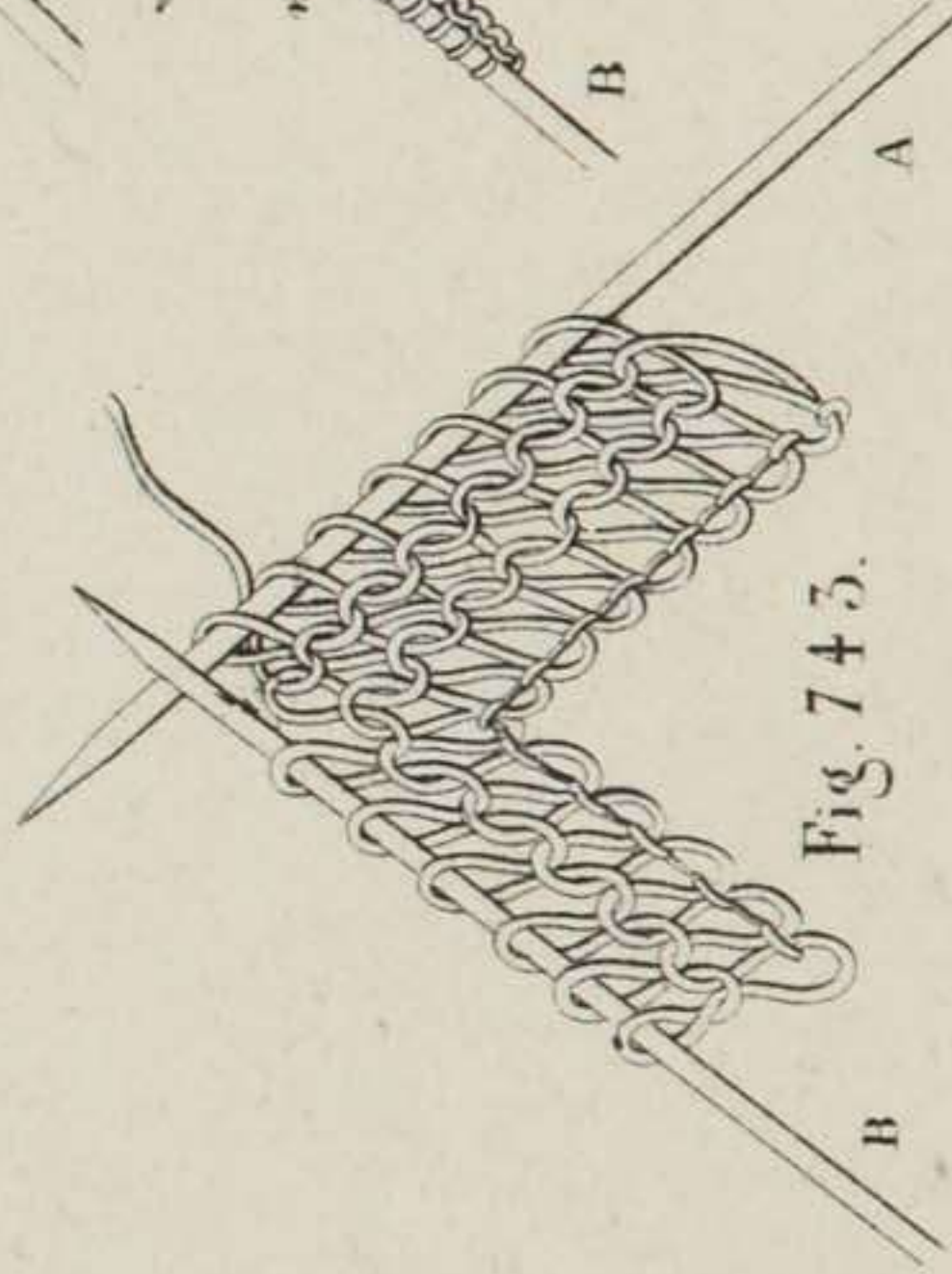


Fig. 743.

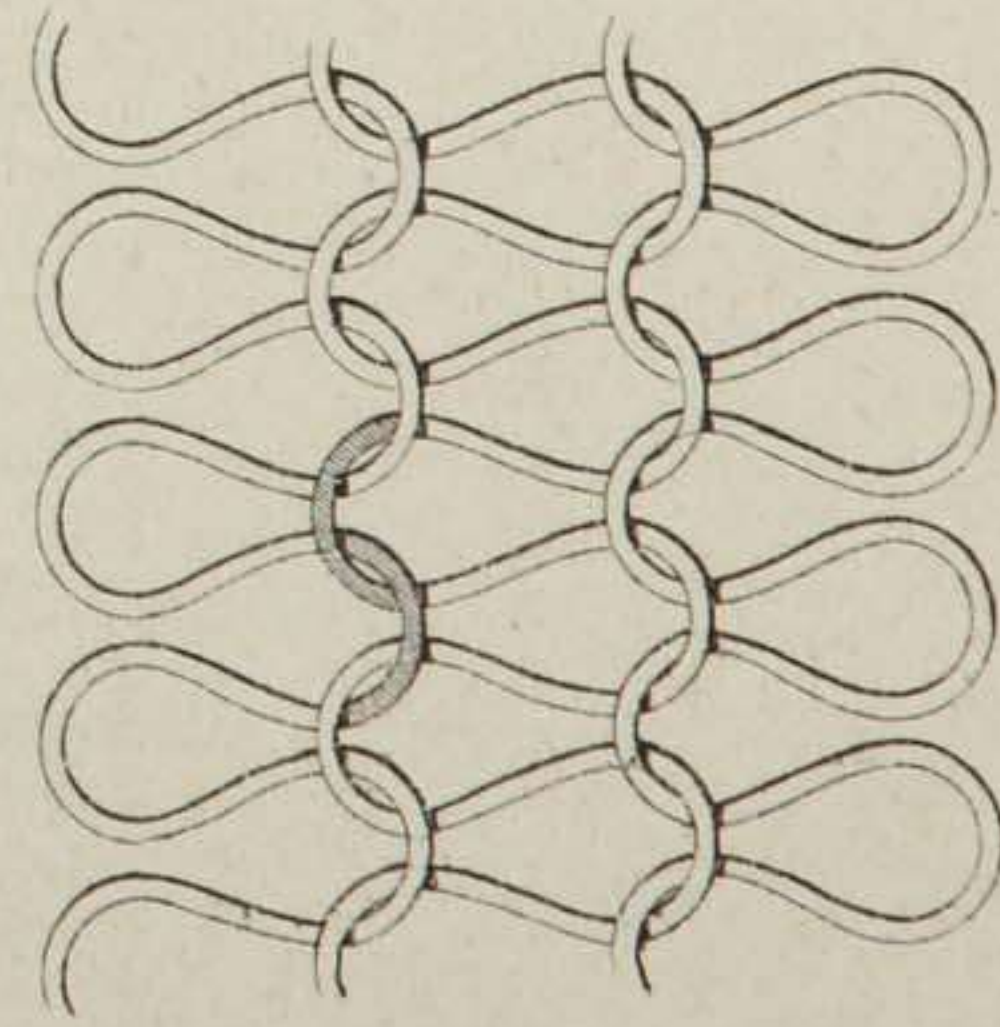


Fig. 744.

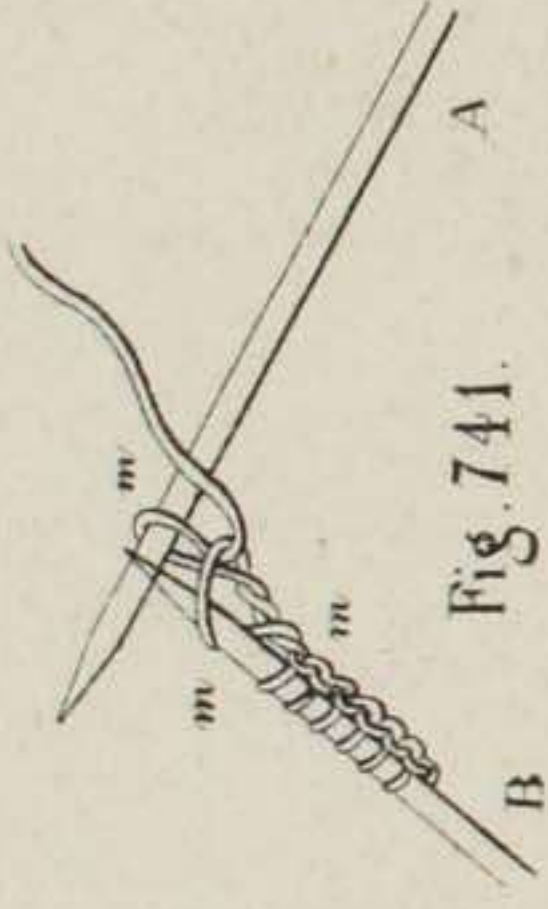


Fig. 741.

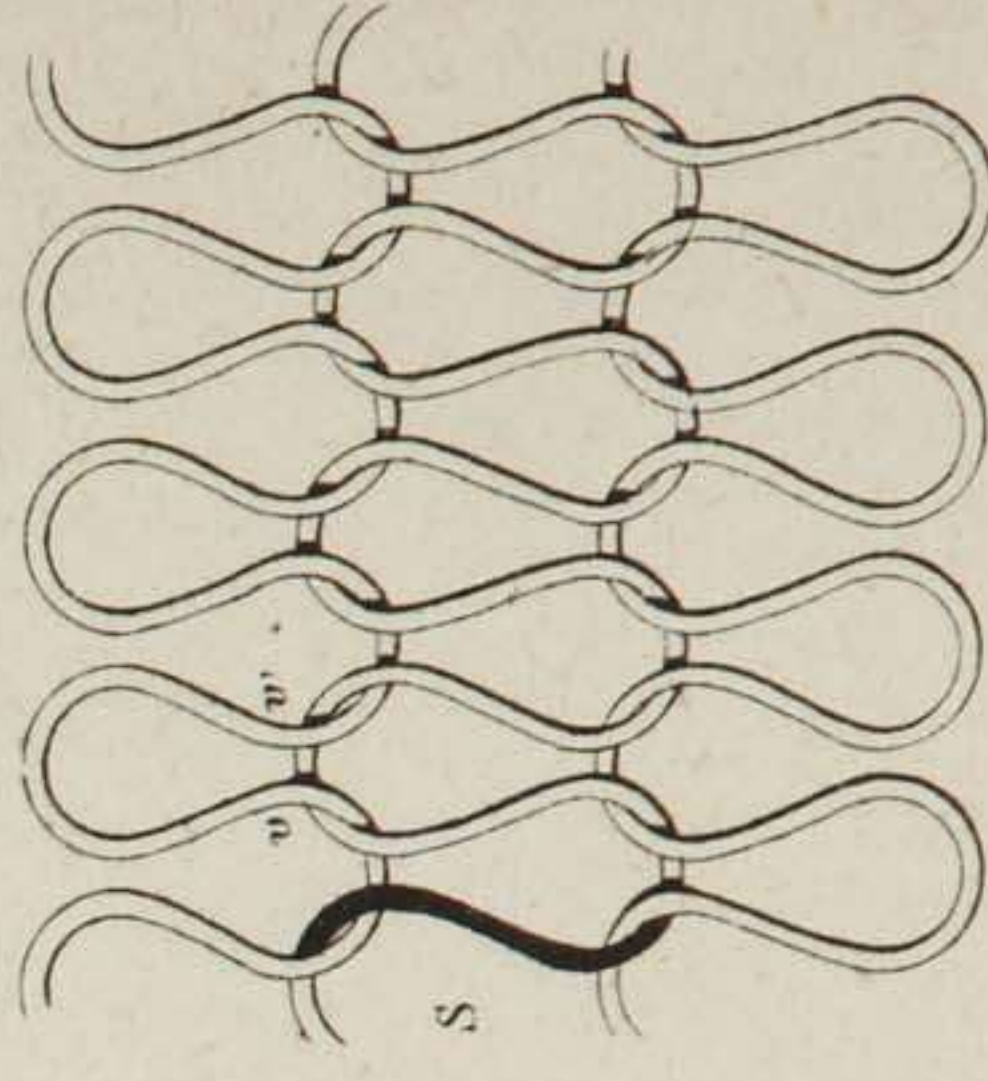


Fig. 745.

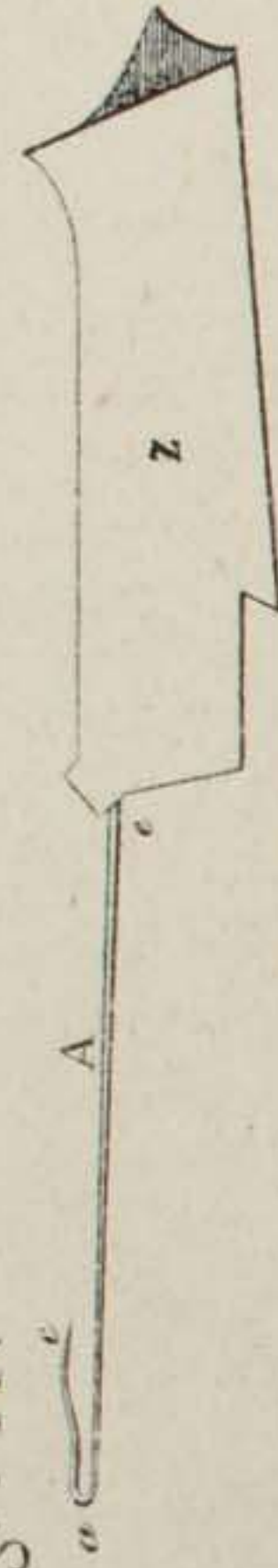


Fig. 747.

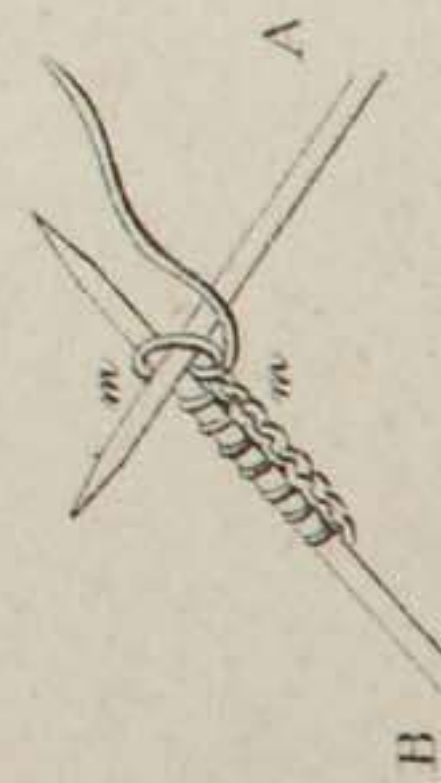


Fig. 739.

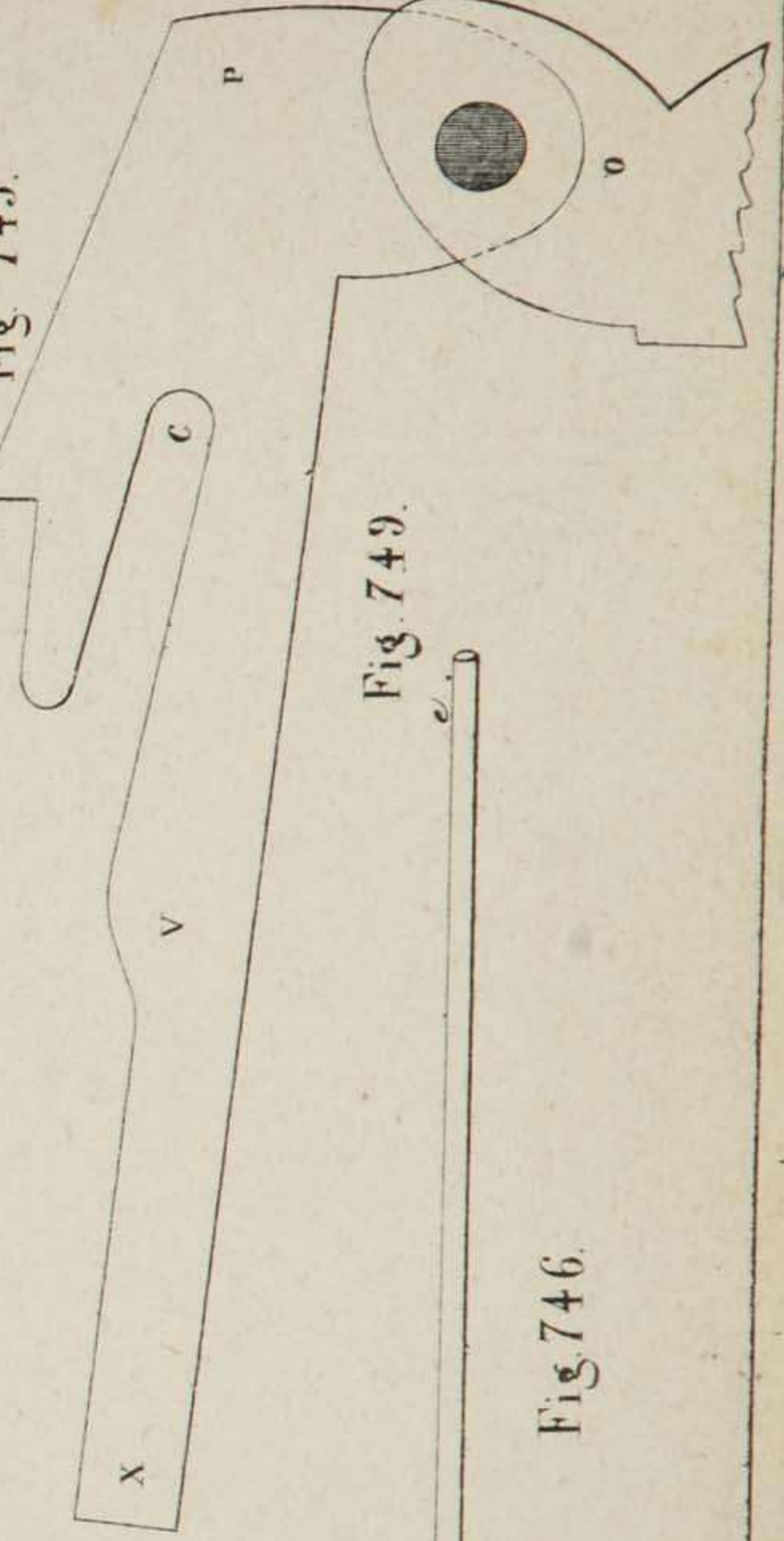


Fig. 746.

Fig. 749.

Fig. 754.

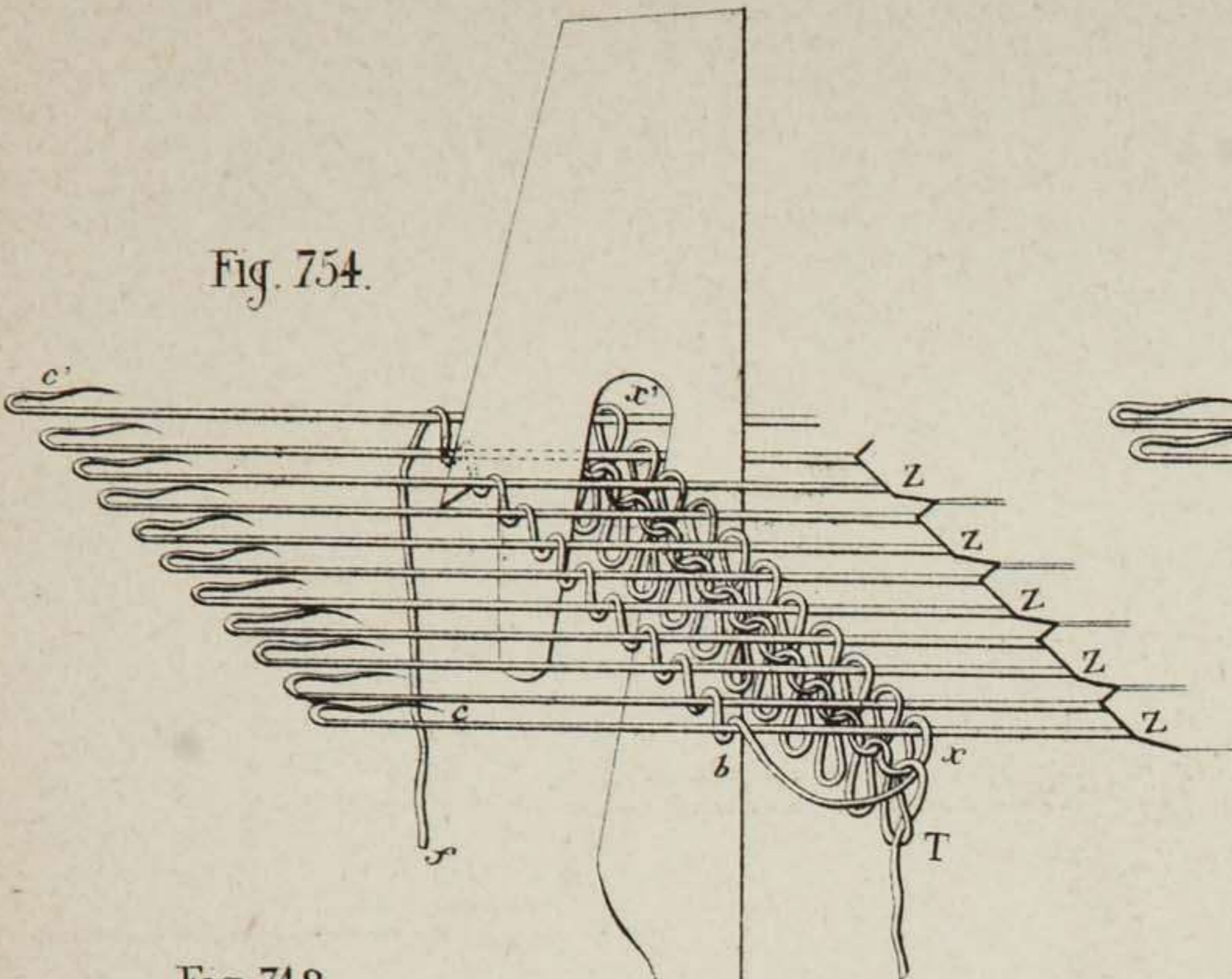


Fig. 752.

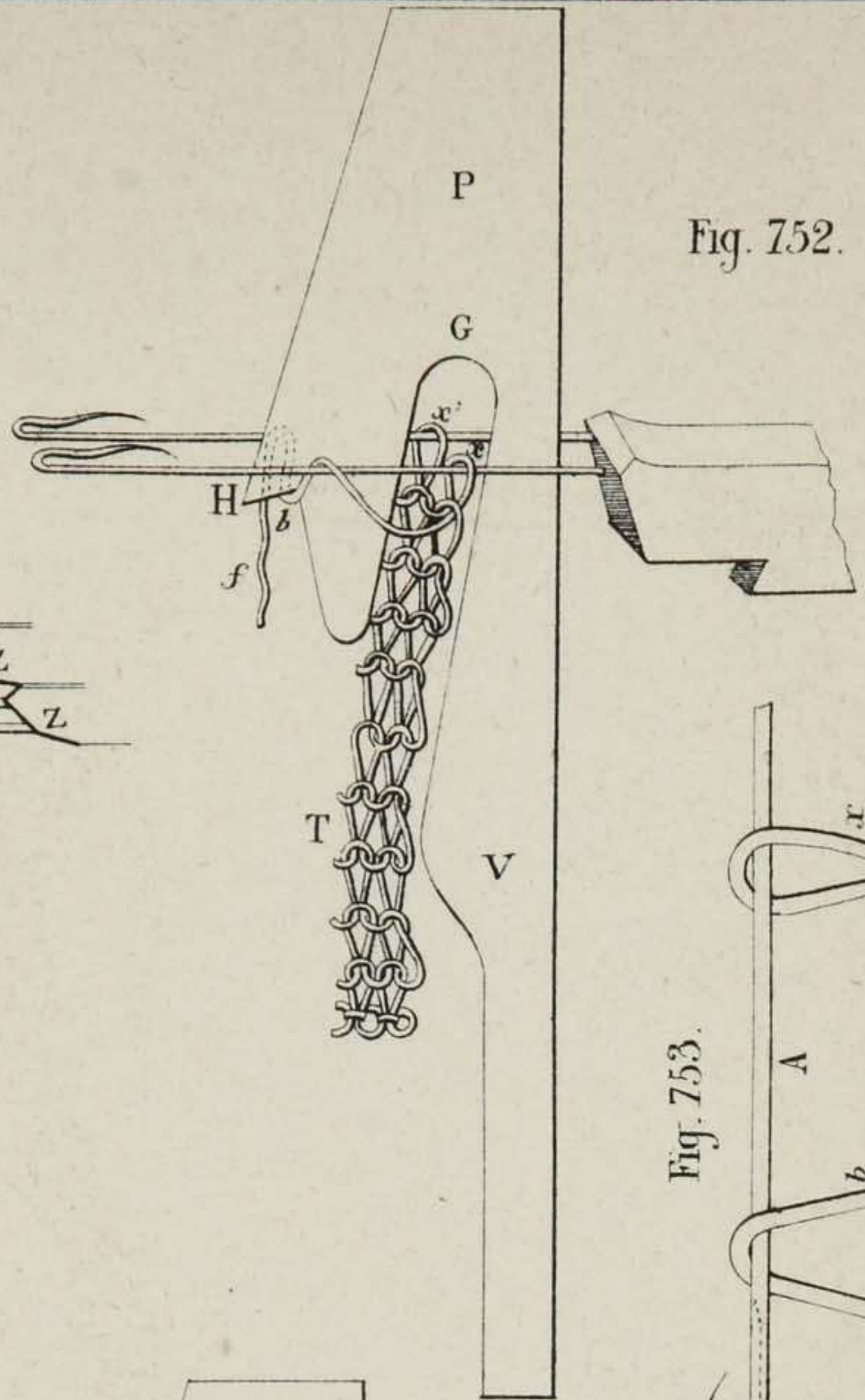


Fig. 748.

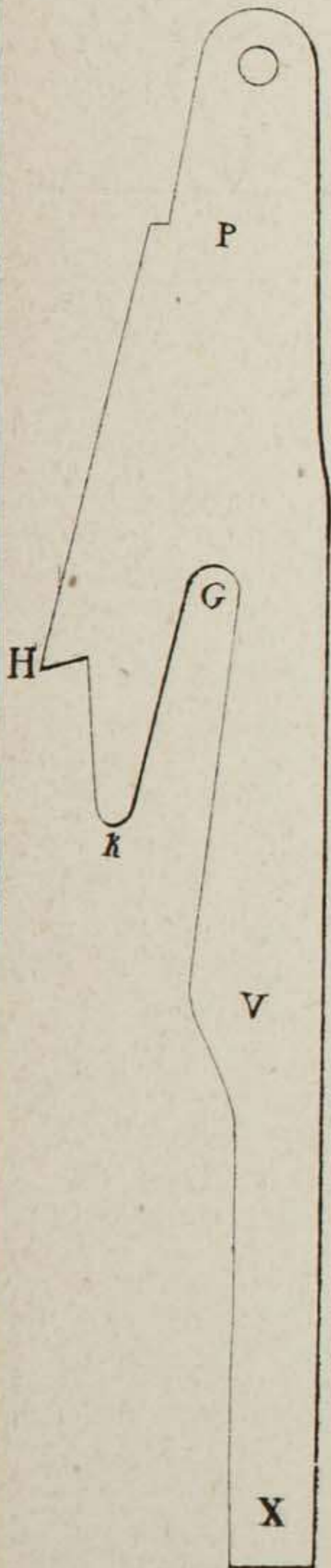


Fig. 753.

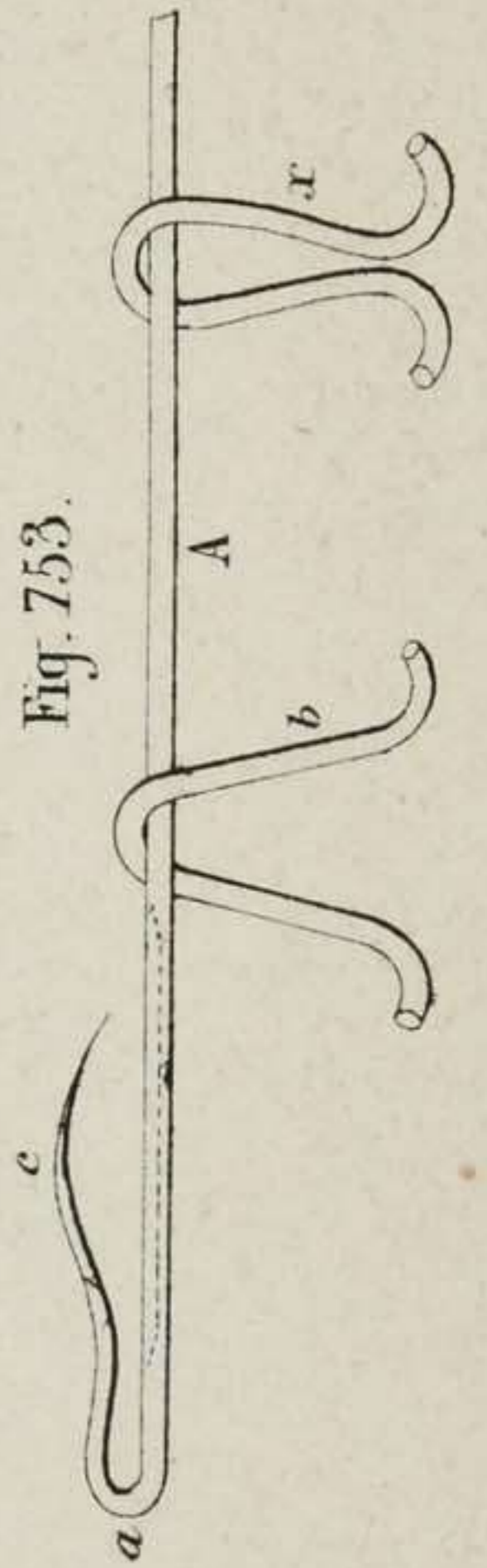


Fig. 750.

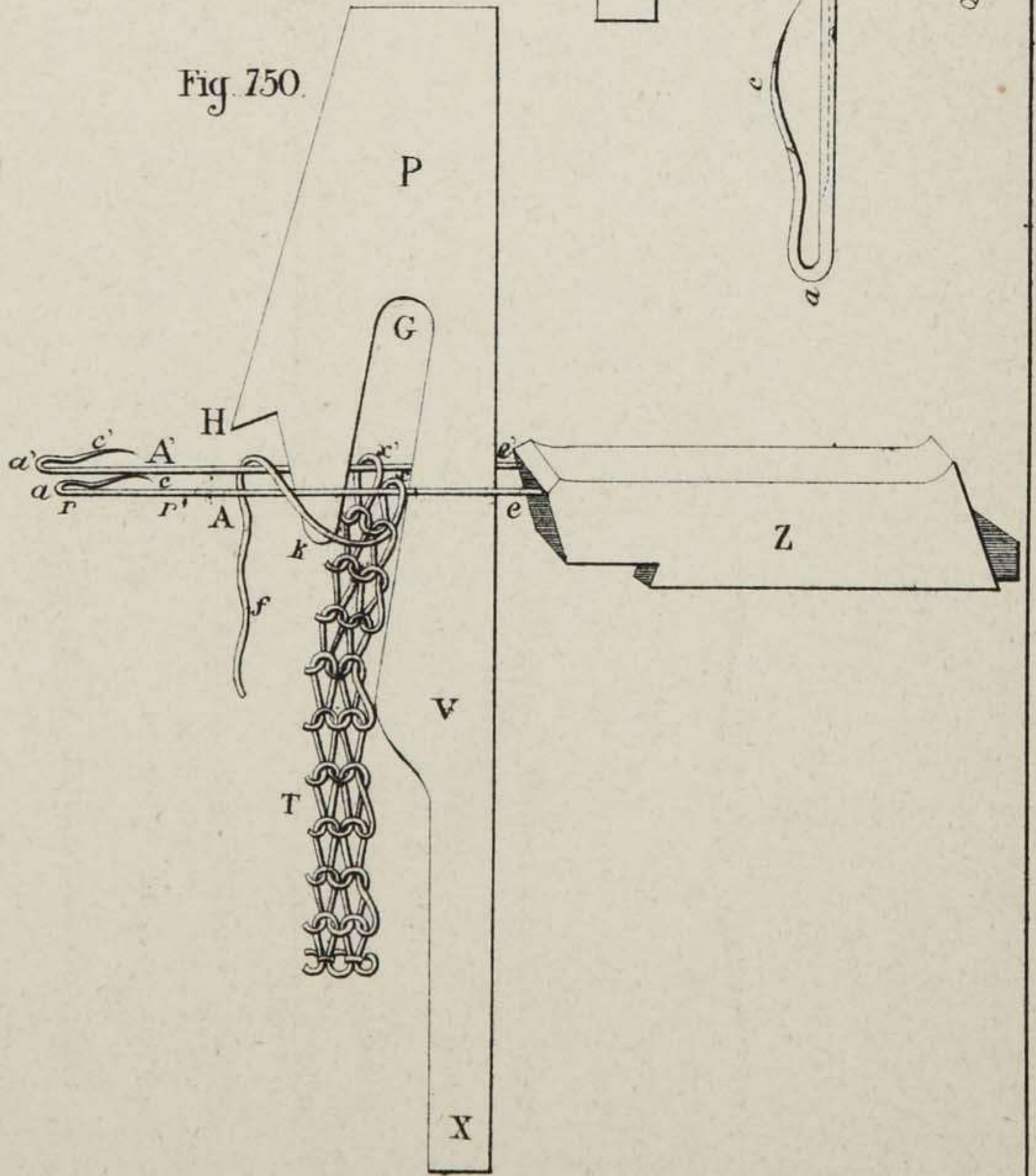


Fig. 751.

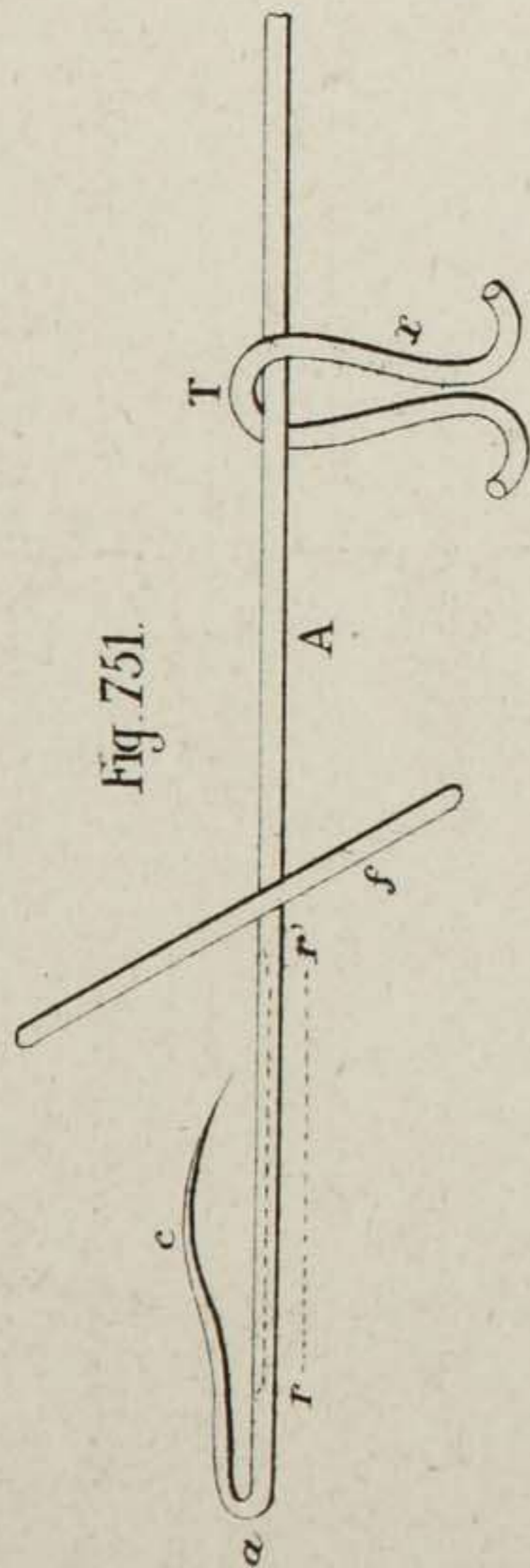


Fig. 756.

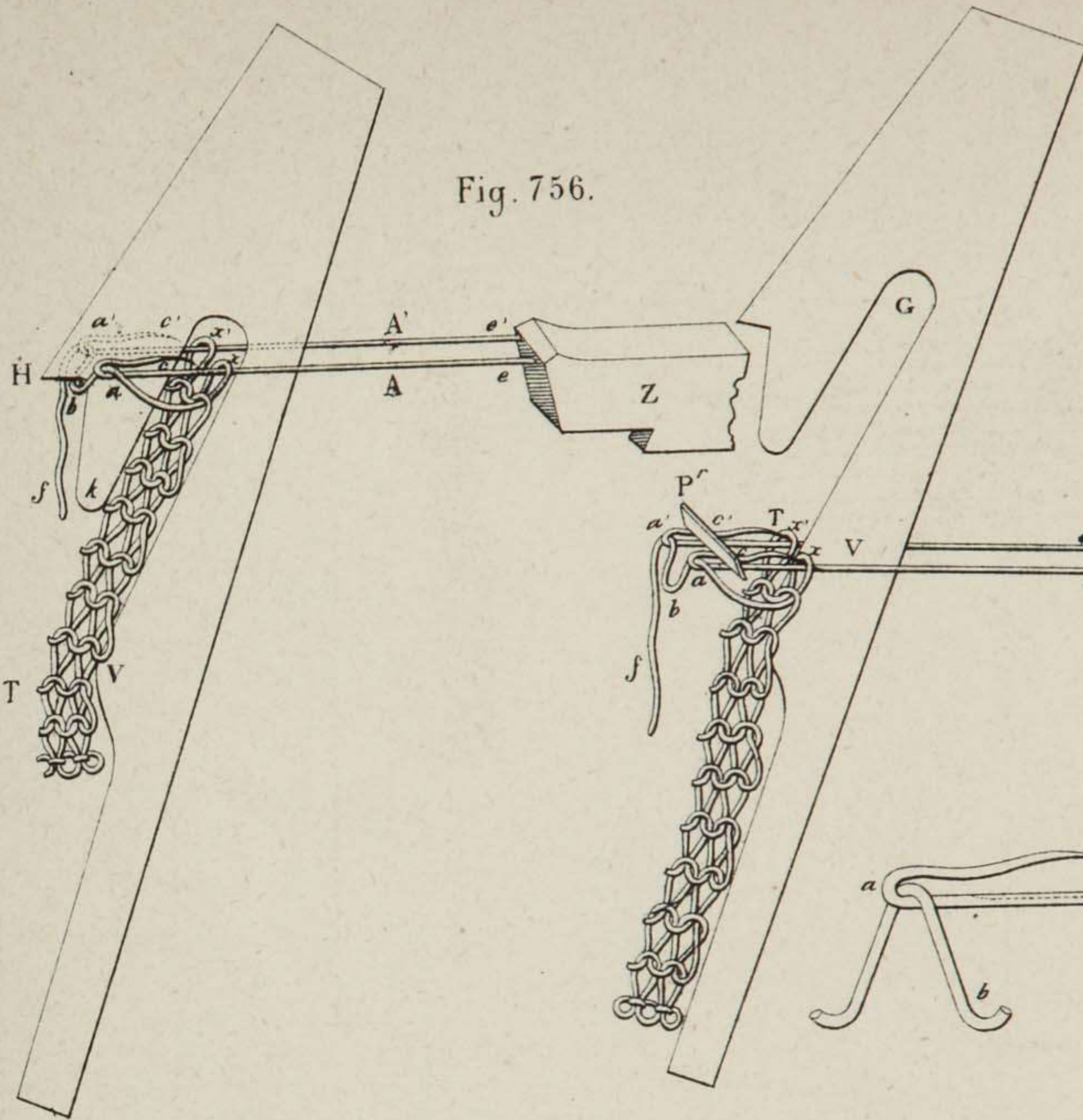


Fig. 758.

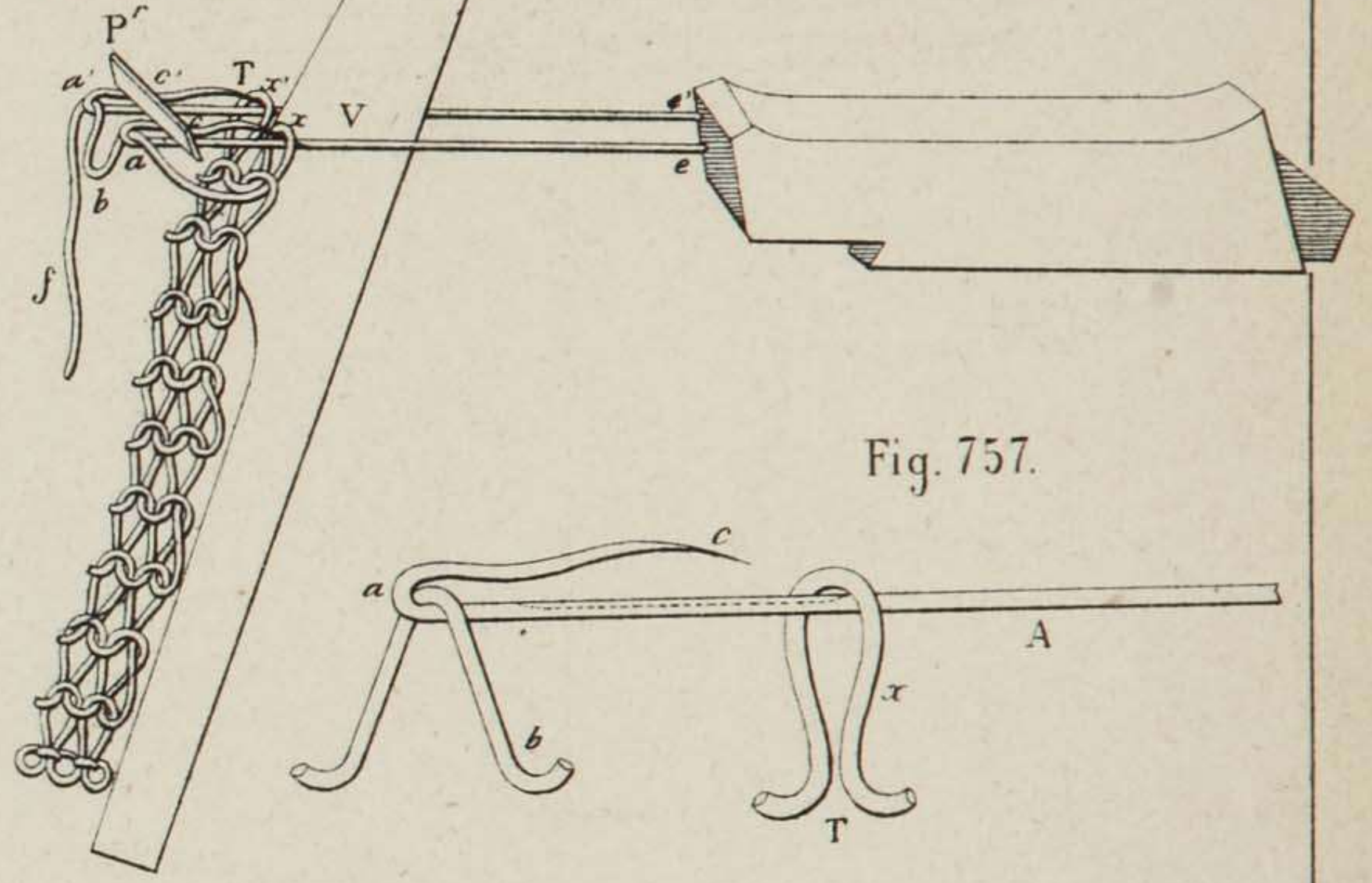


Fig. 757.

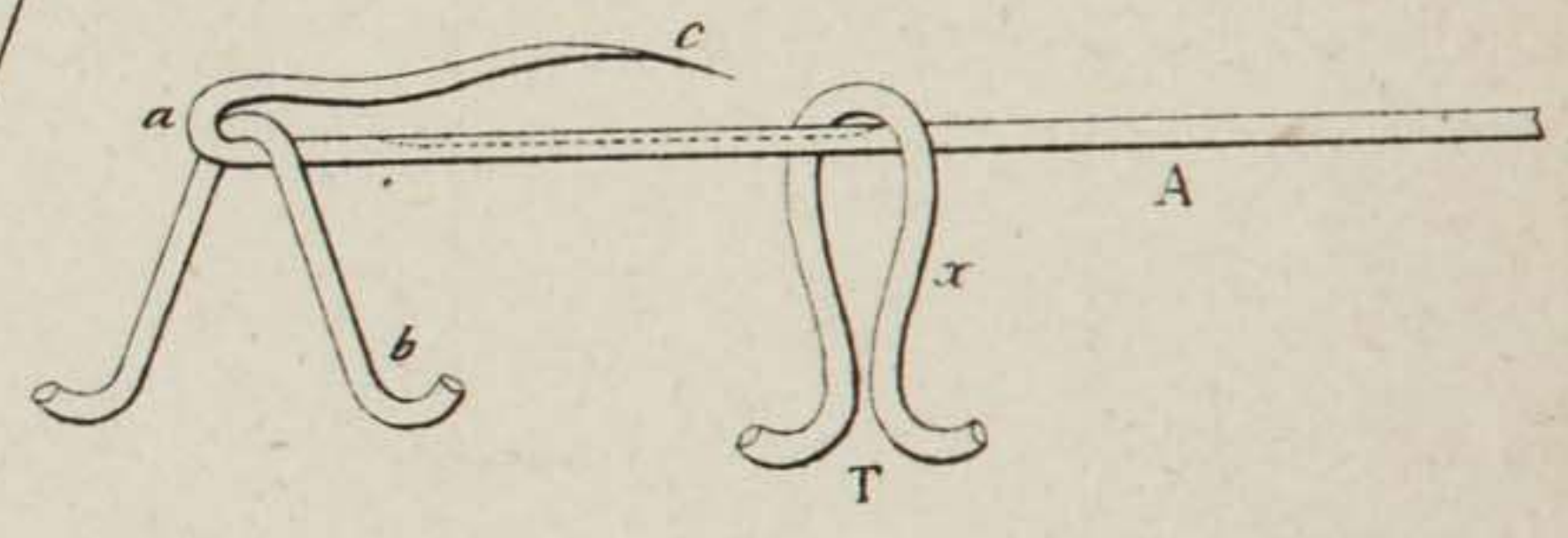


Fig. 755.

FORMACION

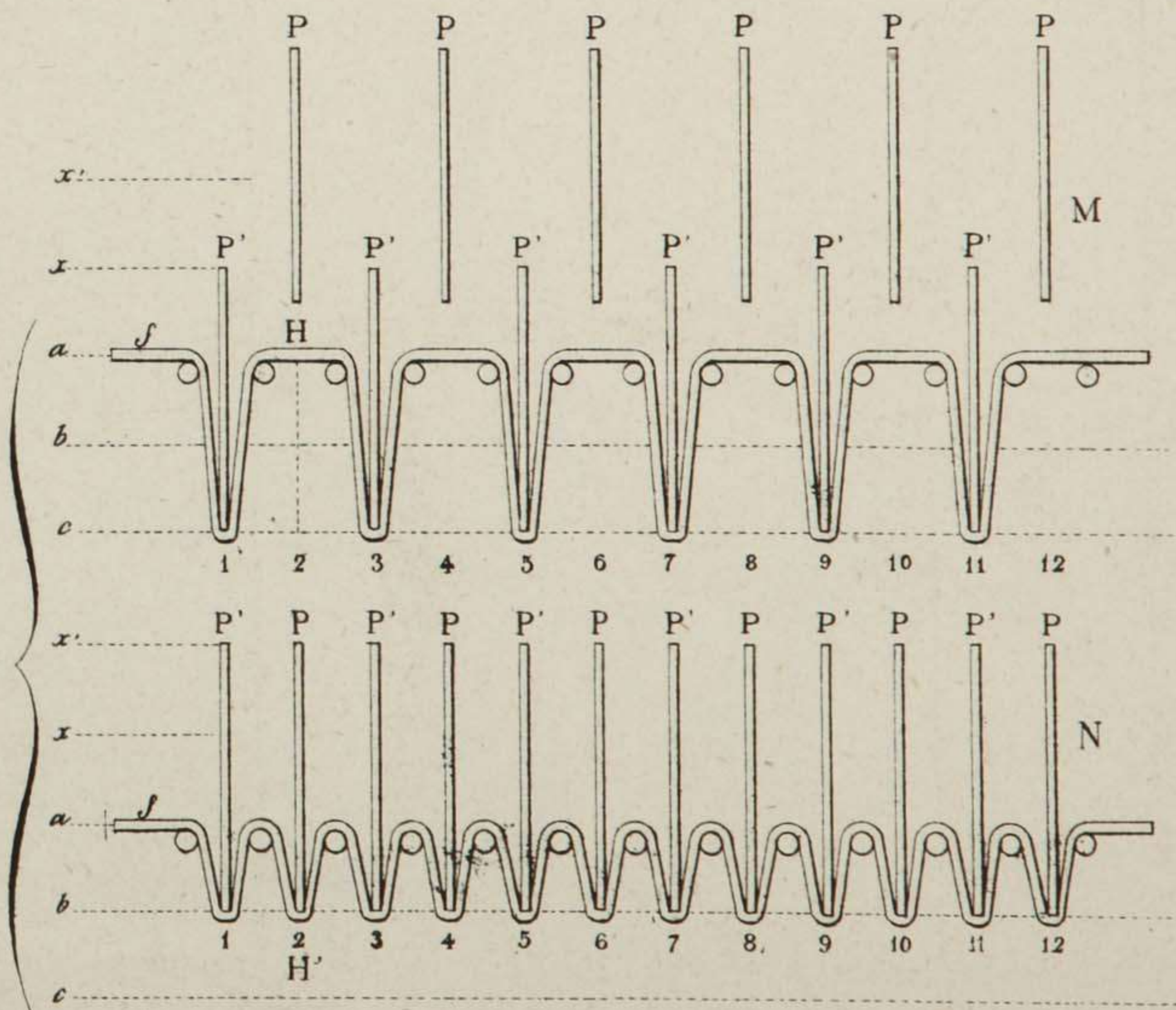




Fig. 765.

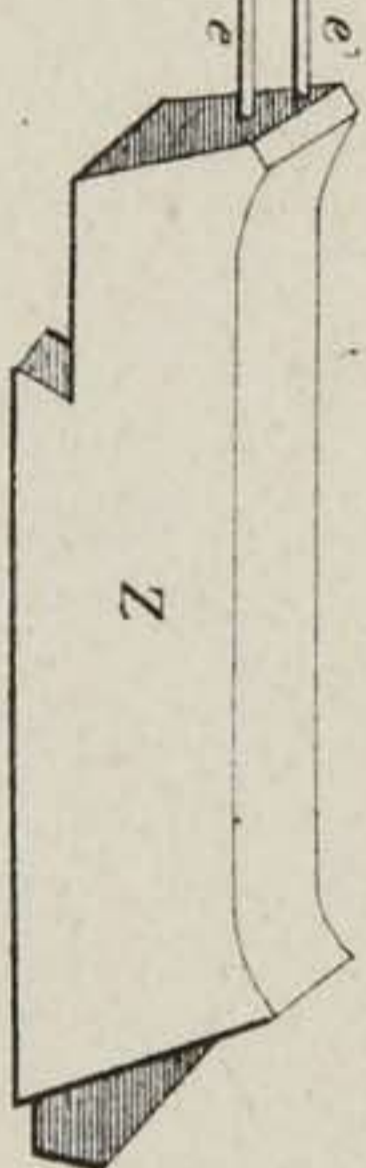


Fig. 764.

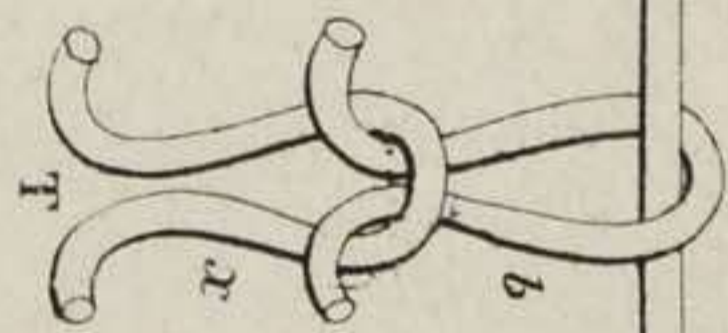


Fig. 760.

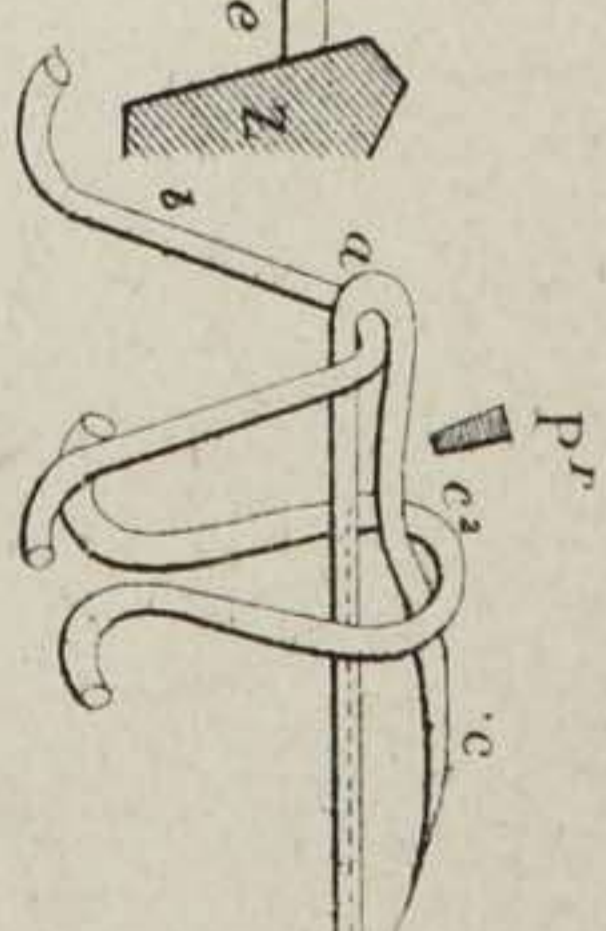


Fig. 761.

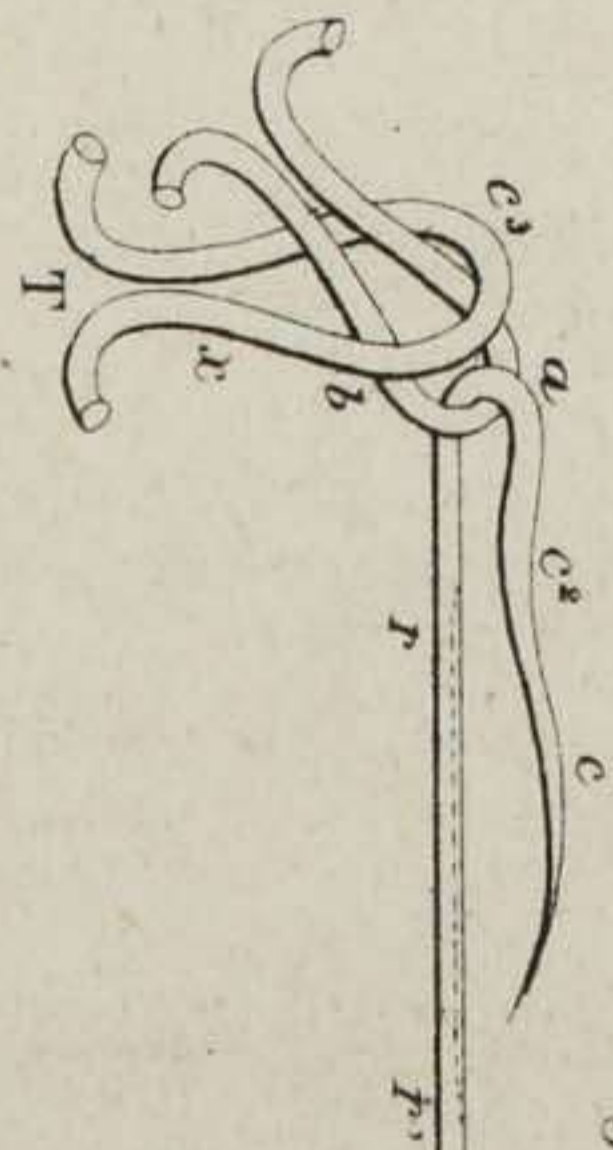


Fig. 759.

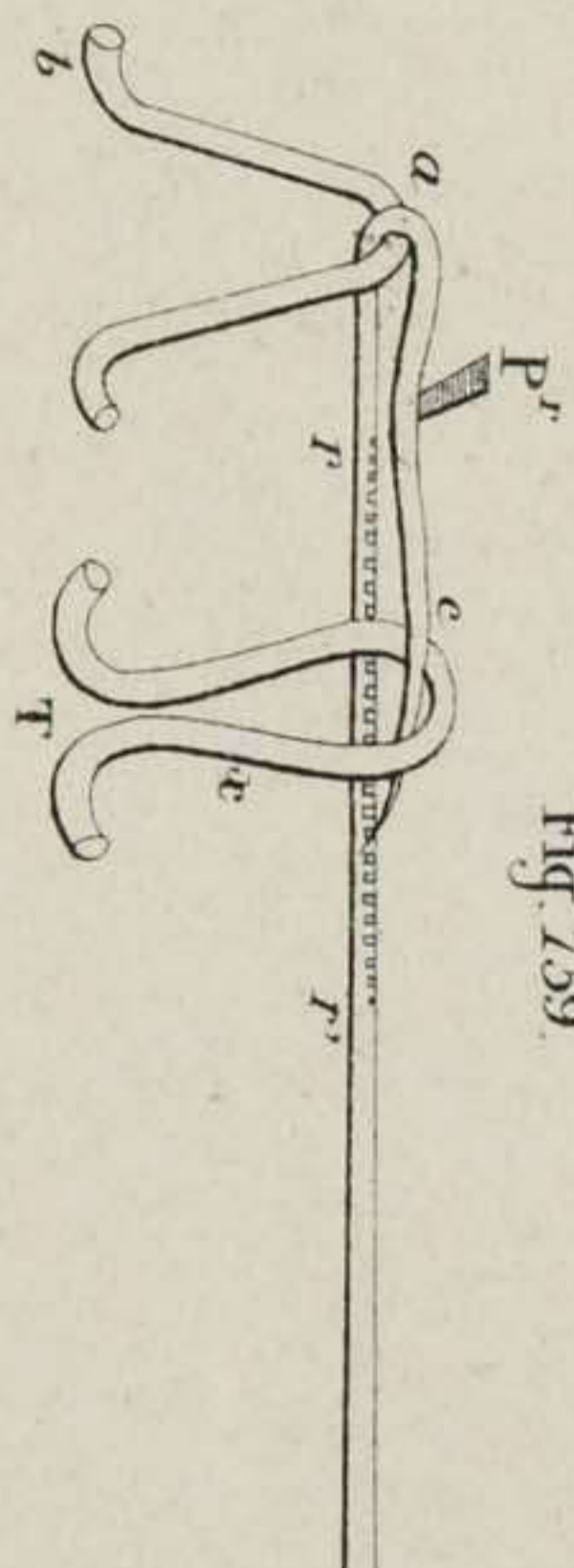


Fig. 762.

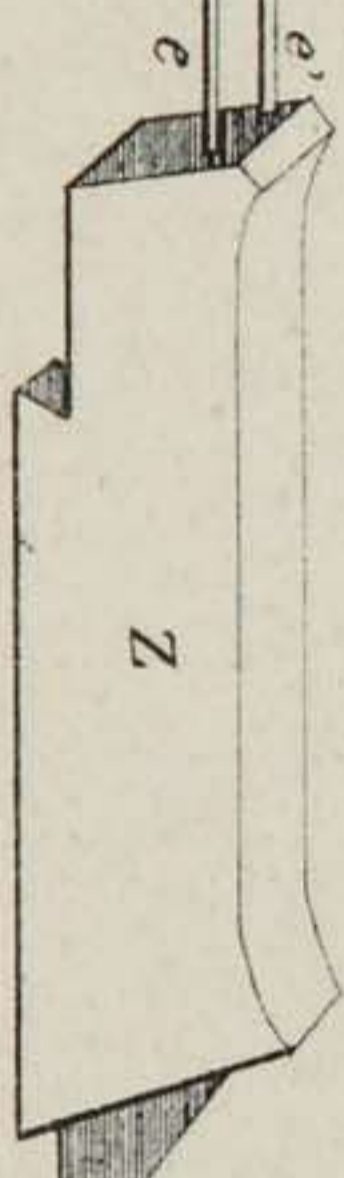


Fig. 763.

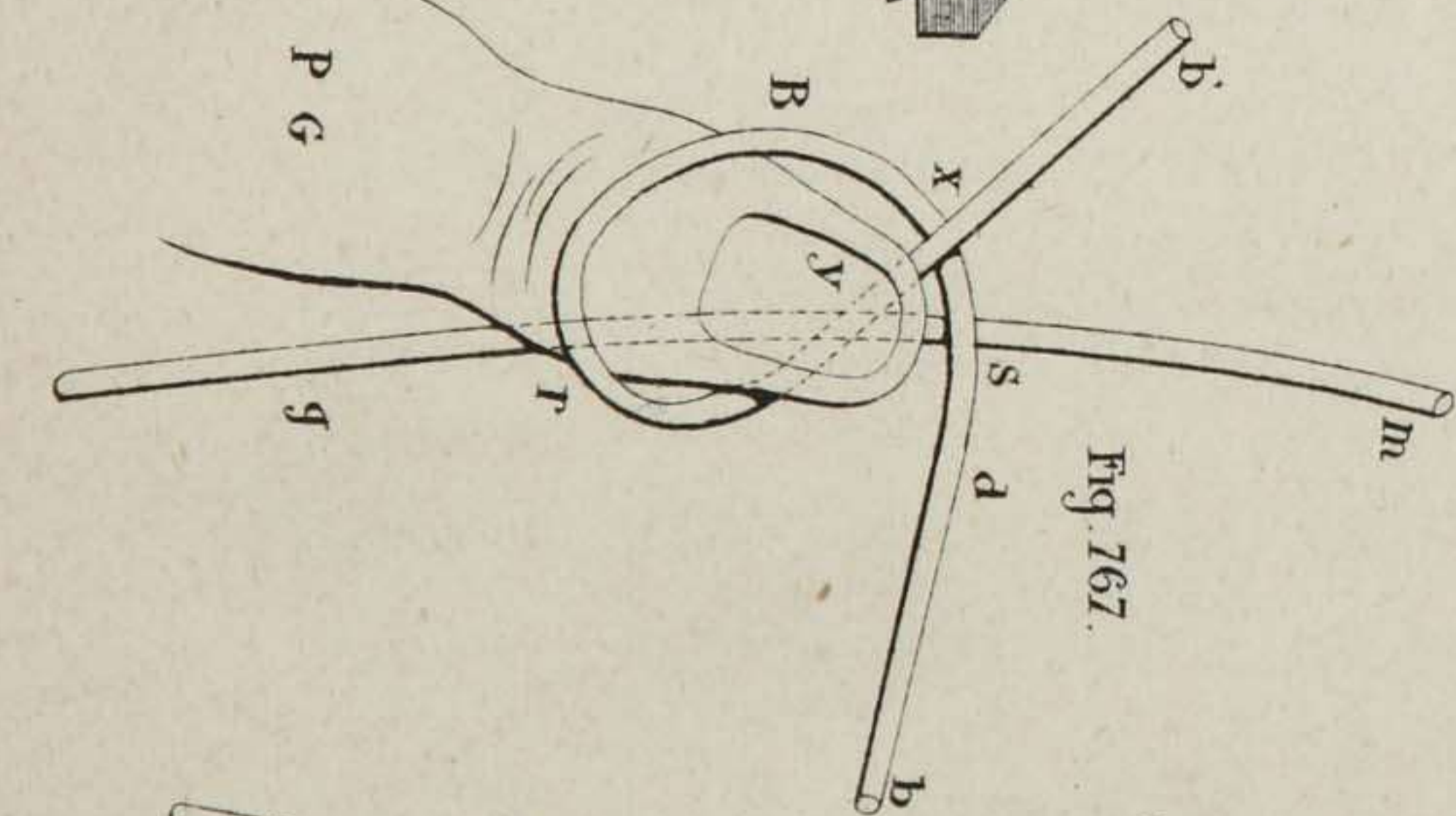


Fig. 767.

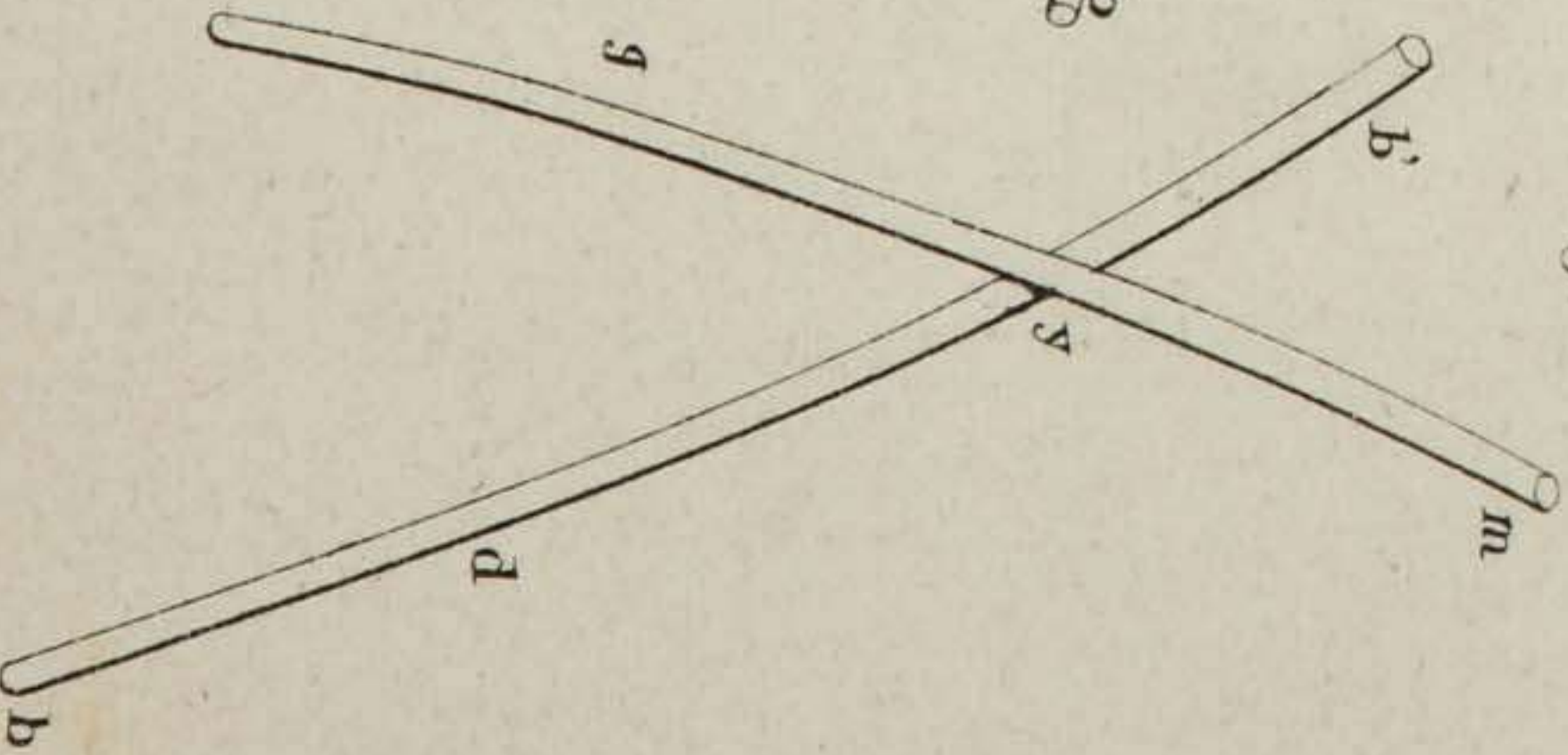
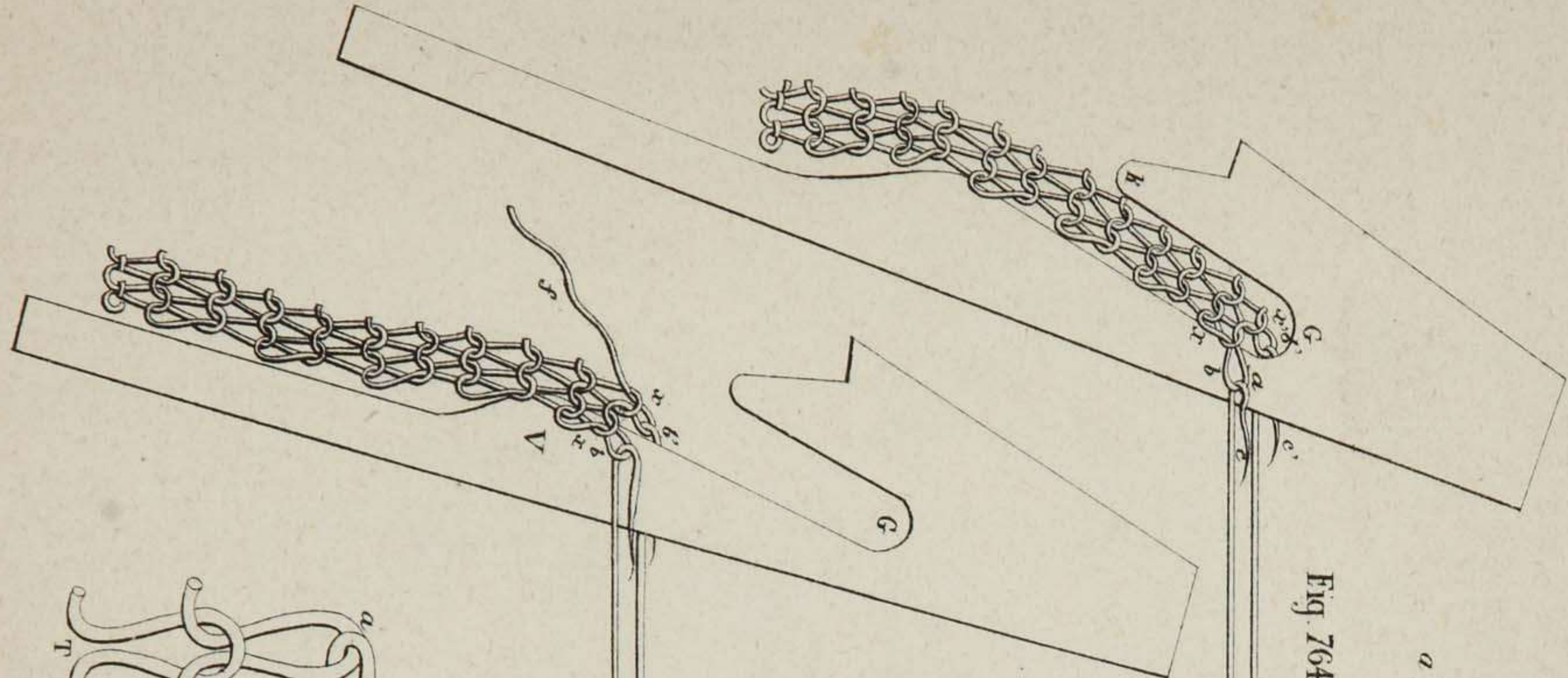


Fig. 766.



NUDO DE TEJEDOR HECHO Á MANO

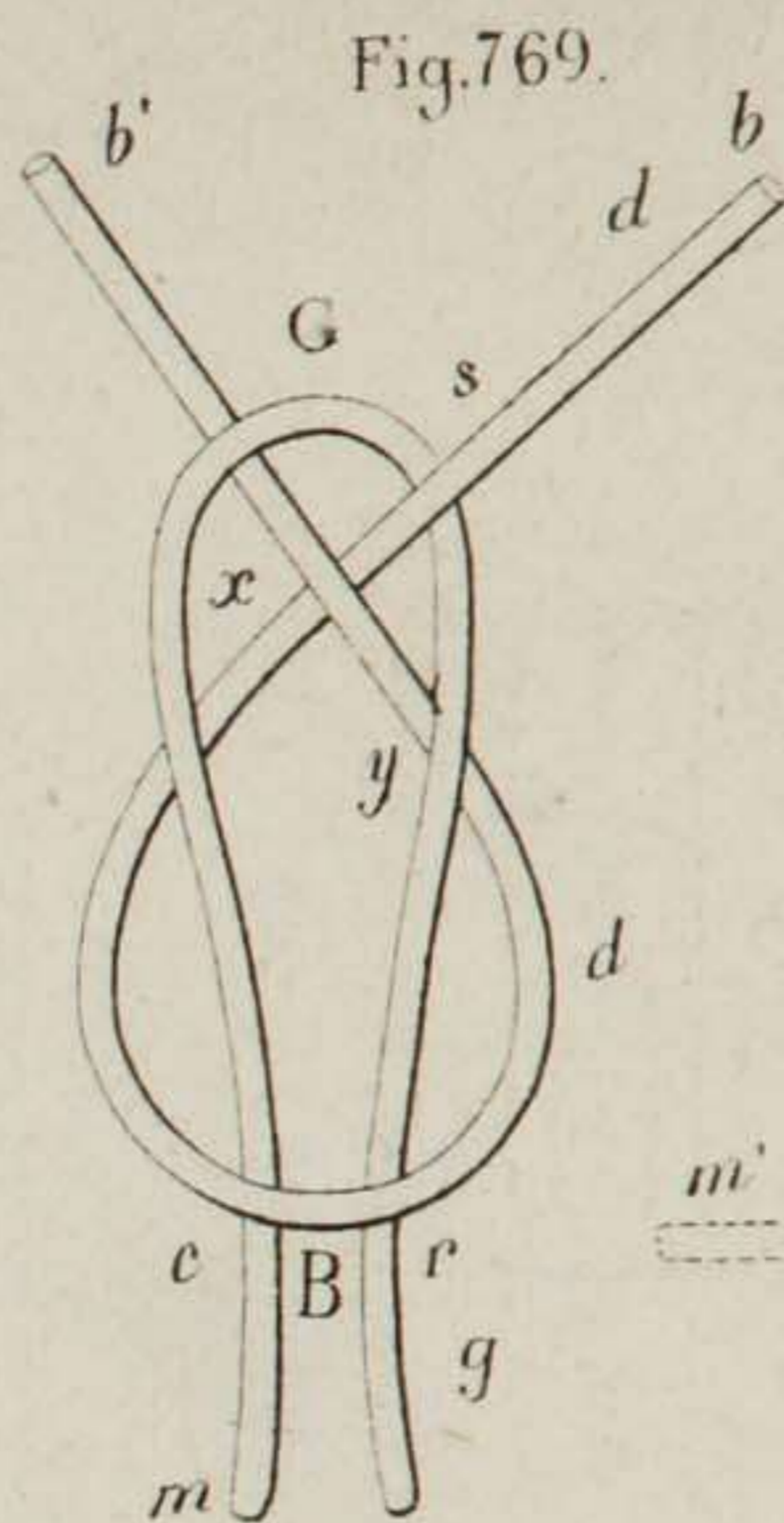
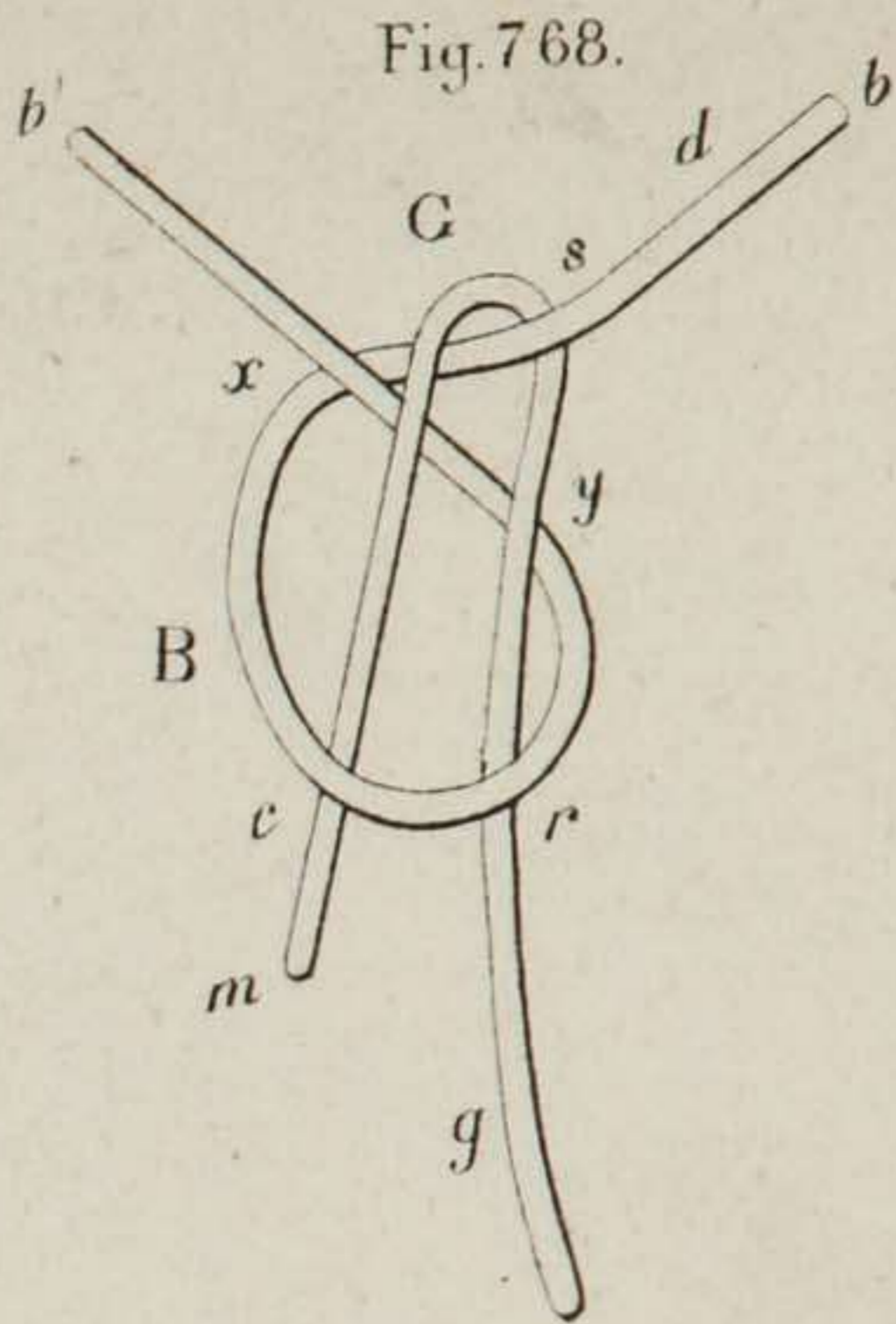
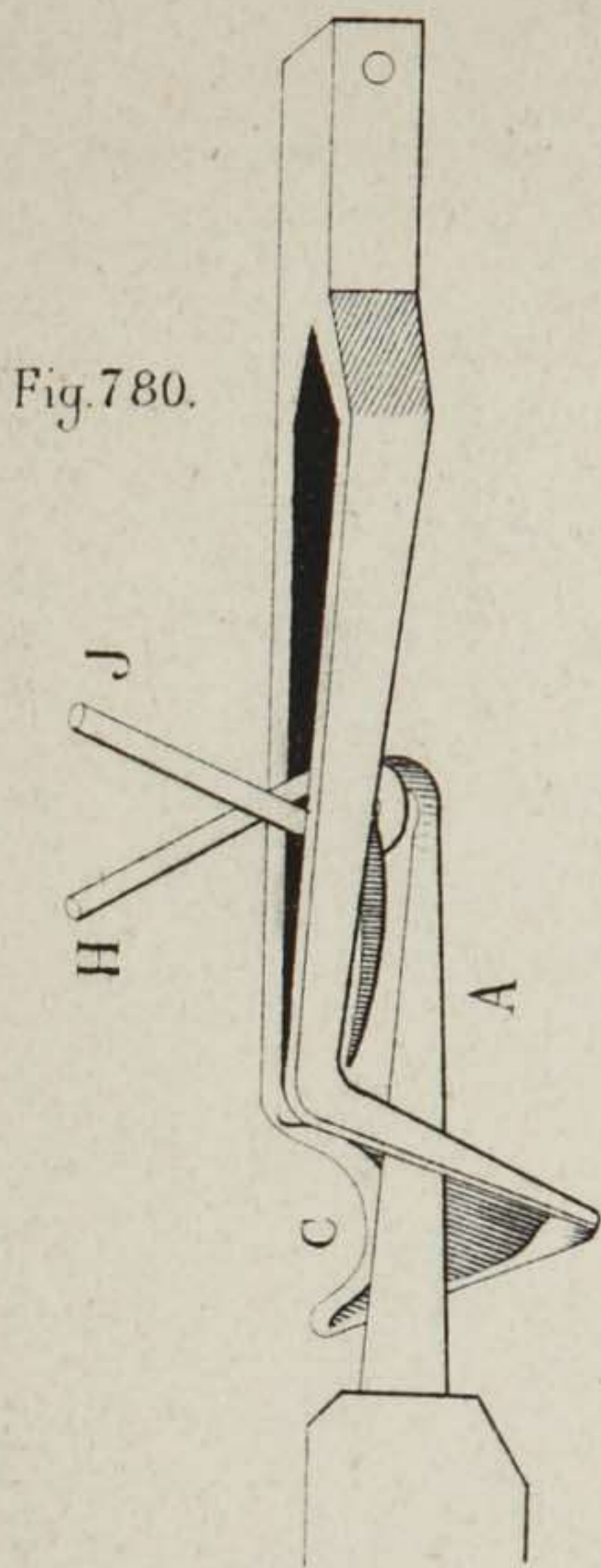
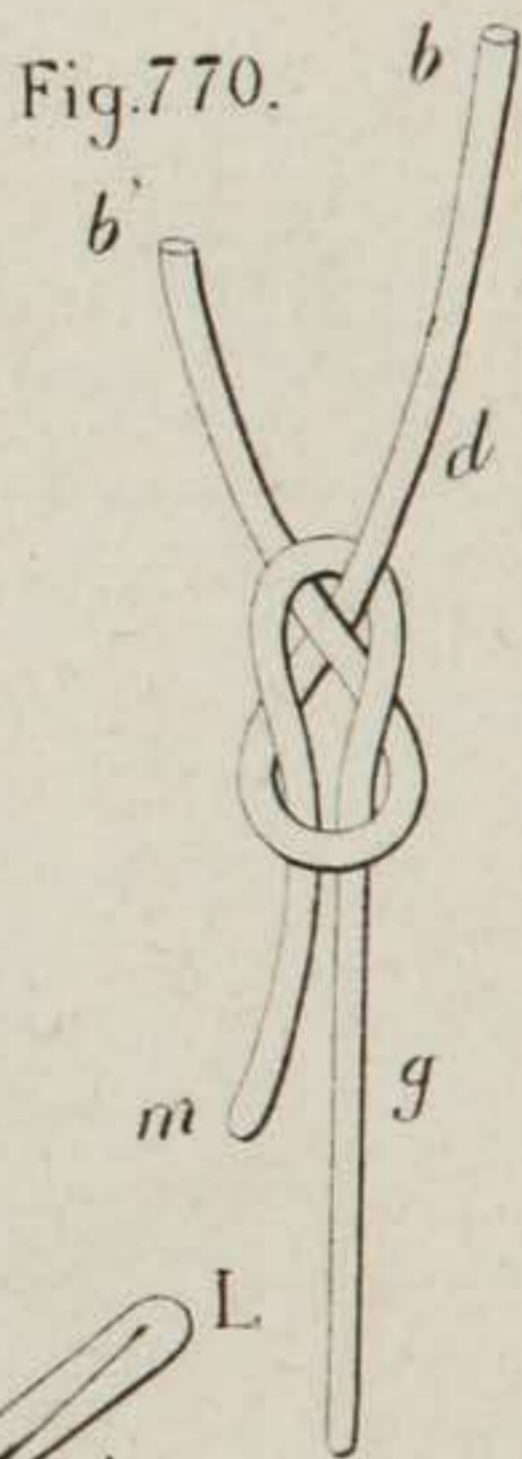
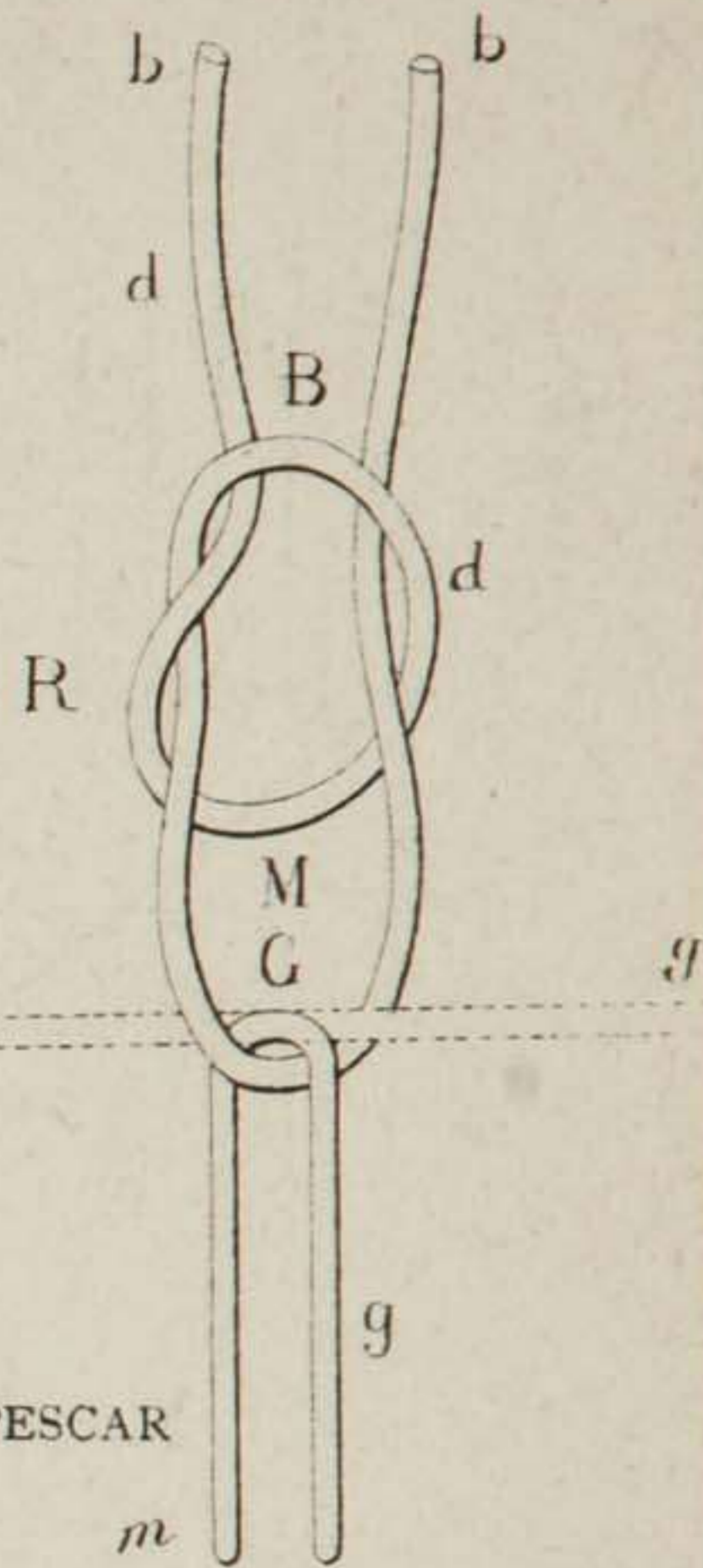


Fig. 772.

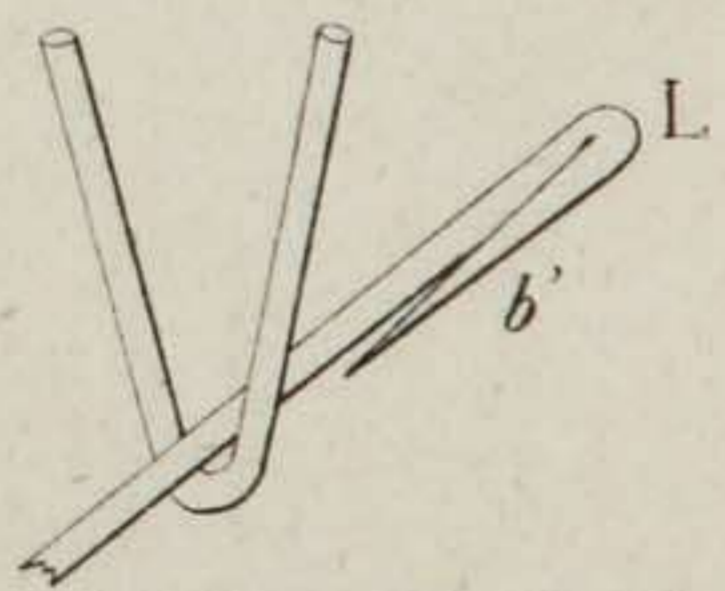


NUDO MECÁNICO DE REDES DE PESCAR

Fig. 778.



Fig. 775.



NT



NM



Fig. 776.

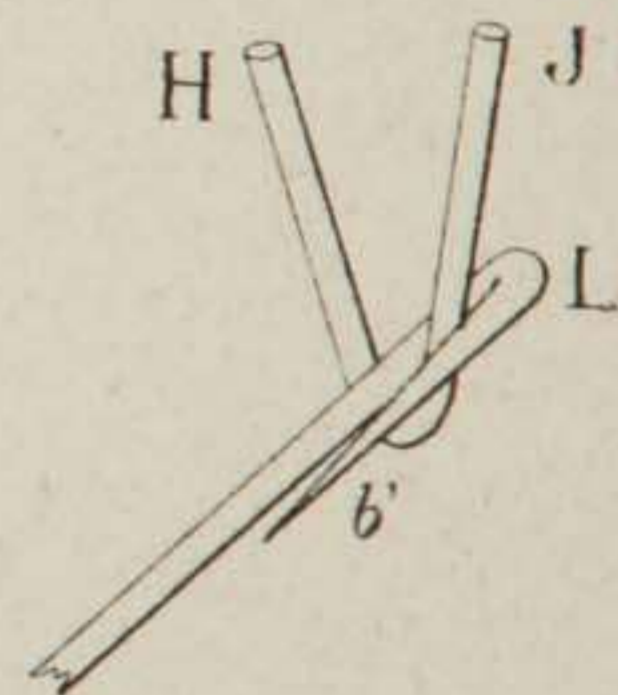


Fig. 779.

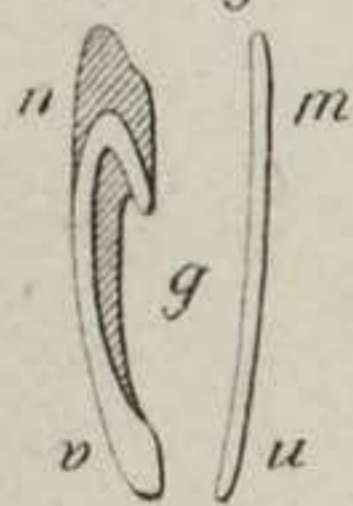


Fig. 773.

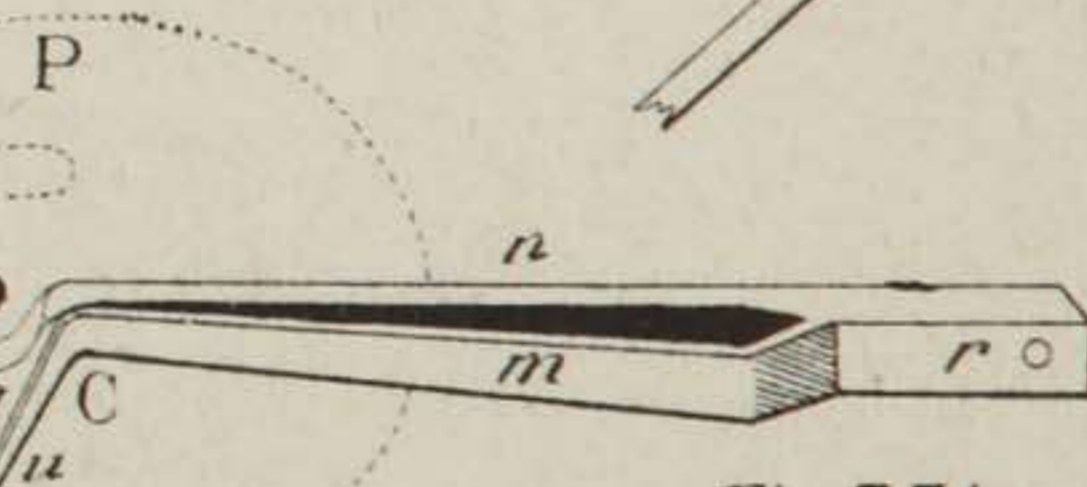
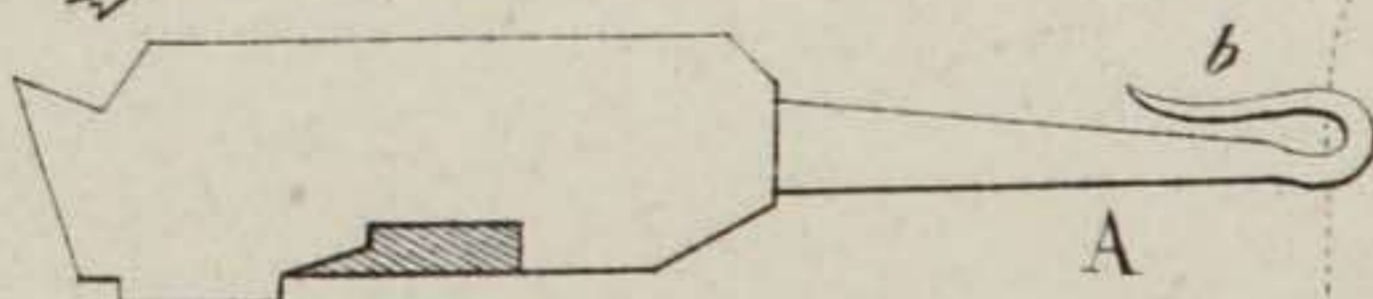


Fig. 774.

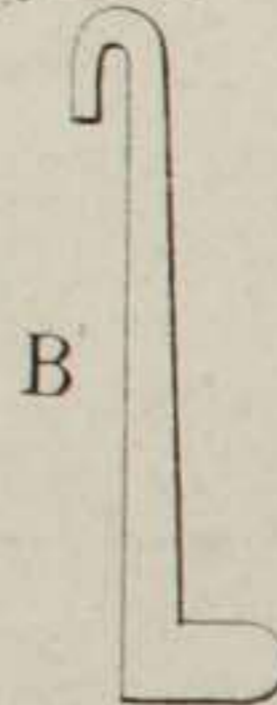
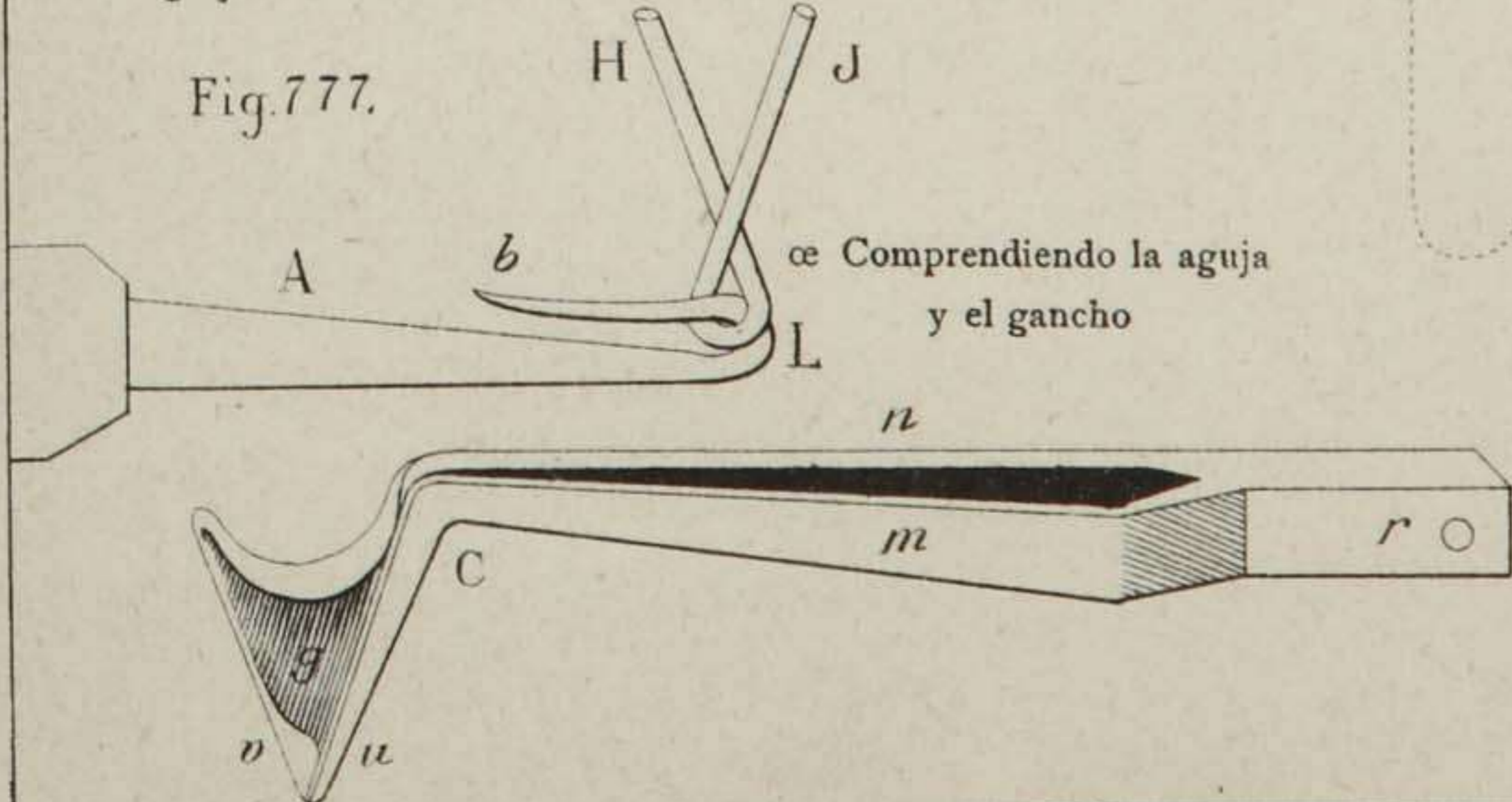


Fig. 777.



Comprendiendo la aguja y el gancho

PASAR Á ORDEN SEGUNDO
Á DOS CUERPOS

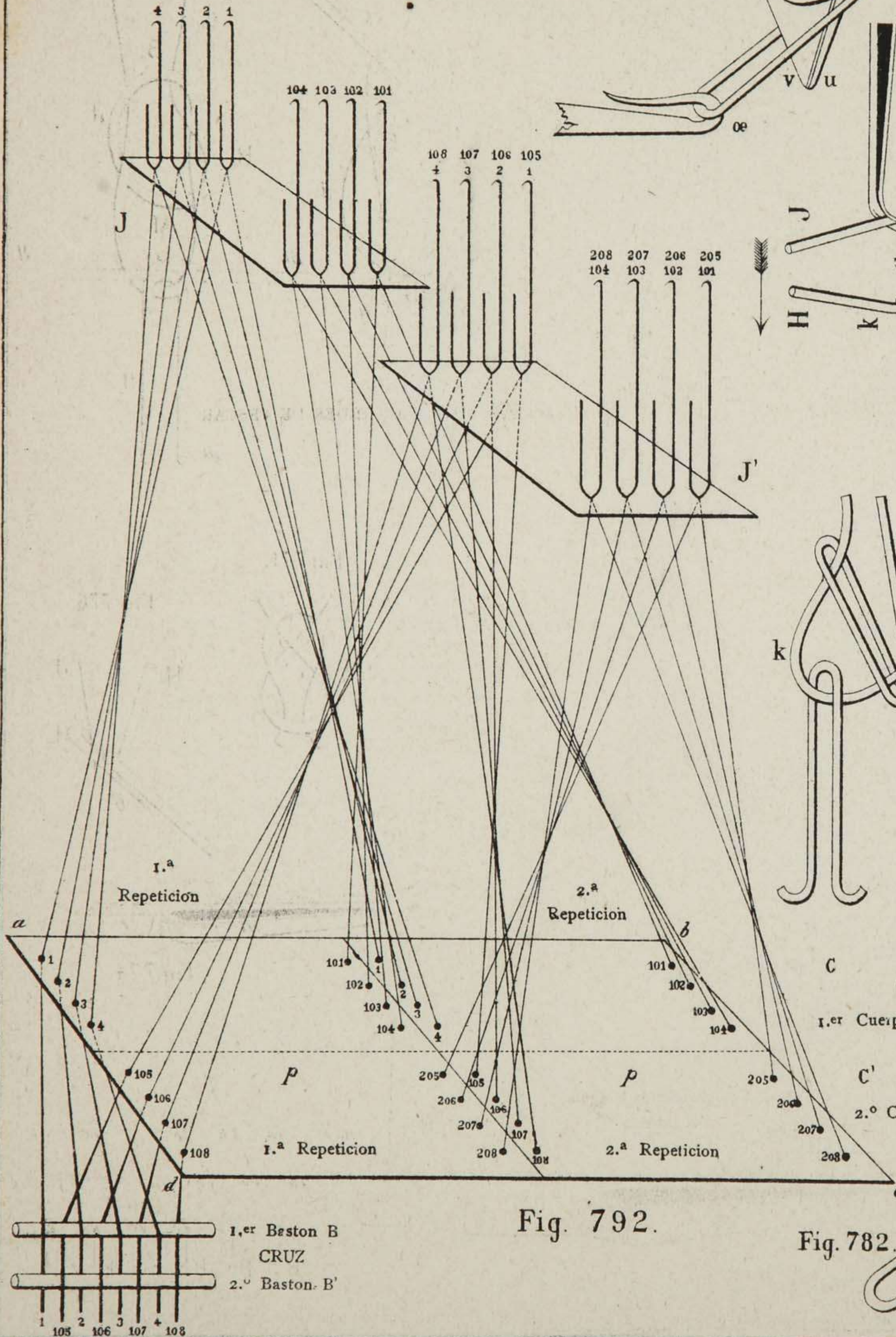


Fig. 792.

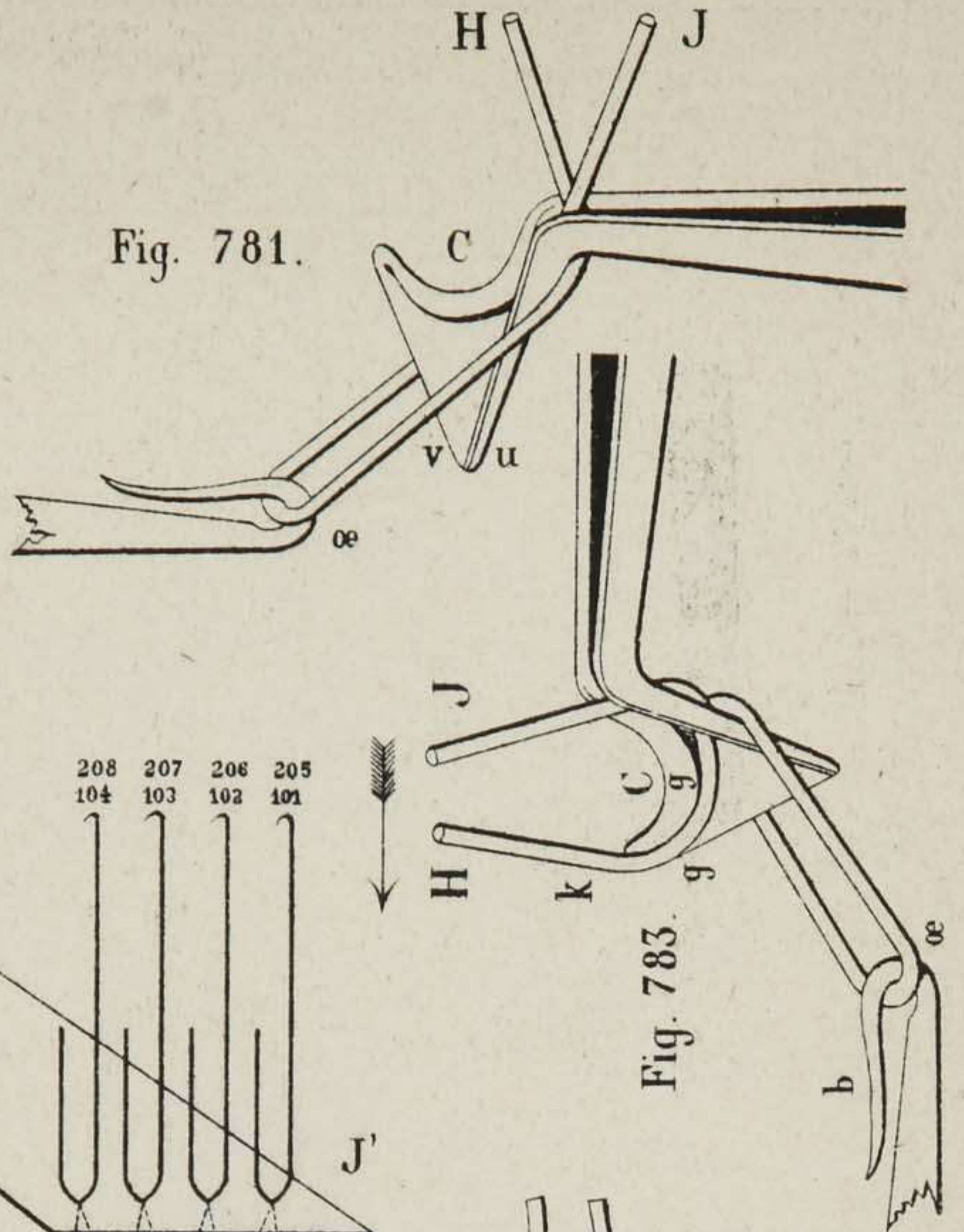


Fig. 781.

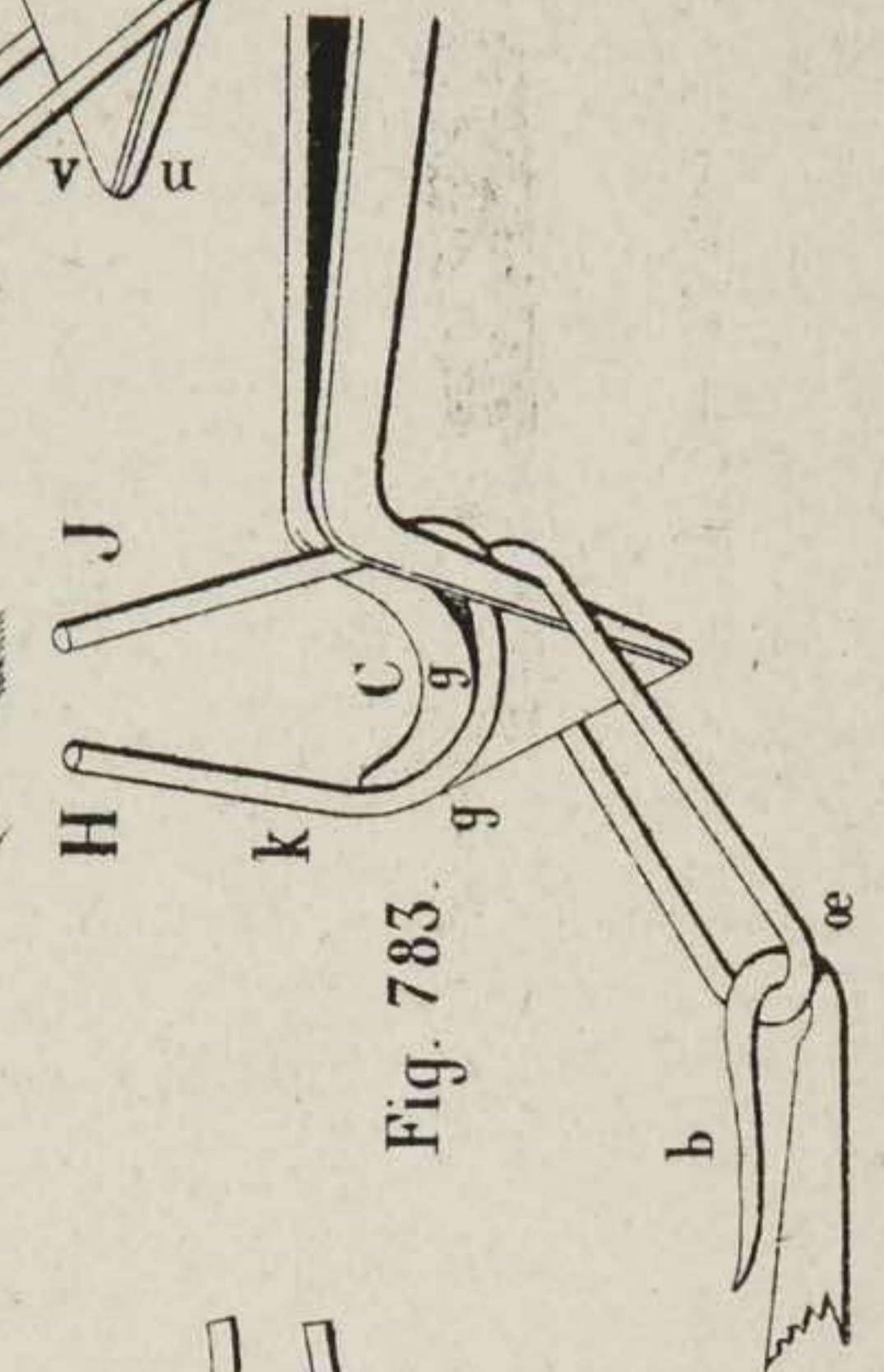


Fig. 783.

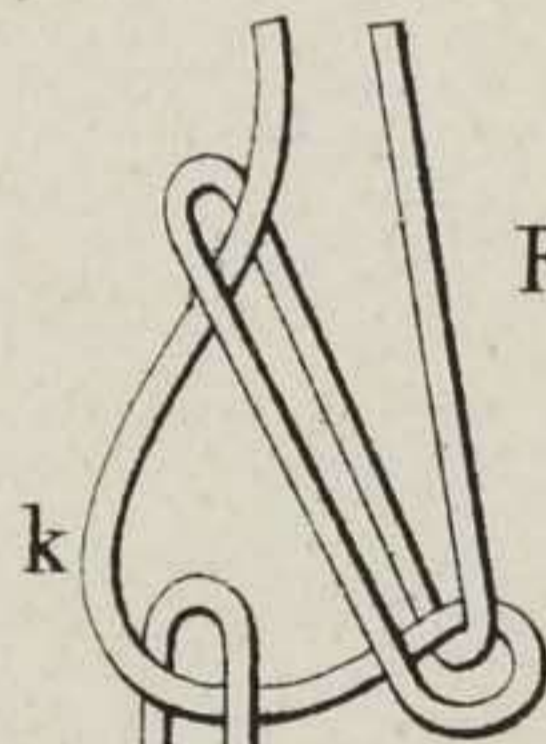


Fig. 787.

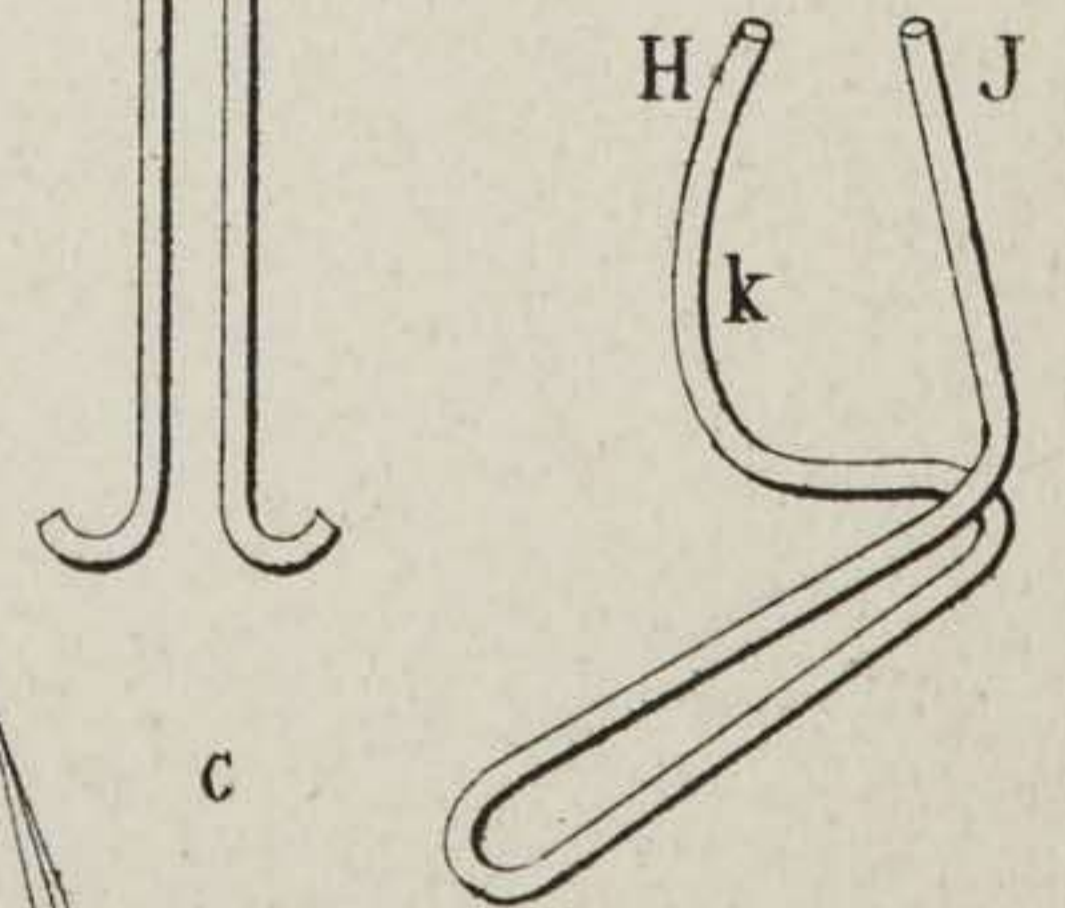


Fig. 784.

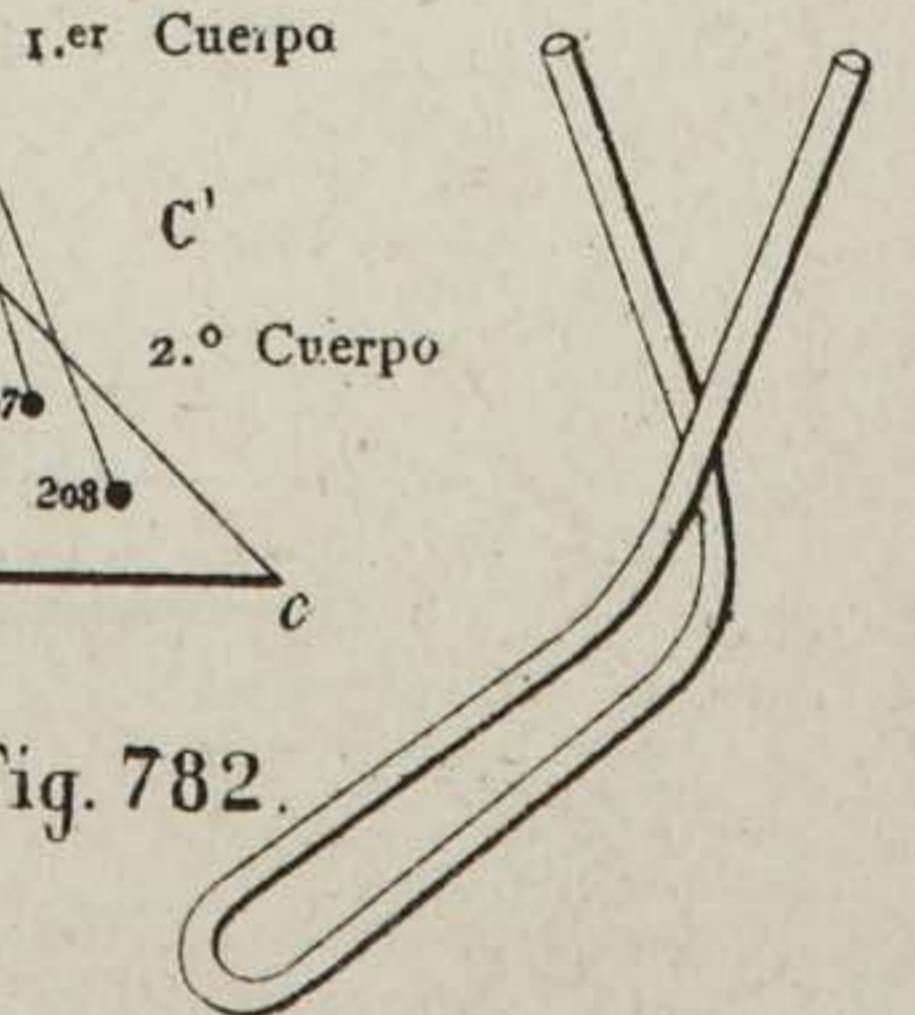
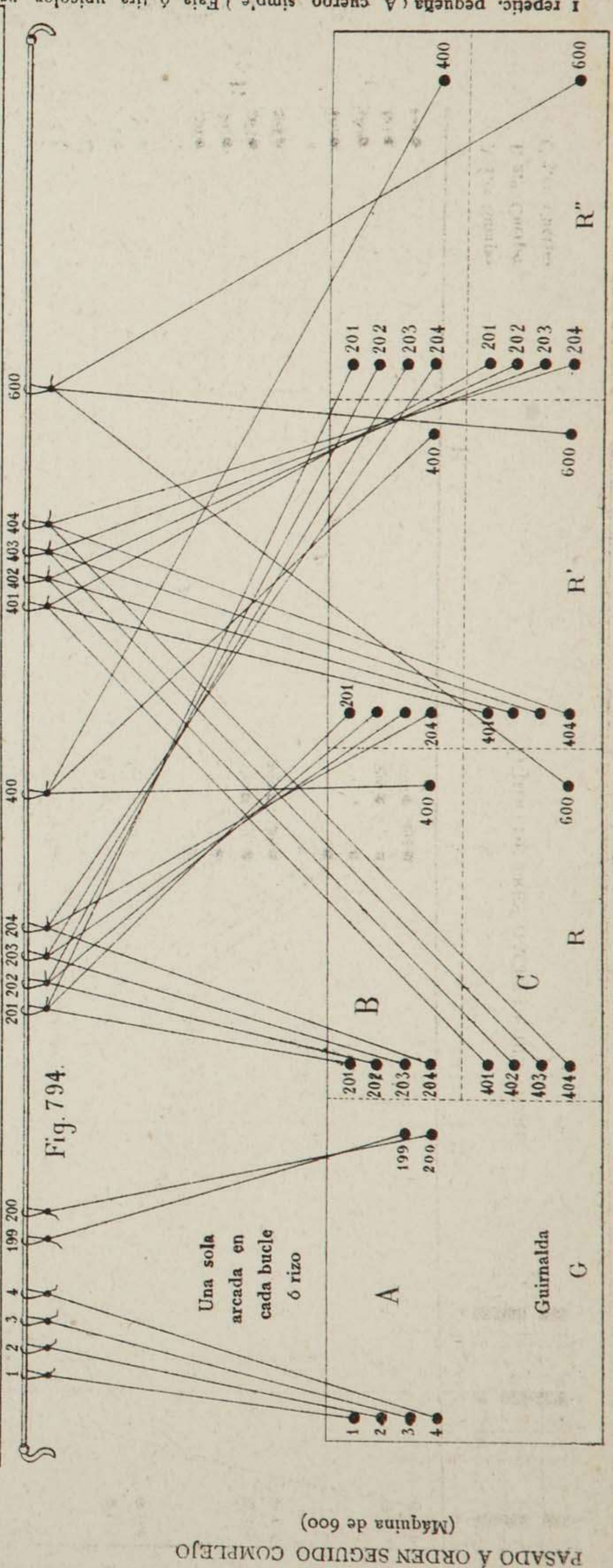
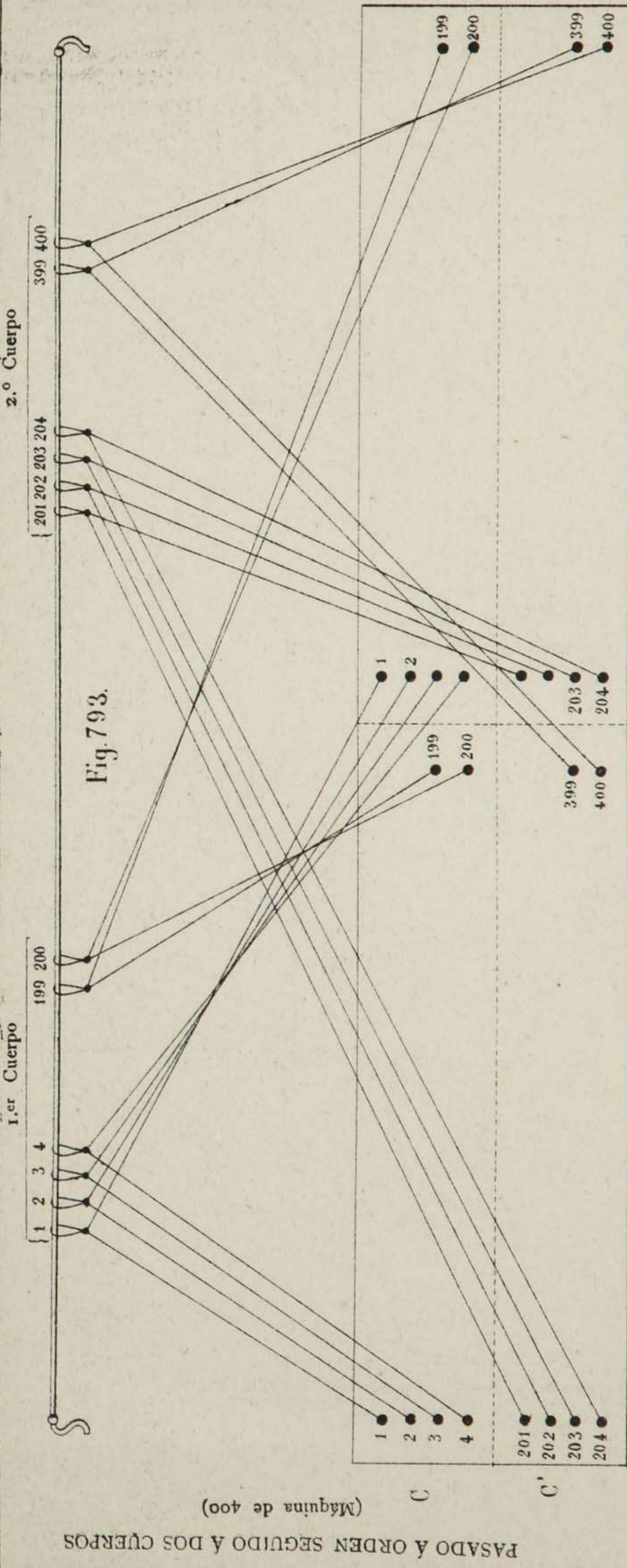


Fig. 782.



C Primer cuerpo, del 1.º gancho al 200
 C' Segundo cuerpo, del gancho 201 al 400

B primer cuerpo, Tejido de dos colores, por
 de 201 a 400
 C segundo cuerpo, Tipos separados, aspa ó
 de 401 a 600
 separados.

1 repetic. pequeña { A cuerpo simple, Faja ó tira unicolor, ur-
 de 1 a 200
 dimbre sencillo.
 G
 3 repetic. pequeñas { R R' R''
 de 201 a 400
 Tipos separados, aspa ó
 de 401 a 600
 separados.

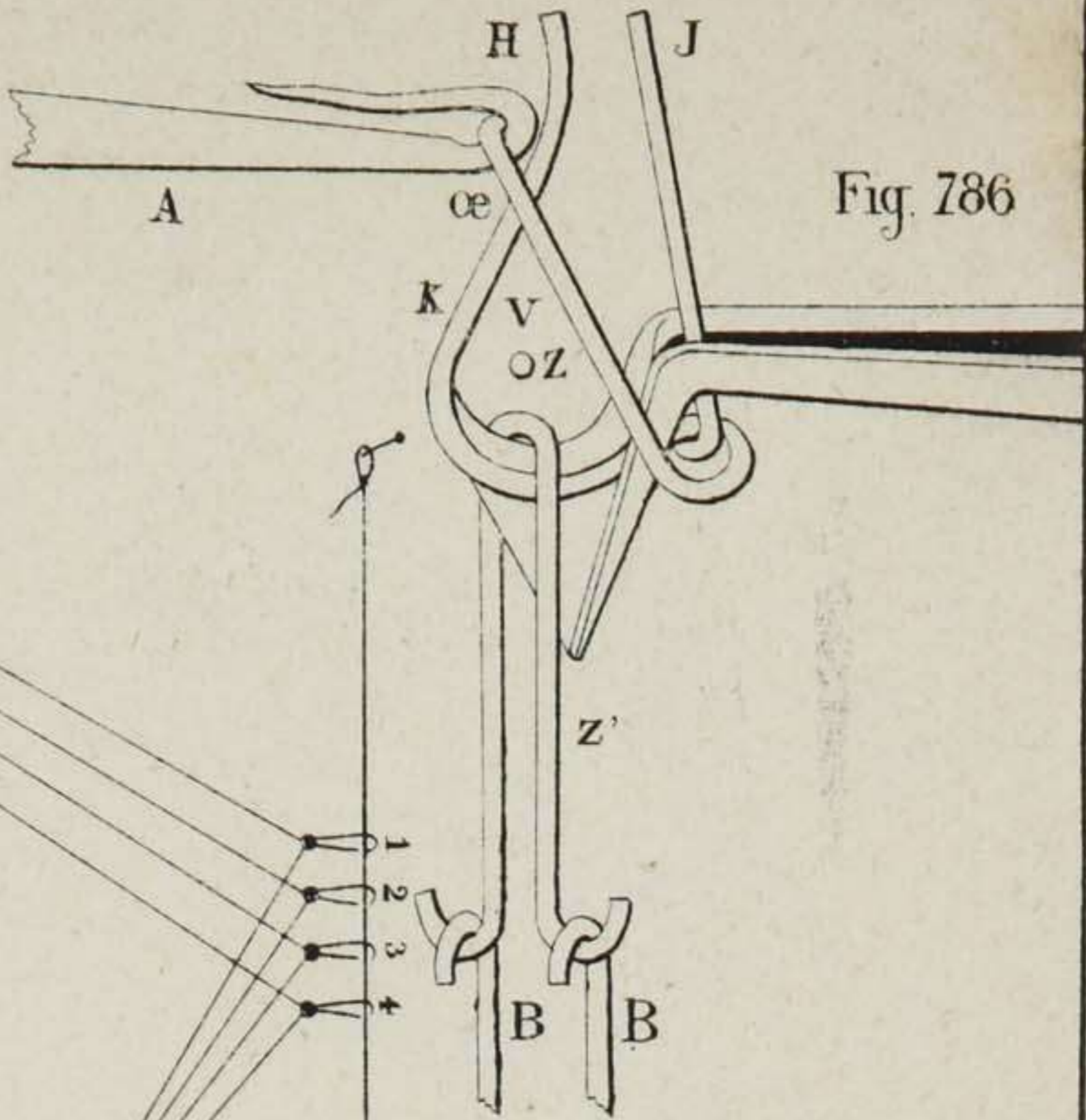


Fig. 786

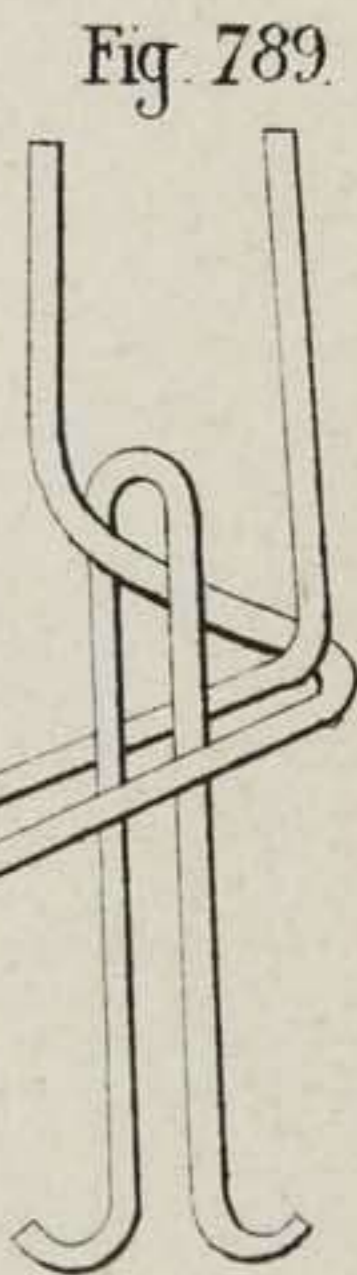


Fig. 789

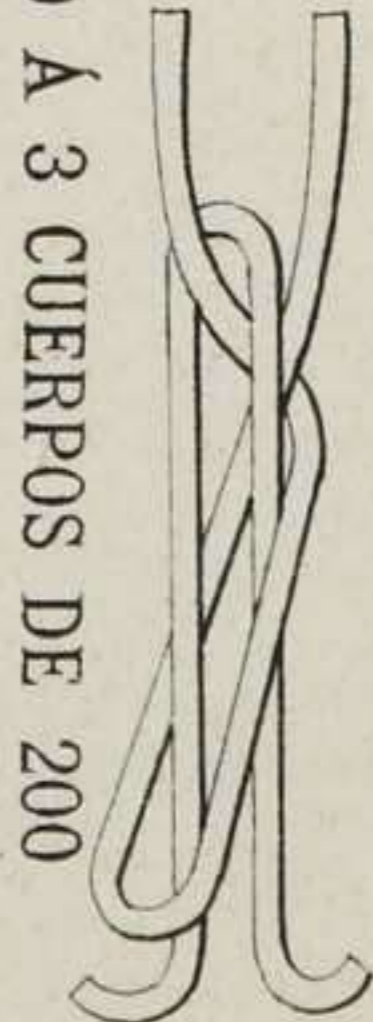


Fig. 790.

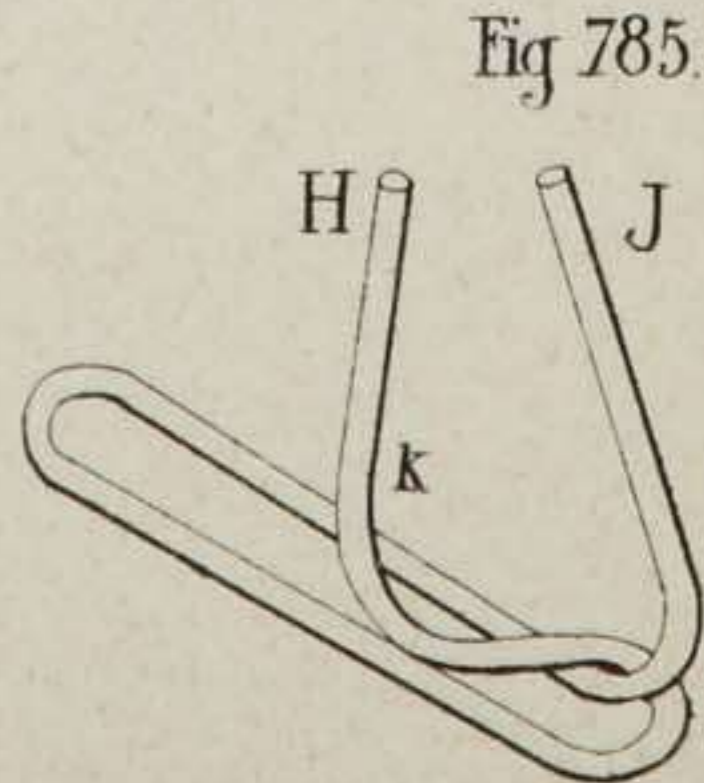


Fig. 785.

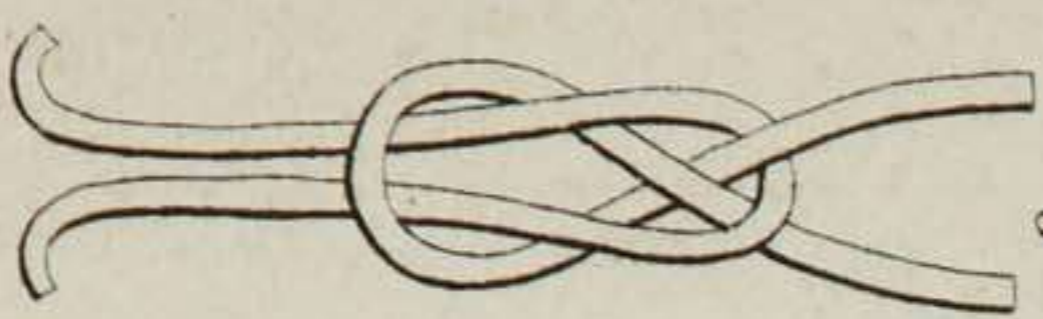
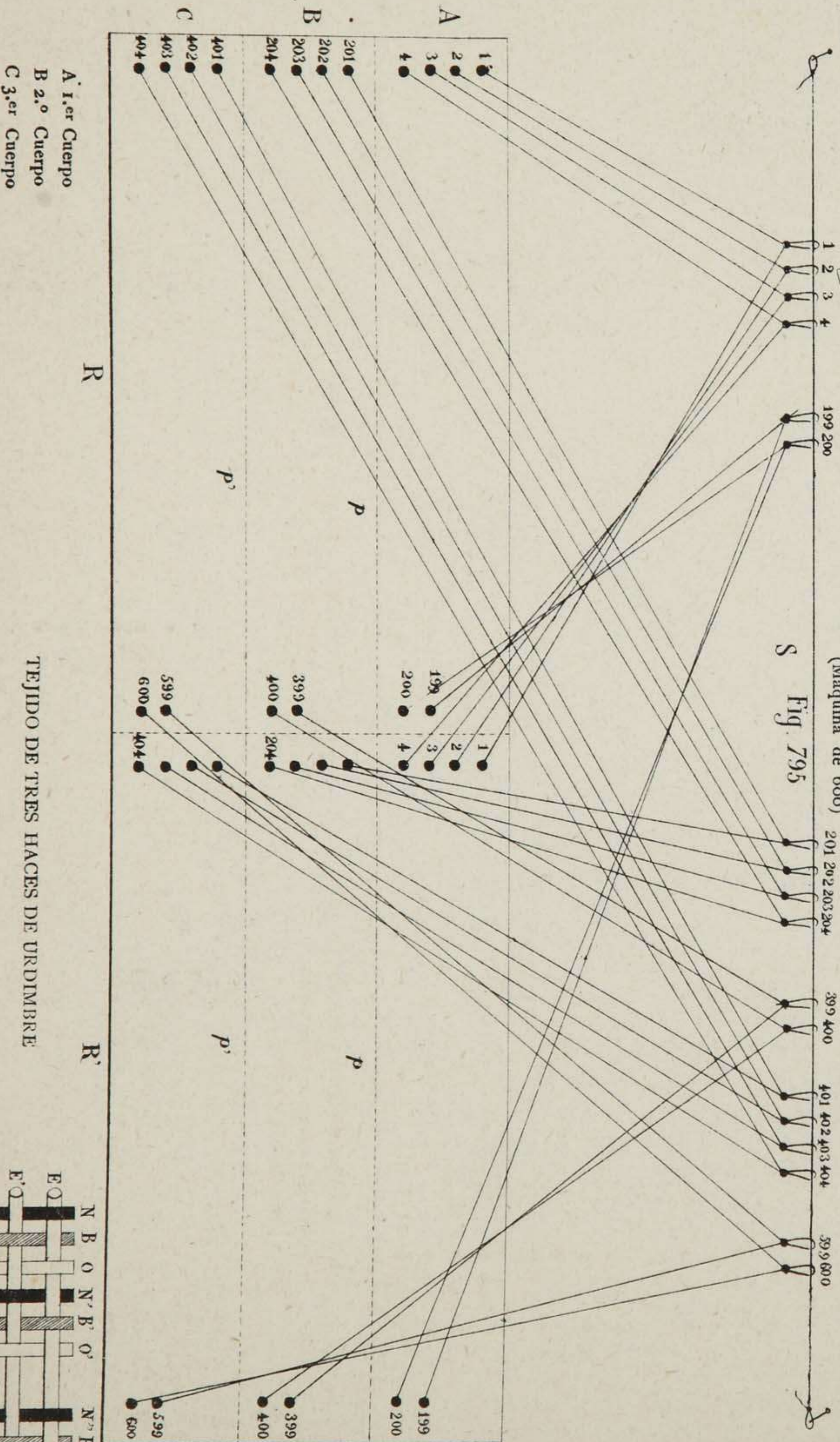


Fig. 791



TEJIDO DE TRES HACES DE URDIMBRE

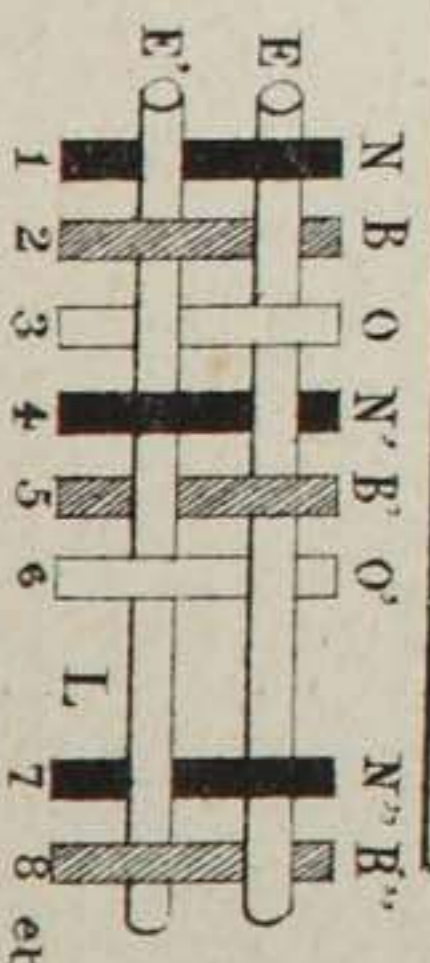
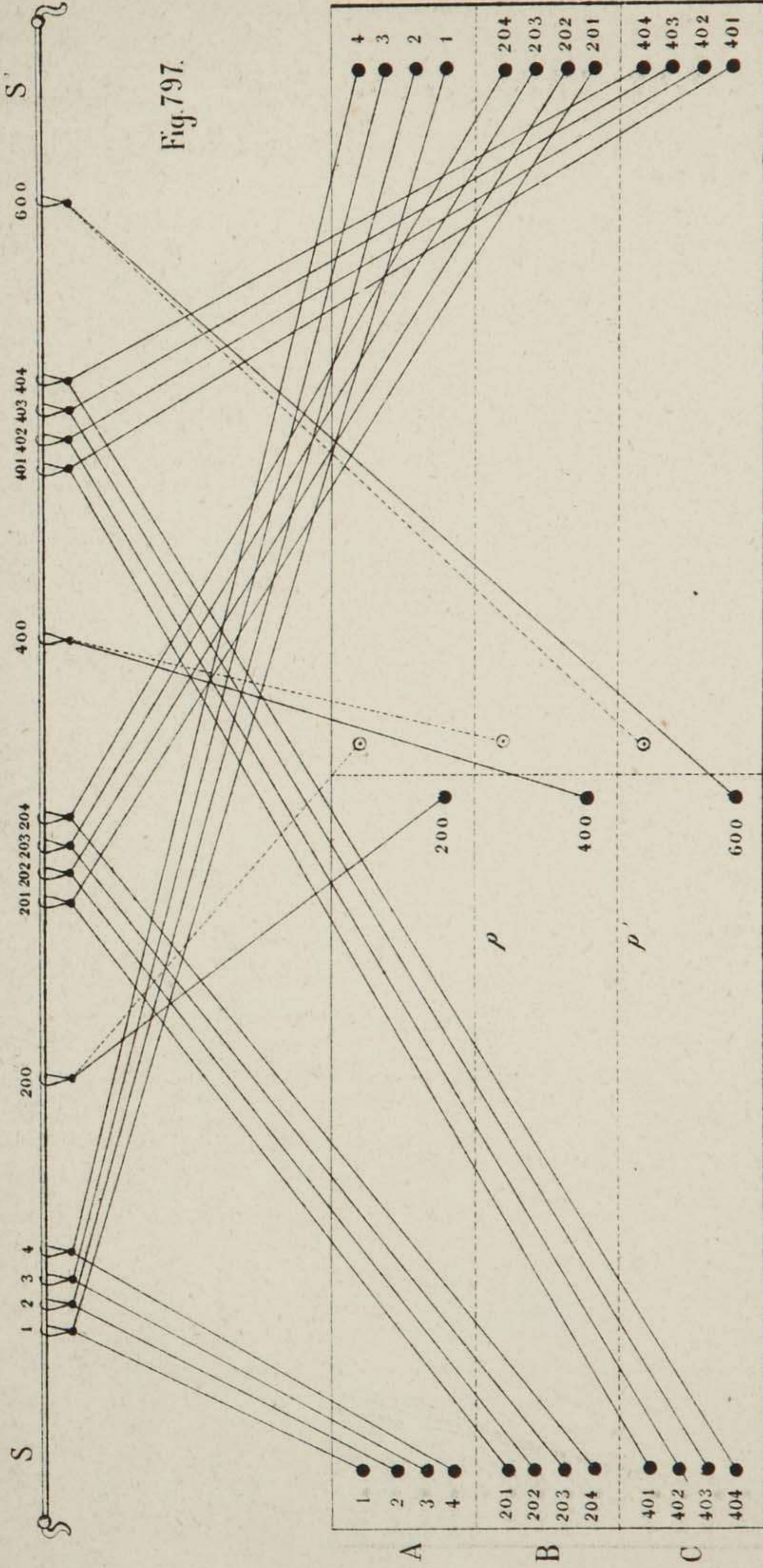


Fig. 796

PASAR Á PUNTA Á 3 CUERPOS (1.er Ejemplo)
(Máquina de 600)



NOTA: Deben eliminarse las arcadas de punto para conservar únicamente las de 1 un a (200, 400 y 600)

NOTA: Deben eliminarse las arcadas de punto para conservar únicamente las de 1 un a (200, 400 y 600)

A Primer cuerpo, de 1 á 200—1.er Urdimbre: 399 hilos
B Segundo cuerpo, de 201 á 400—2.º Urdimbre: 399 " } 3 haces.
C Tercer cuerpo, de 401 á 600—3.er Urdimbre: 399 "

Fig. 811.

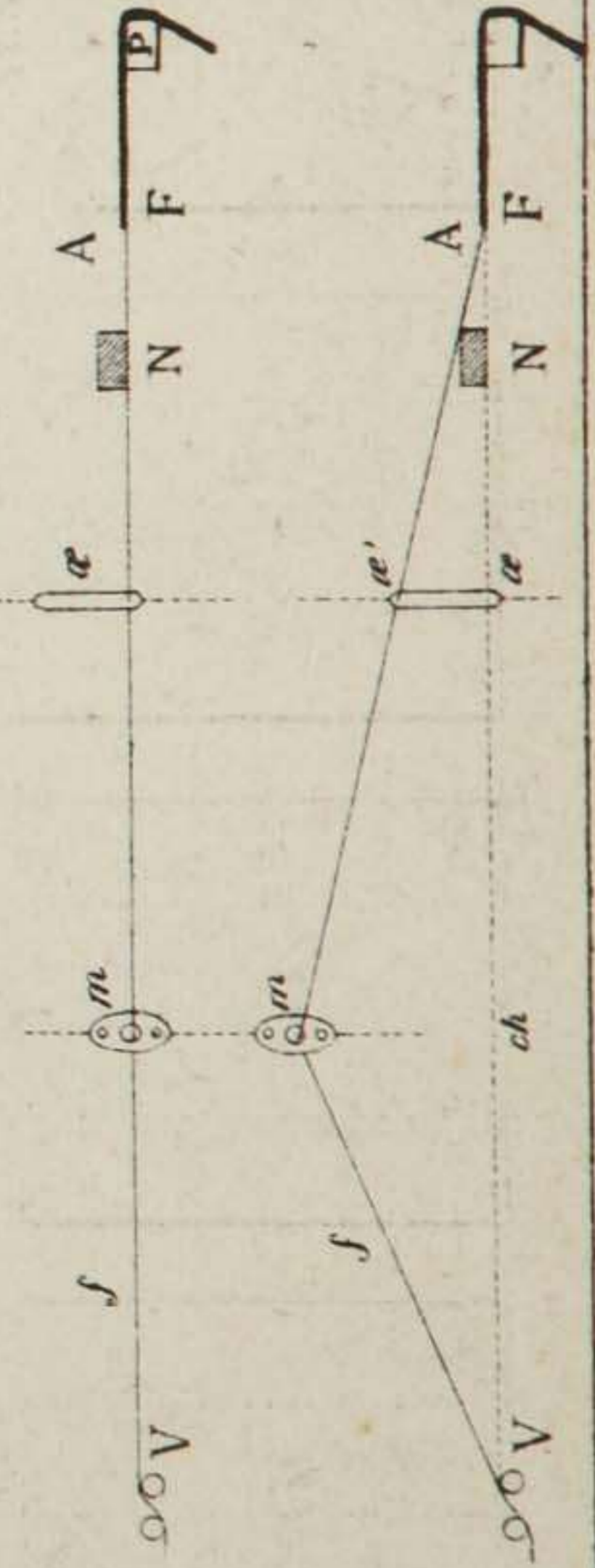


Fig. 812.

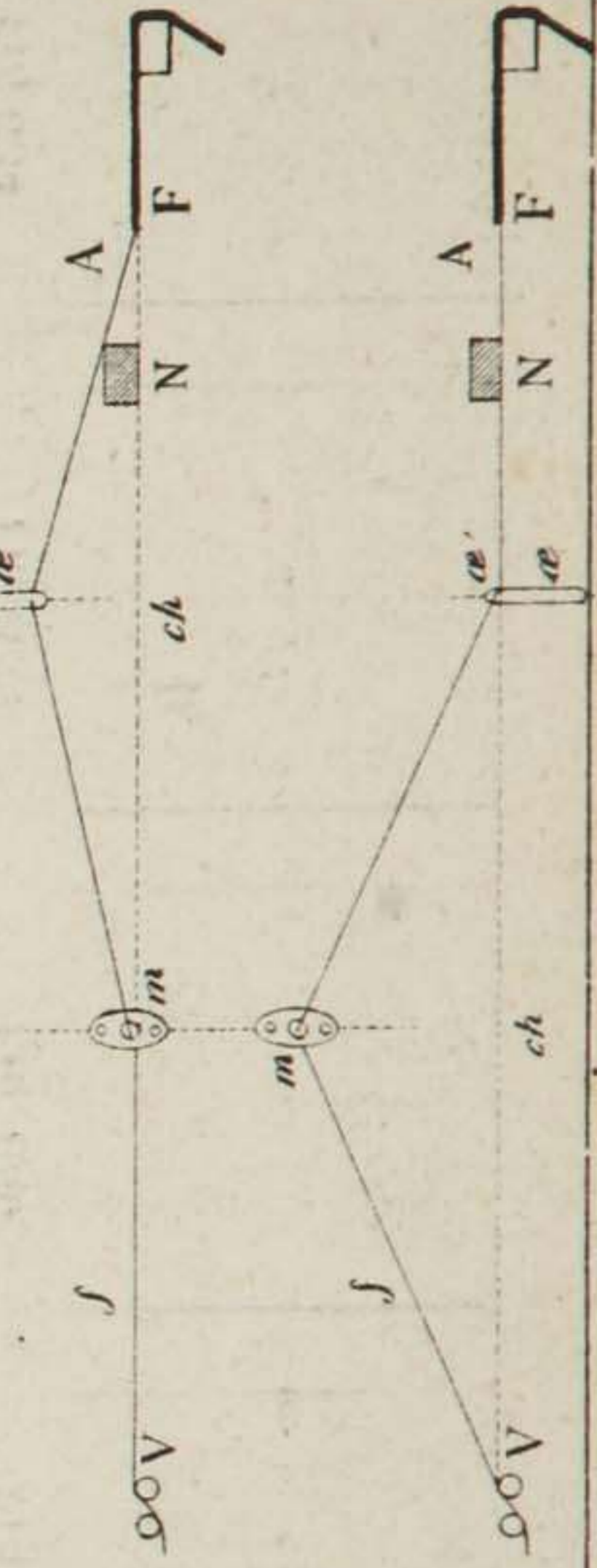


Fig. 813.

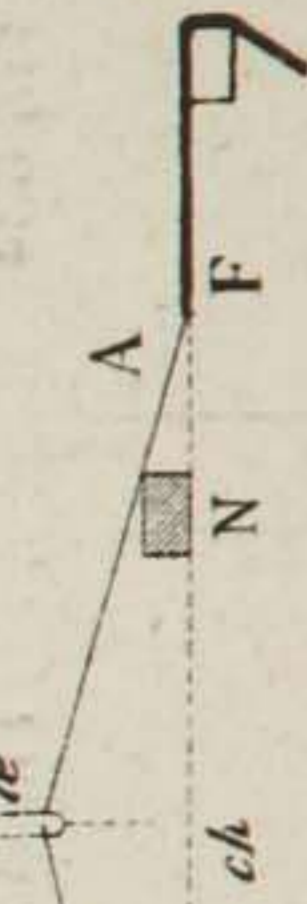


Fig. 814.



PASAR Á PUNTOS Á 3 CUERPOS (2.º Ejemplo)
(Máquina de 600)

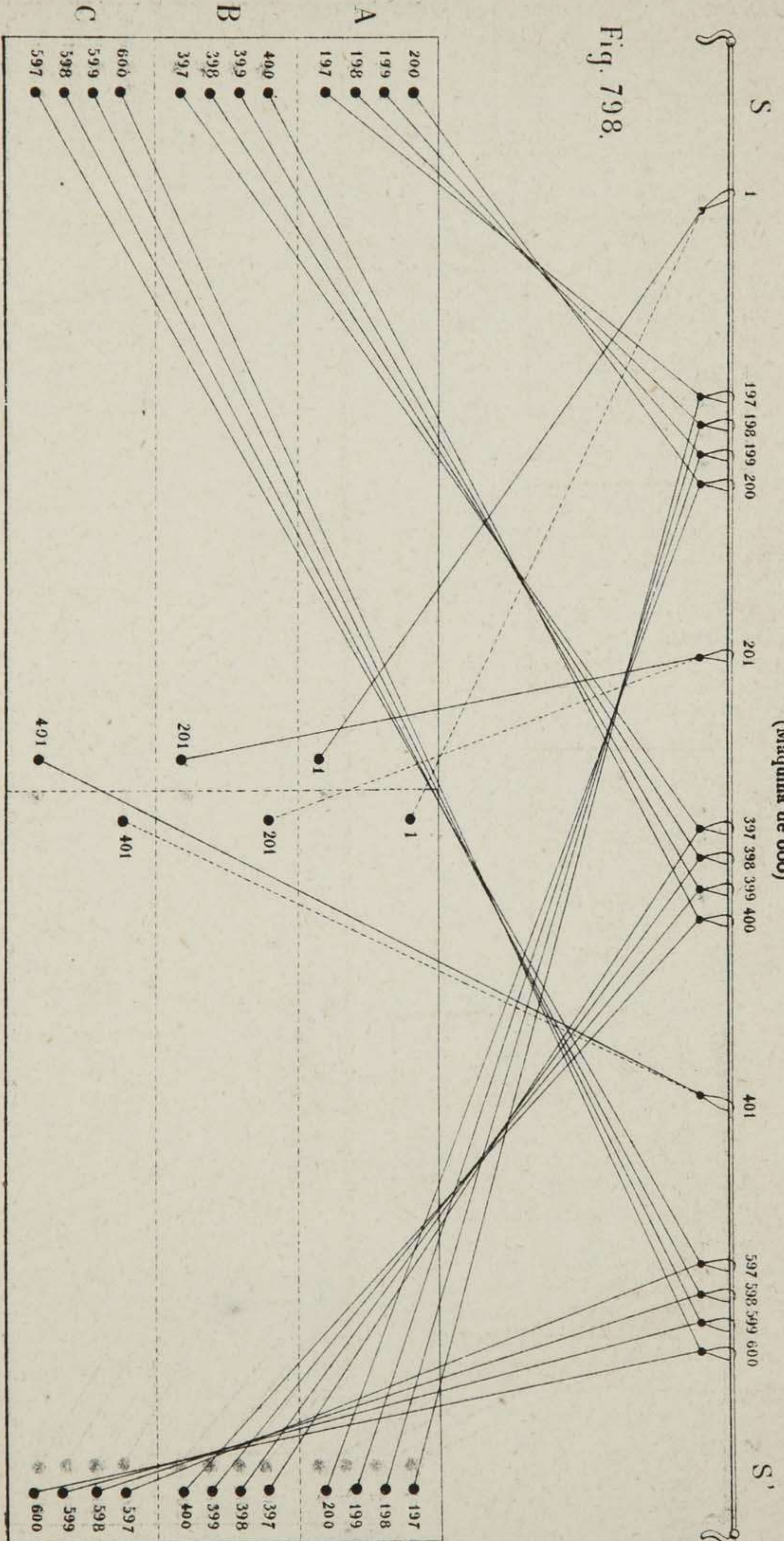


Fig. 798.

A Primer cuerpo, de 200 á 1.—1.º Urdimbre: 399 hilos
 B Segundo cuerpo, de 400 á 201.—2.º Urdimbre: 399 " } 3 haces.
 C Tercer cuerpo, de 600 á 401.—3.º Urdimbre: 399 "

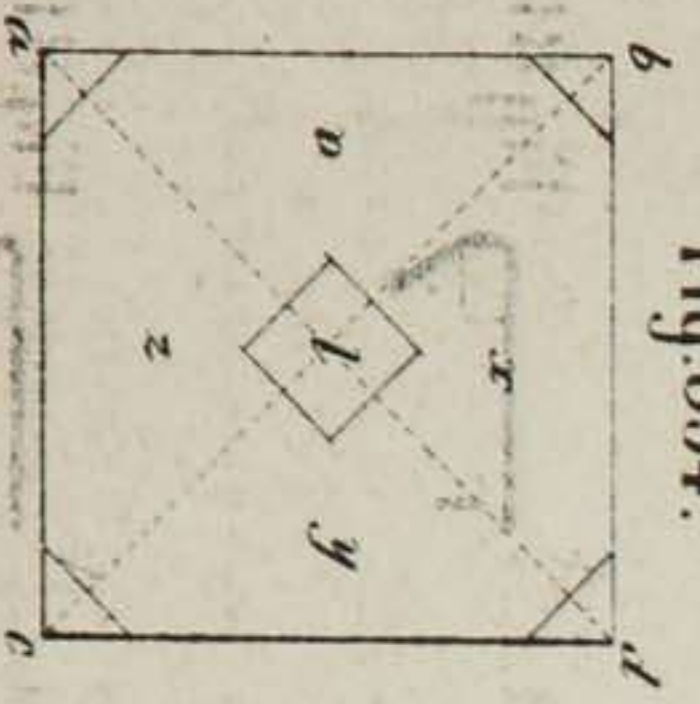


Fig. 834.

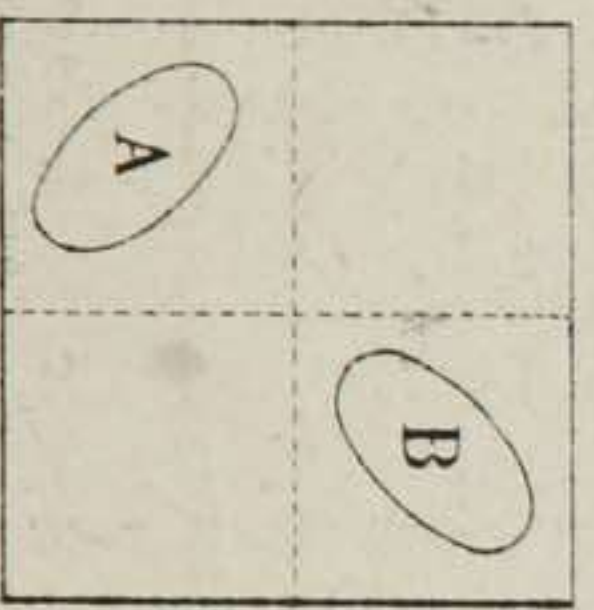


Fig. 835.

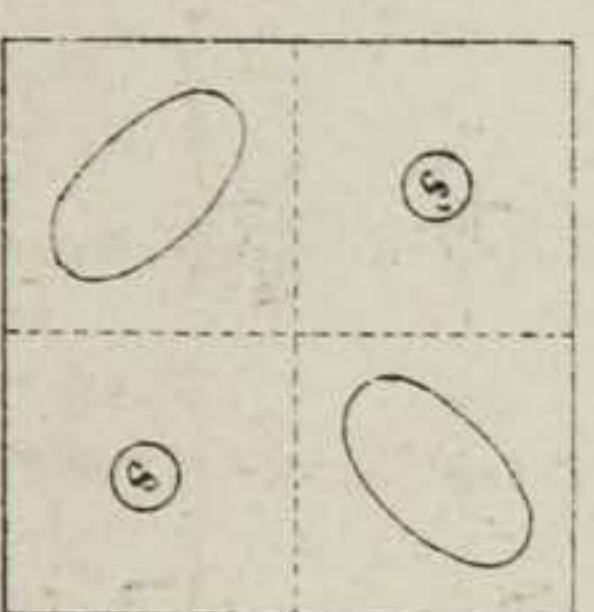


Fig. 836.

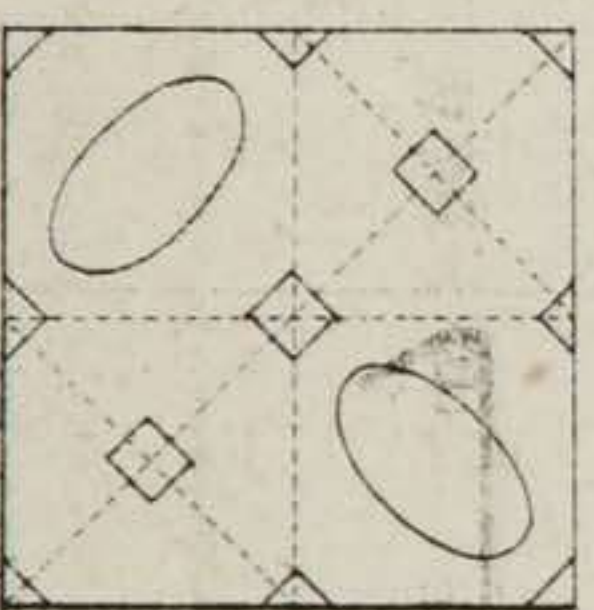


Fig. 837.

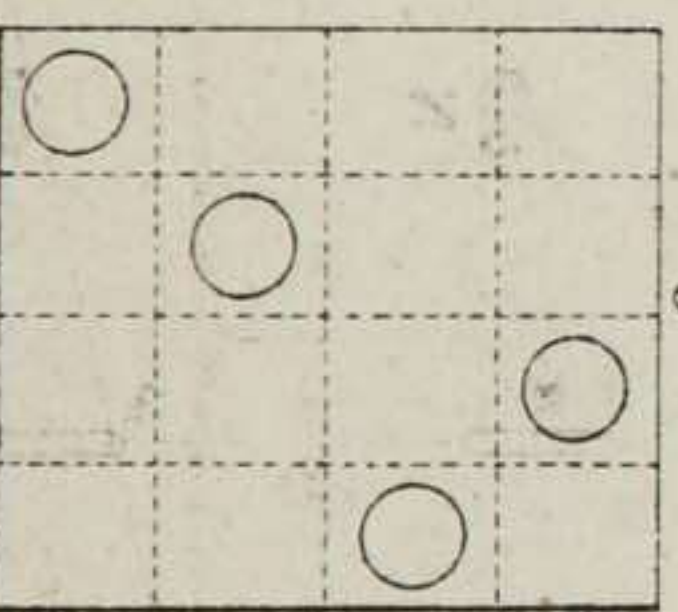


Fig. 838.

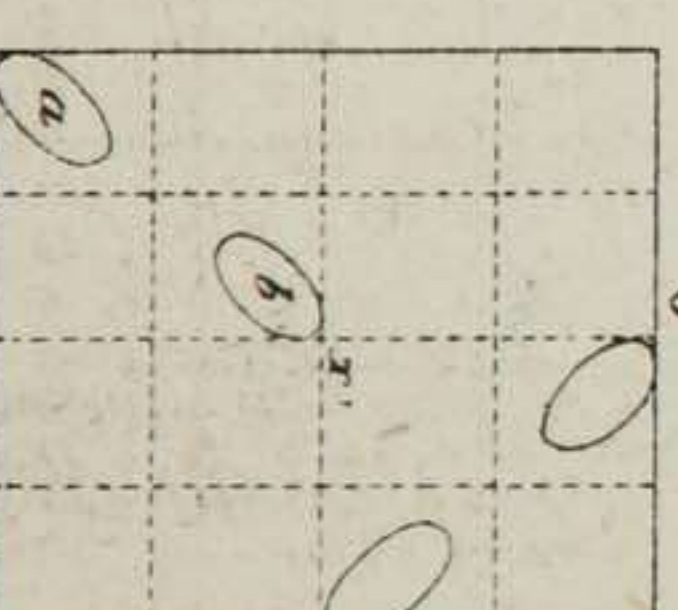


Fig. 839.

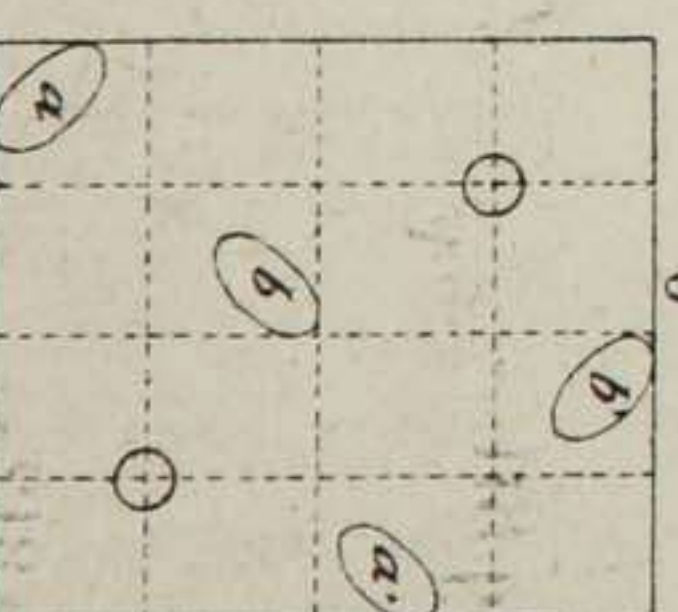


Fig. 840.

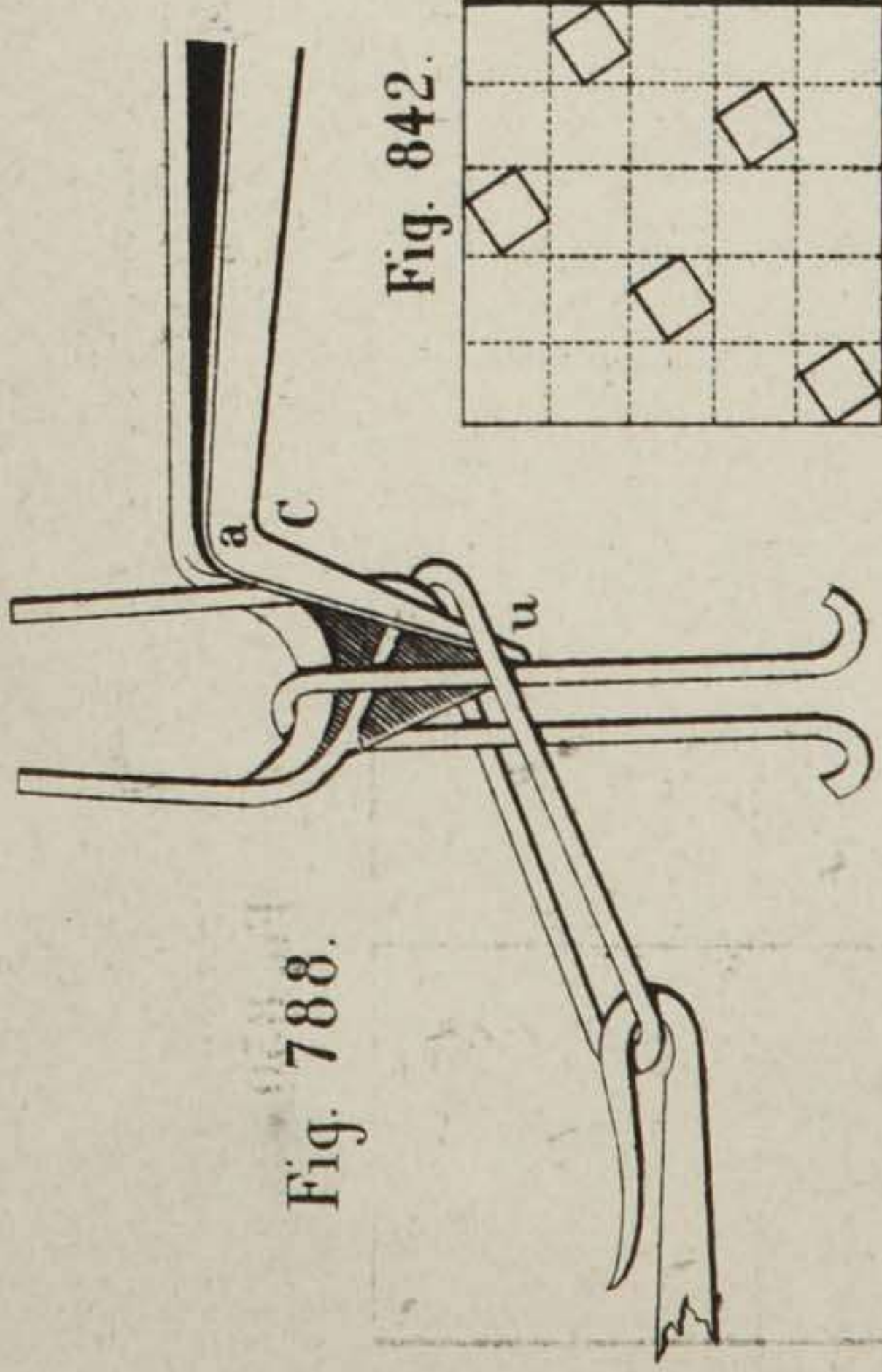


Fig. 843.

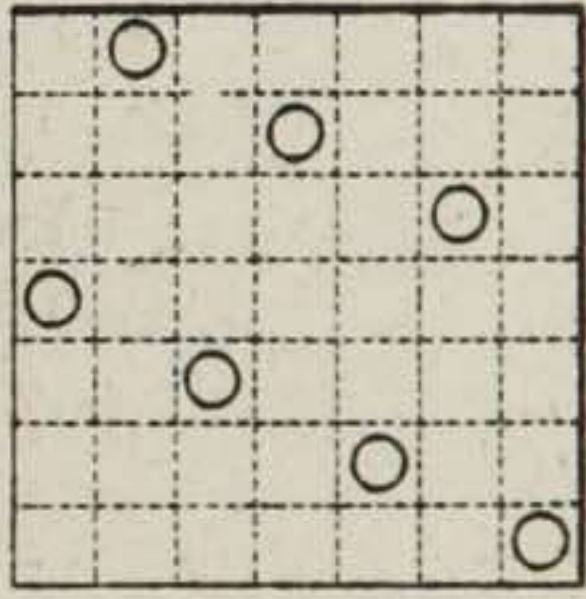


Fig. 844.

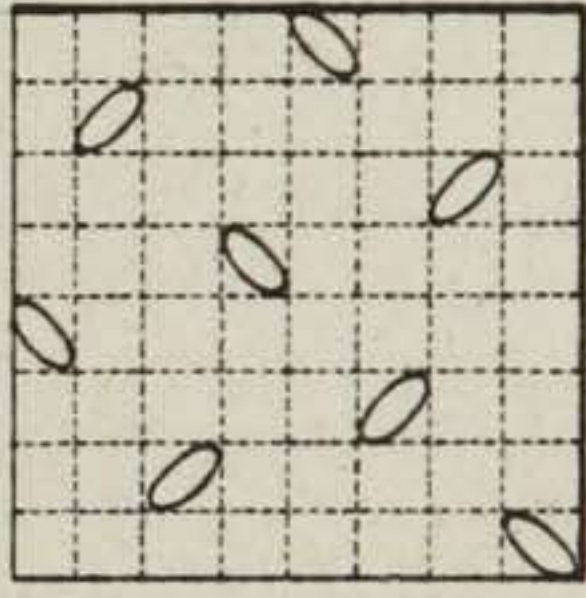


Fig. 845.

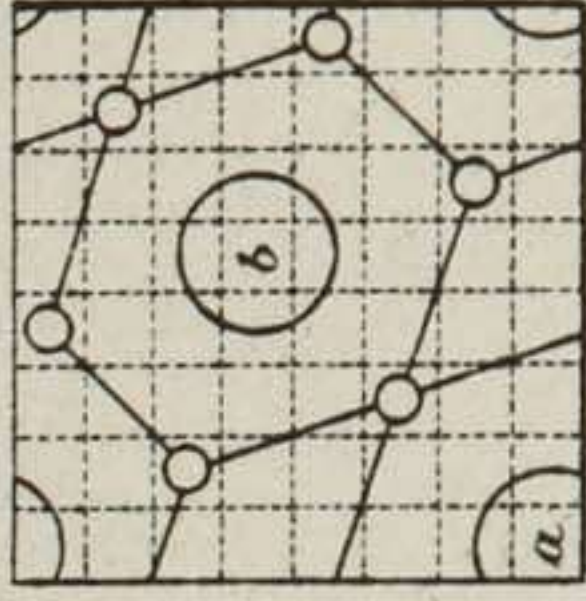


Fig. 841.

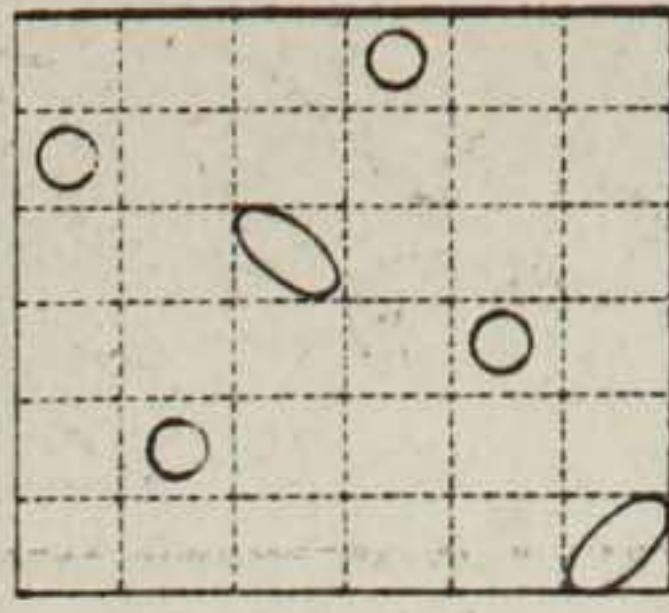


Fig. 842.

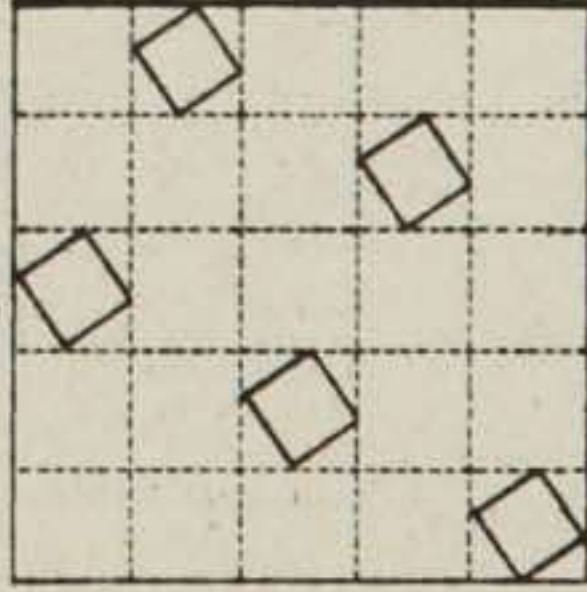


Fig. 846.

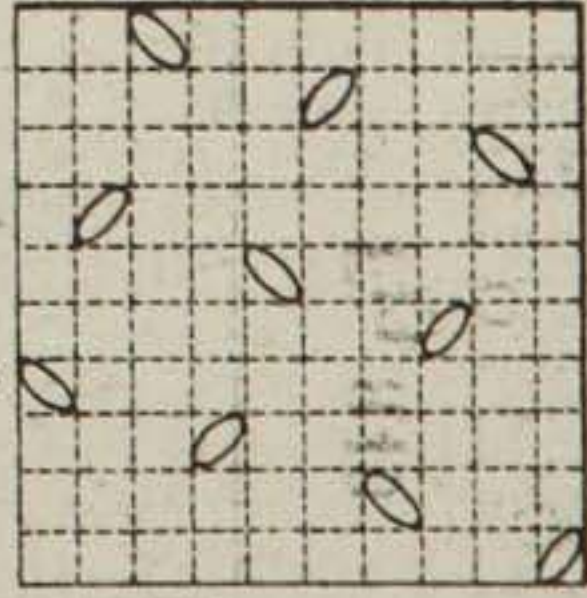


Fig. 847.

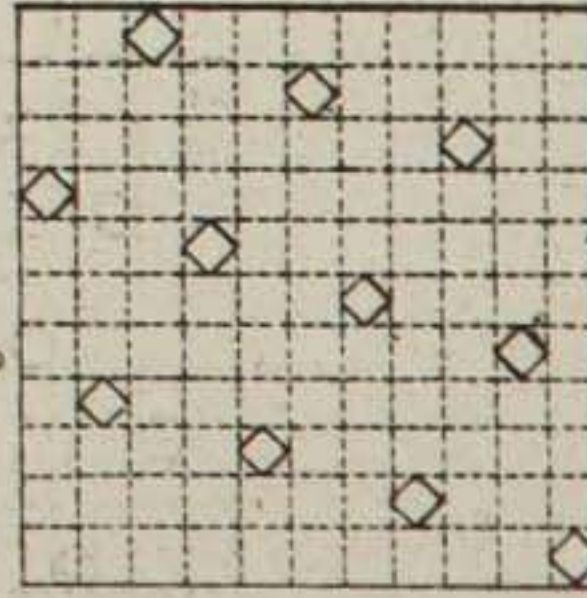
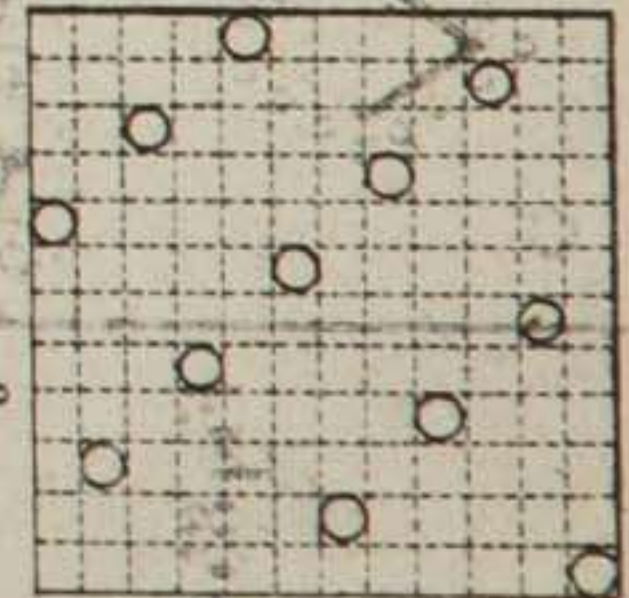
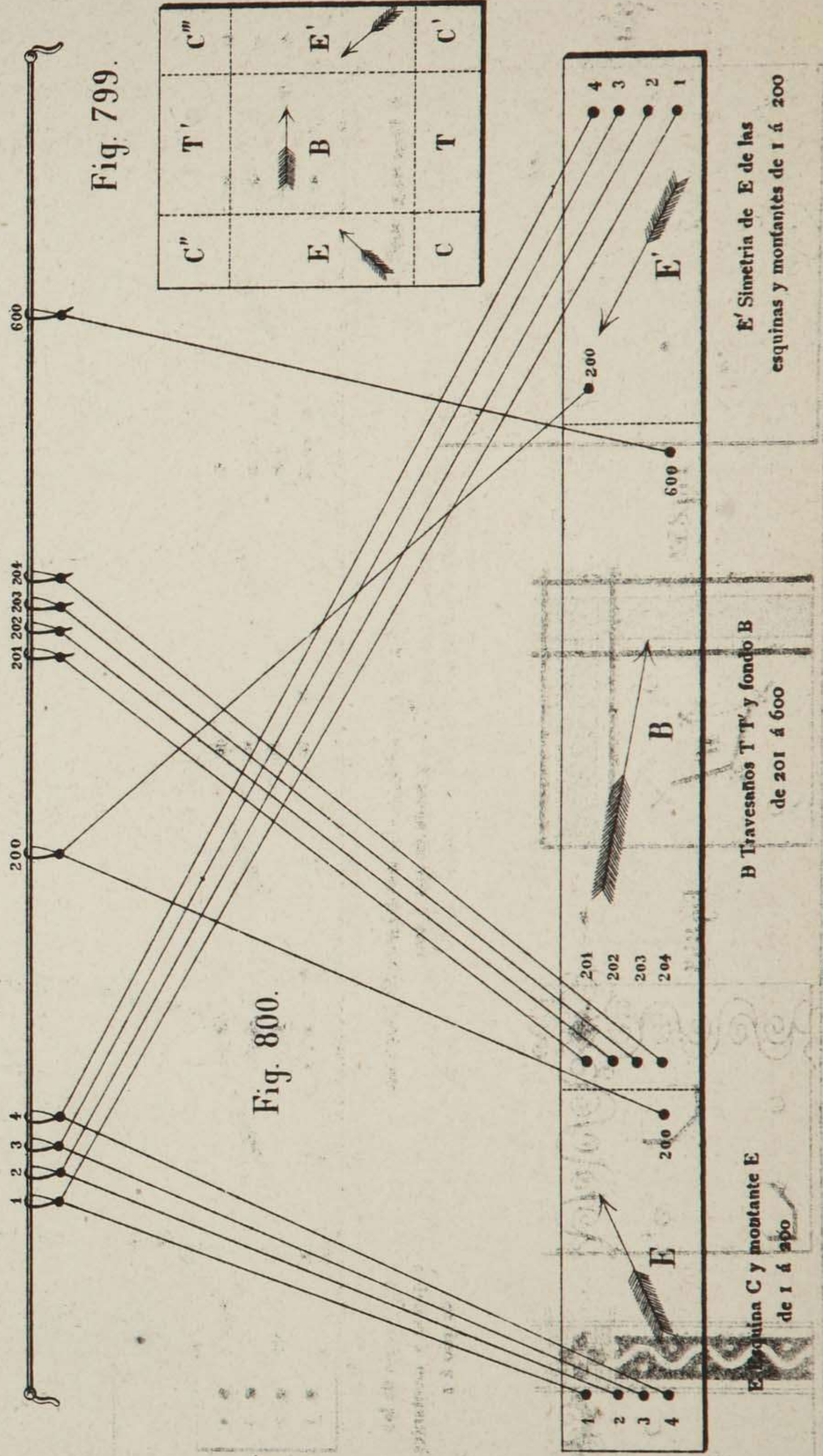


Fig. 848.



PASAR BASTARDO
(Máquina de 600)



PASAR A BORDES SIMÉTRICOS Y A CAMINOS SEGUIDOS

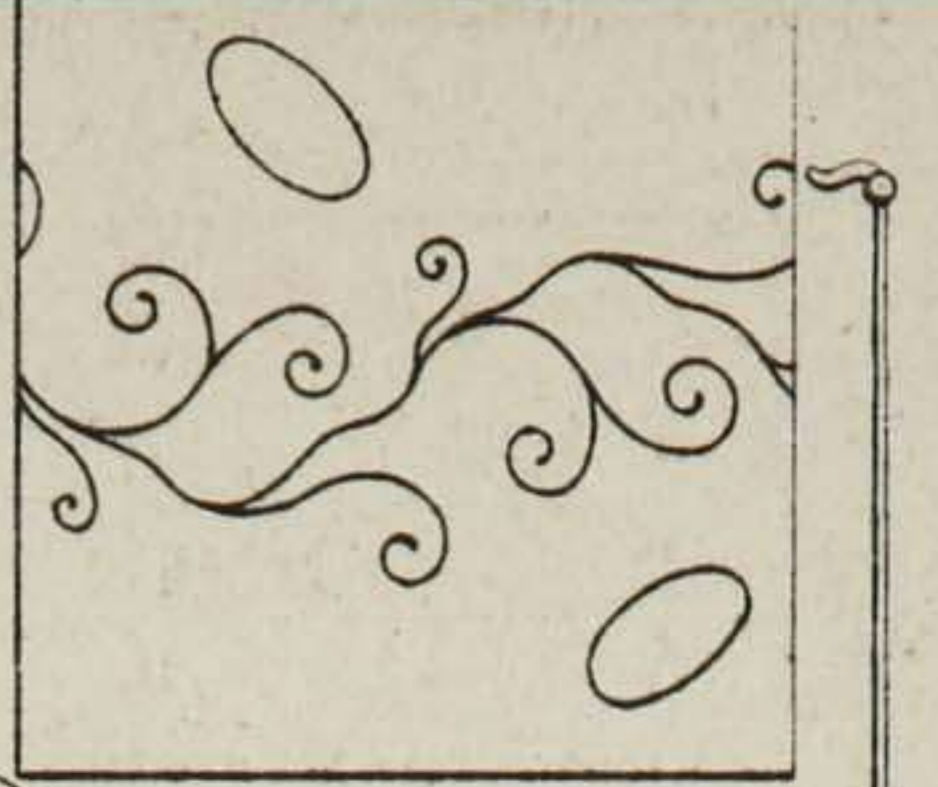


Fig. 855.

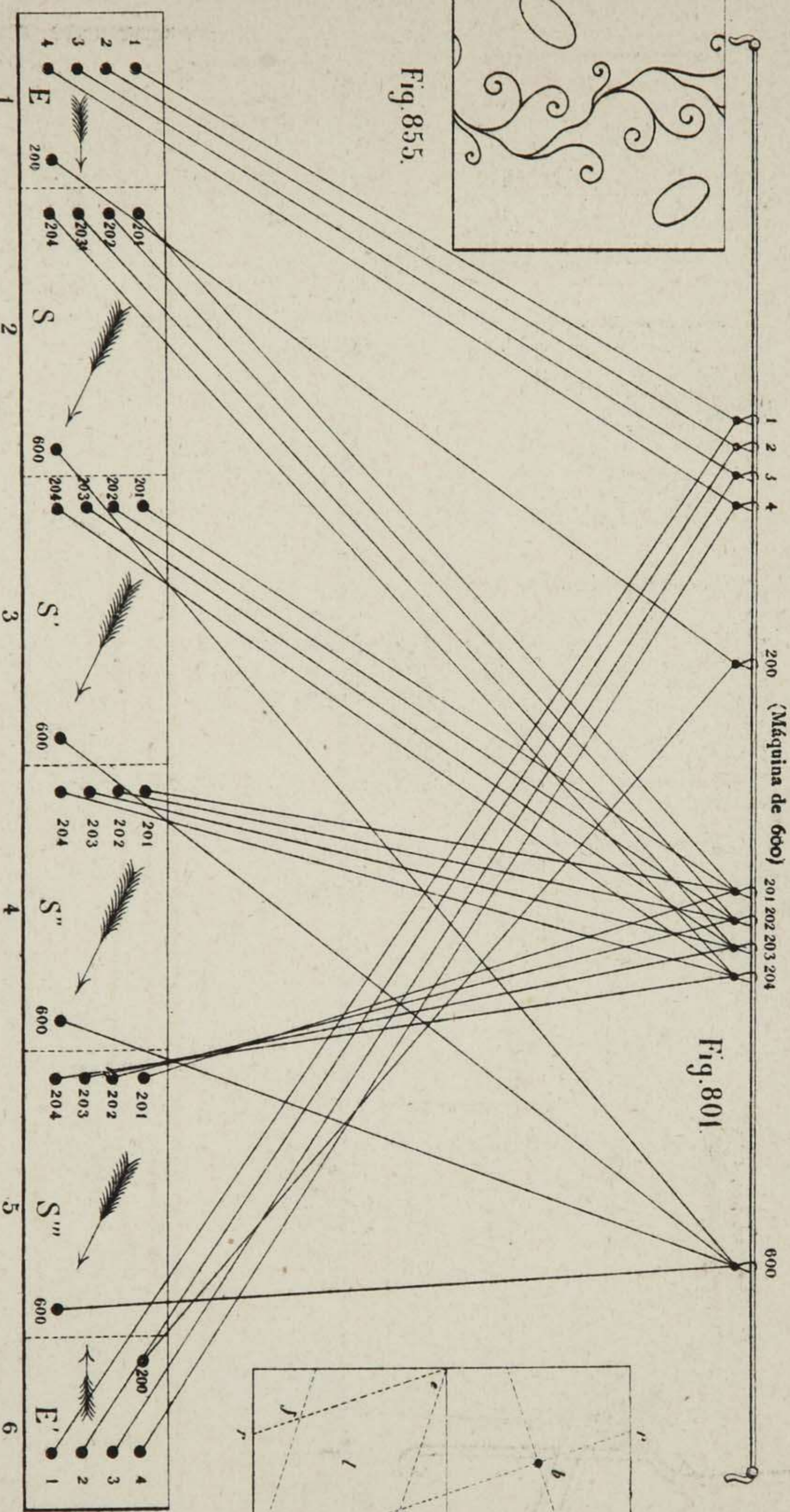


Fig. 801

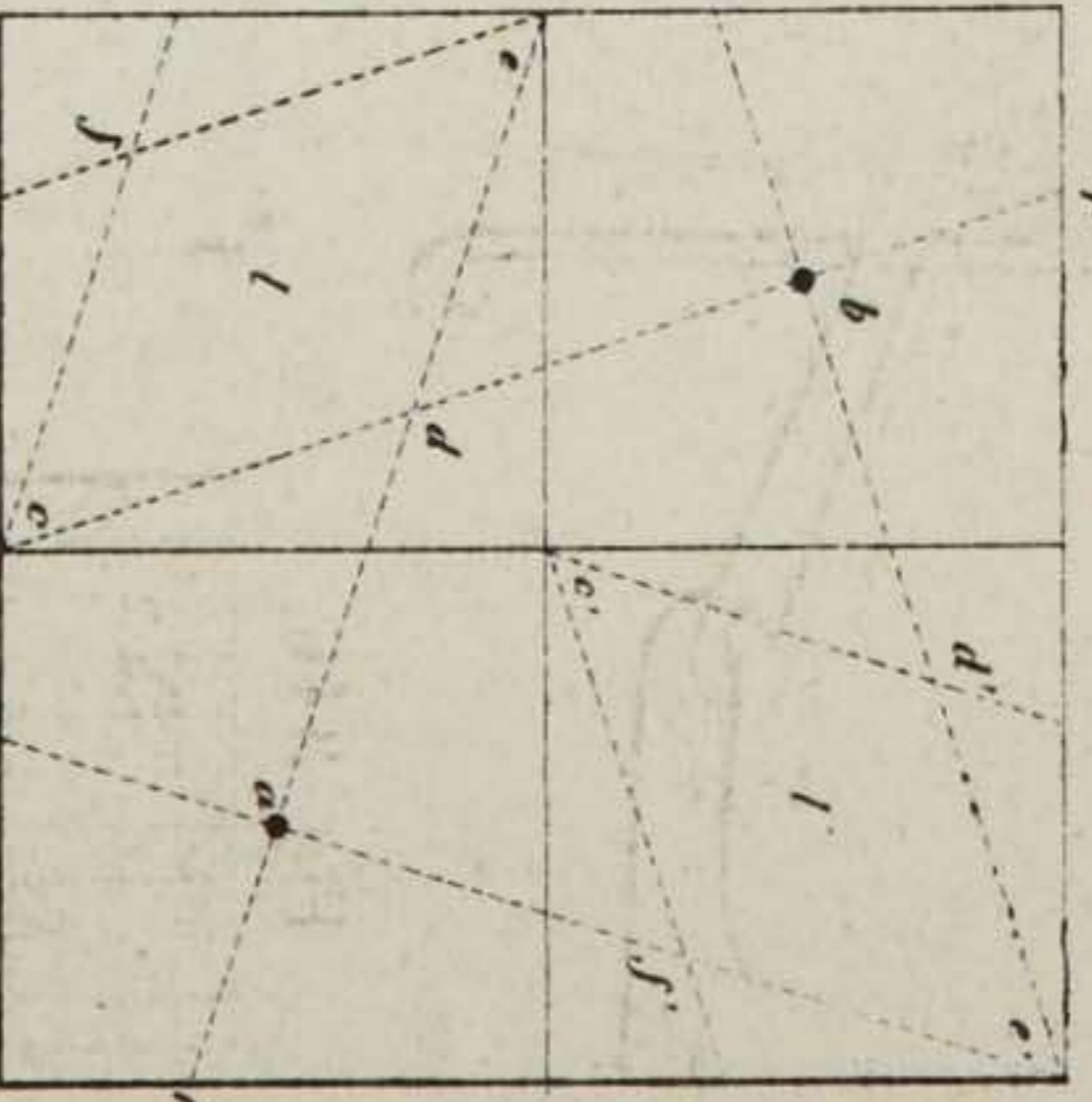


Fig. 850.

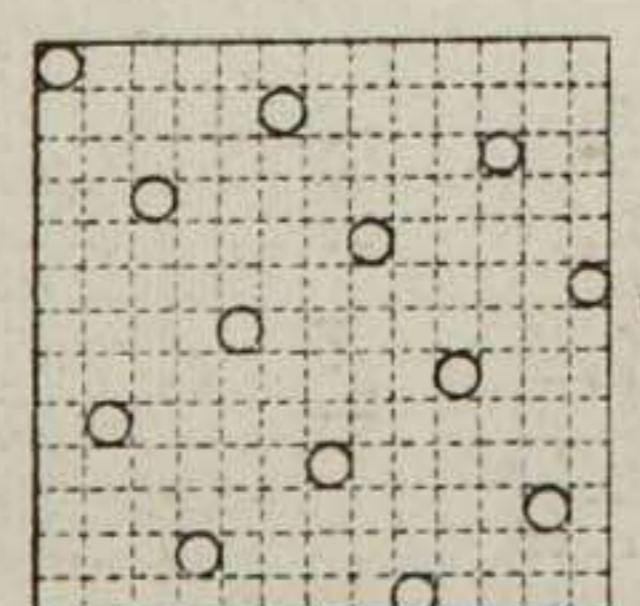


Fig. 849.

K Esquina y montante

S S' S'' S''' Cuatro repeliones seguidas de travesanos y fondo de 201 á 600

E Simetria de las esquinas y montantes de 260 á 1

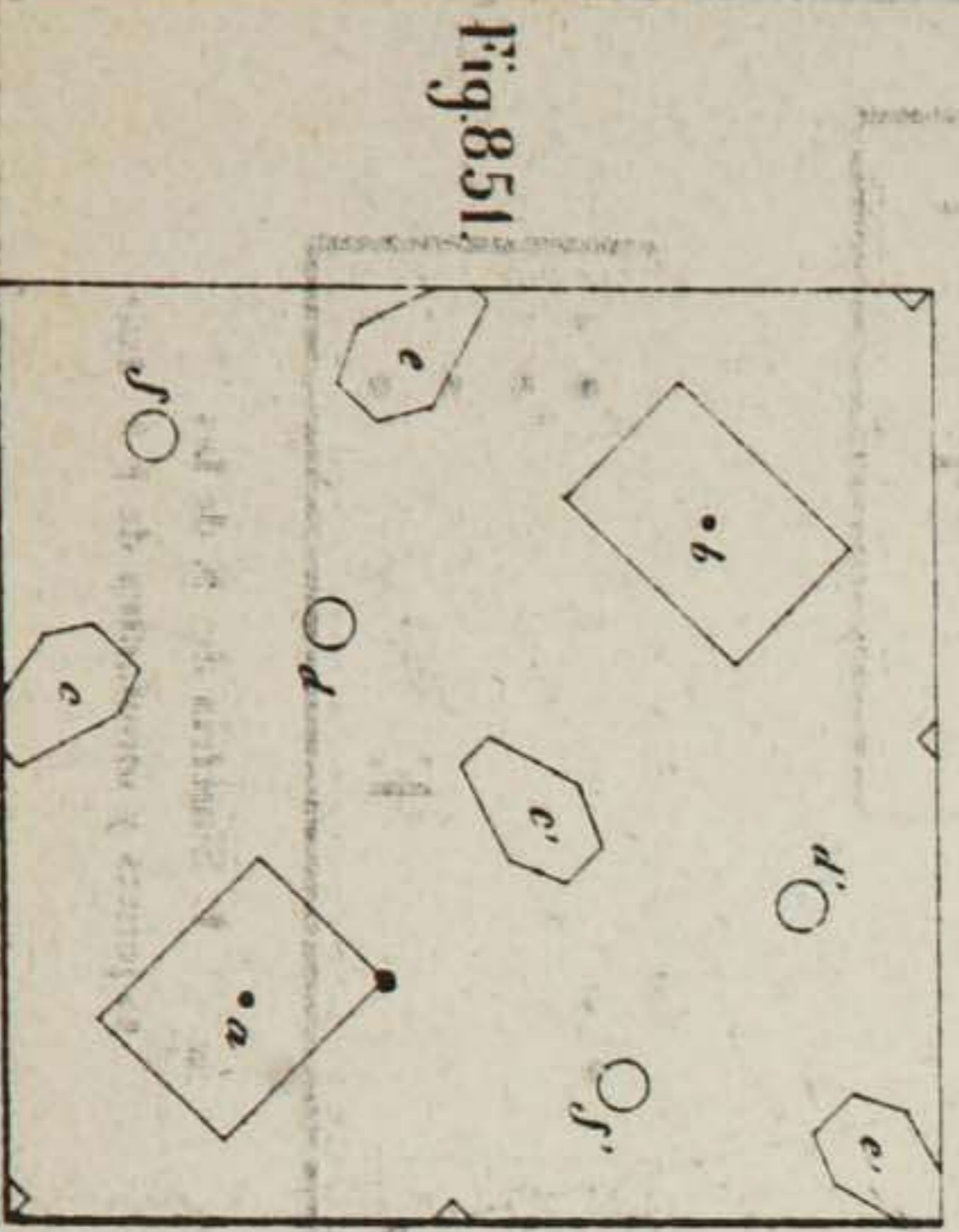


Fig. 851.

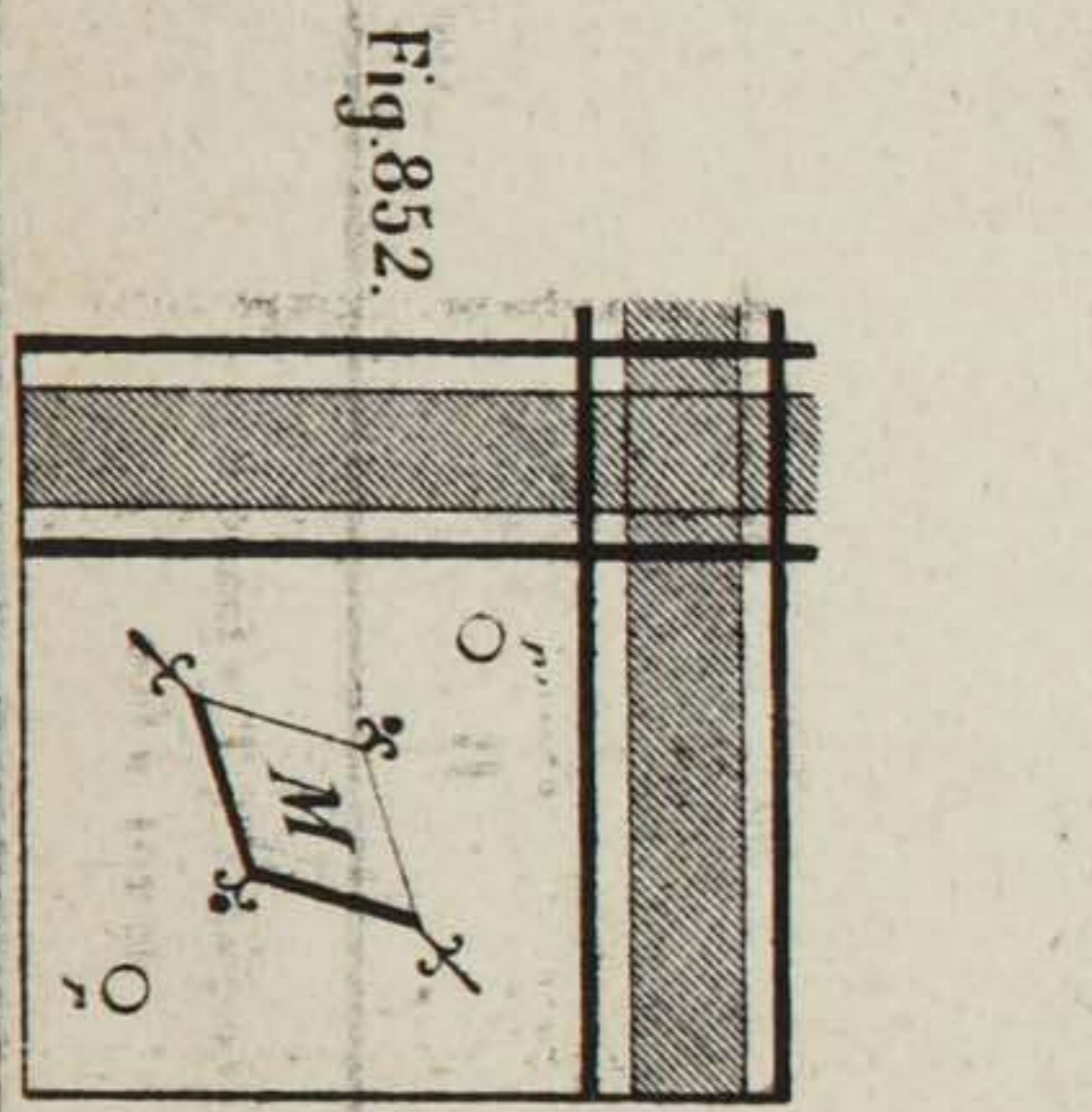


Fig. 852.

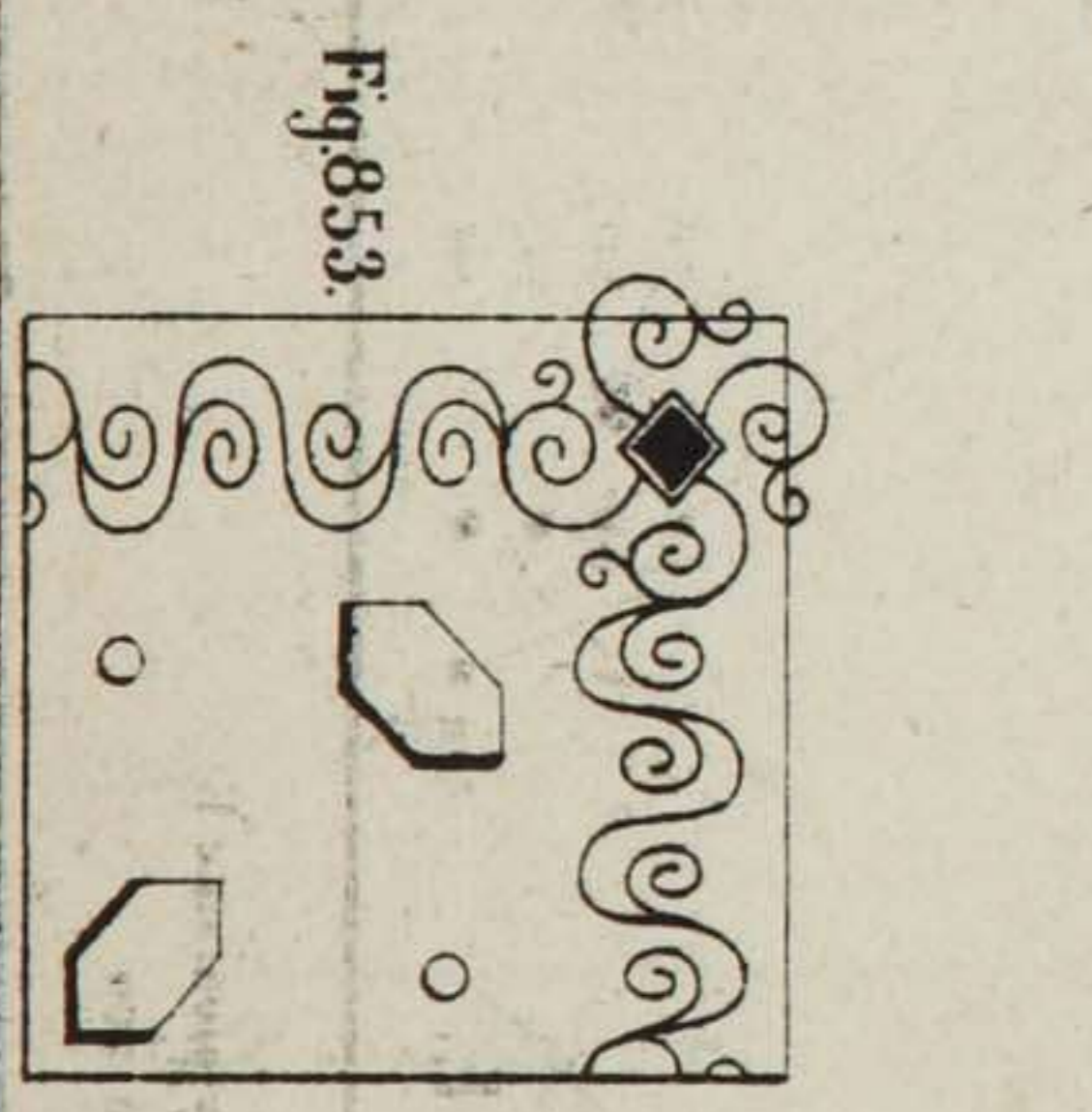


Fig. 853.

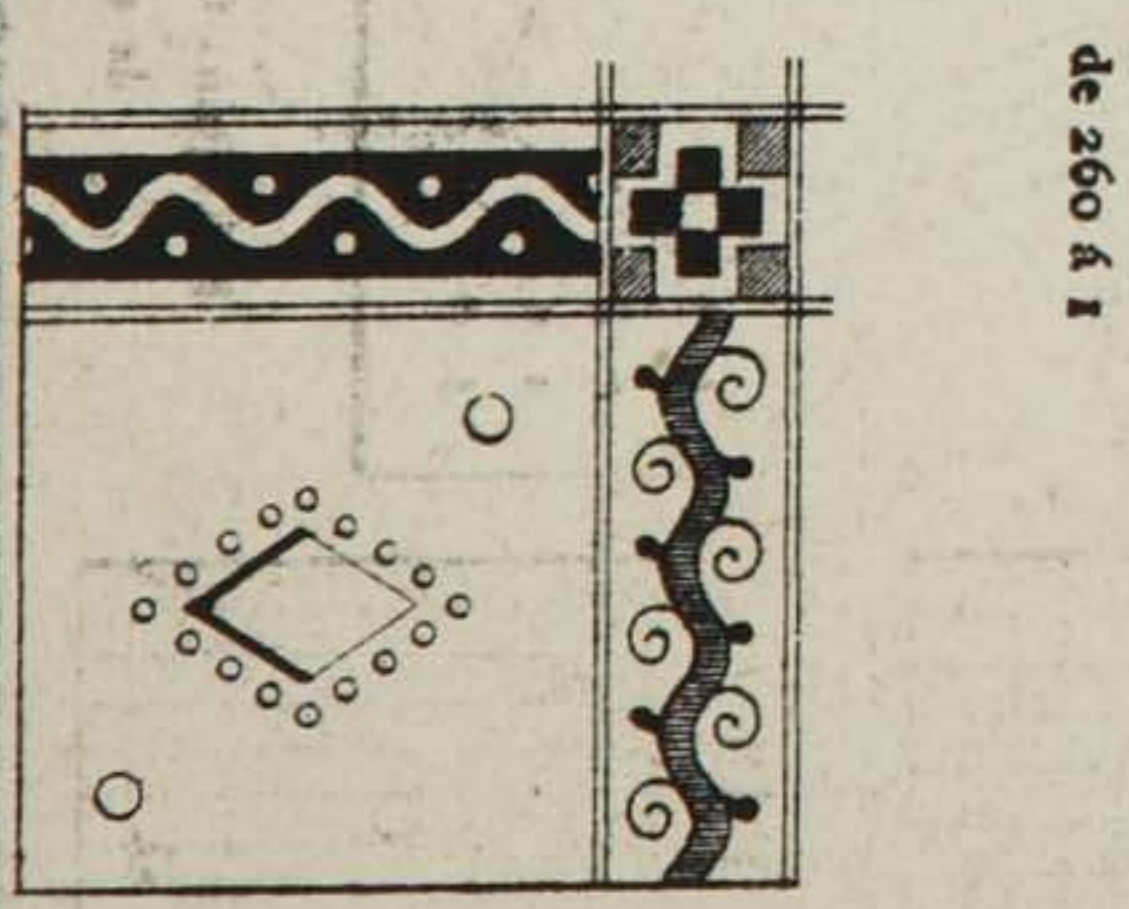
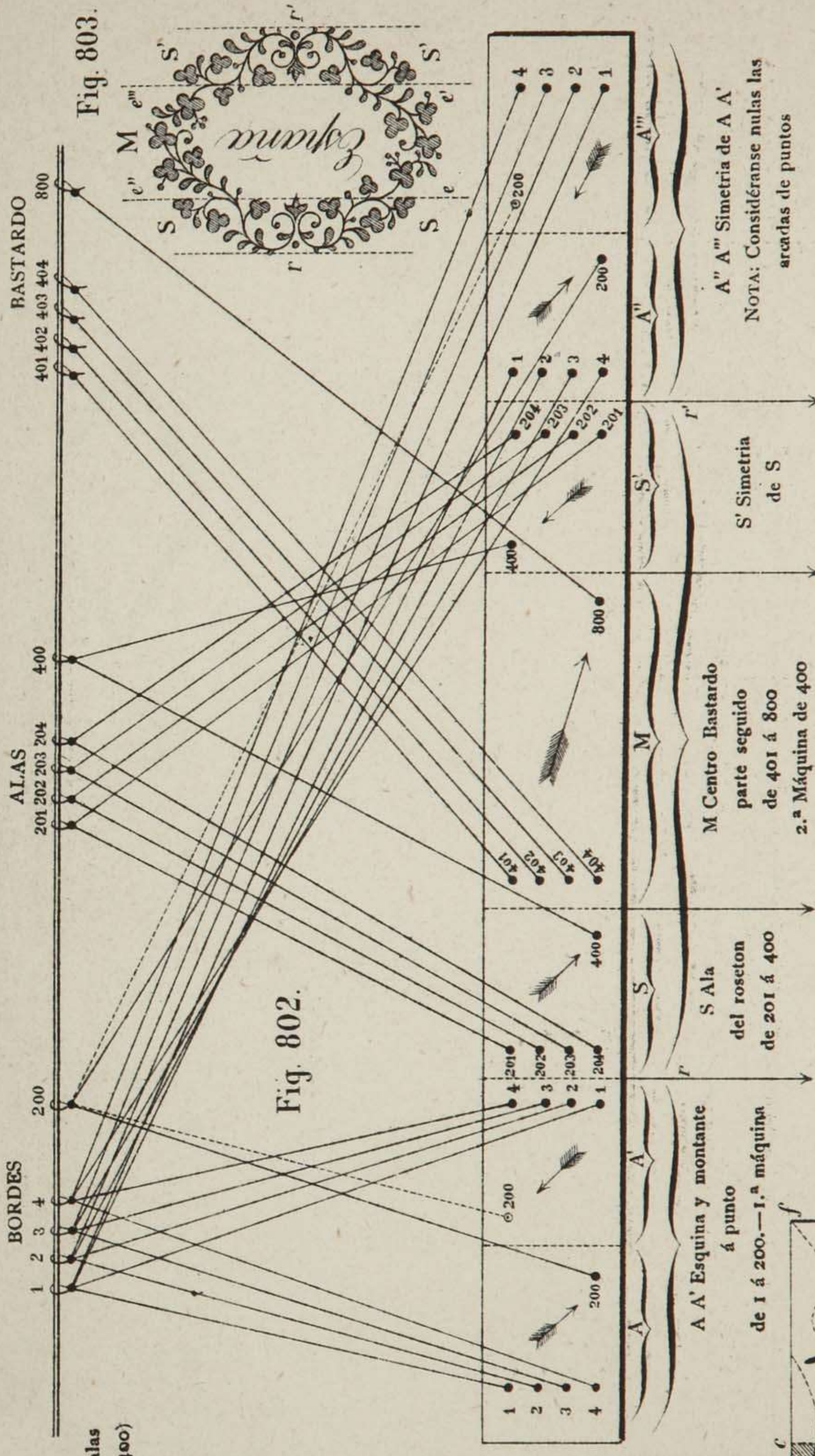


Fig. 854.



Pasar Bastardo de alas
(Dos máquinas de 400)

Fig. 859.

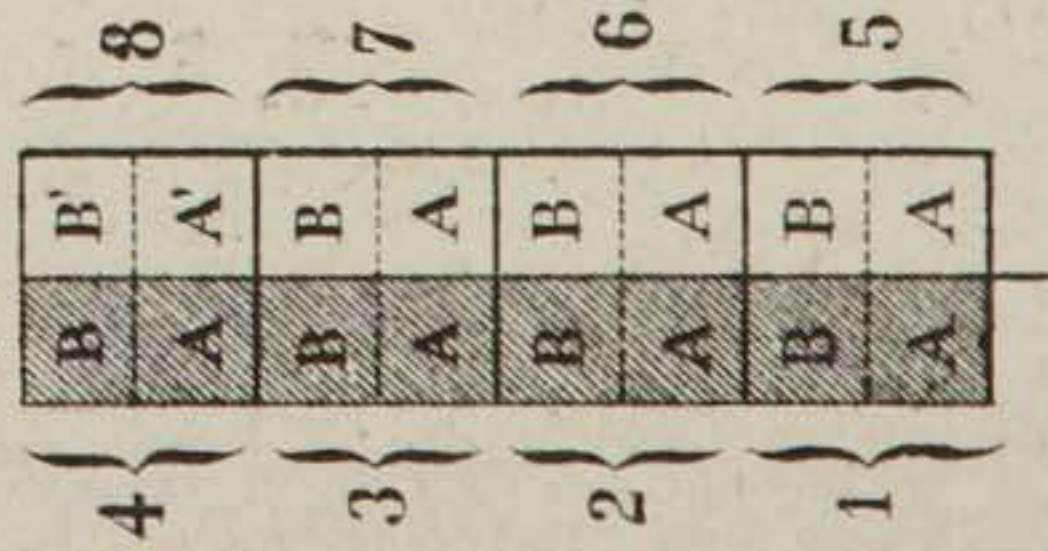


Fig. 803.



A'' A''' Simetria de A A'

NOTA: Considéranse nulas las
arcadas de puntos

S' Simetria
de S

M Centro Bastardo
parte seguido
de 401 á 800
2.^a Máquina de 400

S Ala
del roseton
de 201 á 400

A A' Esquina y montante
á punto
de 1 á 200.—1.^a máquina

Fig. 860.

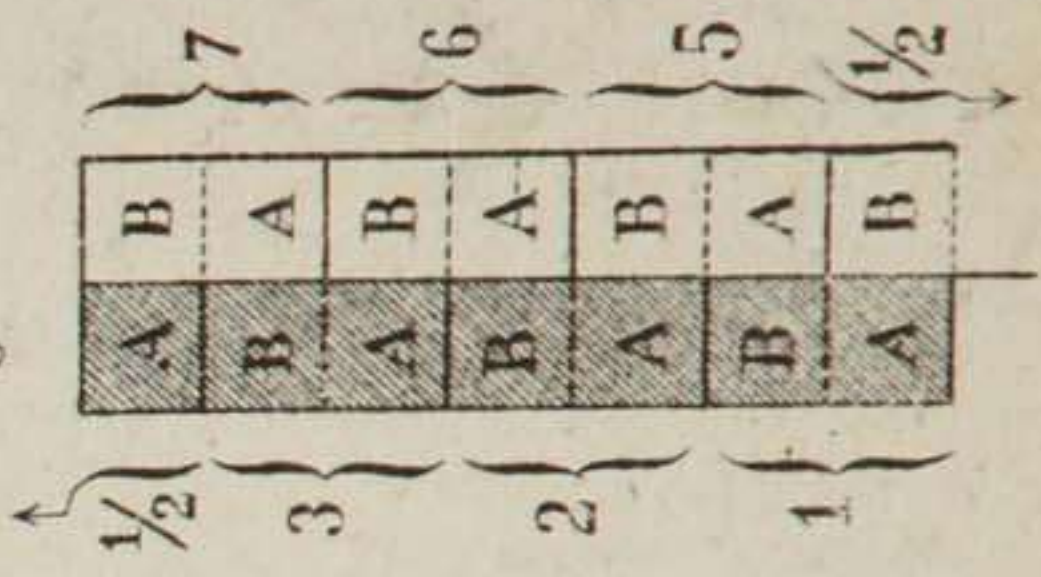


Fig. 857.

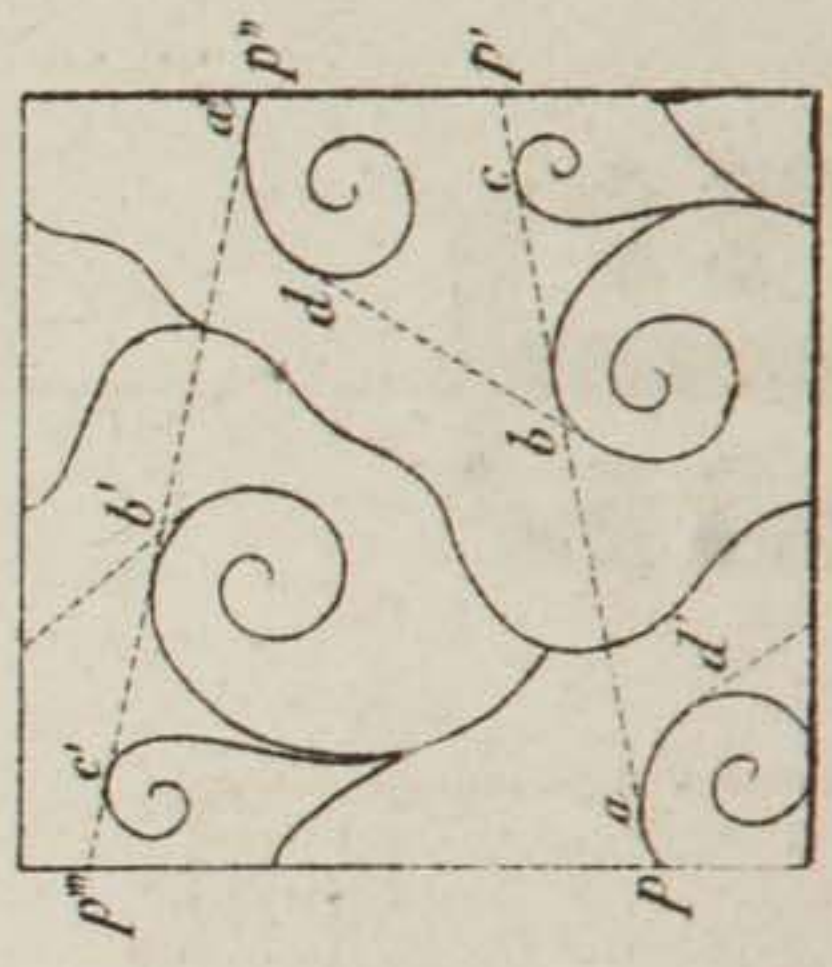


Fig. 856.

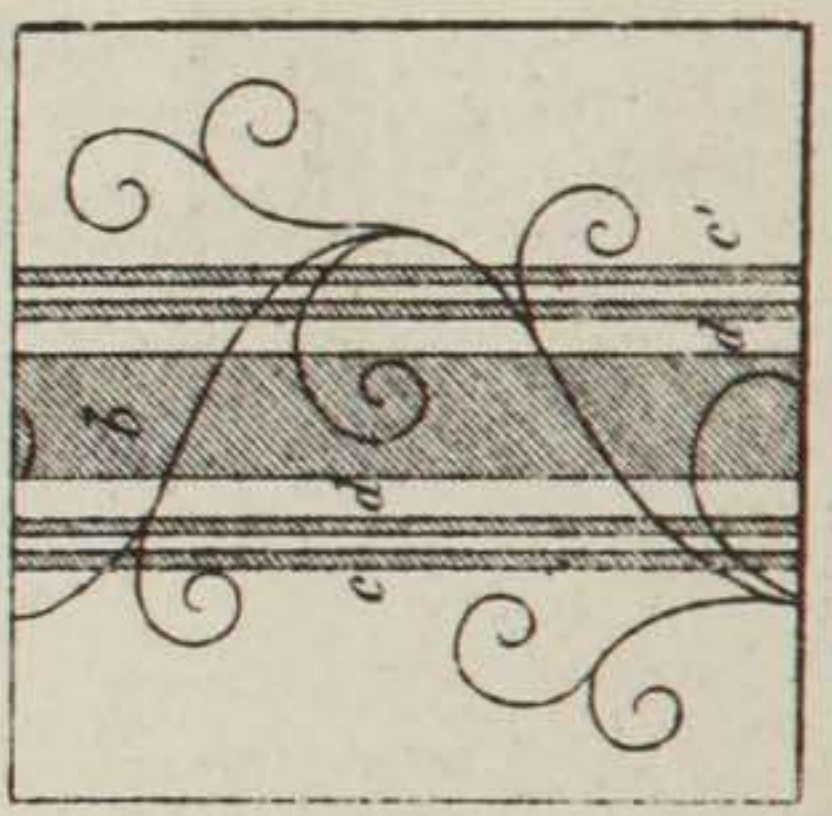
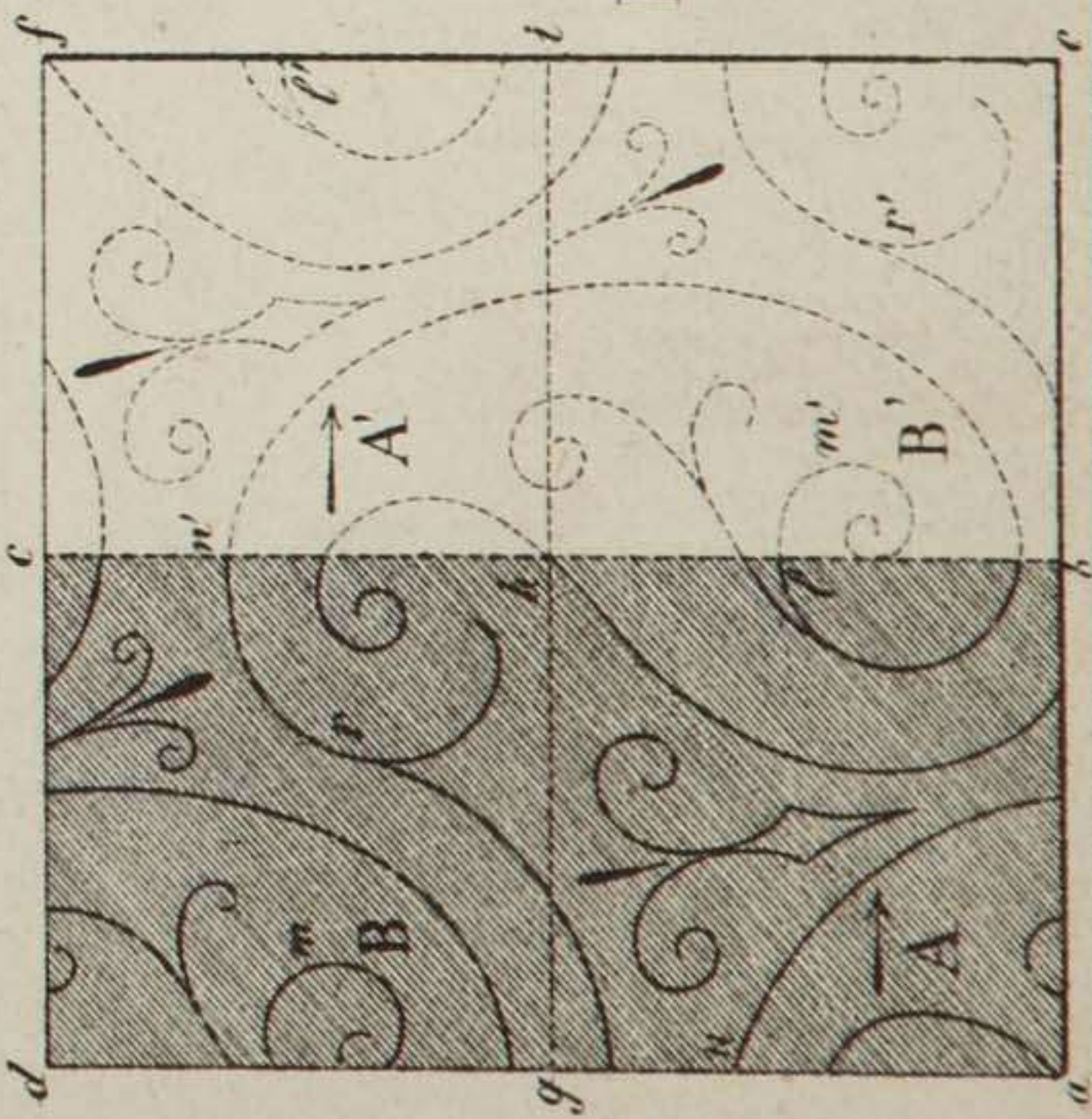


Fig. 858.



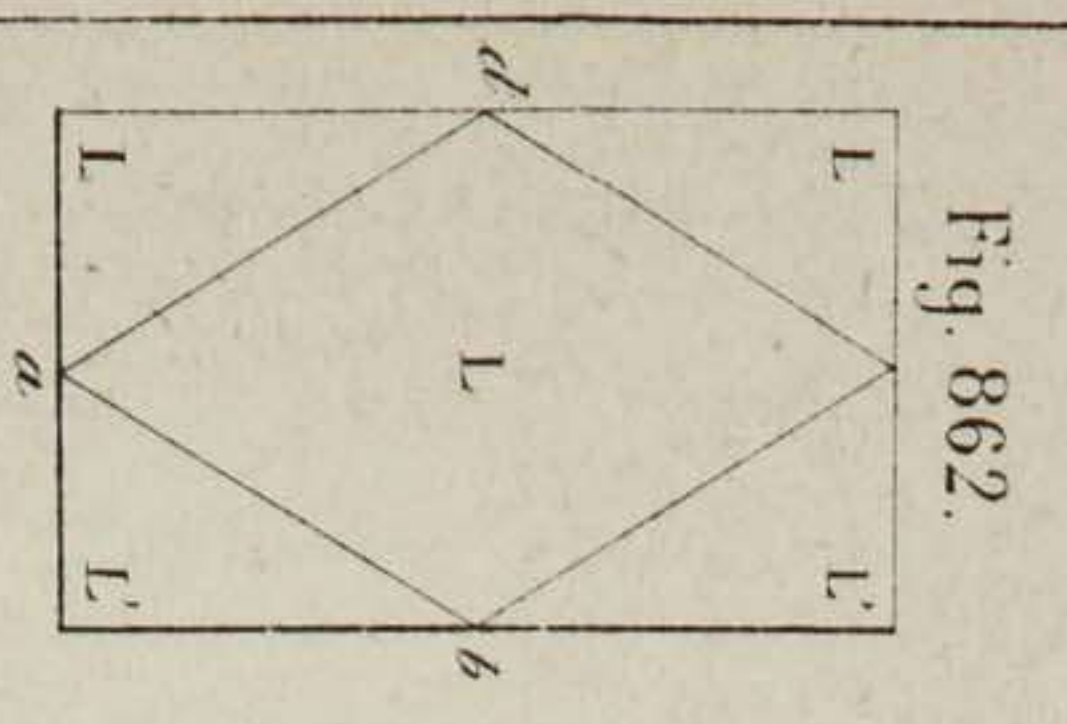


Fig. 862.

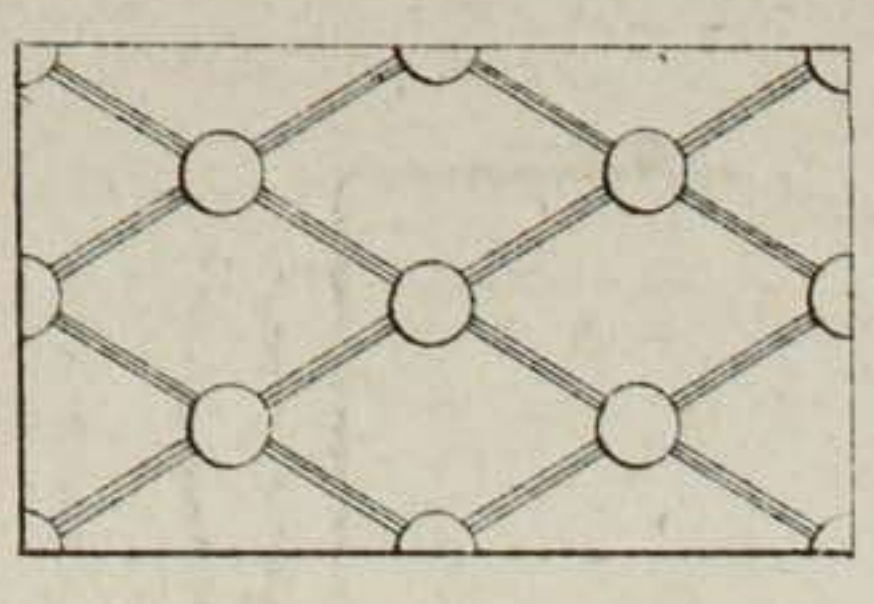


Fig. 866.



Fig. 867.

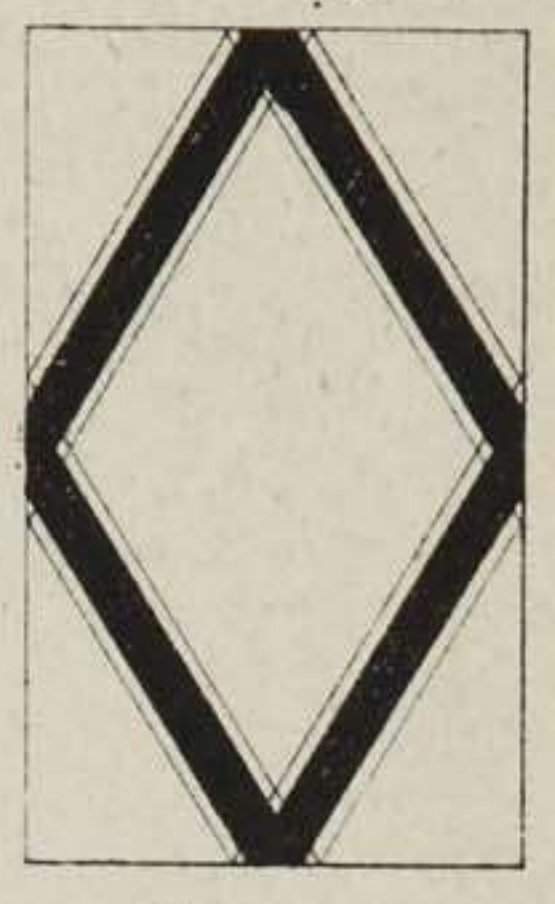


Fig. 863.

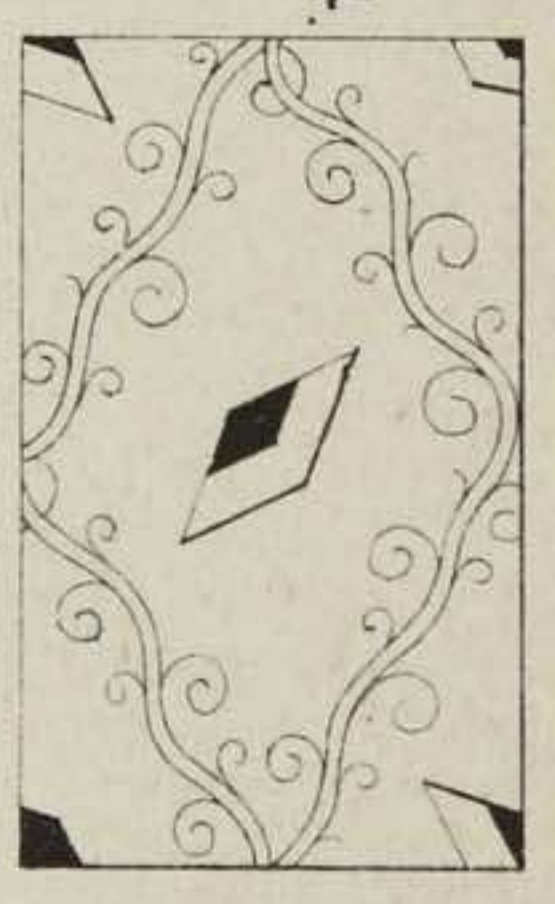


Fig. 864.

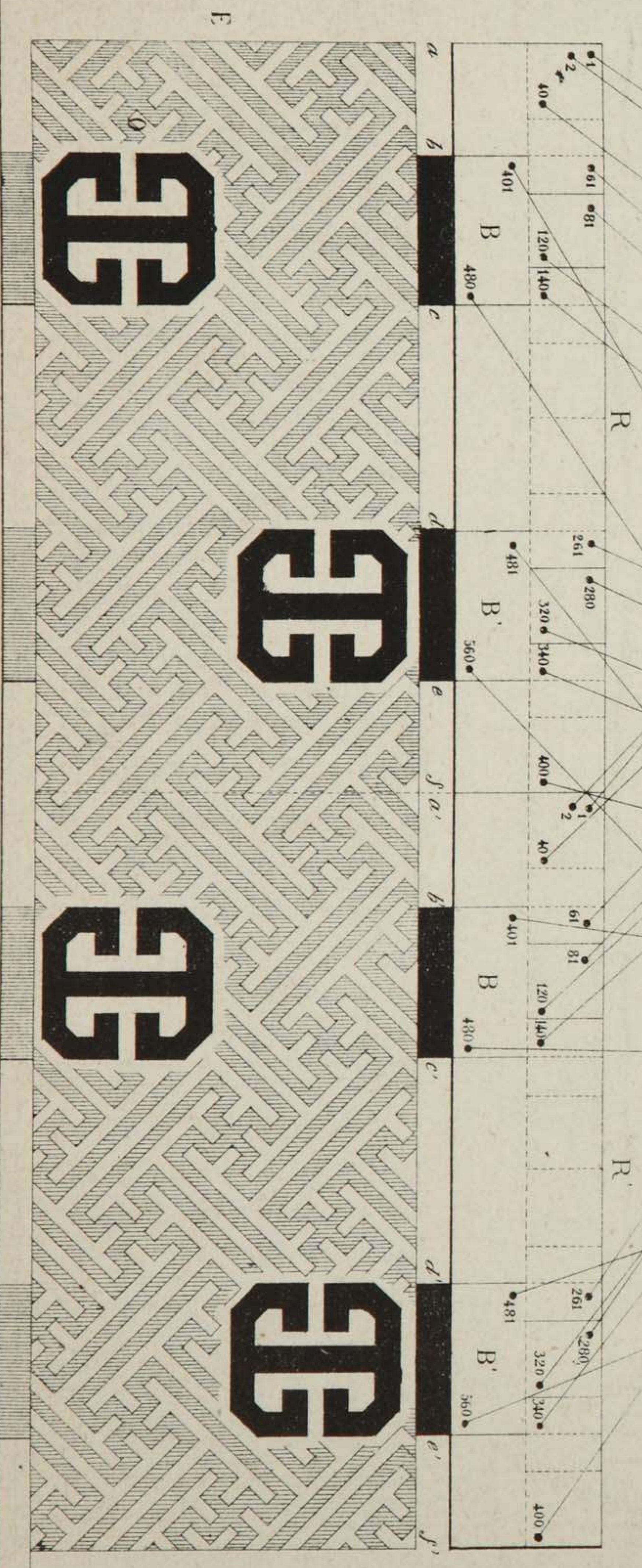


Fig. 865.



Fig. 804.

PASAR Á DOS CUERPOS
EL UNO Á ORDEN SEGUIDO
Y EL OTRO INTERRÚMPIDO
PASAR SALTADO



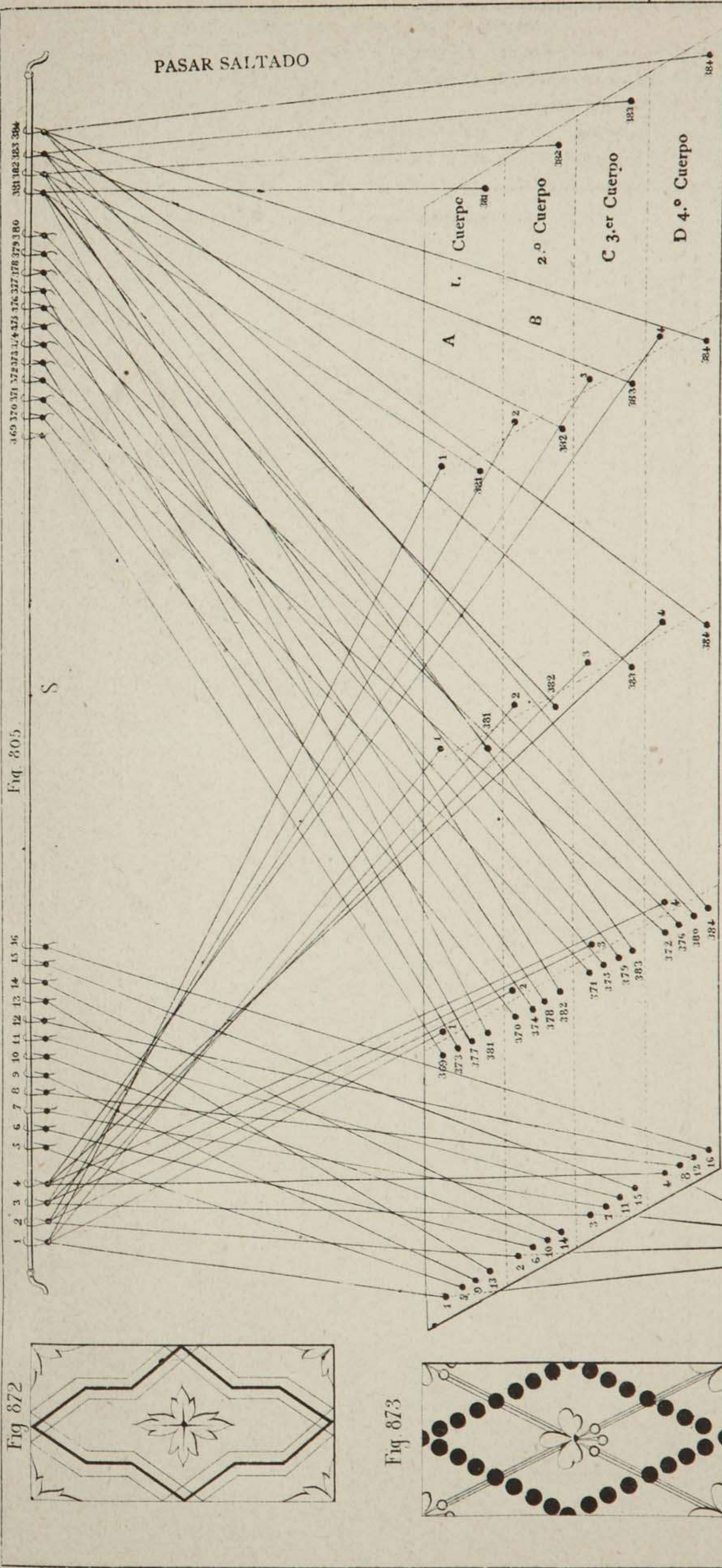


Fig. 805.

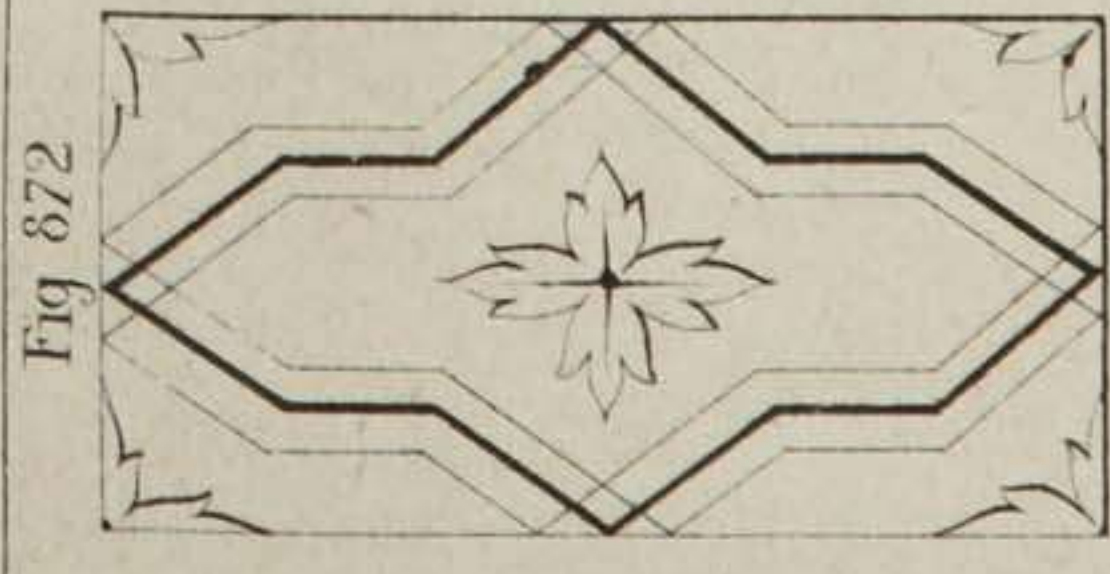


Fig. 872

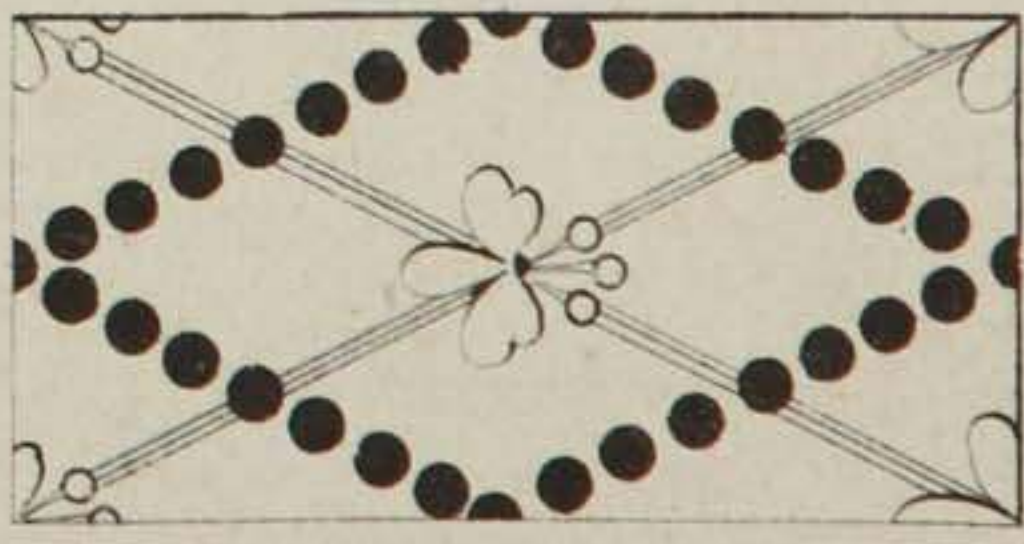


Fig. 873

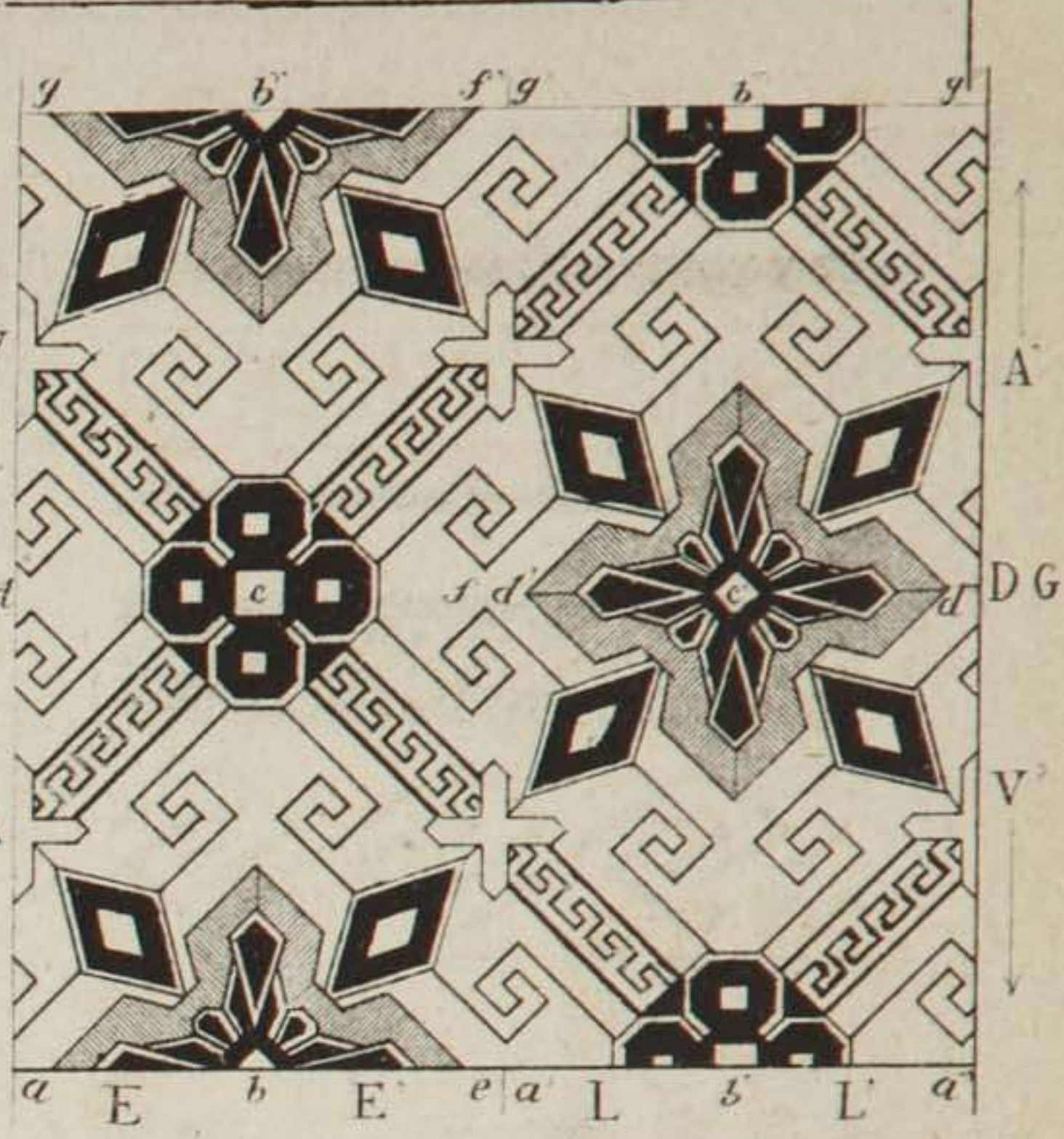


Fig. 861

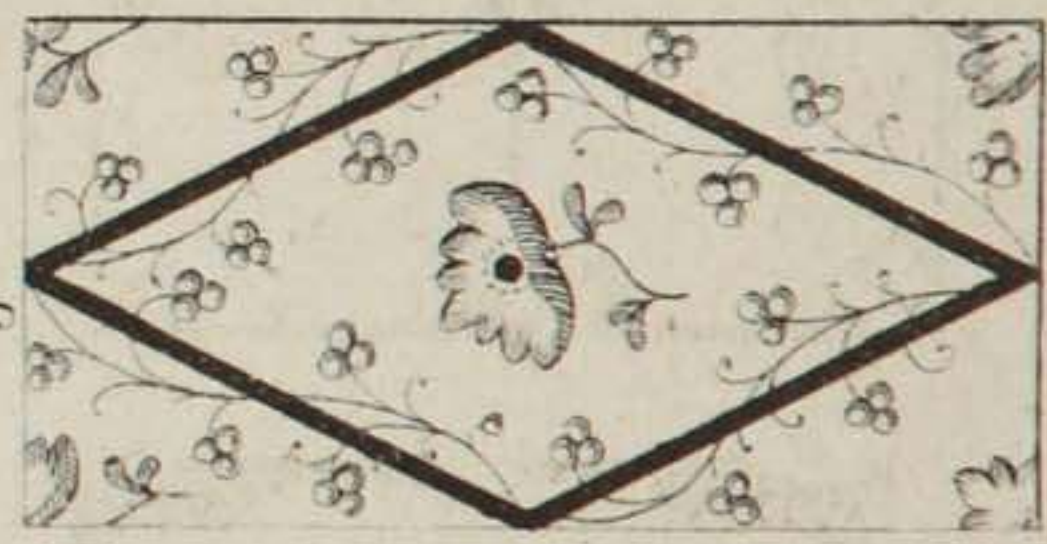


Fig. 868.

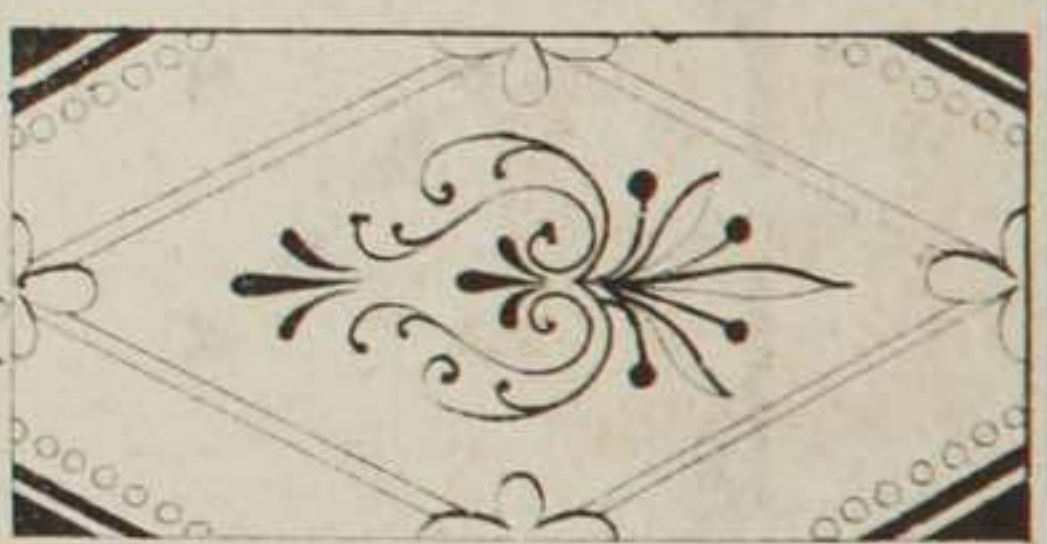


Fig. 871

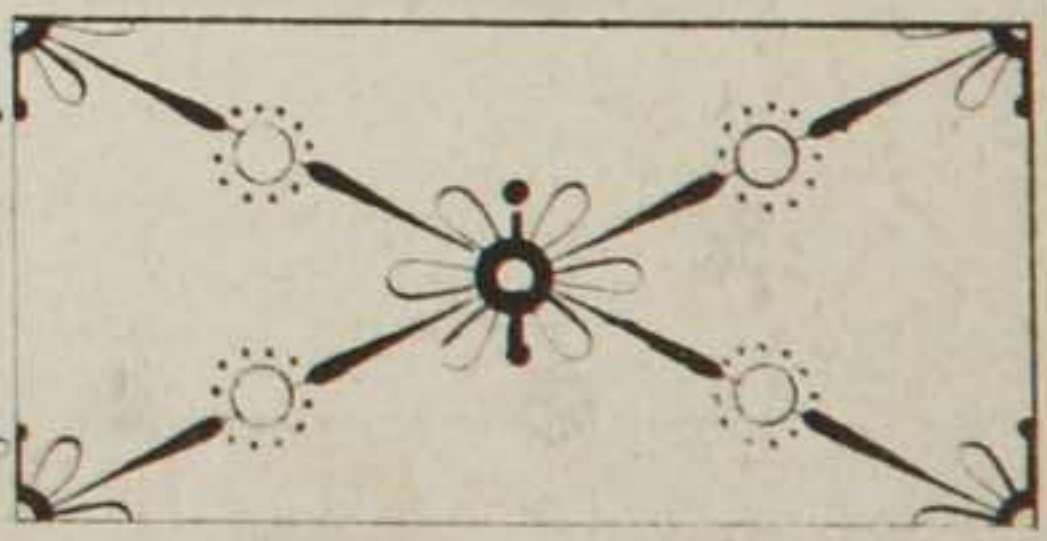


Fig. 870

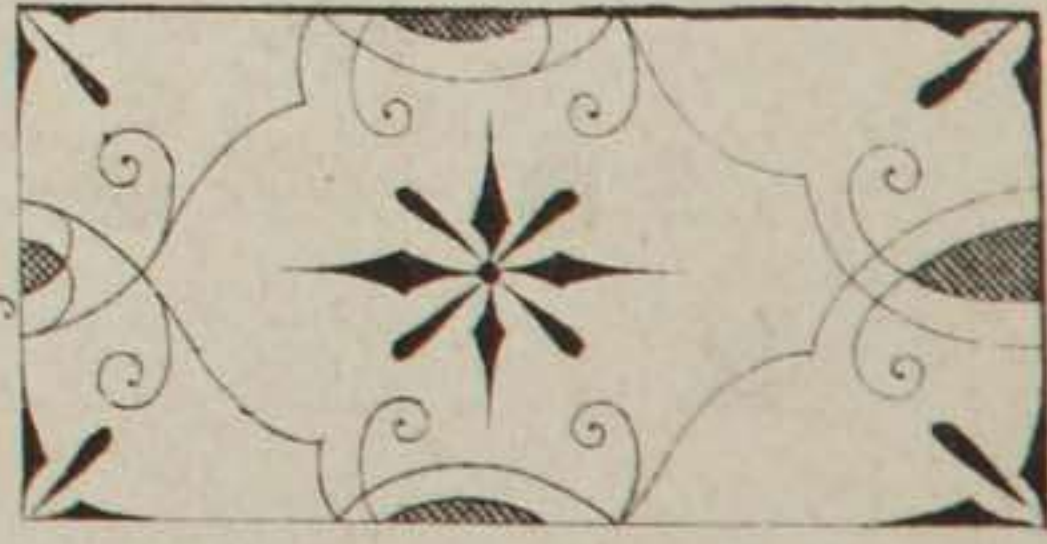


Fig. 869

CRUCE SALTADO

E

Máquinas de 400 y 500-900 ganchos

- 1.º t' t' dos anillos á punta de 1 á 500=198 arcadas para 50 ganchos (2 arcadas nulas)
- 2.º B B' dos bordes seguidos de 51 á 400=700 " " 350 "
- 3.º K R' Bastardo general á punta de. 401 á 900=899 " " 500 " (1 arcada nula)
- 4.º B'' B''' Simetria de B B' de 400 á 51=700 " . "
- 5.º t'' t''' Simetria de t' t' de. . . 50 á 1=198 " " (2 arcadas nulas)

Total de arcadas 2795 para 900 ganchos

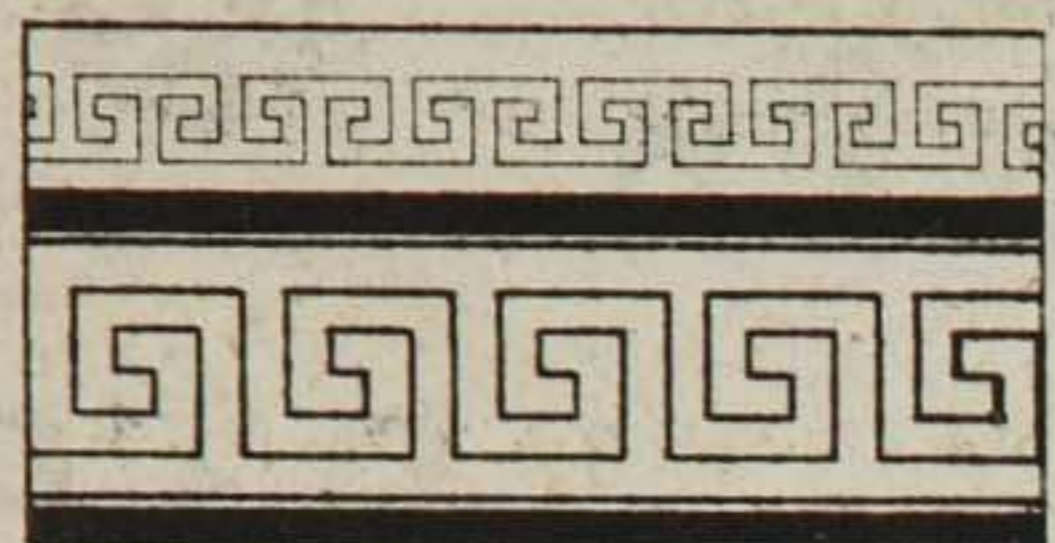


Fig. 874.



Fig. 875.

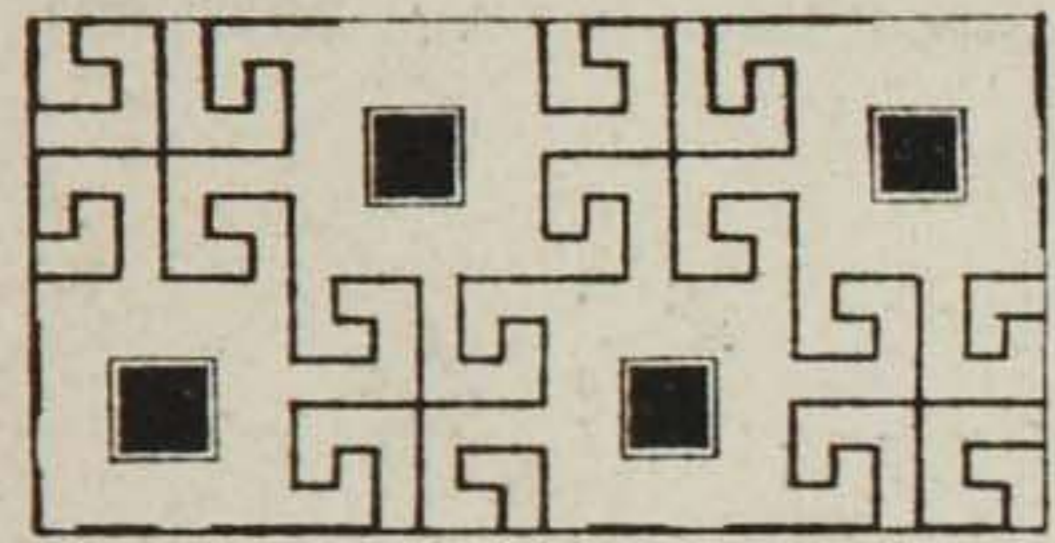


Fig. 876.



Fig. 877.

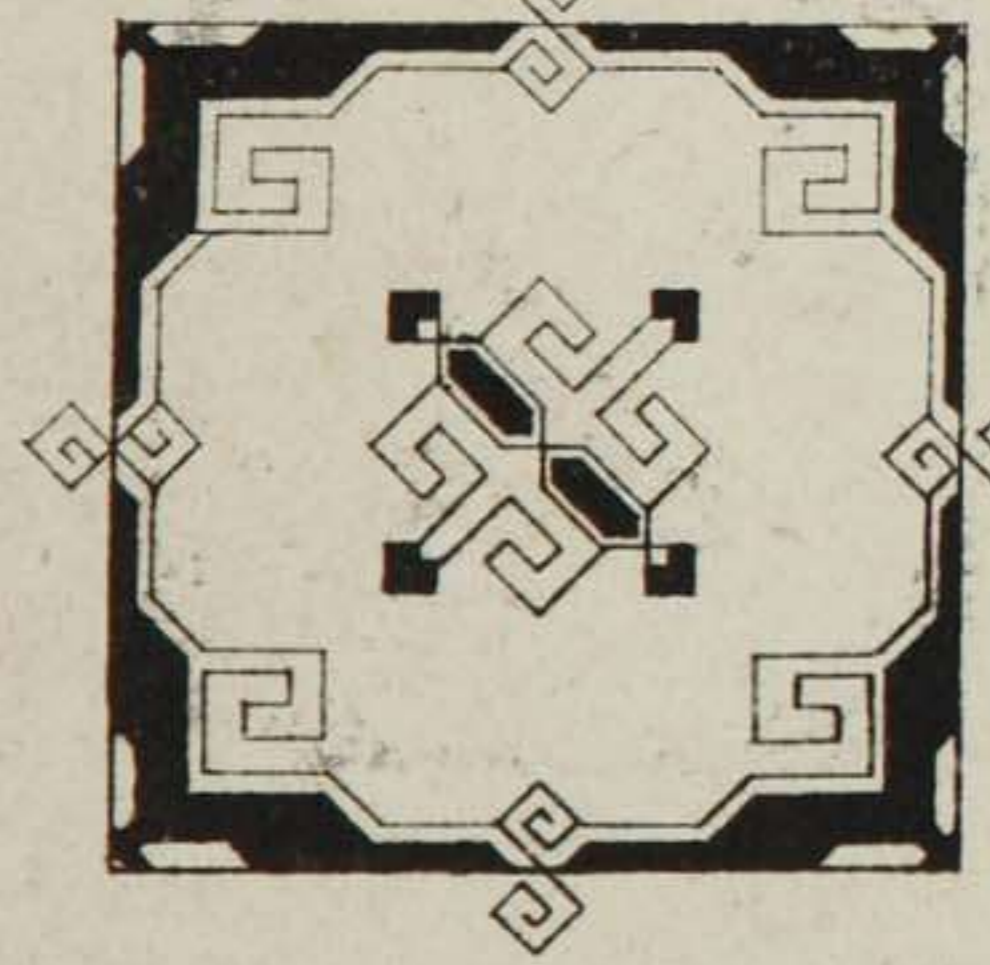


Fig. 878.

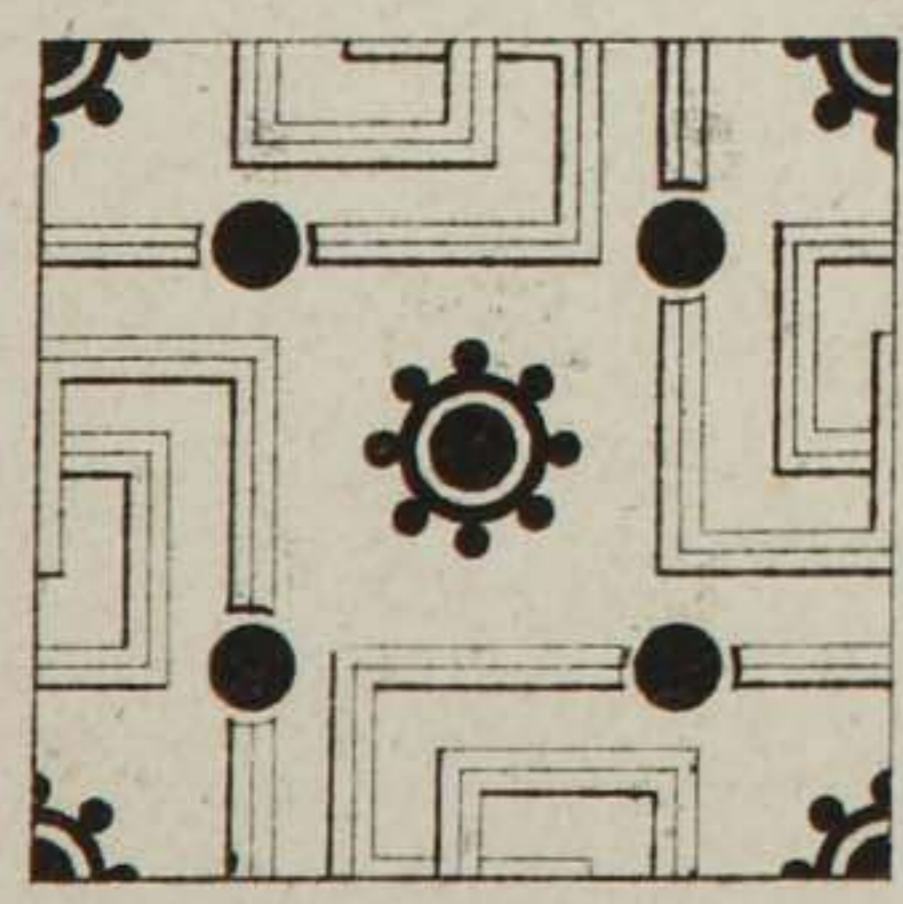


Fig. 879.

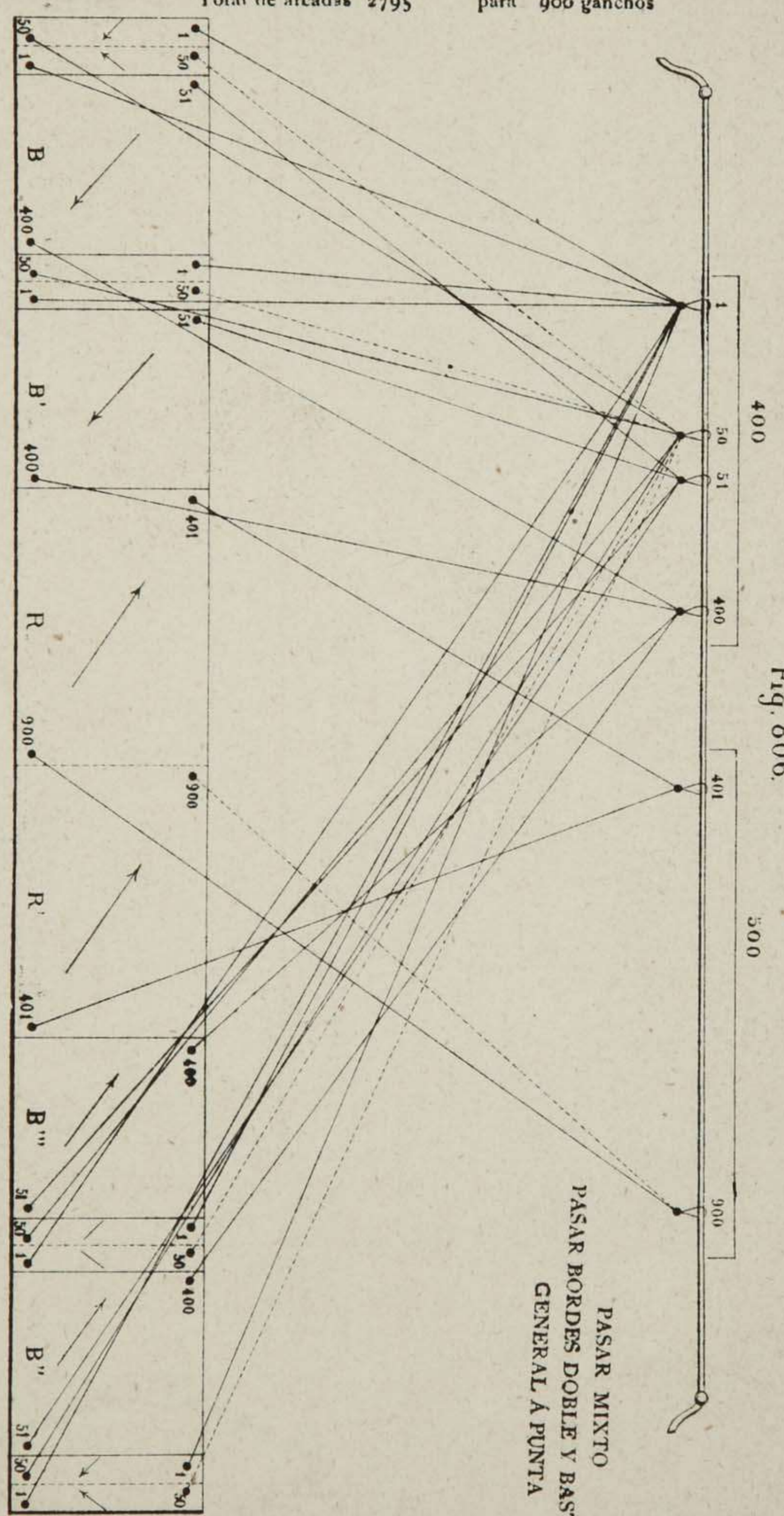


Fig. 806.

PASAR MIXTO
PASAR BORDES DOBLE Y BASTARDO
GENERAL A PUNTA

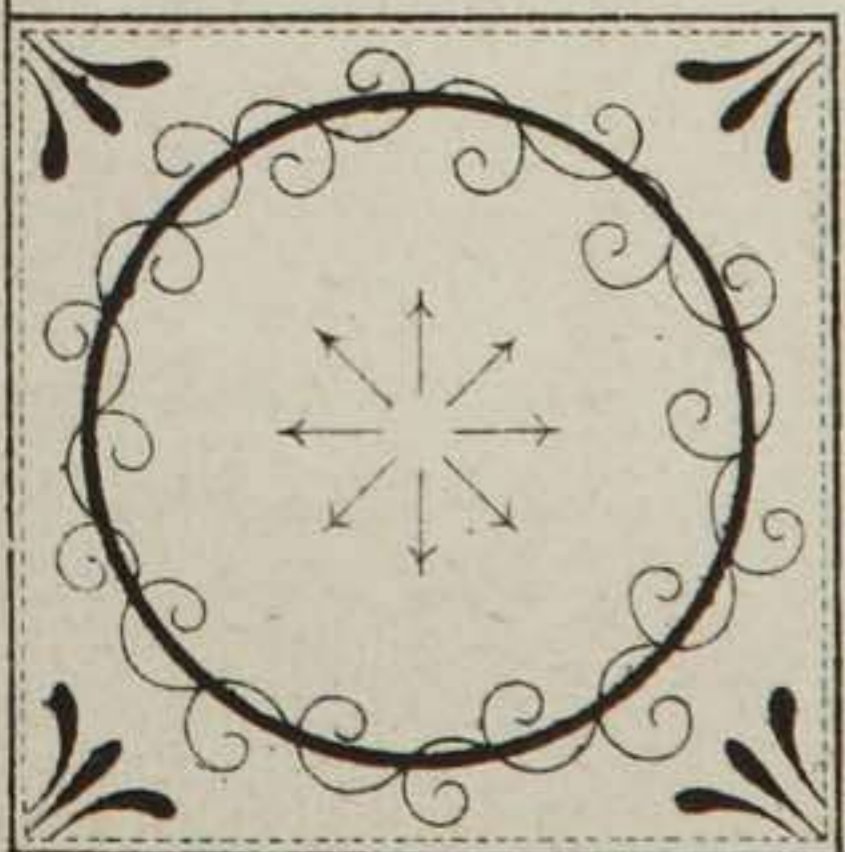


Fig. 881.

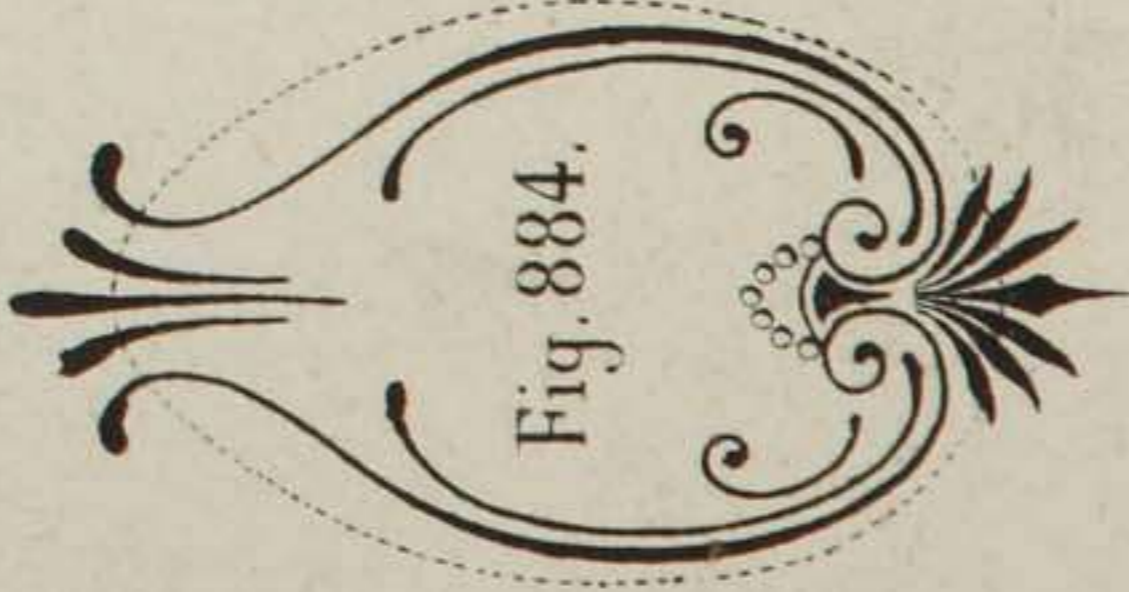
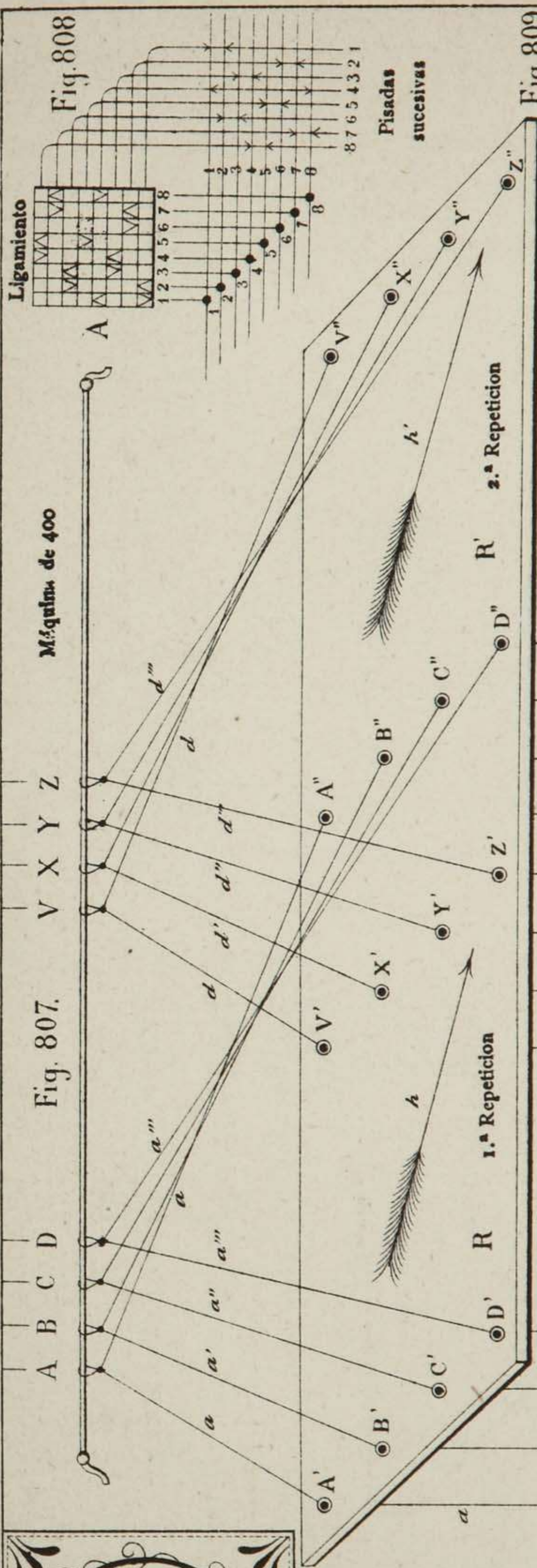


Fig. 884.



1.^a Repetición

2.^a Repetición

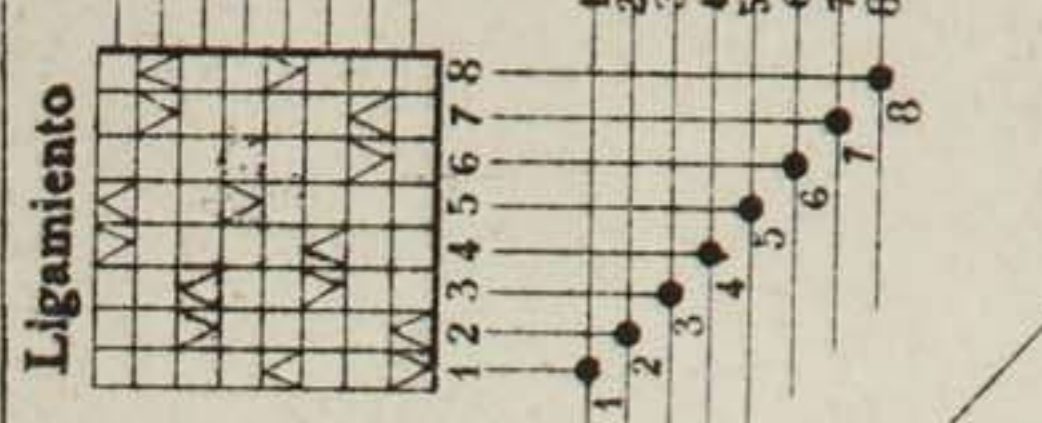


Fig. 808

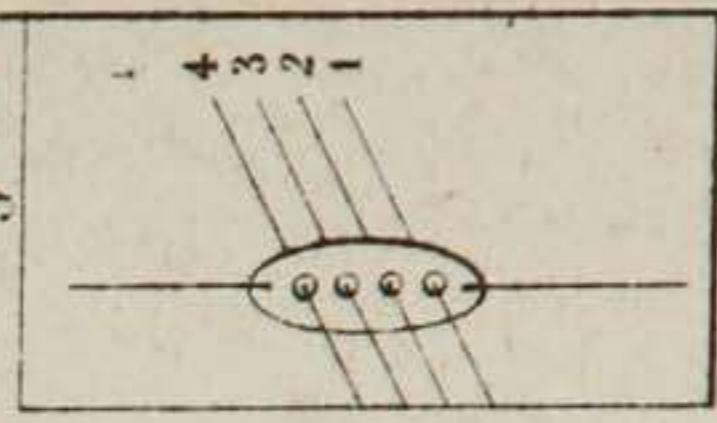


Fig. 809

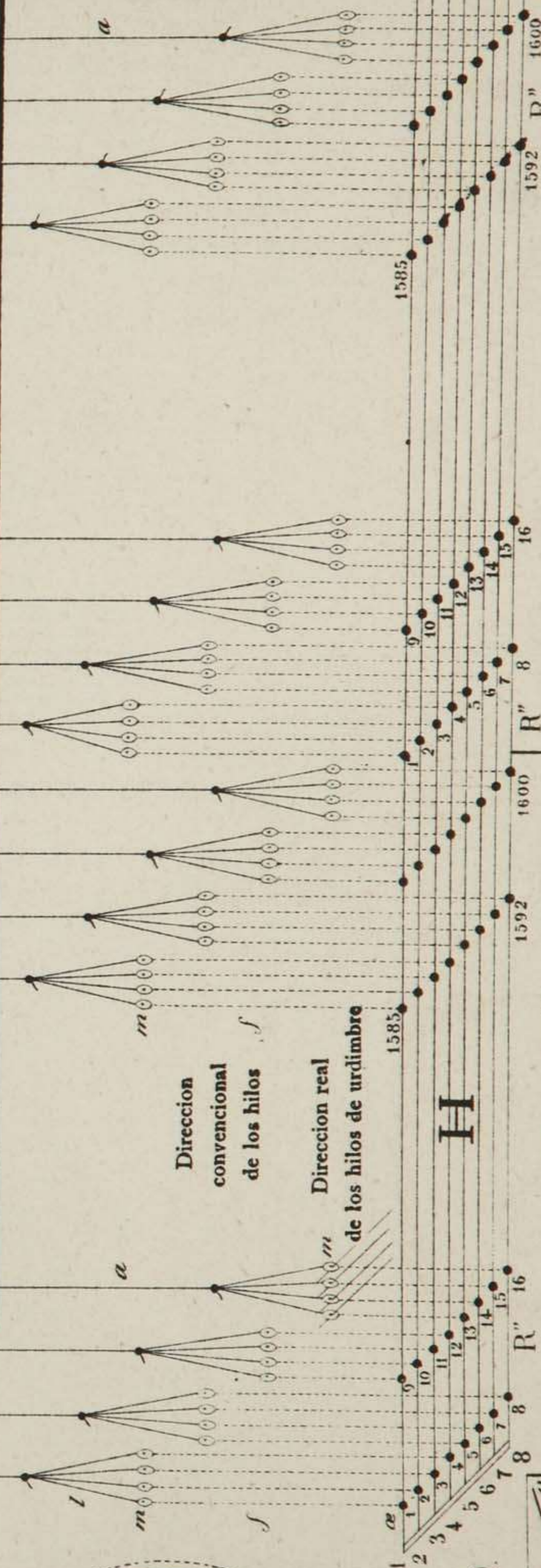


Fig. 880.

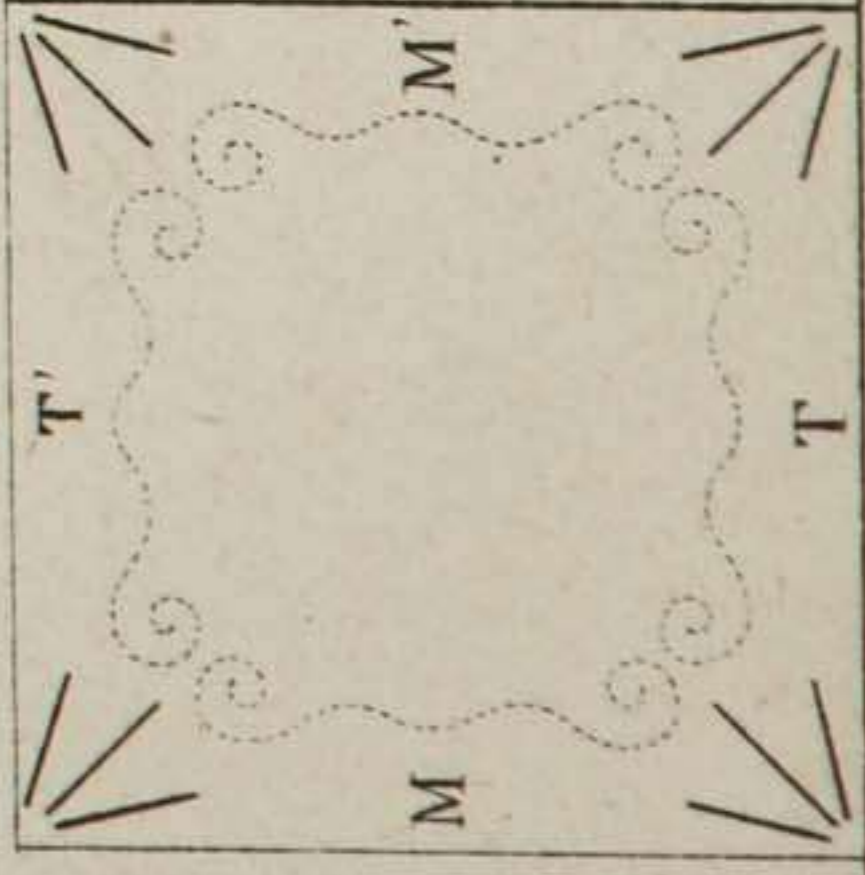


Fig. 882

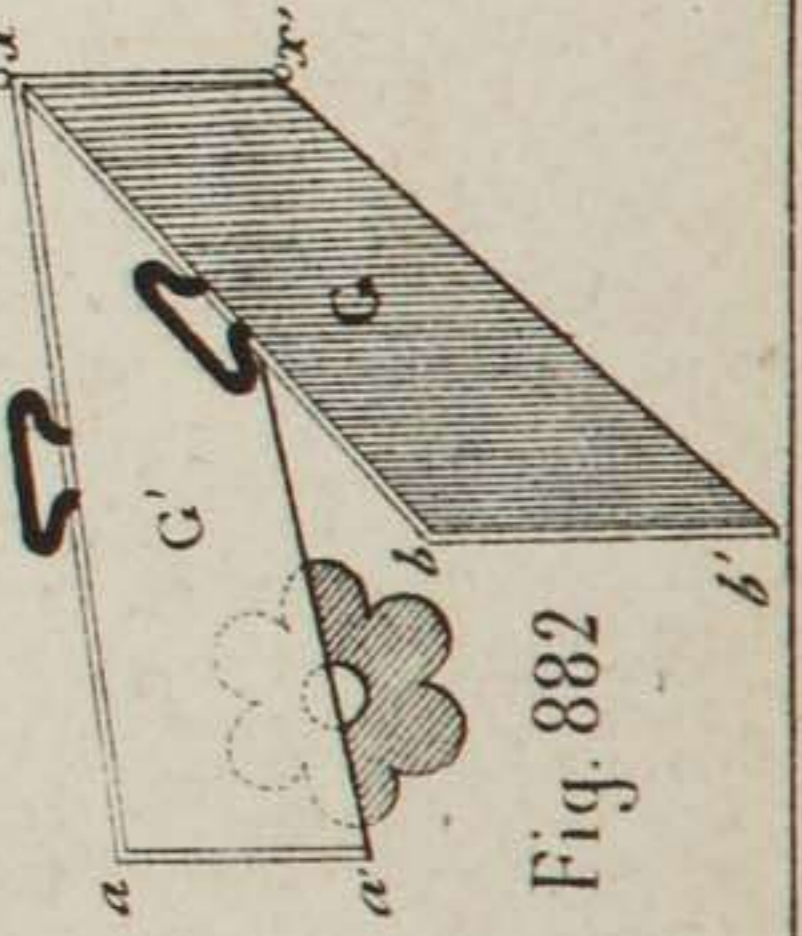


Fig. 883

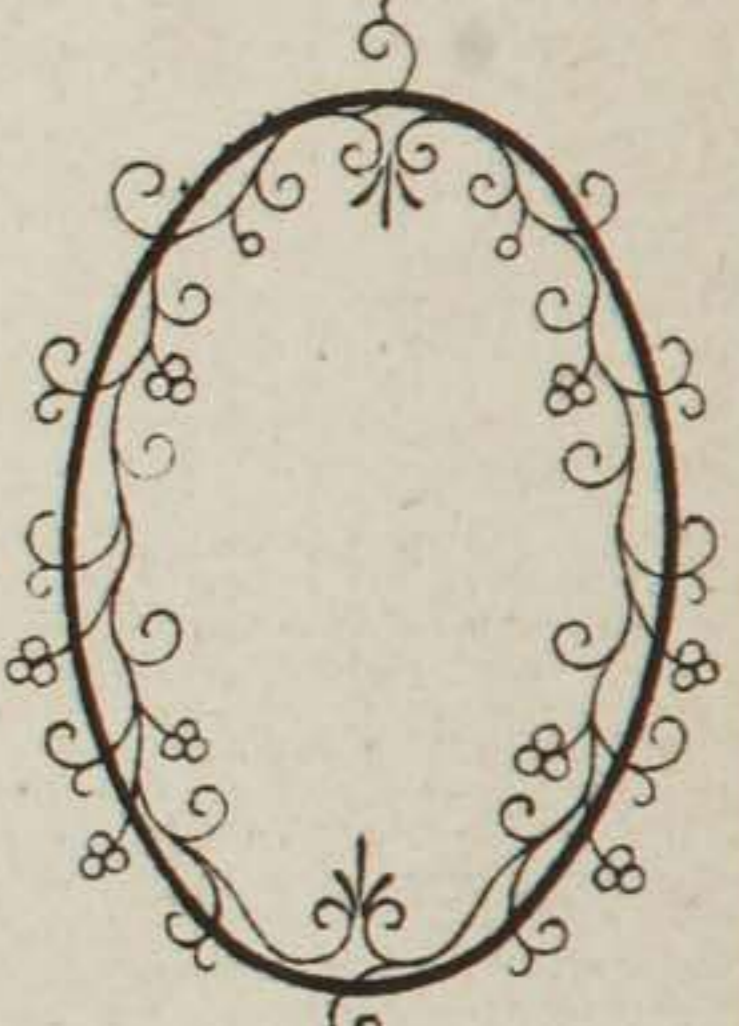


Fig. 885

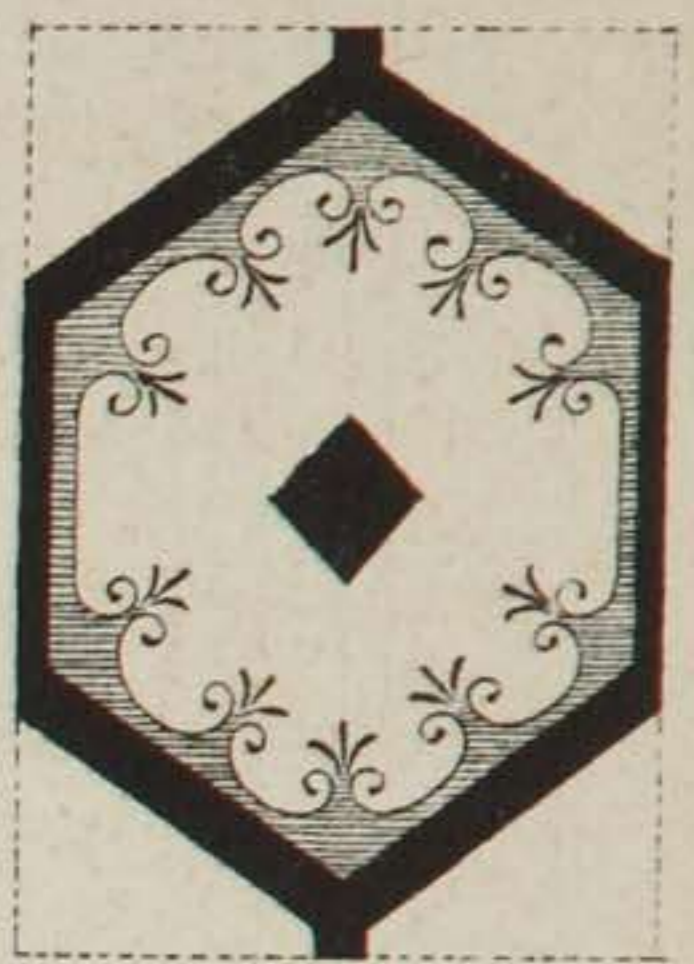


Fig. 886

Fig. 810.

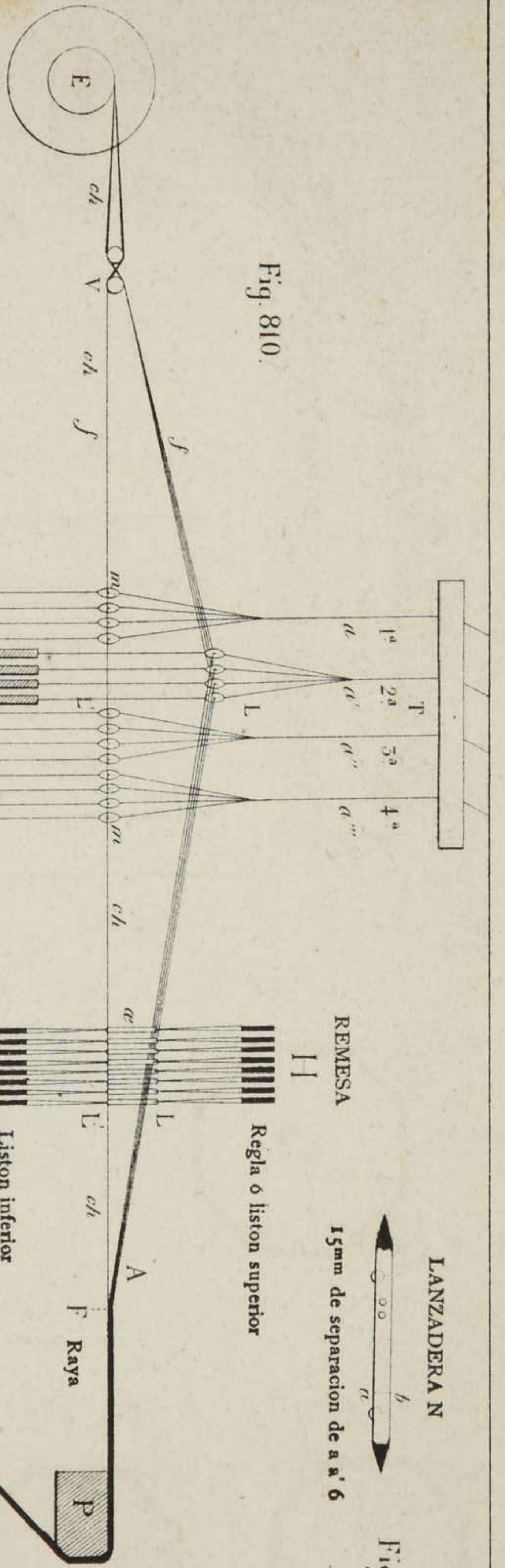
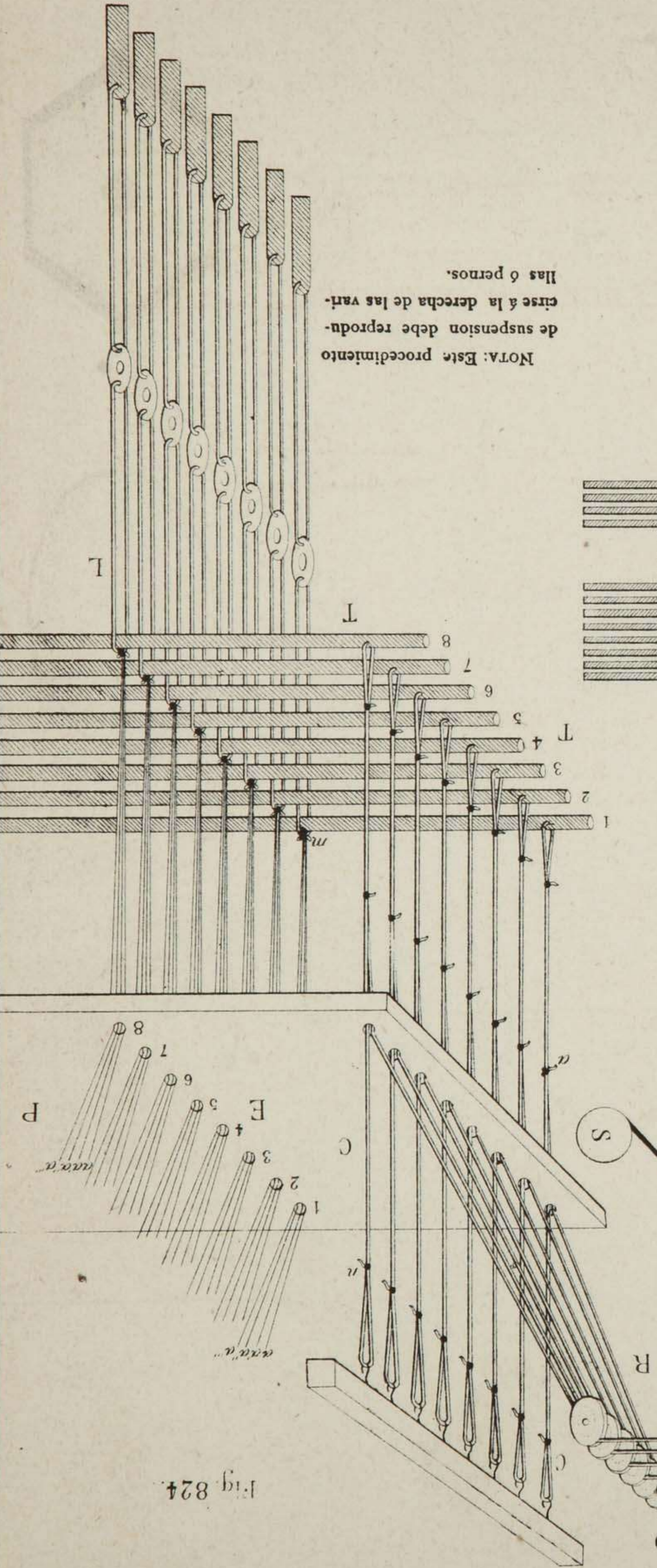


Fig. 815.



NOTA: Este procedimiento de suspension debe reproducirse a la derecha de las varillas 6 pernos.

Fig. 824.

Fig. 891.

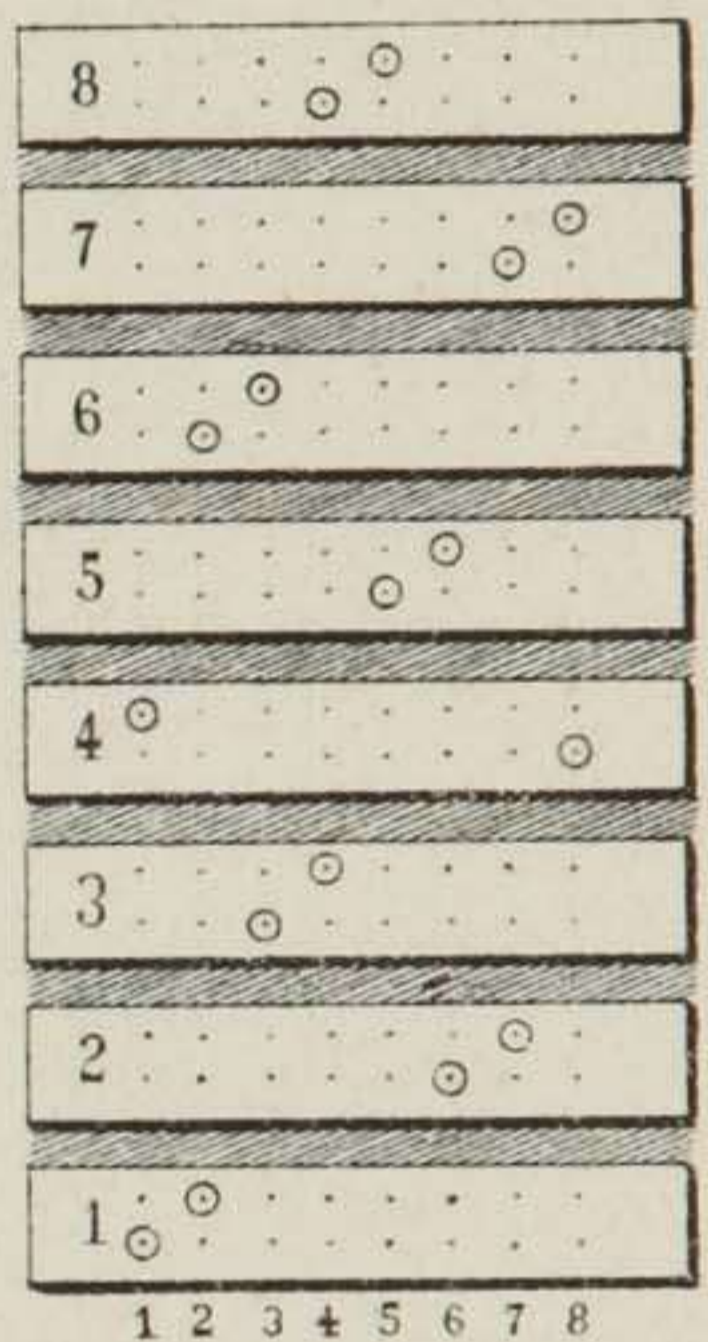
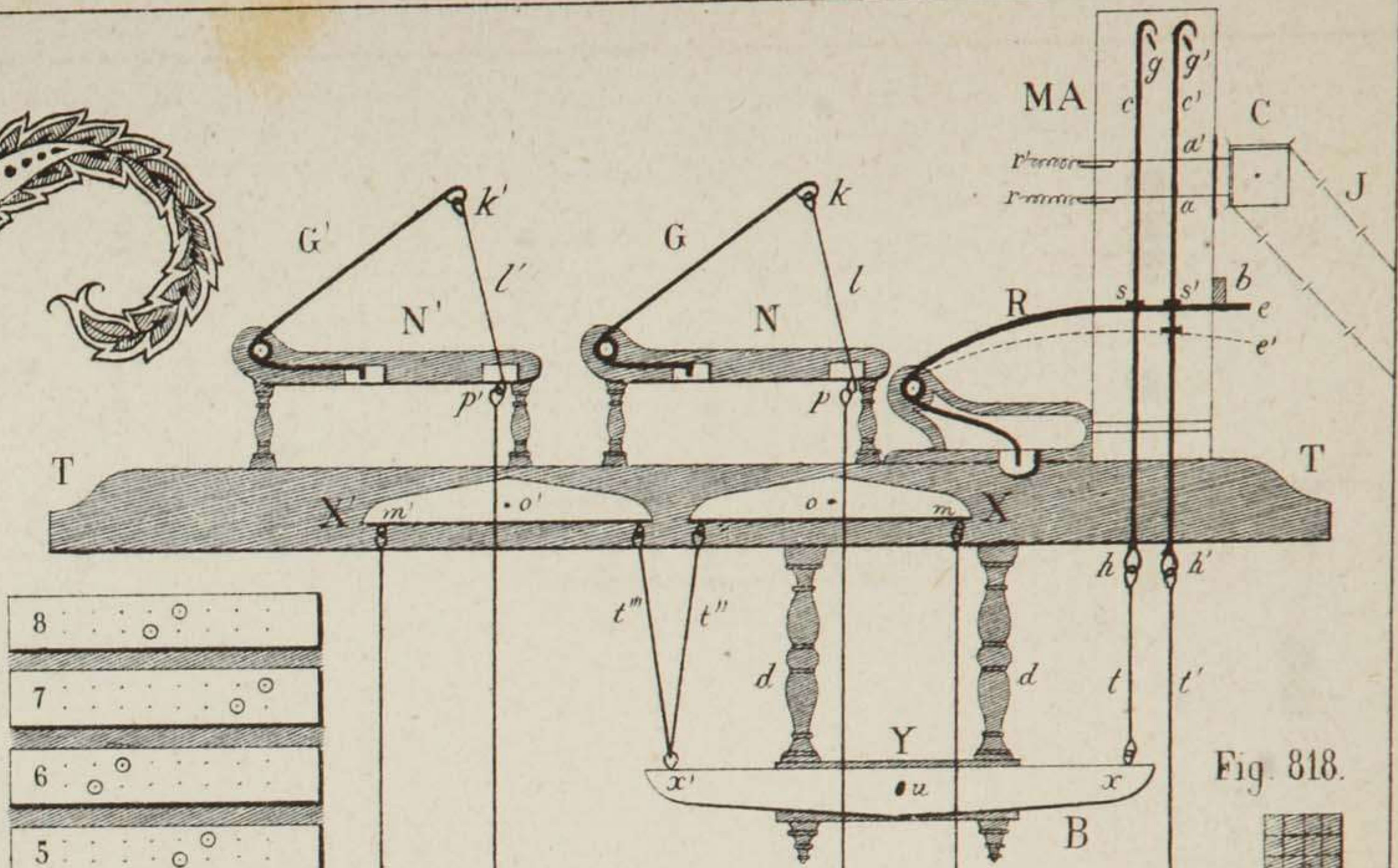


Fig. 817.

Fig. 816.

Lizo L
formando parte
del remetido H

Fig. 818.

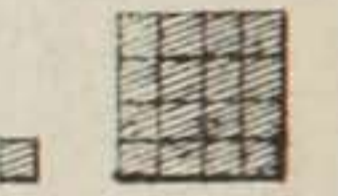


Fig. 819.

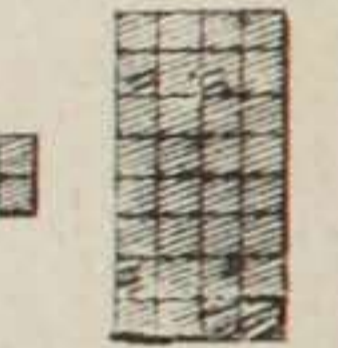


Fig. 820.

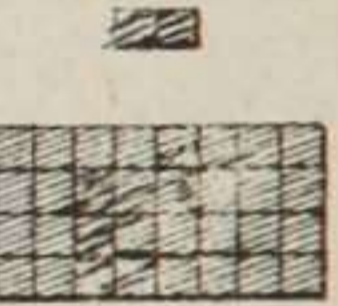


Fig. 821.

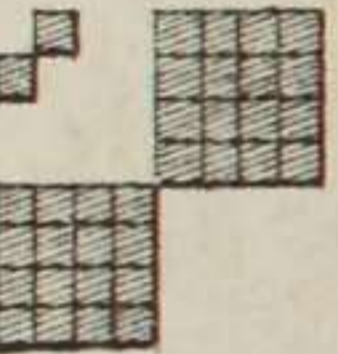


Fig. 822.

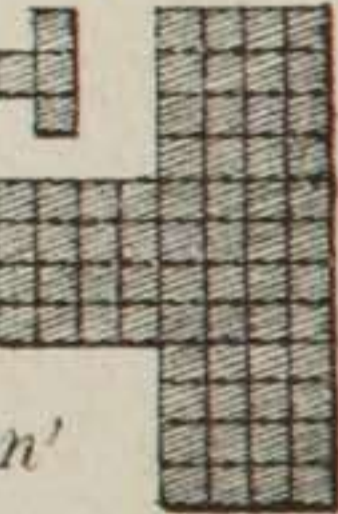


Fig. 886.



f. Hilo en estado de
reposo en una malla α

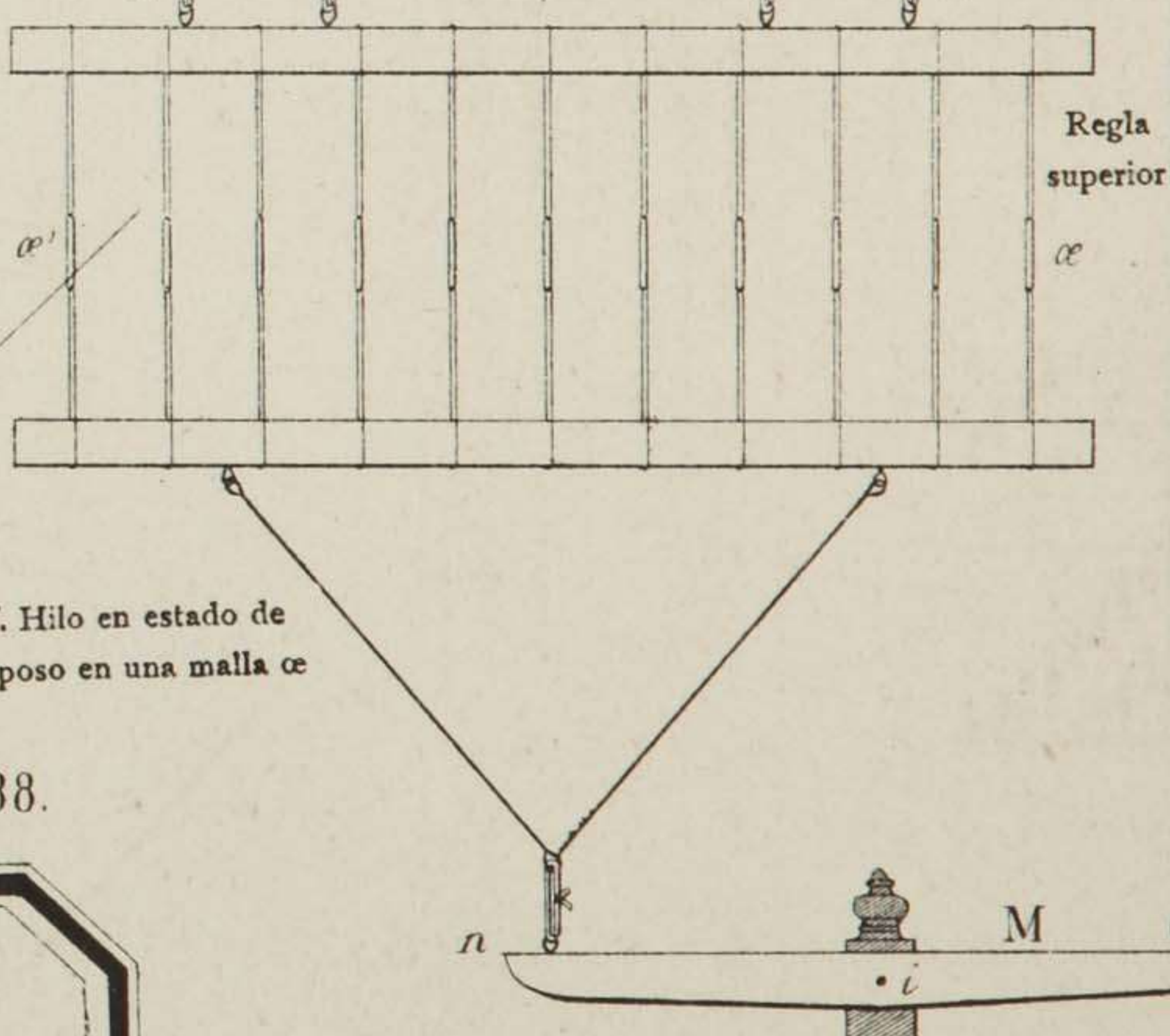


Fig. 889.

Fig. 890.

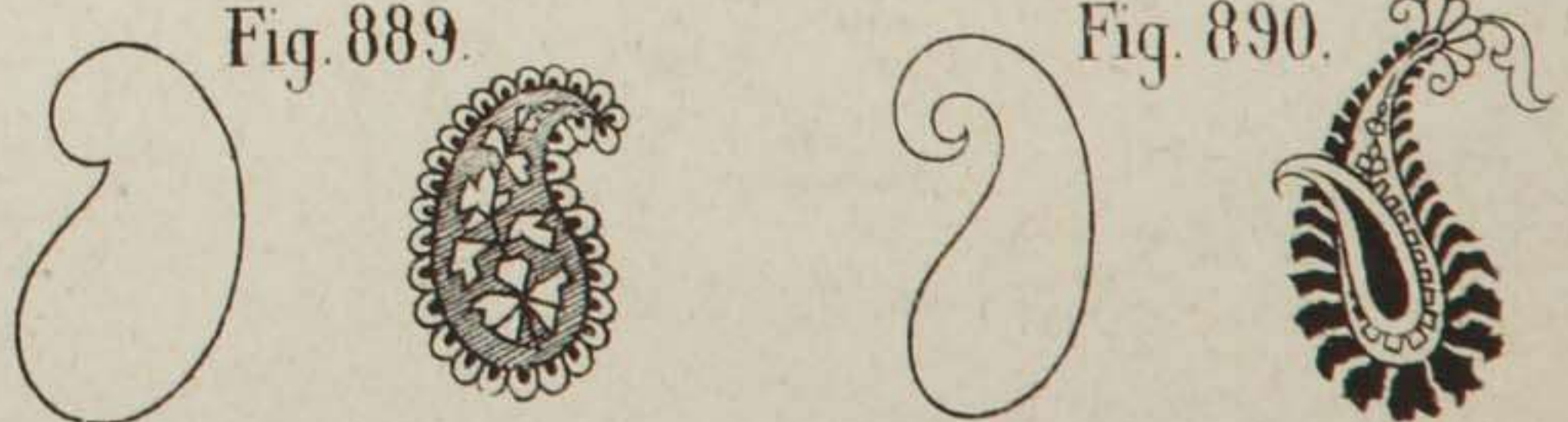


Fig. 887.

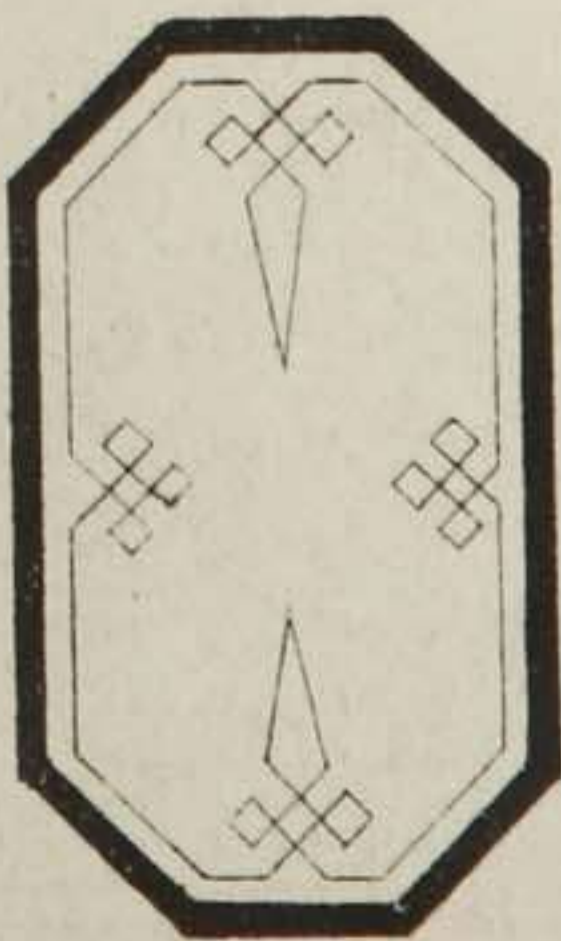


Fig. 888.



PASAR A TABLA QUEBRADA P

Máquina de 100

Máquina de 500

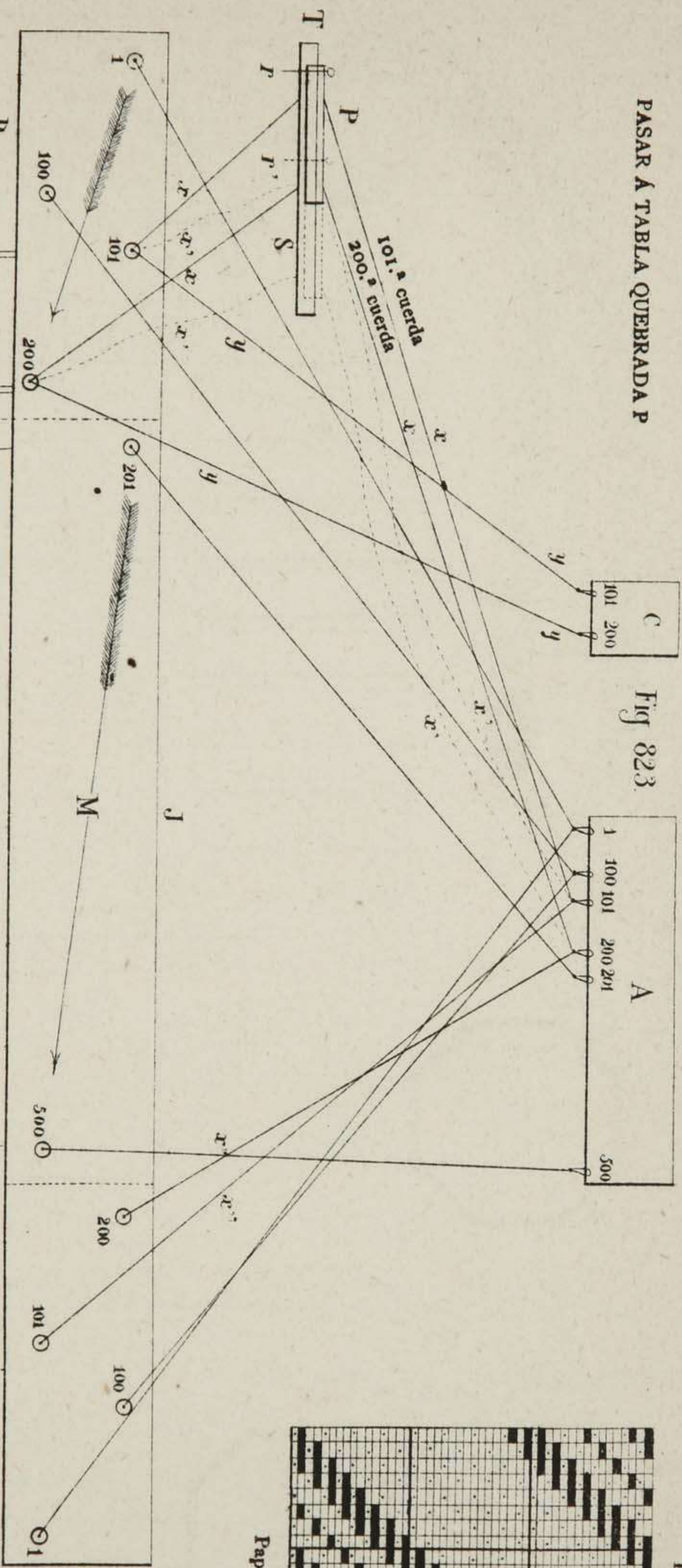


Fig. 823

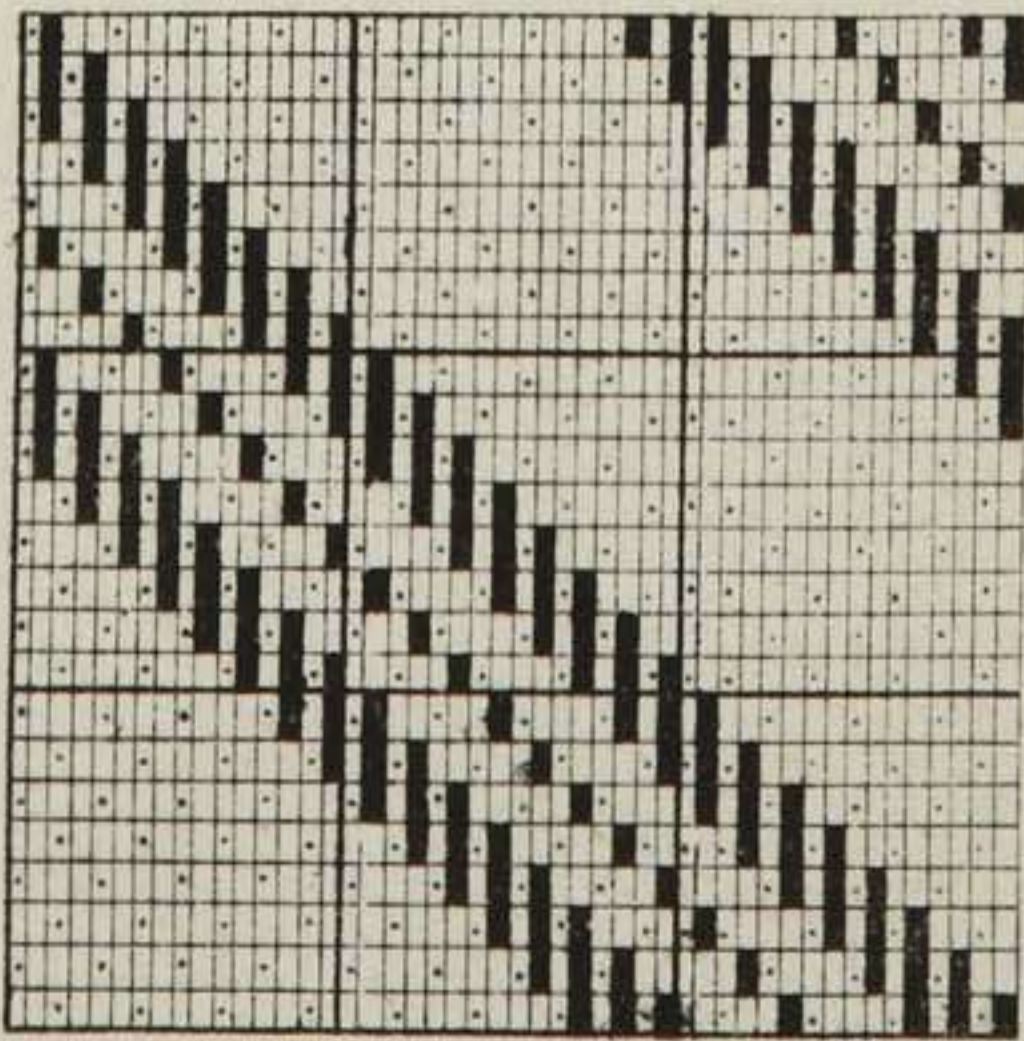


Fig. 828.

Papel 8 en 16

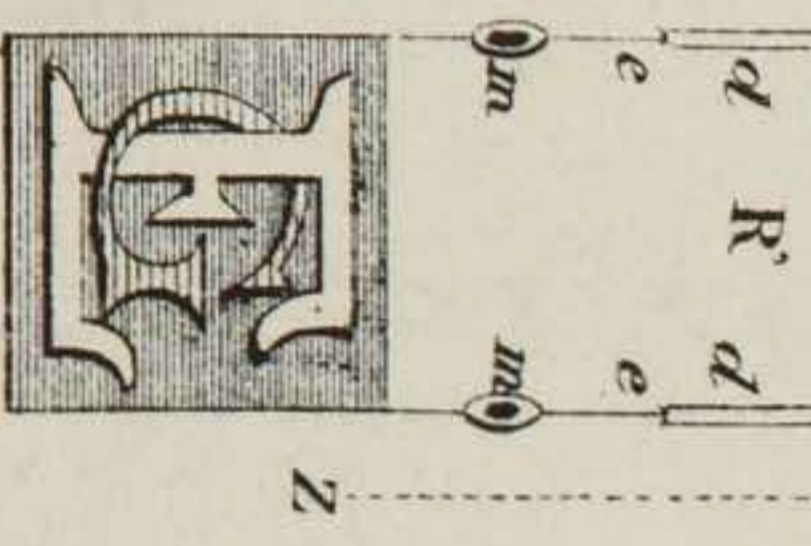


Fig. 827

S Resbalamiento de la tabla móvil P
 Resultado { x 101.^a cuerda que se ha vuelto floja
 { x' 200.^a id. id. id. id.
 así como las cuerdas de 102 á 199 no visibles aquí
 Máquina auxiliar que hace por sí sola las cifras E G
 A 200 ganchos frente (R R') 300 para el centro M

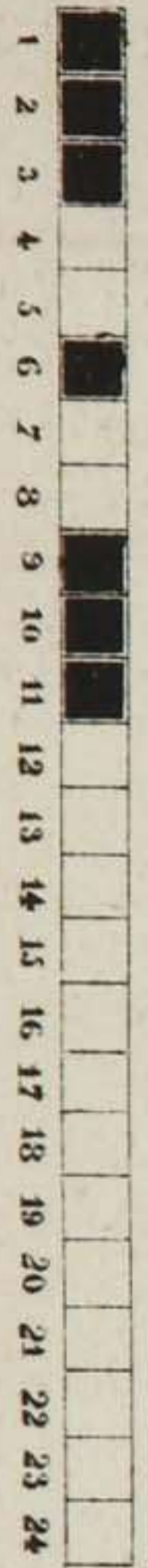


Fig. 825.

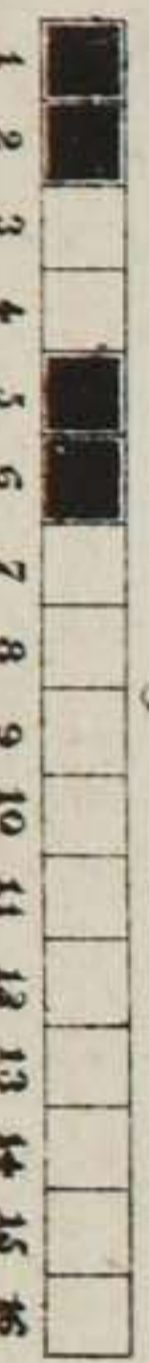


Fig. 826.

Papel 8 en 16



Fig. 892.

Paseo de Orizaba, Aq.

NOTA.—El dibujo pequeño por trama, pasa por todo el fondo y por debajo del dibujo por urdimbre.

PASAR AMALGAMADQ

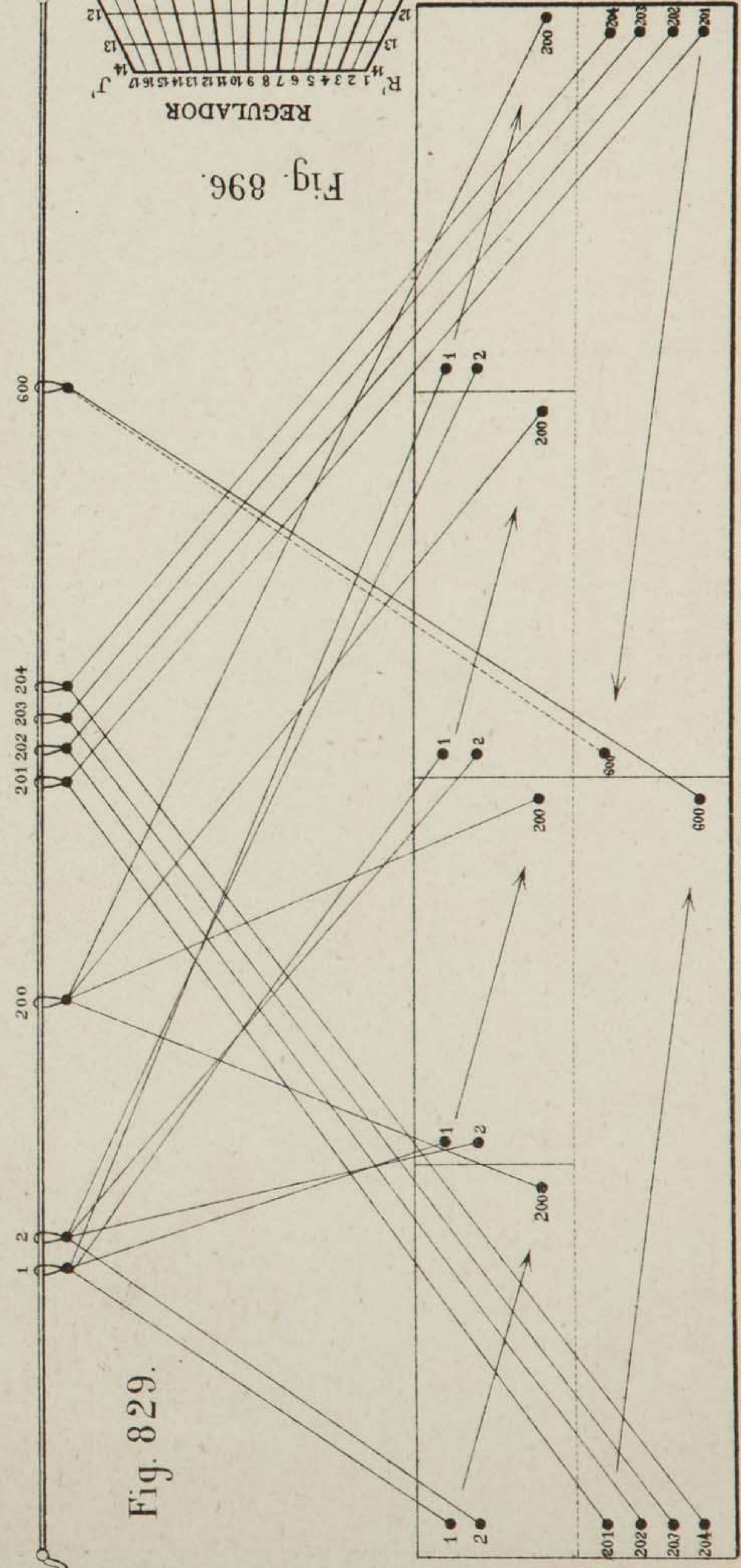


Fig. 829.

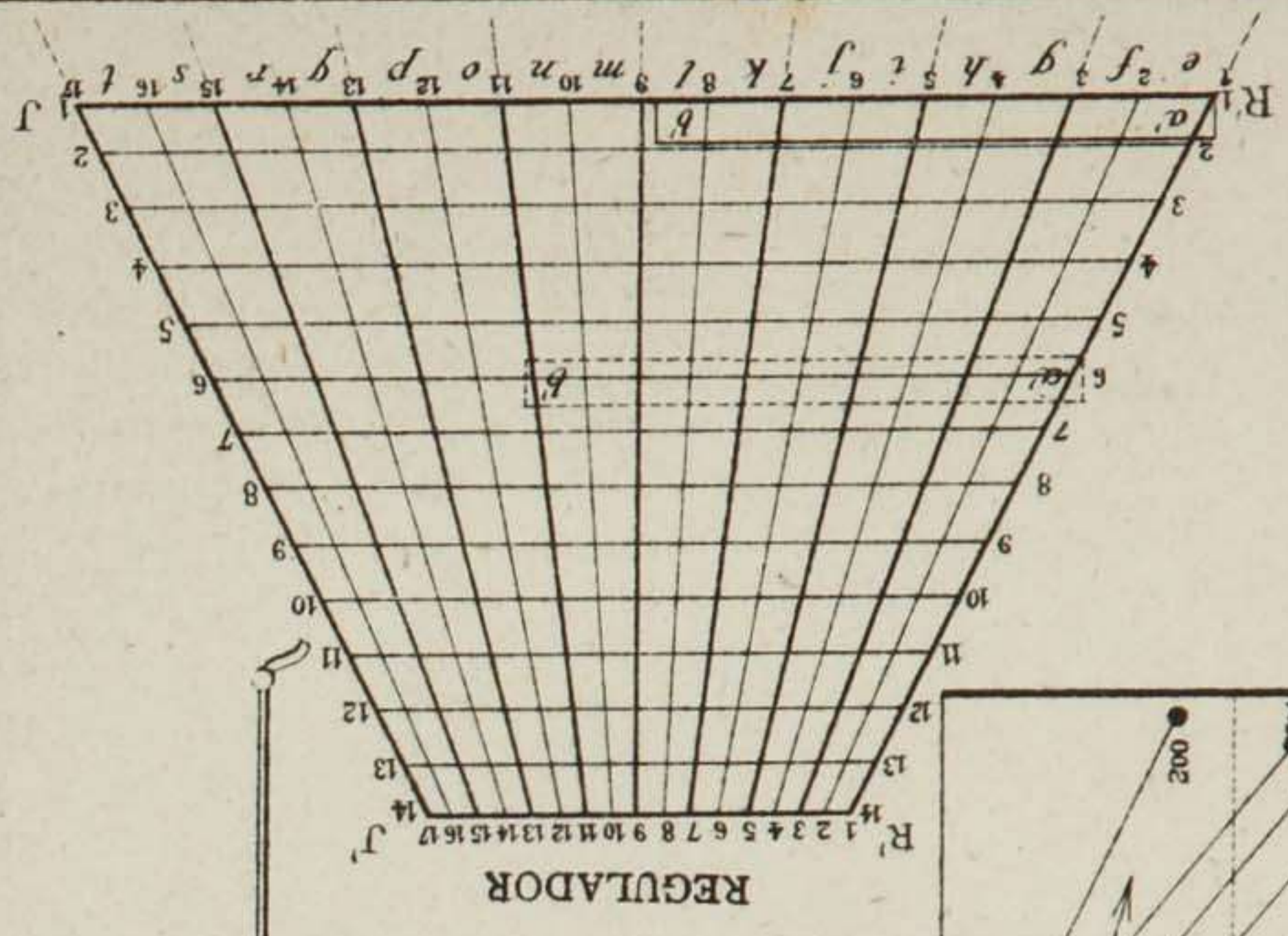


Fig. 896.

REGULADOR

DISEÑO

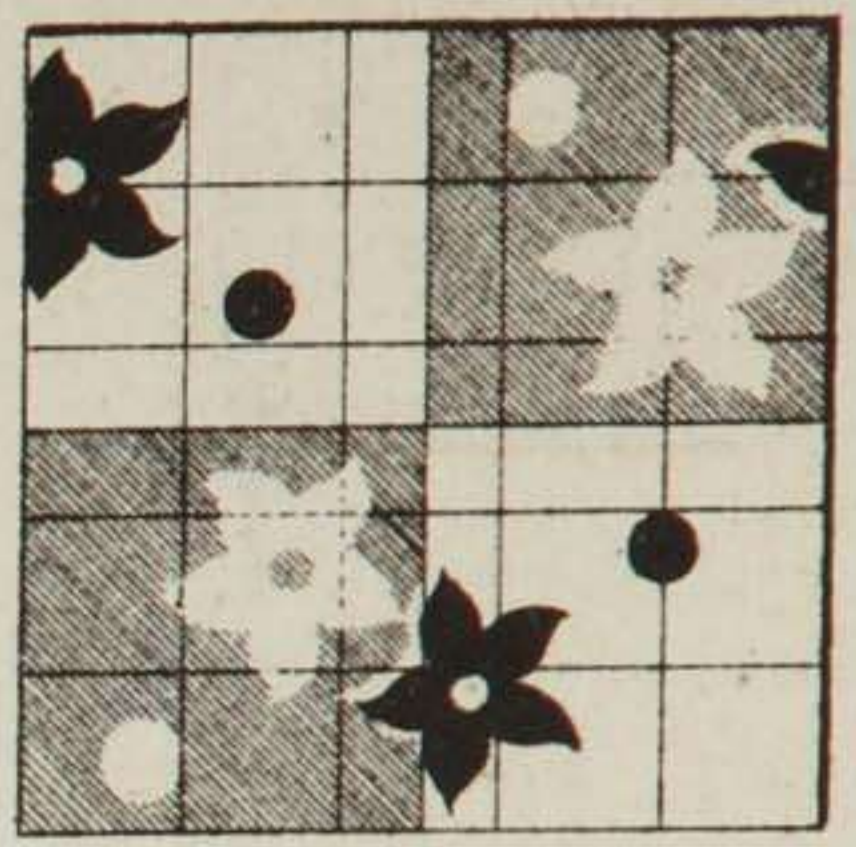


Fig. 894.

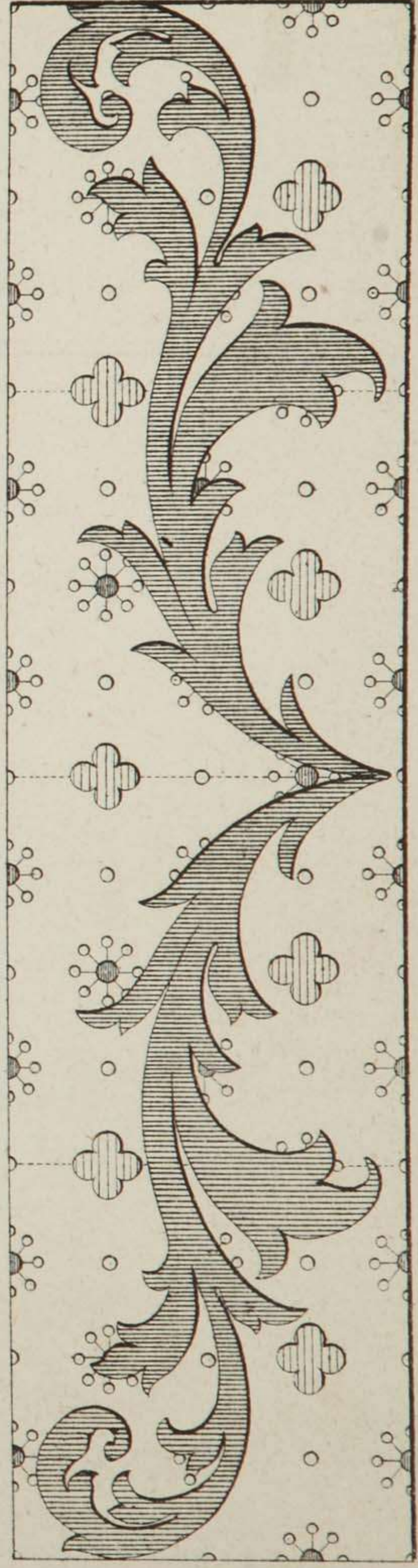
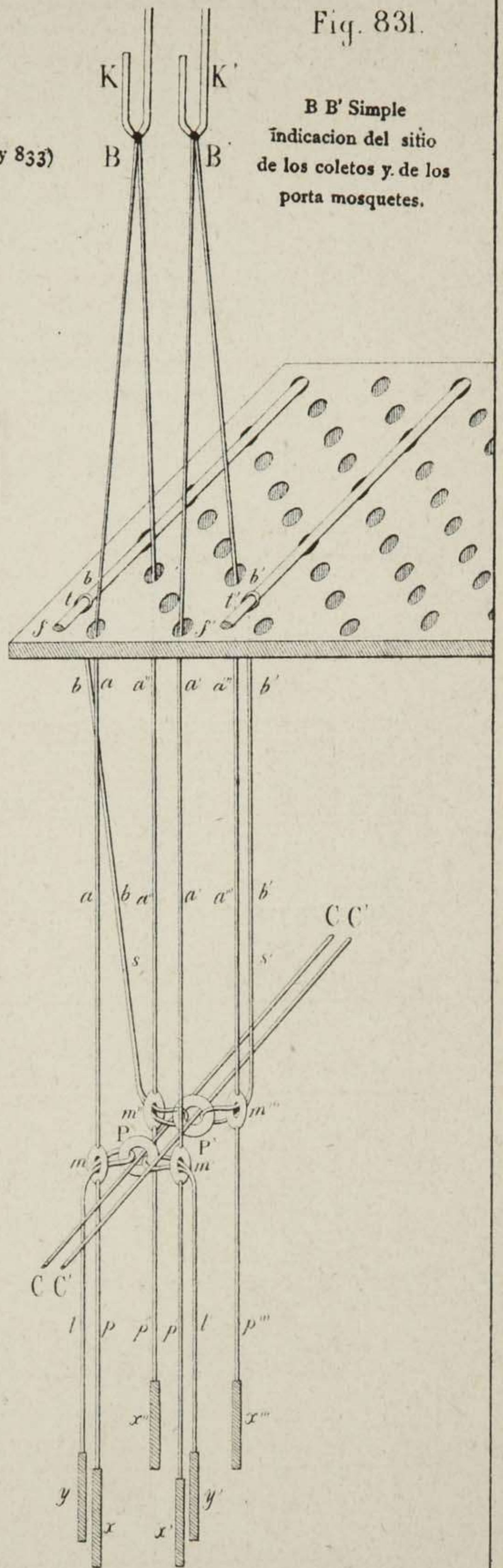
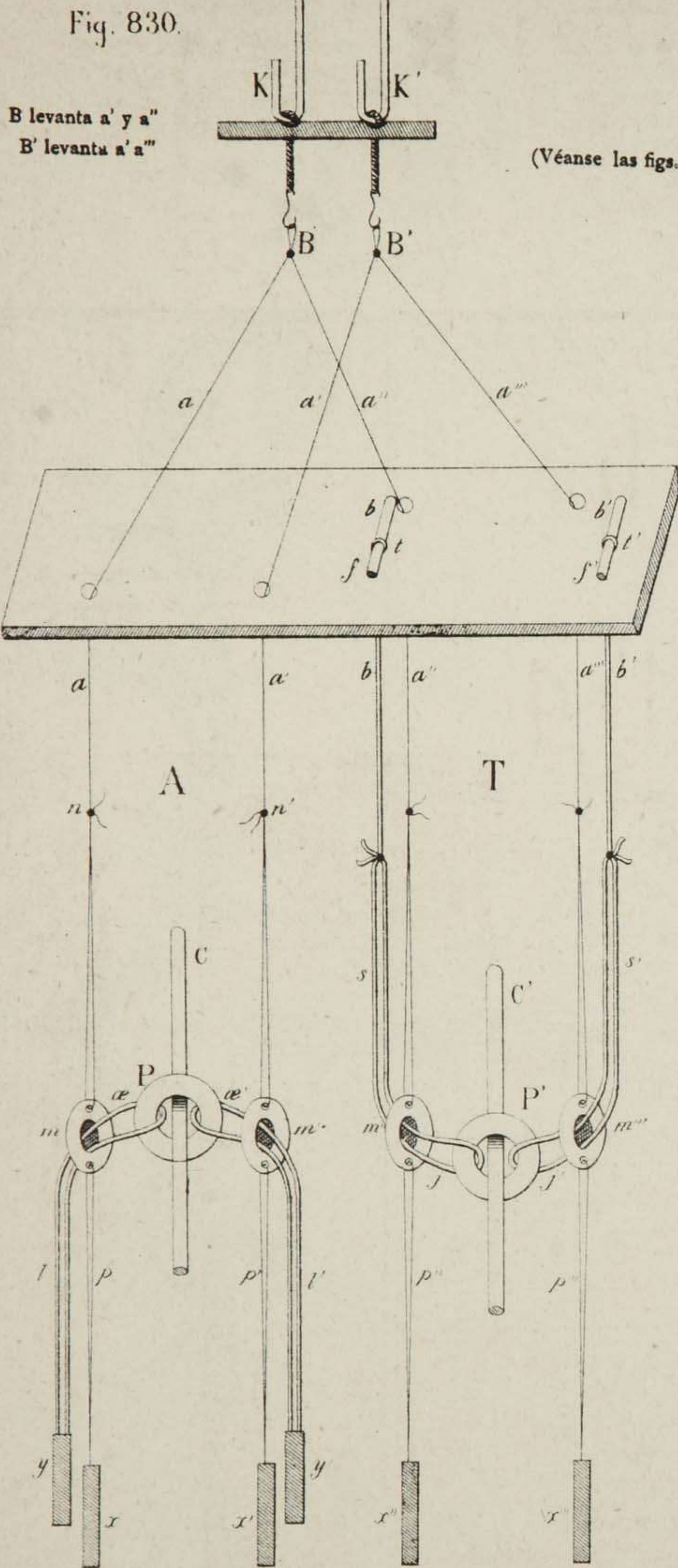
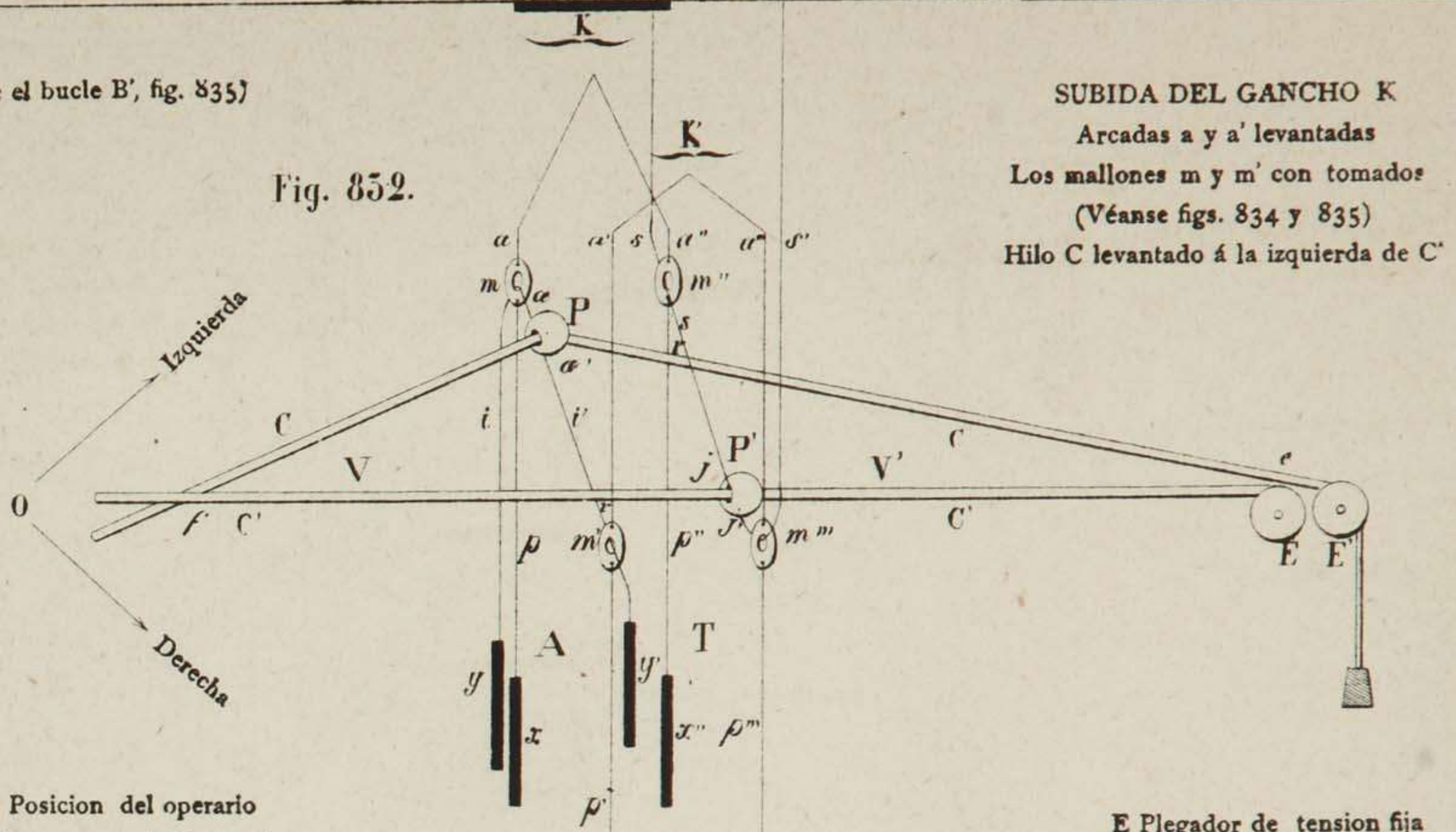


Fig. 897.



(Véase el bucle B', fig. 835)

Fig. 852.



O Posicion del operario
Las flechas representando sus brazos

E Plegador de tension fija
E' Plegador de tension retrógada

Fig. 895.

PUESTA EN CARTA

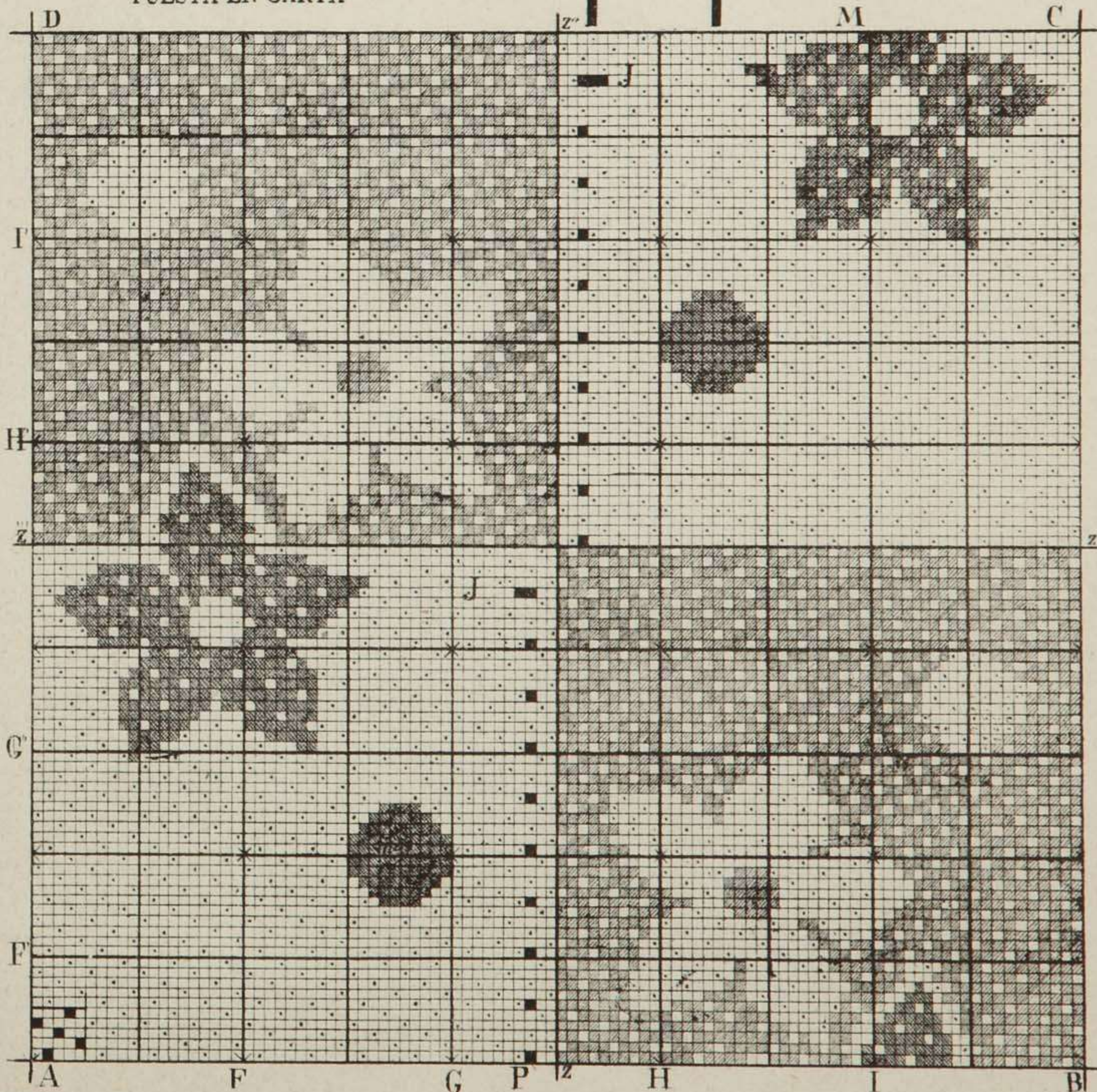
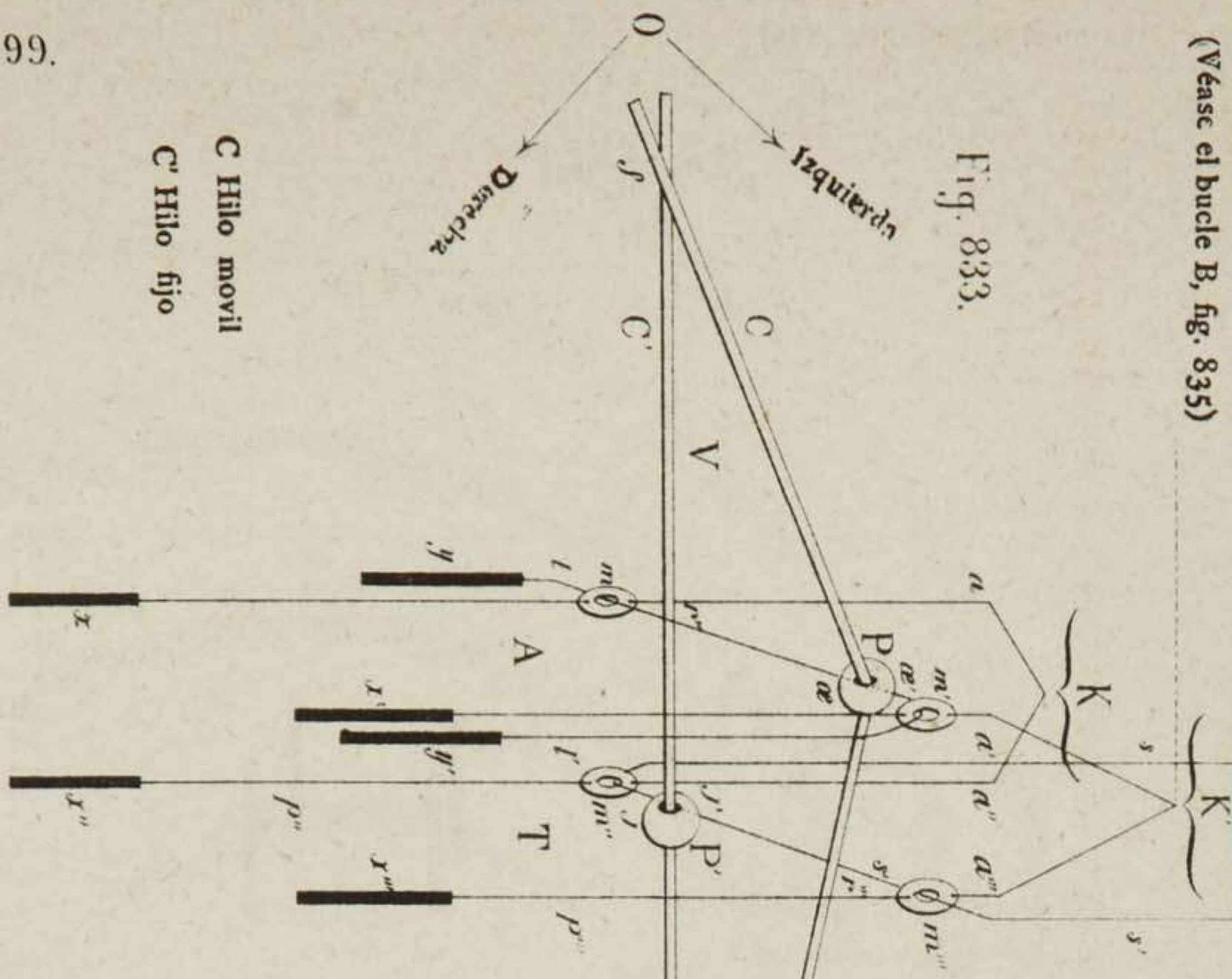


Fig. 888.

(Véase el bucle B, fig. 835)

Fig. 833.



SUBIDA DEL GANCHO K'

Arcadas a' y a levantadas
Los mallones m' y m'' son tomados
Hilo C levantado á la derecha de C'

Fig. 907.

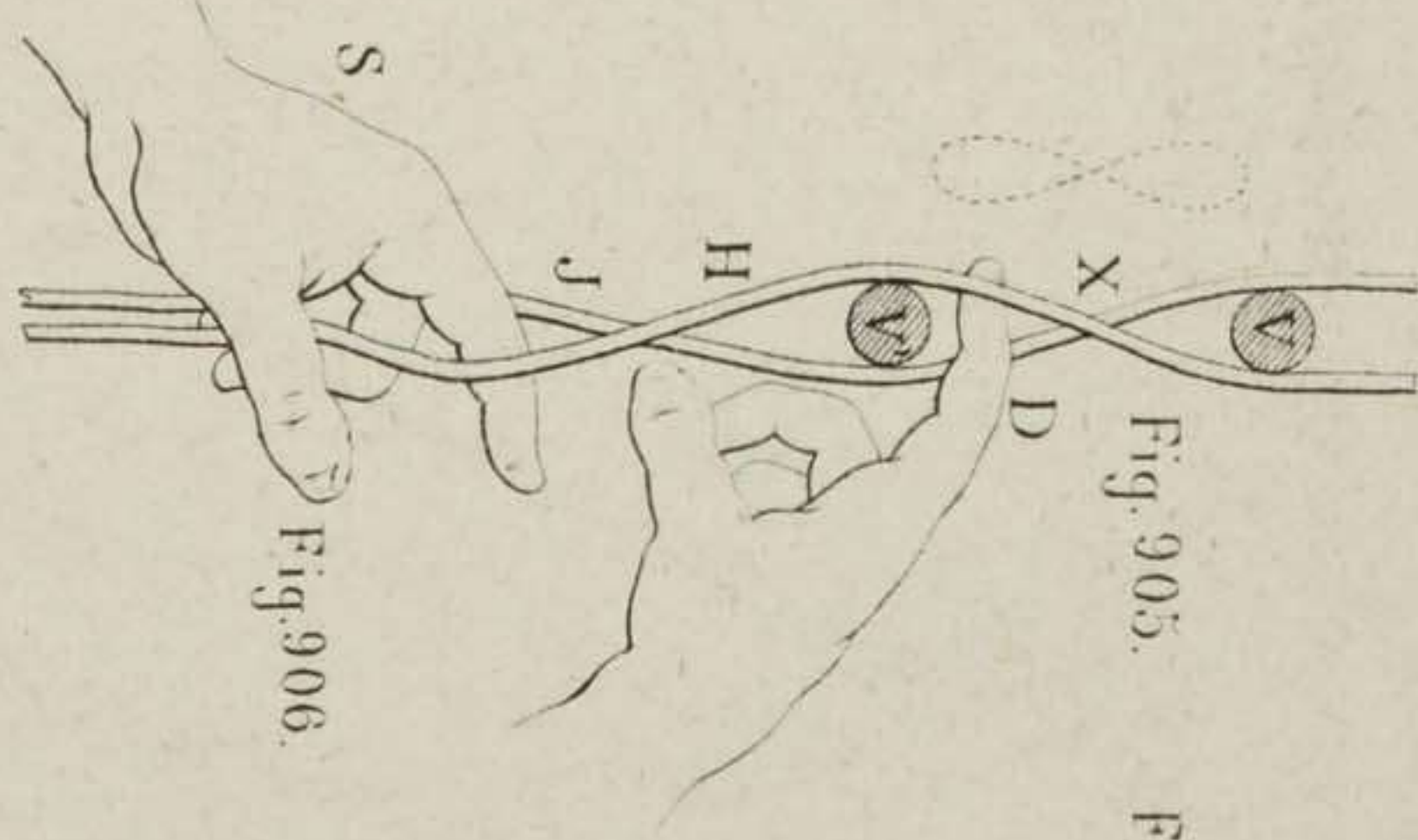
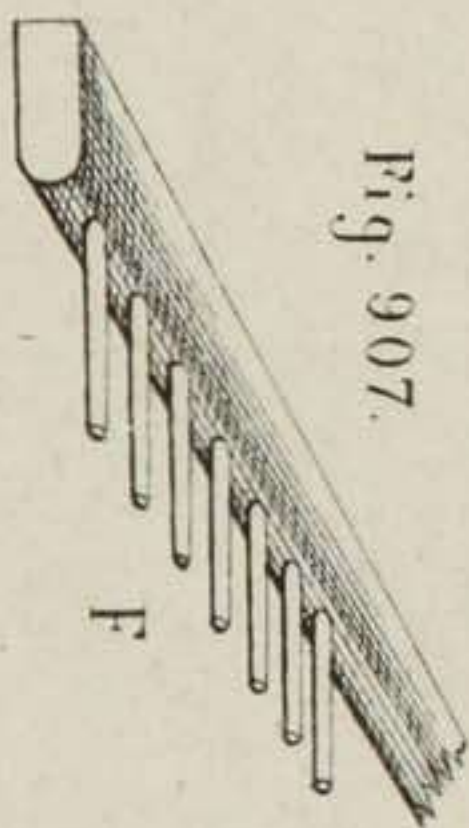
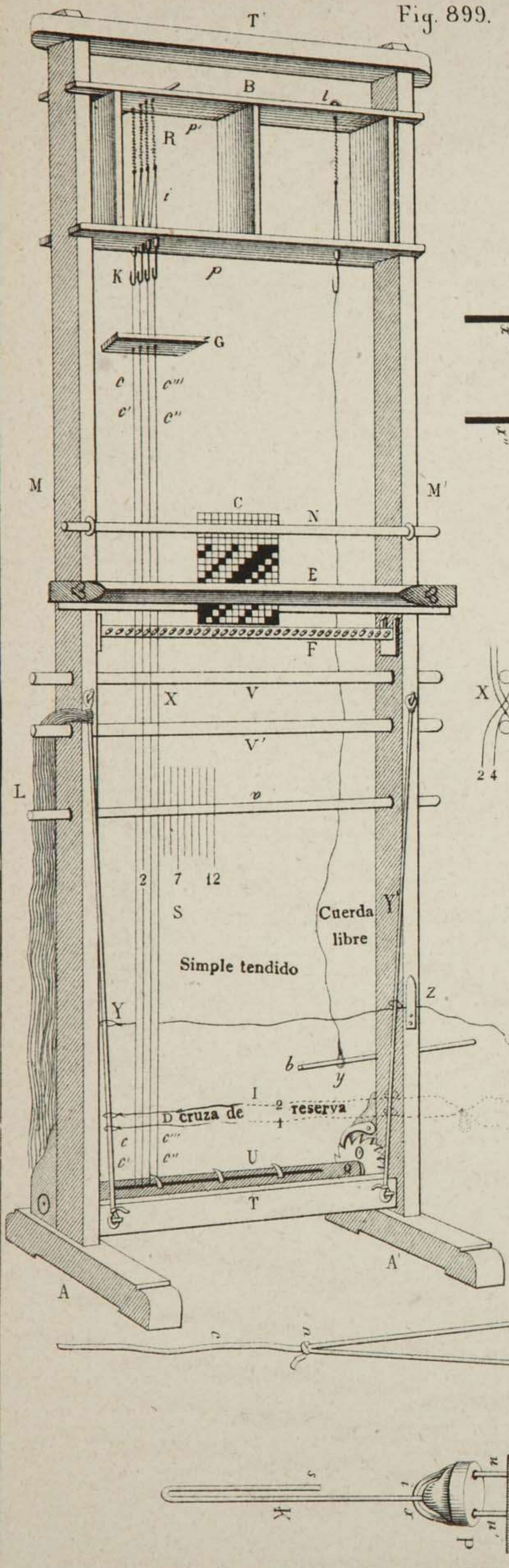


Fig. 905.

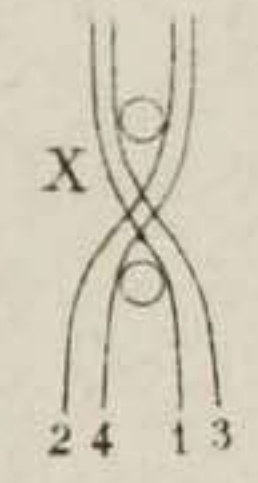
Fig. 904.

Fig. 901.

Fig. 899.



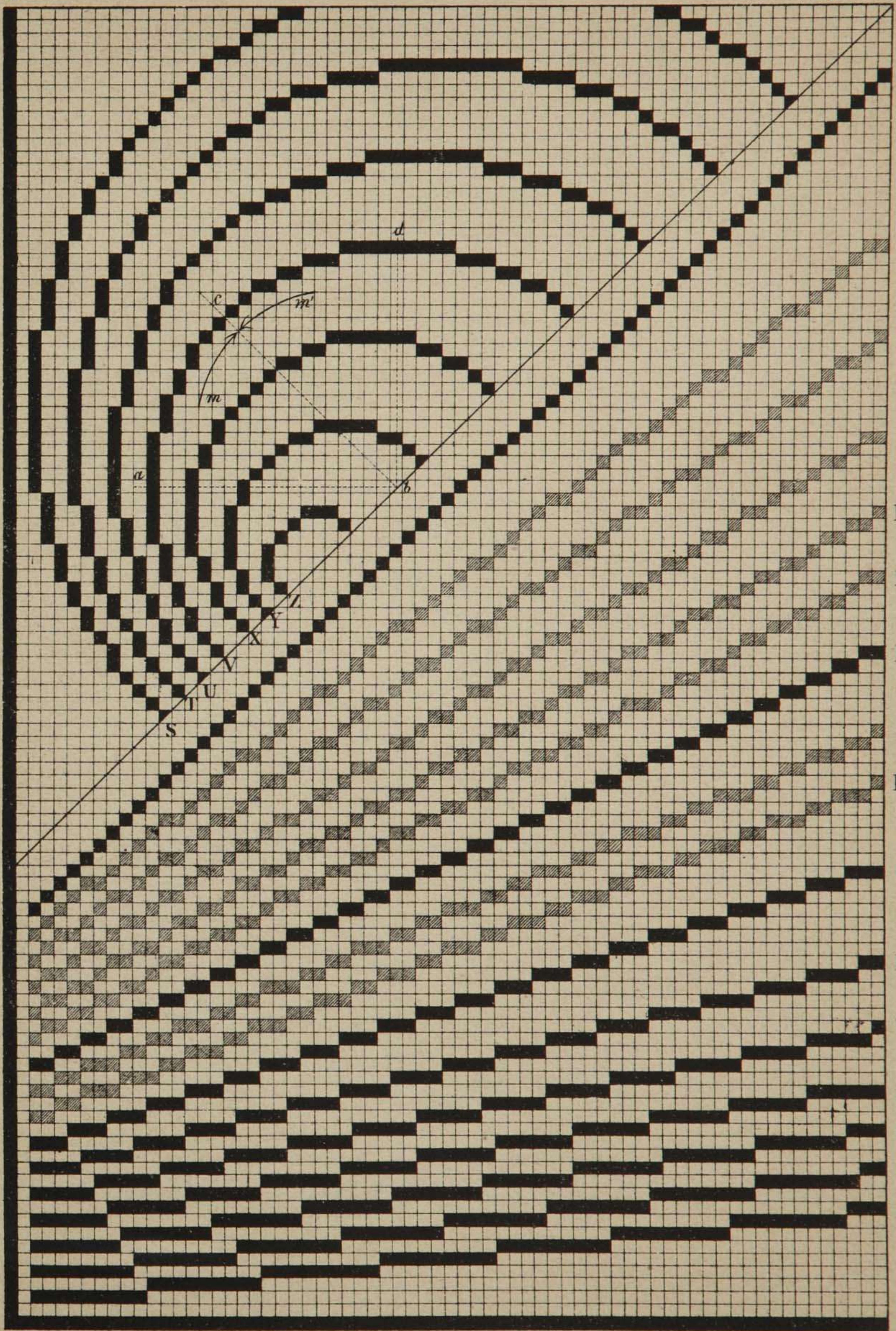
C Hilo movil
C' Hilo fijo



VARIOS ESCALONADOS—OBLICUOS Y CURVOS

Fig. 893.

J'



Q
P
O
N
M
L
K
I
H
G
F
E
D
C
B
A
R

J

Q'
P'
O'
N'
M'
L'
K'
I'
H'
G'
F'
E'
D'
C'
B'
A'
R'

Fig. 900.

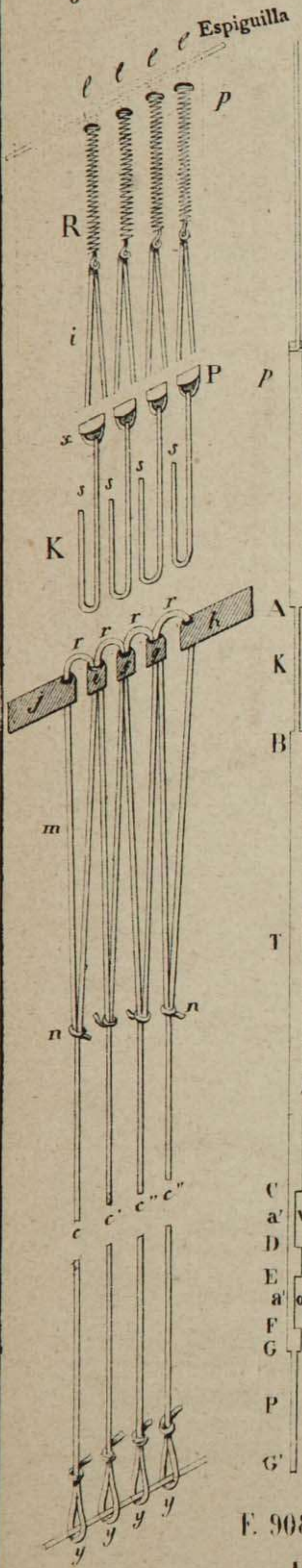


Fig. 904.

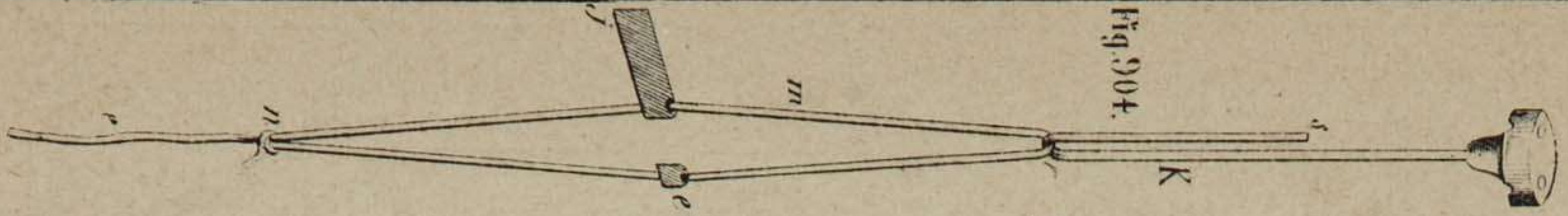


Fig. 905.

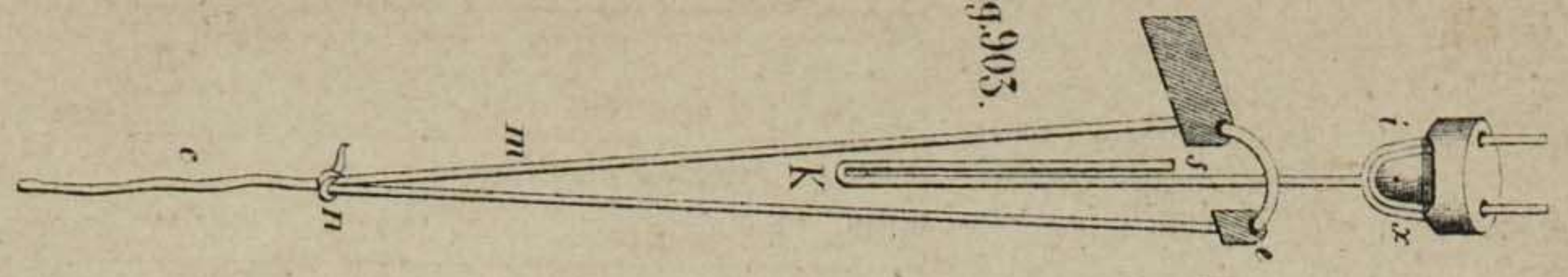
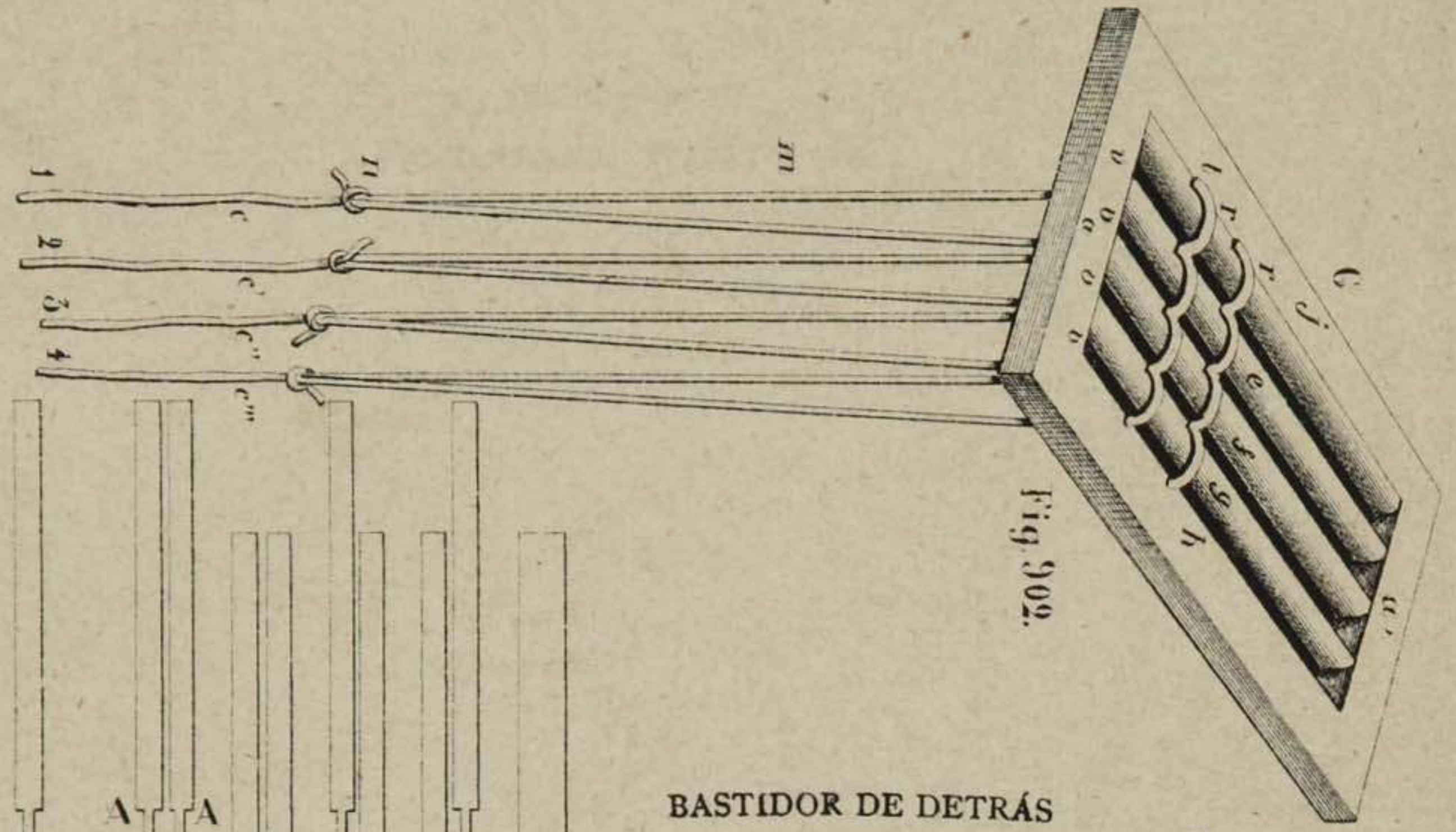


Fig. 909.



BASTIDOR DE DETRÁS

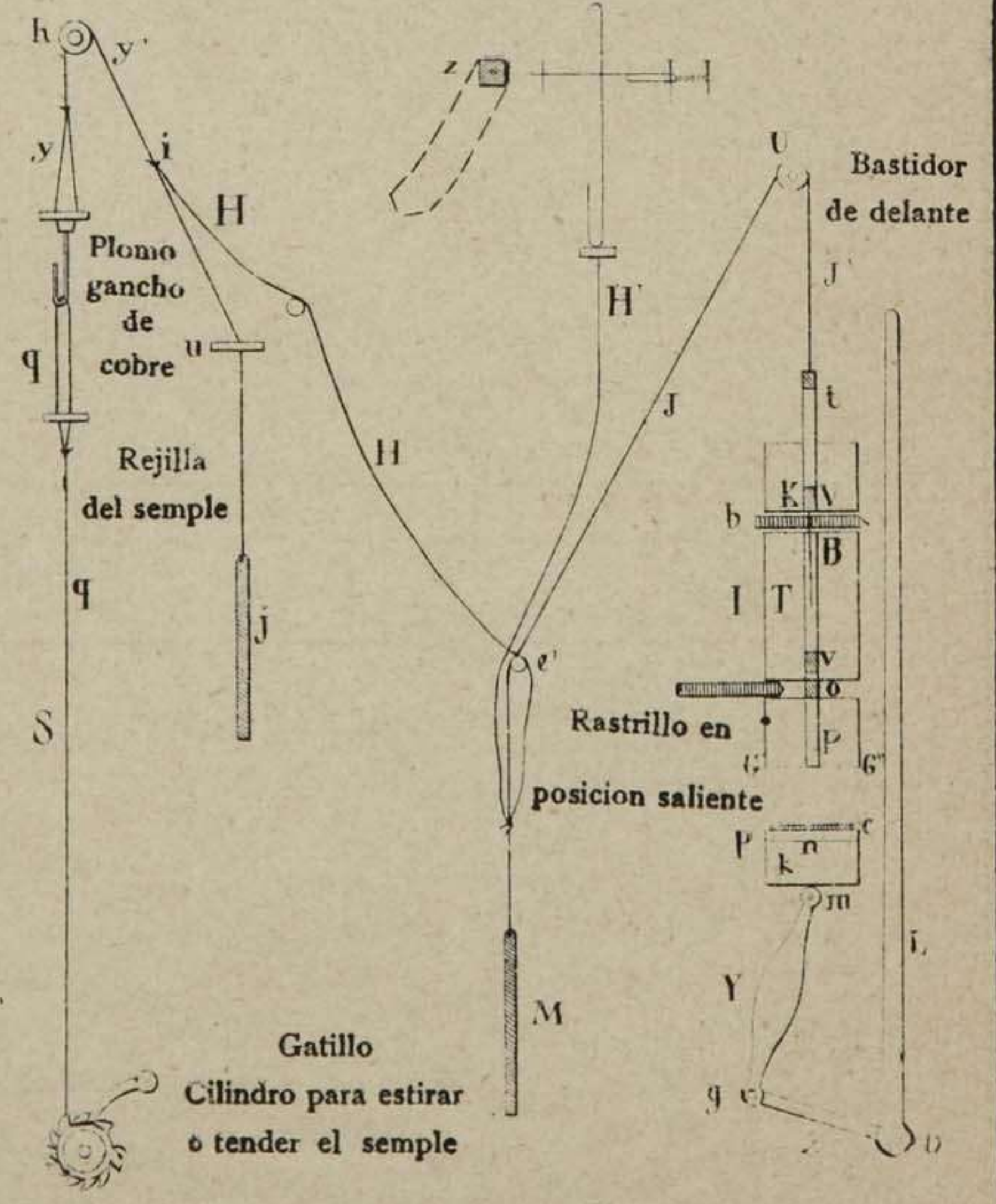


Fig. 916.

F. 908. F. 909. F. 910.

1/2 tamaño

F. 911. F. 912. F. 915. F. 914.

Surco de izquierda á derecha

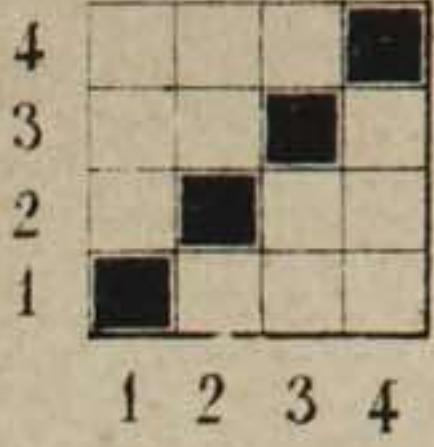
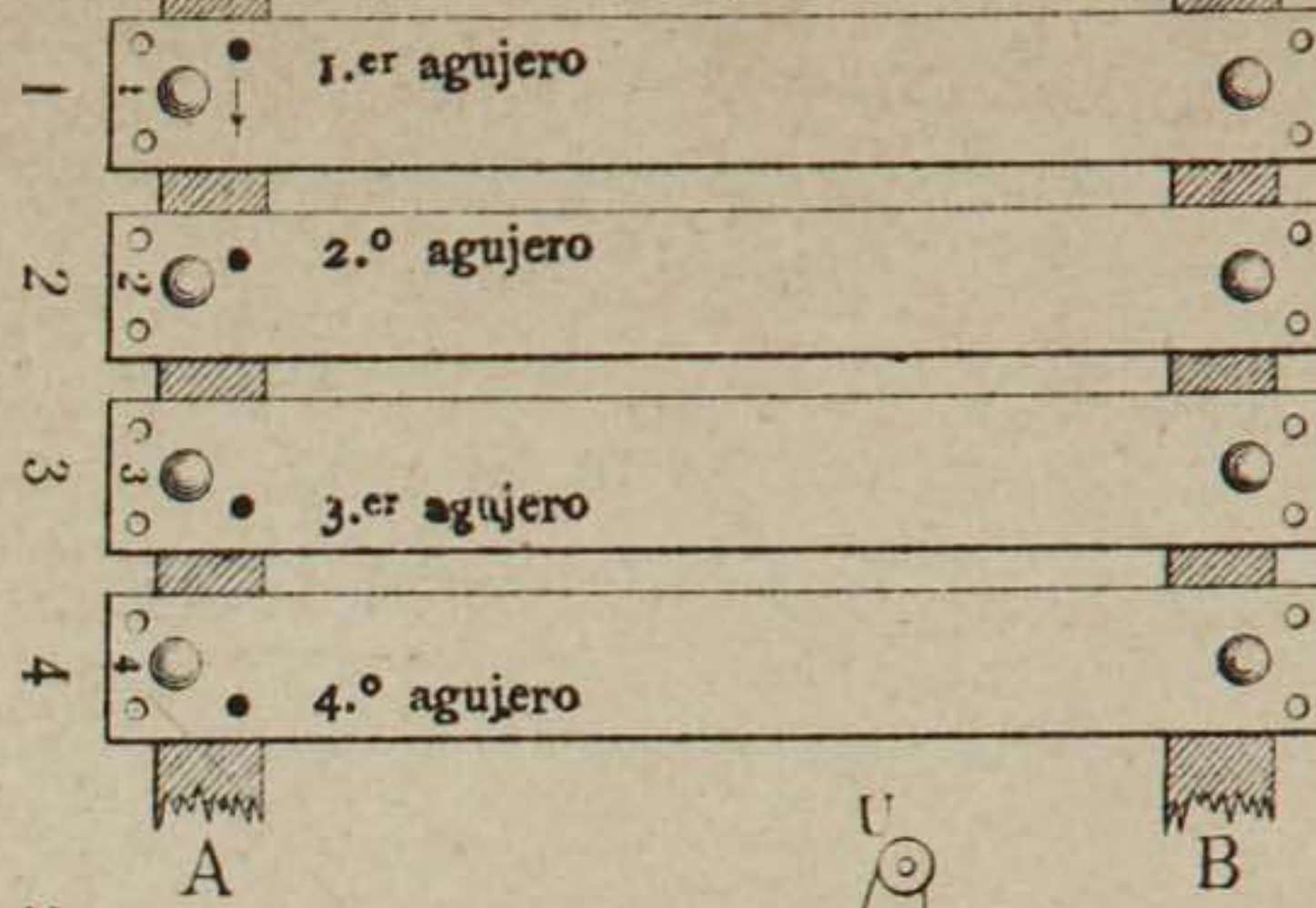


Fig. 923.

Fig. 919.



GRAN LISAJE ACELERADO

Rejilla del simple

Fig. 916.

Rastrillo introducido

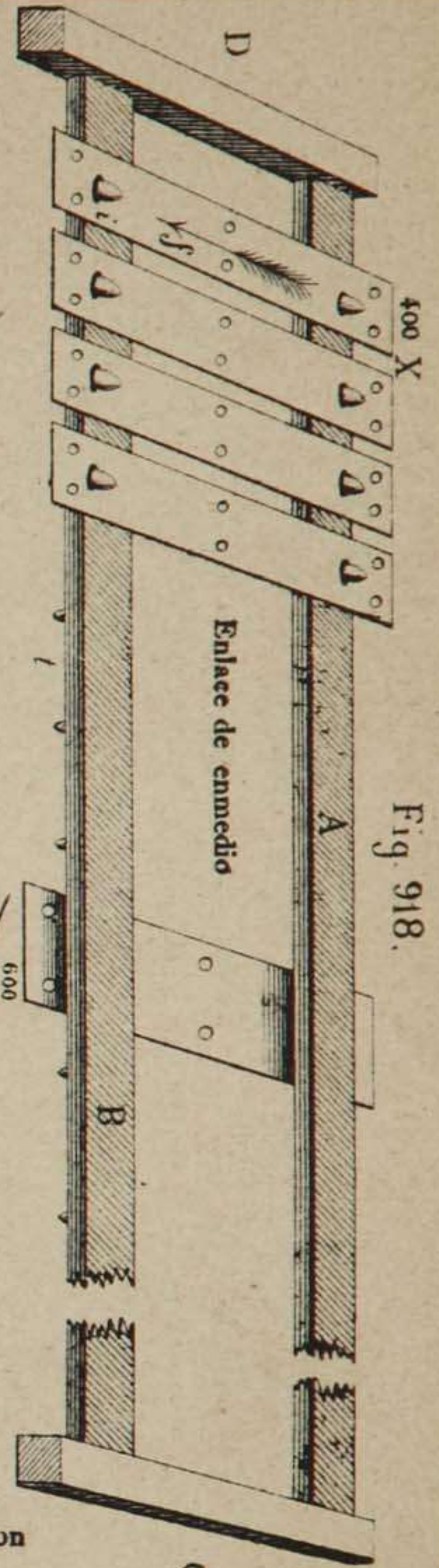


Fig. 918.

Punzon U

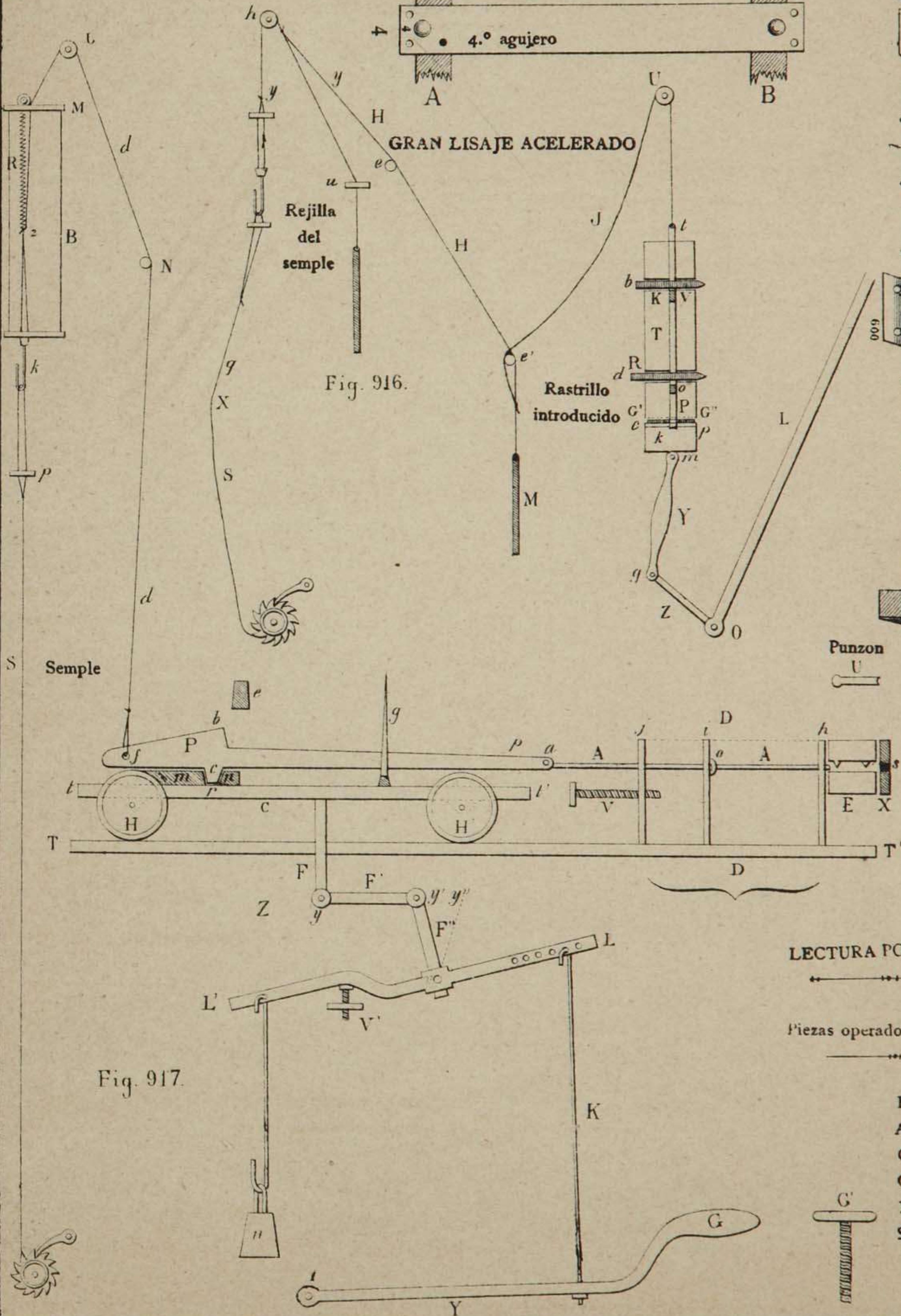


Fig. 917.

LECTURA POR CARRO

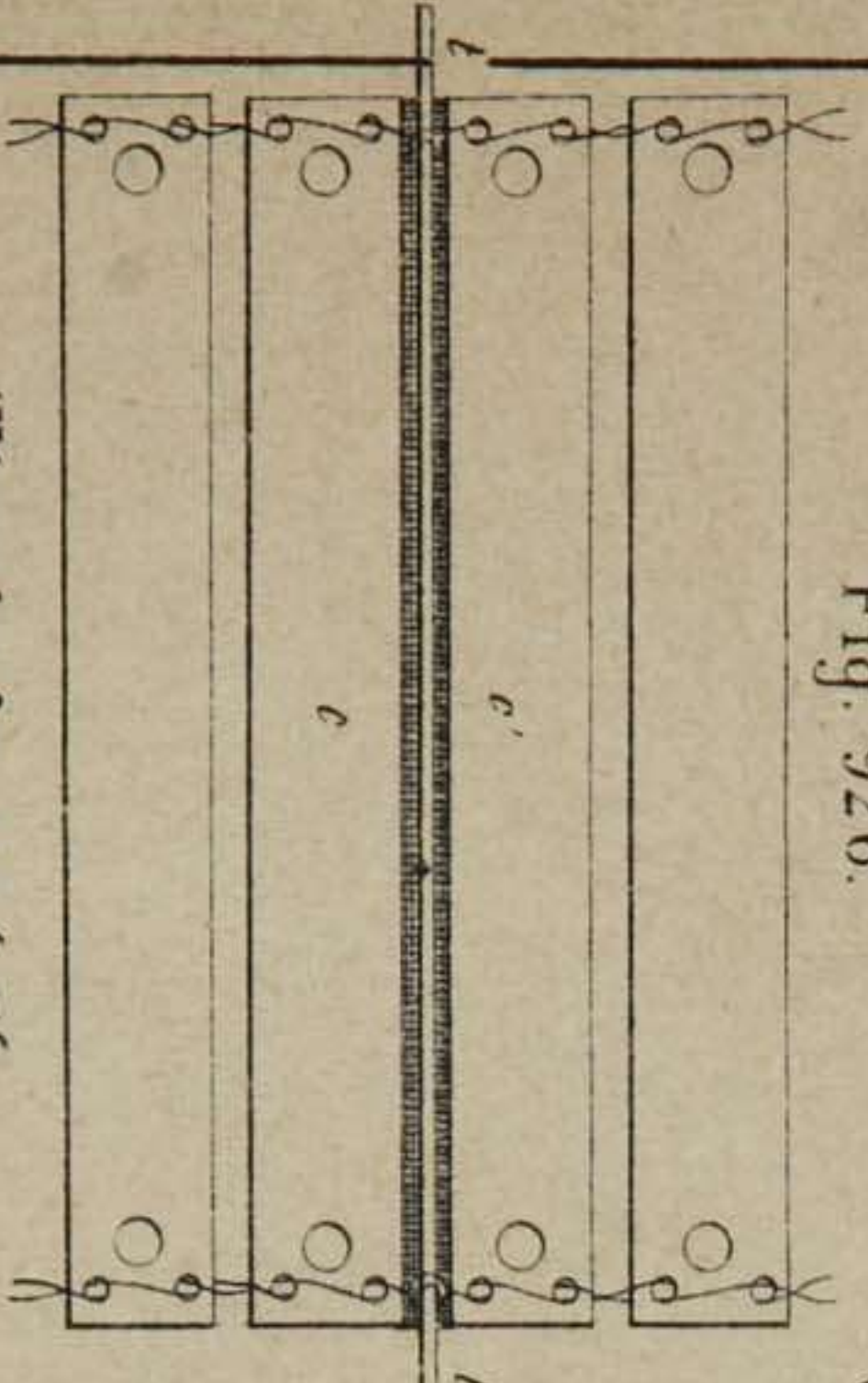
Piezas operadoras movibles

- P Platina
- A Aguja repelente
- C Carro
- G Pedal
- X Placa receptora volante
- S Semple

Fig. 929.



Fig. 926.



(Véanse las figs. 252 á 256 para enlazado)

Surco de derecha á izquierda

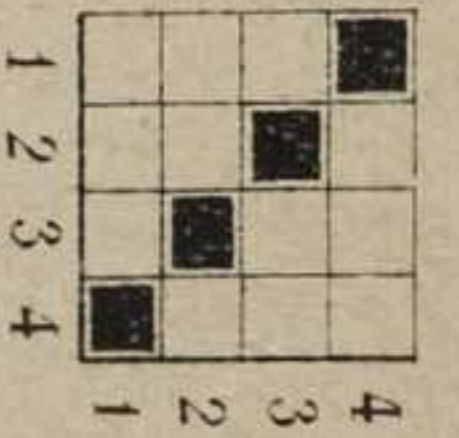


Fig. 924.

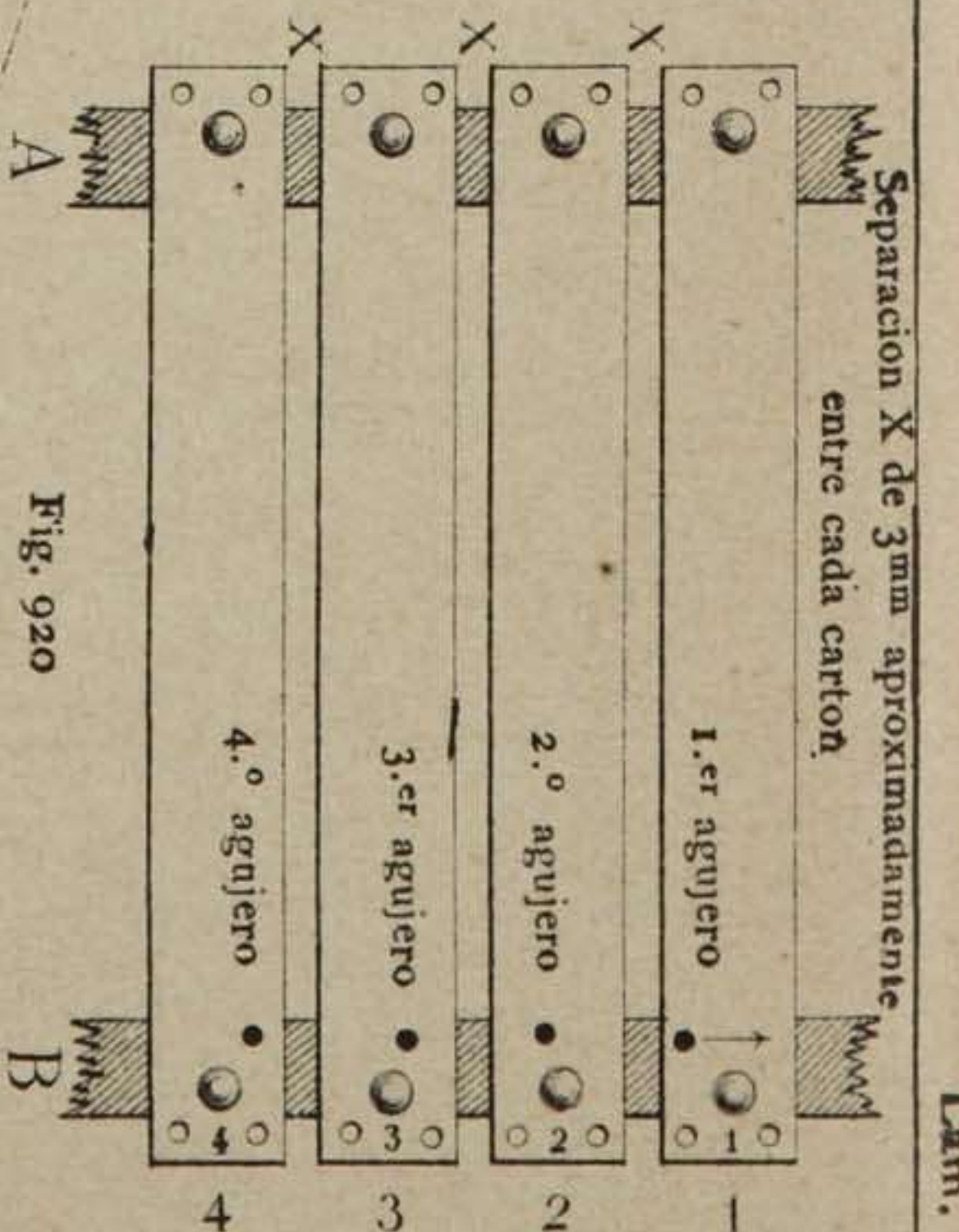


Fig. 920

Fig. 925.

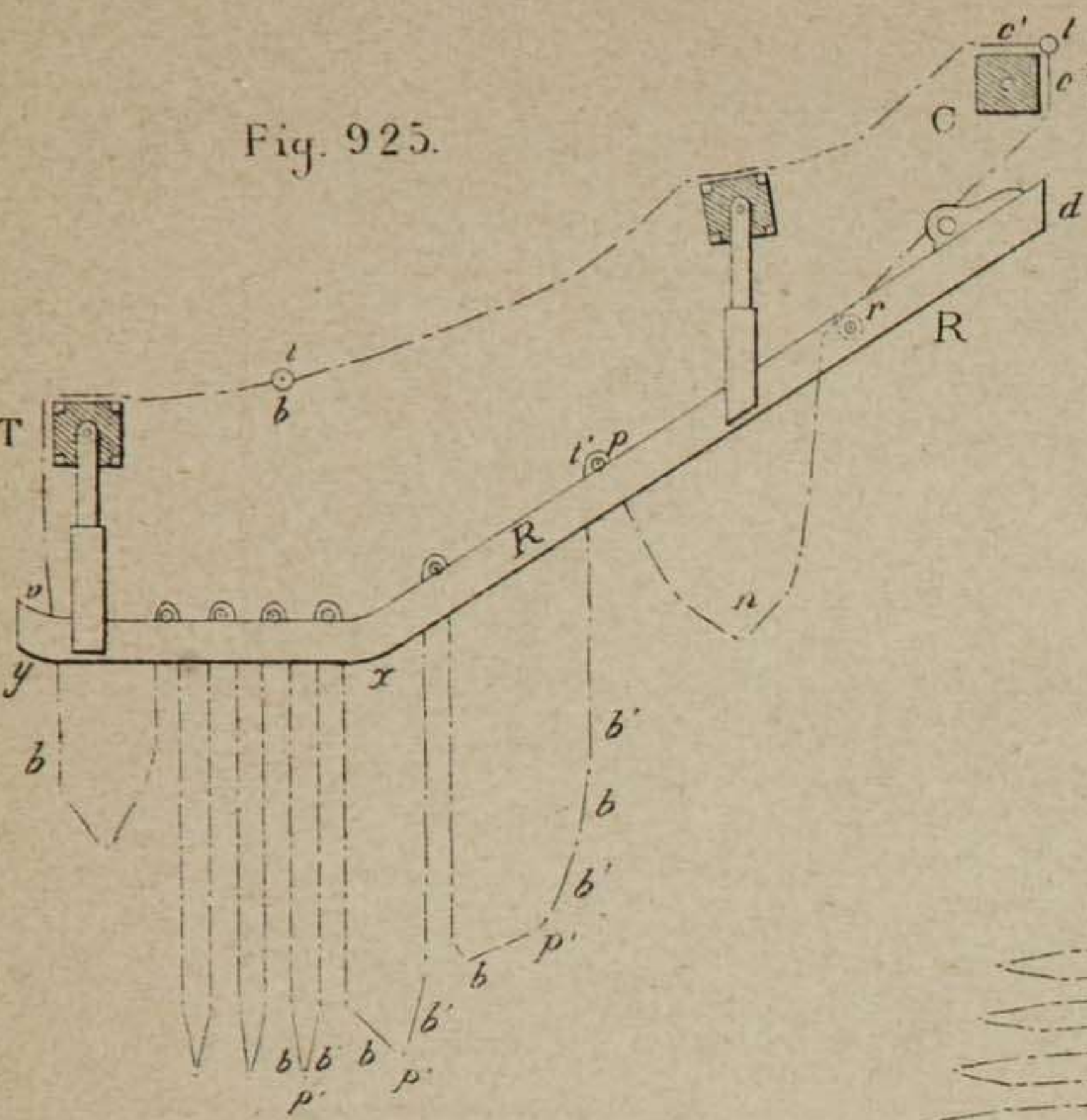


Fig. 922.

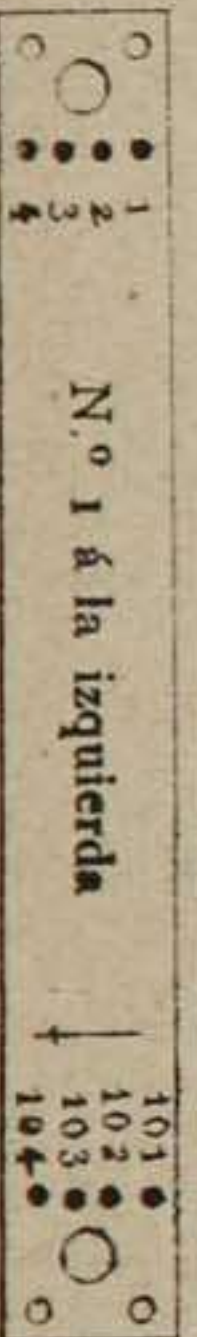


Fig. 921.

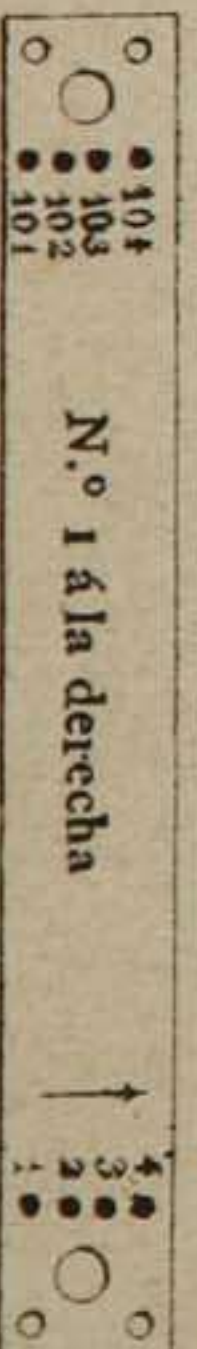
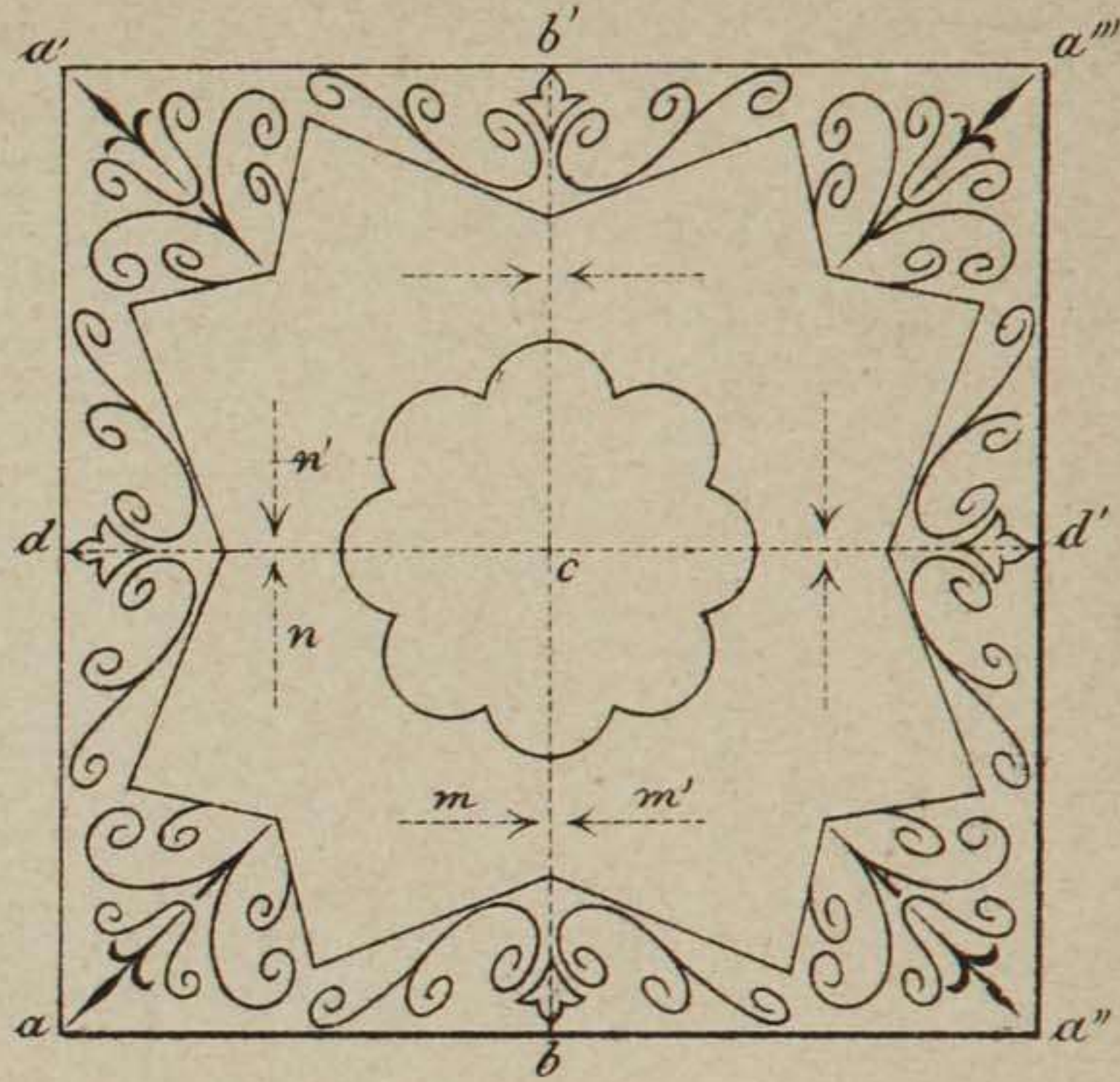




Fig. 928.

Fig. 931.



AG

Fig. 927.



Fig. 930.

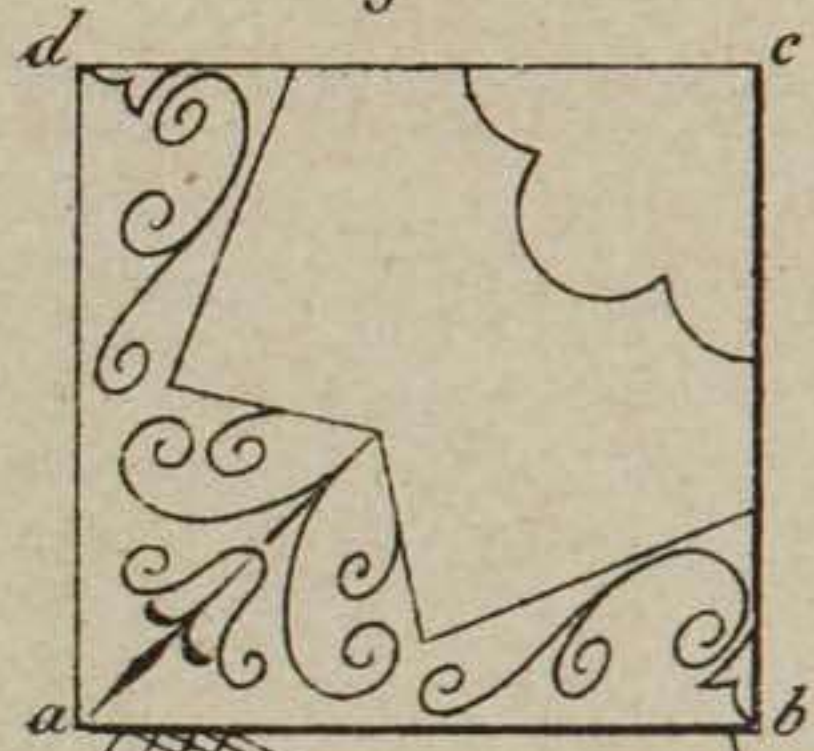
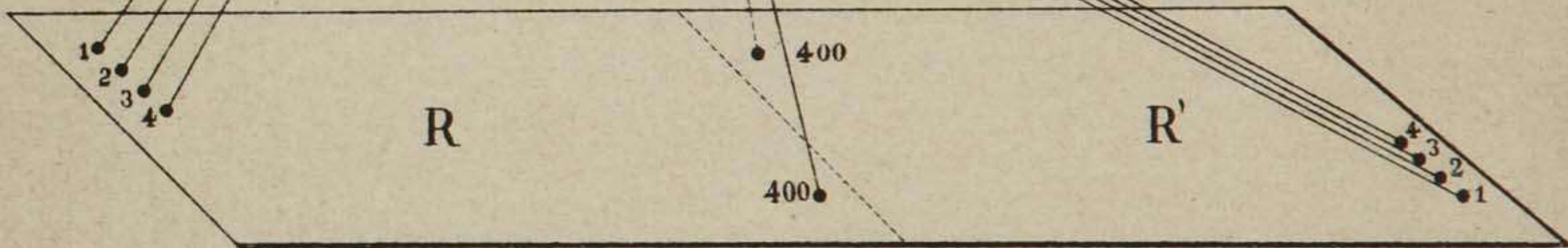
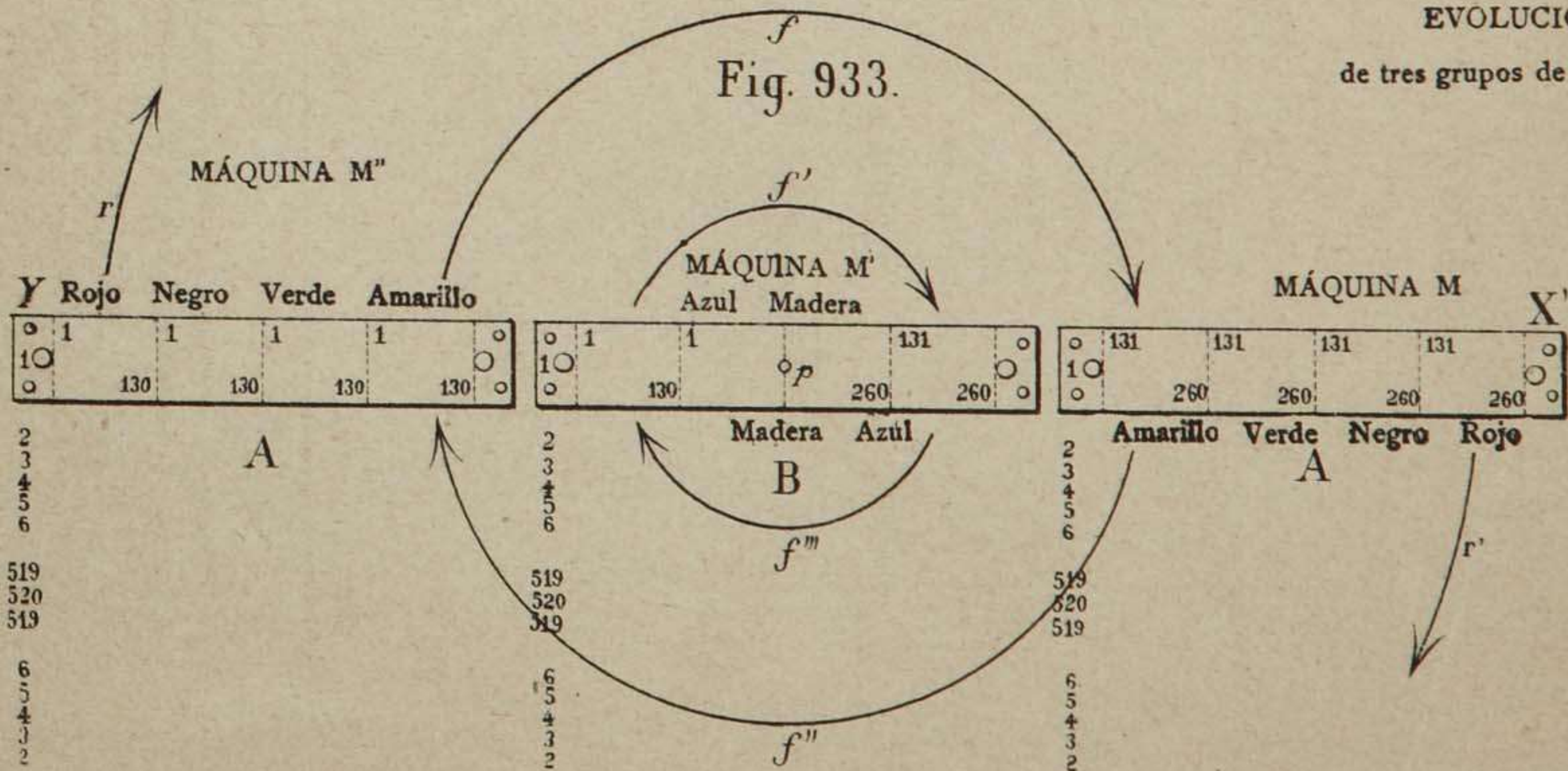


Fig. 932.



PASAR Á PUNTA

EVOLUCION
de tres grupos de cartones



PASAR FRACCIONADO Á SEIS CUERPOS.

EJECUTADO SEGUN LOS 3 CARTONES A B A' DE LA

M 1.^a MÁQUINA DE 520
DEL LADO OPUESTO AL OPERARIO.

M' FIGURA 933.
2.^a MÁQUINA DE 520
EN EL CENTRO.

M'' 1.^a MÁQUINA DE 520
DEL LADO OPUESTO AL OPERARIO.

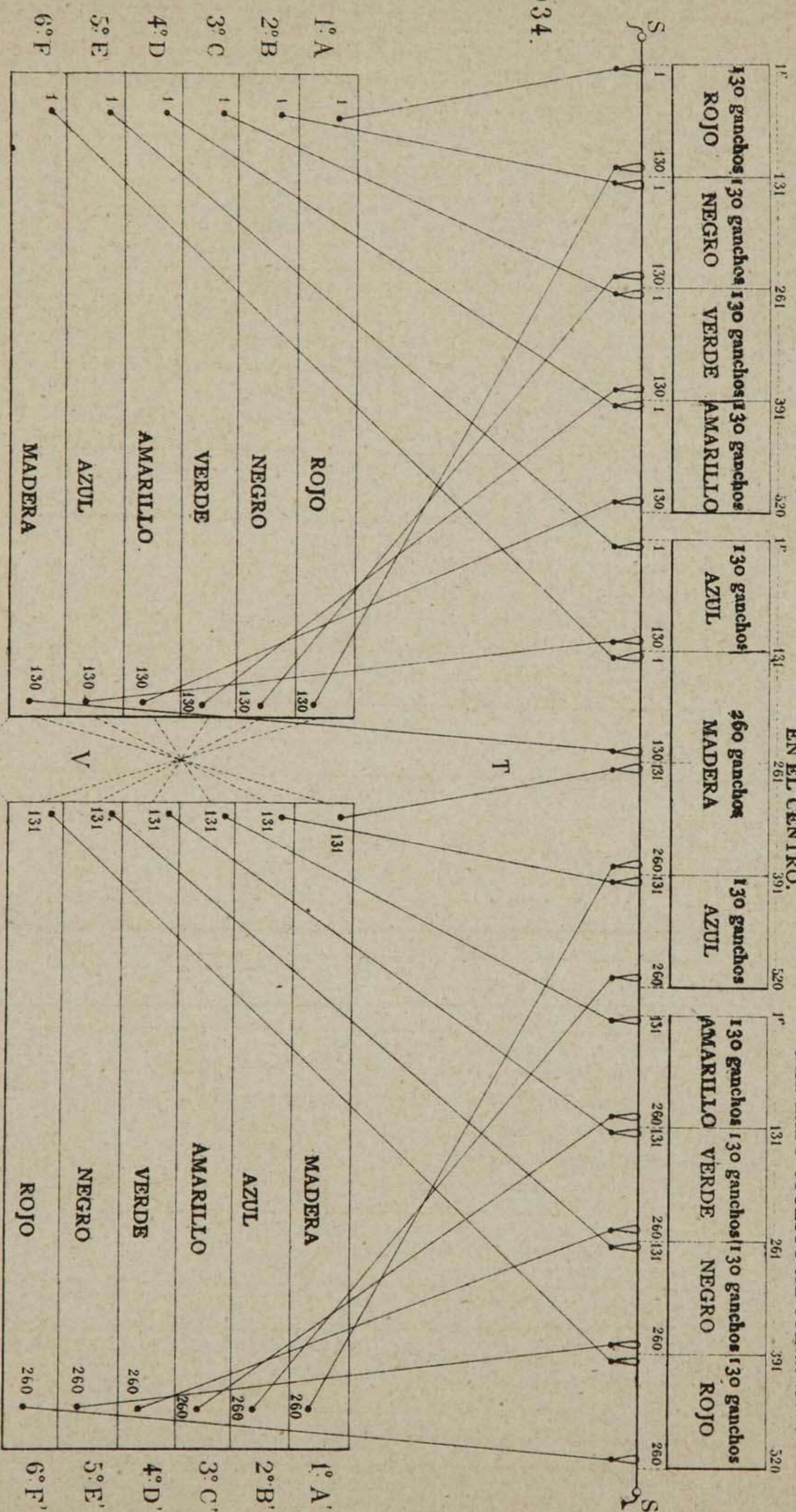


Fig. 934.

DIVISION G, SEIS MEDIOS CUERPOS DE LA
IZQUIERDA

DIVISION H, SEIS MEDIOS CUERPOS DE LA
DERECHA

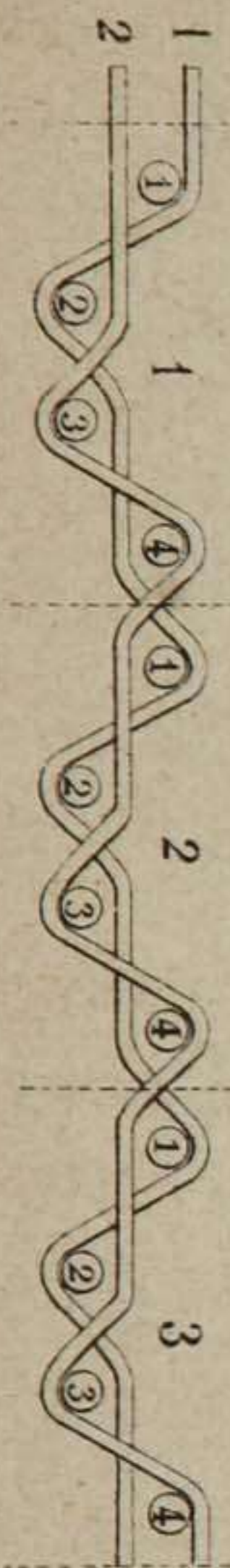


Fig. 937.

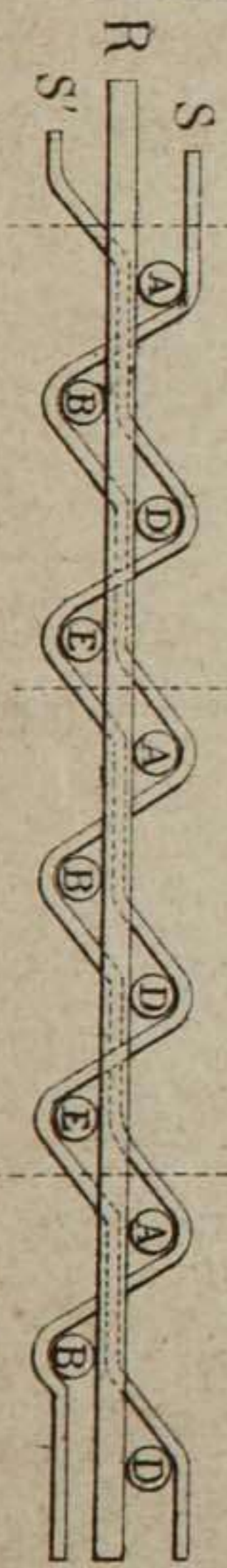


Fig. 938.

COLOCACION DE LAS CAMILLAS EN LOS SEIS BARQUILLOS

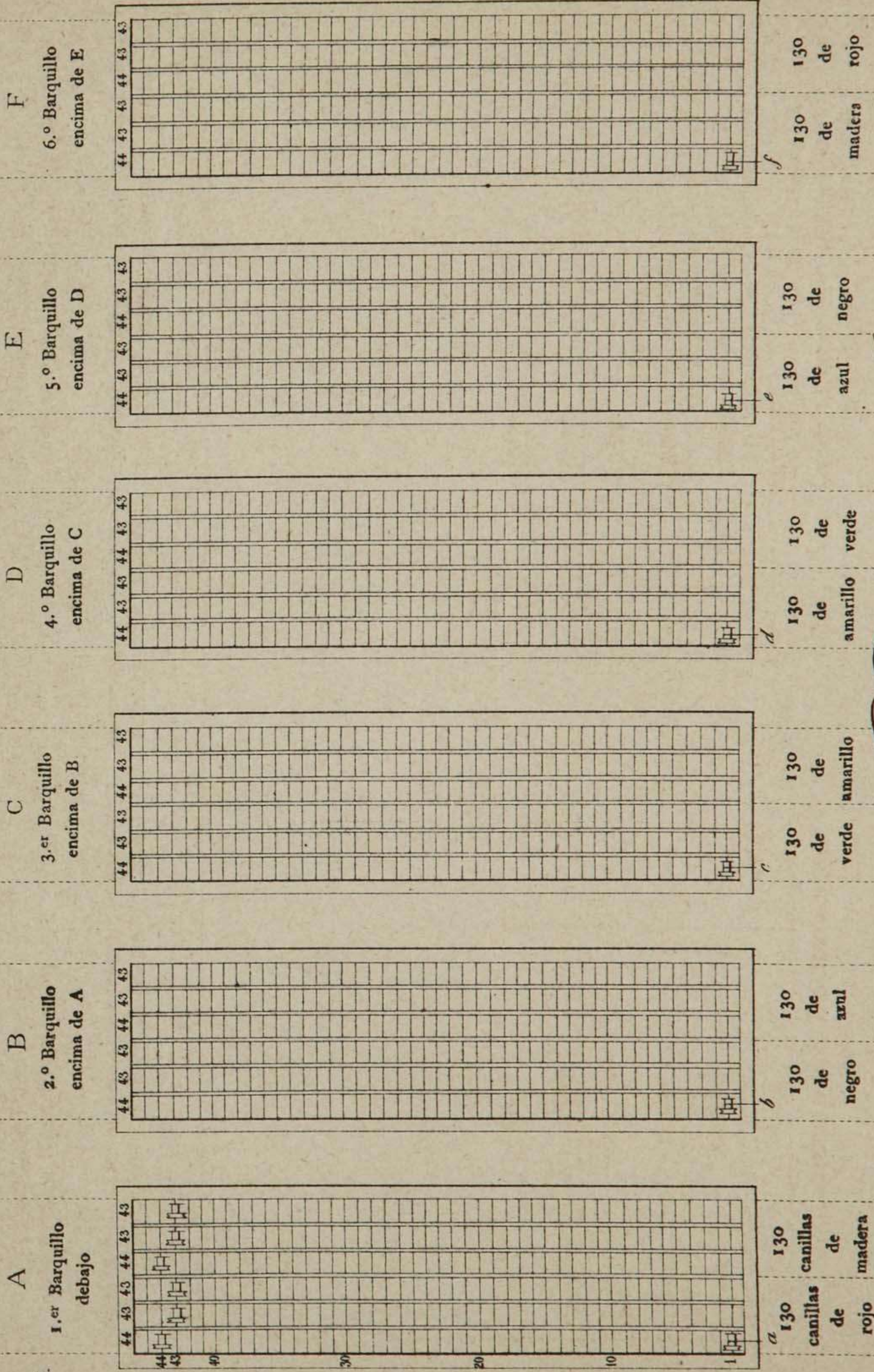


Fig. 955.

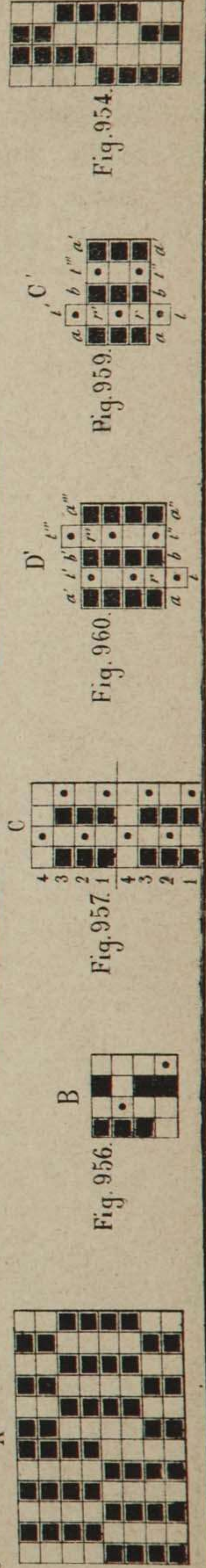
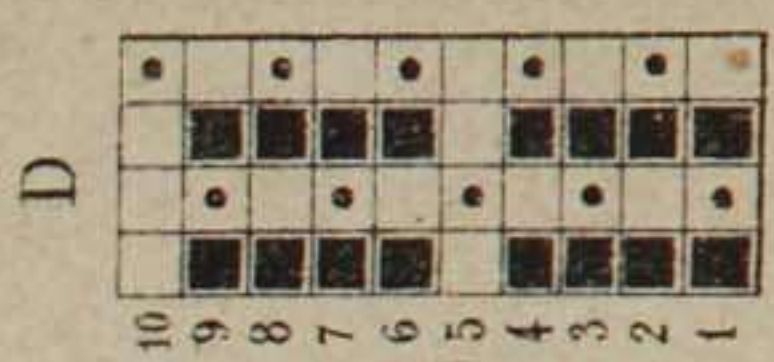
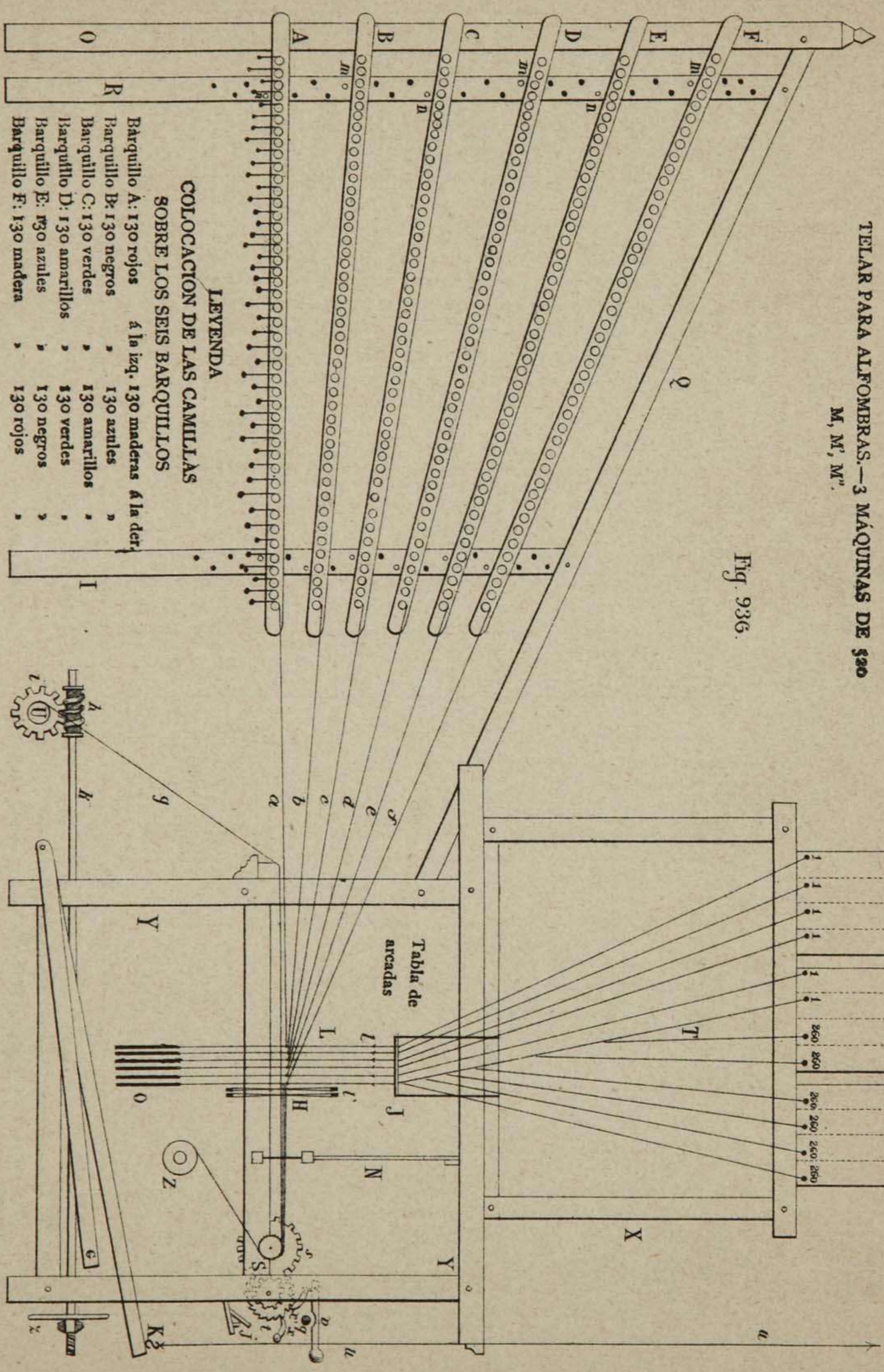


Fig. 958.



TELAR PARA ALFOMBRAS.—3 MÁQUINAS DE 520
M, M', M".

Fig. 936.



LEYENDA
COLOCACION DE LAS CAMILLAS
SOBRE LOS SEIS BARQUILLOS

Barquillo A: 130 rojos	á la izq. 130 maderas	á la der.
Barquillo B: 130 negros	"	"
Barquillo C: 130 verdes	"	"
Barquillo D: 130 amarillos	"	"
Barquillo E: 130 azules	"	"
Barquillo F: 130 maderas	"	"

Fig. 961.

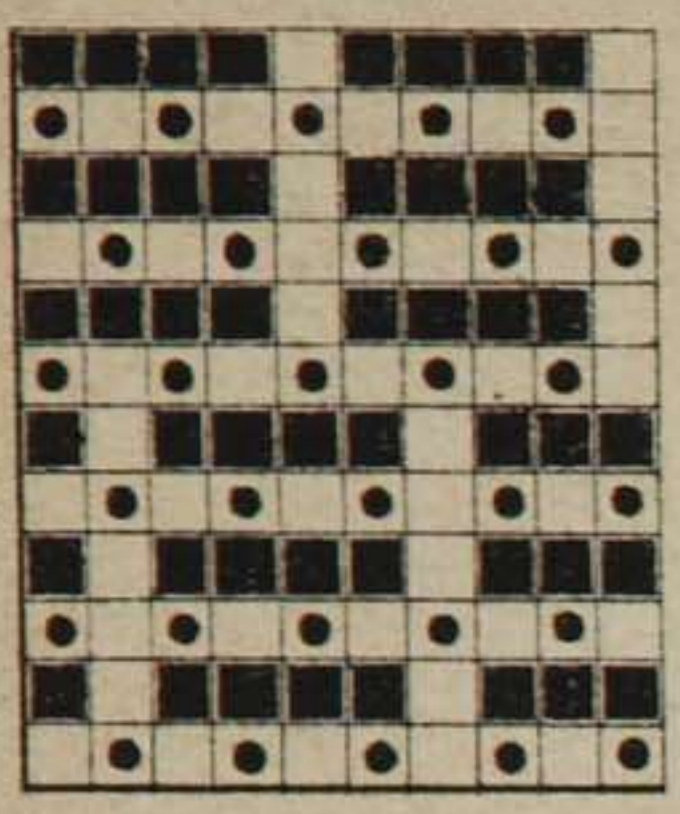


Fig. 964.

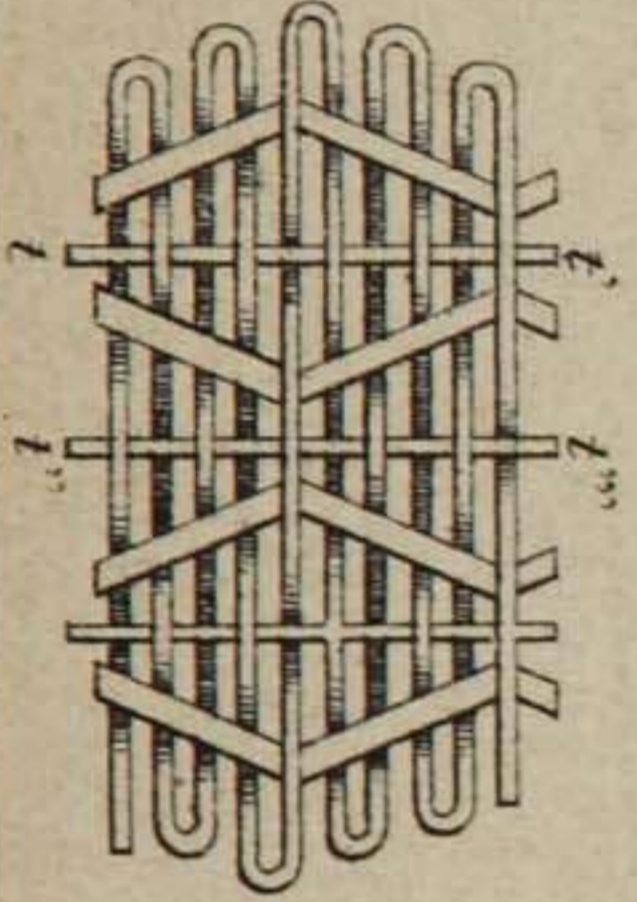


Fig. 963.

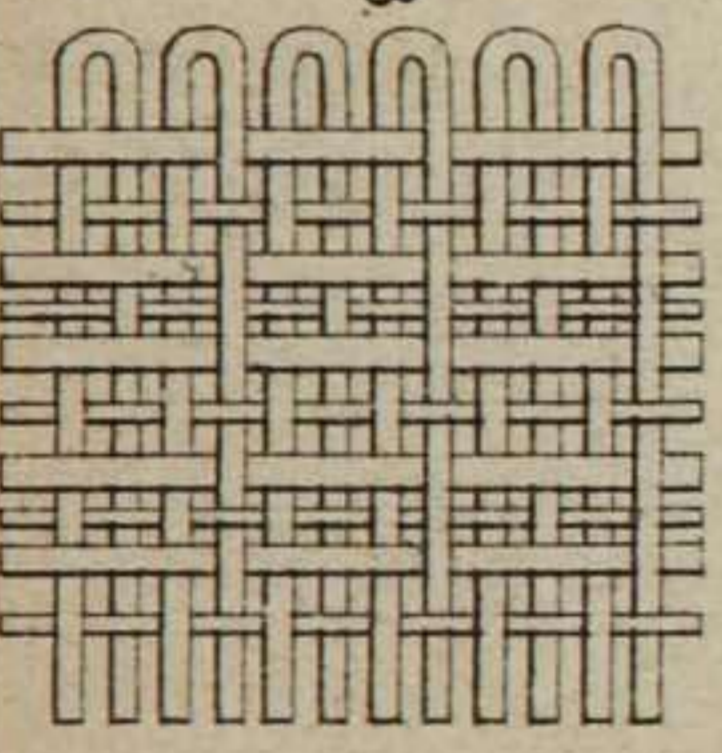
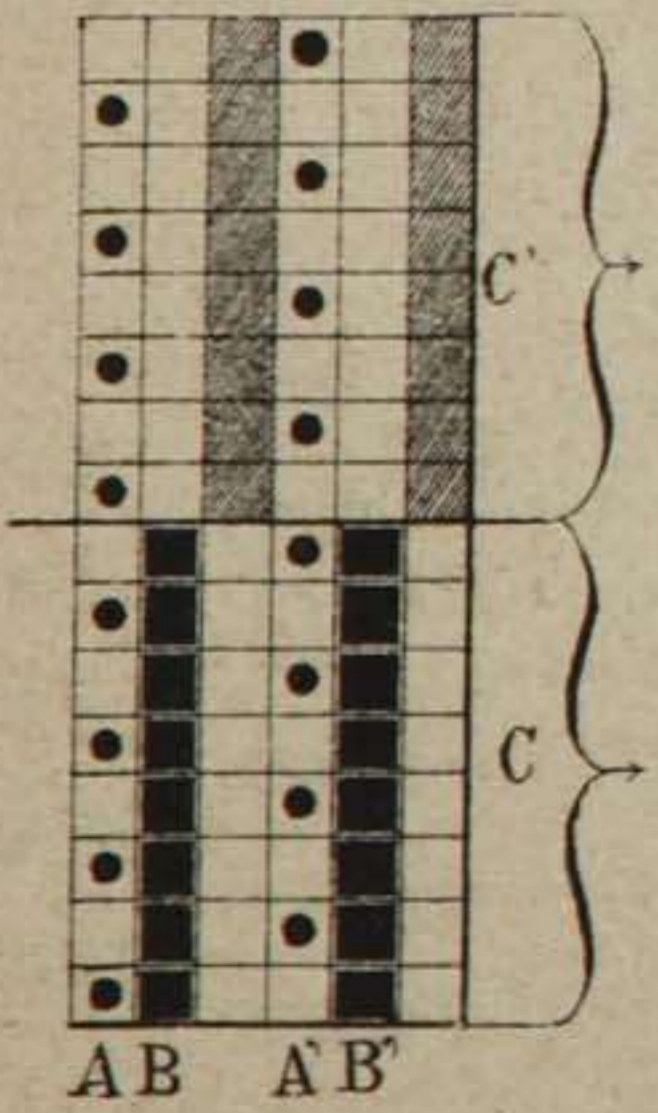


Fig. 962.



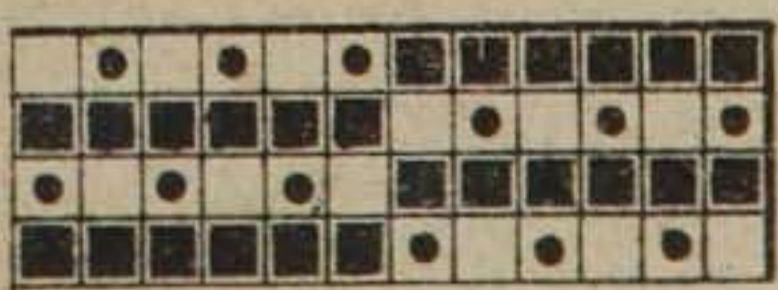


Fig. 966.

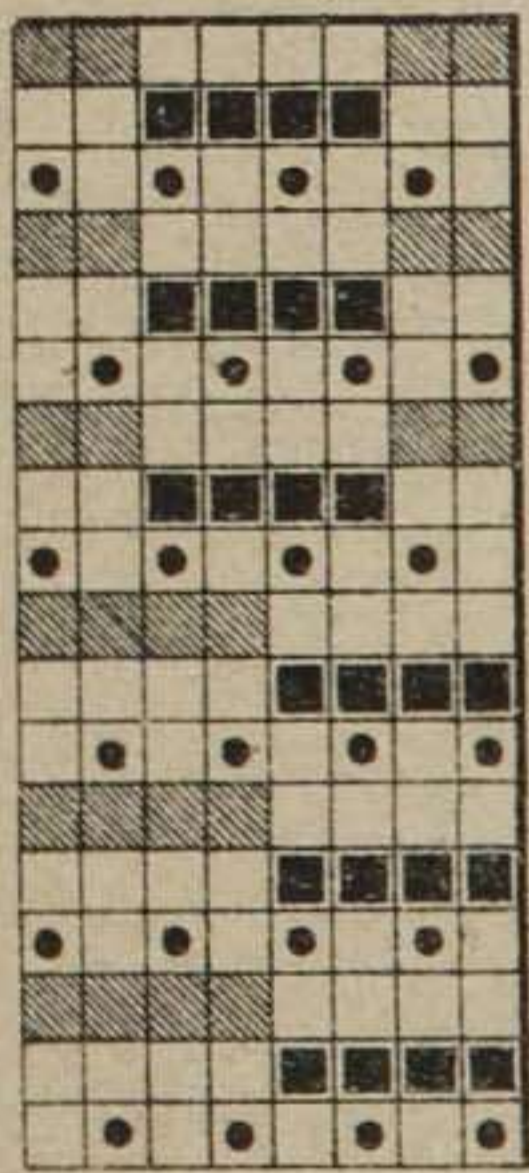


Fig. 965.

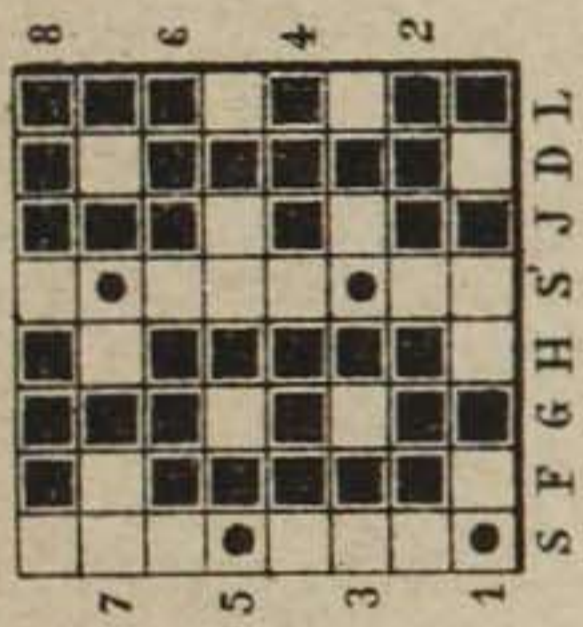


Fig. 967.

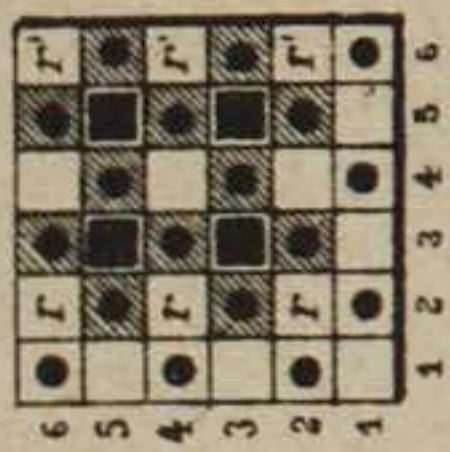


Fig. 968.

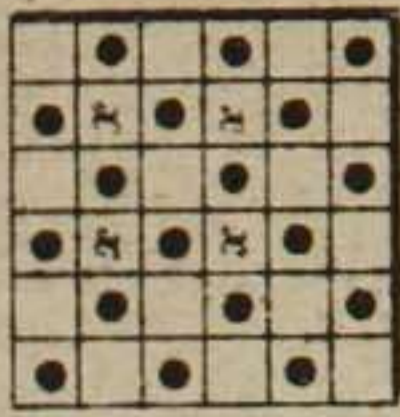


Fig. 969.

LEVENDA
DE LOS COLORES

- Rojo
- Negro
- Verde
- Amarillo
- Azul
- Madera

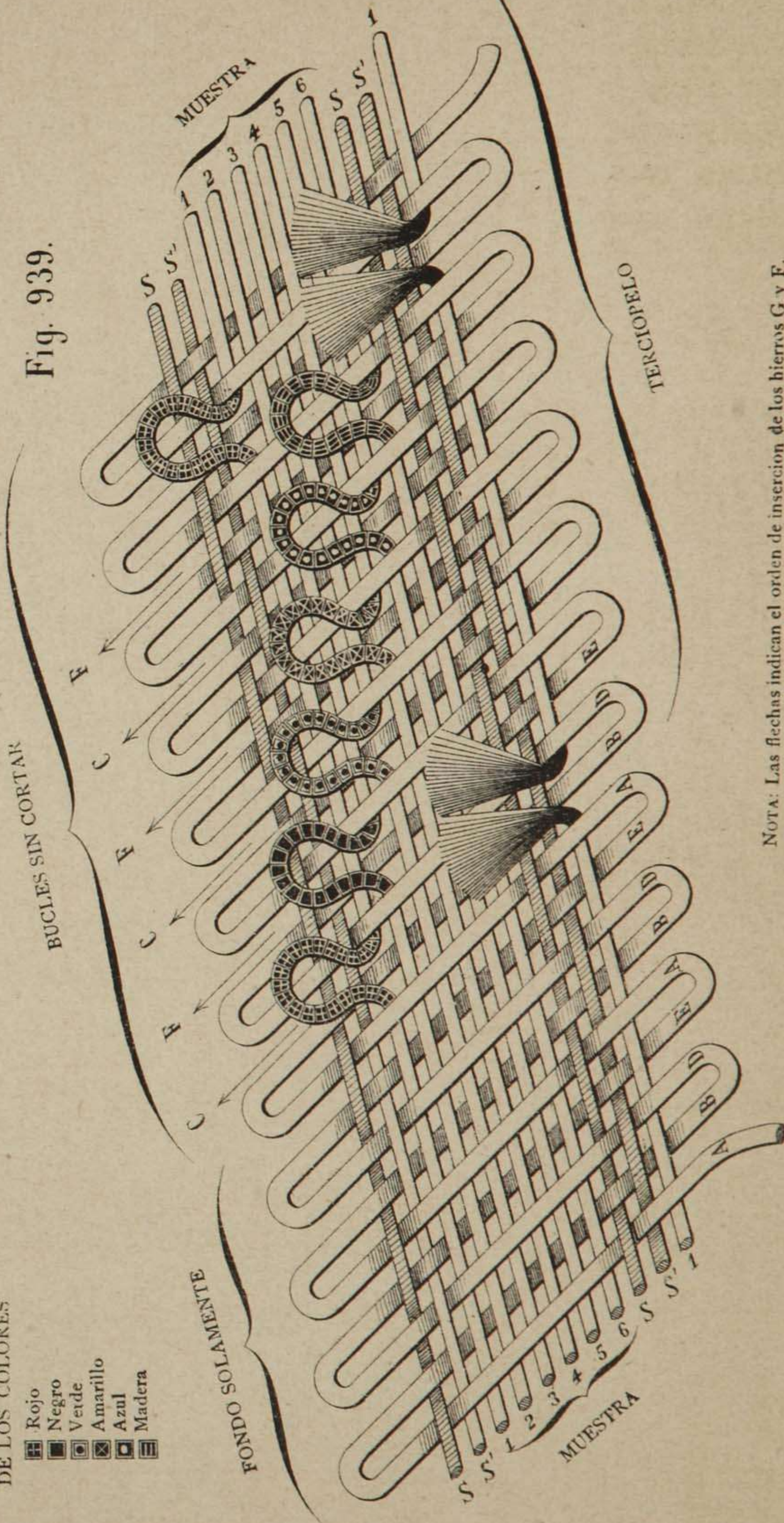


Fig. 939.

NOTA: Las flechas indican el orden de insercion de los hierros G y F.

Fig. 981.

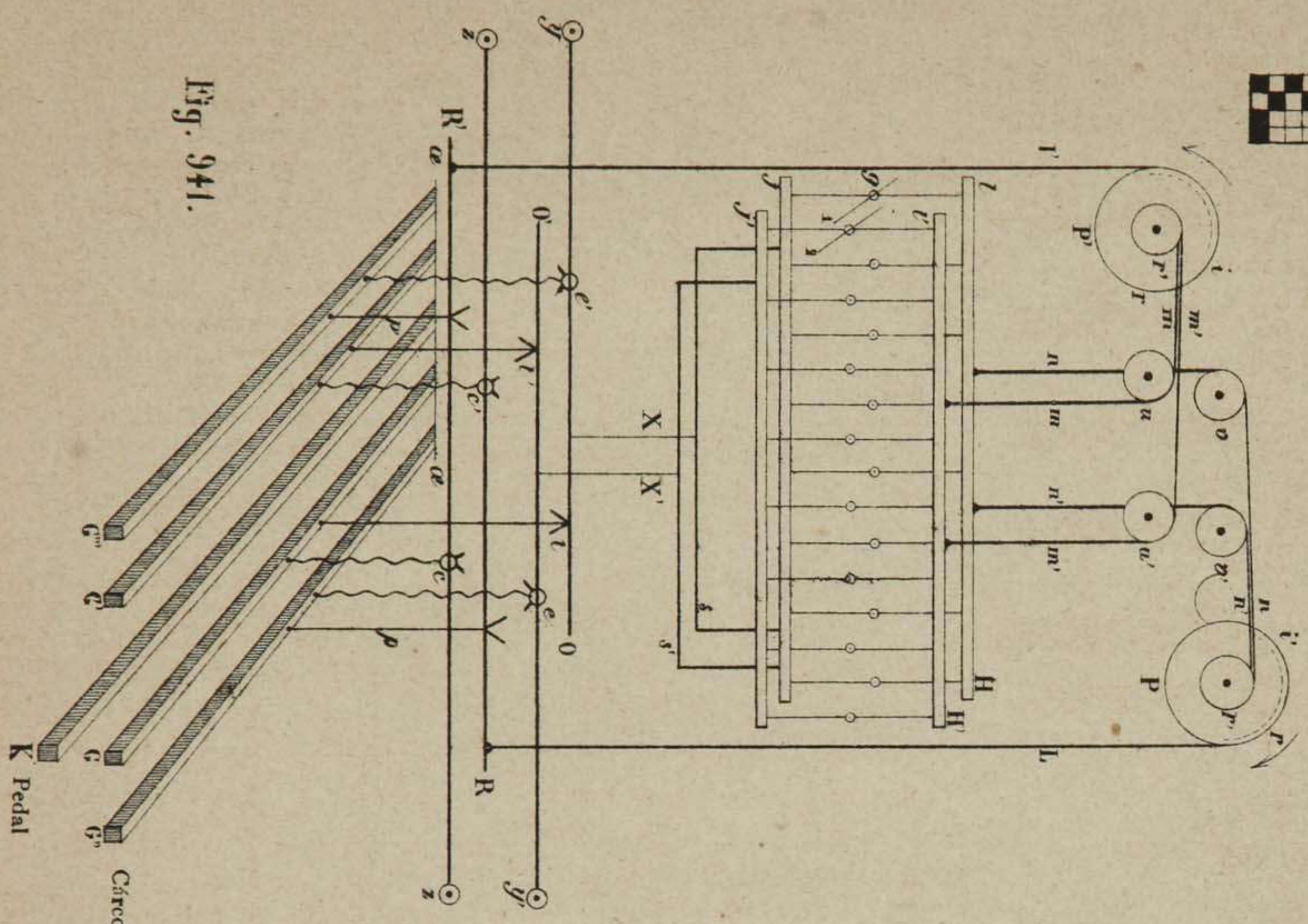


Fig. 941.

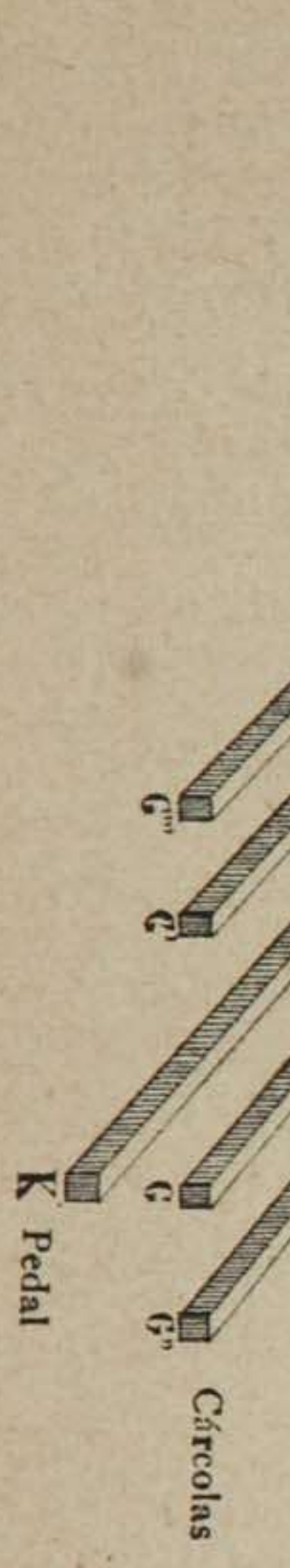


Fig 979

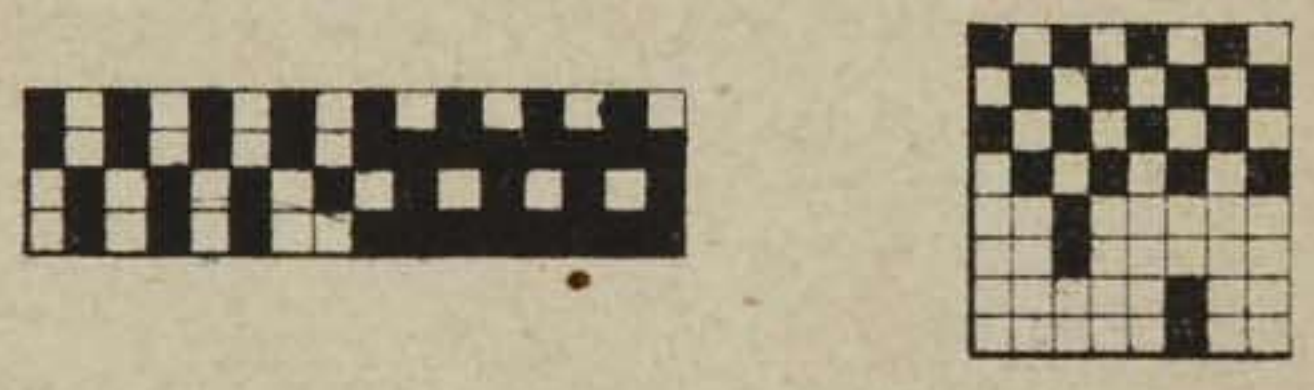


Fig. 980.

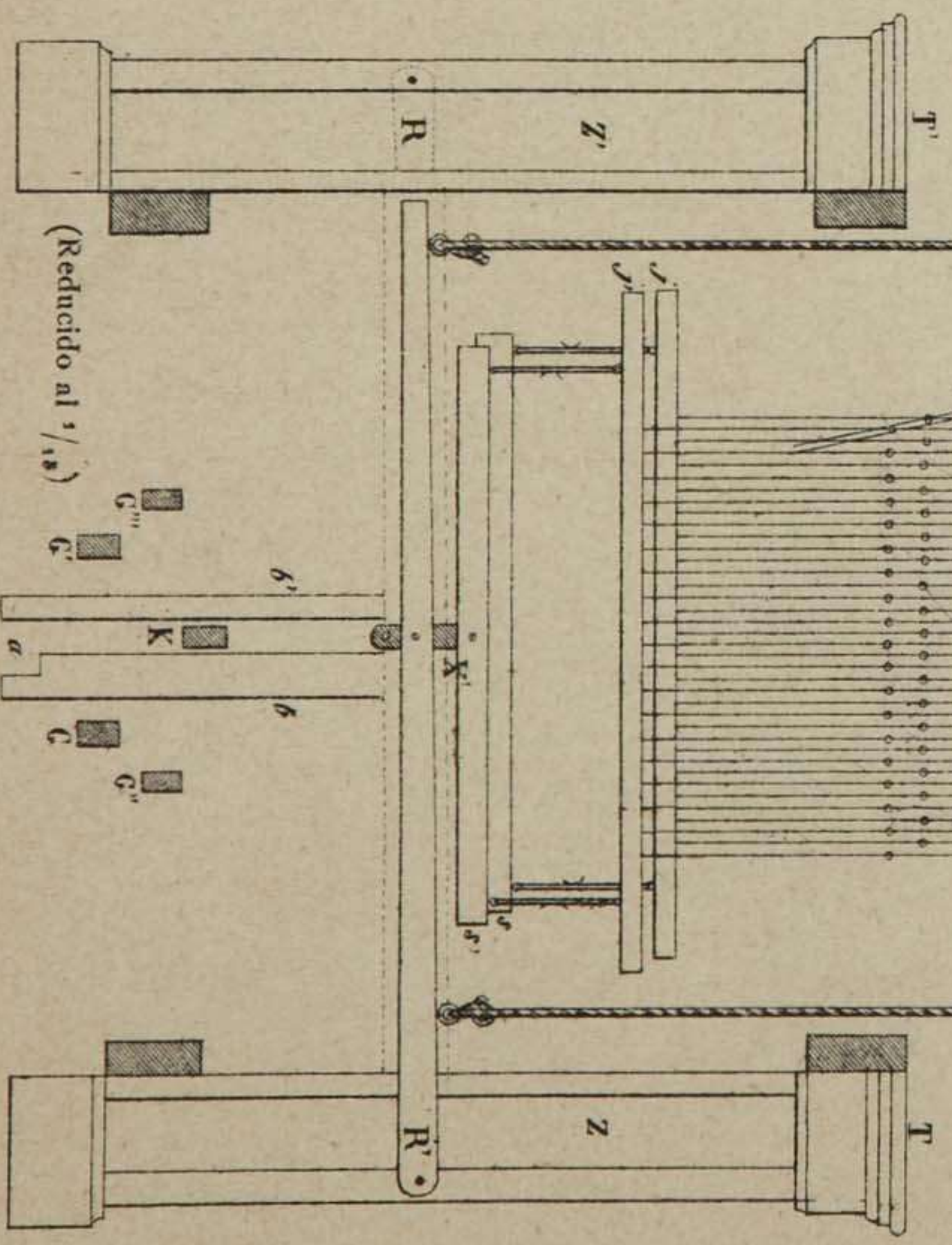


Fig. 978.

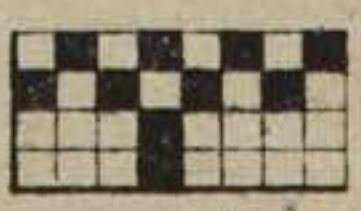


Fig. 940.

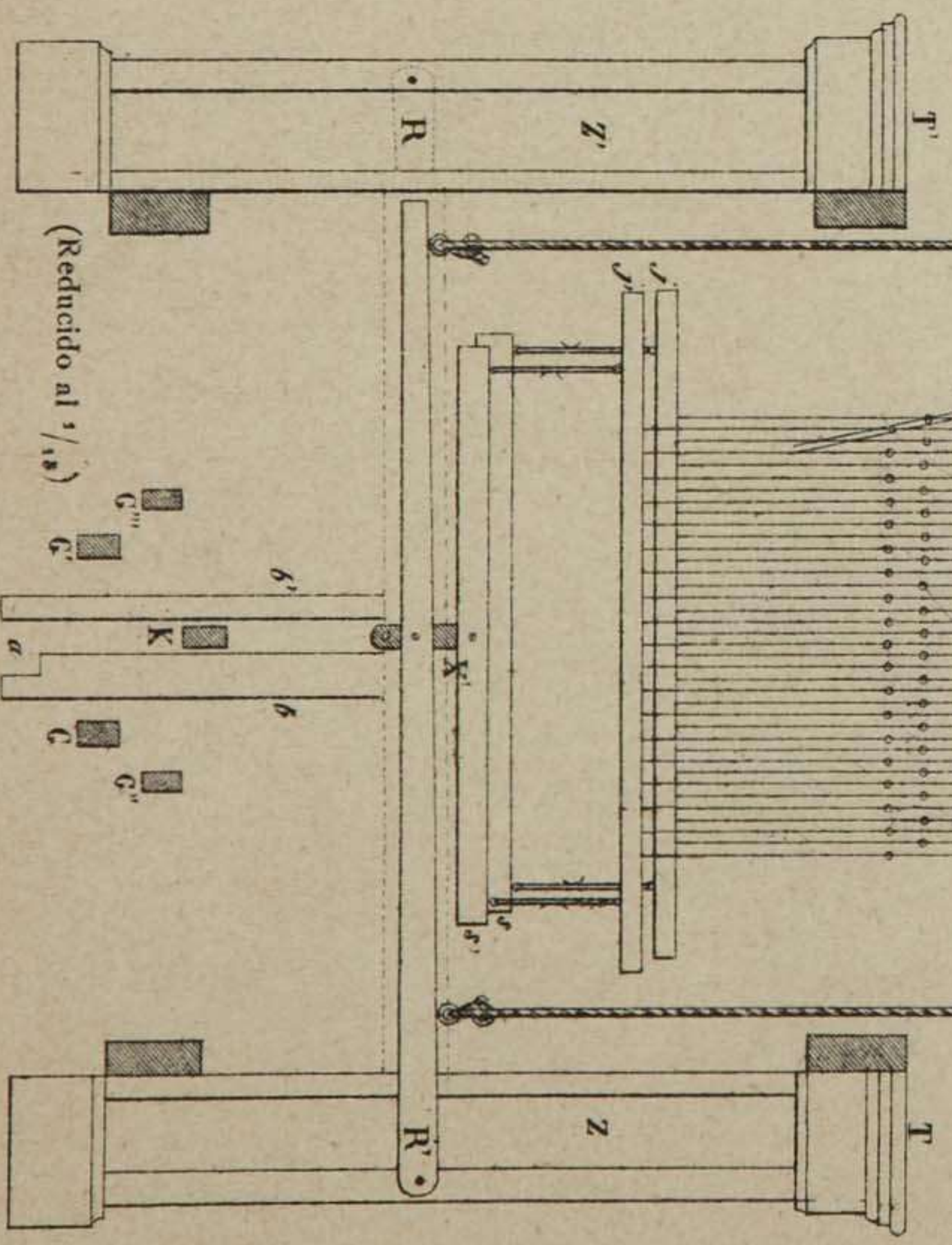
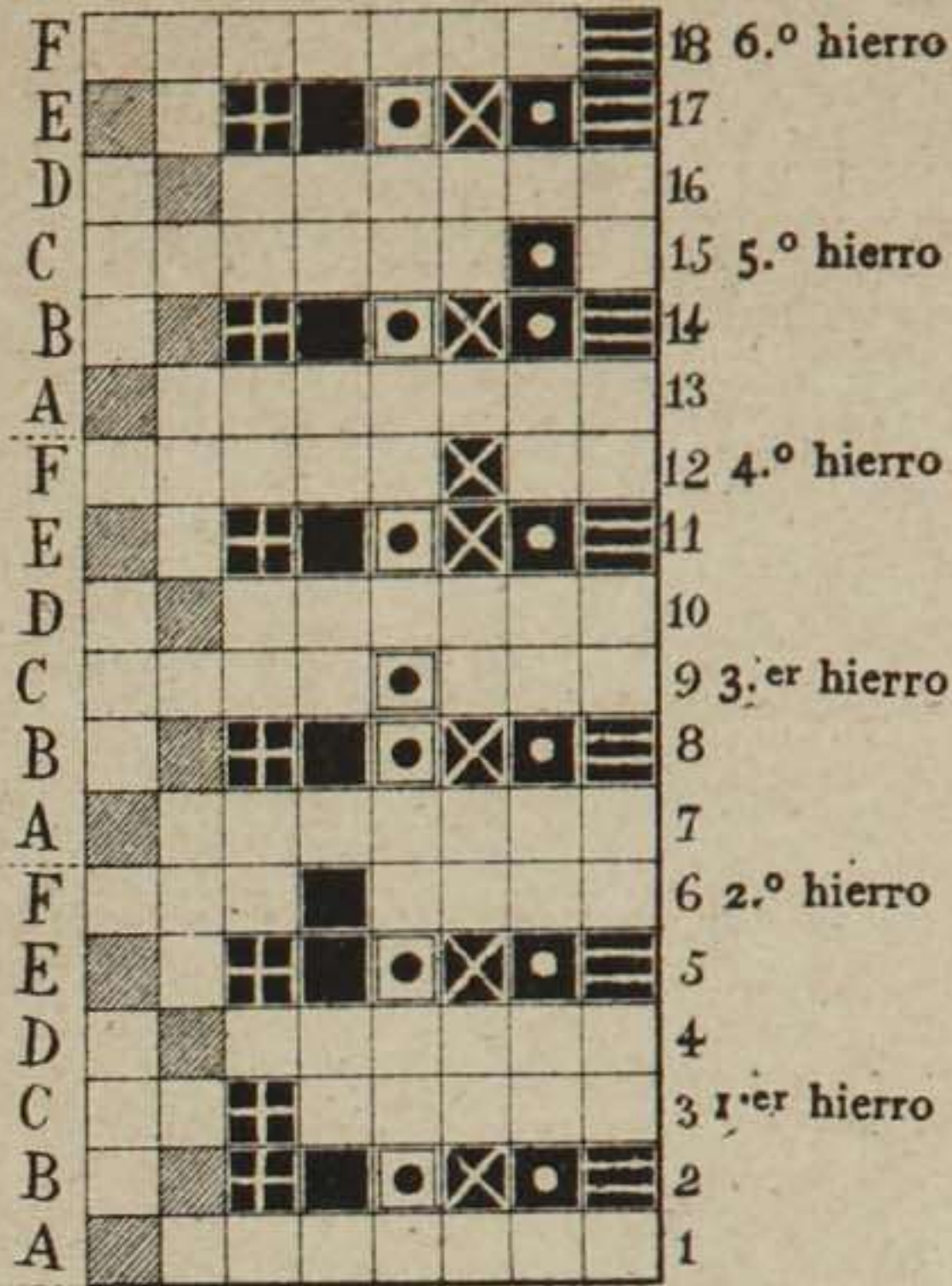


Fig. 942.

EVOLUCION DE LA MUESTRA



SÍNTESIS

LEYENDA DE LOS SIGNOS Y LETRAS DE LA CADENCIA

- A 1.ª pisada
- X, 1.º Paro de K.
- B 2.ª pisada.
- C Paso del 1.º hierro.
- r, desasimiento de K.
- ⊙ 3.ª pisada.
- D X', 2.º paro de K.
- ⊠ 4.ª pisada.
- E Paso del 2.º hierro.
- F r', desprendimiento de K
- ⊙ Lizo levantado.
- ∨ Lizo rebatido.
- ∧ Fechas-direcciones de los piés,

Fig. 945

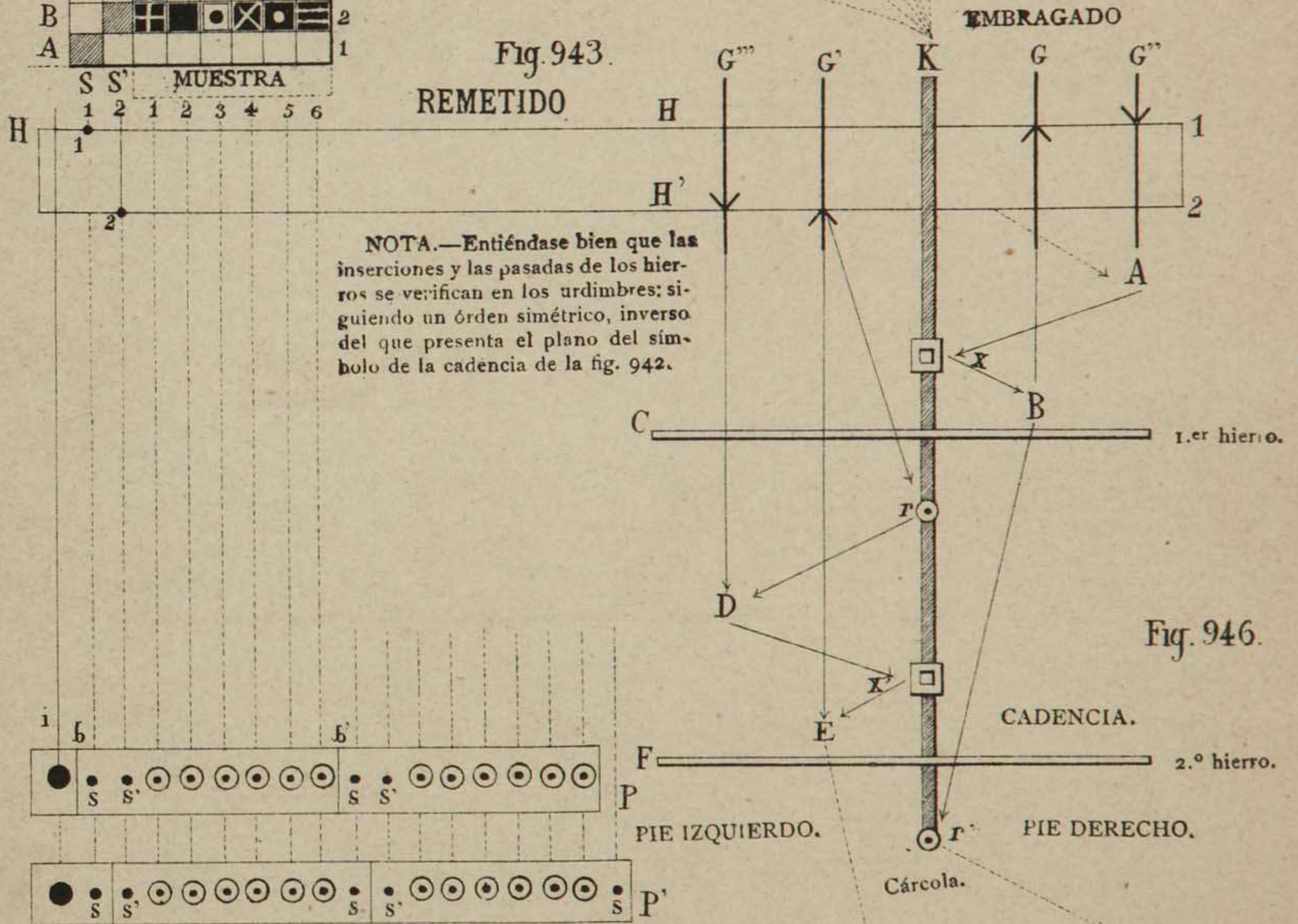


Fig. 944. } P Punteado á la francesa.
P' Punteado á la inglesa.

Fig. 947.

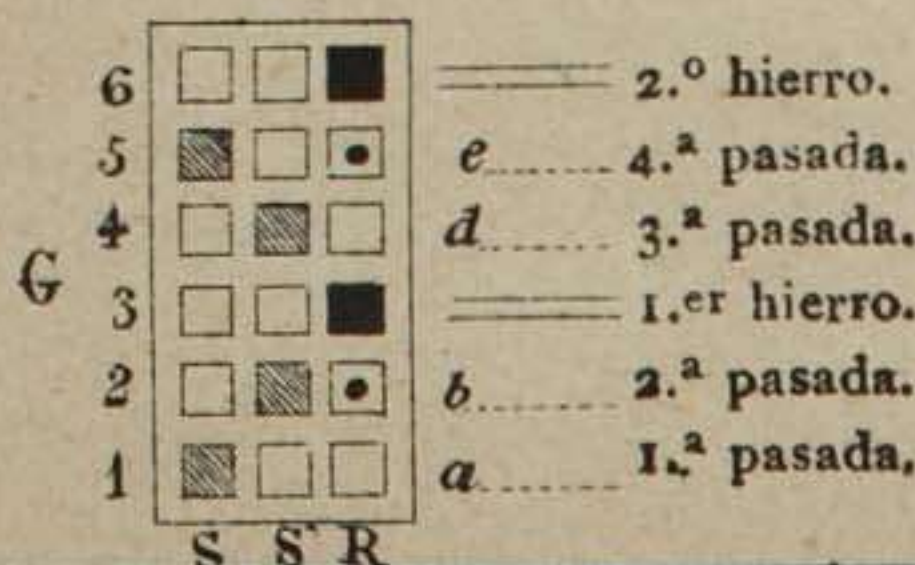


Fig. 948.

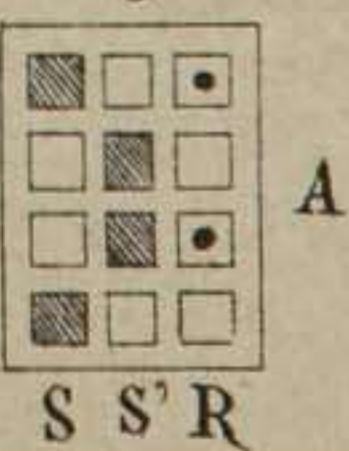


Fig. 949



Fig. 950

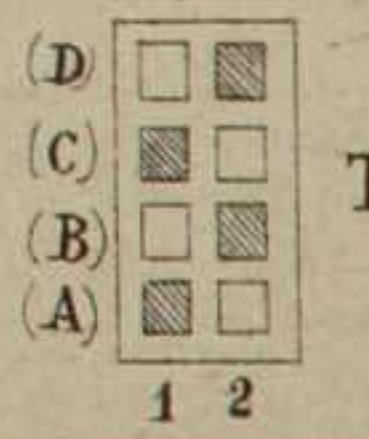


Fig. 951.

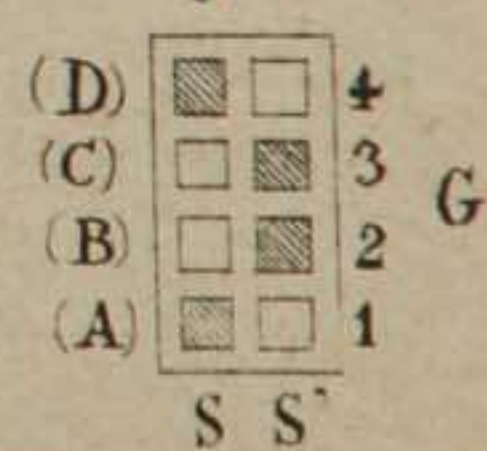
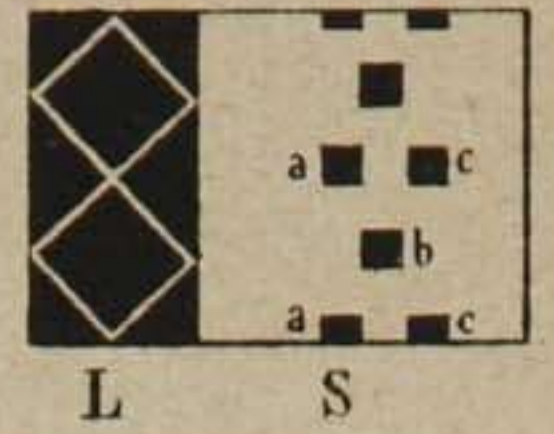
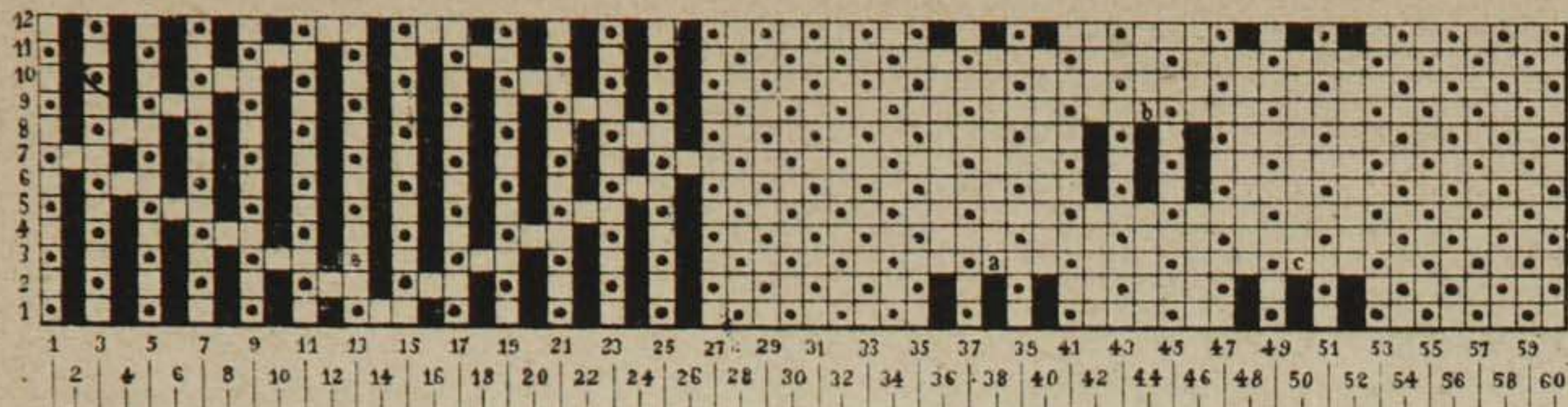


Fig. 973

PUESTA EN CARTA.

DISEÑO.

Fig. 972



1.er cuerpo.

2.º cuerpo.

3.er cuerpo.

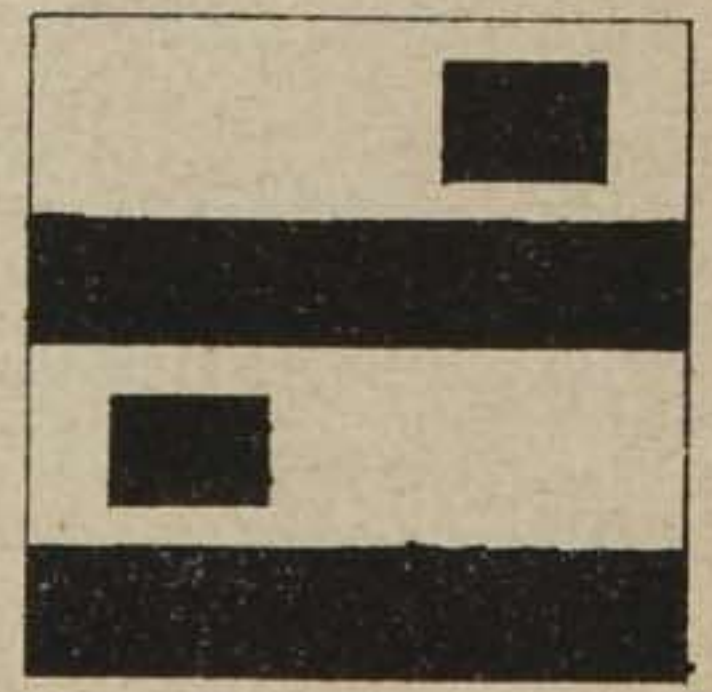
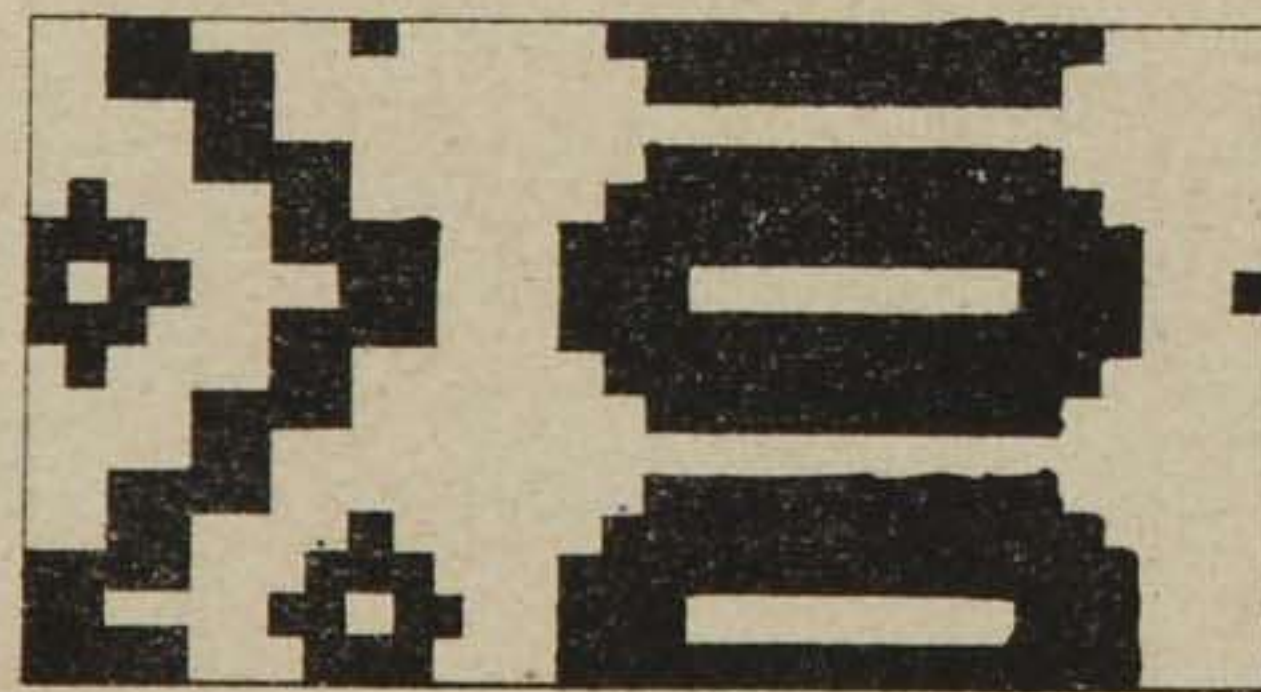
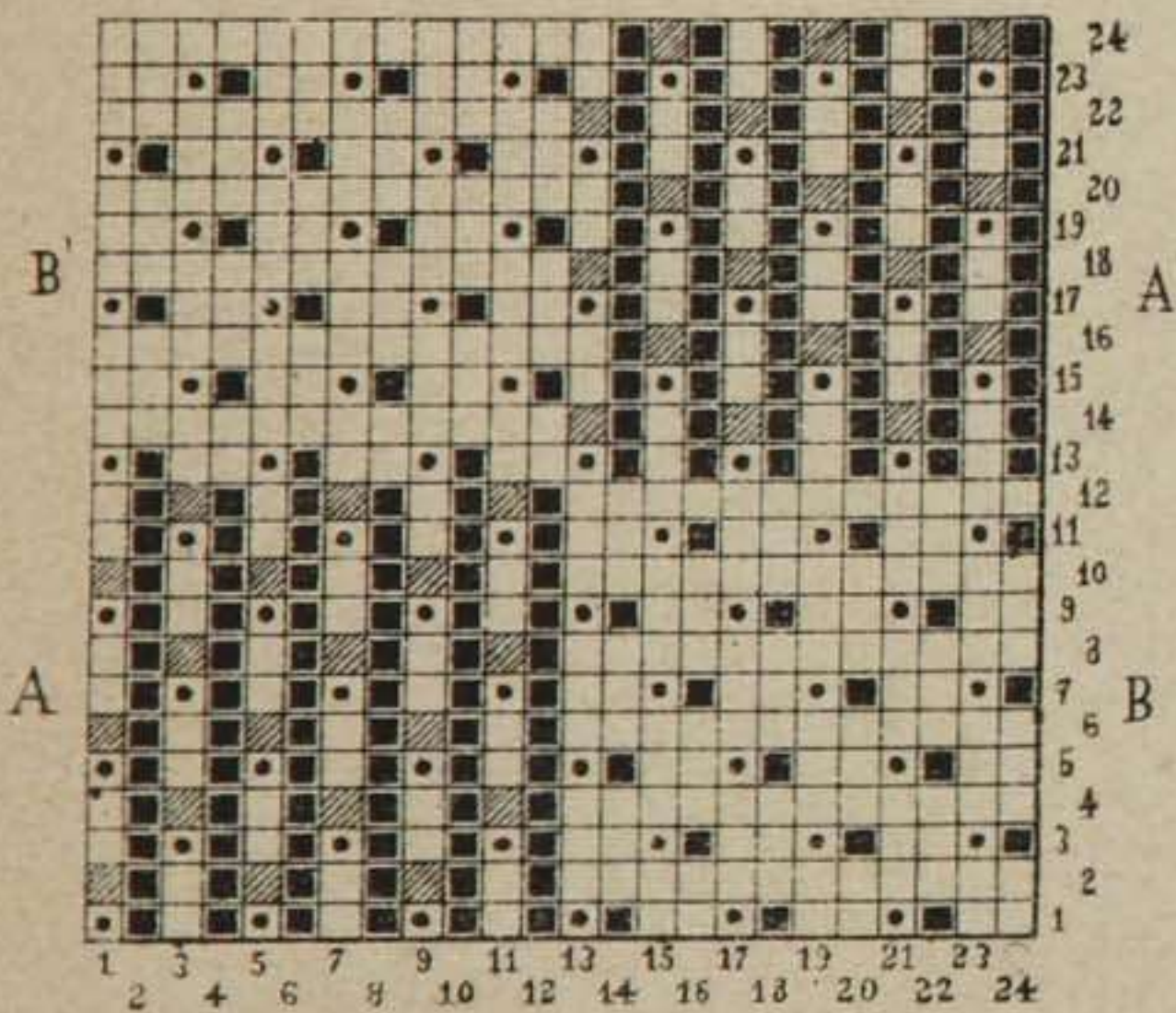
DISEÑO.

Fig. 975

DISEÑO.

Fig. 976

Fig. 970



DISEÑO.

Fig. 977

DISEÑO.

Fig. 974

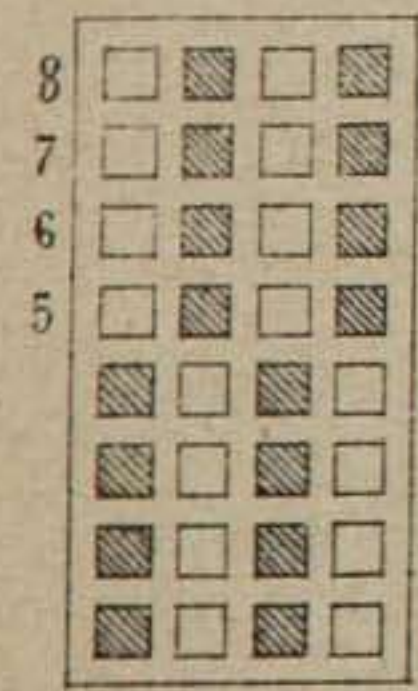
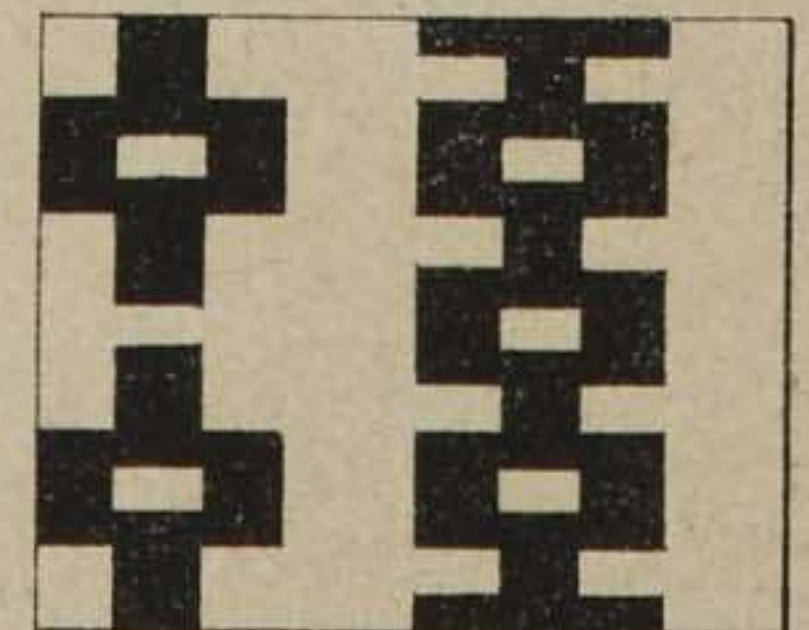
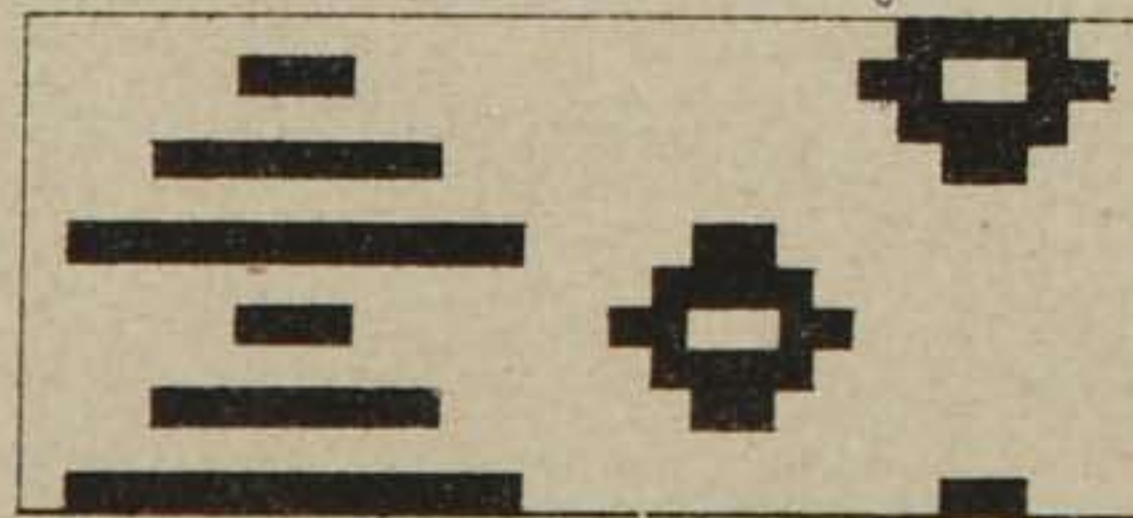


Fig. 953



Fig. 980



Fig. 981



Fig. 978

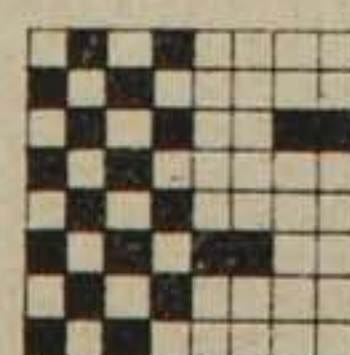


Fig. 979



Fig. 971

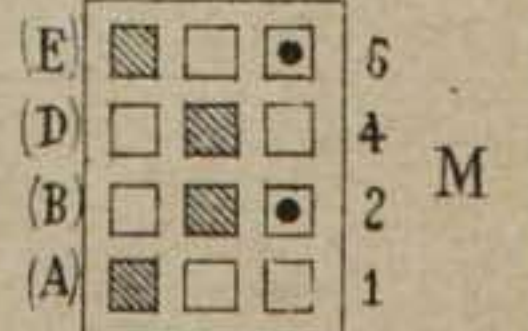


Fig. 952

Guías de la regla dentada

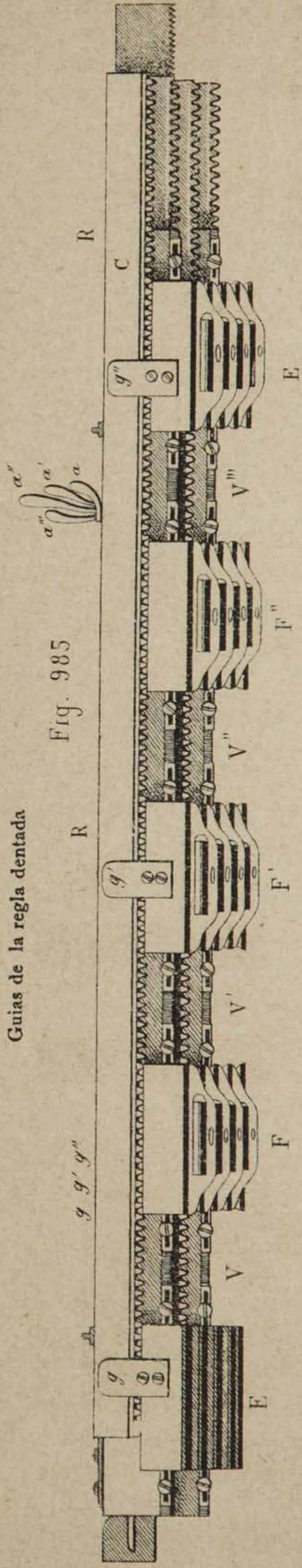


Fig. 985

TEORIA DEL VARAL DEL LABRADO (cuadro articulado)

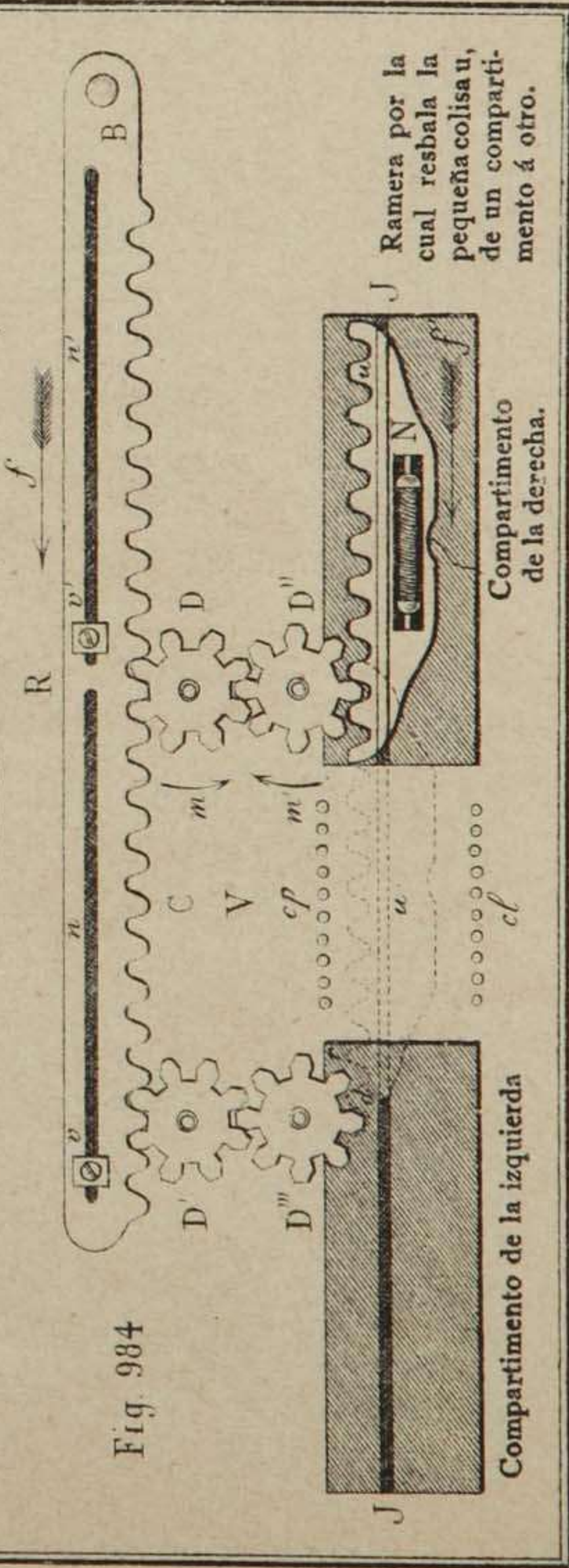


Fig. 984

(Guía lanaradera)

Fig. 988

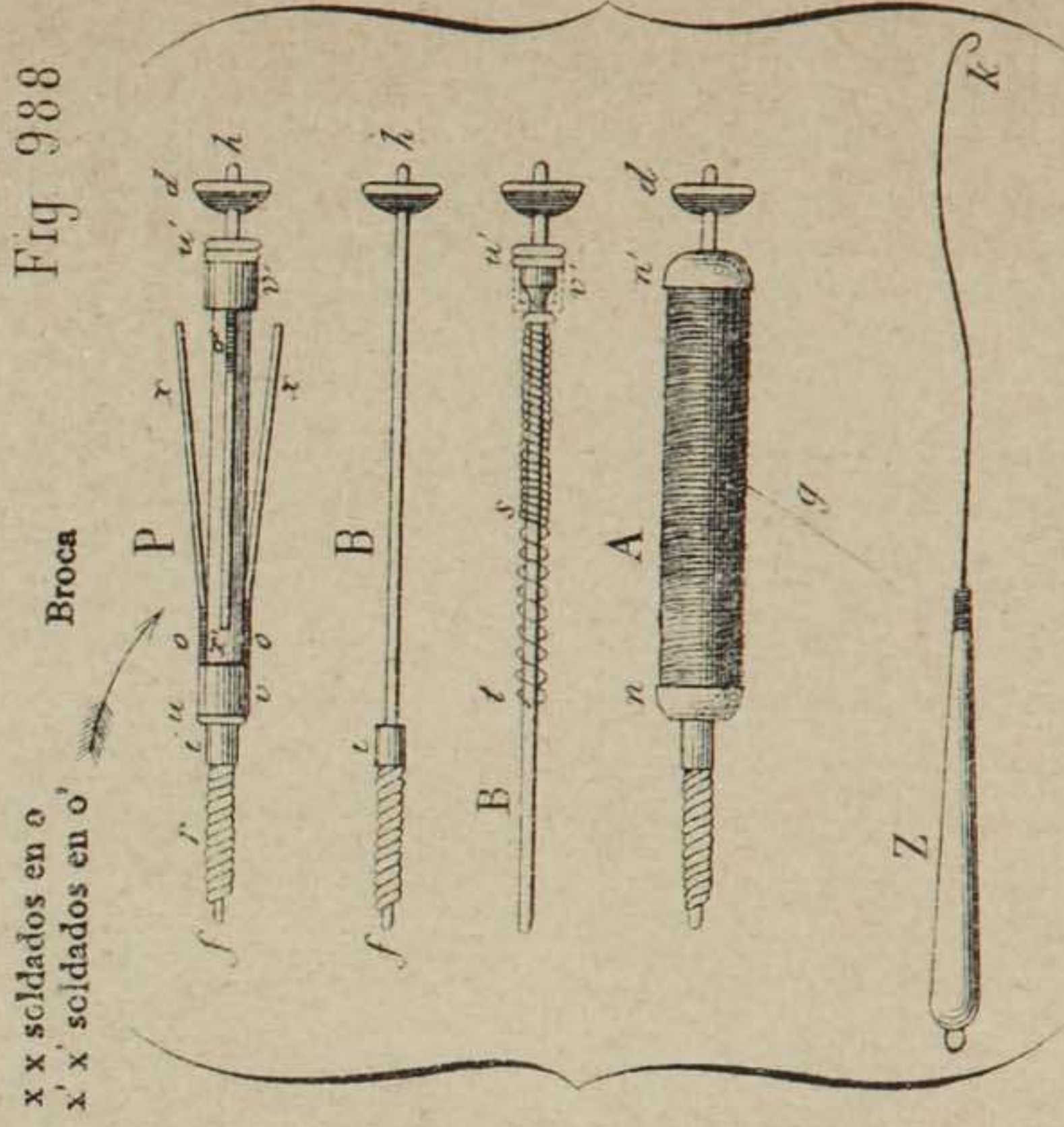


Fig. 986

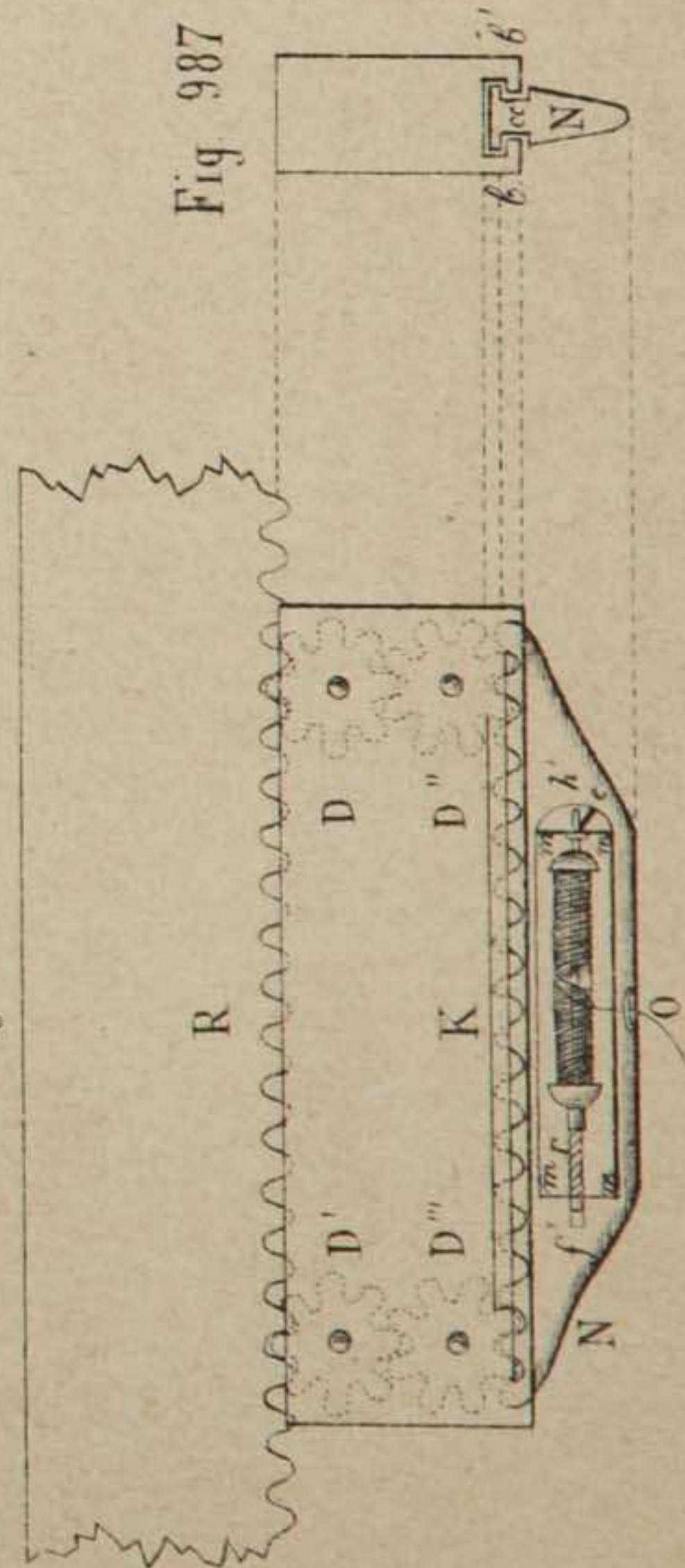


Fig. 987

Fig. 982



Blanco Verde

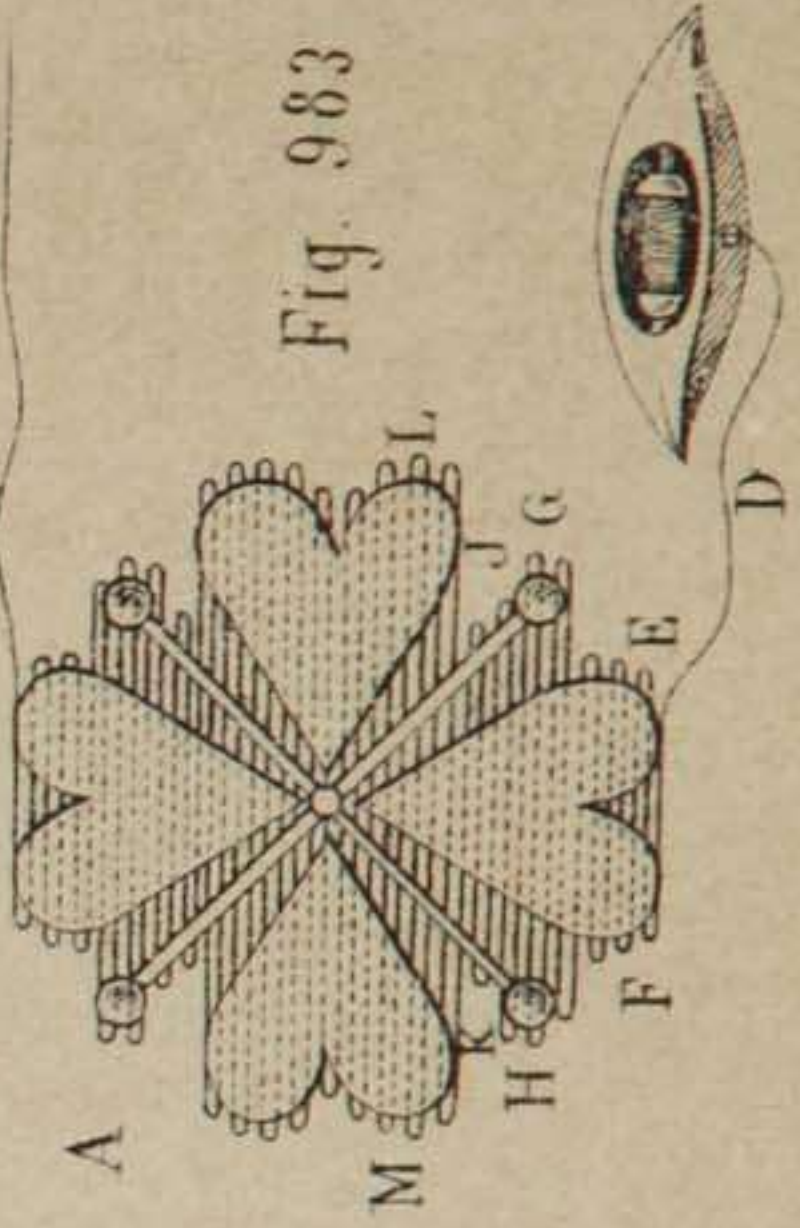


Fig. 983

Fig. 992

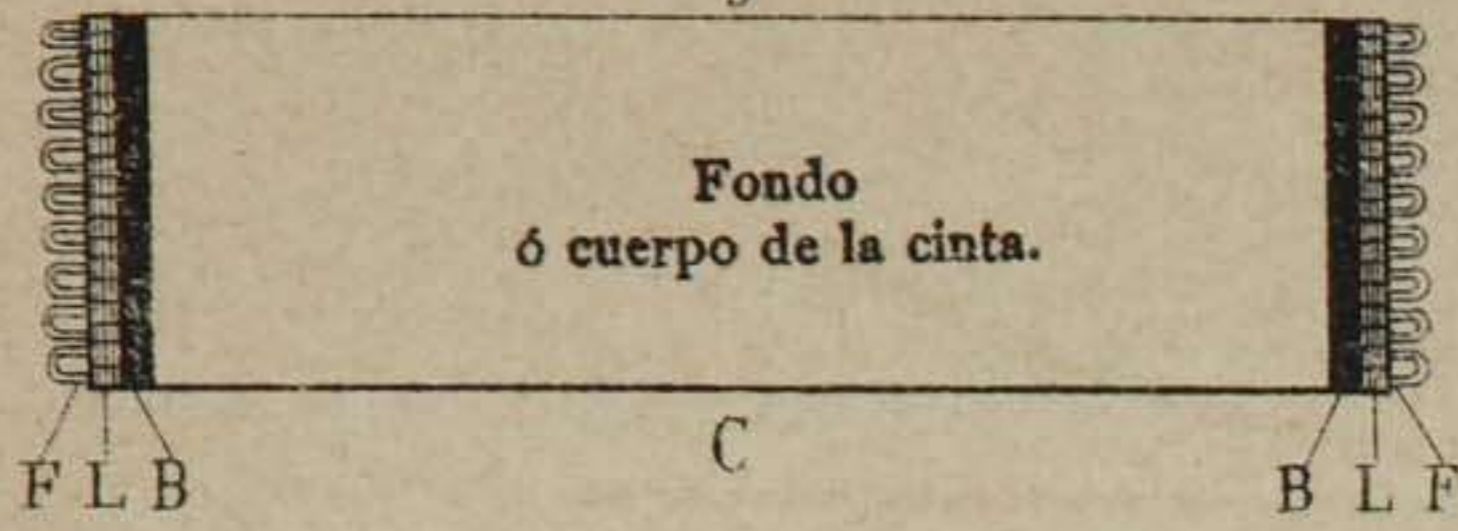


Fig. 996

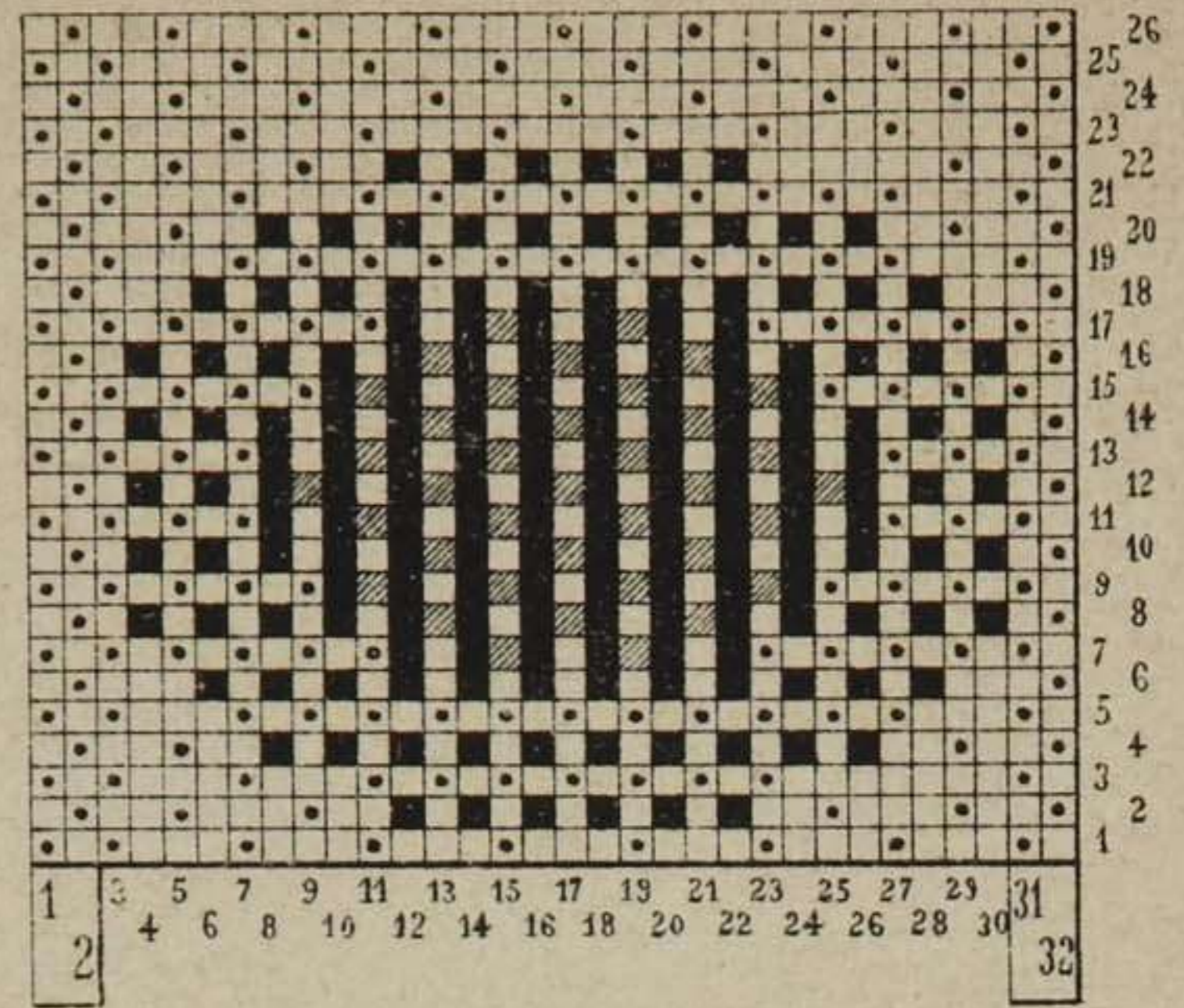


Fig. 999

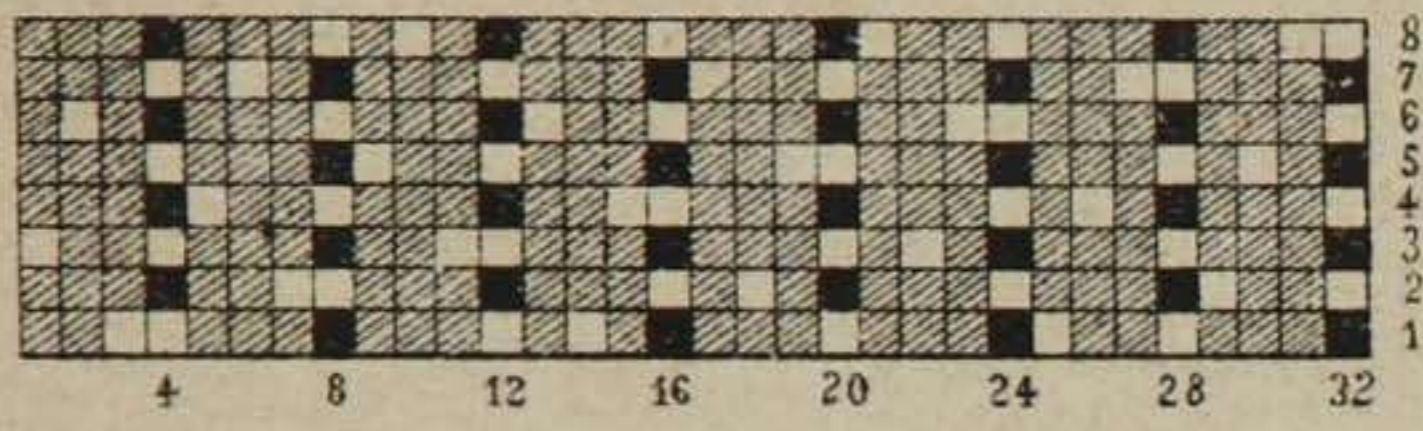


Fig. 997

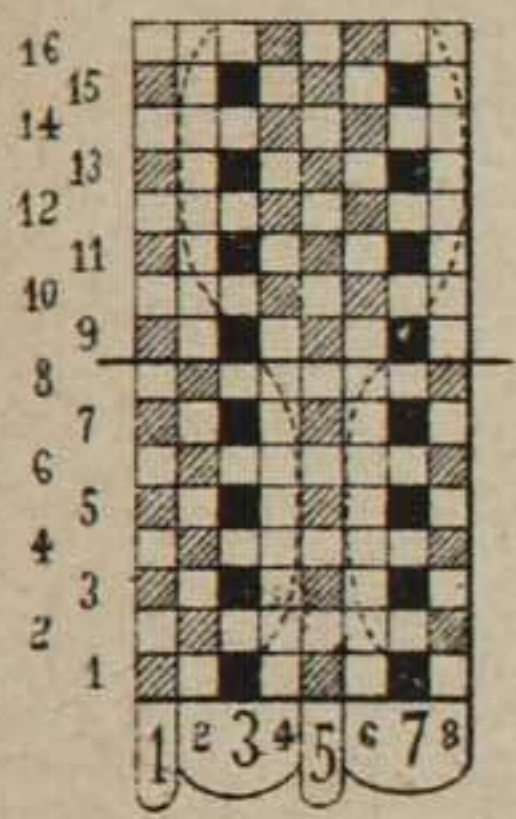


Fig. 993

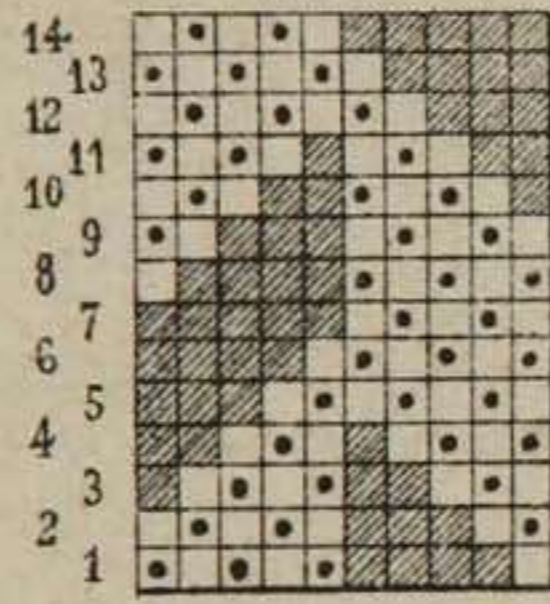


Fig. 995

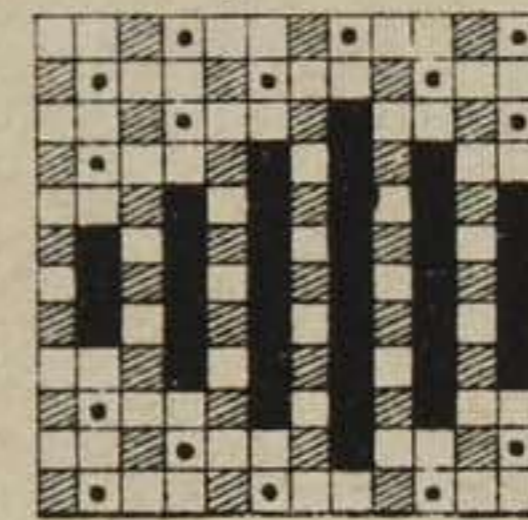


Fig. 989

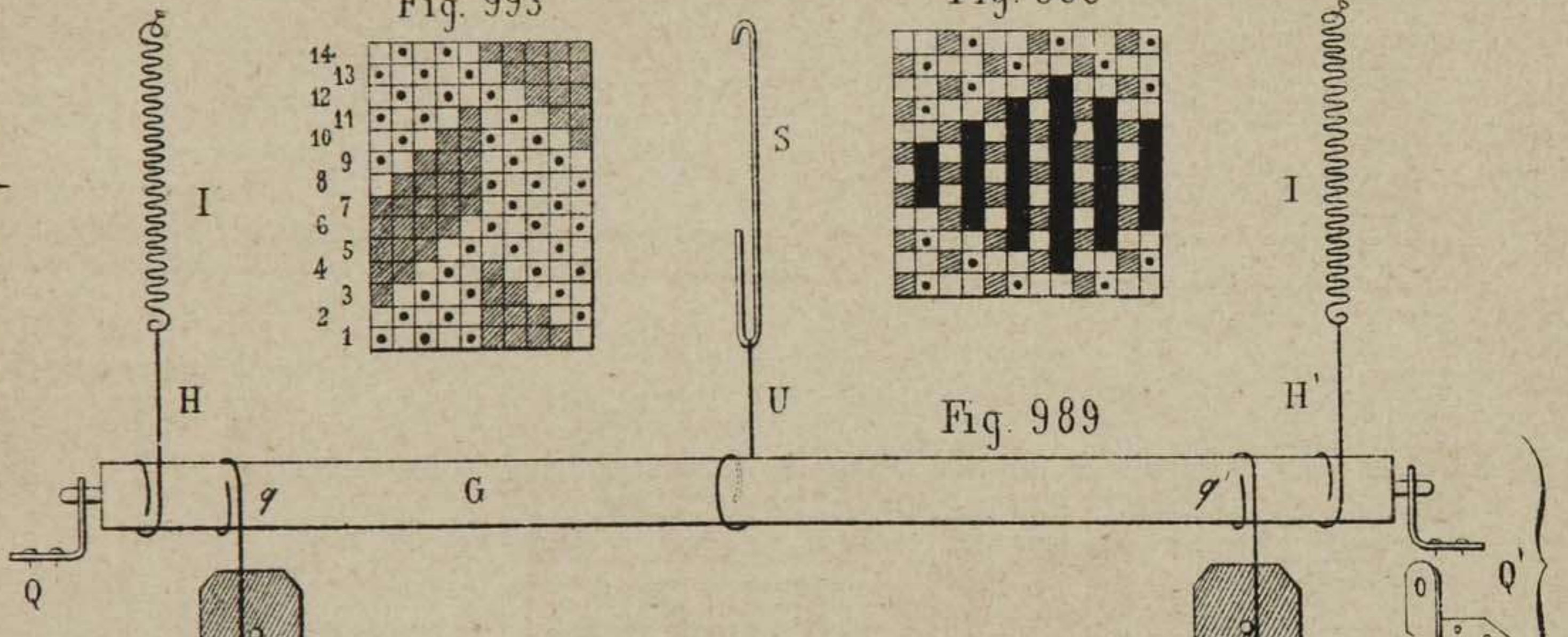


Fig. 994

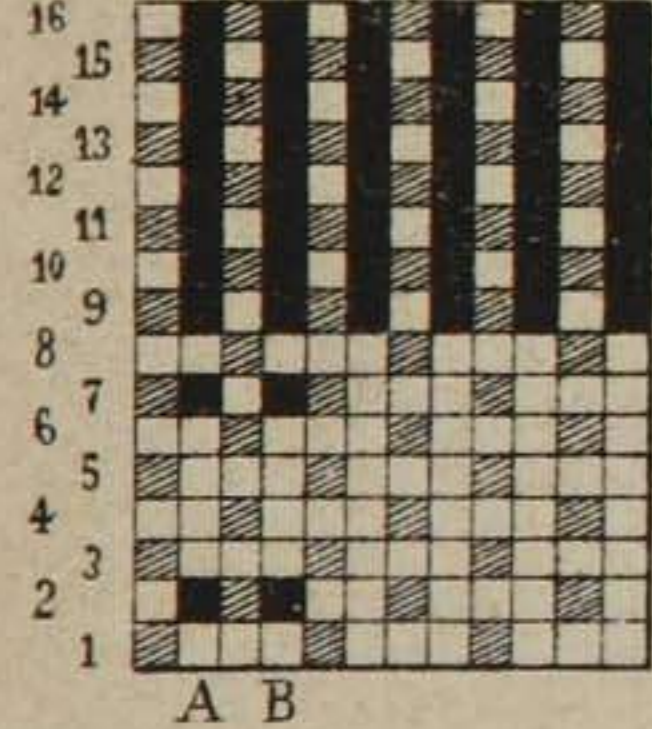


Fig. 1000

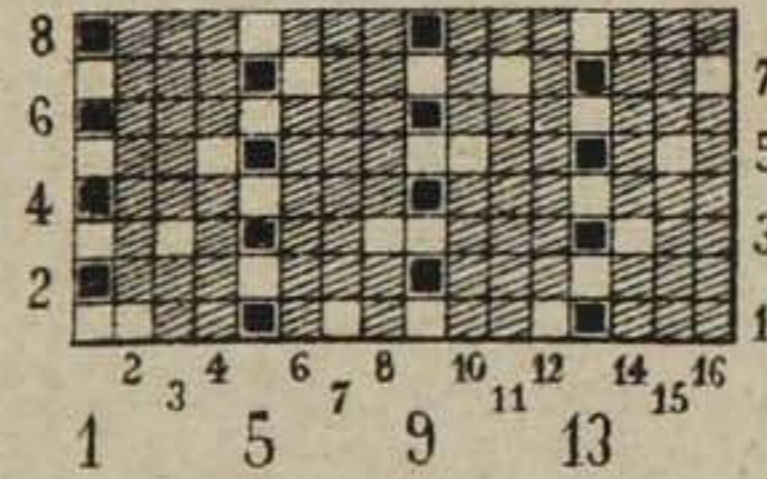
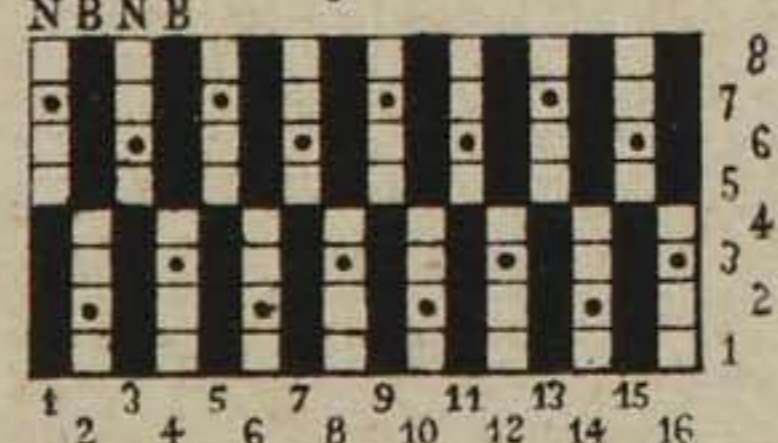


Fig. 1001



Leyenda

N hilos negros 1 3 5 7 9 11 13 15
B hilos azules 2 4 6 8 10 12 14 16

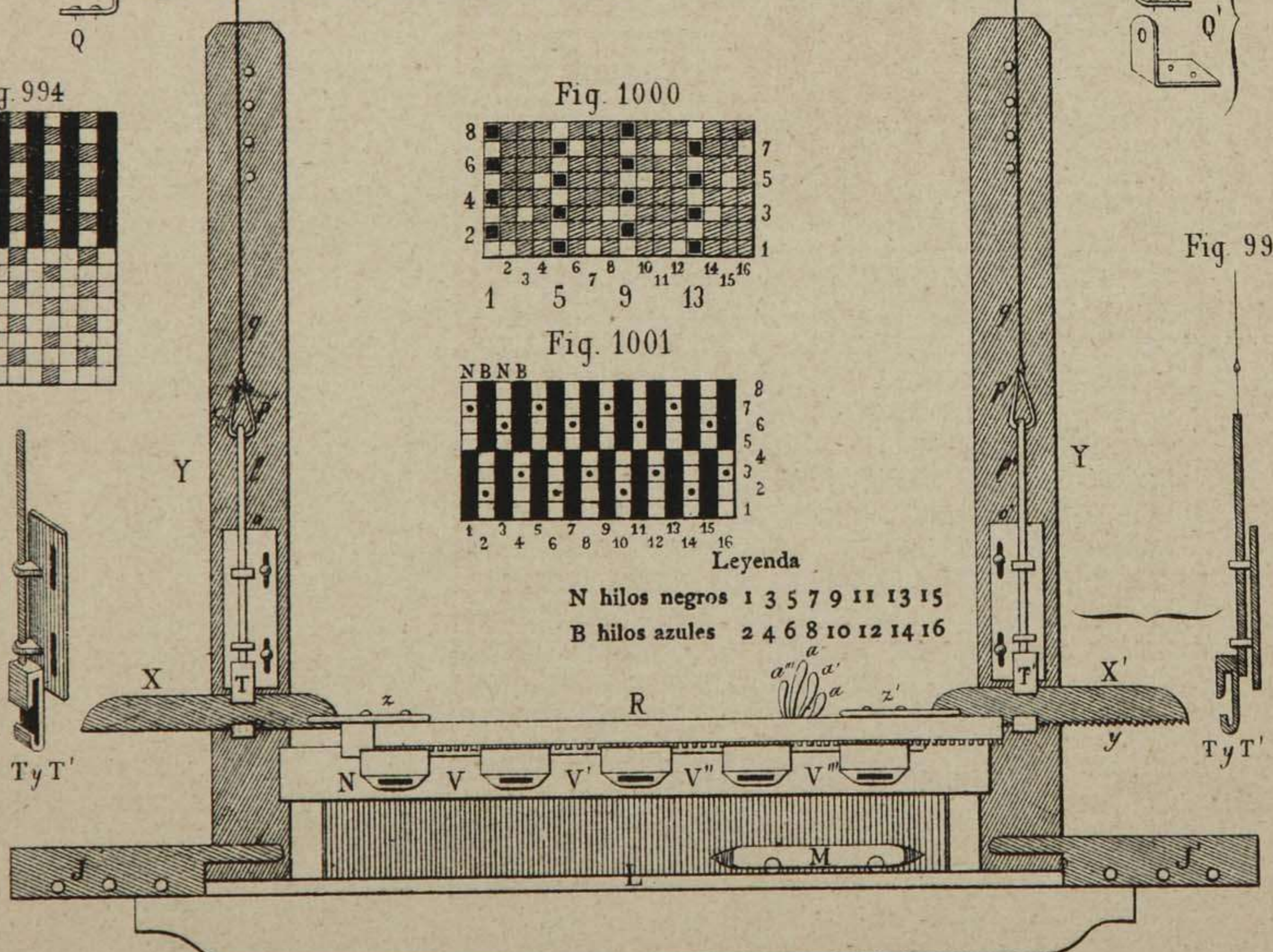
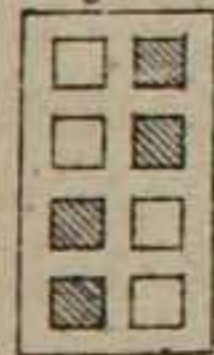
Fig. 991

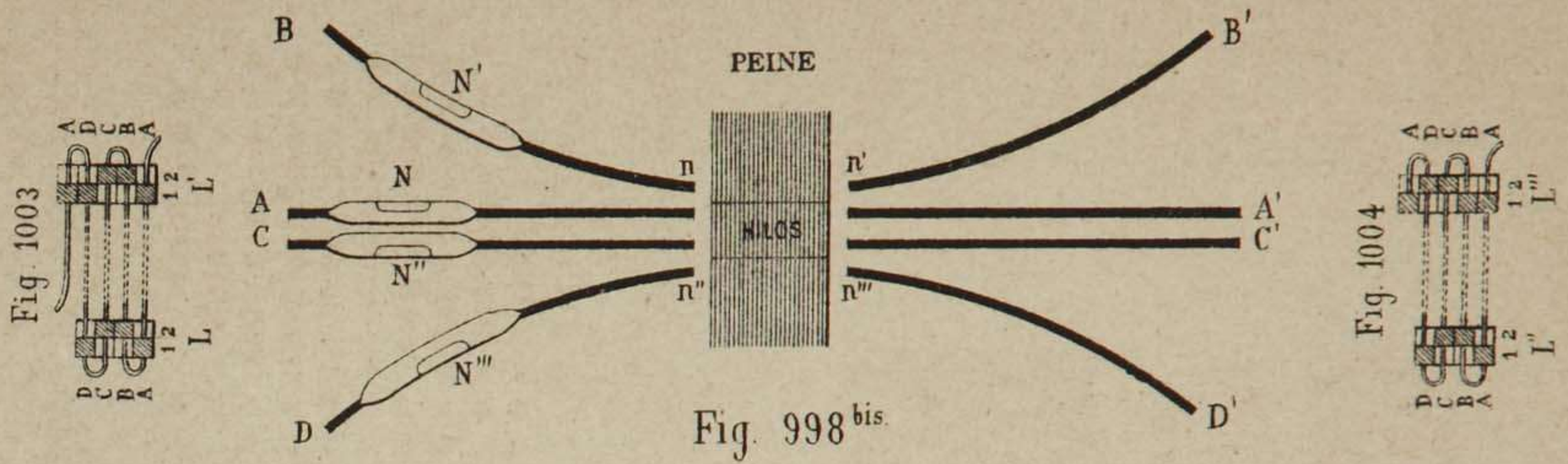


Fig. 990



Fig. 1002





VARAL DE J. B. DAVID

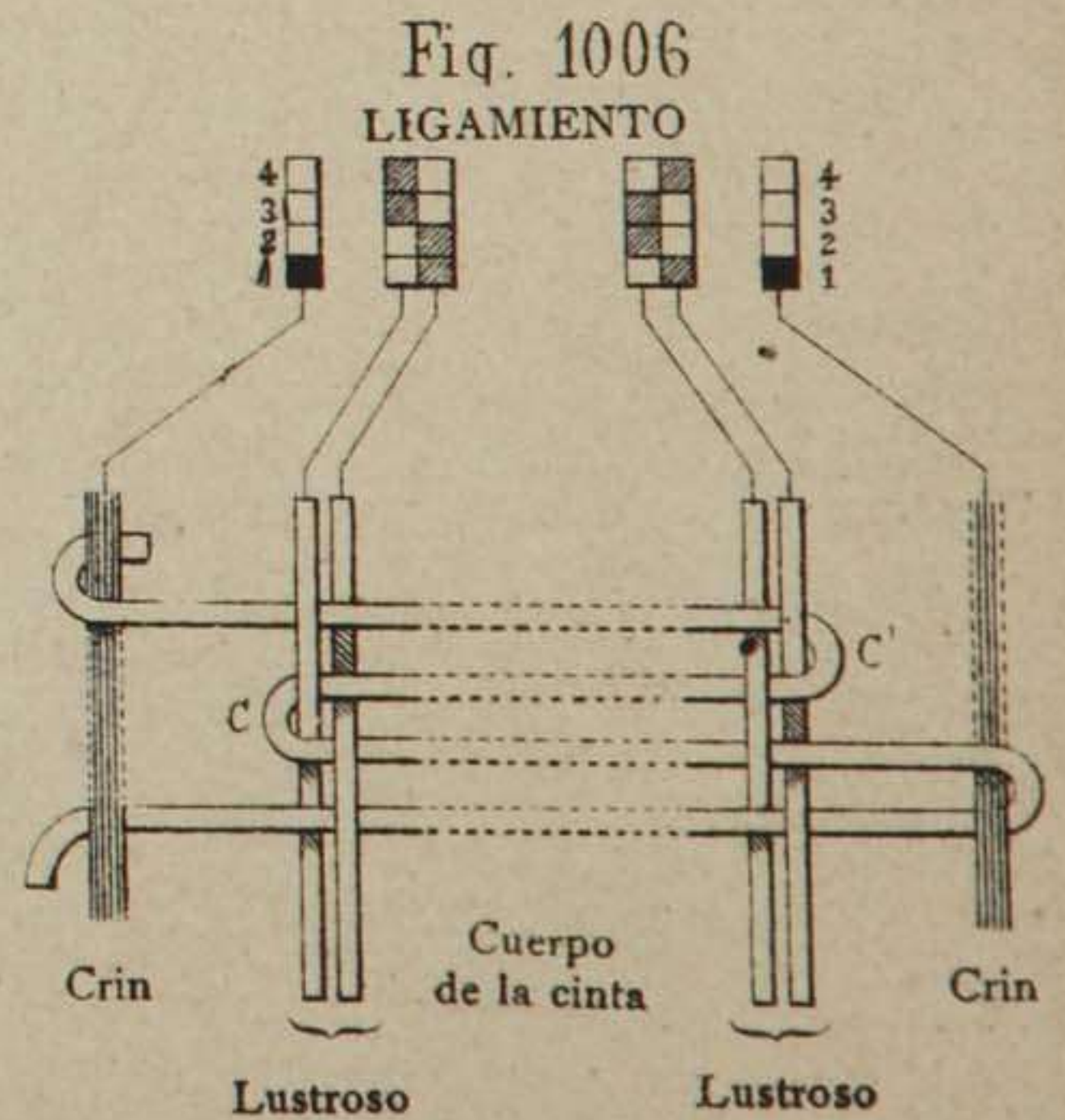
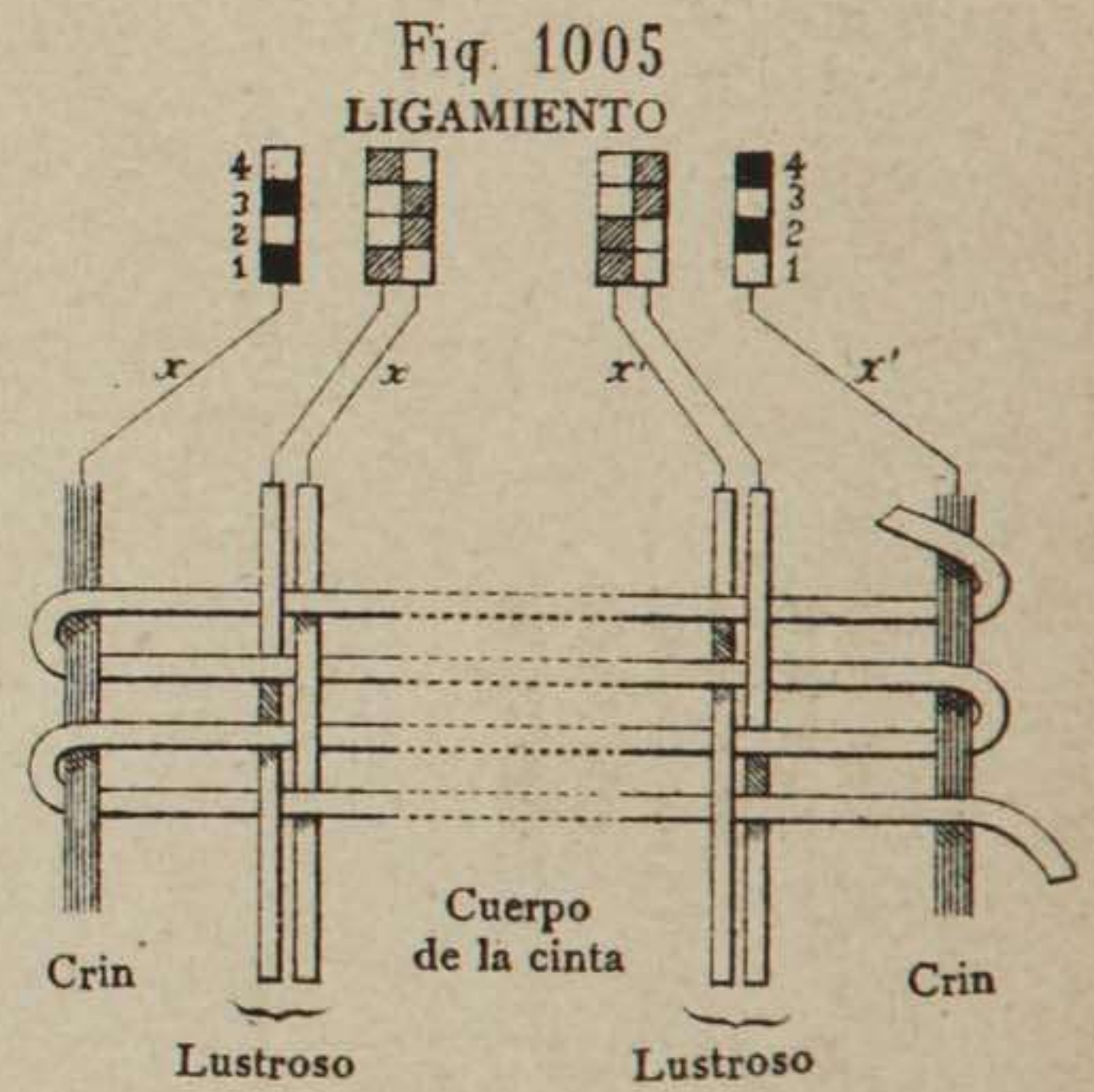
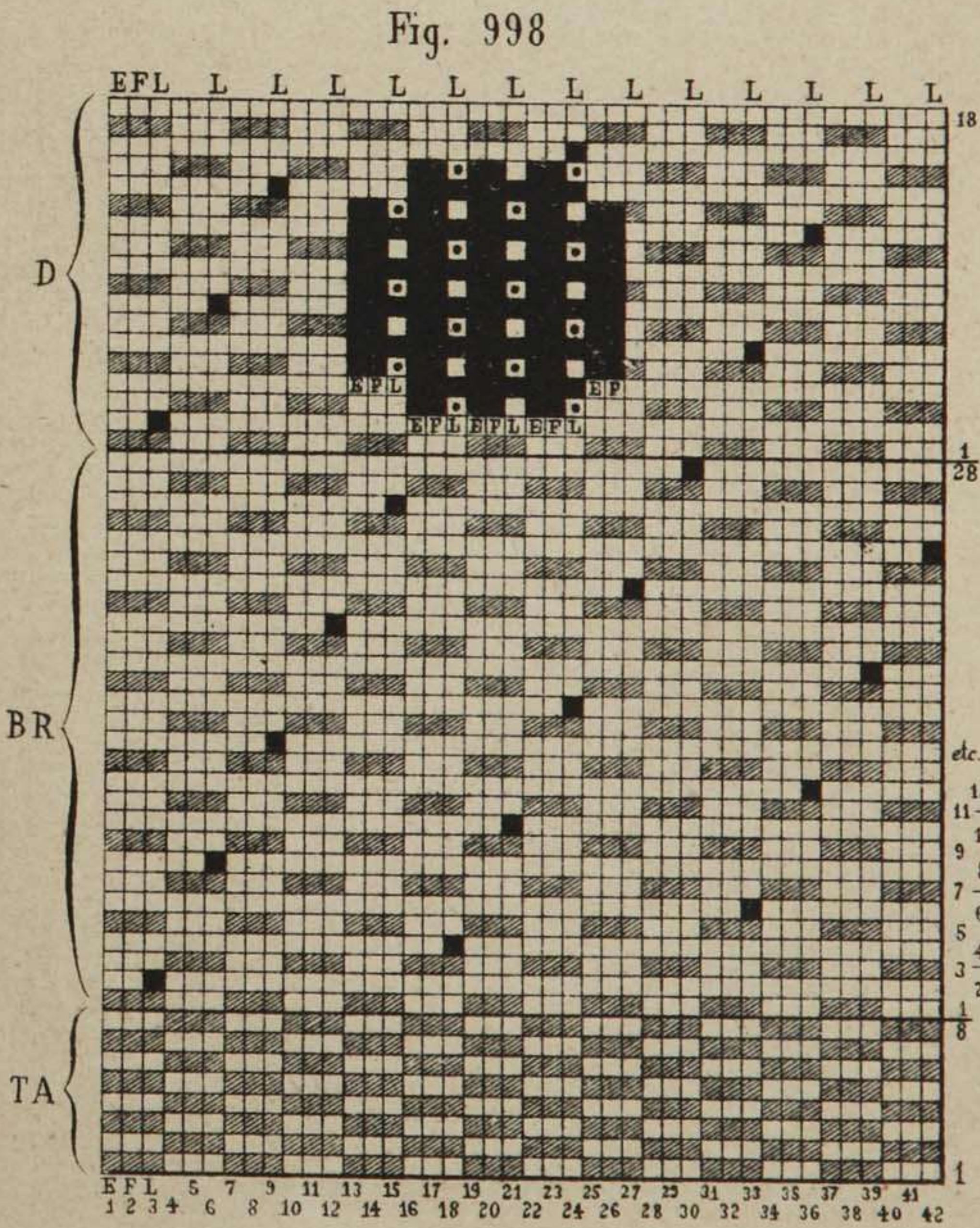
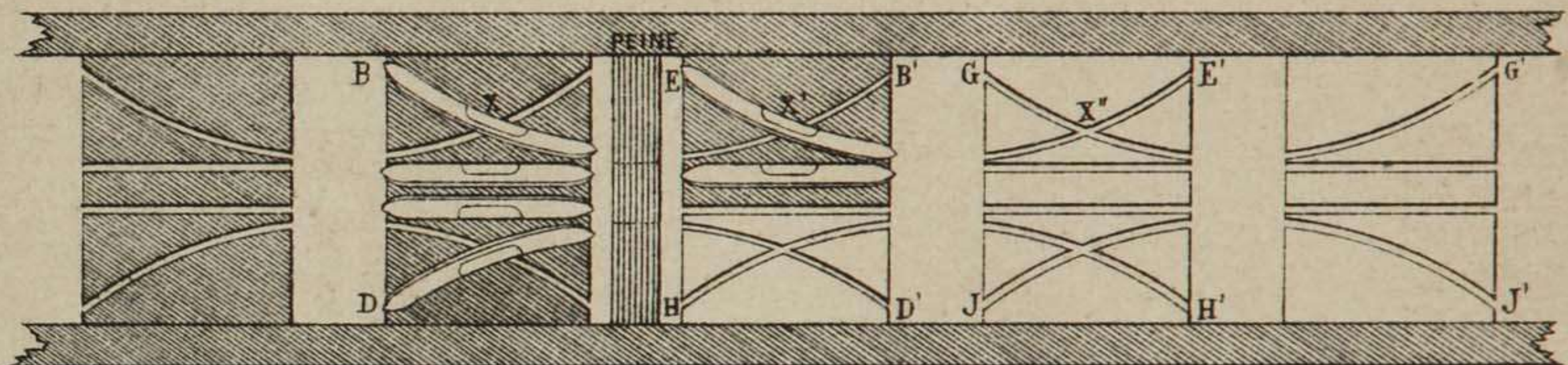


Fig. 1007

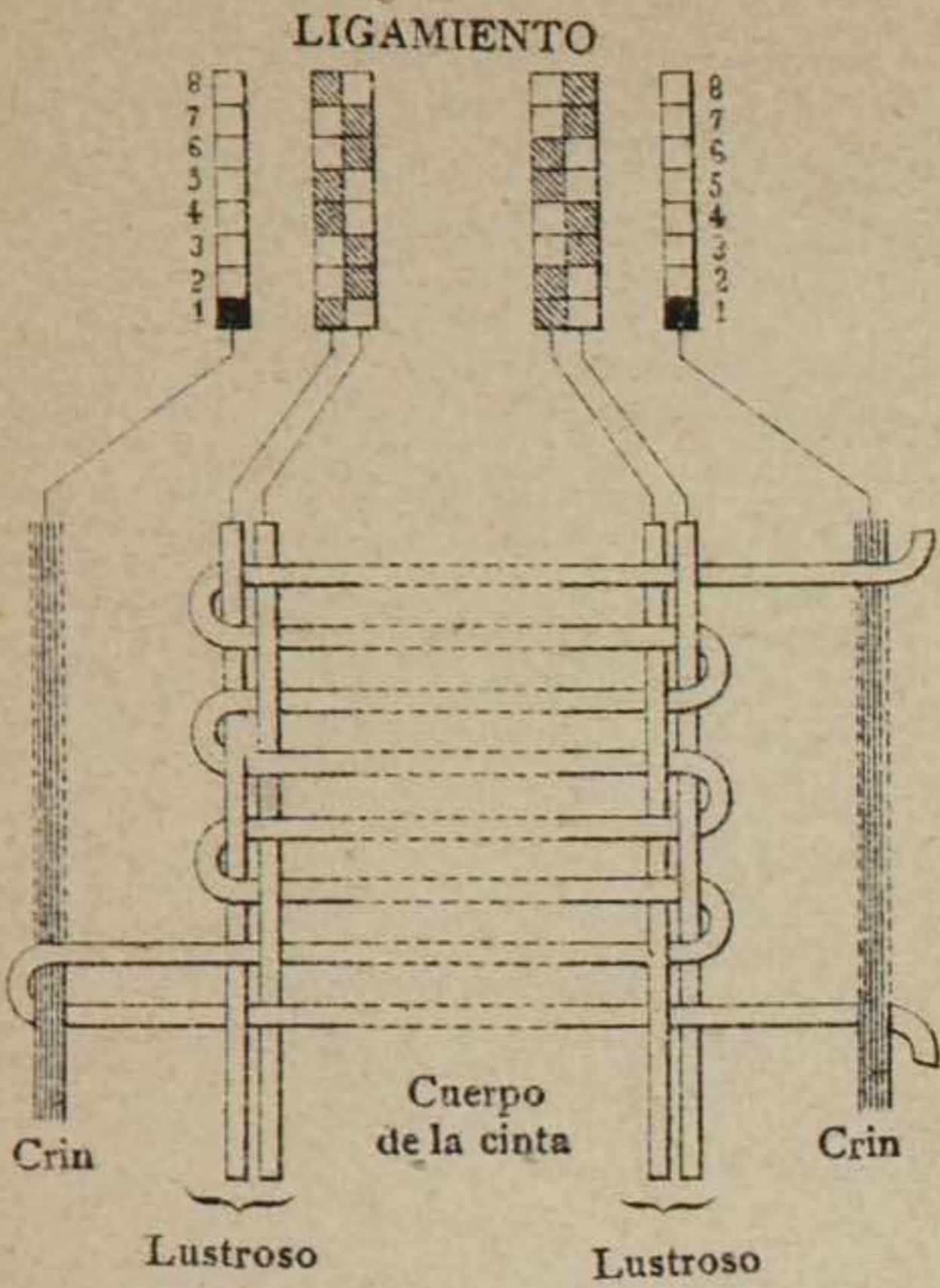


Fig. 1011

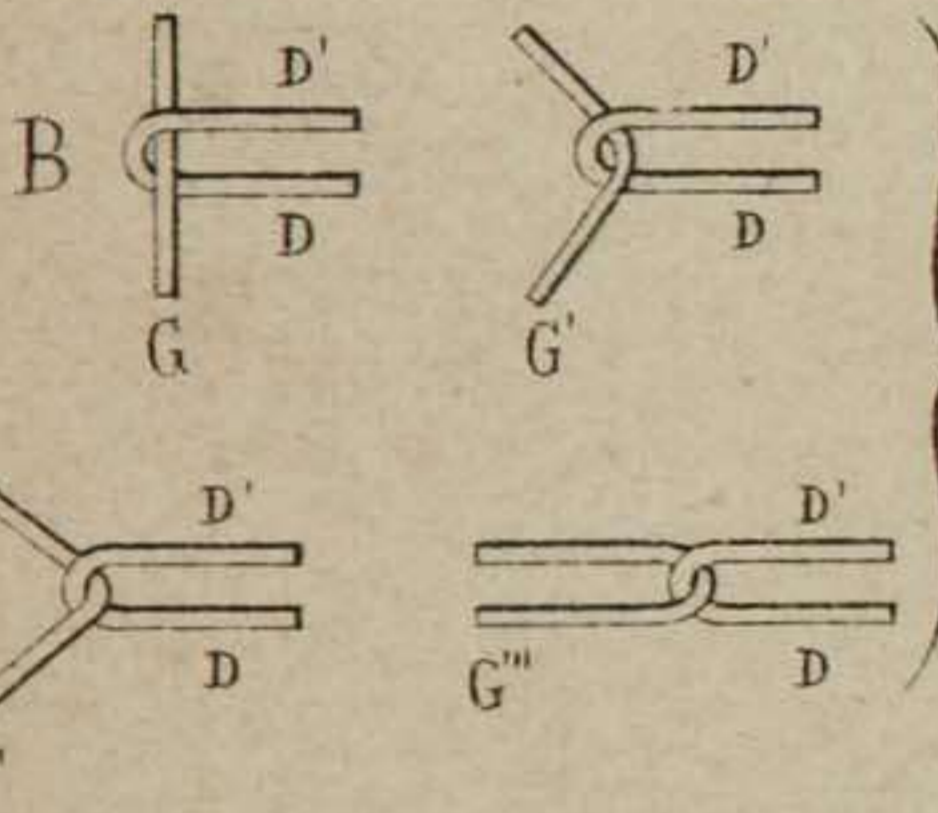
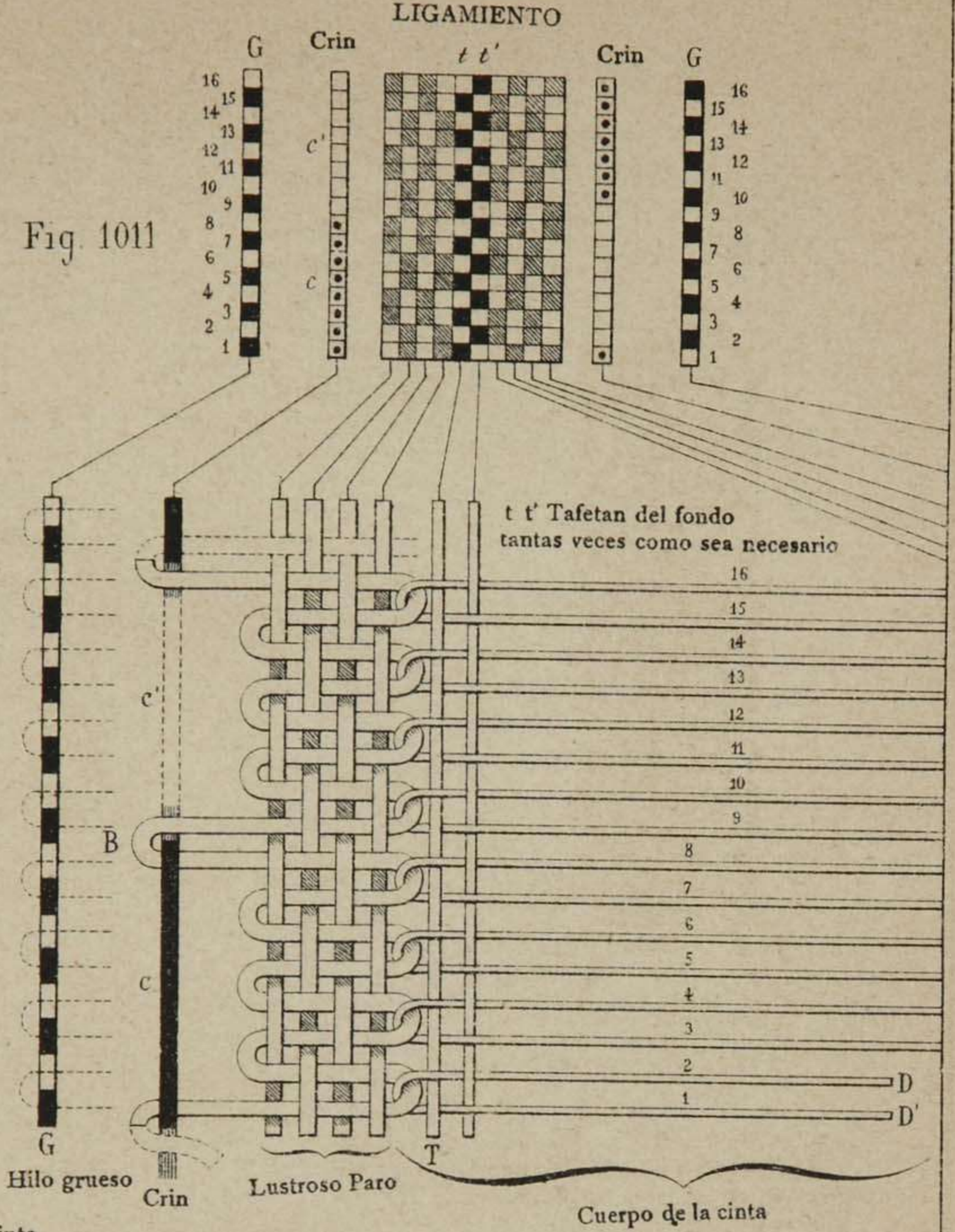


Fig. 1009

Fig. 1010

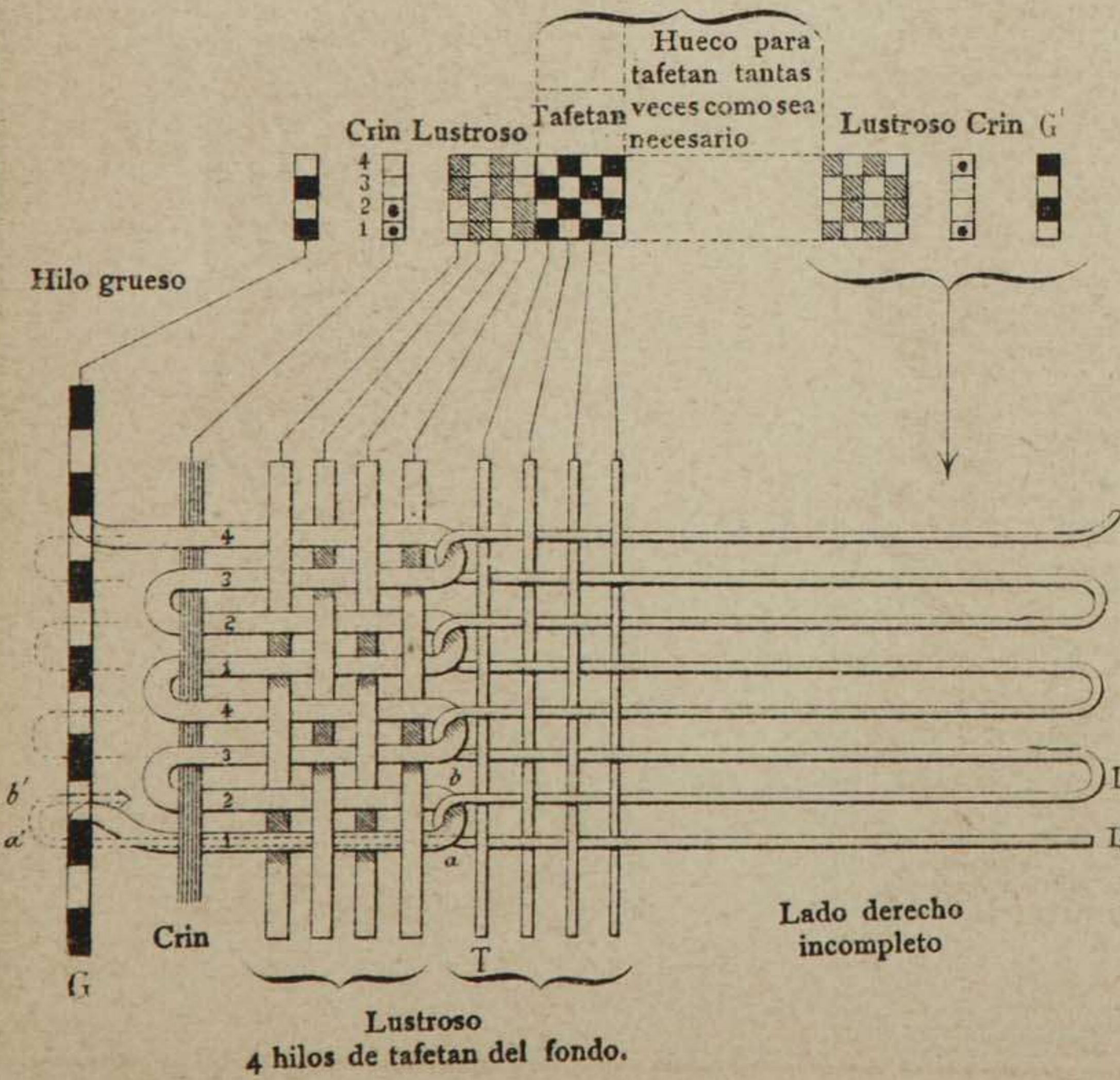


Fig. 1008

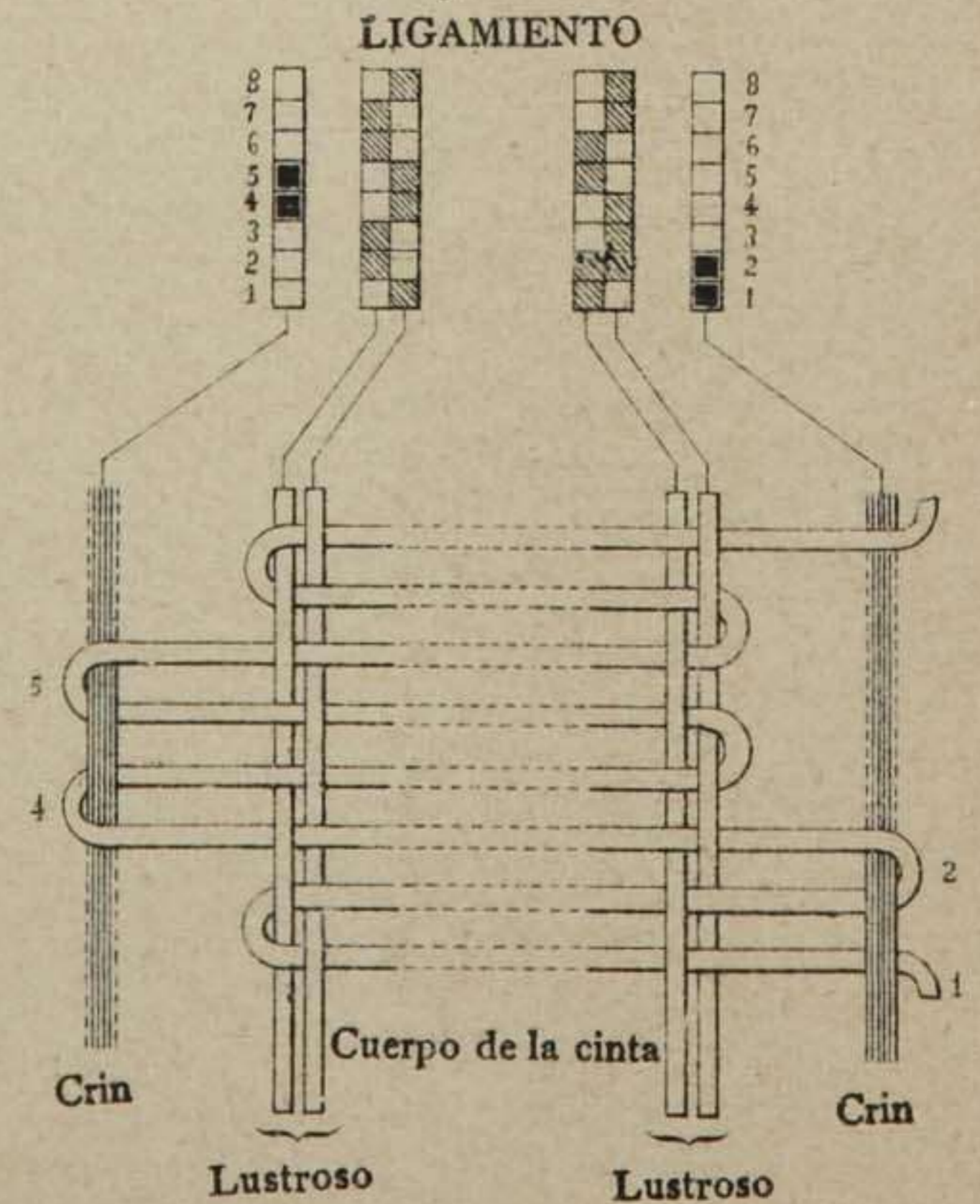




Fig. 1012

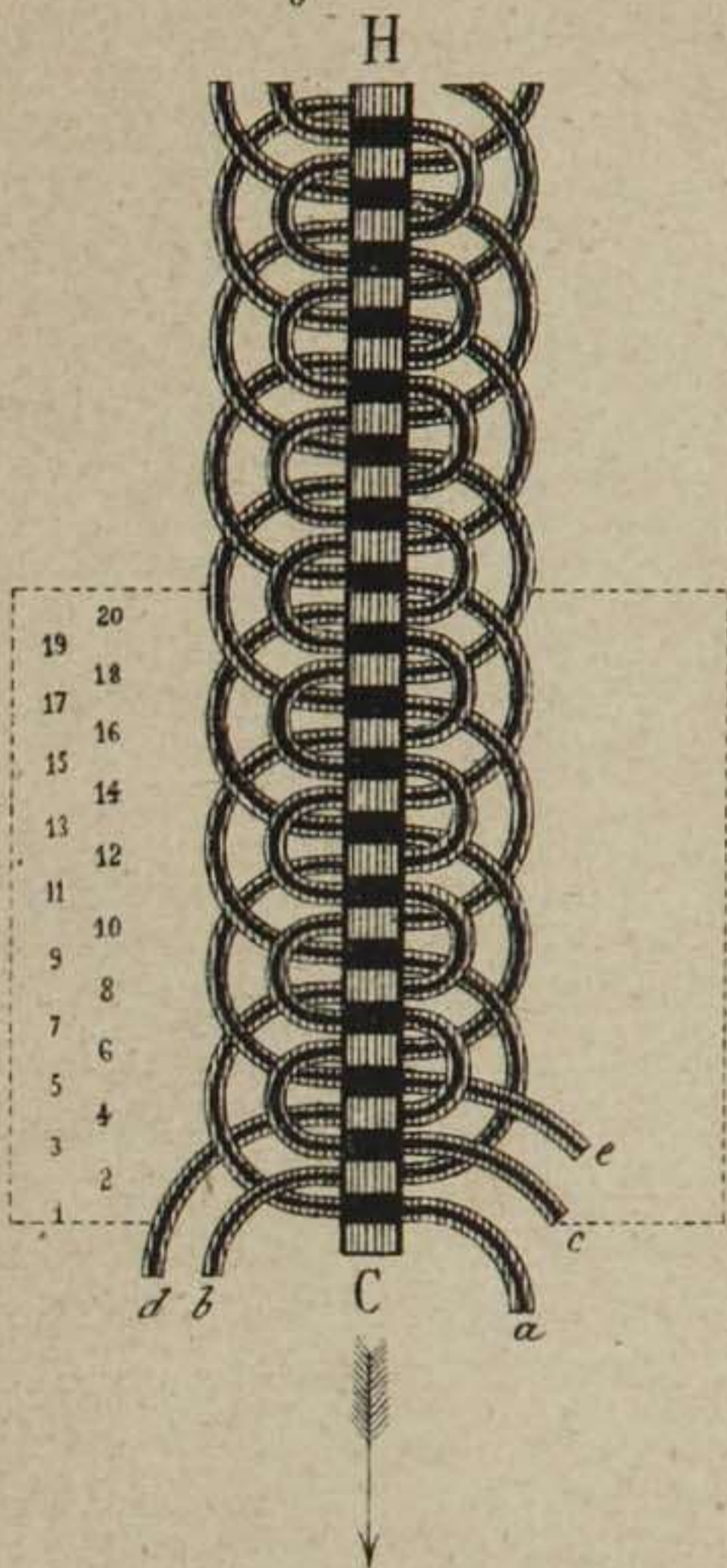


Fig. 1013

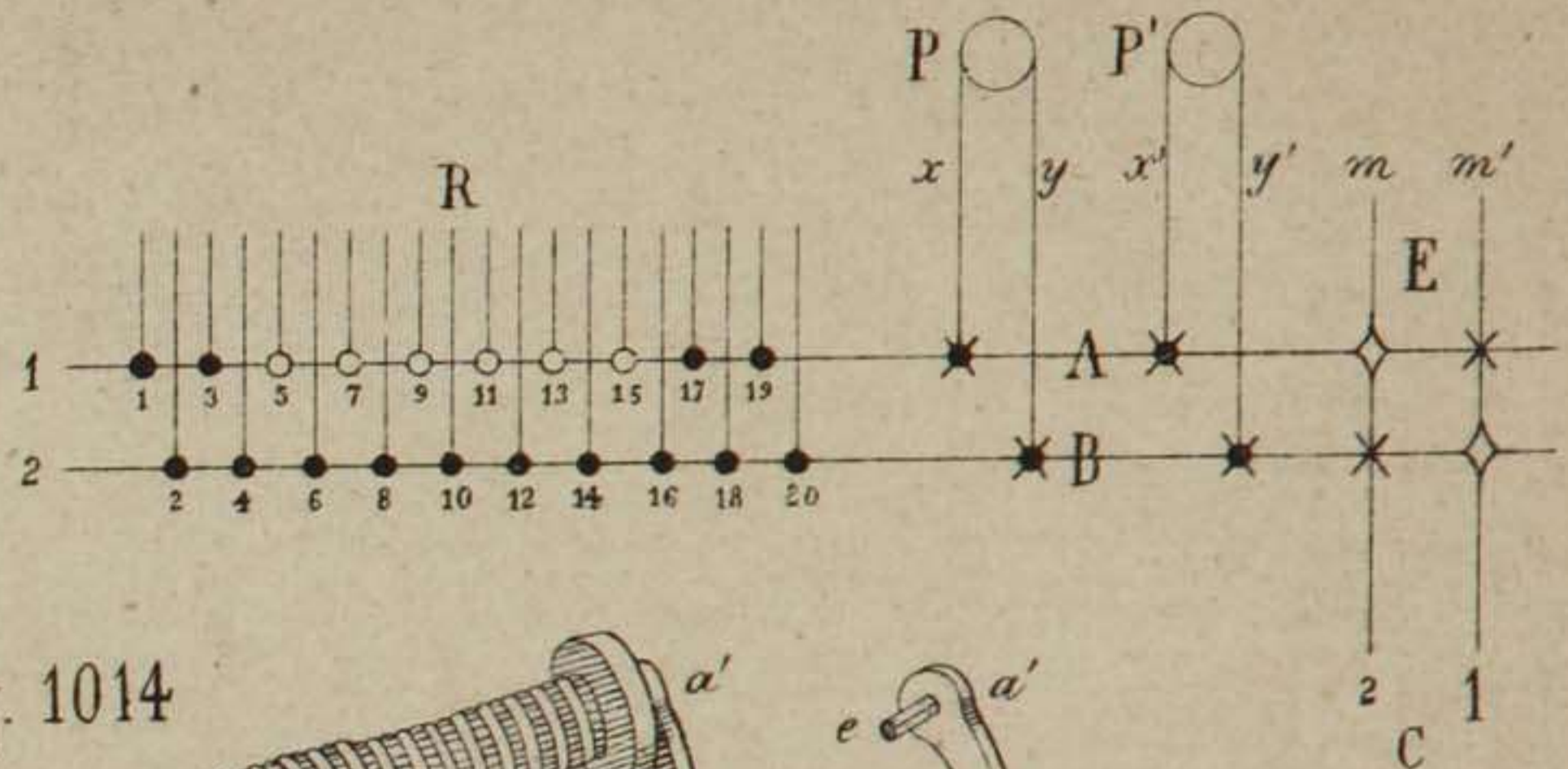


Fig. 1014

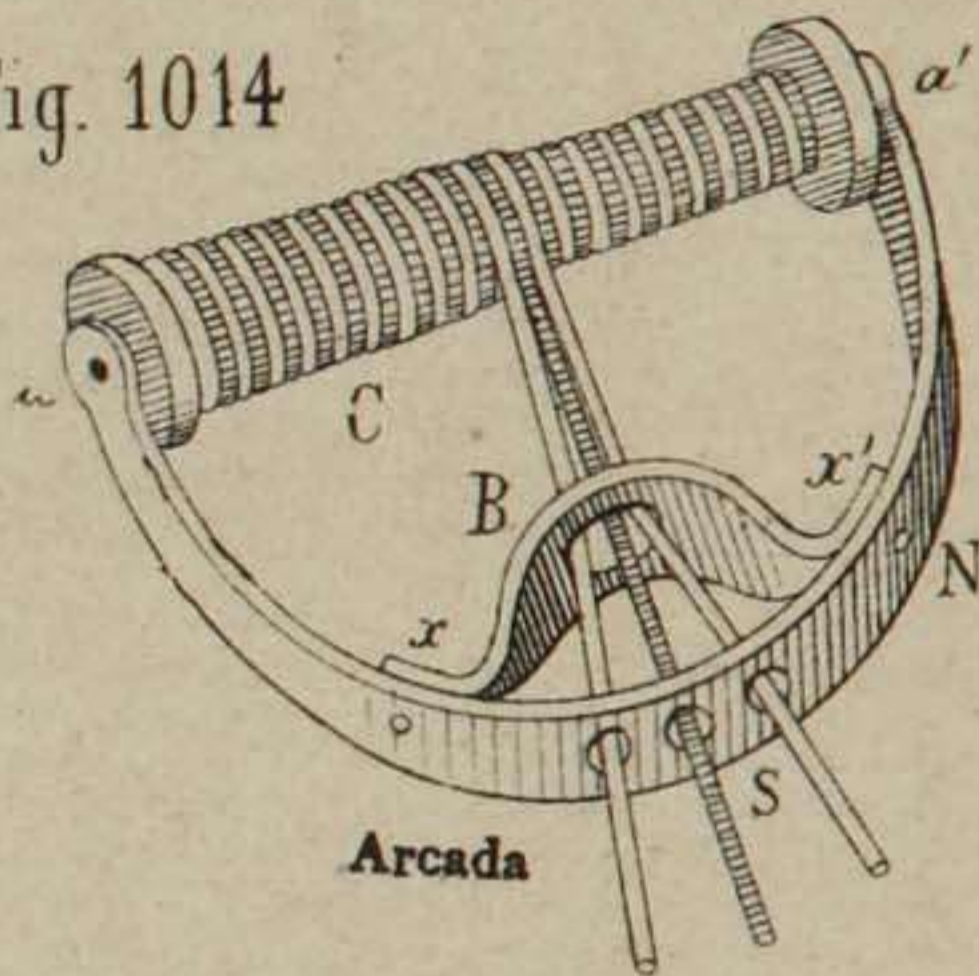


Fig. 1015

Fig. 1020

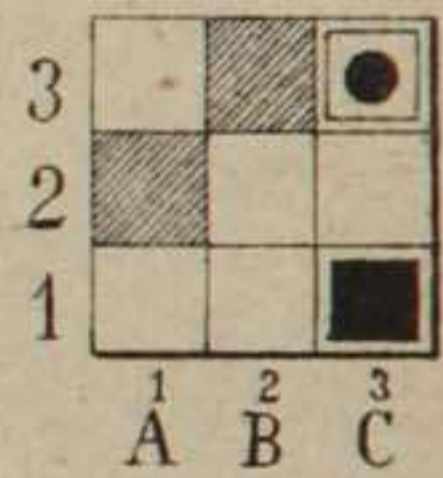
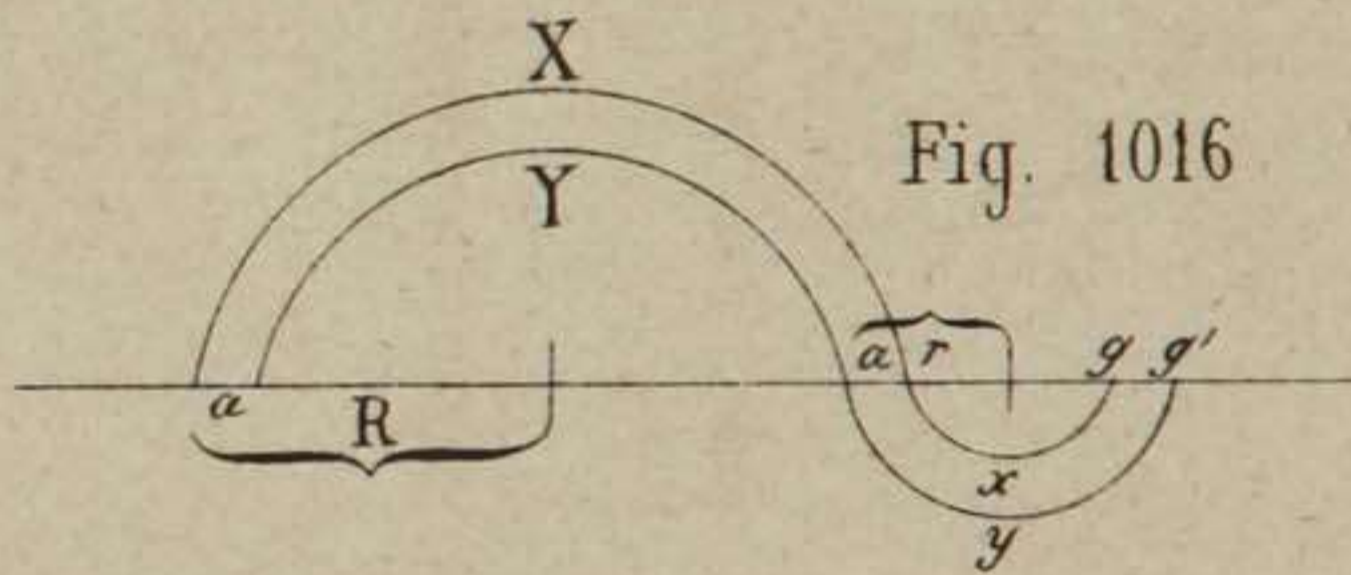


Fig. 1016



Igual dibujo que el de la fig. 1012 pero con un urdimbre de 36 hilos de igual color.

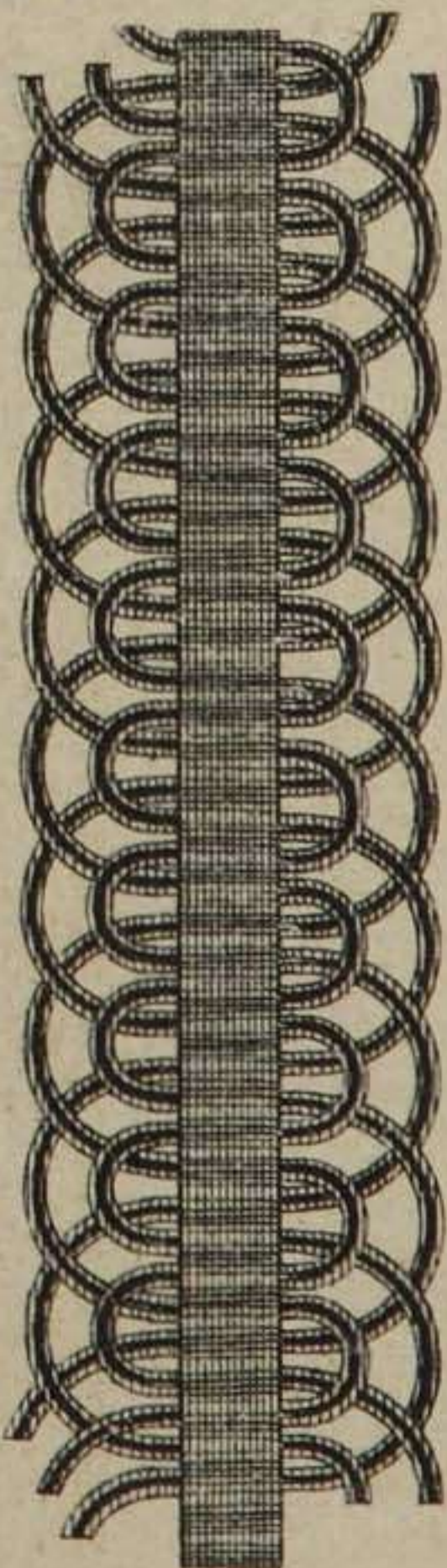


Fig. 1017

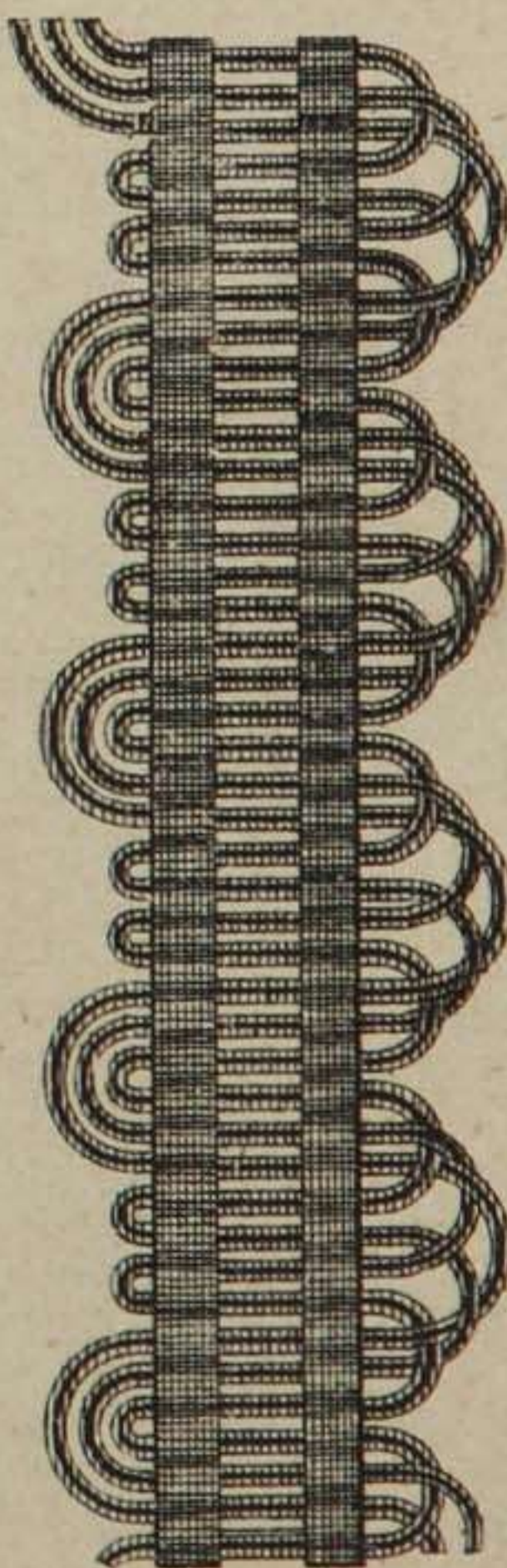
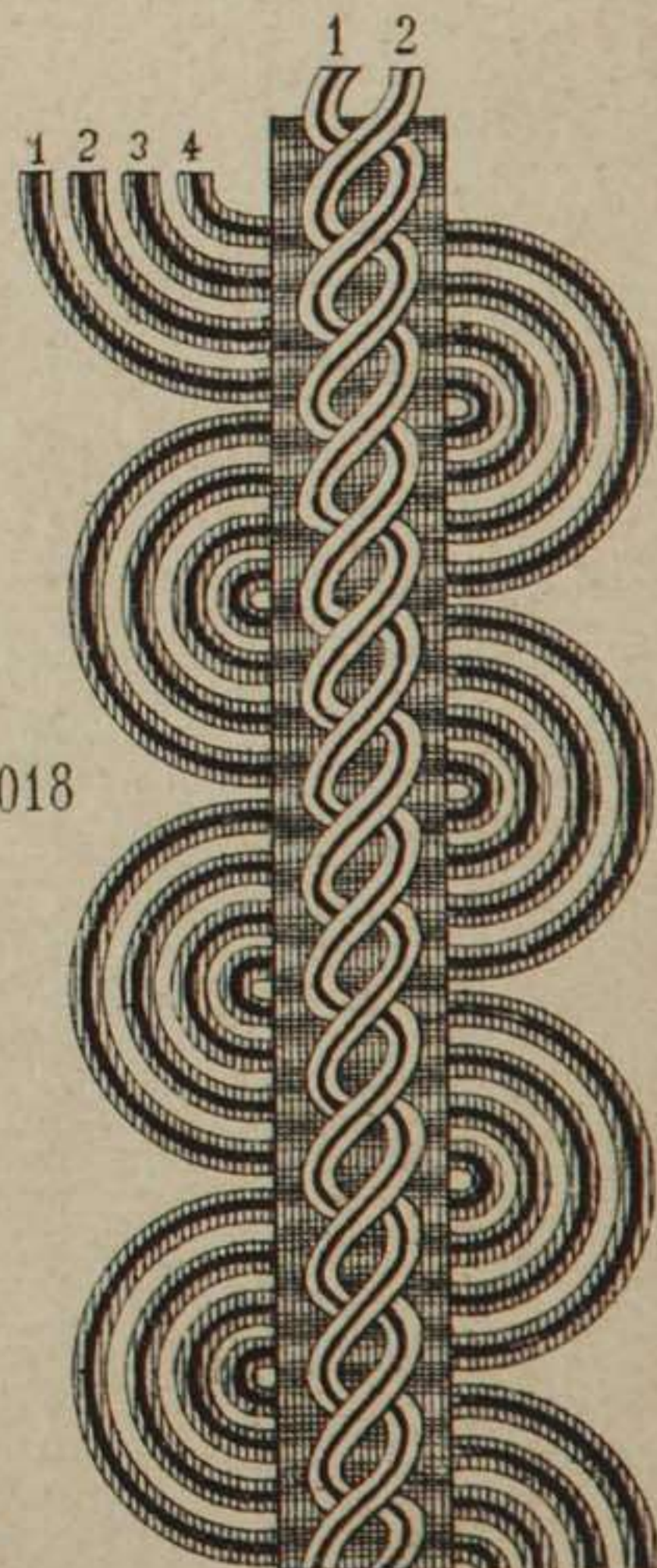
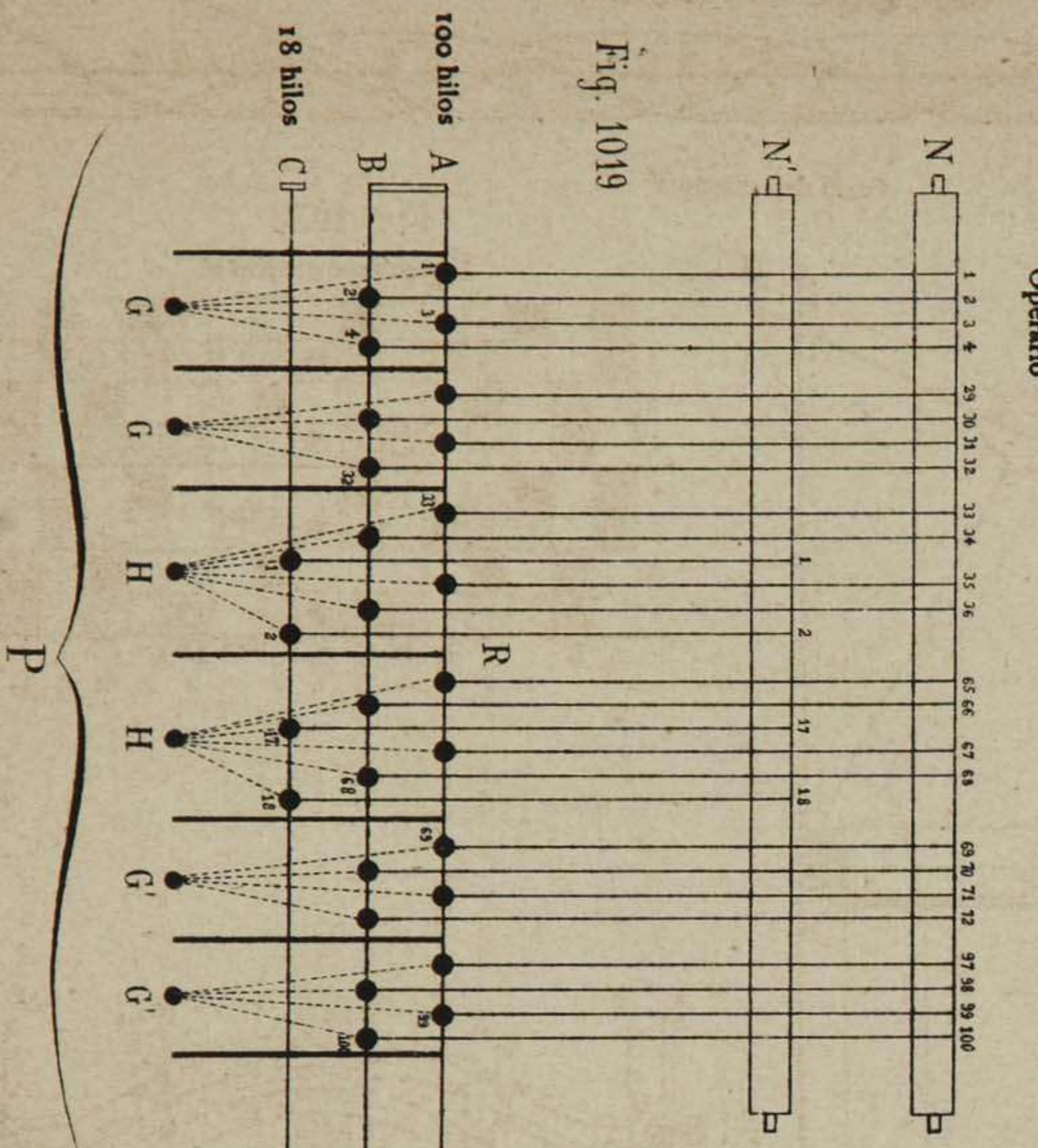
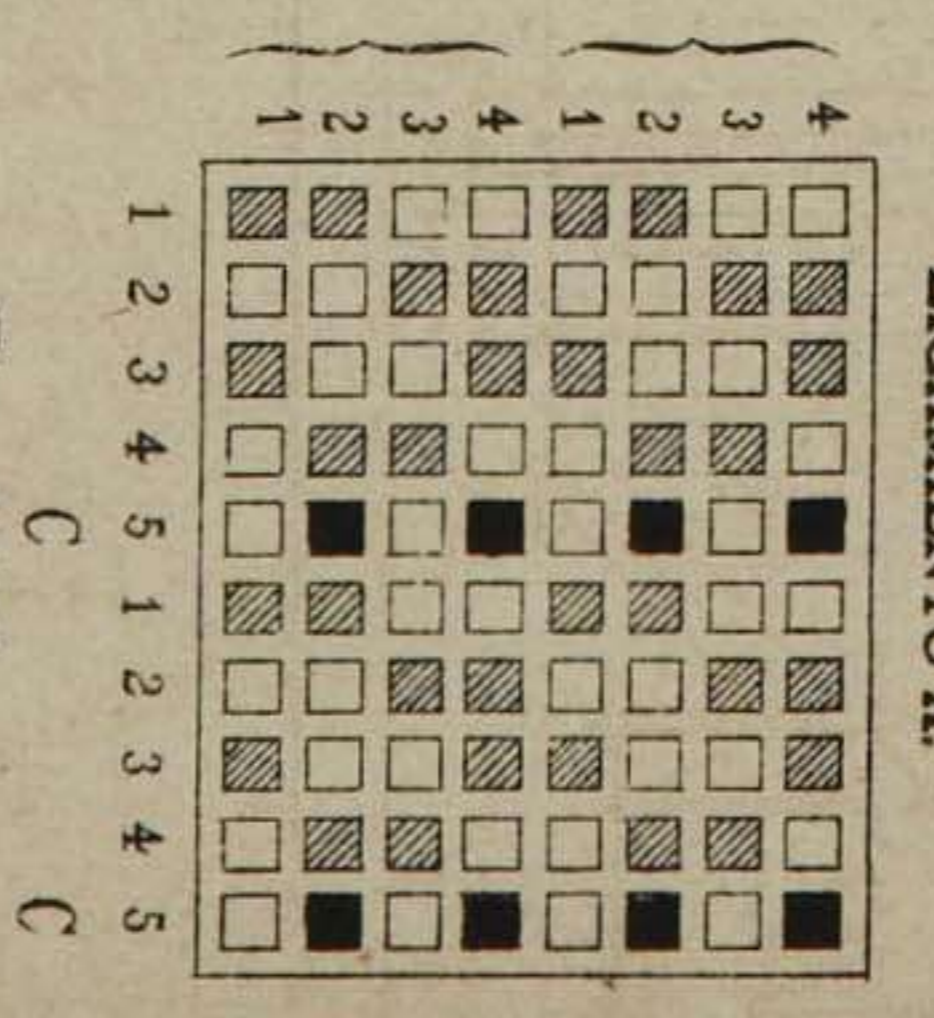
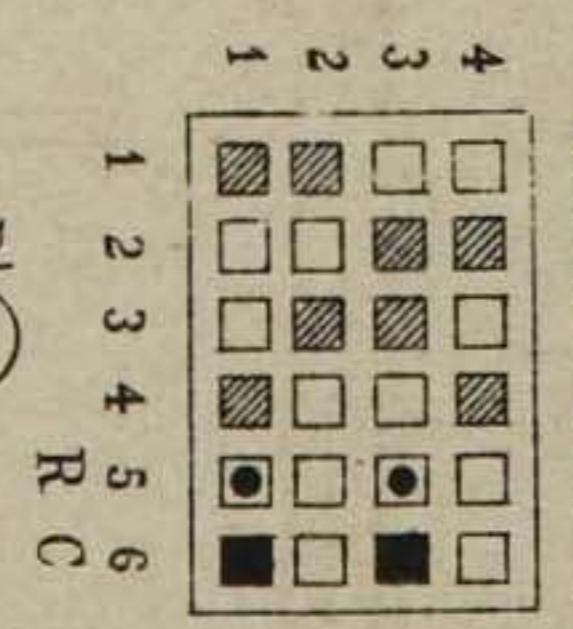
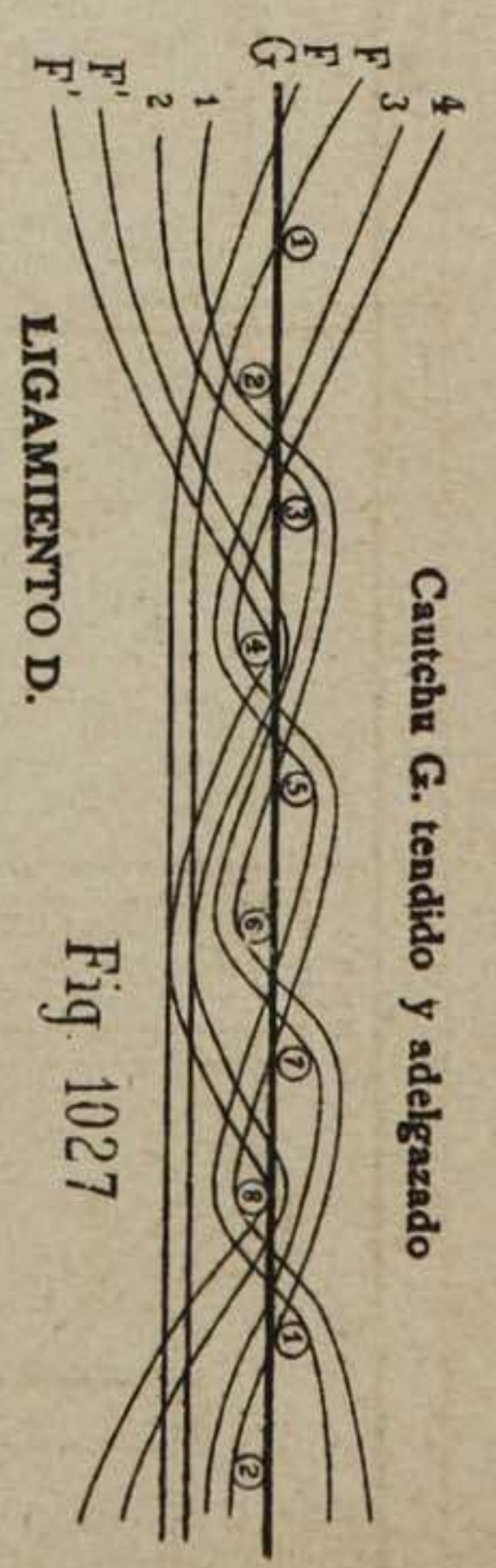
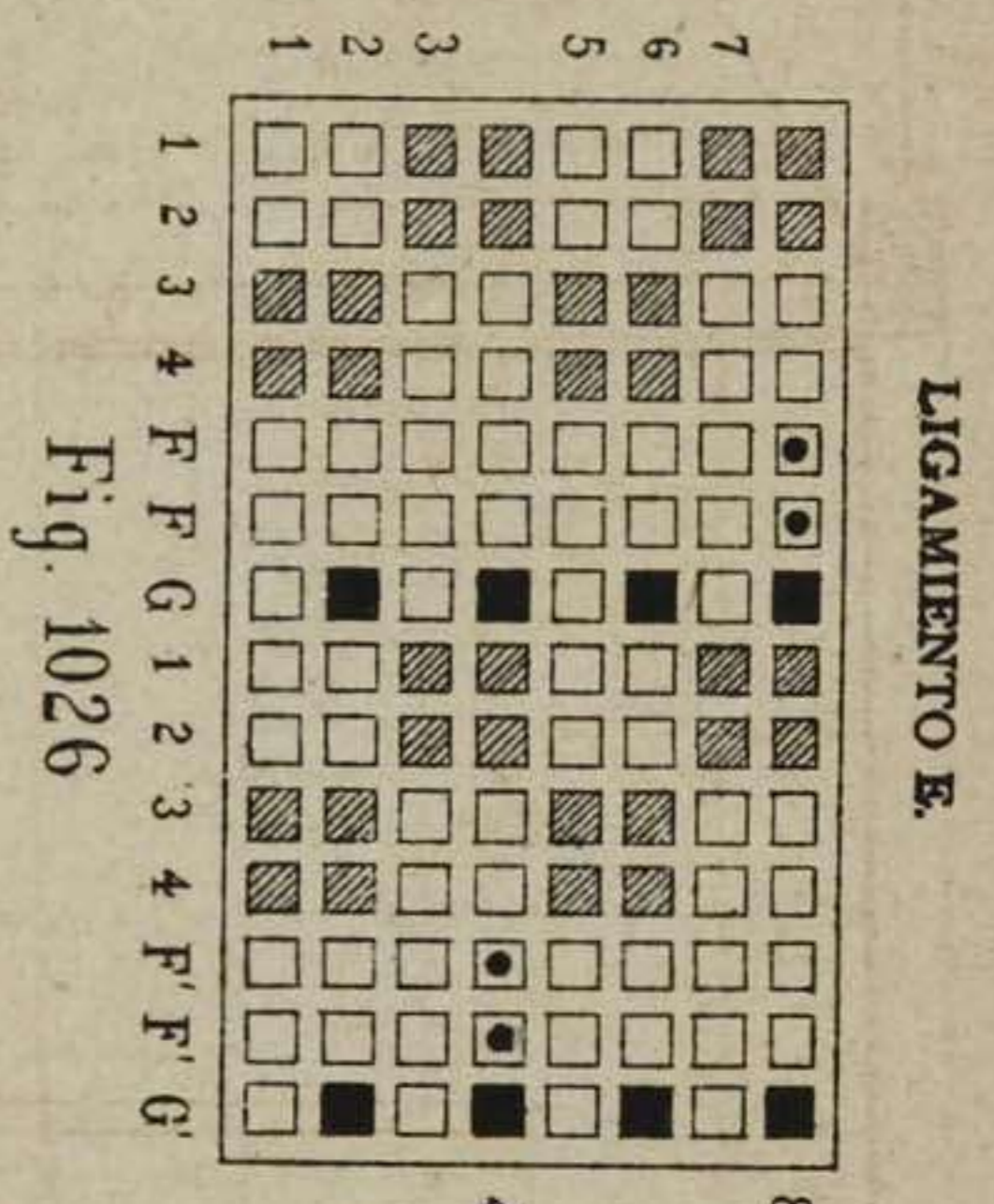
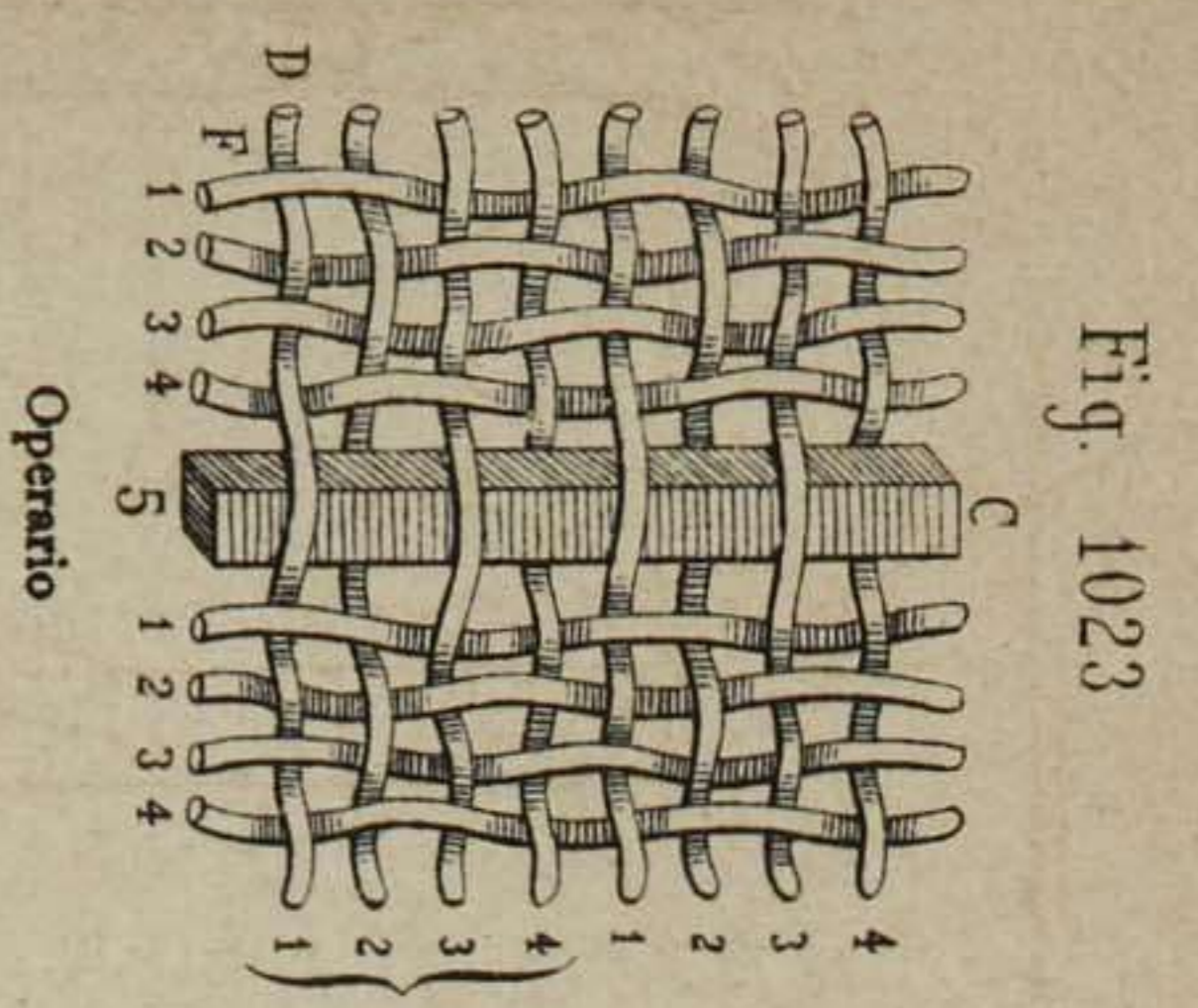
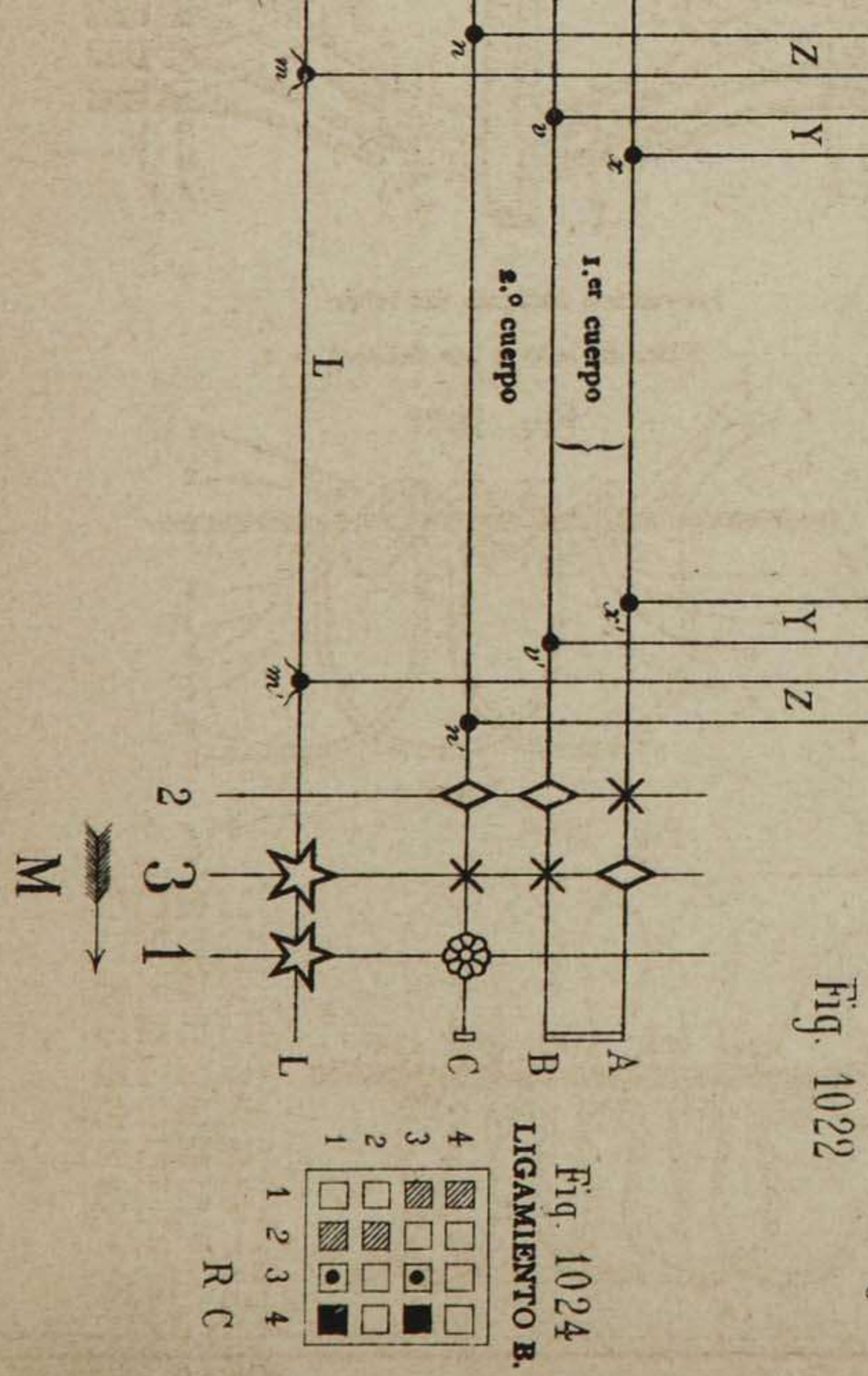
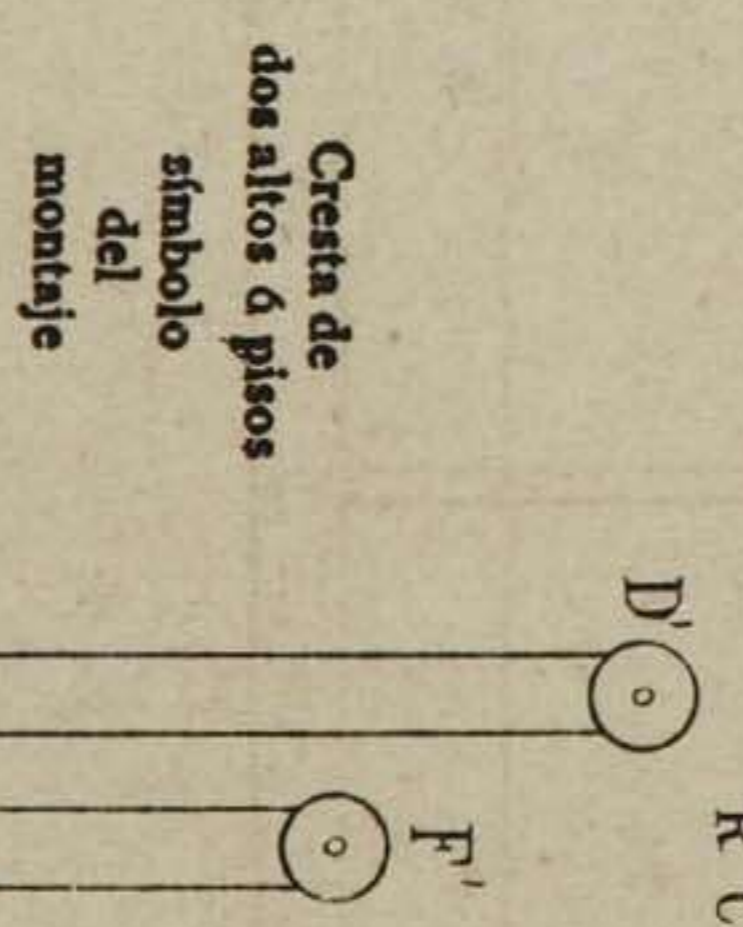


Fig. 1018





Sistema de proyeccion adoptado en la práctica para la espresion gráfica de los elementos del montaje.



Modo de tender, retrógrado cada plegadora
 Fig. 1045 (Vista de frente)
 S S' S'' S''' Soportes de las cinco plegadoras
 G A D G I L' P' P' anillos de donde arrancan los
 cordales c c' que soportan la barra B, sobre la
 cual se coloca el peso P en la muesca conve-
 niente.
 h contrapeso que lleva la cuerda de tension
 m m' aplicada convenientemente en la gargan-
 ta V

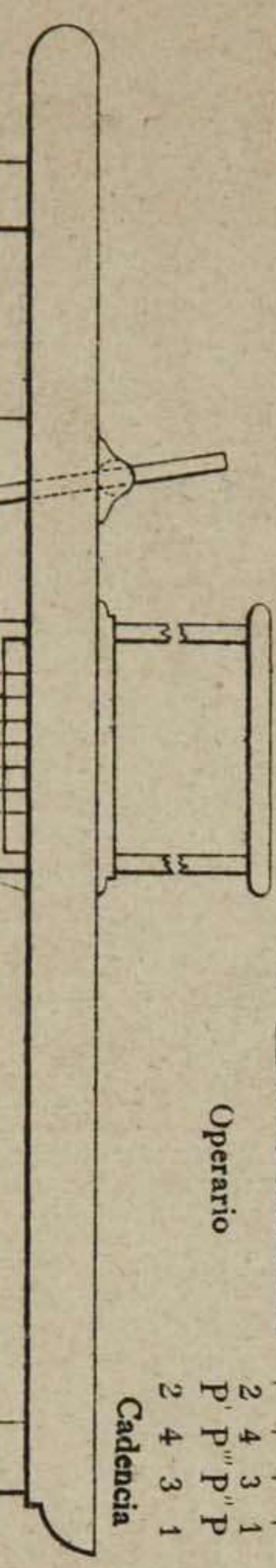
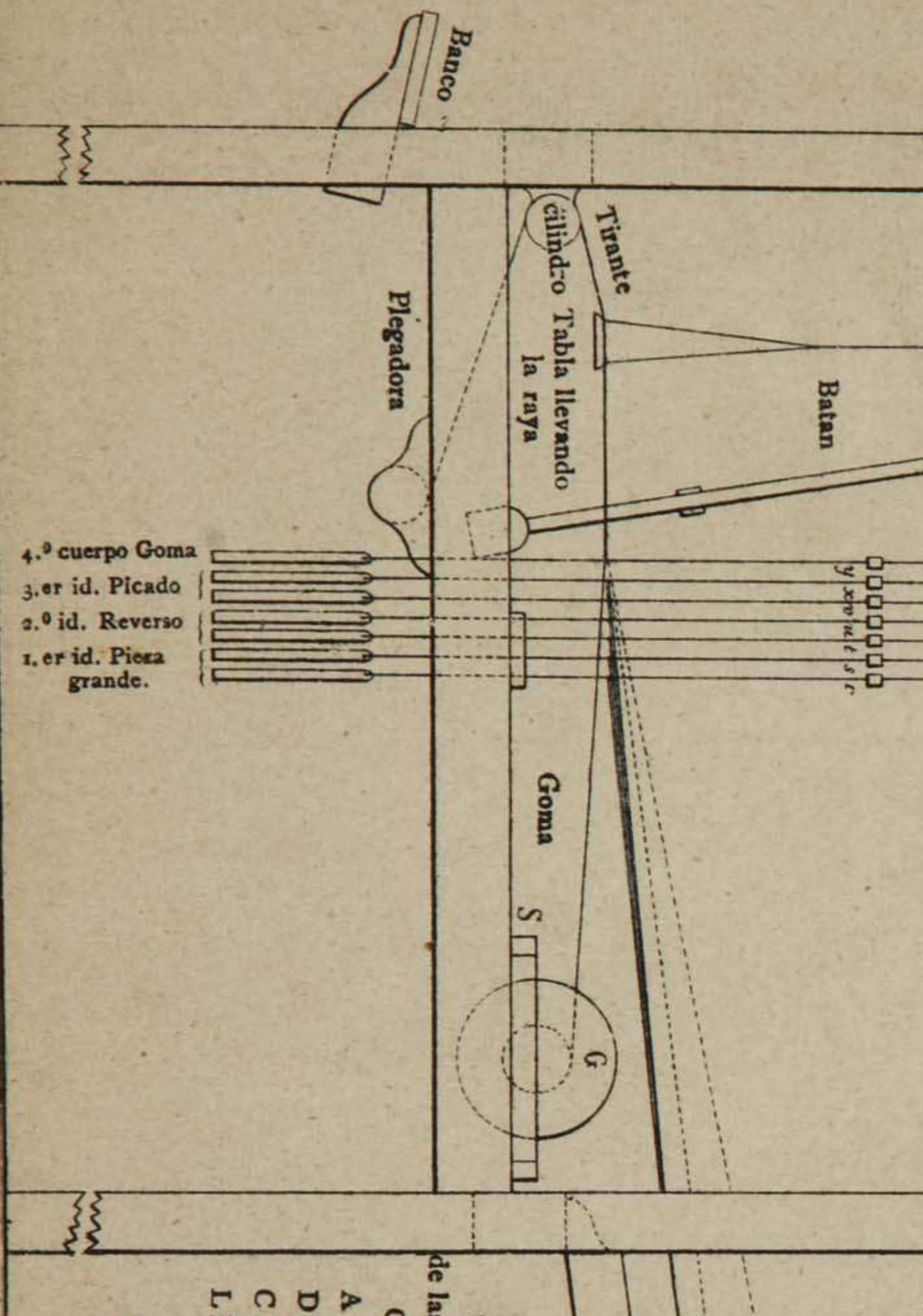


Fig. 1044



0' 4 pedales 0

C' C'' C'''	1	*	1
C' C'' C'''	2	*	2
D D''	3	*	3
D' D'''	4	*	4
A	5	*	5
B	6	*	6
G E	7	*	7

Operario

2	4	3	1
P'	P''	P'''	P
2	4	3	1

Cadencia

Fig. 1045

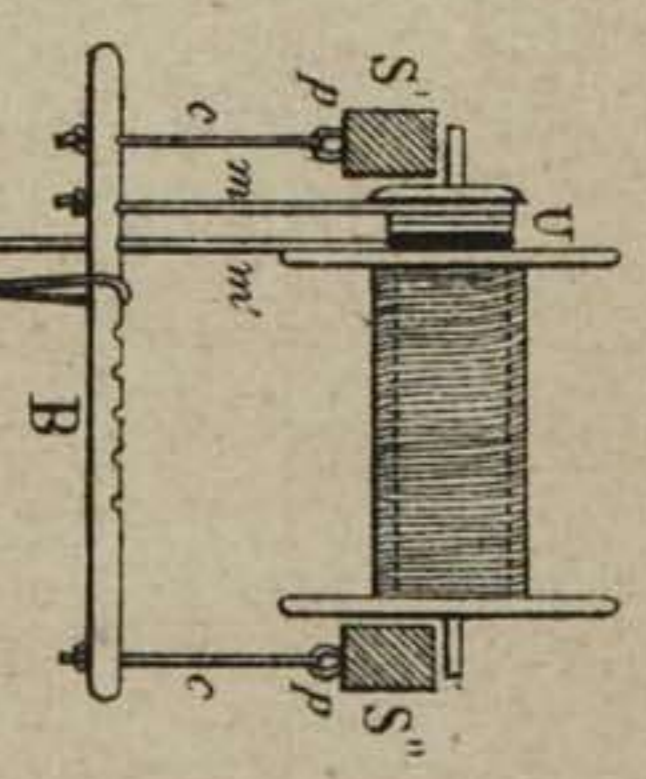


Fig. 1041

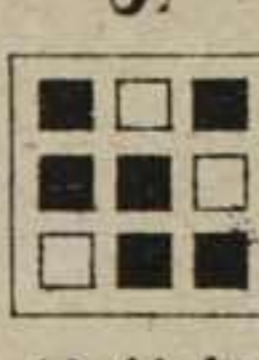


Fig. 1042

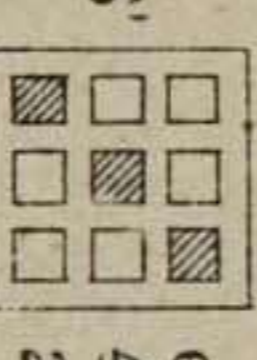


Fig. 1043

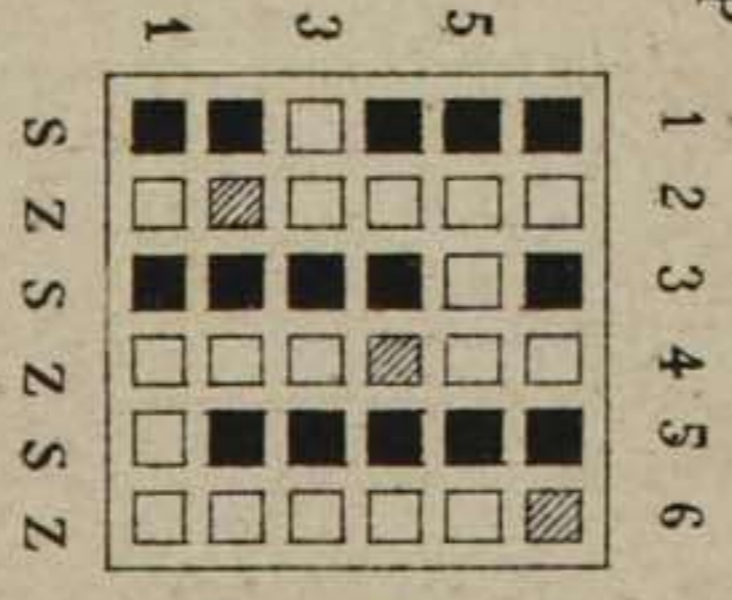


Fig. 1029

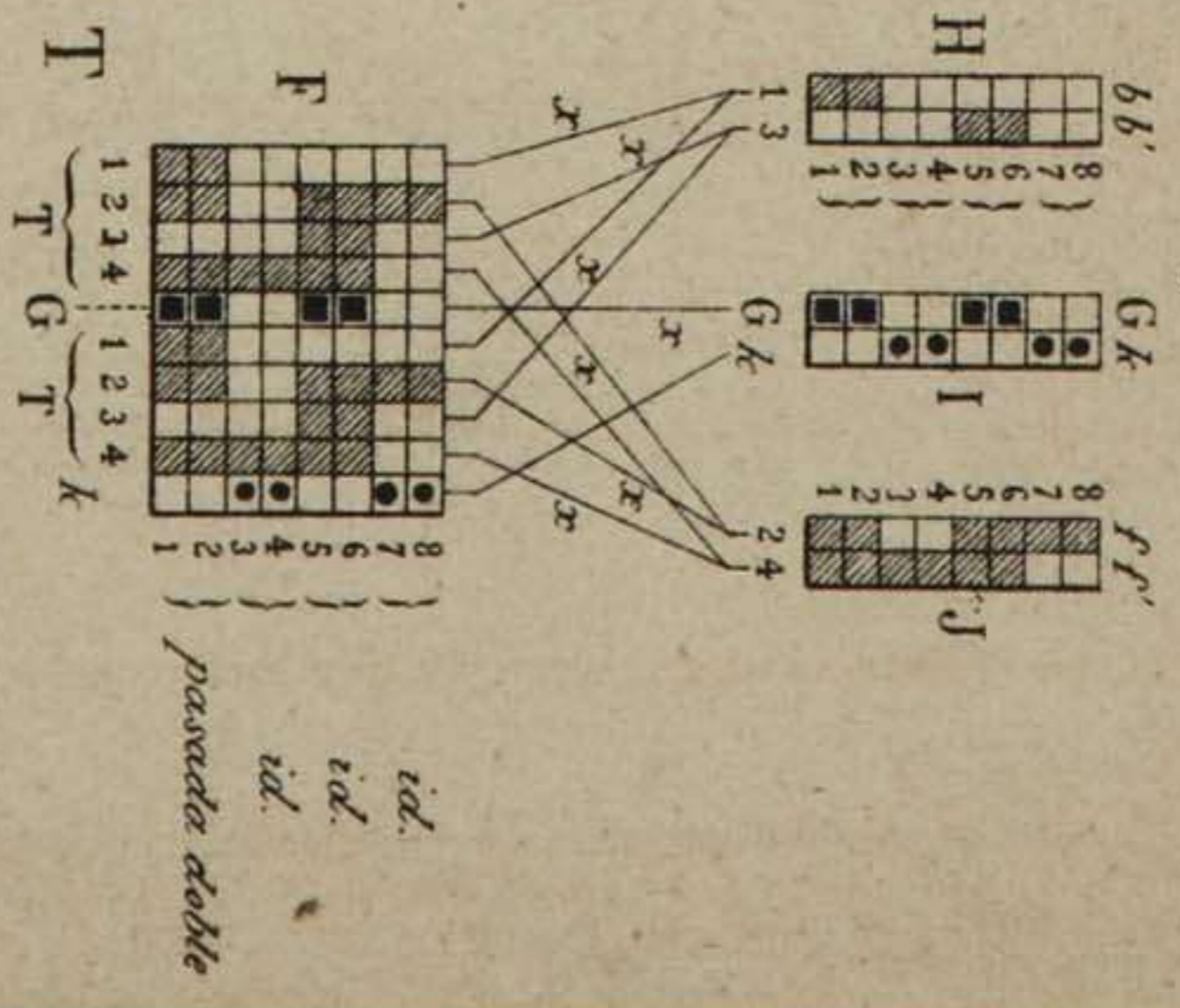


Fig. 1039

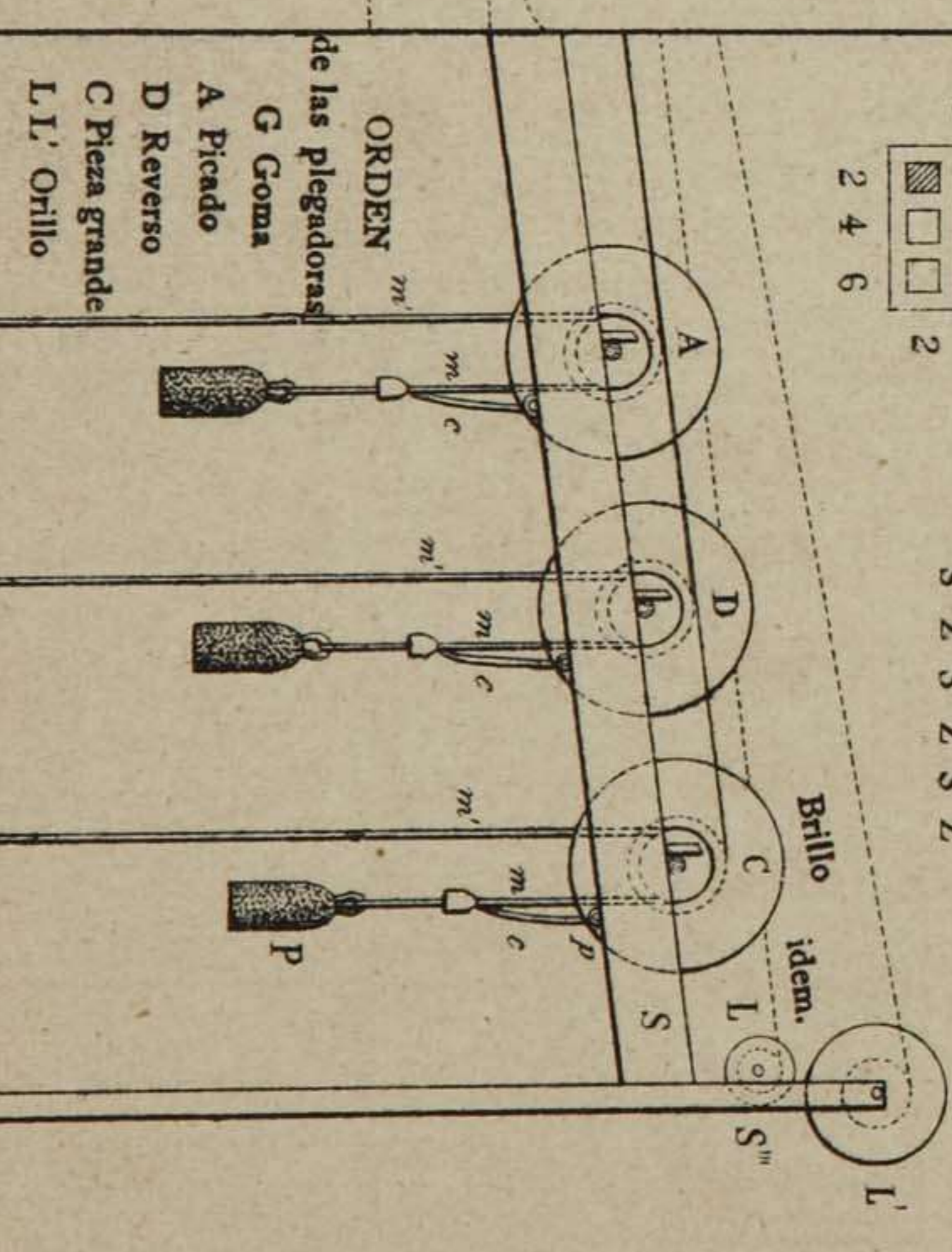
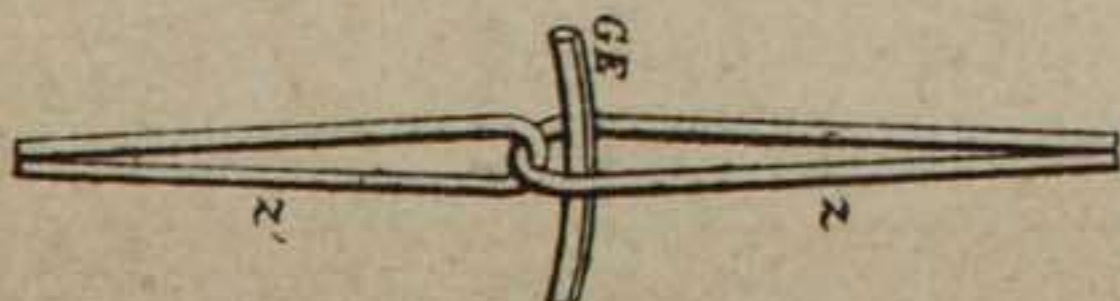


Fig. 1046

DOBLE-CARA SATINADA POR URDIMBRE

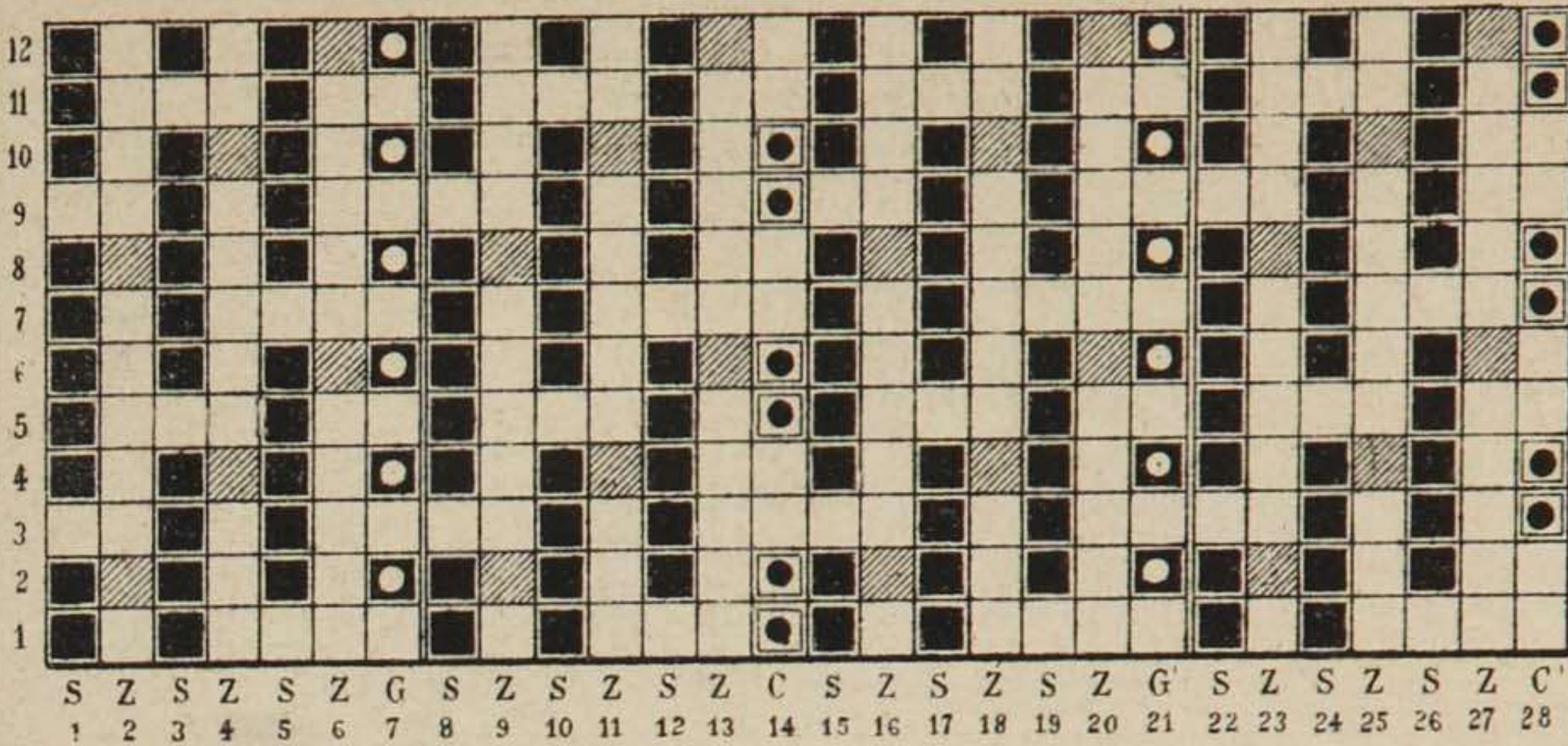


Fig 1050

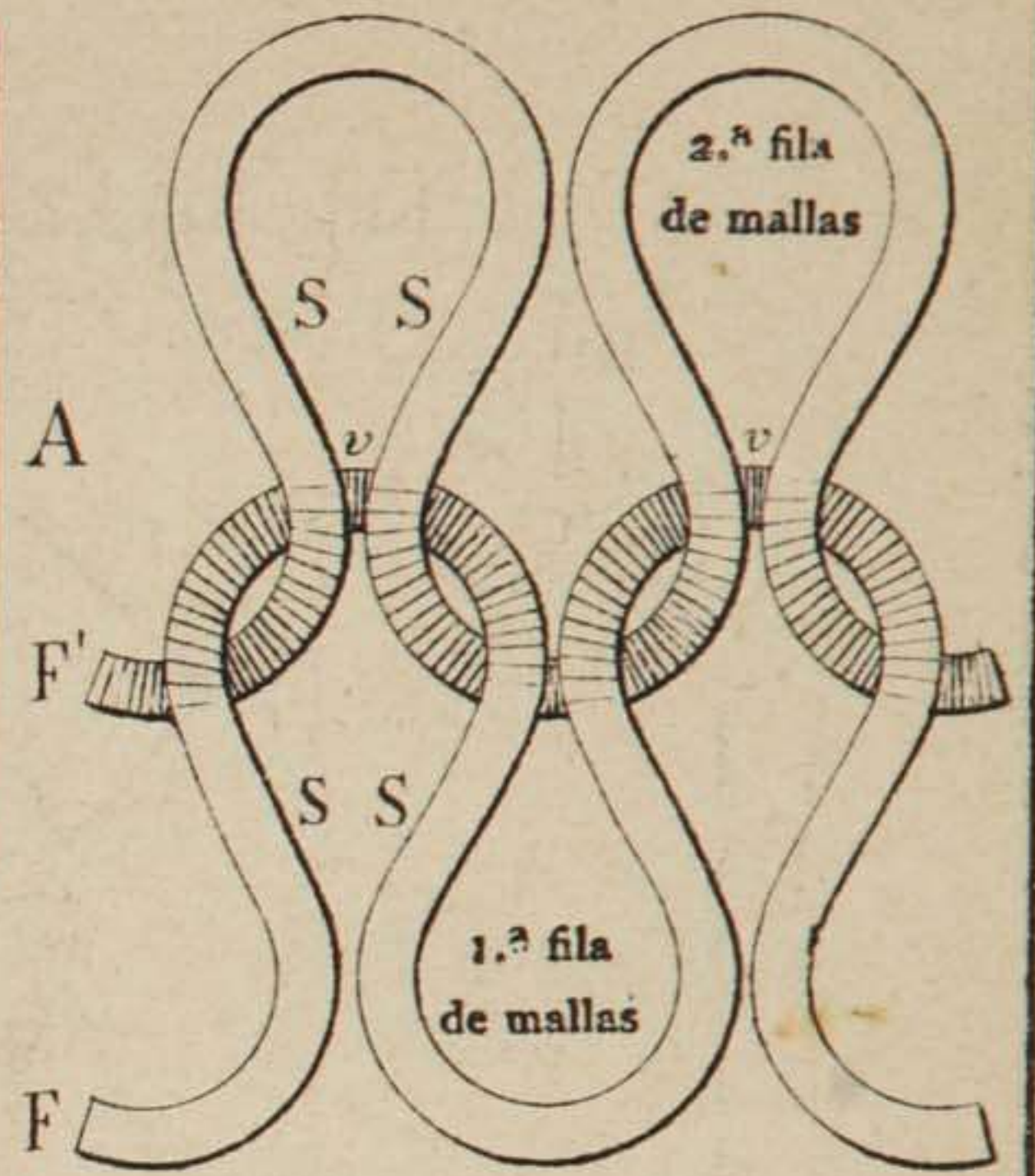
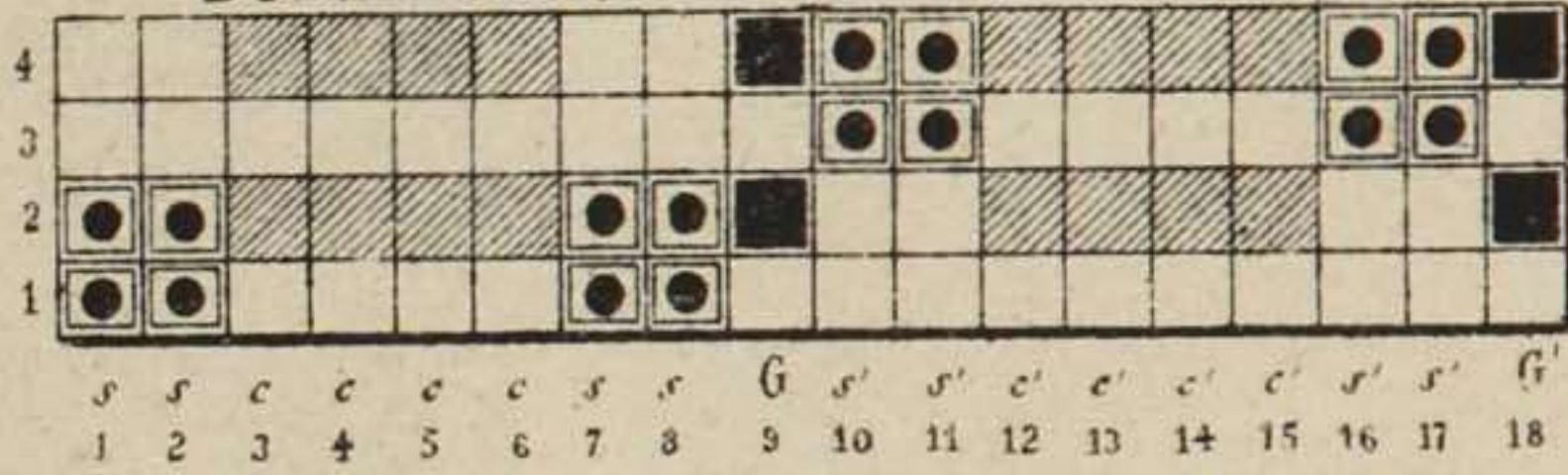


Fig. 1047

DOBLE-CARA ACANALADA POR TRAMA



B

LIGAMIENTO GENERAL M

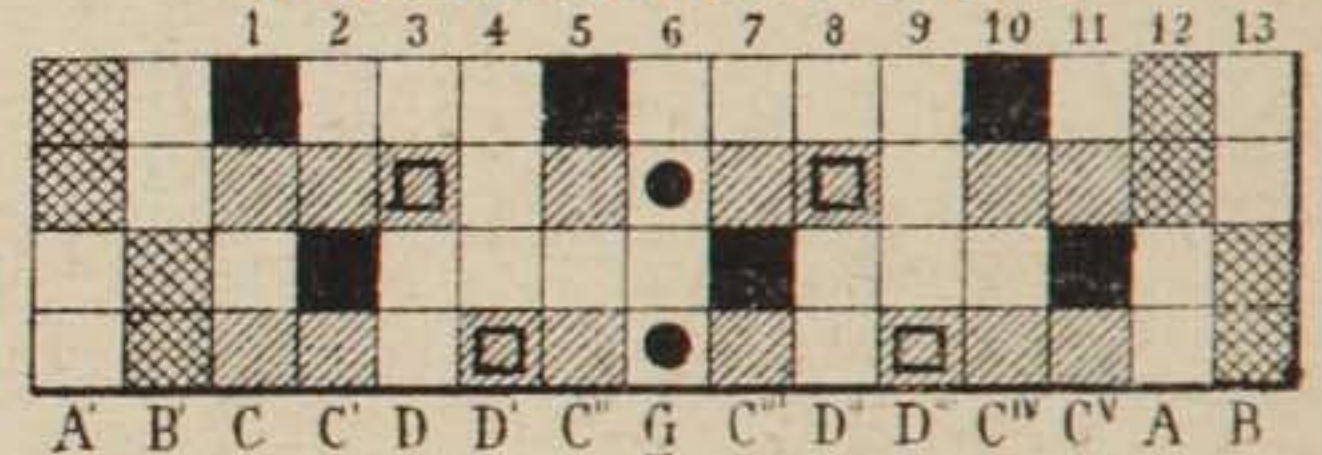
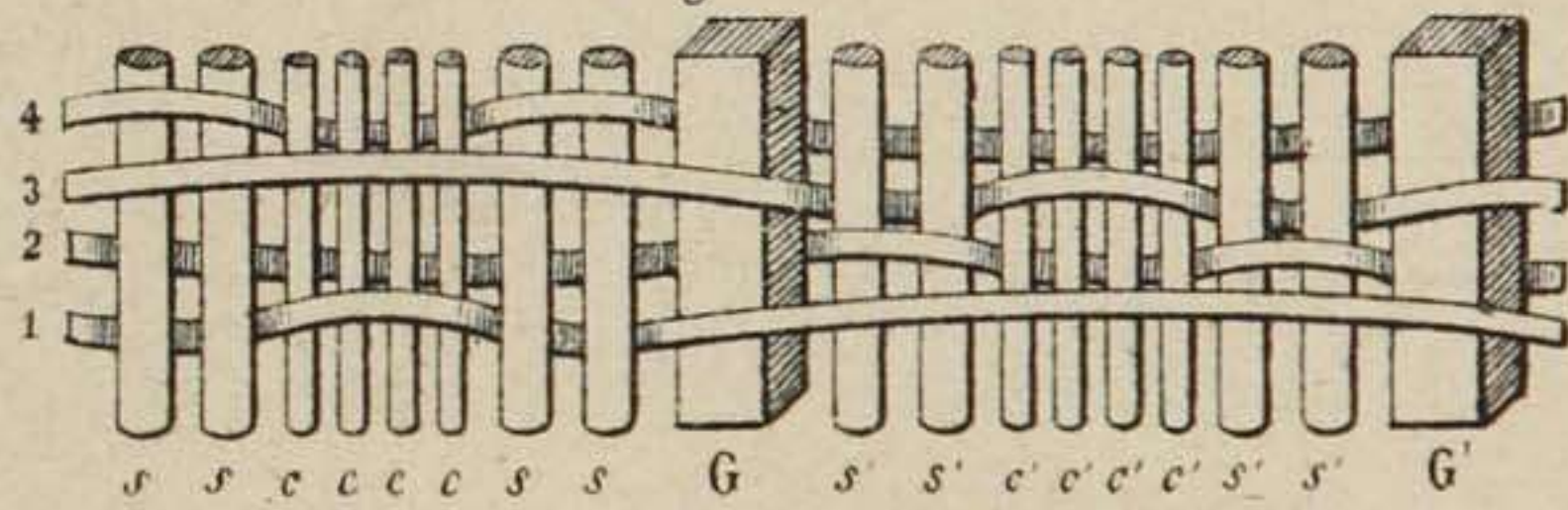


Fig. 1035

Fig. 1048



B'

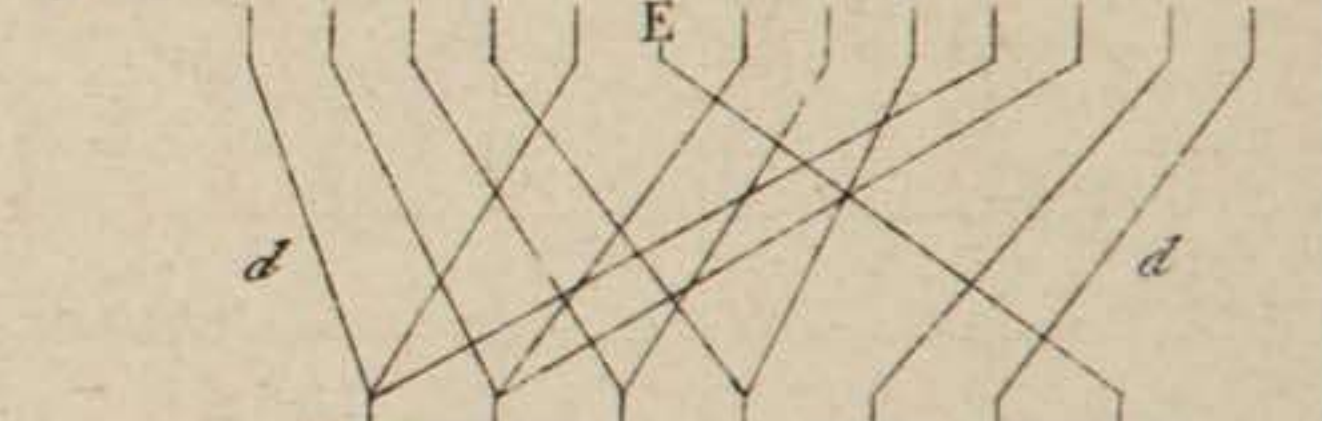


Fig. 1036

Fig. 1049

DOBLE CARA ACANALADA AGRAMILADA POR TRAMA

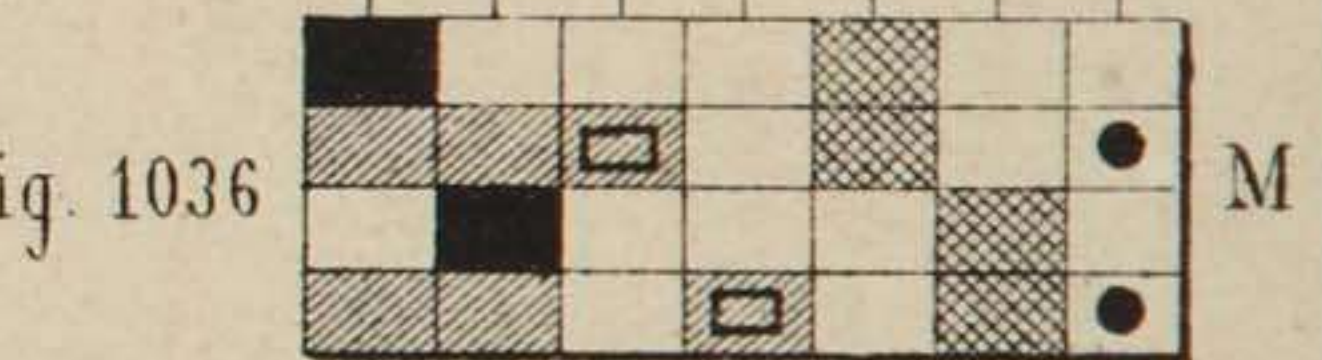
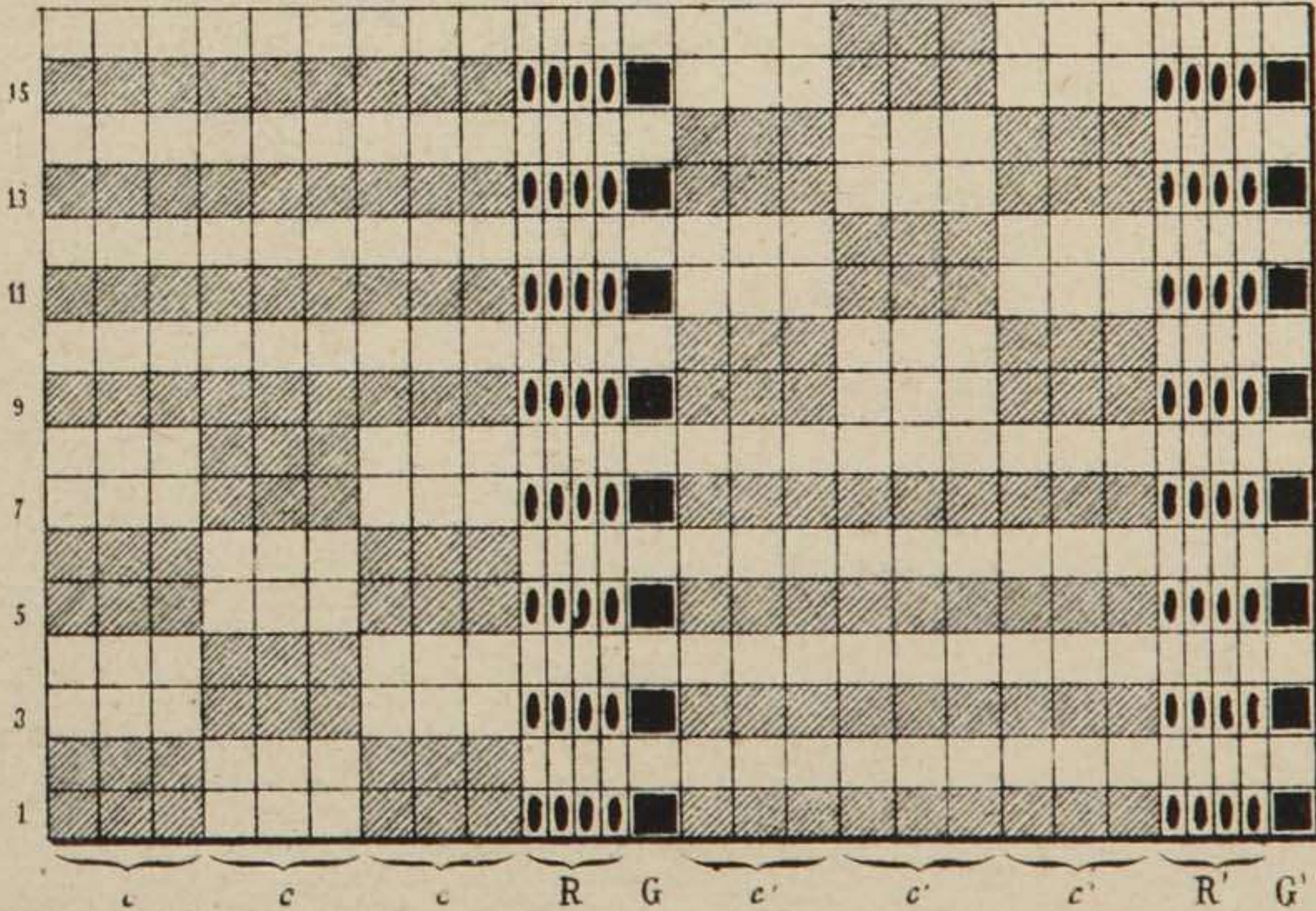


Fig. 1037

D

REMETIDO DE LOS 13 HILOS

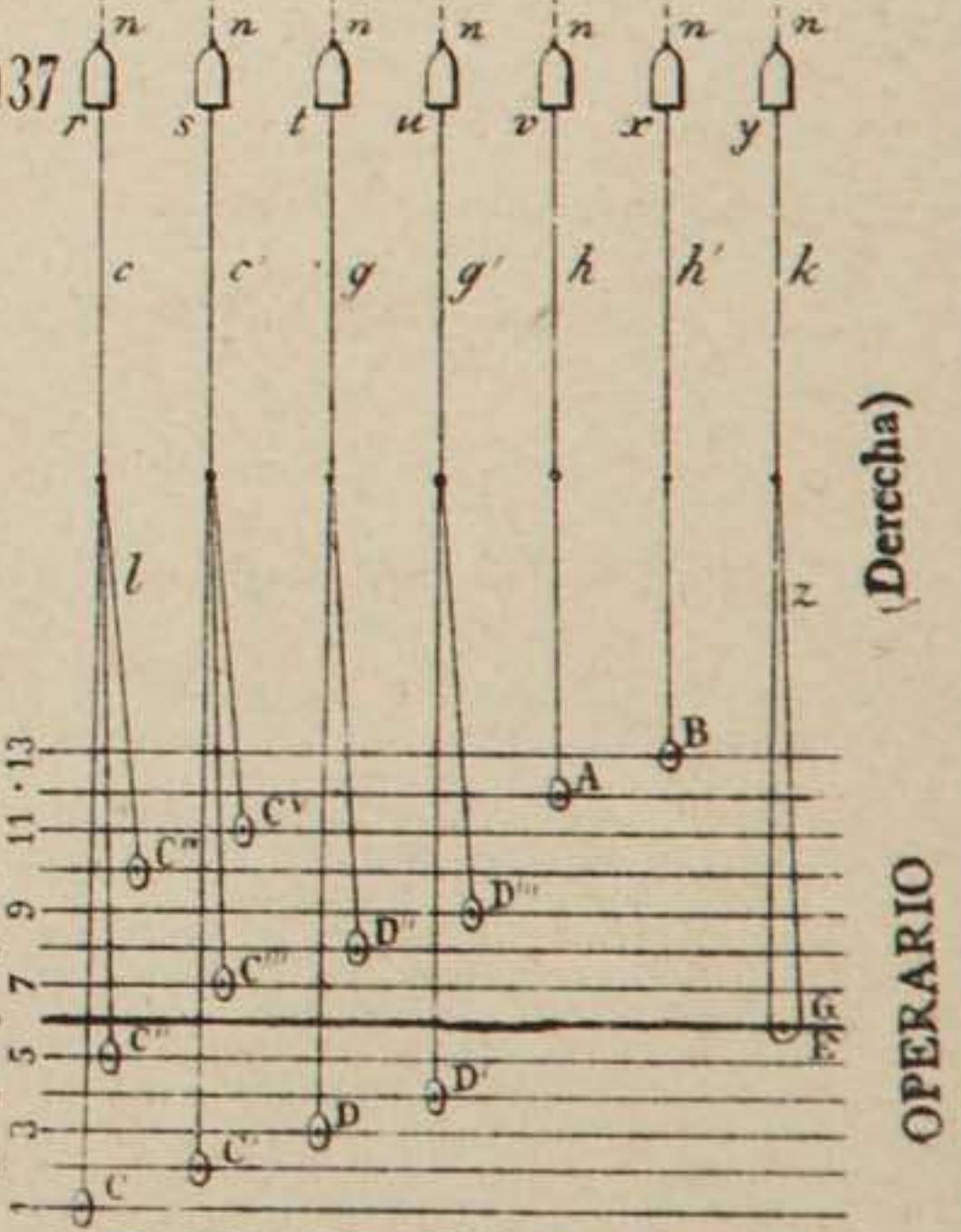


Fig. 1038

NOTA: Todos los signos, sean los que fueren, indican tomados

1.º cuerpo po pieza grande
2.º cuerpo reverso
3.º cuerpo picado
4.º cuerpo goma. (Izquierda)

Fig. 1052

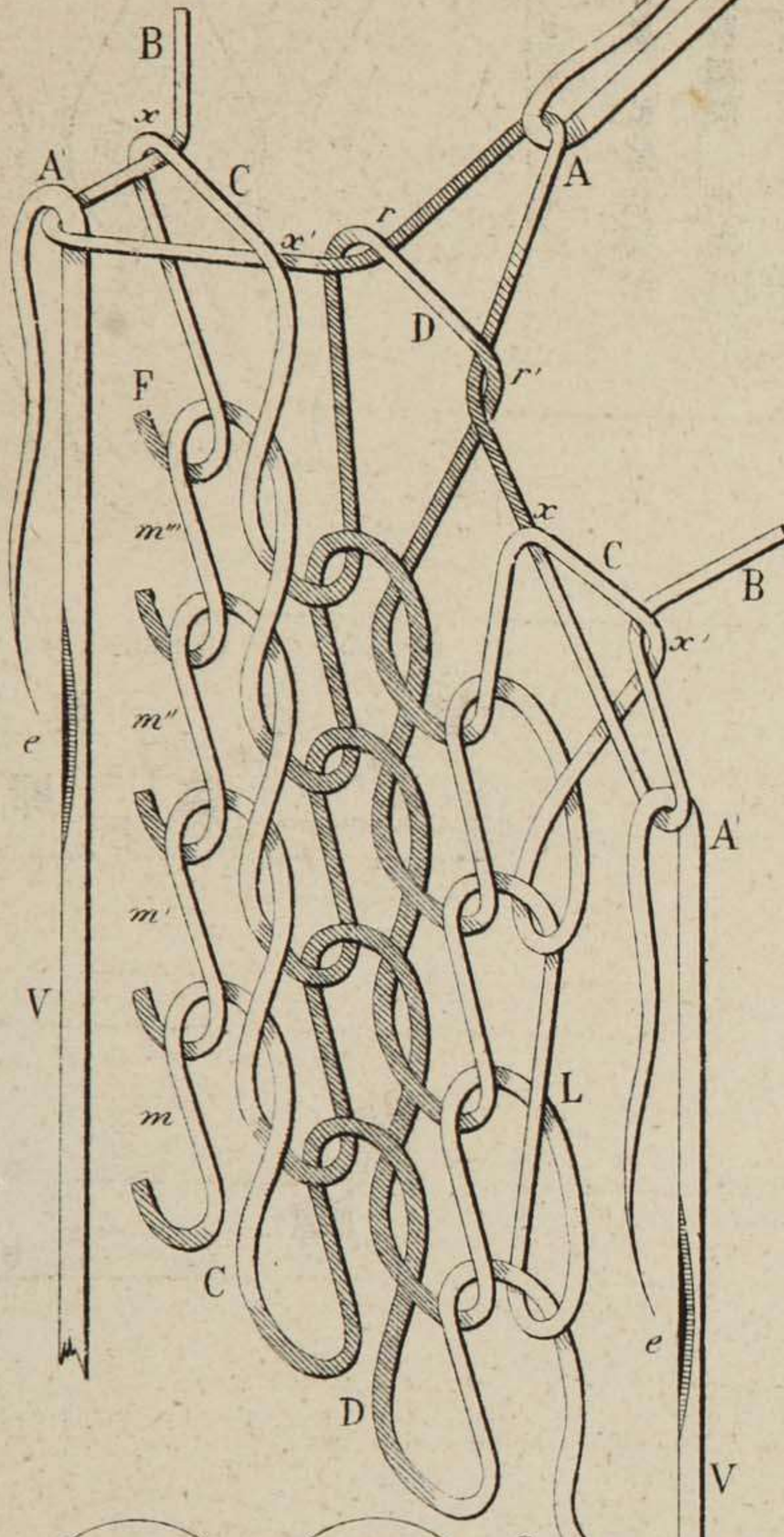


Fig. 1058

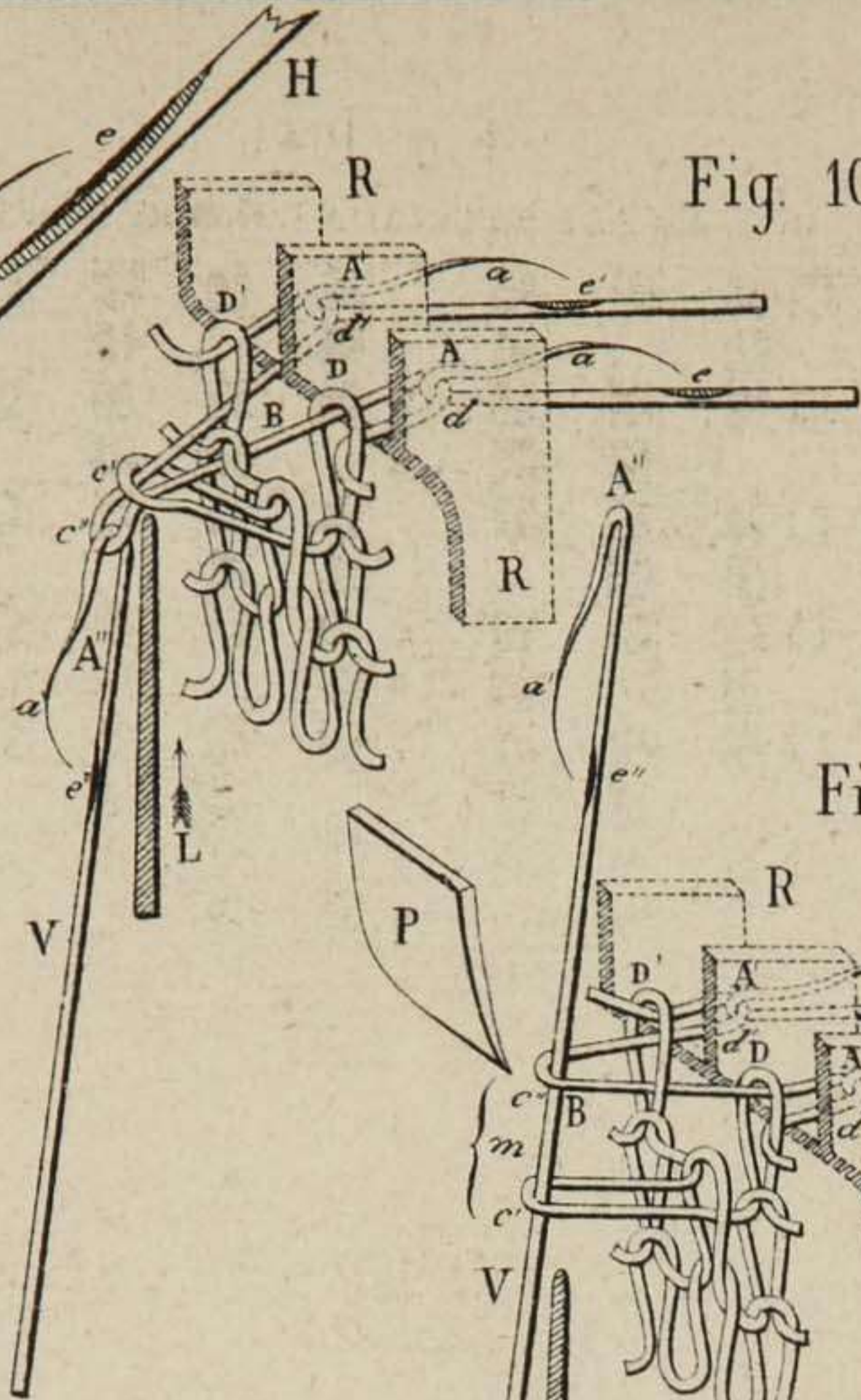


Fig. 1055

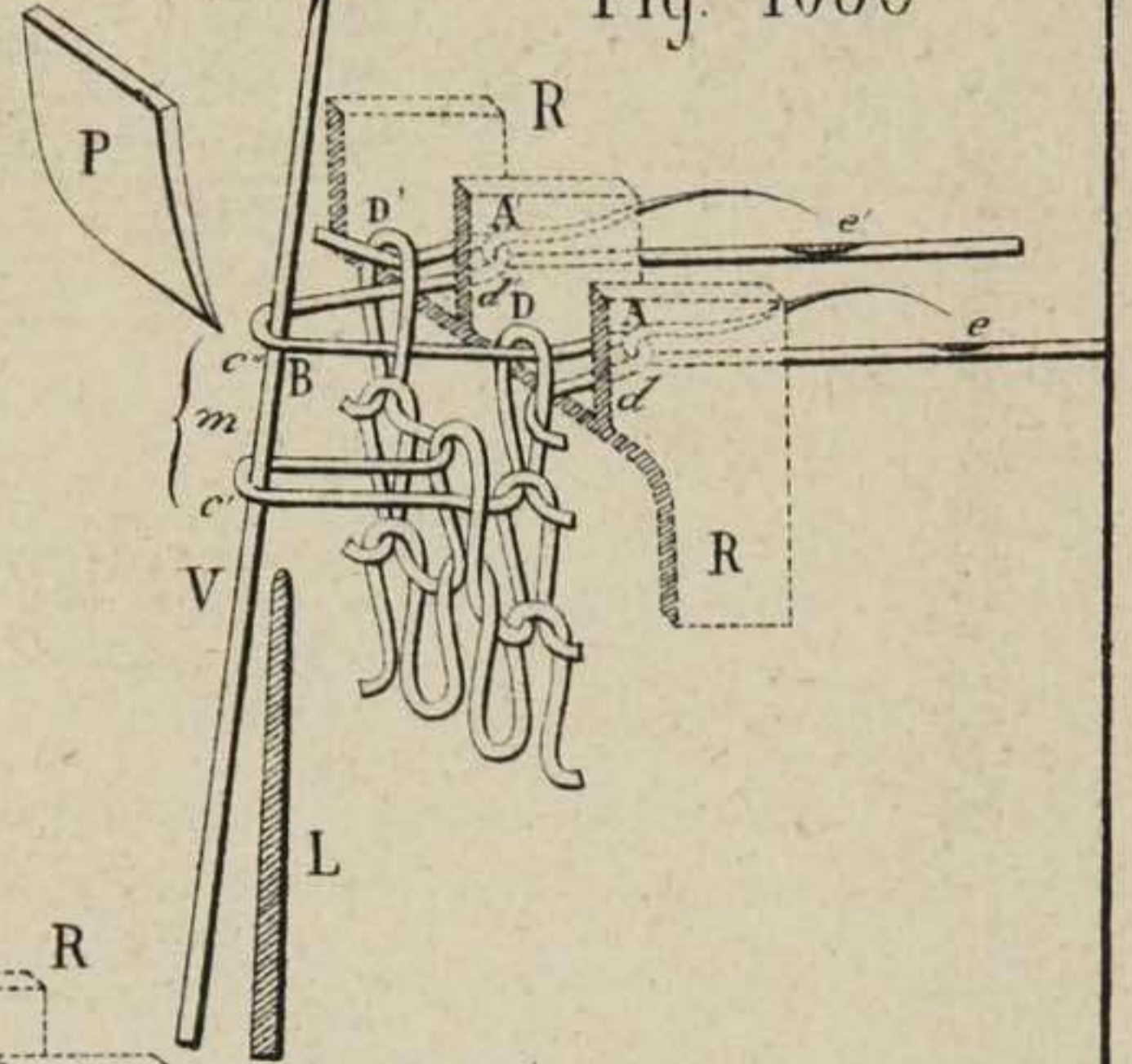


Fig. 1057

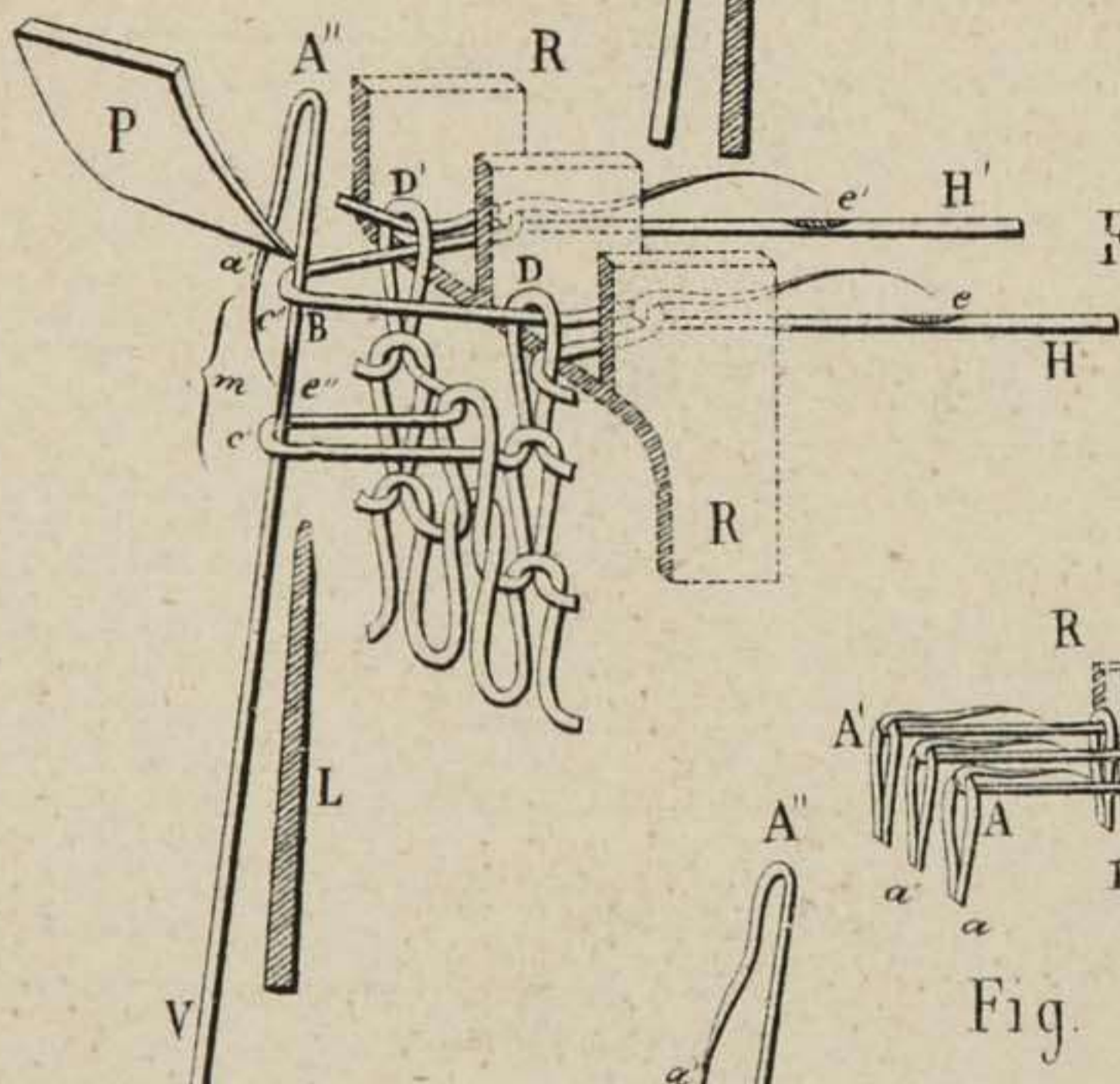


Fig. 1056

TRICOT: Tipo inglés

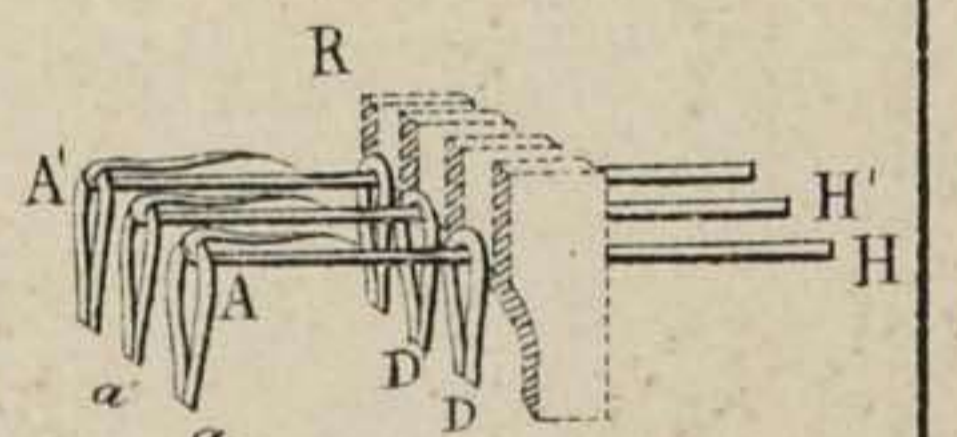


Fig. 1053

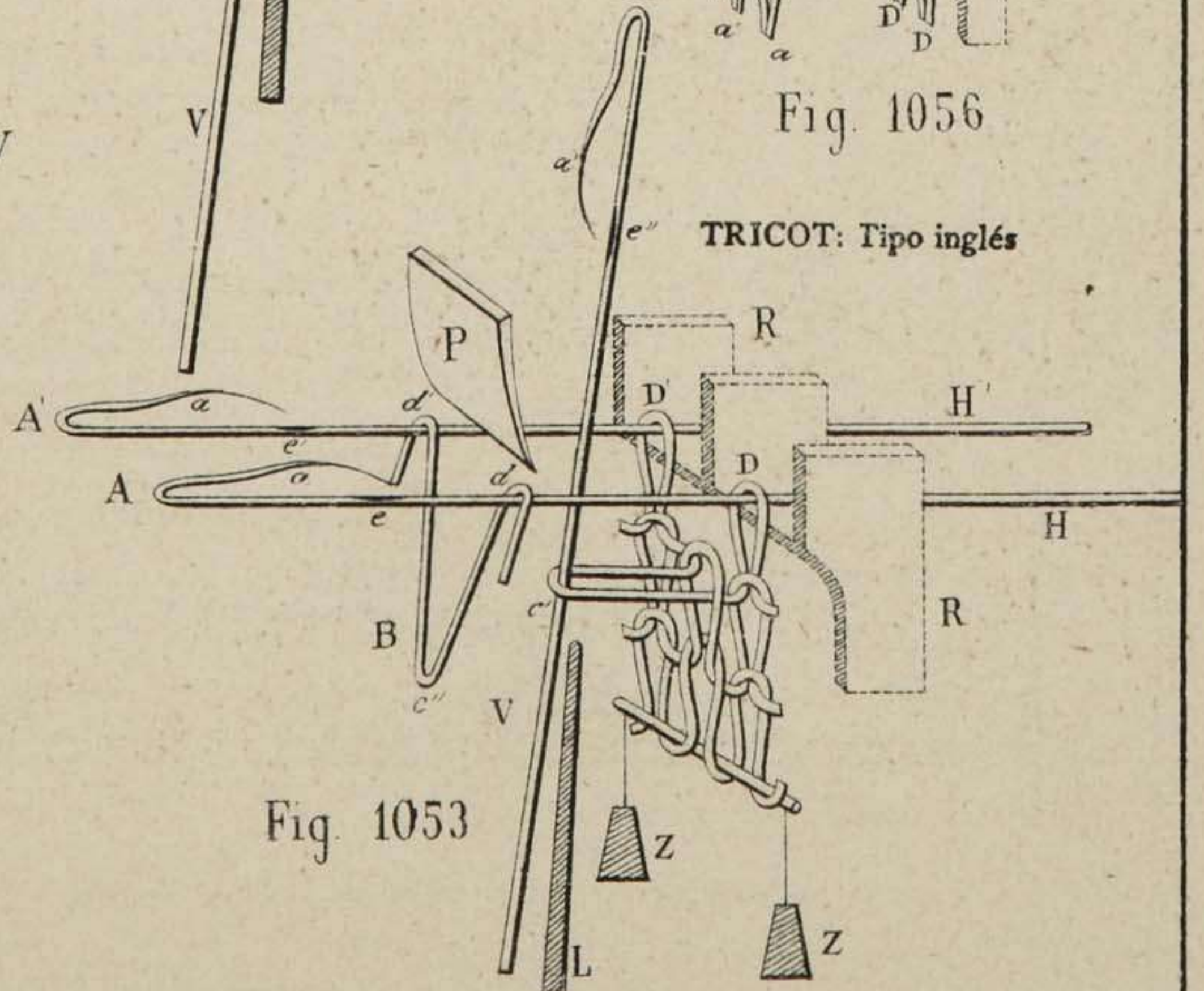
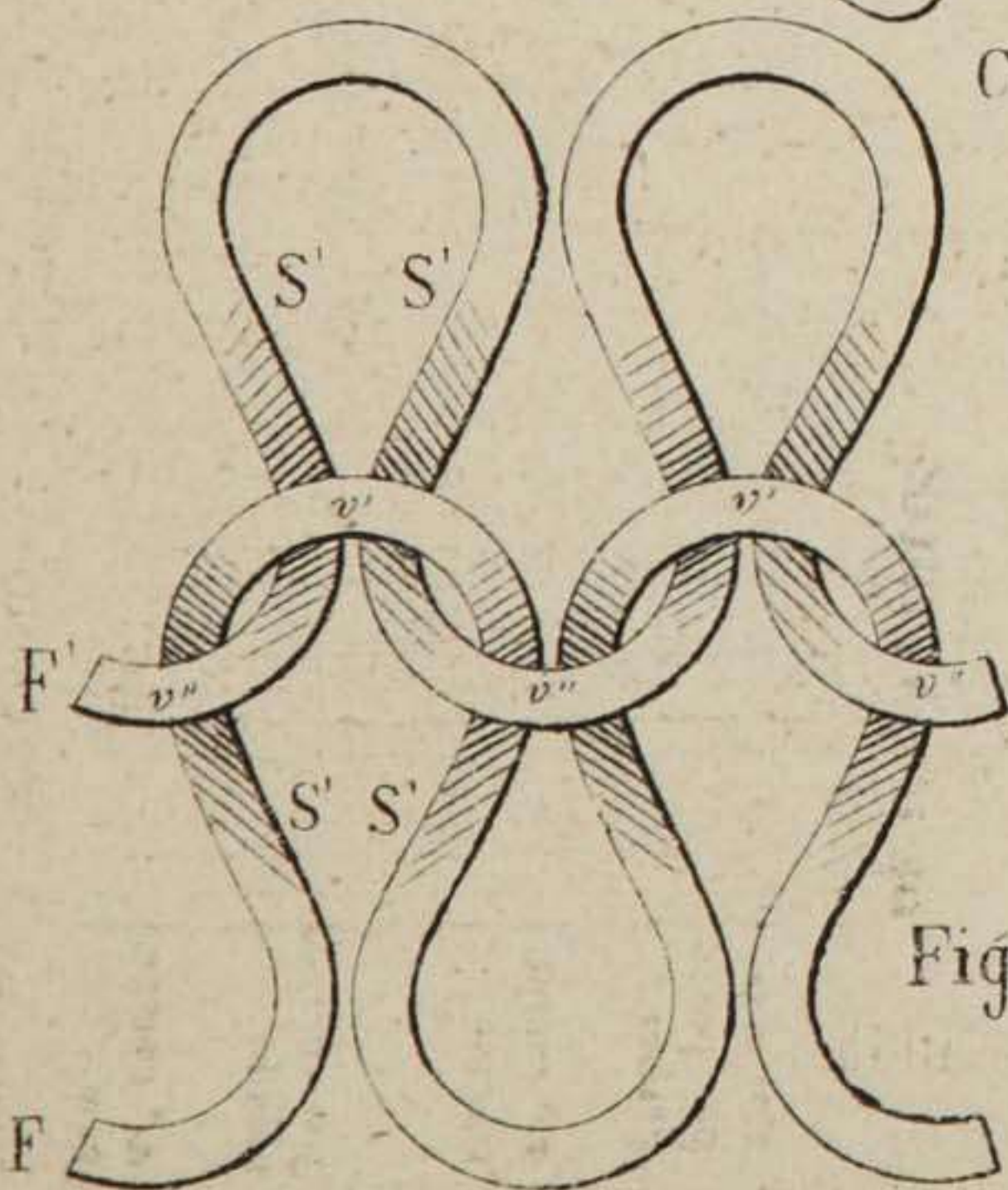
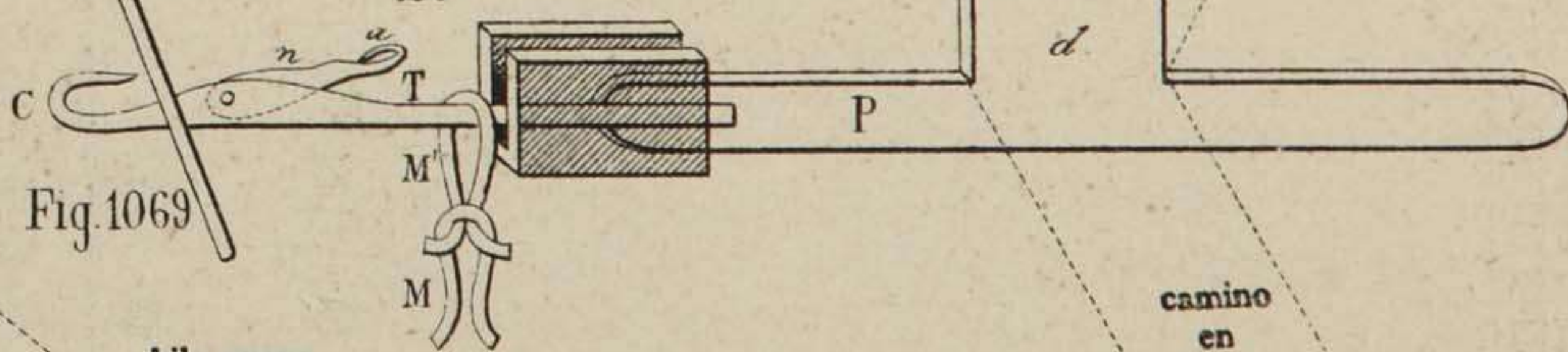
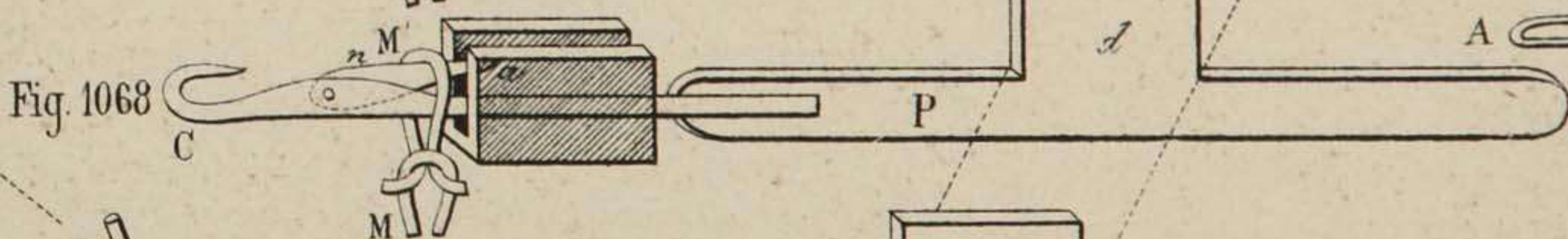
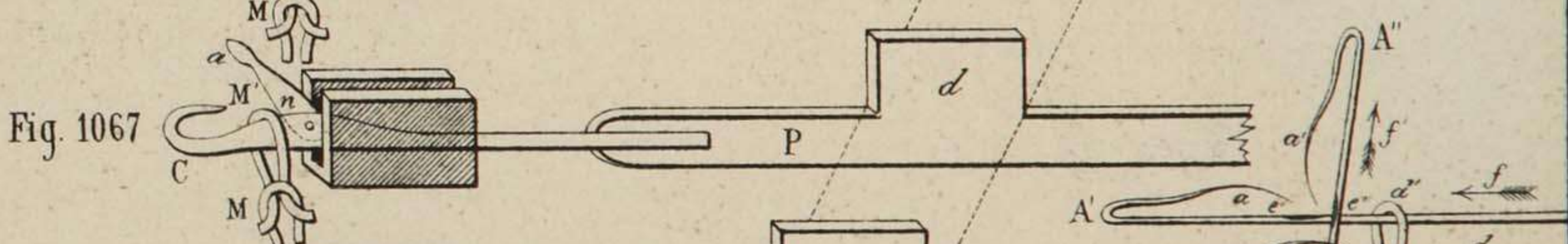
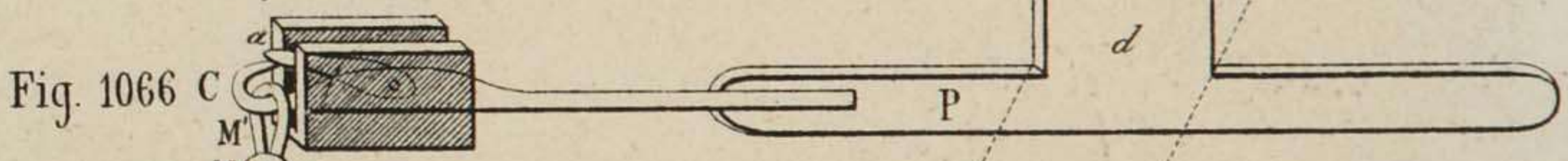
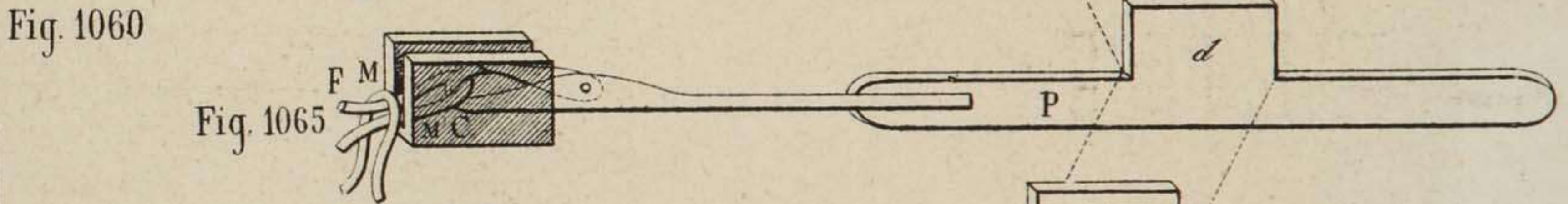
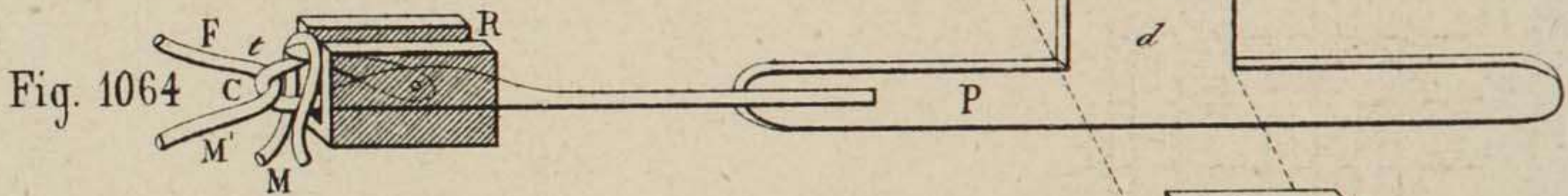
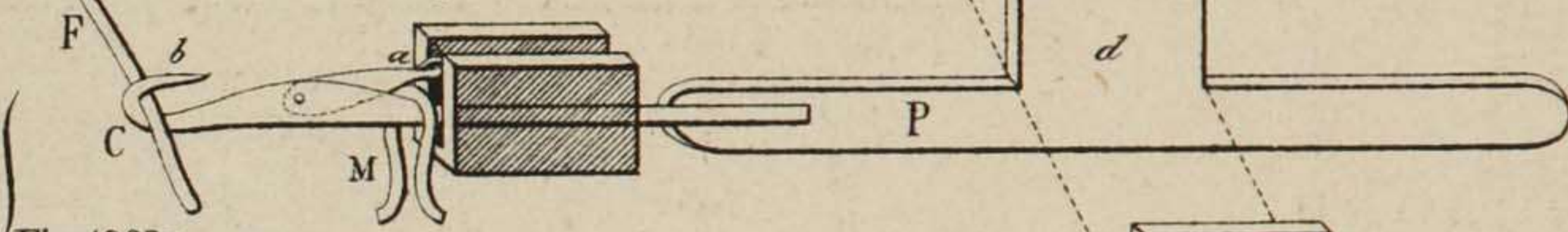
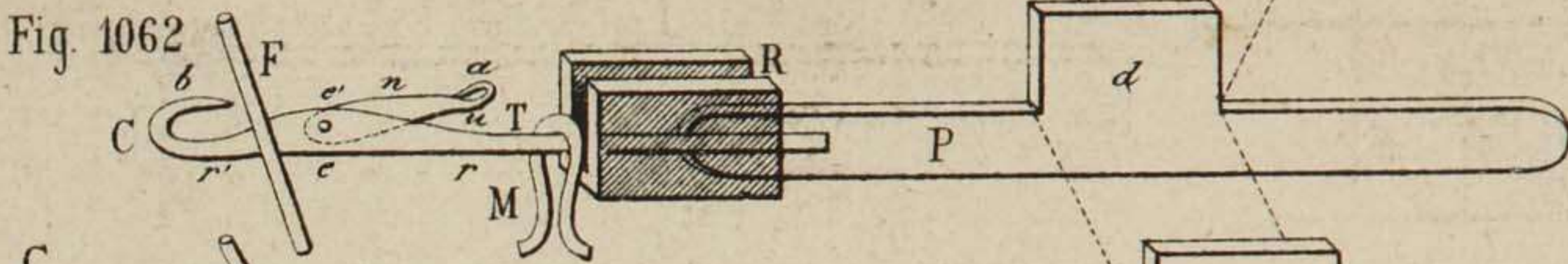
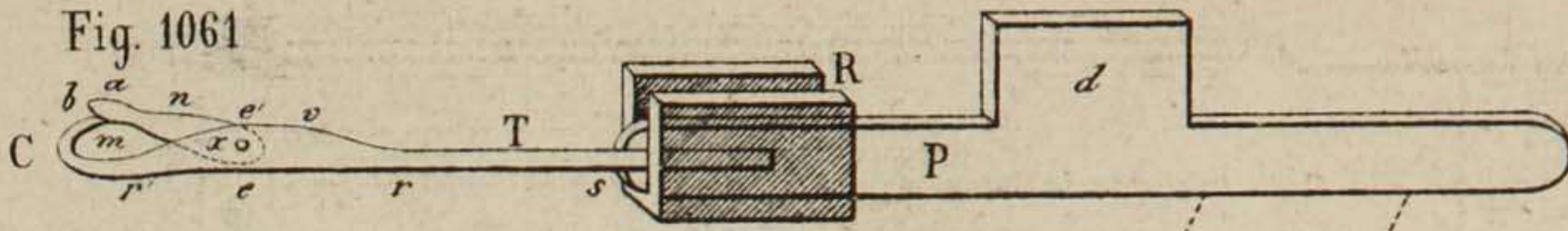


Fig. 1051



TRICOT: Aguja automática



hilo nuevo

camino en zig-zag

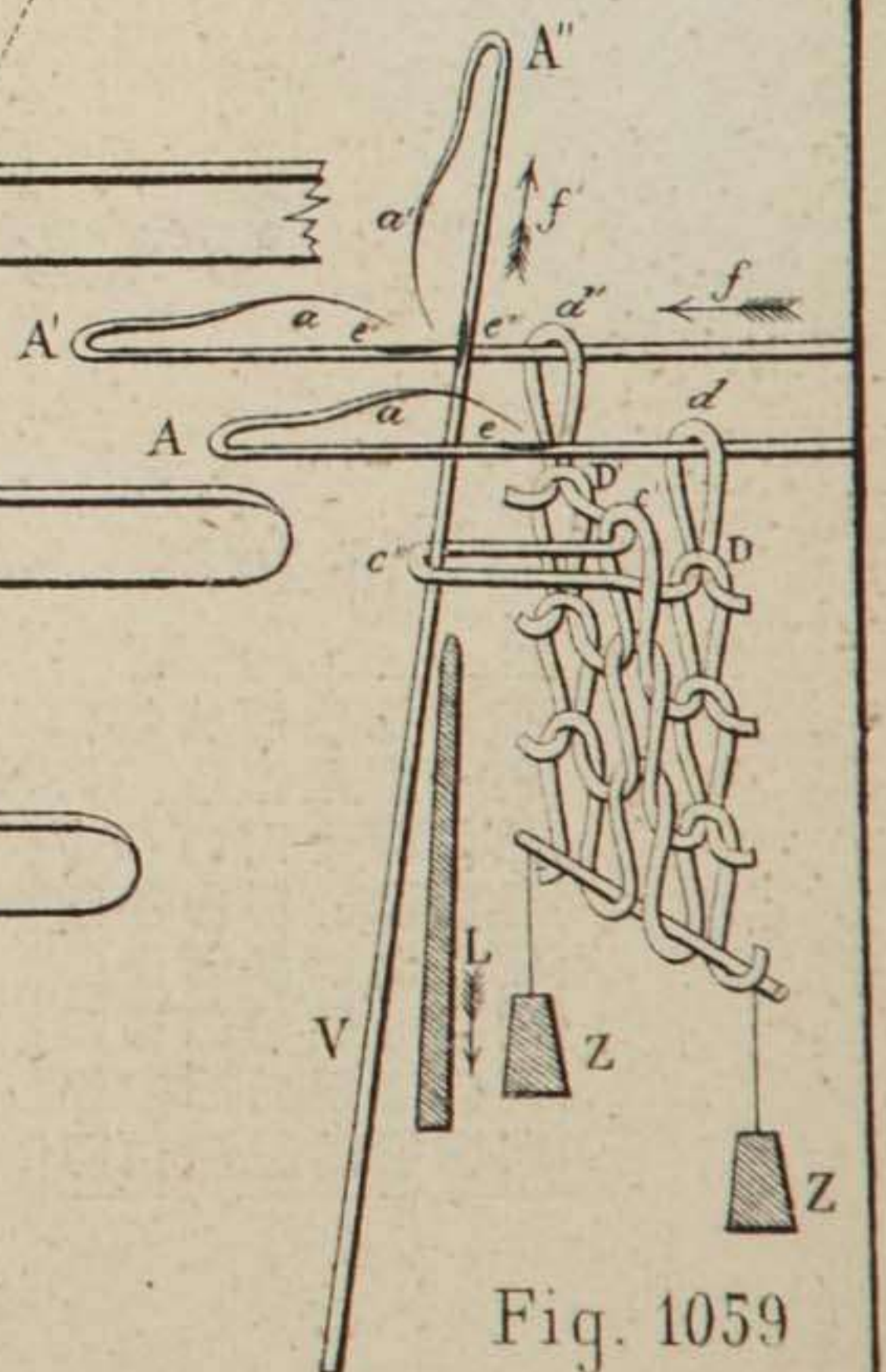
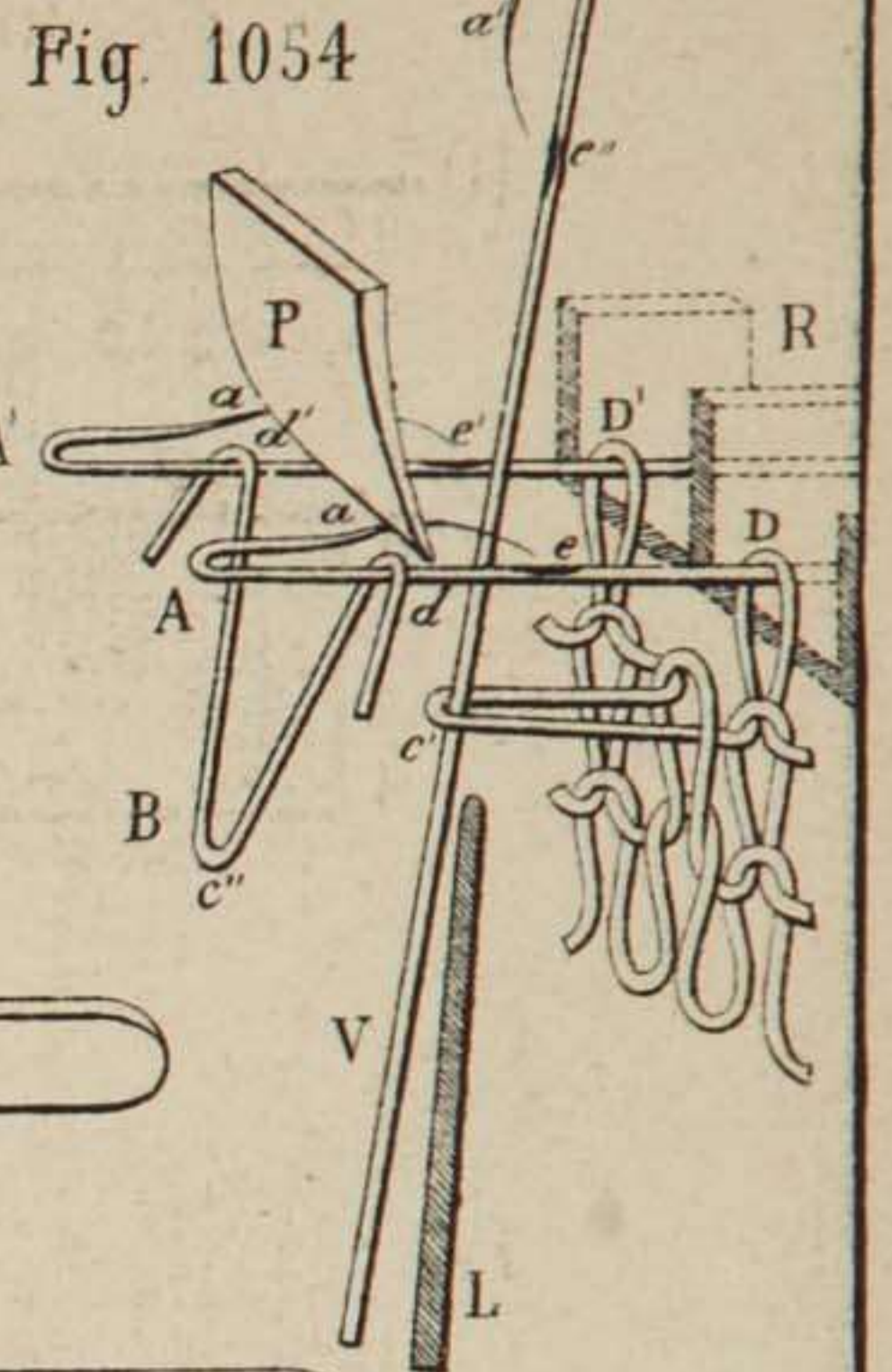


Fig. 1074 A

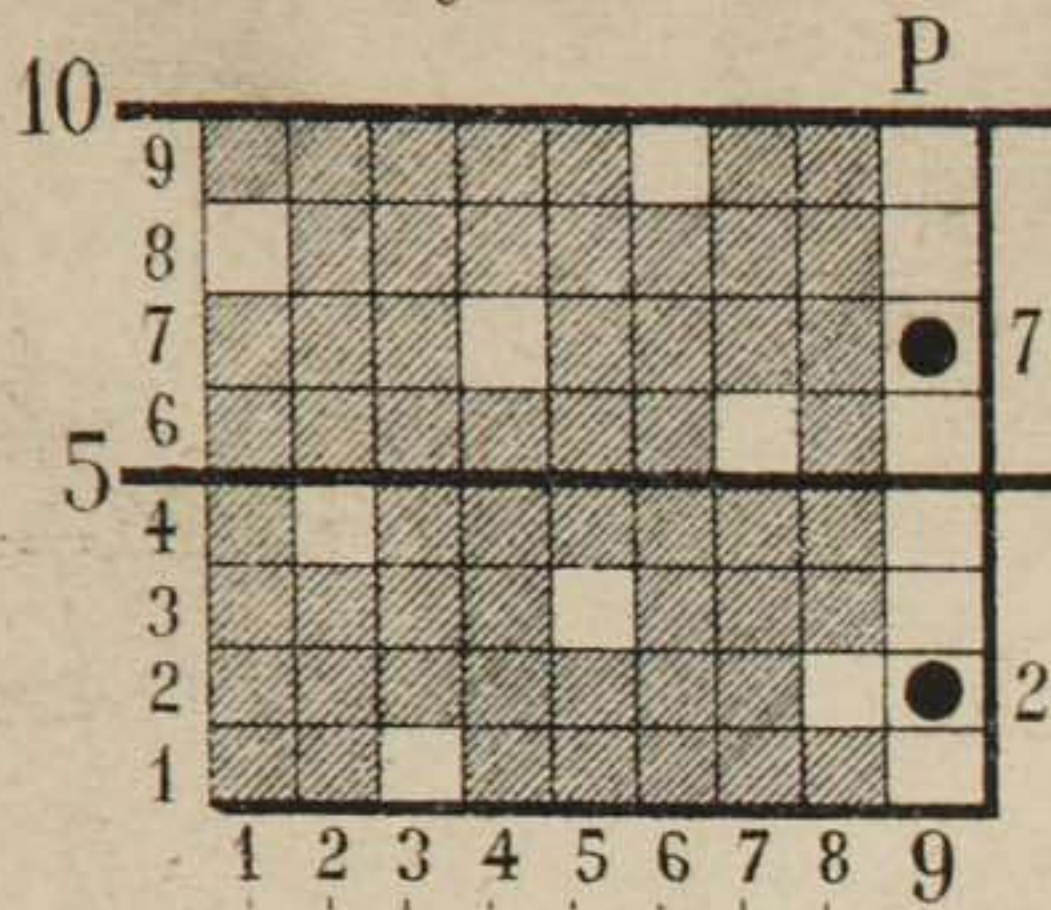


Fig. 1077 B

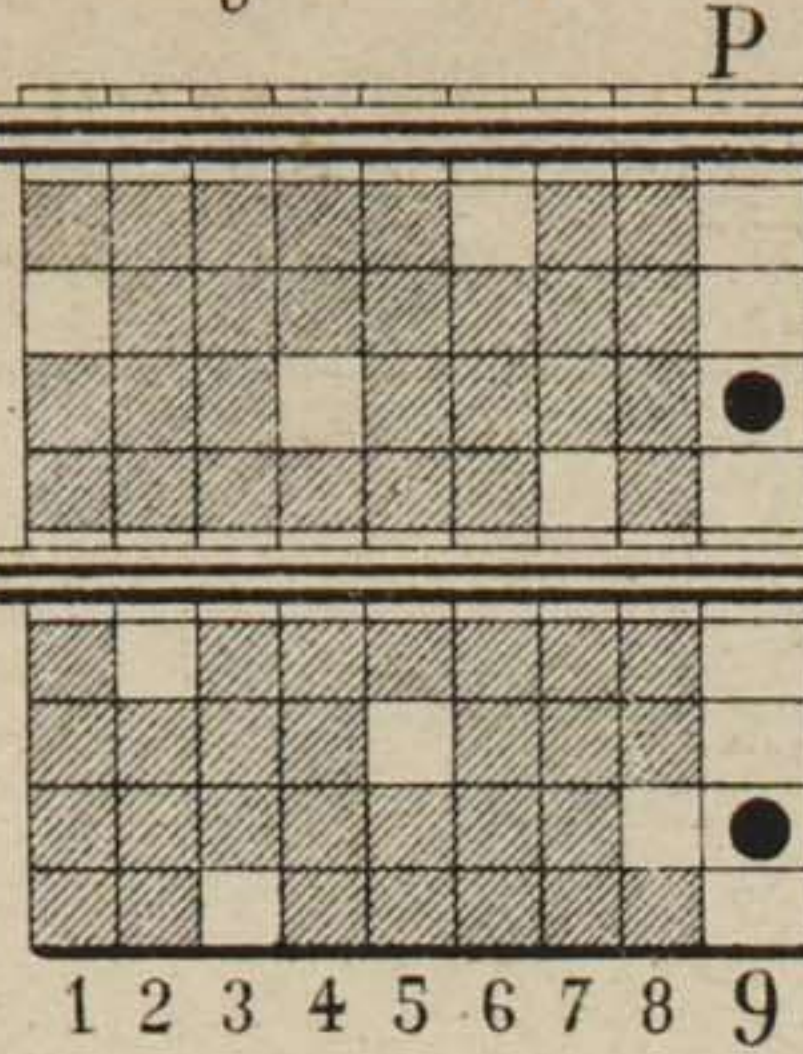


Fig. 1078 C

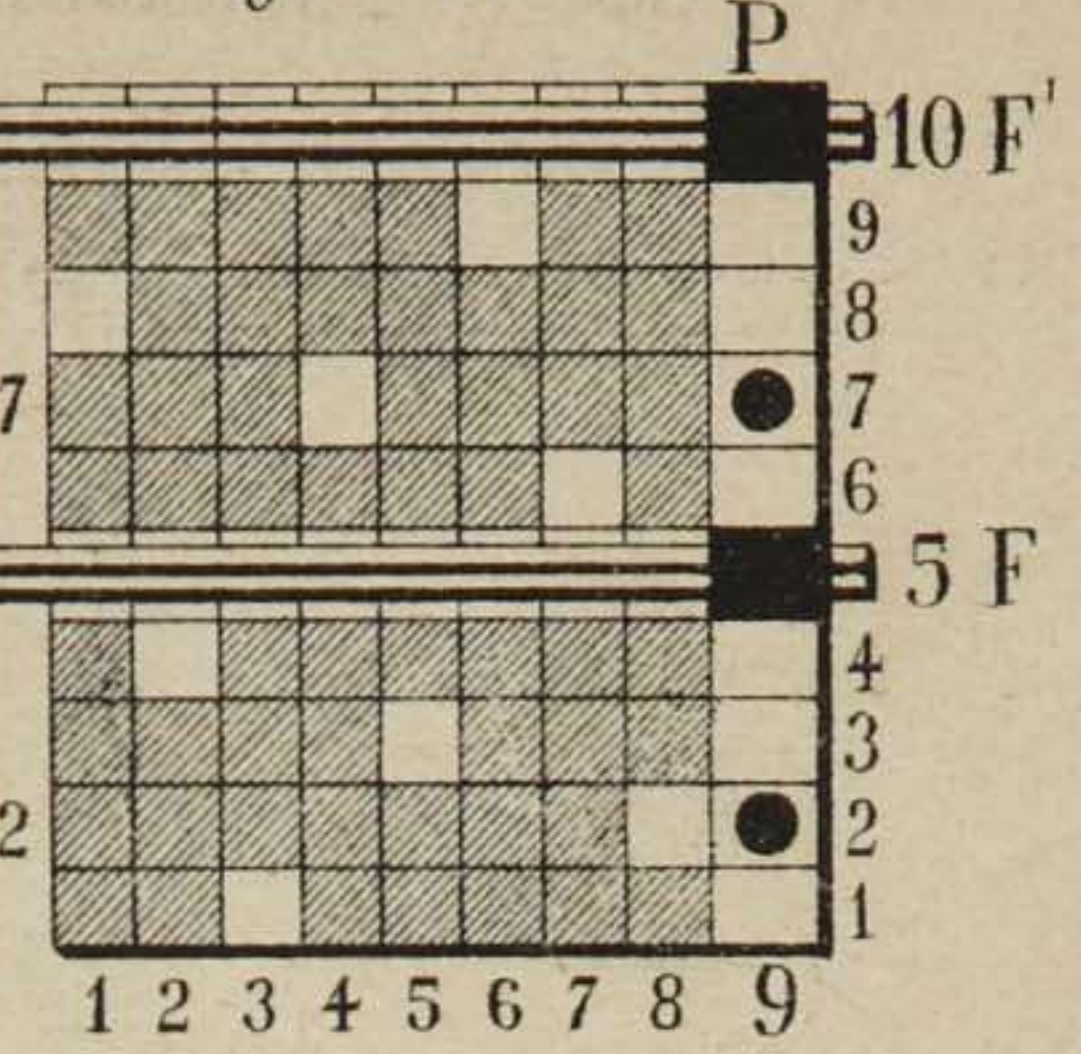
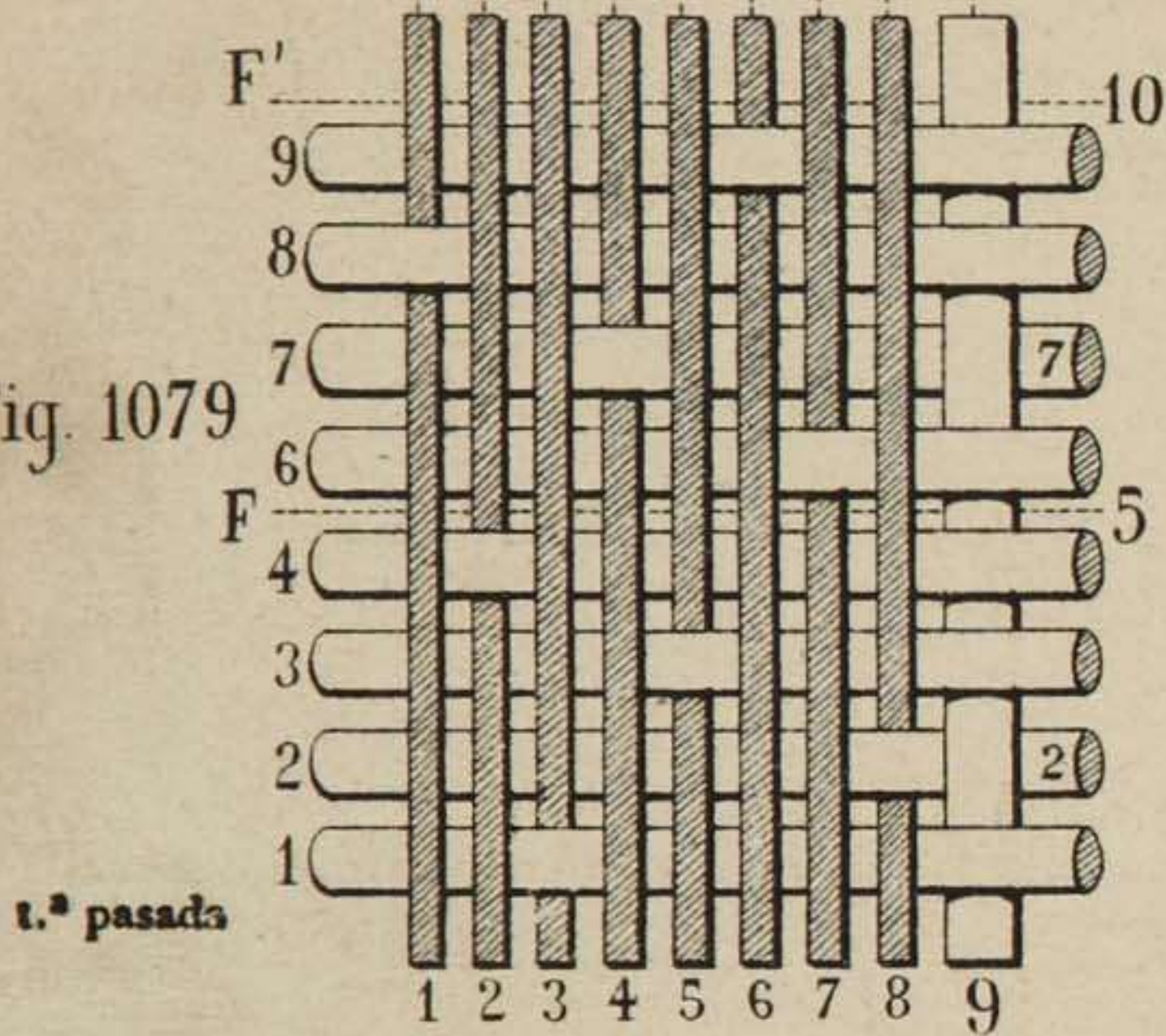


Fig. 1079



t.ª pasada

Fig. 1080

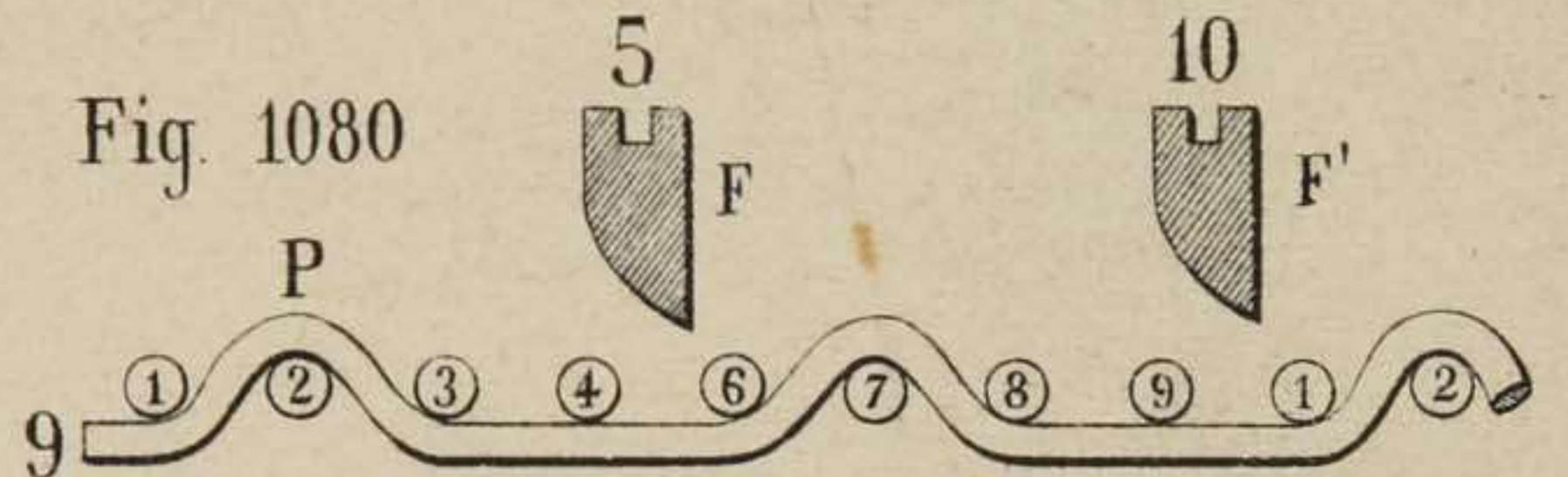


Fig. 1081

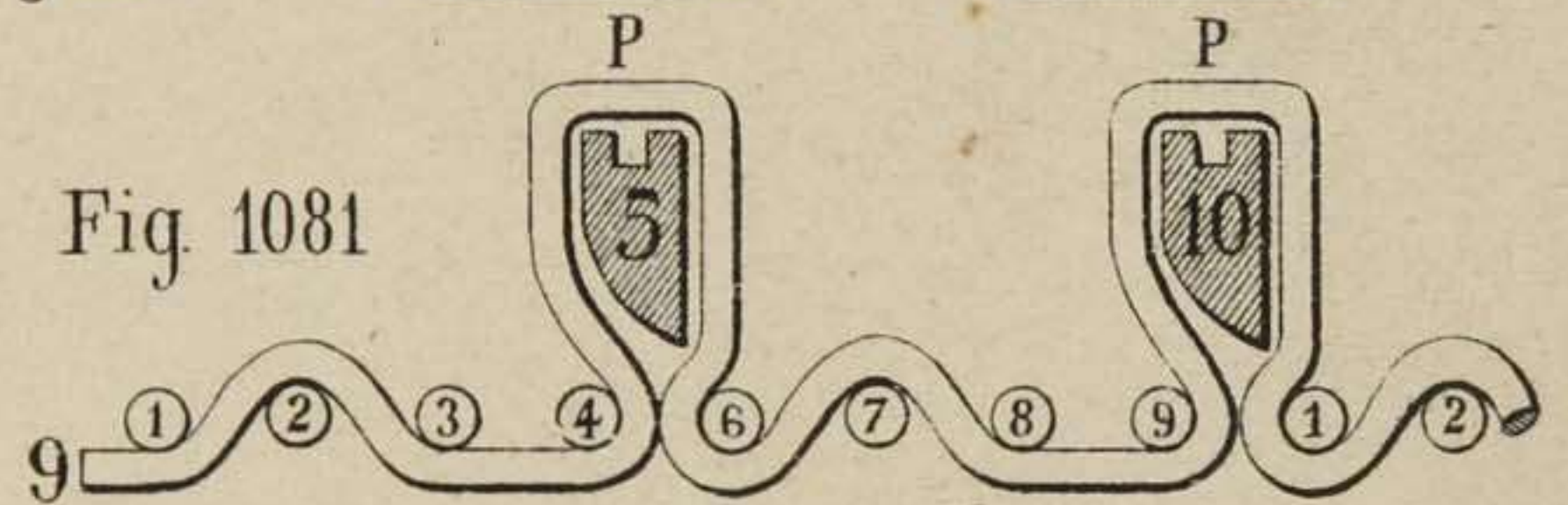


Fig. 1082

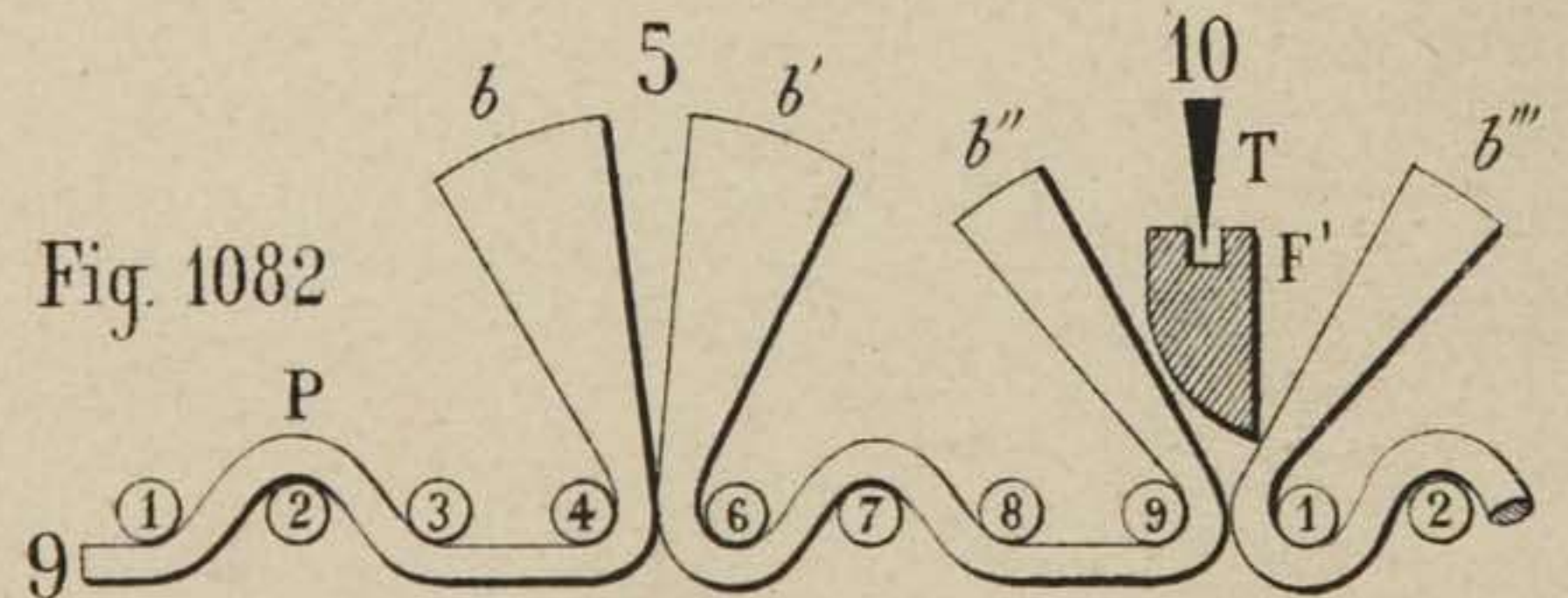


Fig. 1075

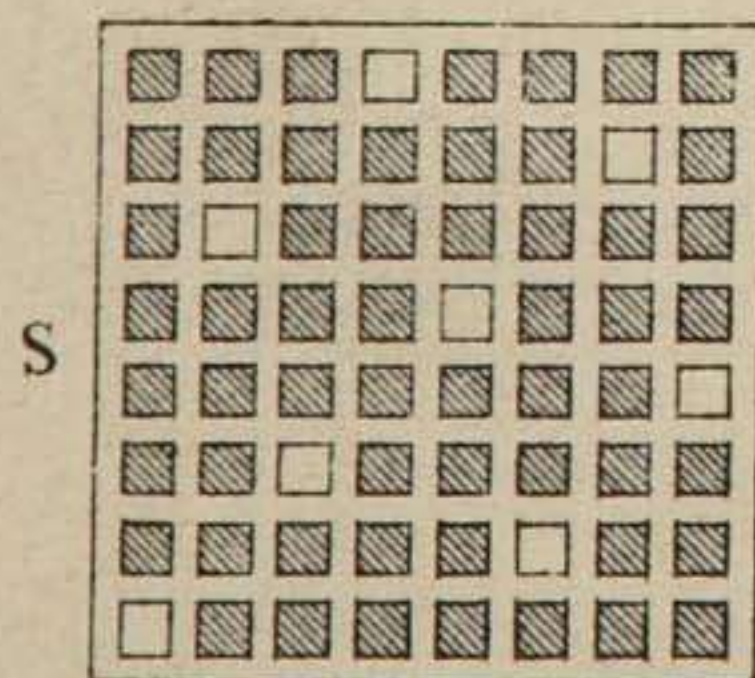
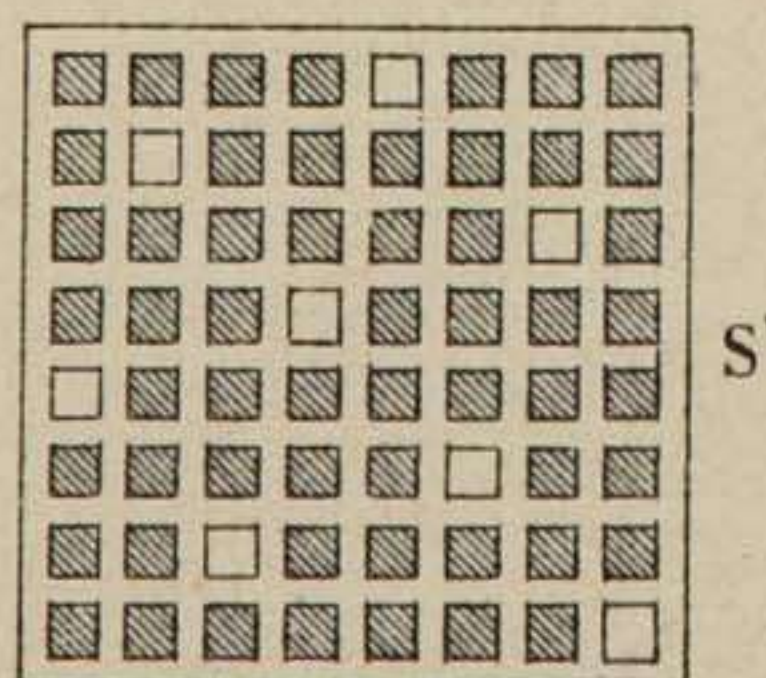


Fig. 1076



(Perfil)
Diseño C' del texto

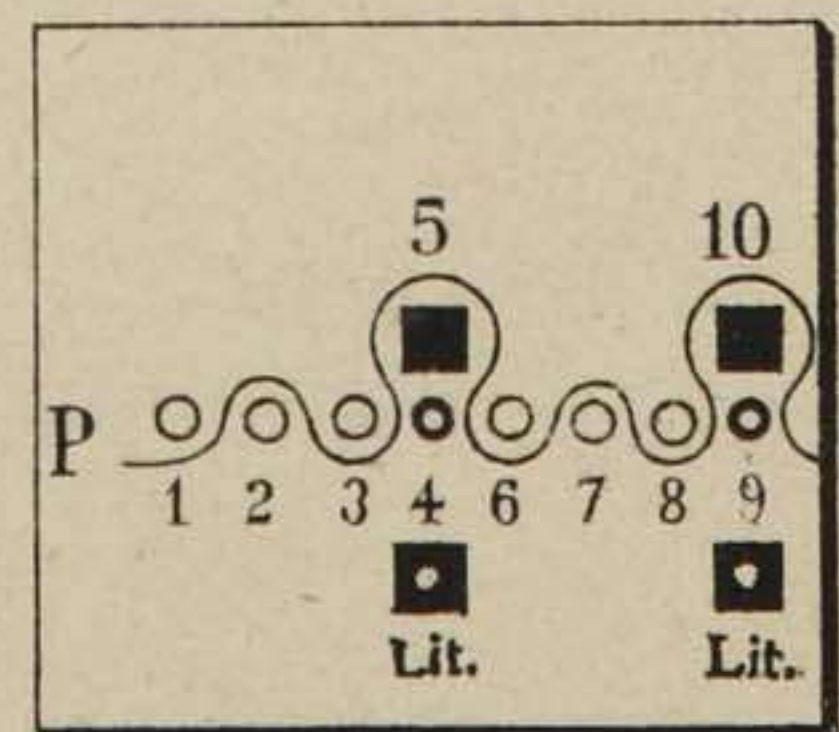


Fig. 1090

Fig. 1085

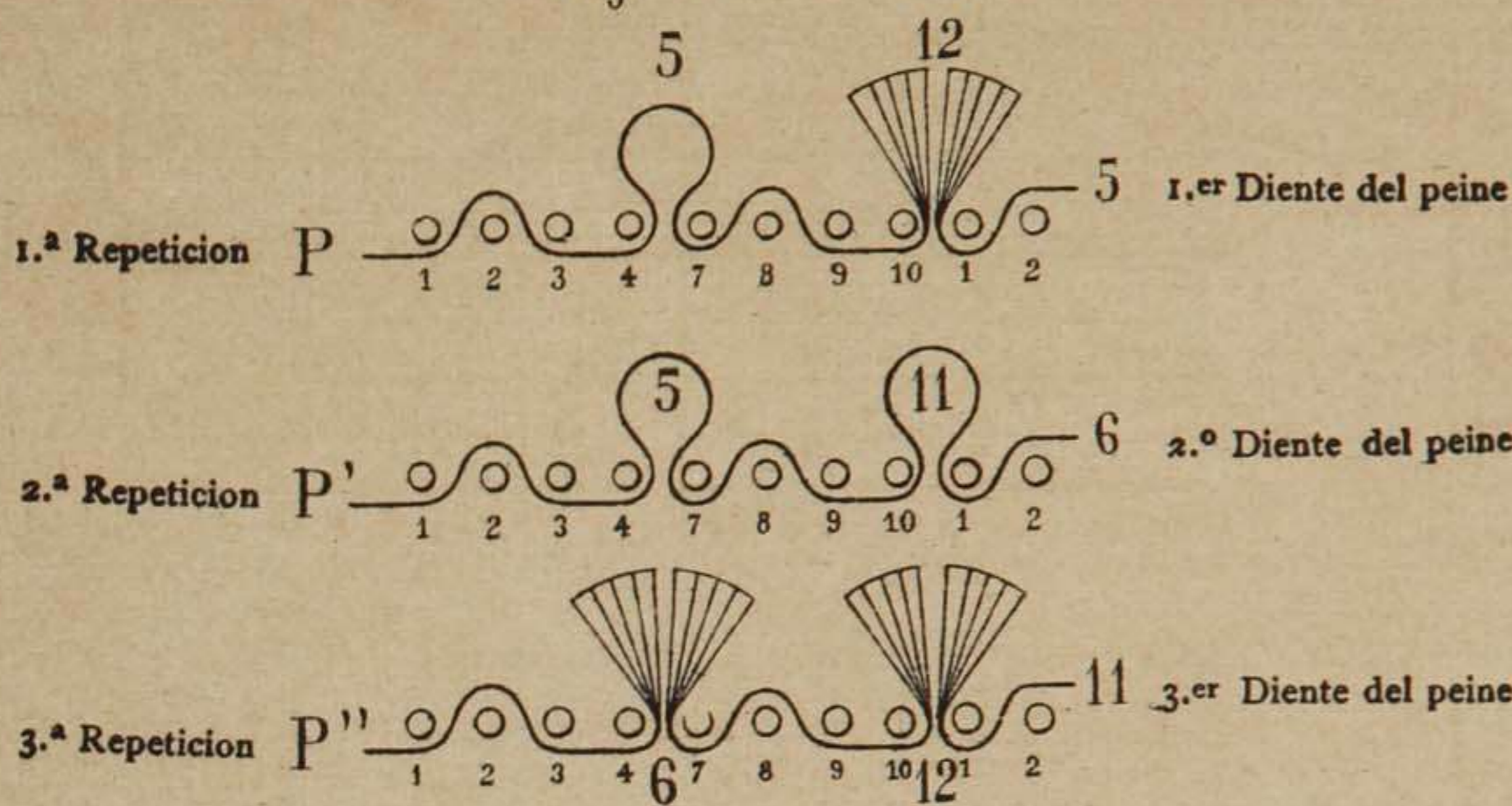


Fig. 1089

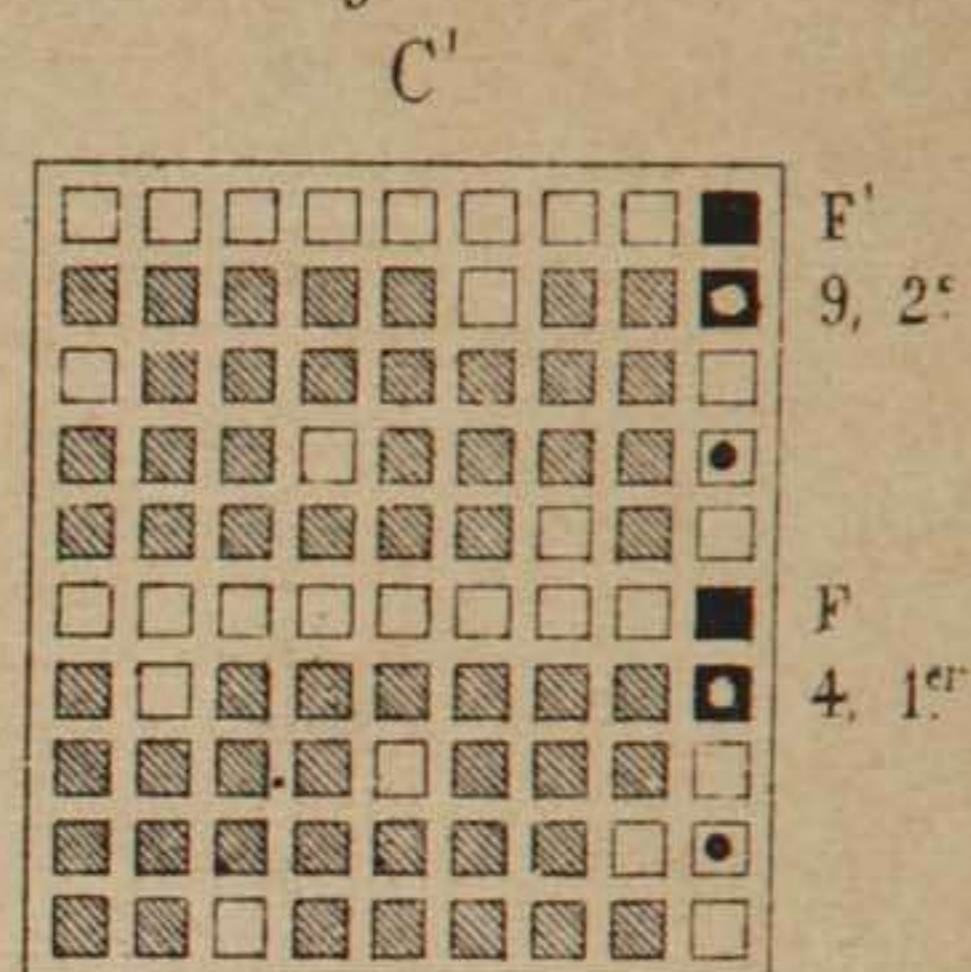


Fig. 1084

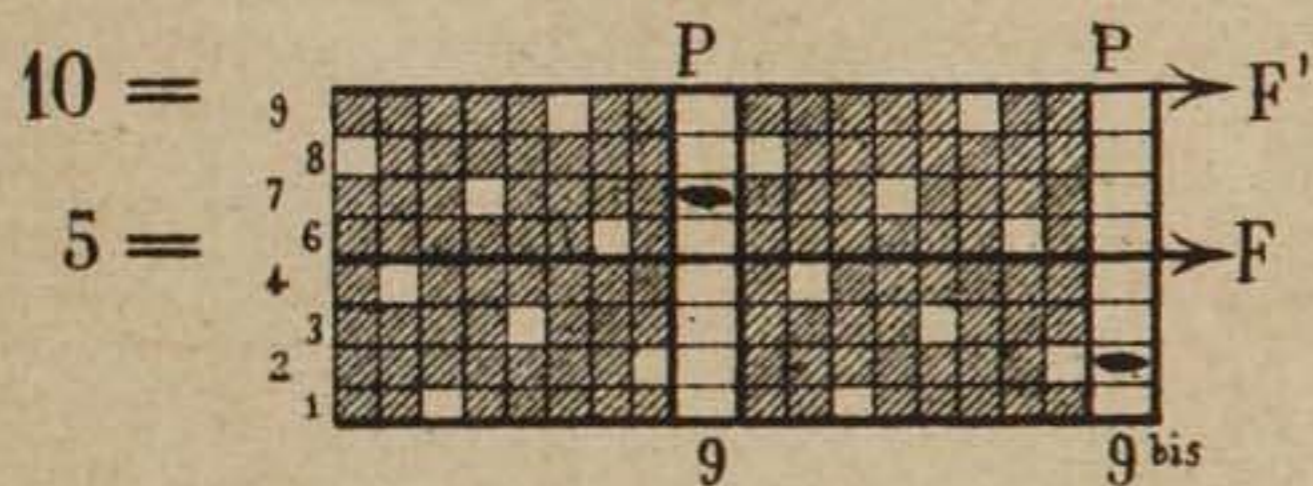


Fig. 1087

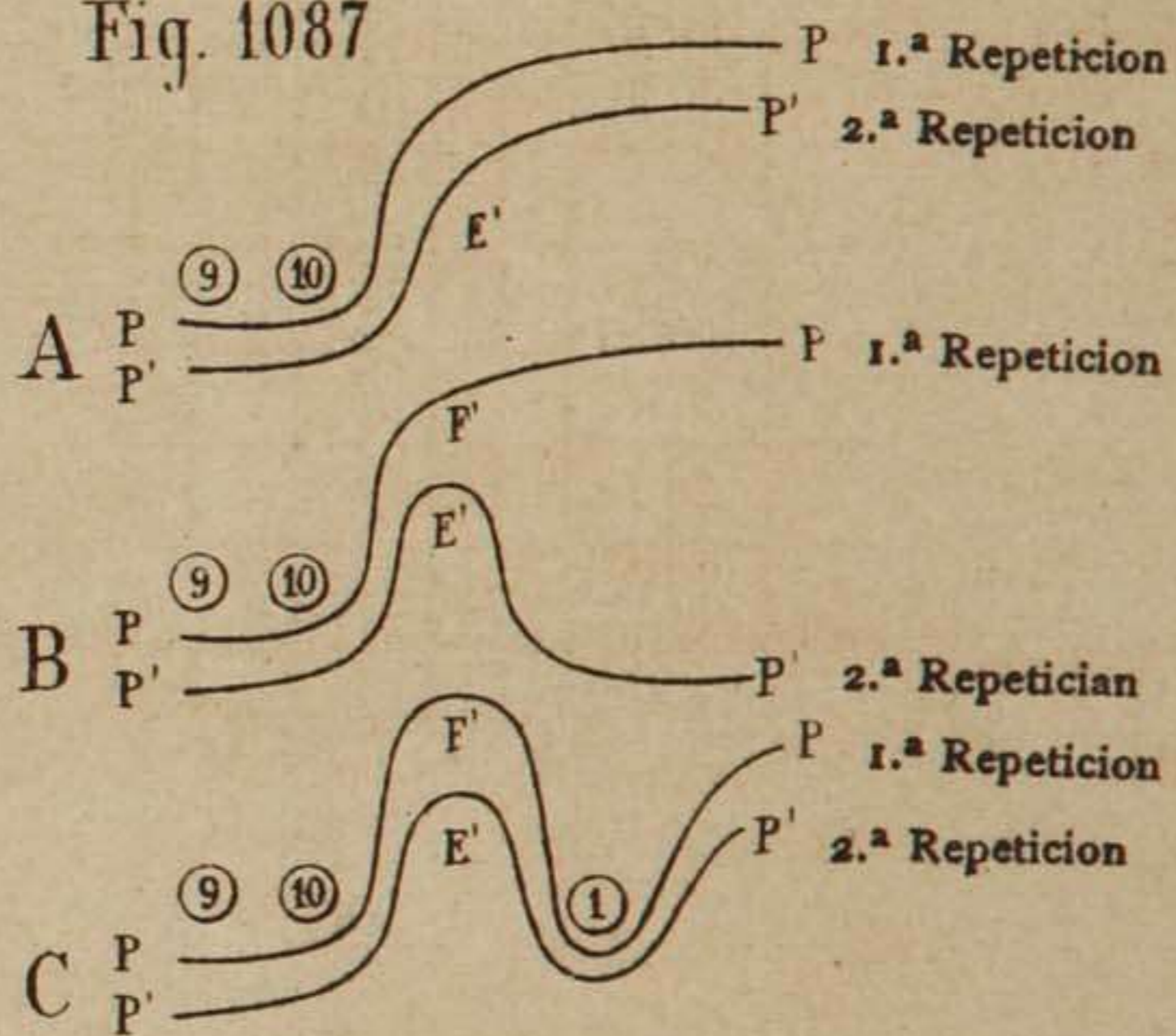


Fig. 1086

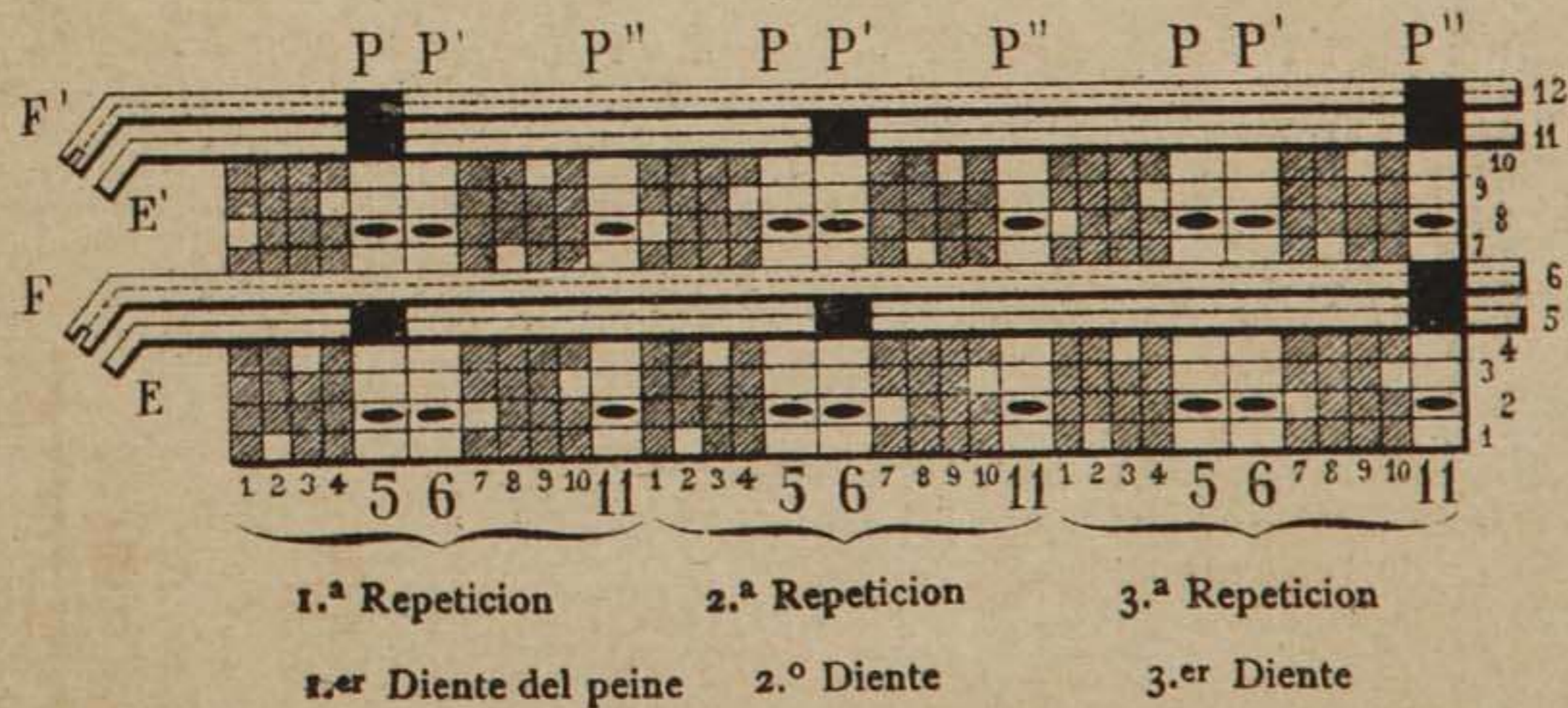
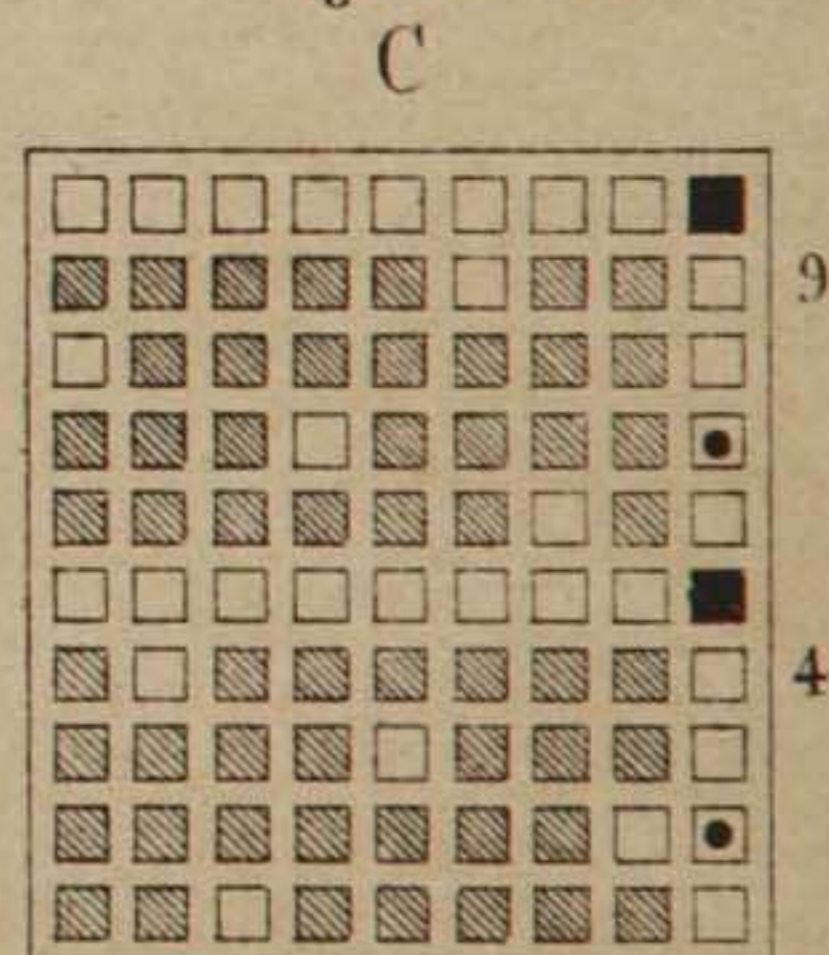


Fig. 1088



LEYENDA de los colores de las figs. 1070 y 1071

Urdimbre negro Ligado siempre Tomado en los diseños x, x', A, B, C

Trama verde Ligaduras Dejadas

Trama negra N en estos mismos Diseños

LEYENDA de la fig. 1073. Tejido

Urdimbre

Trama Negra

Trama Roja

Trama Naranja

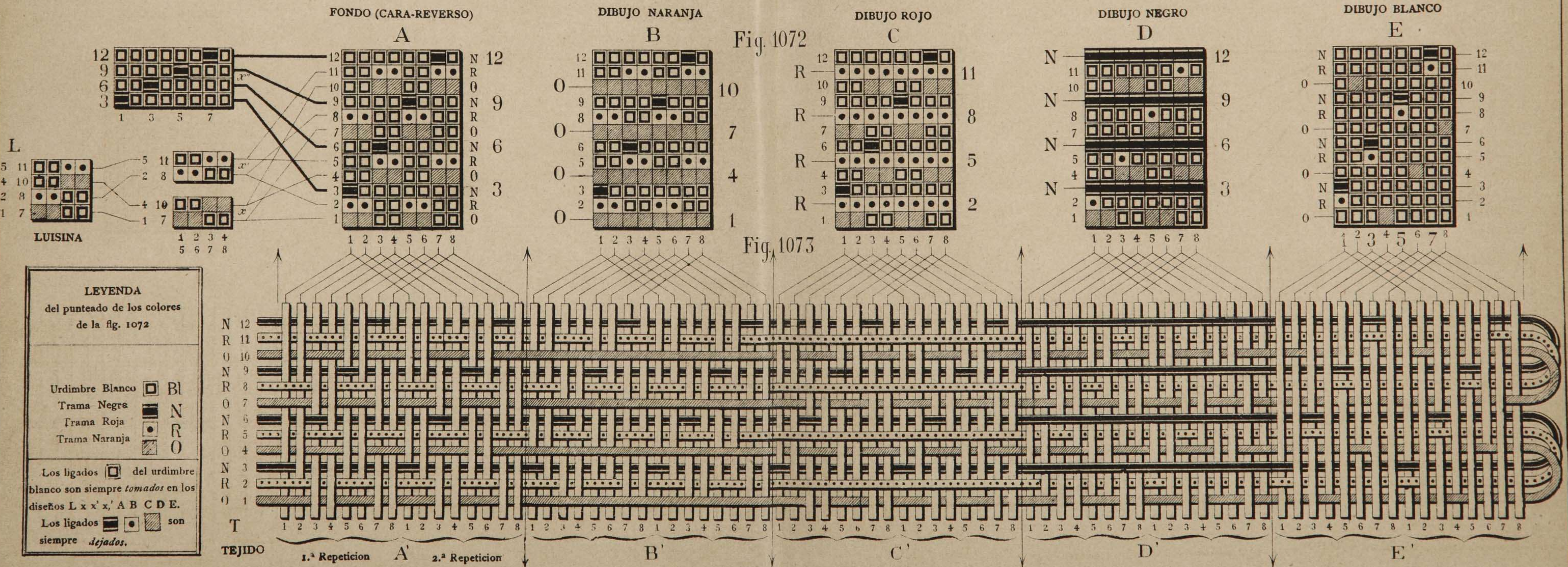
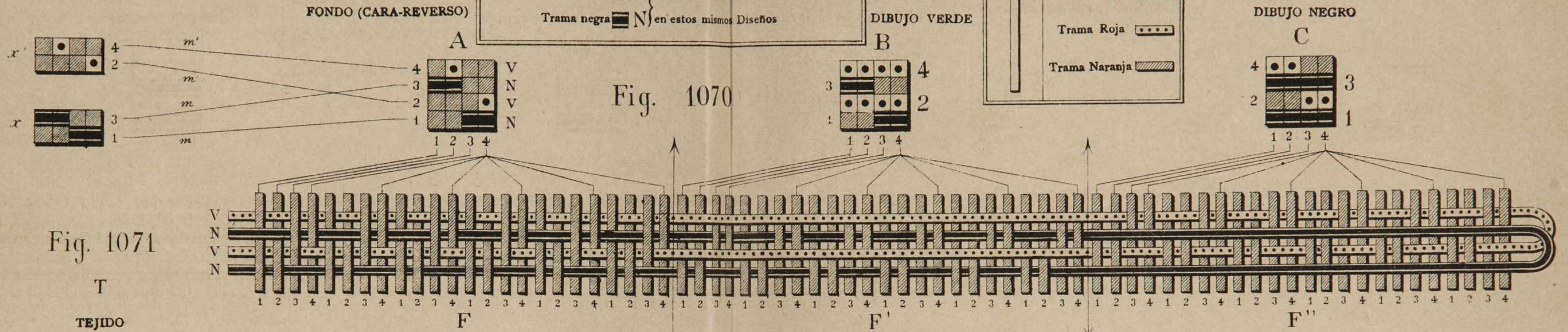


Fig 1095.

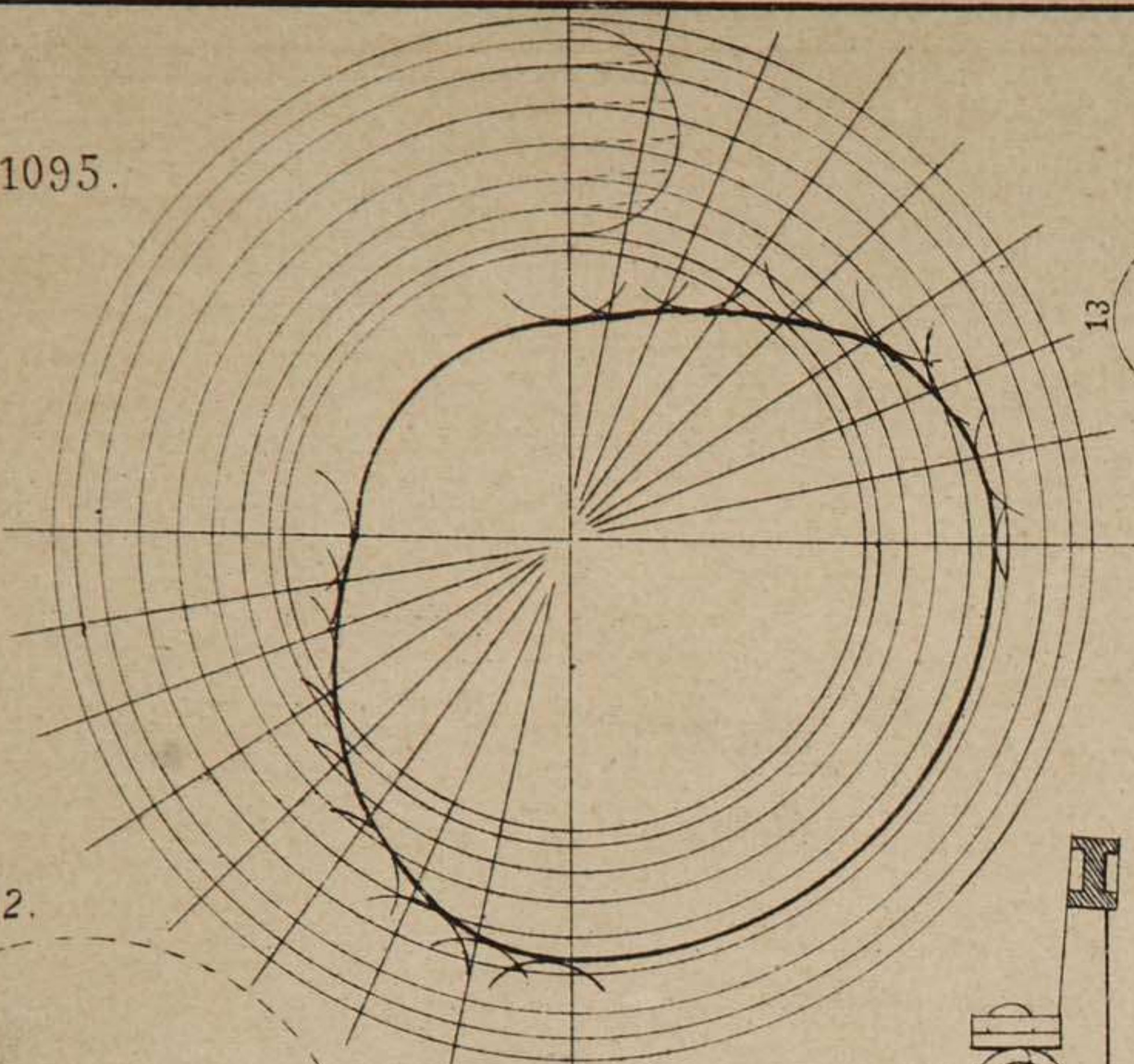


Fig.1092.

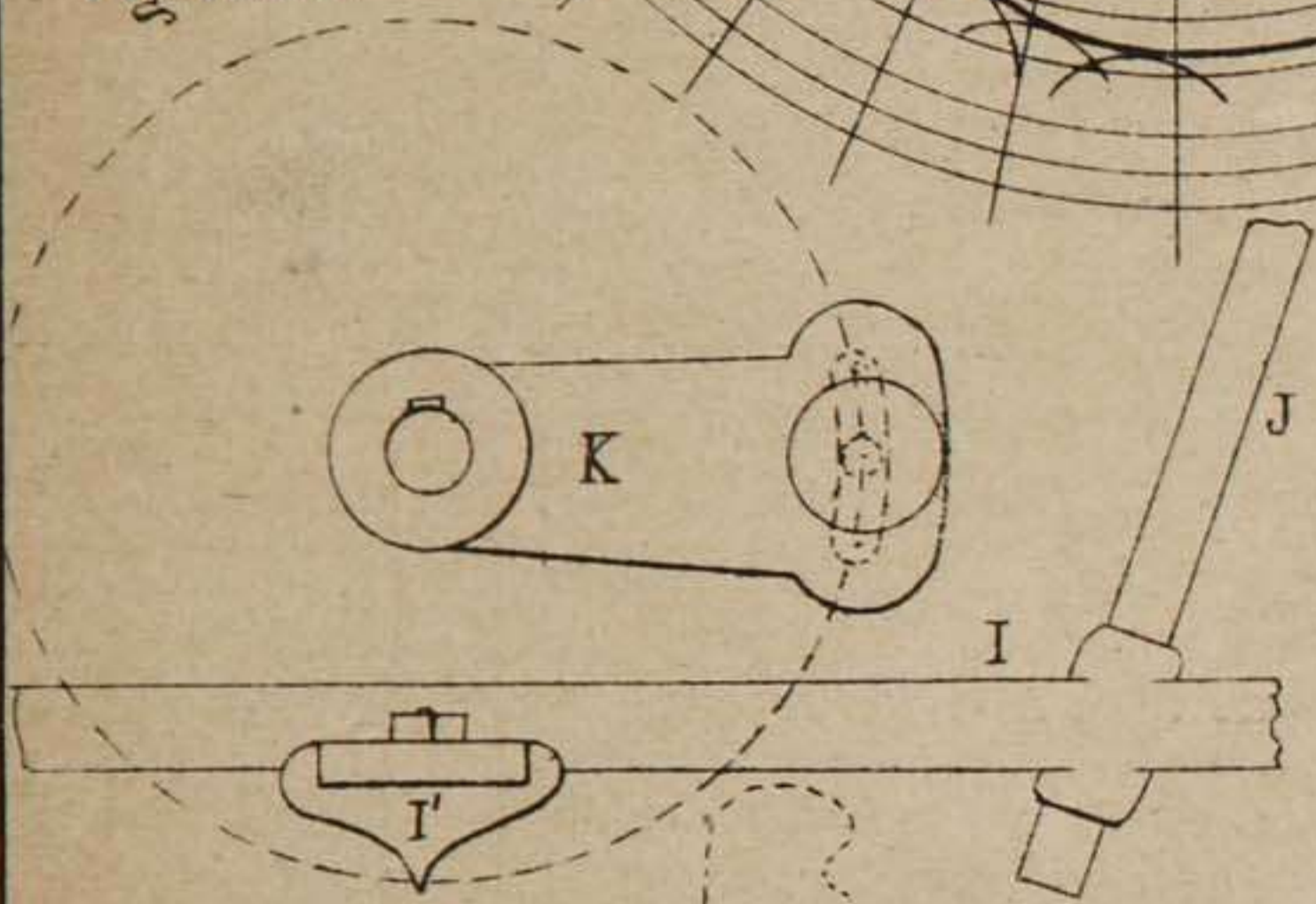


Fig.1093.

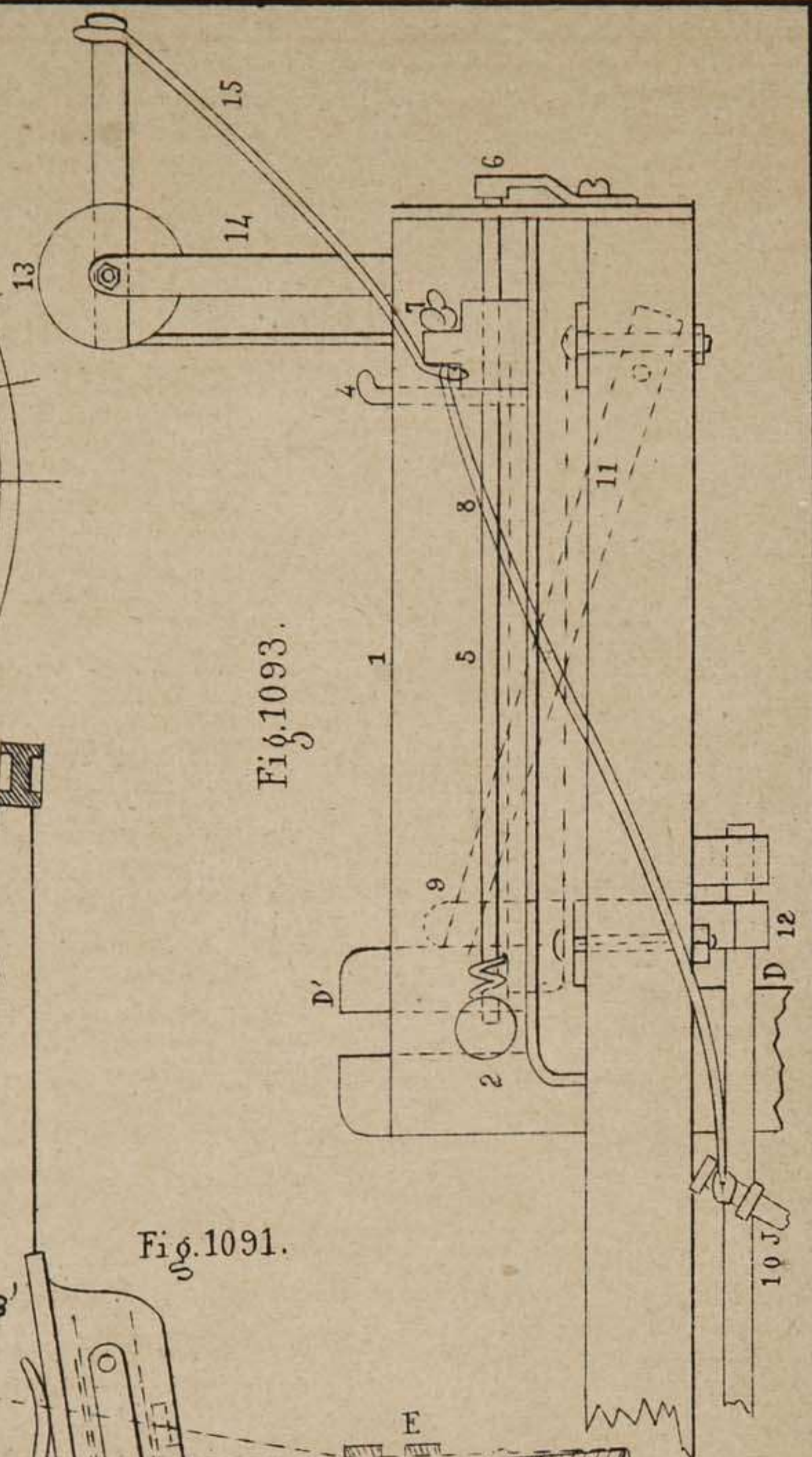


Fig.1091.

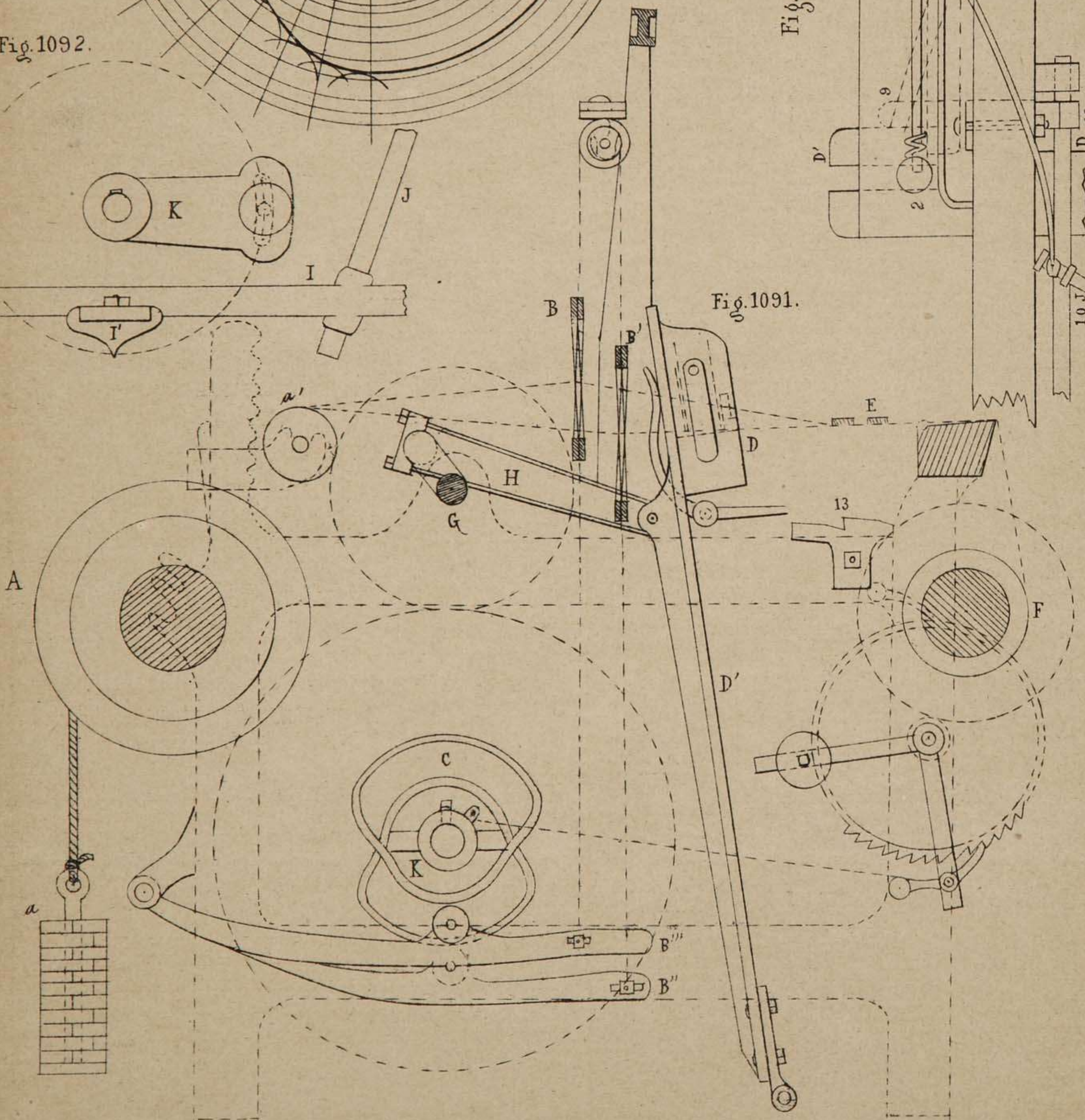




Fig 1096

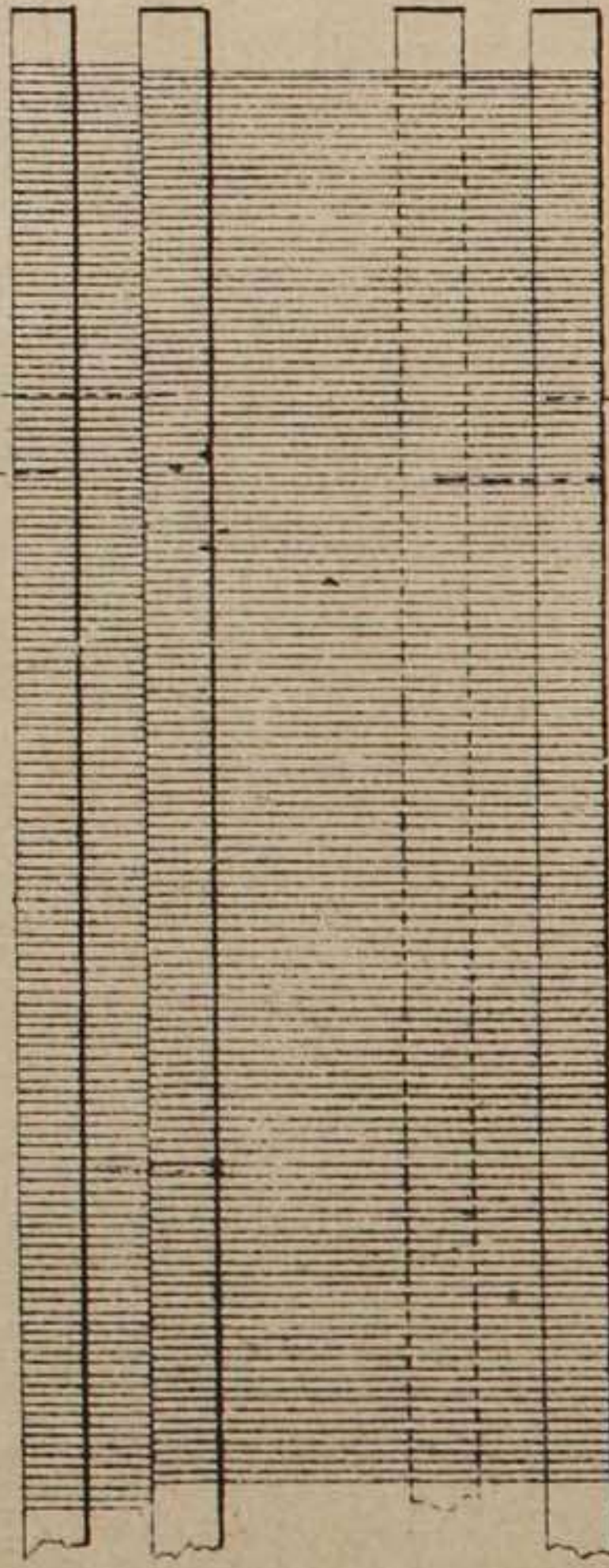


Fig. 1094

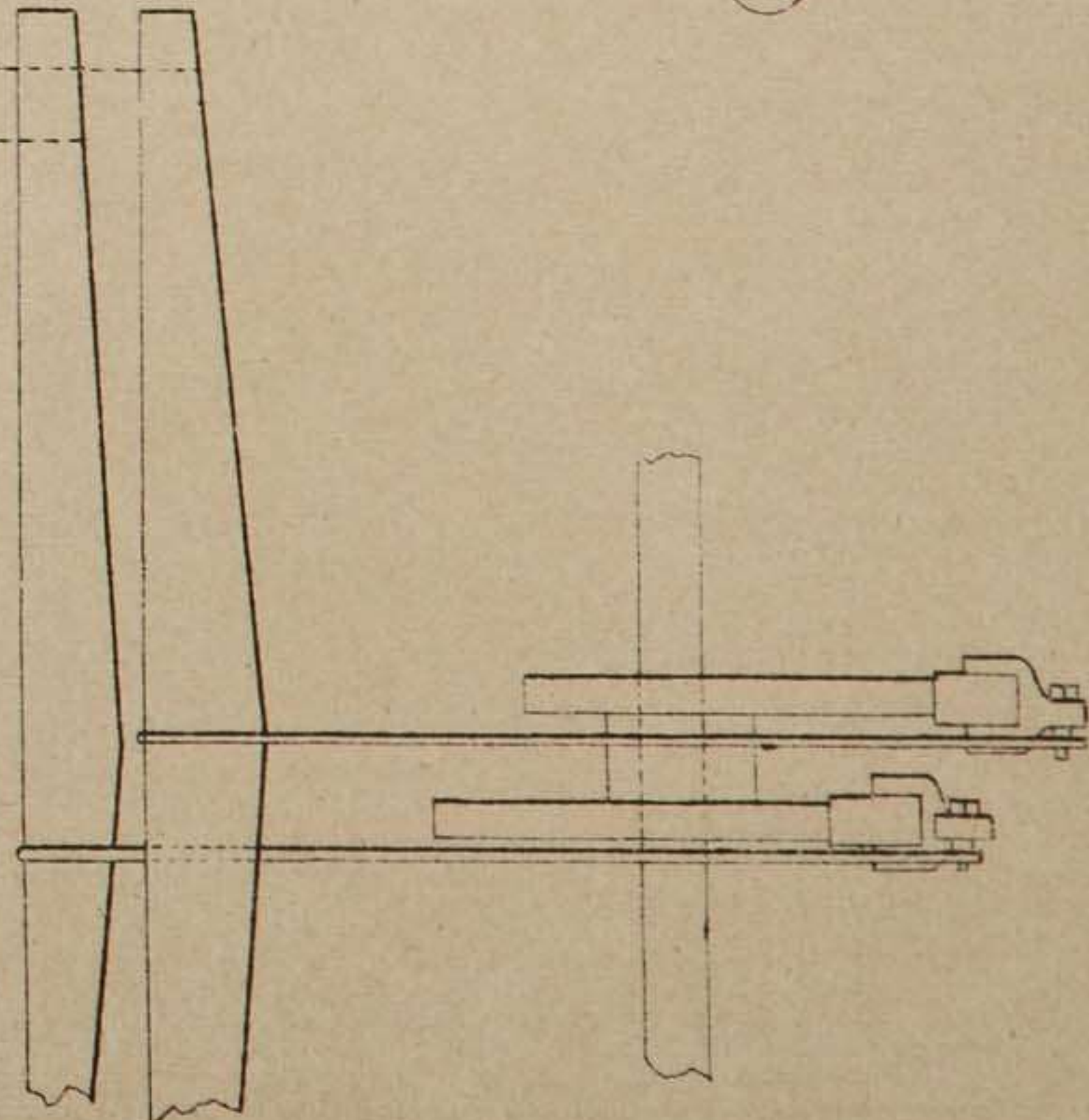


Fig. 1098.

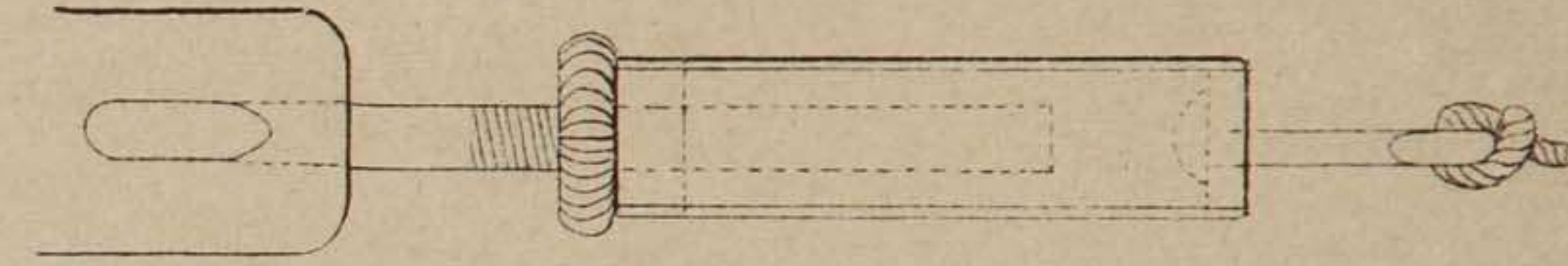


Fig. 1097.

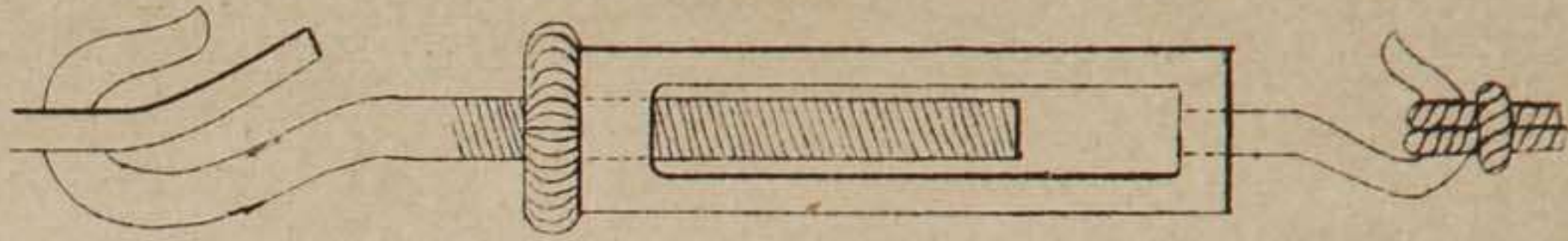


Fig. 1100

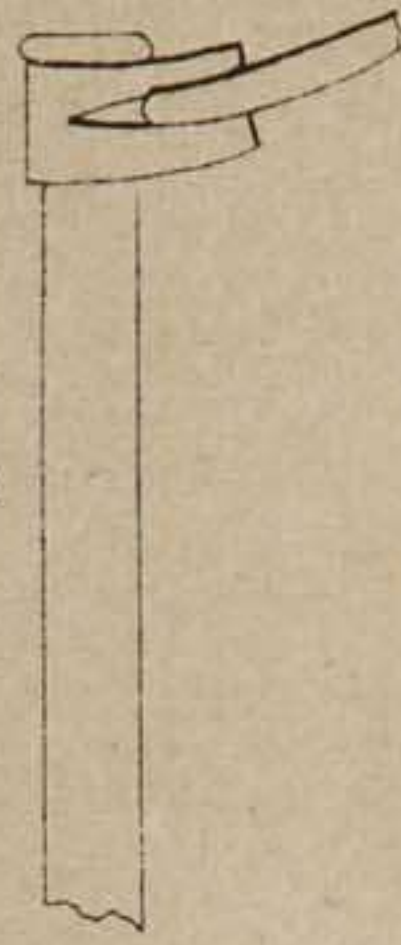
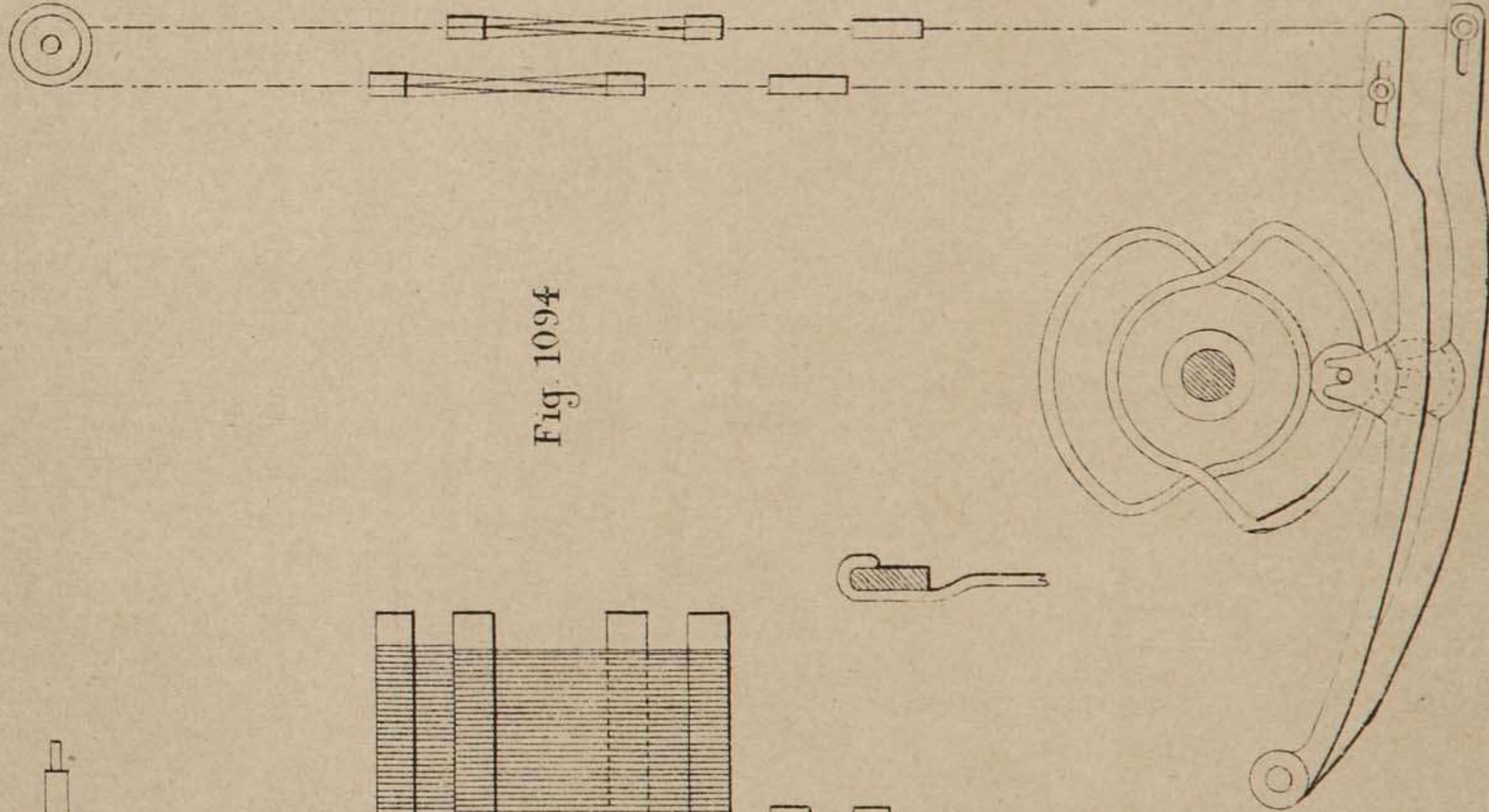
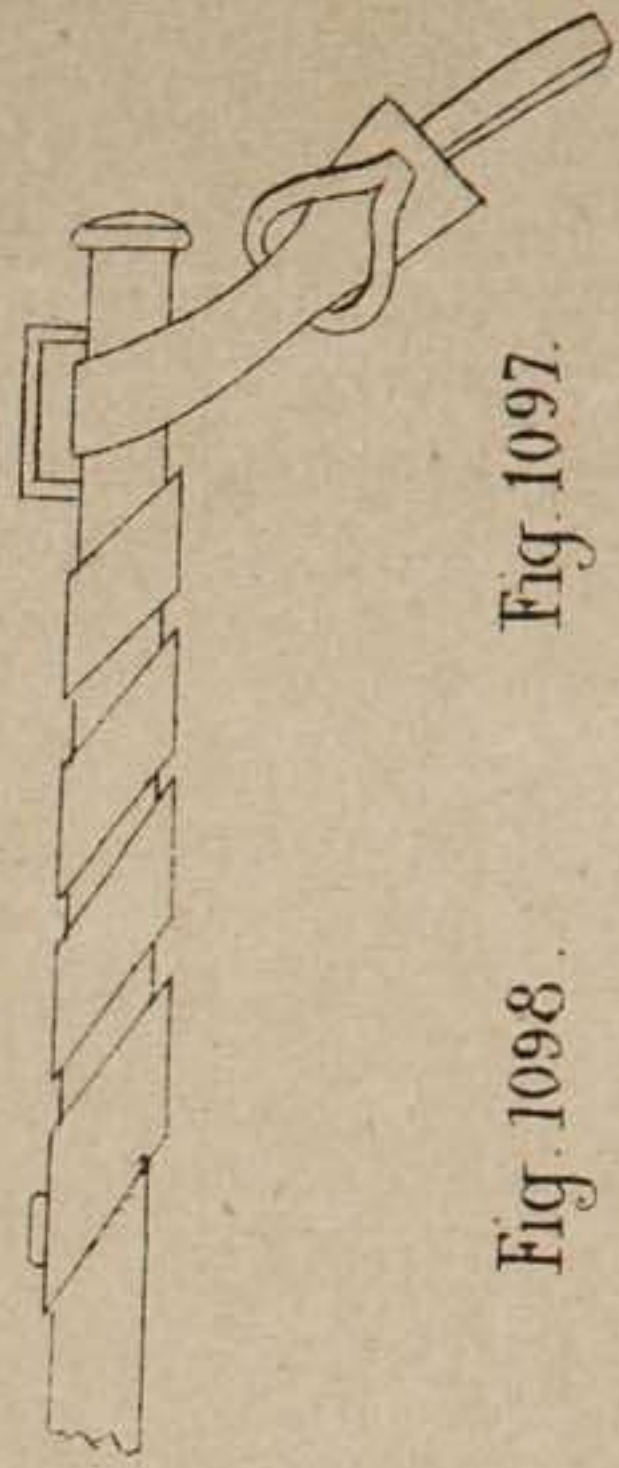


Fig. 1101.



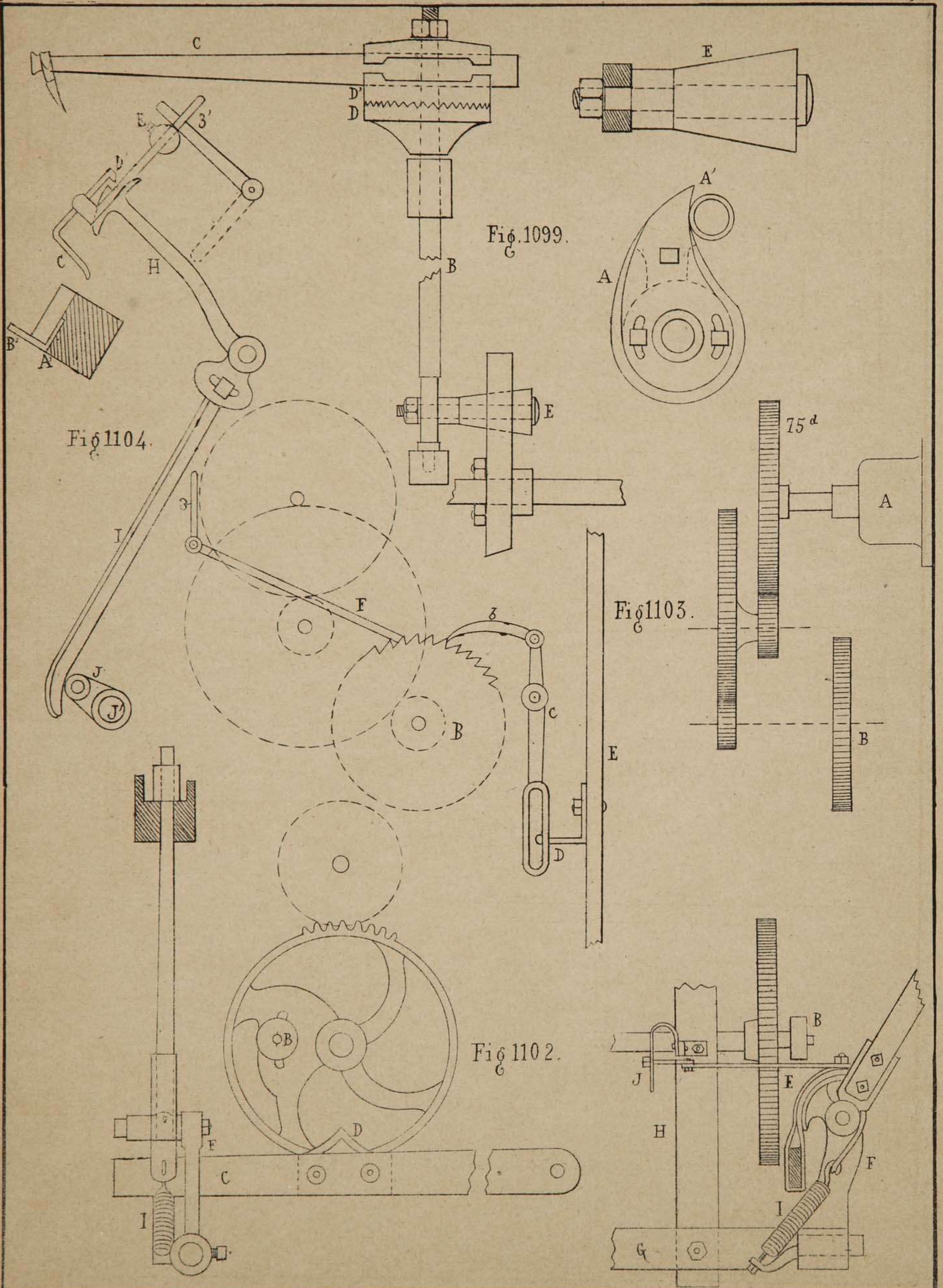


Fig. 1112.

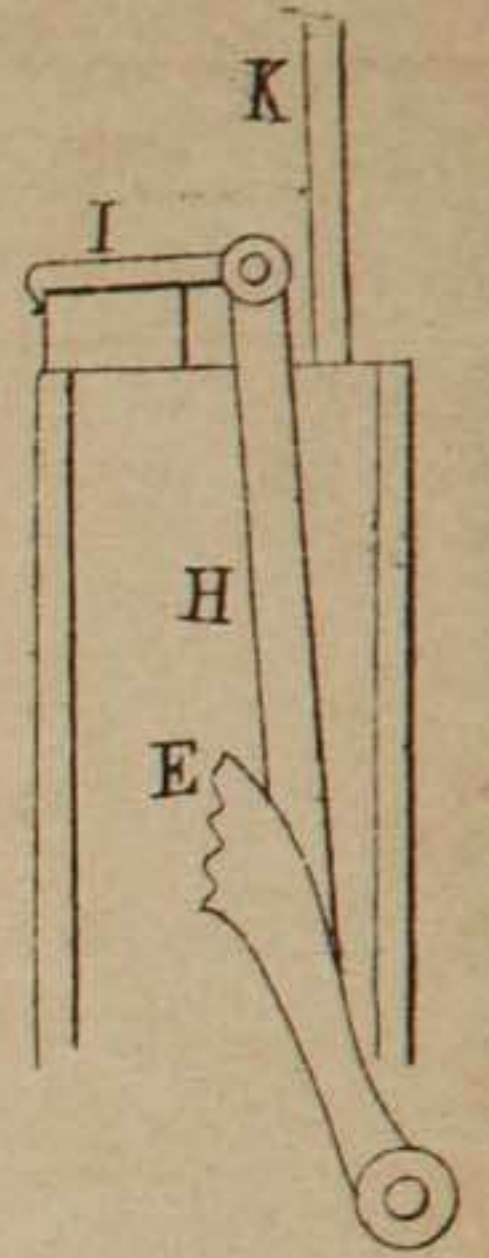
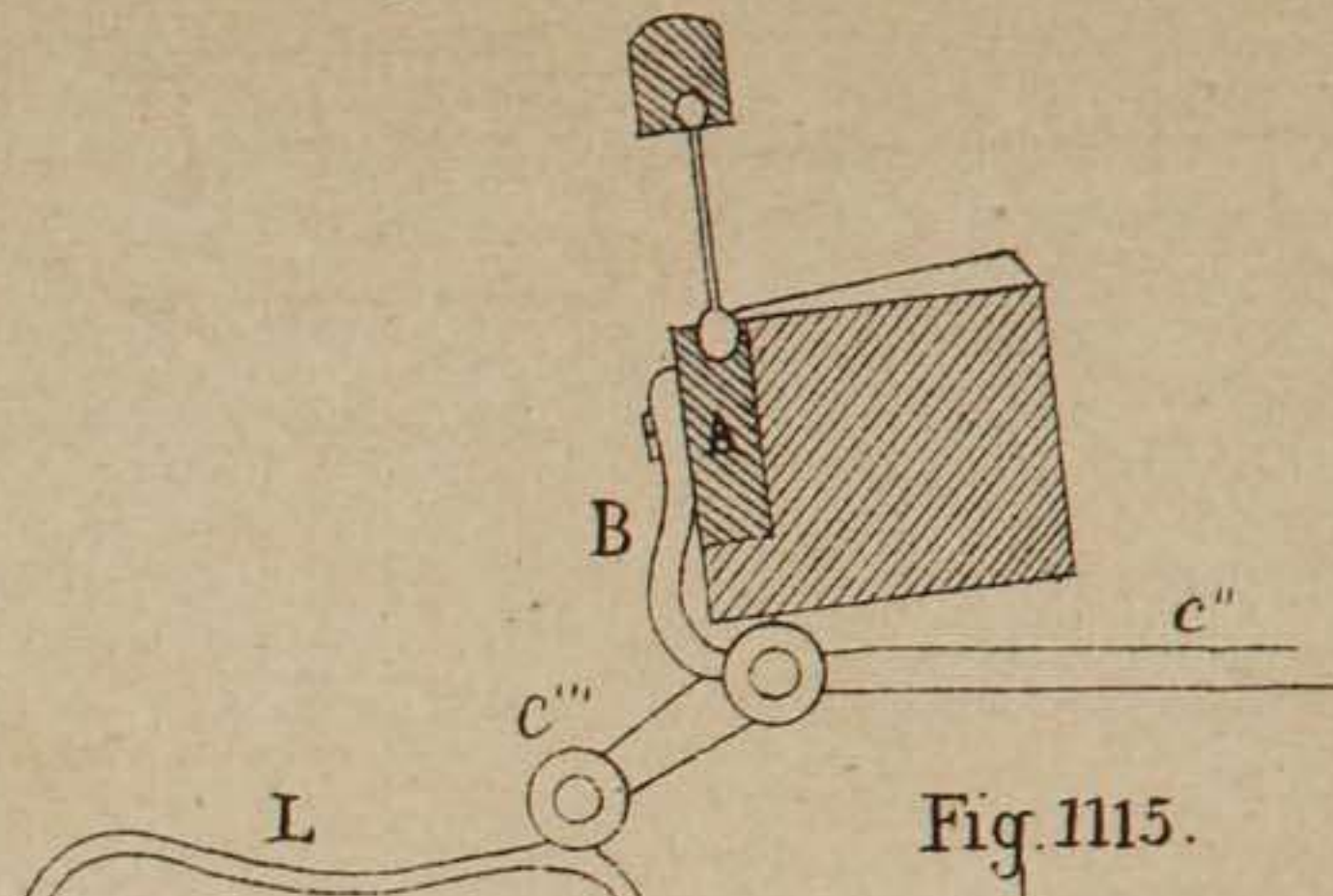
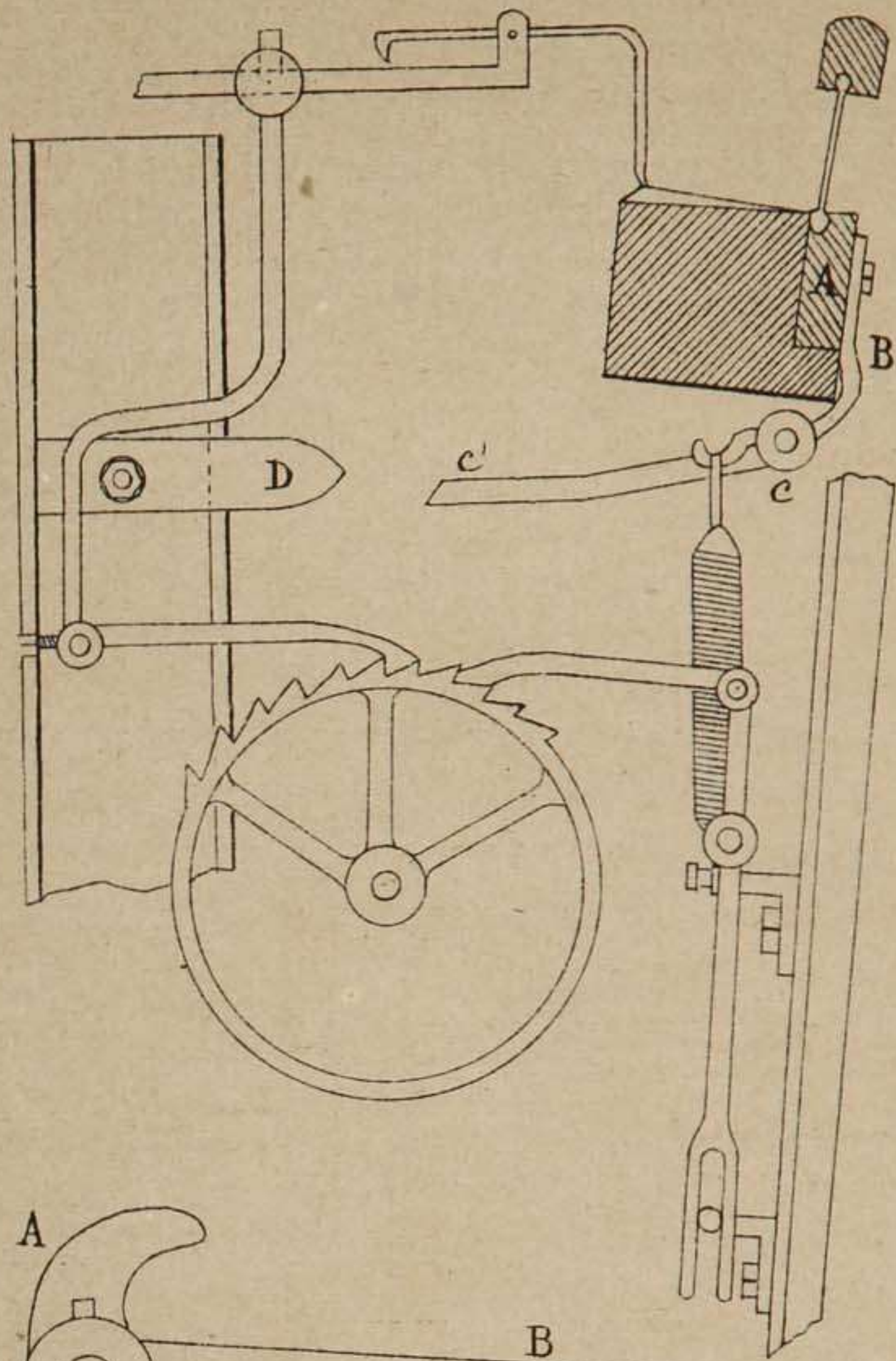
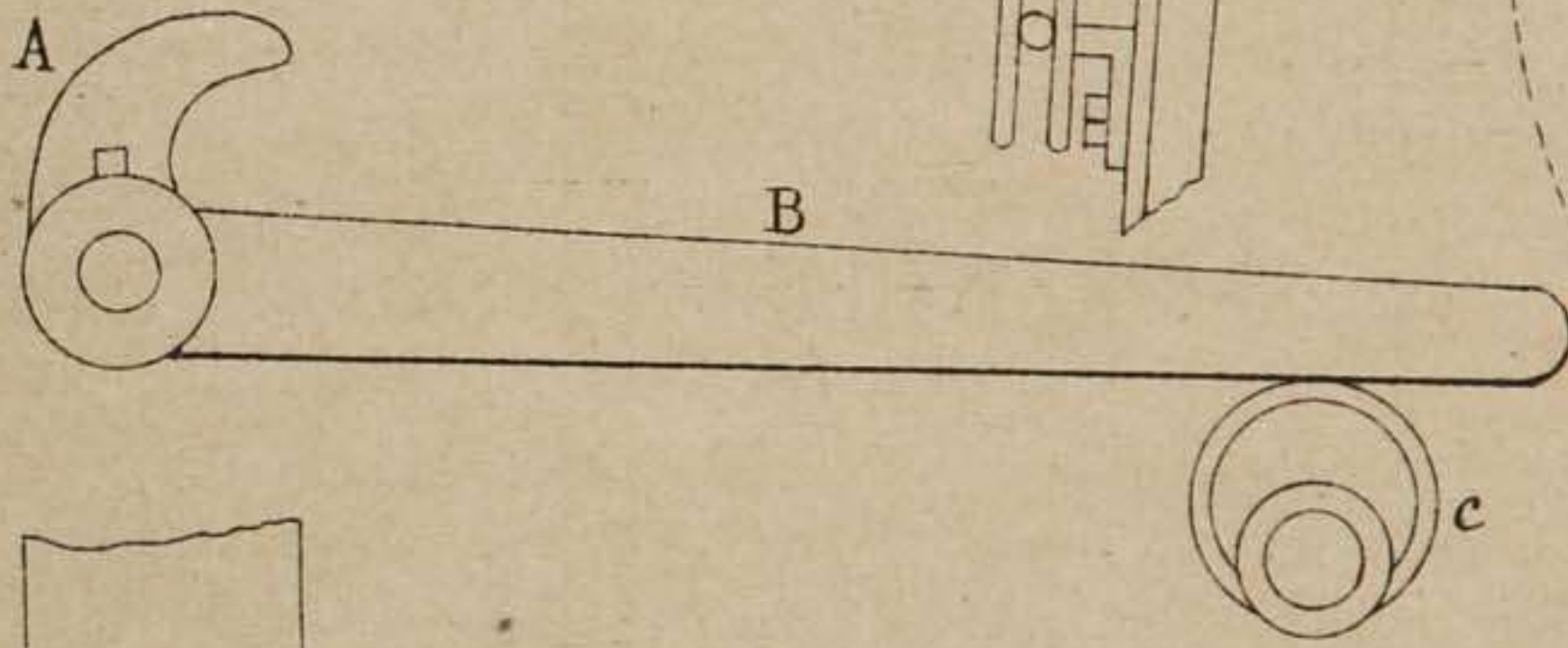
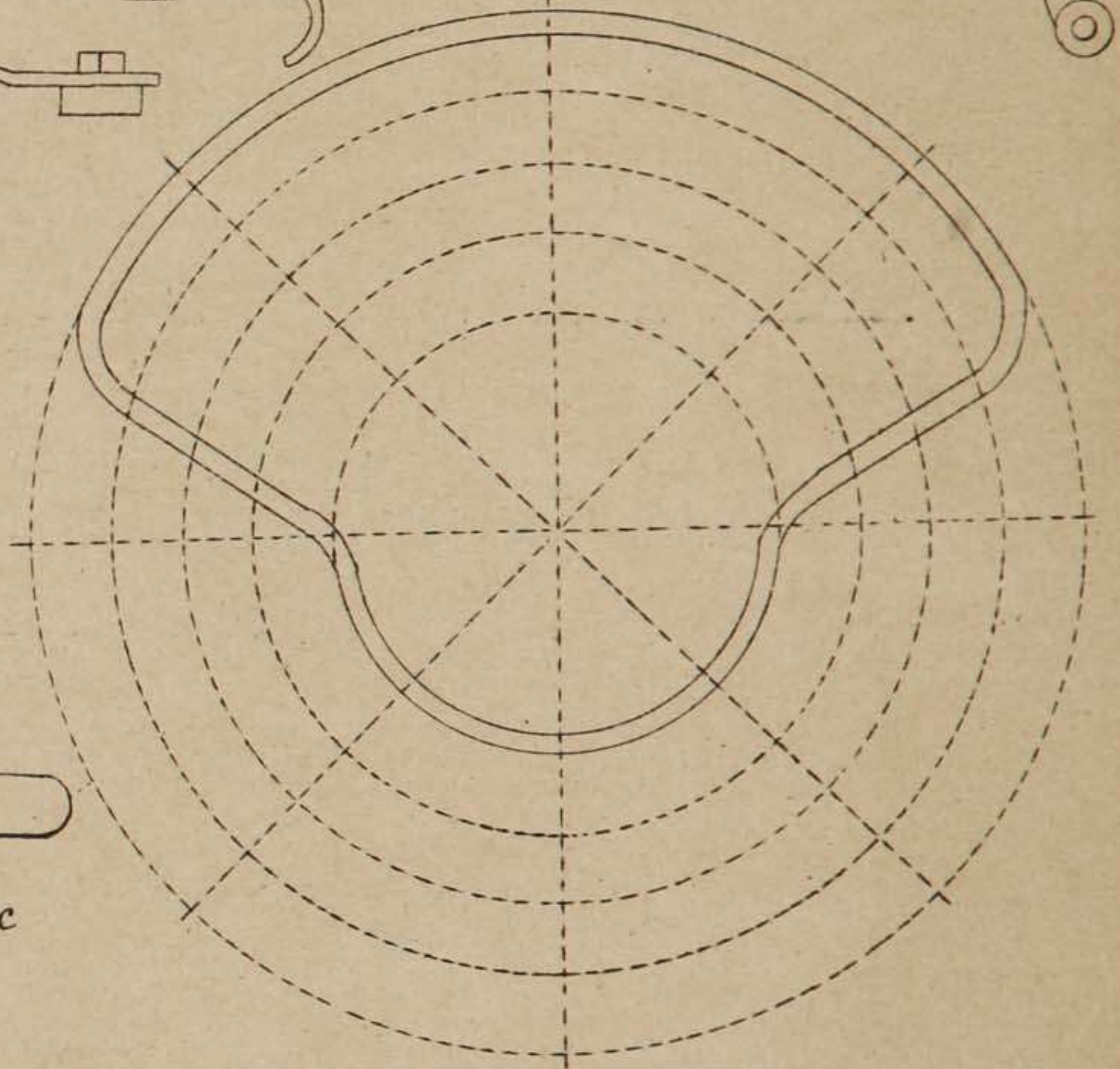


Fig. 1115.



A

Fig. 1113.

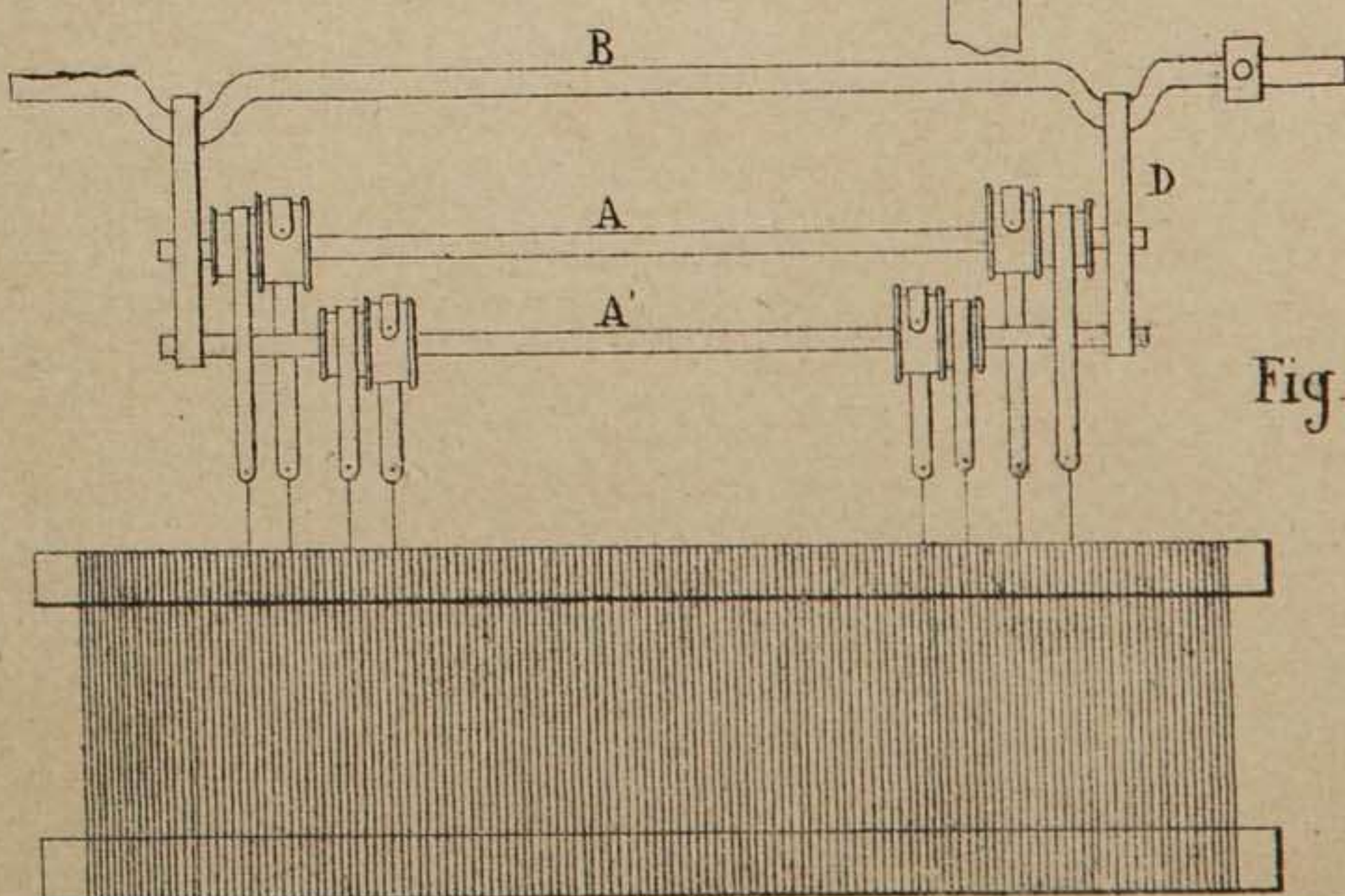
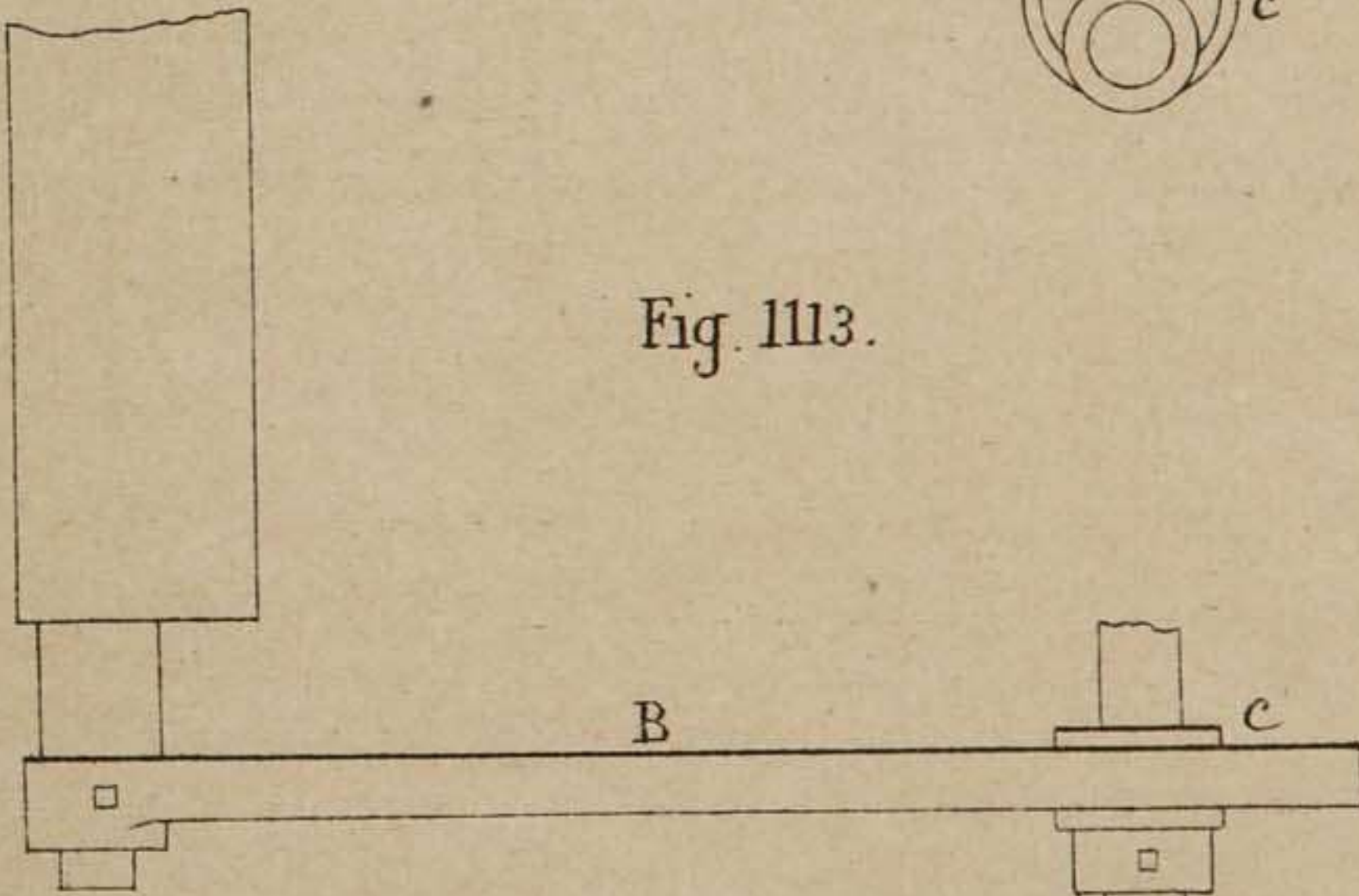


Fig. 1117.

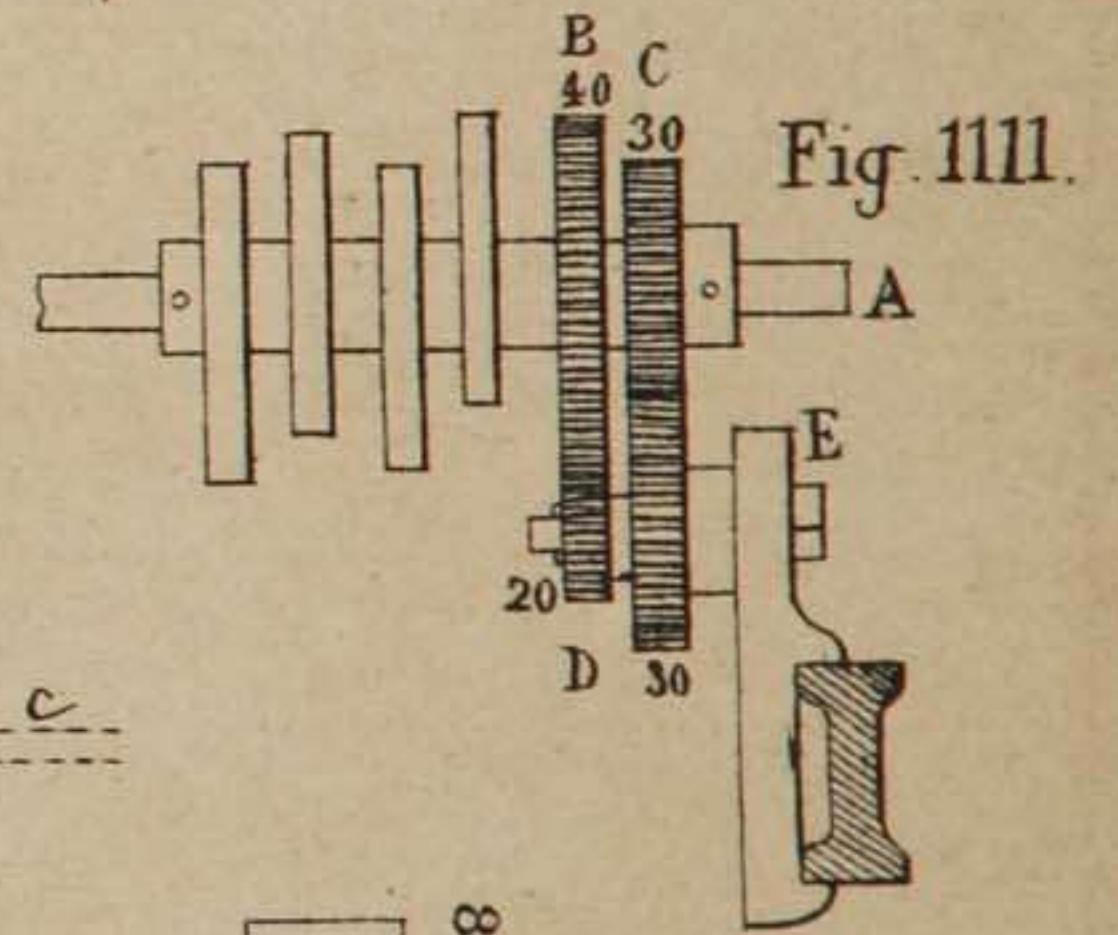


Fig. 1111.

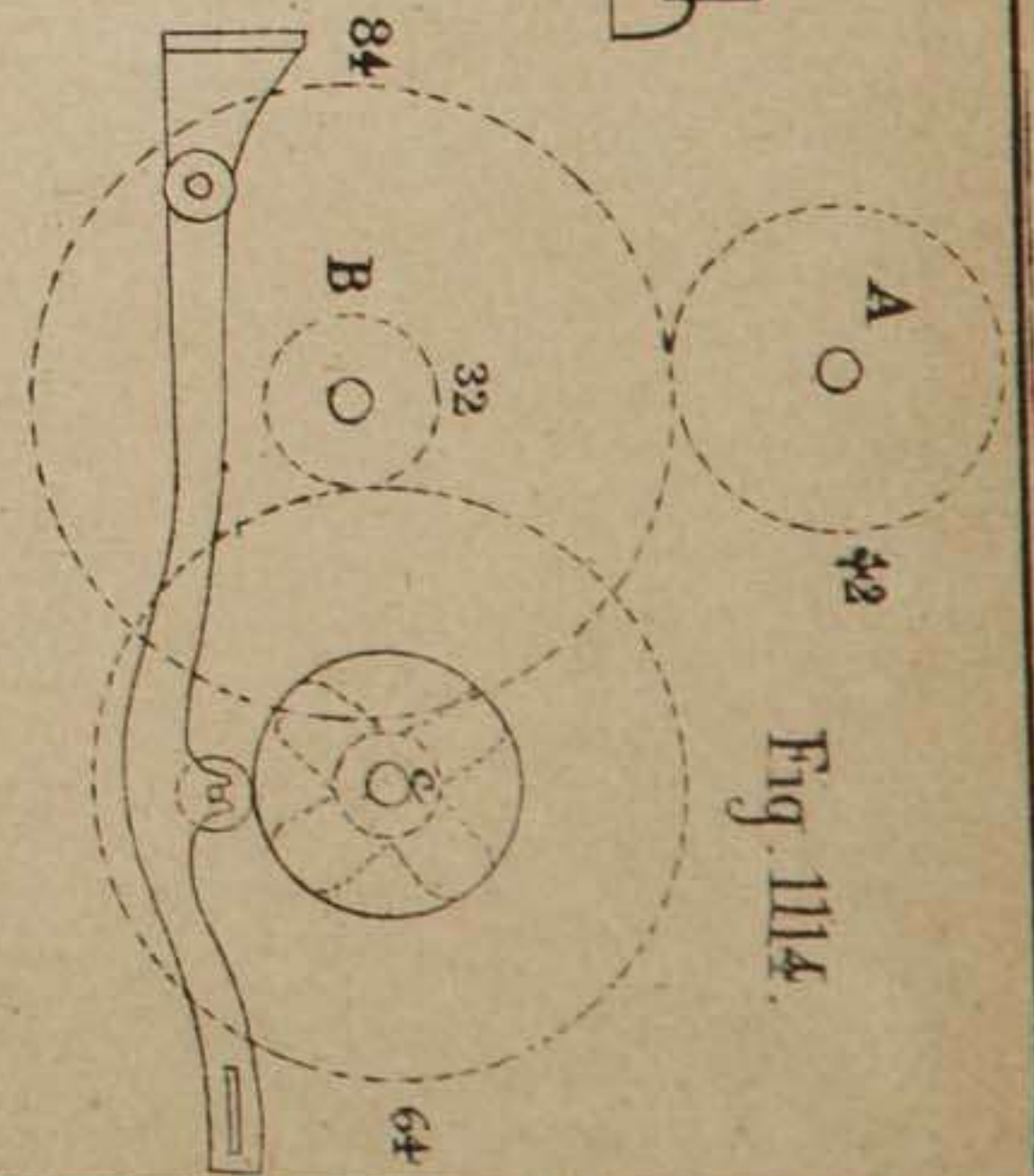
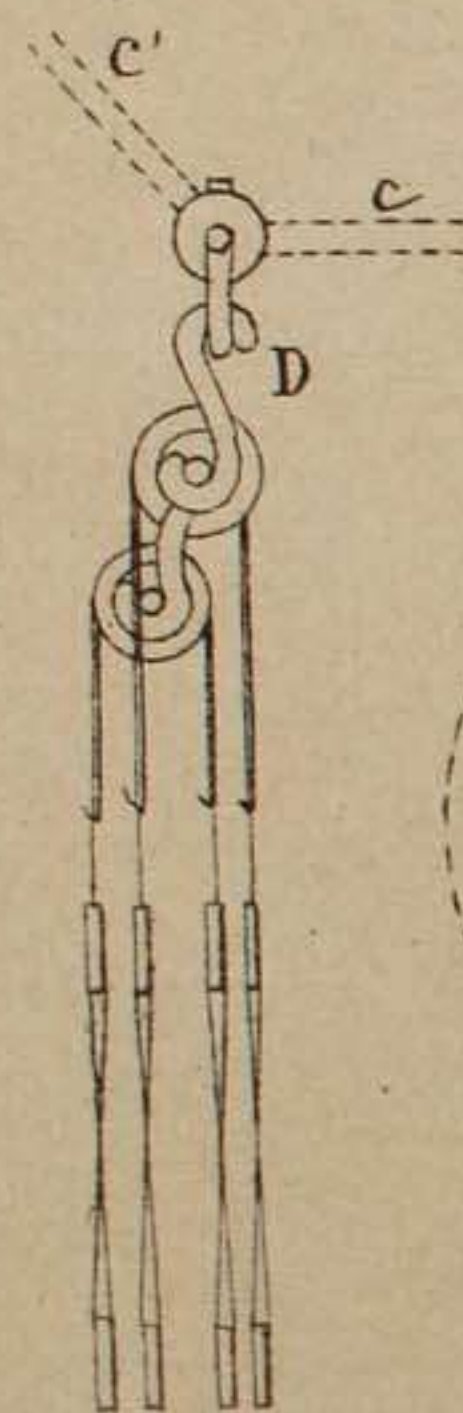
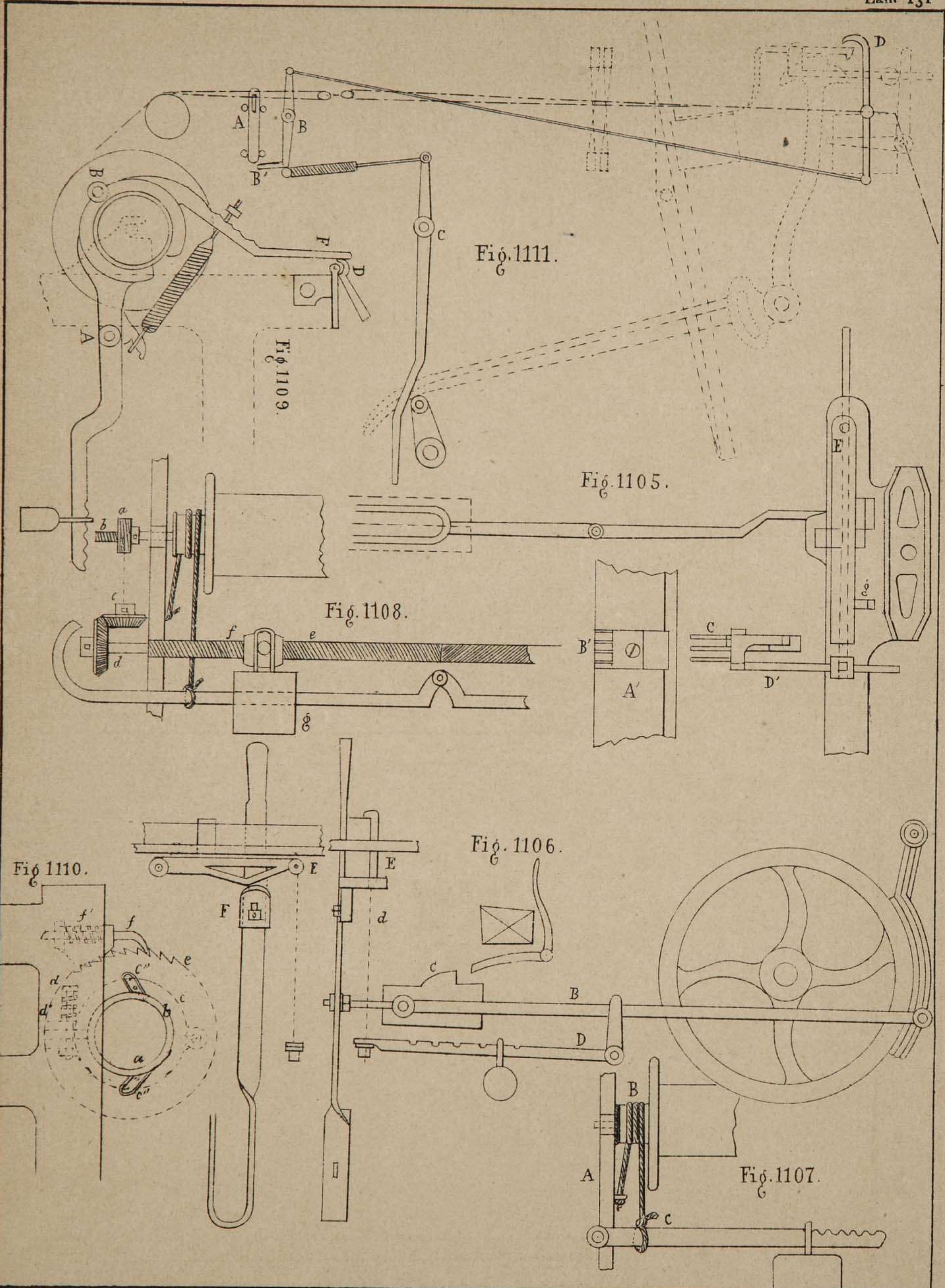


Fig. 1114.



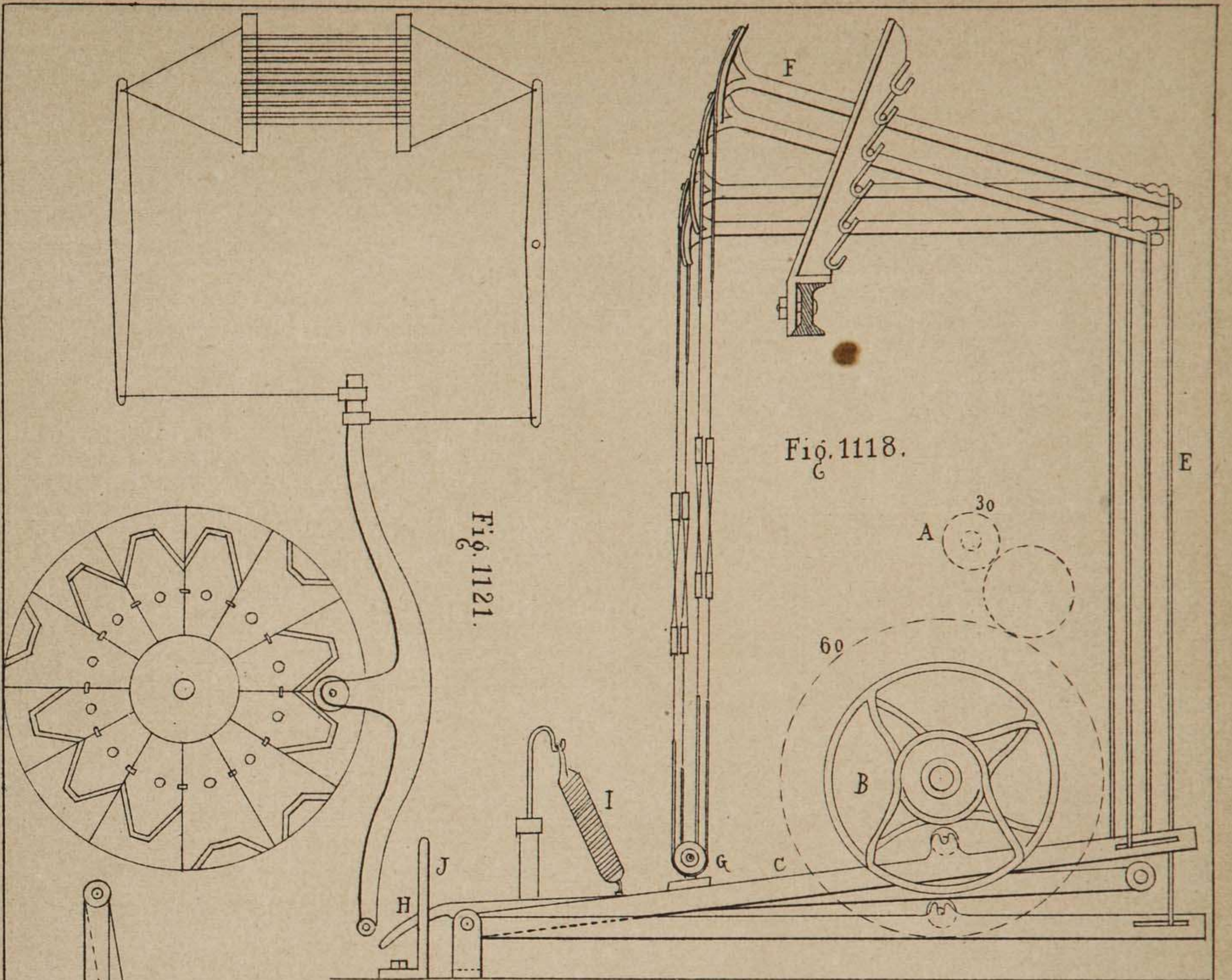


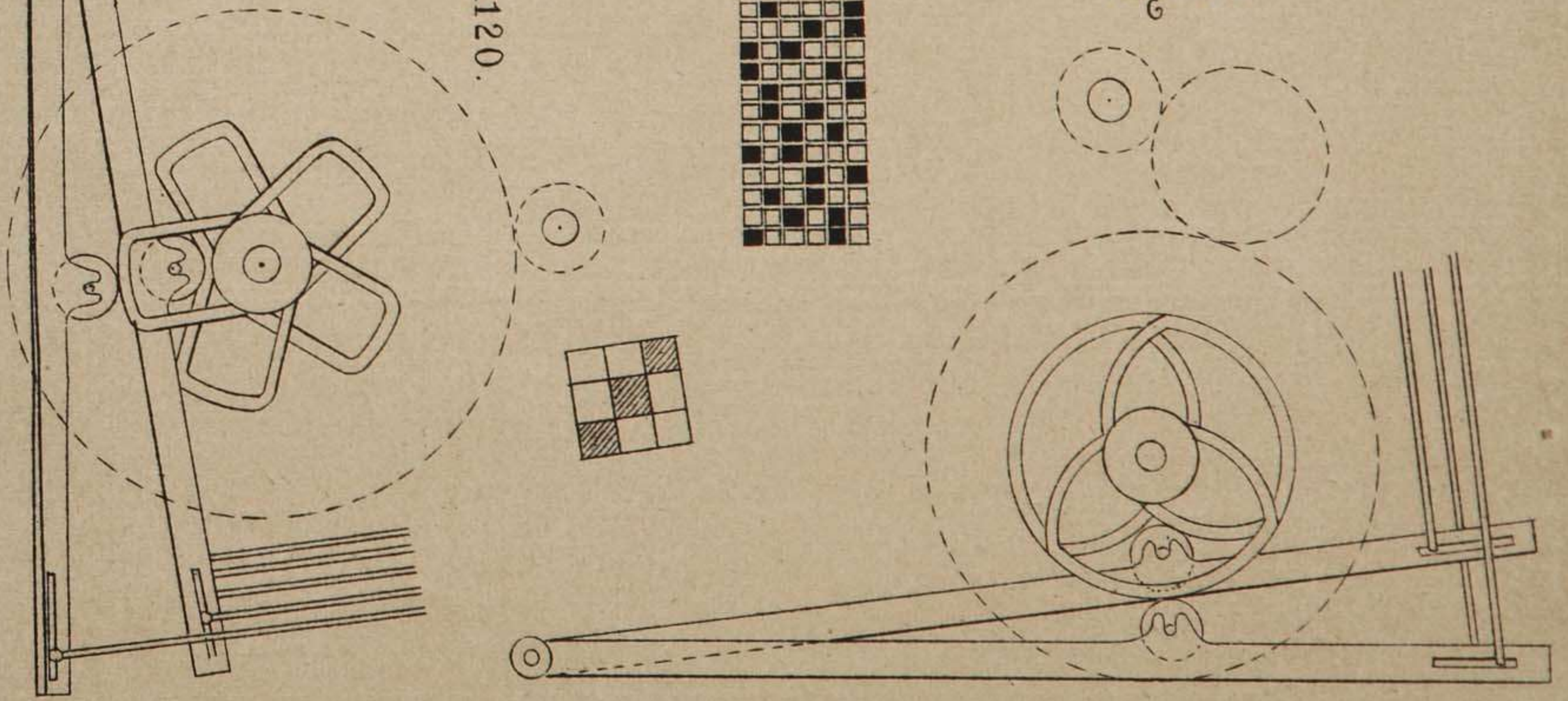
Fig. 1118.

Fig. 1121.

Fig. 1120.

Fig. 1122.

Fig. 1119.



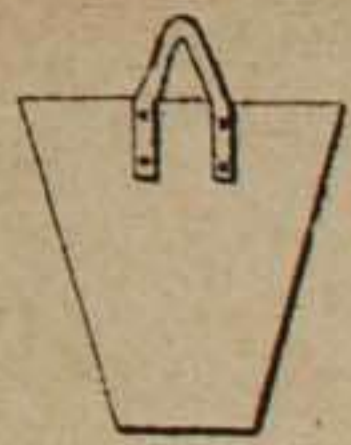


Fig. 1123.

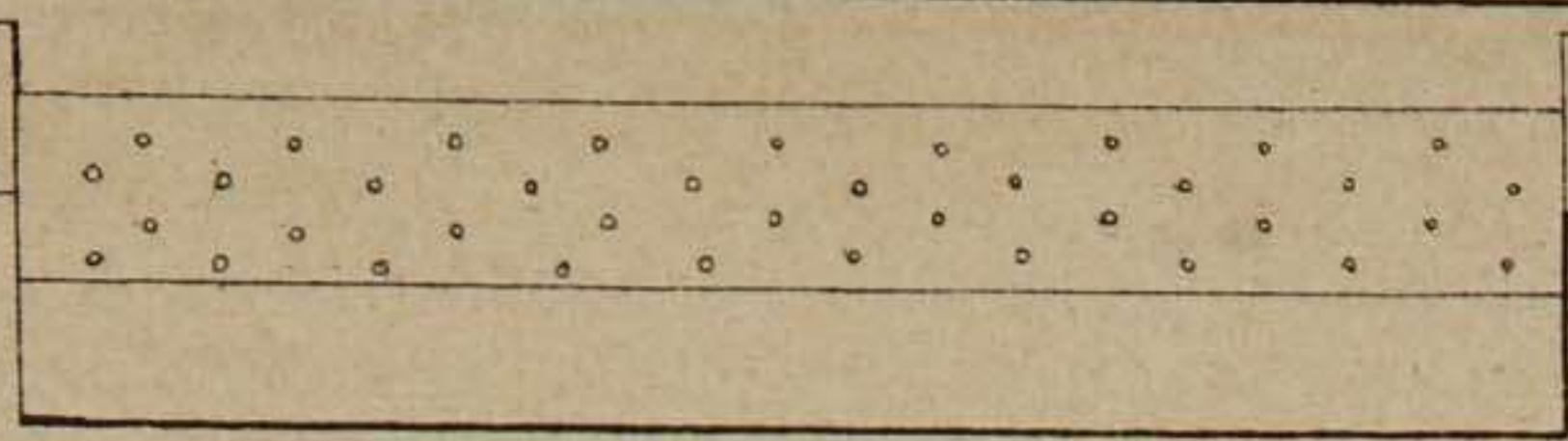


Fig. 1127.

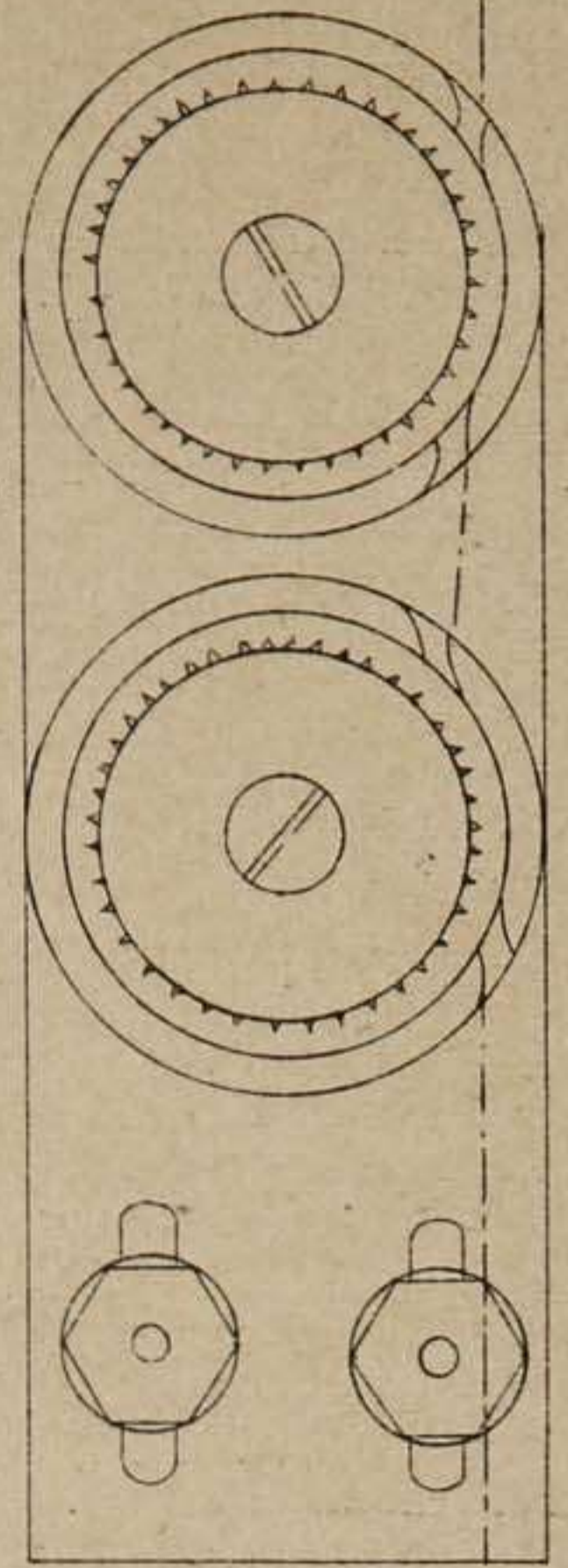


Fig. 1126.

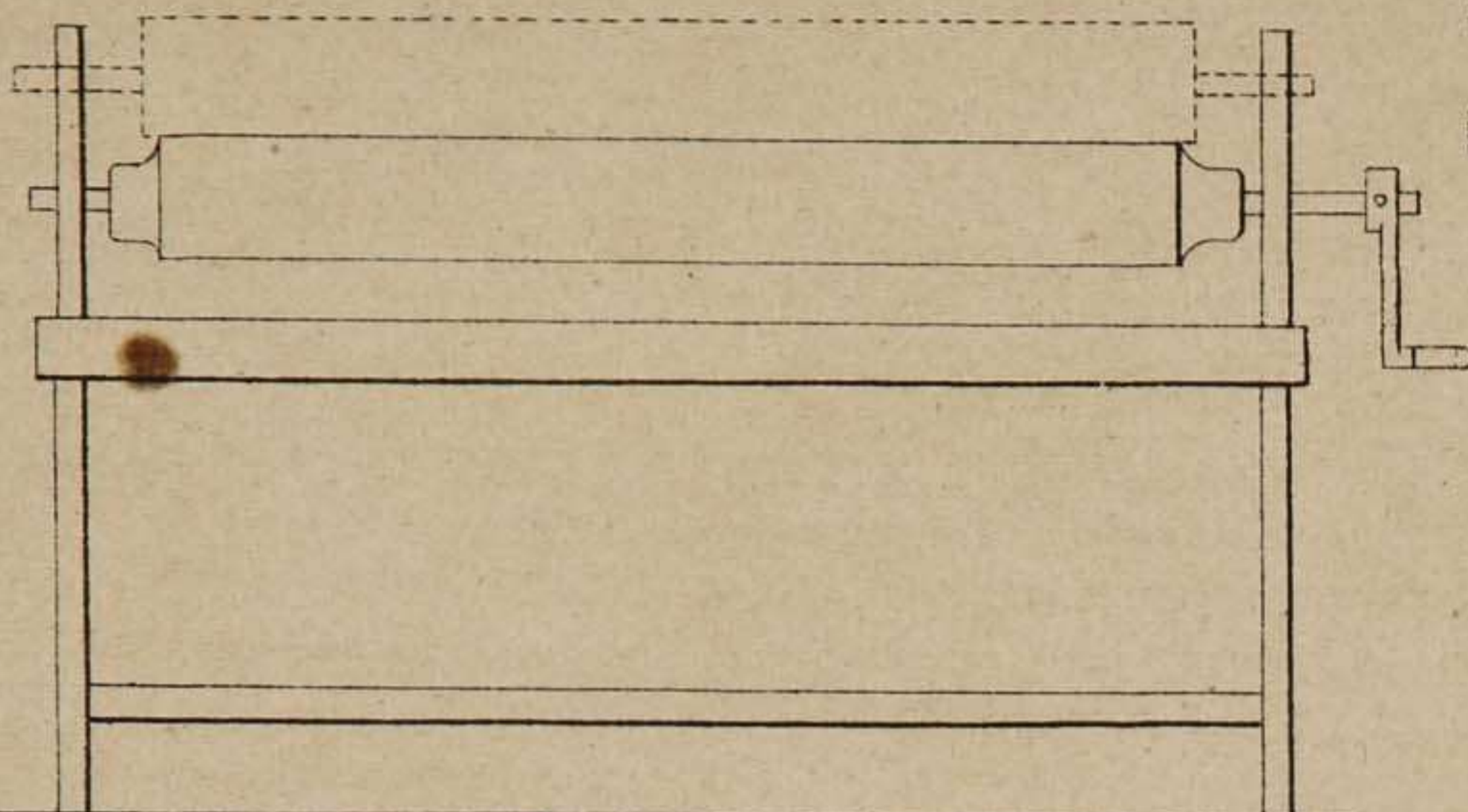
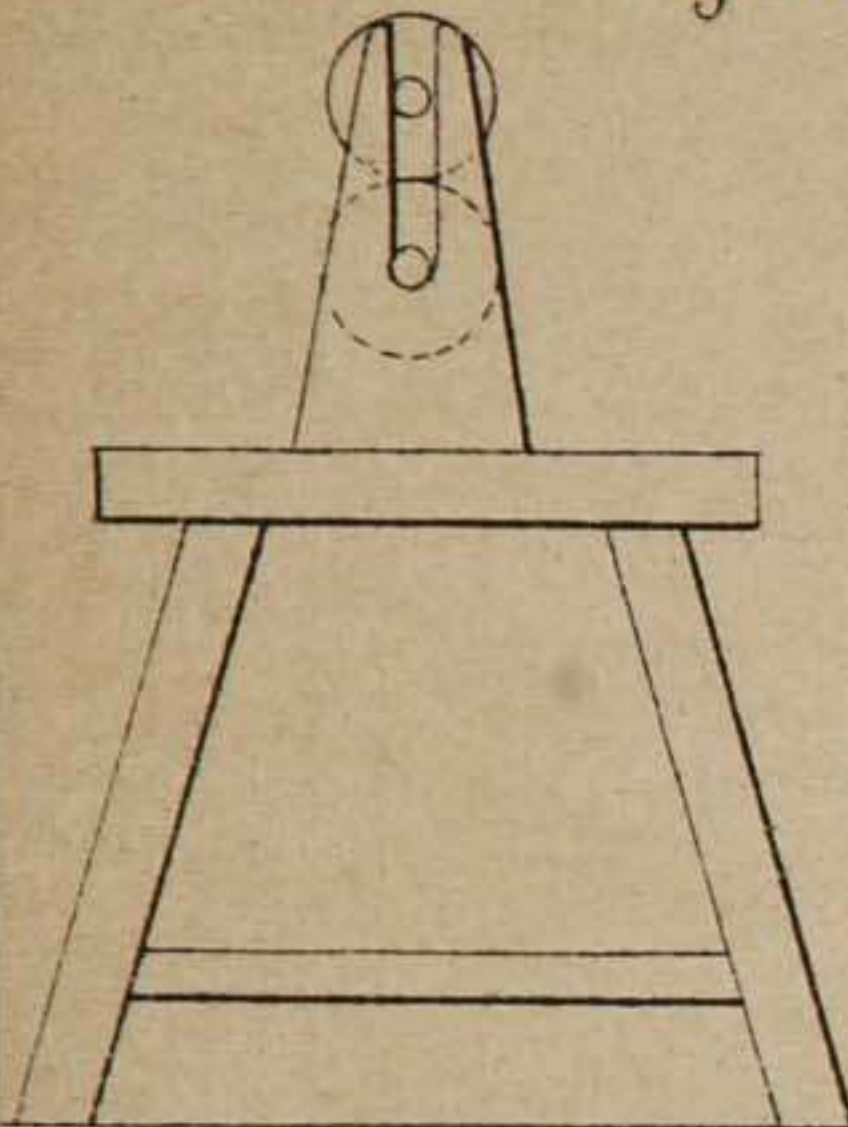


Fig. 1128.

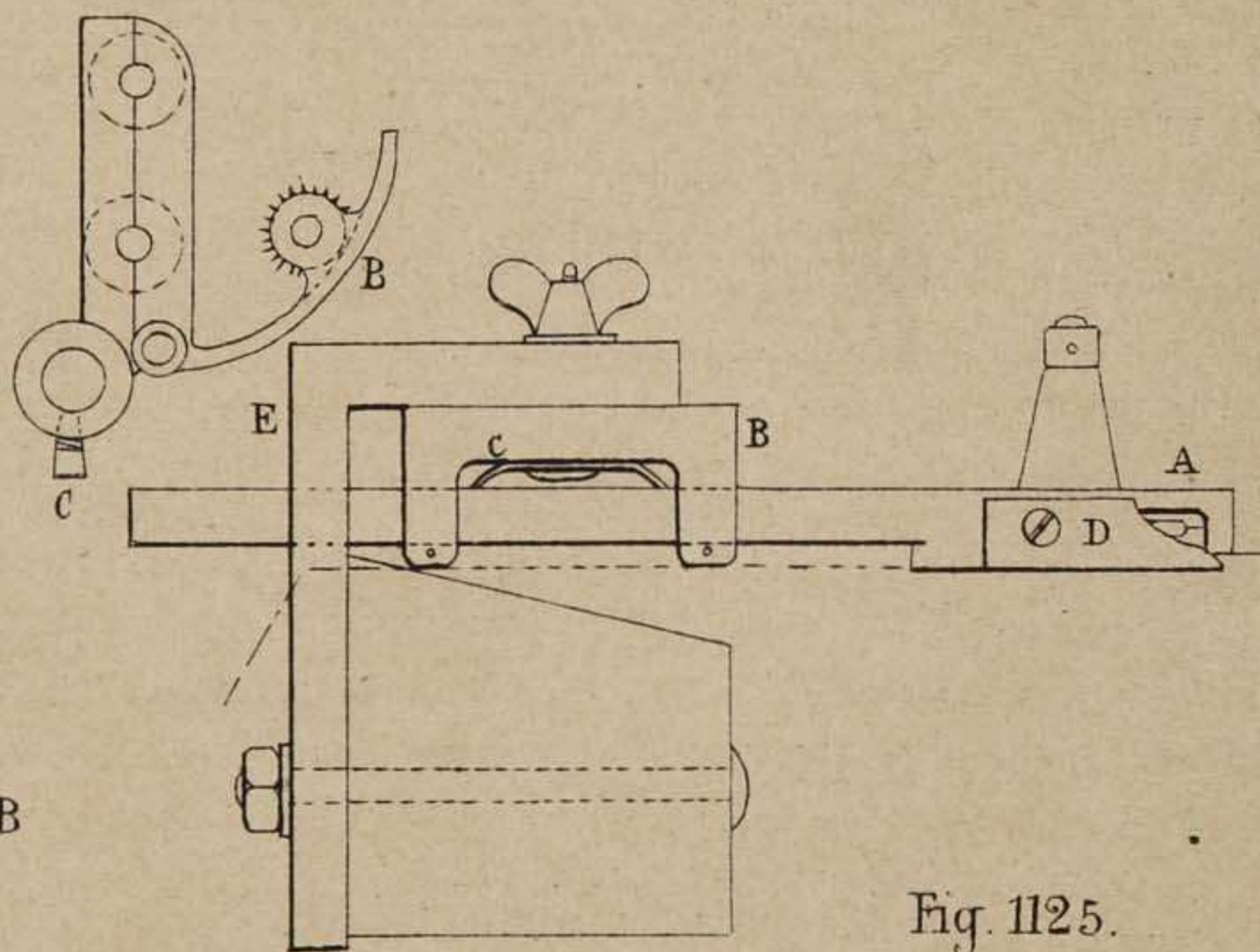
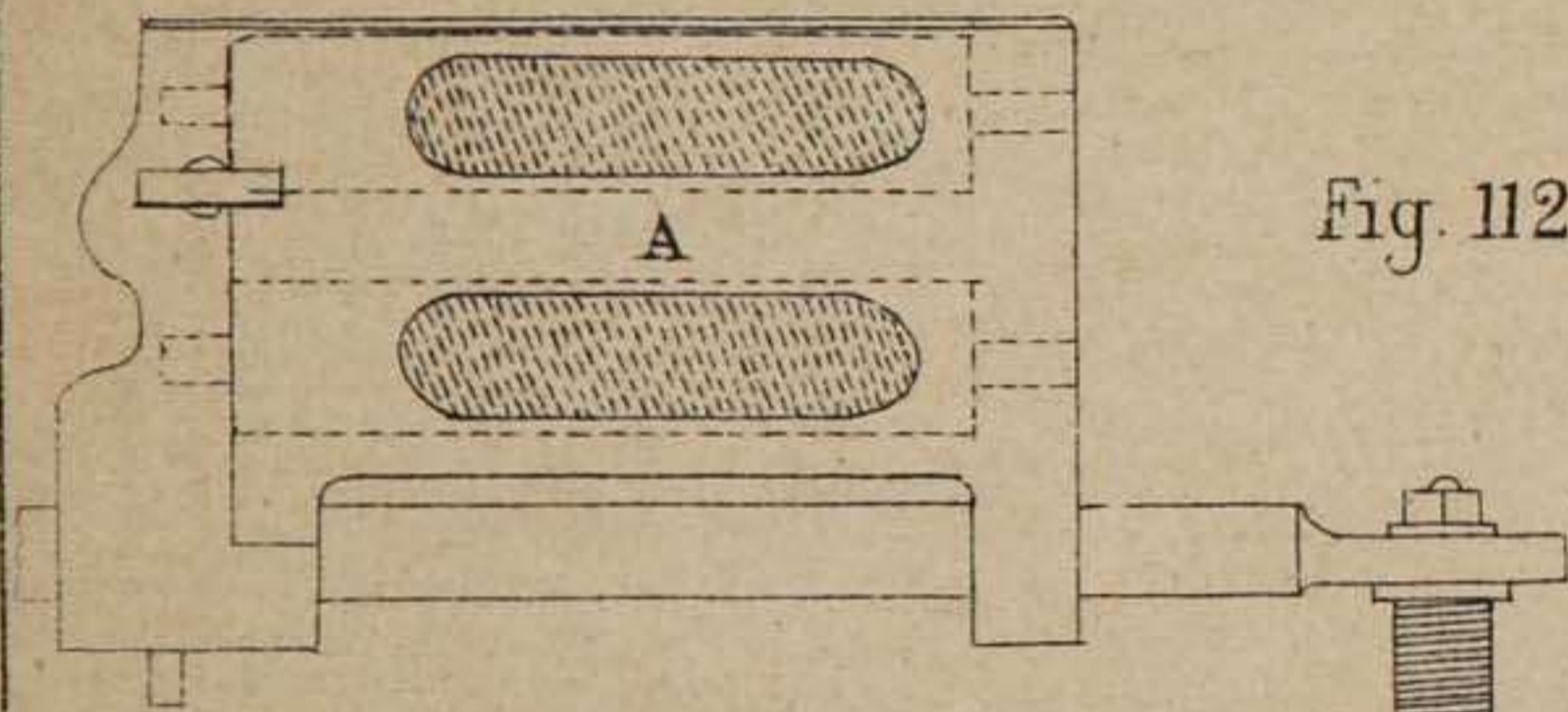


Fig. 1125.

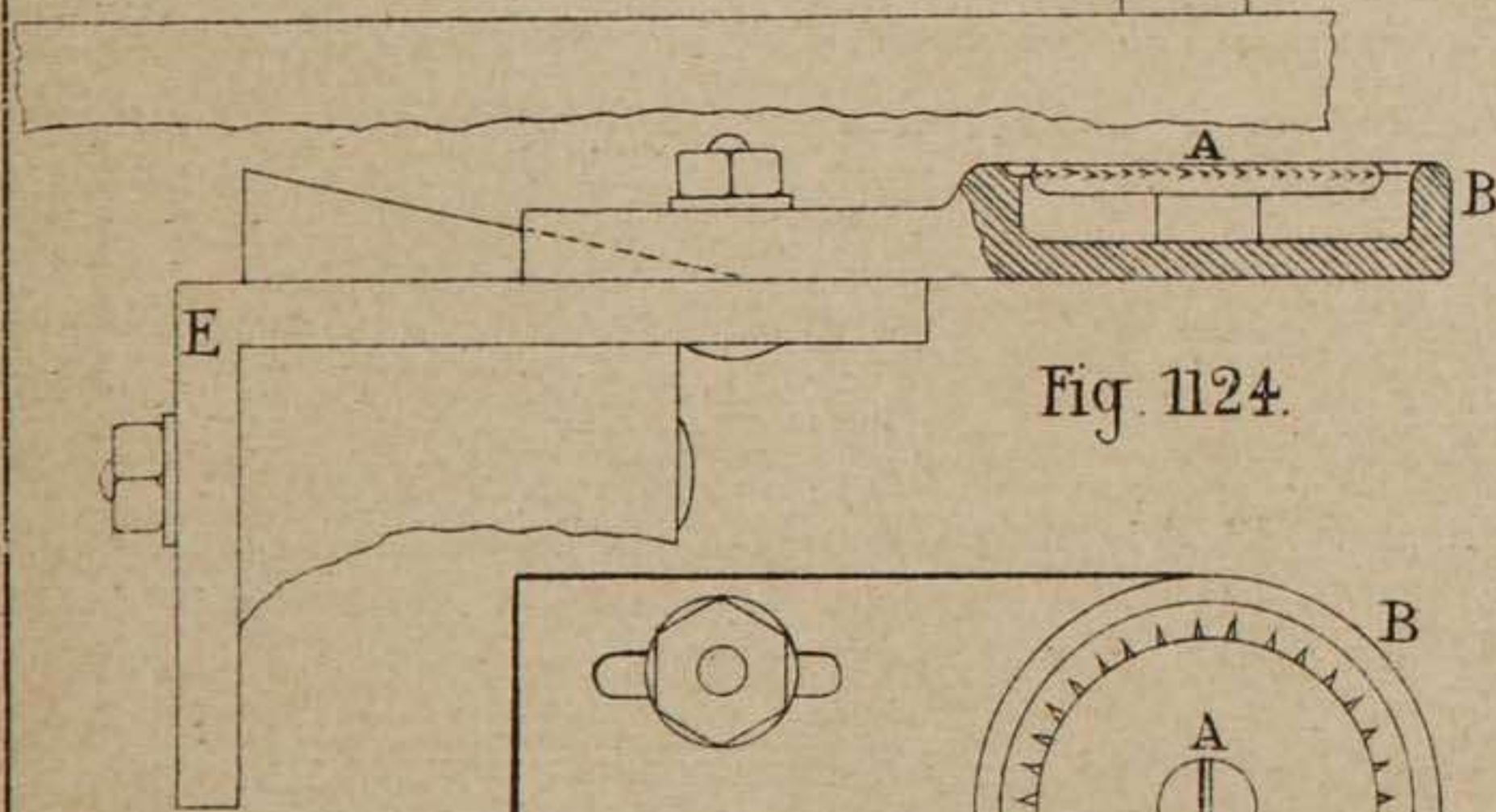


Fig. 1124.

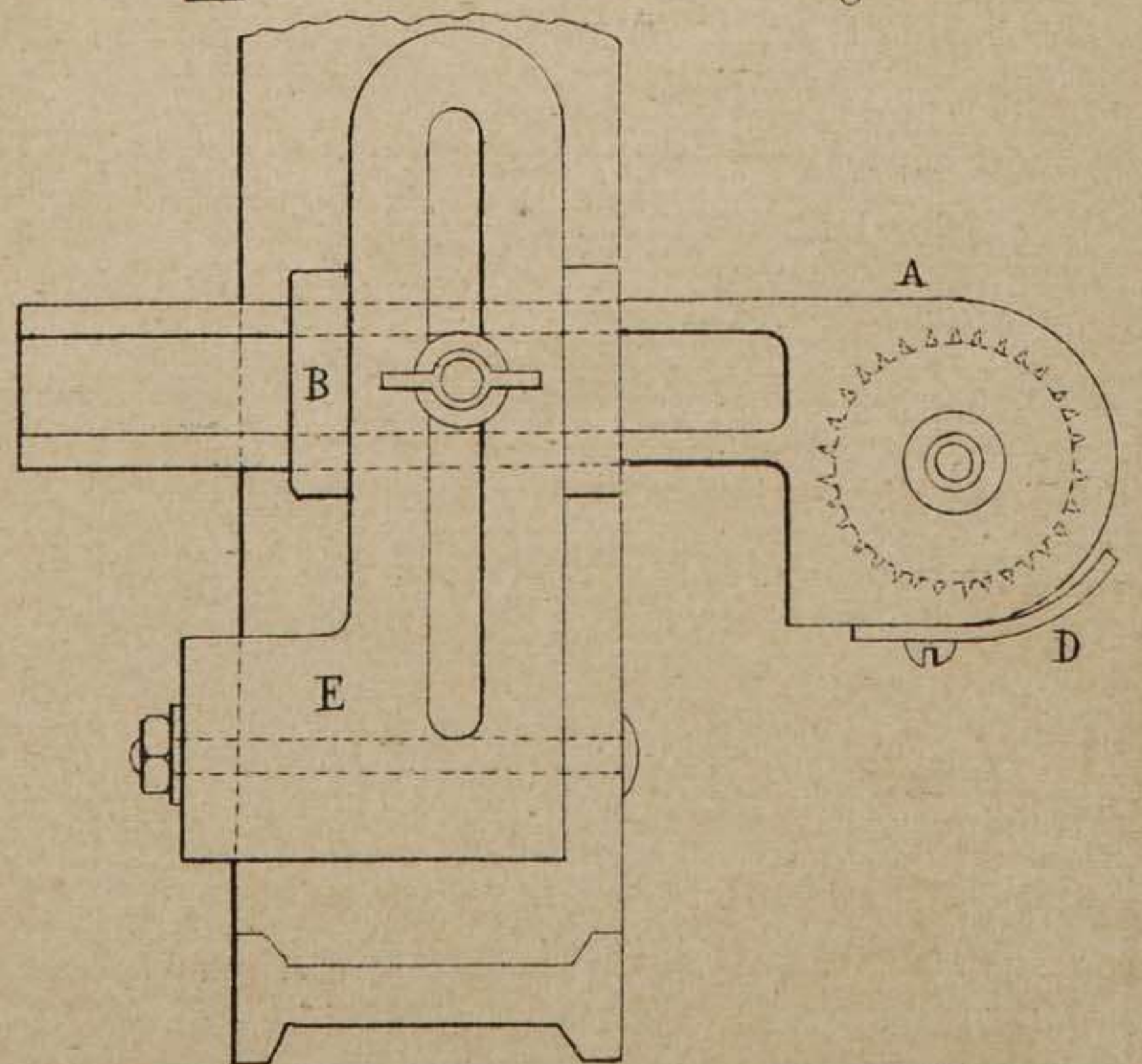
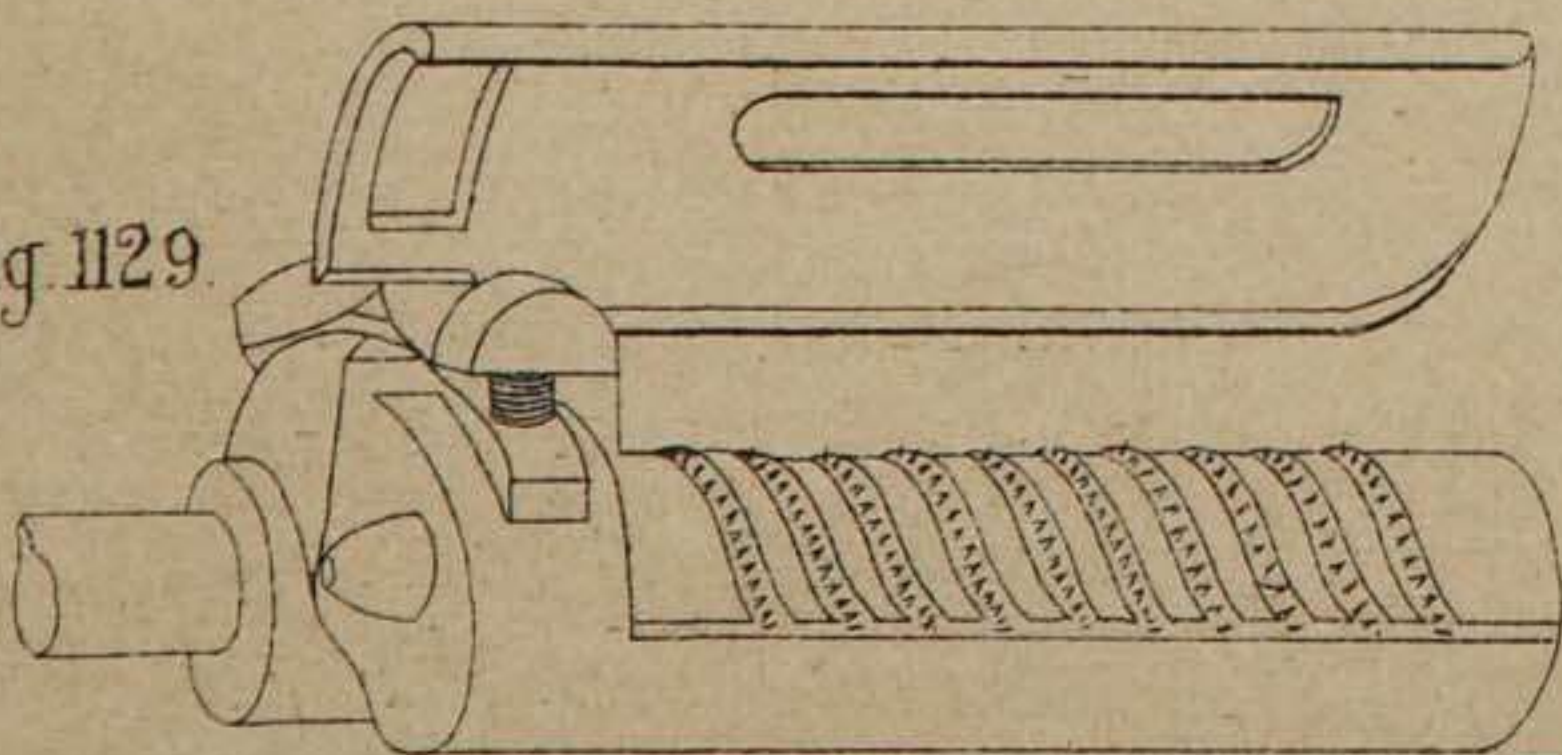


Fig. 1129.



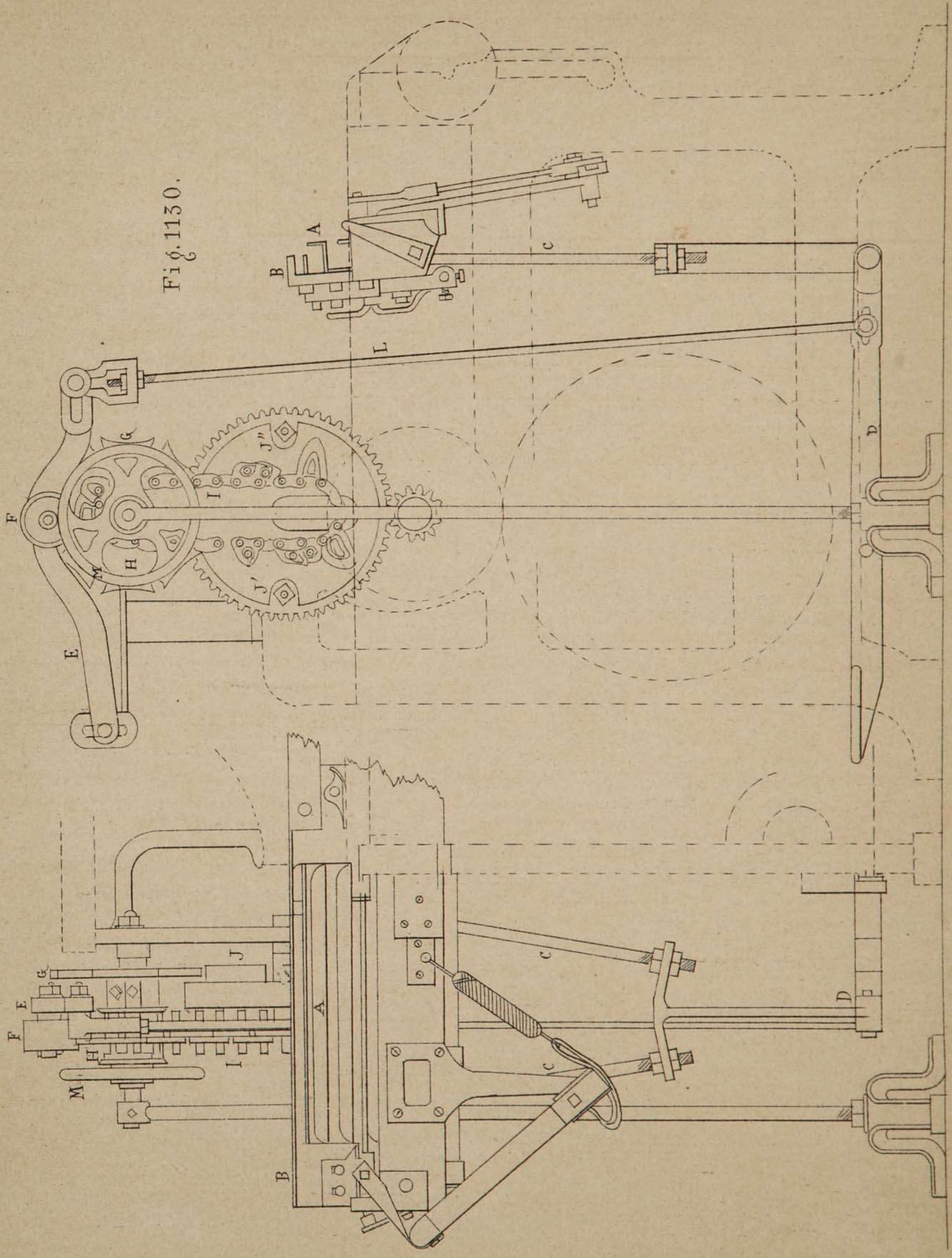


Fig. 1130.

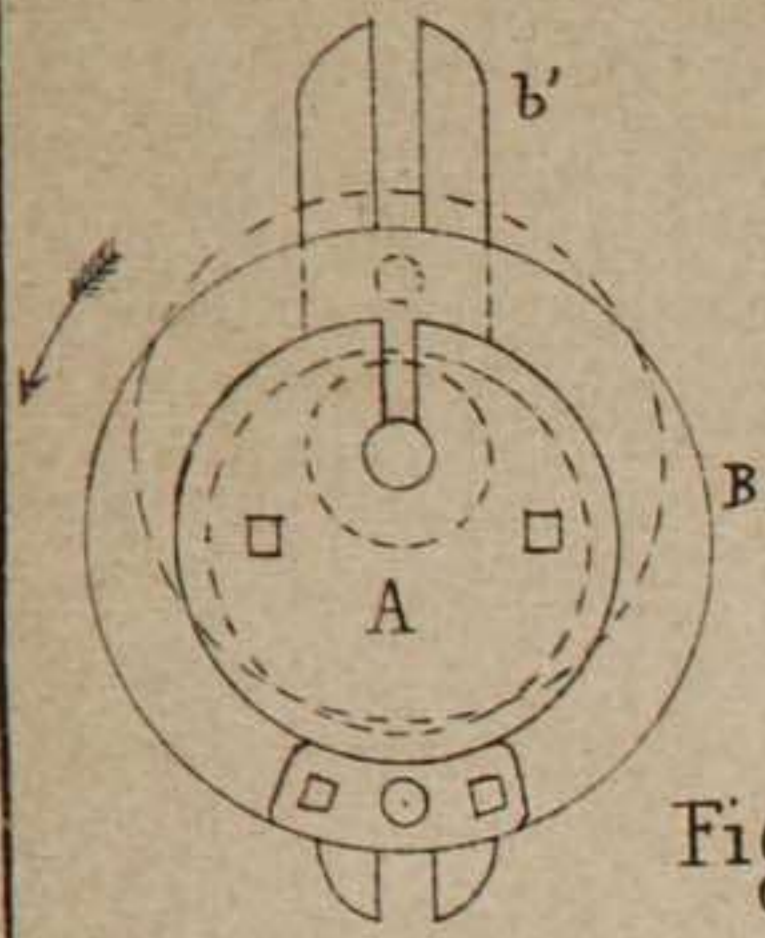


Fig. 1133.

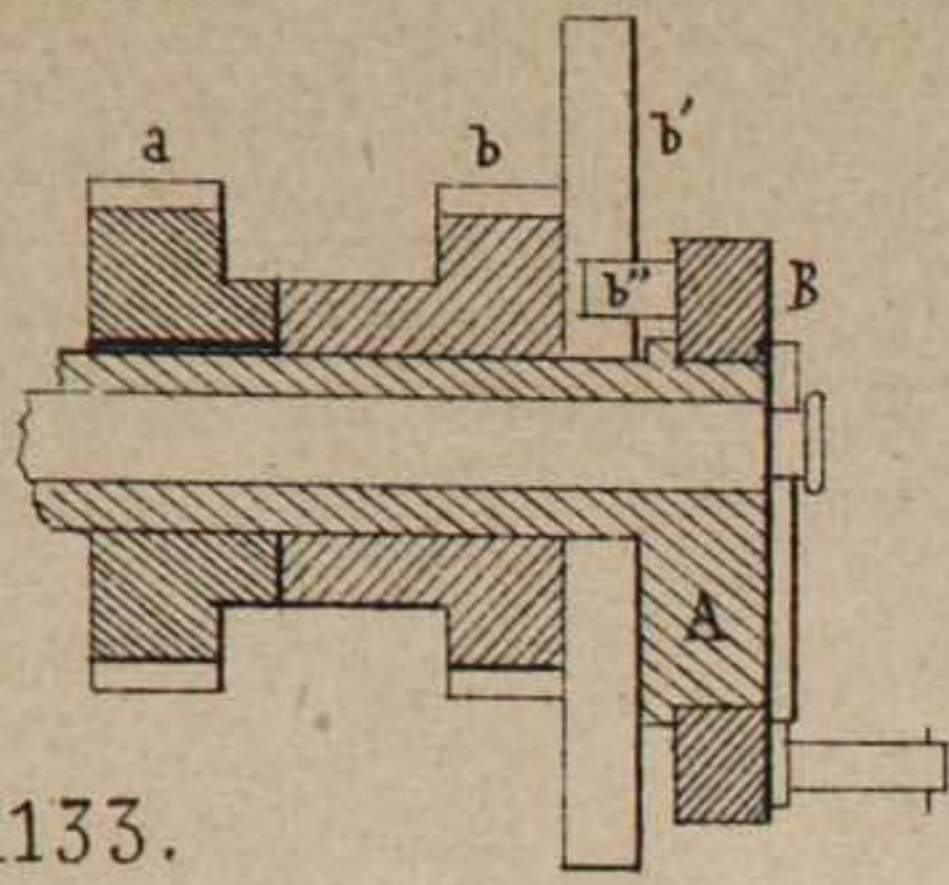


Fig. 1132.

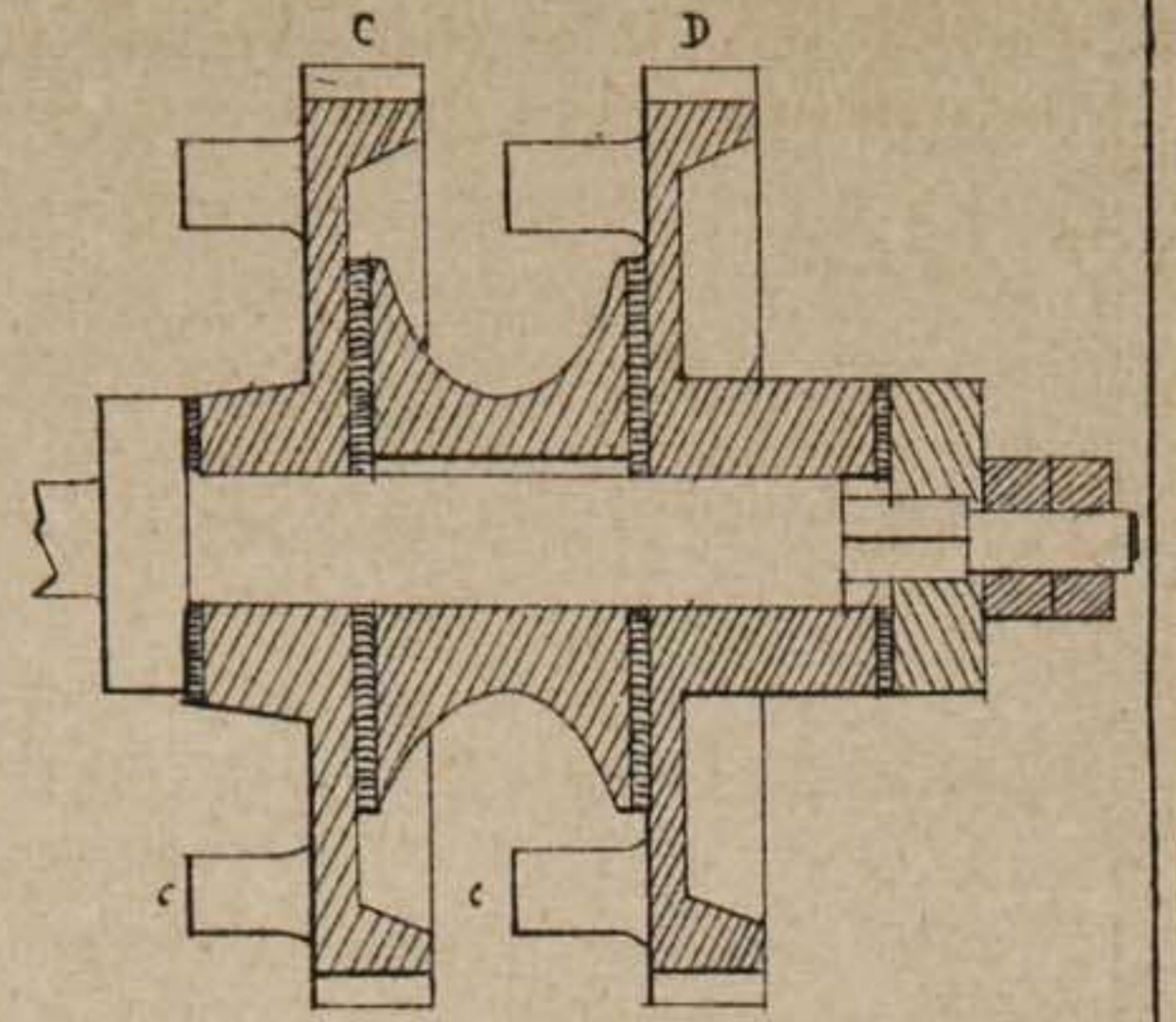


Fig. 1135.

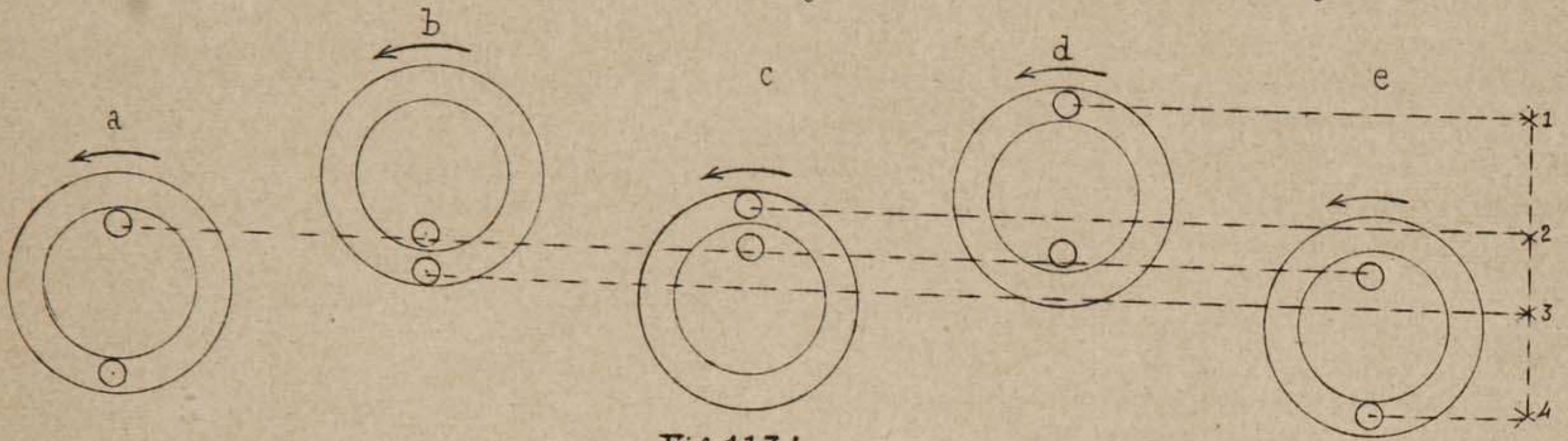


Fig. 1134.

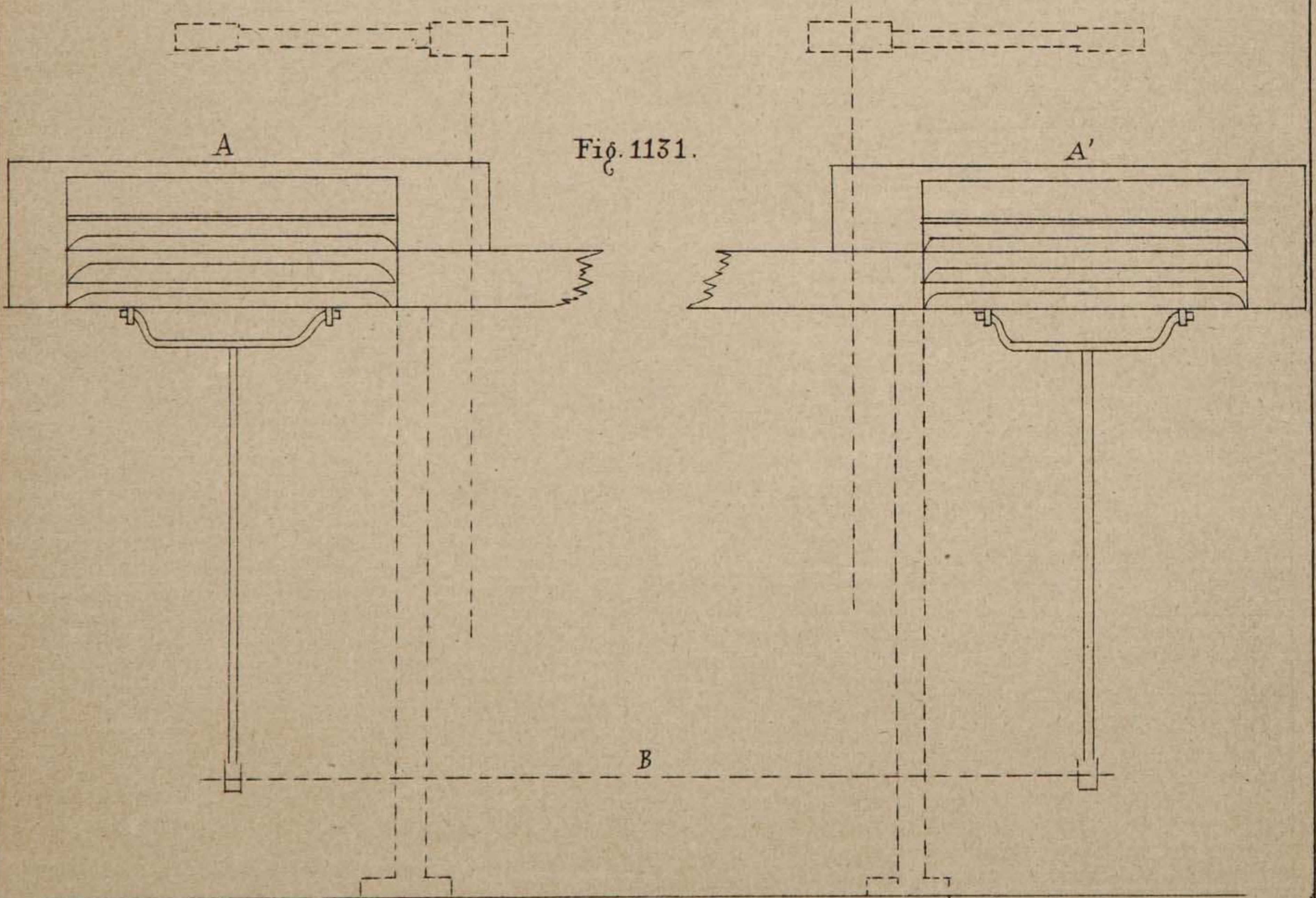


Fig. 1131.

