

1874



S  
6012

1-1

BIBLIOT. UNIV.  
EST.  
TABLA  
Nº 8  
ARTES Y OFICIOS

~~443-1-20~~



TRAITÉ  
THÉORIQUE ET PRATIQUE  
DE  
**L'ART DE BATIR.**

---

SUPPLÉMENT.

LIBRARY  
UNIVERSITY OF TORONTO  
130 St. George Street  
Toronto, Ontario  
M5S 1A5



G.2 S. 6012

TRAITÉ  
THÉORIQUE ET PRATIQUE  
DE  
L'ART DE BATIR

DE JEAN RONDELET,

ARCHITECTE, MEMBRE DE L'INSTITUT.

SUPPLÉMENT

PAR G. ABEL BLOUET,

ARCHITECTE DU GOUVERNEMENT,

ANCIEN PENSIONNAIRE DE L'ACADÉMIE DE FRANCE A ROME, MEMBRE DU CONSEIL GÉNÉRAL

DES BATIMENTS CIVILS, INSPECTEUR GÉNÉRAL DES BATIMENTS DES PRISONS,

PROFESSEUR DE THÉORIE D'ARCHITECTURE A L'ÉCOLE

IMPÉRIALE DES BEAUX-ARTS.

PLANCHES.

A PARIS,

CHEZ FIRMIN DIDOT FRÈRES, LIBRAIRES,

IMPRIMEURS DE L'INSTITUT DE FRANCE,

RUE JACOB, 56.

M DCCC LV.



R. J. 648.



Fig. 1. (3.)

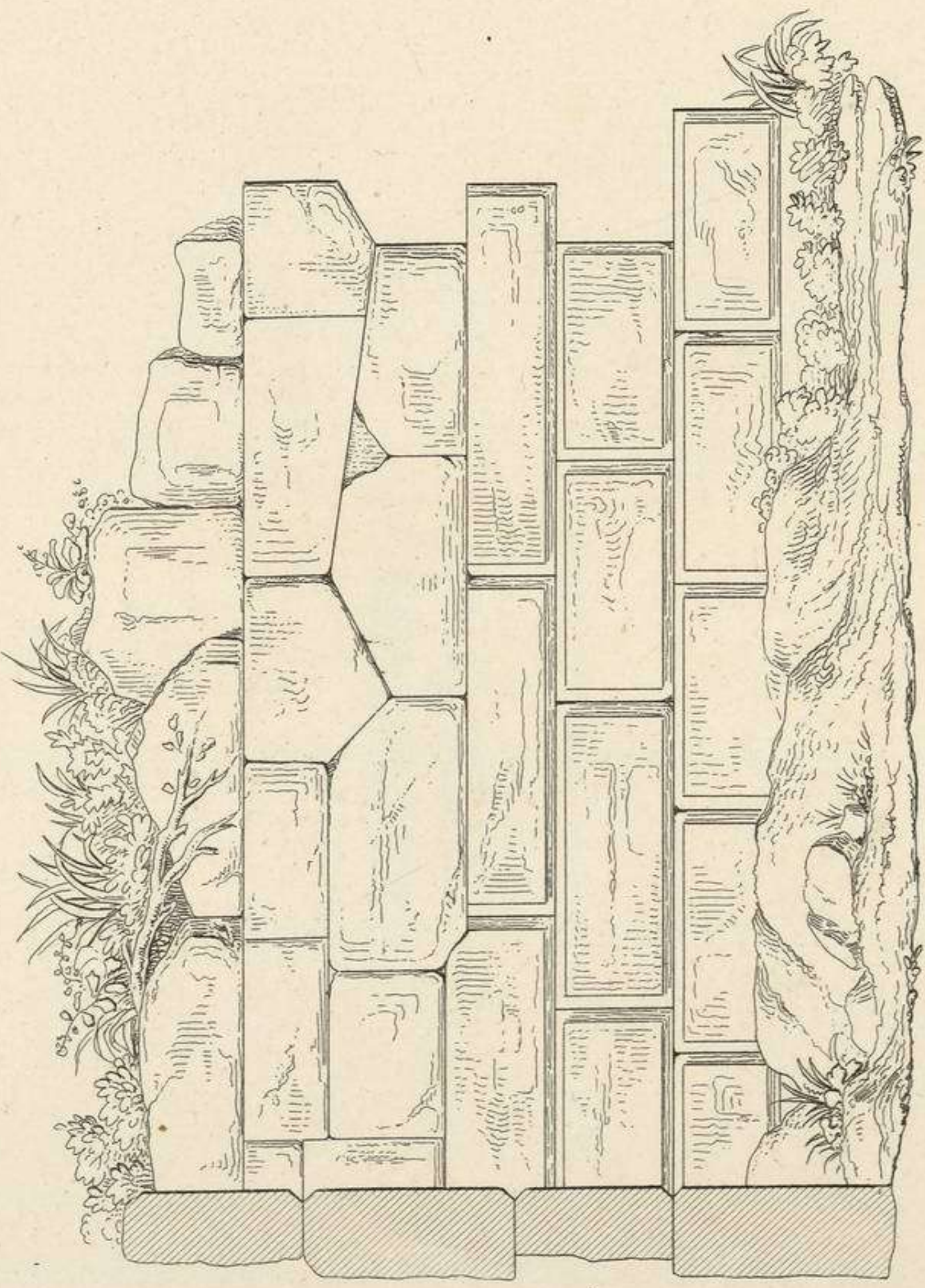

Fig. 4. (3.)



Fig. 5. (4.)

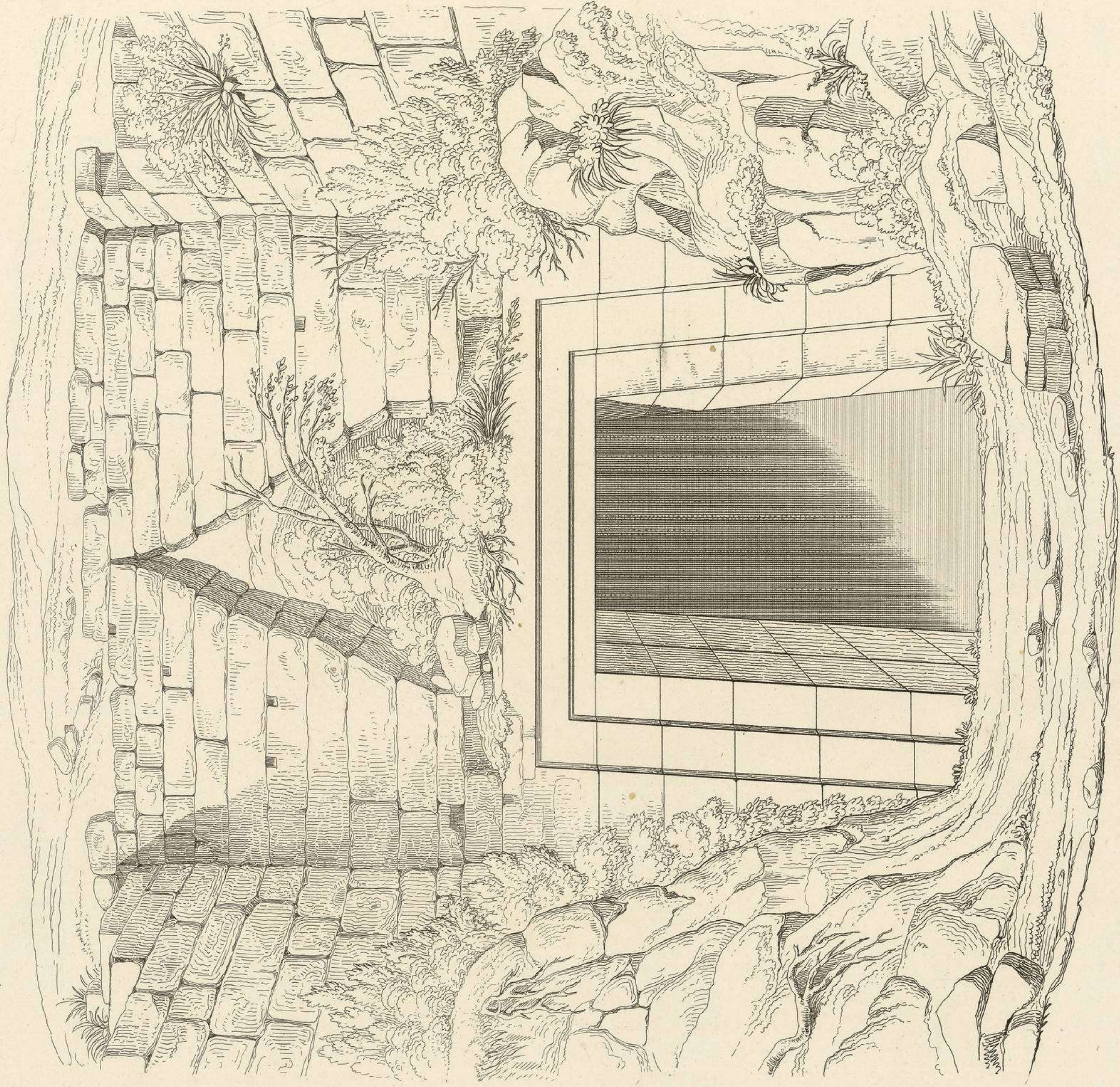

Fig. 2. (3.)

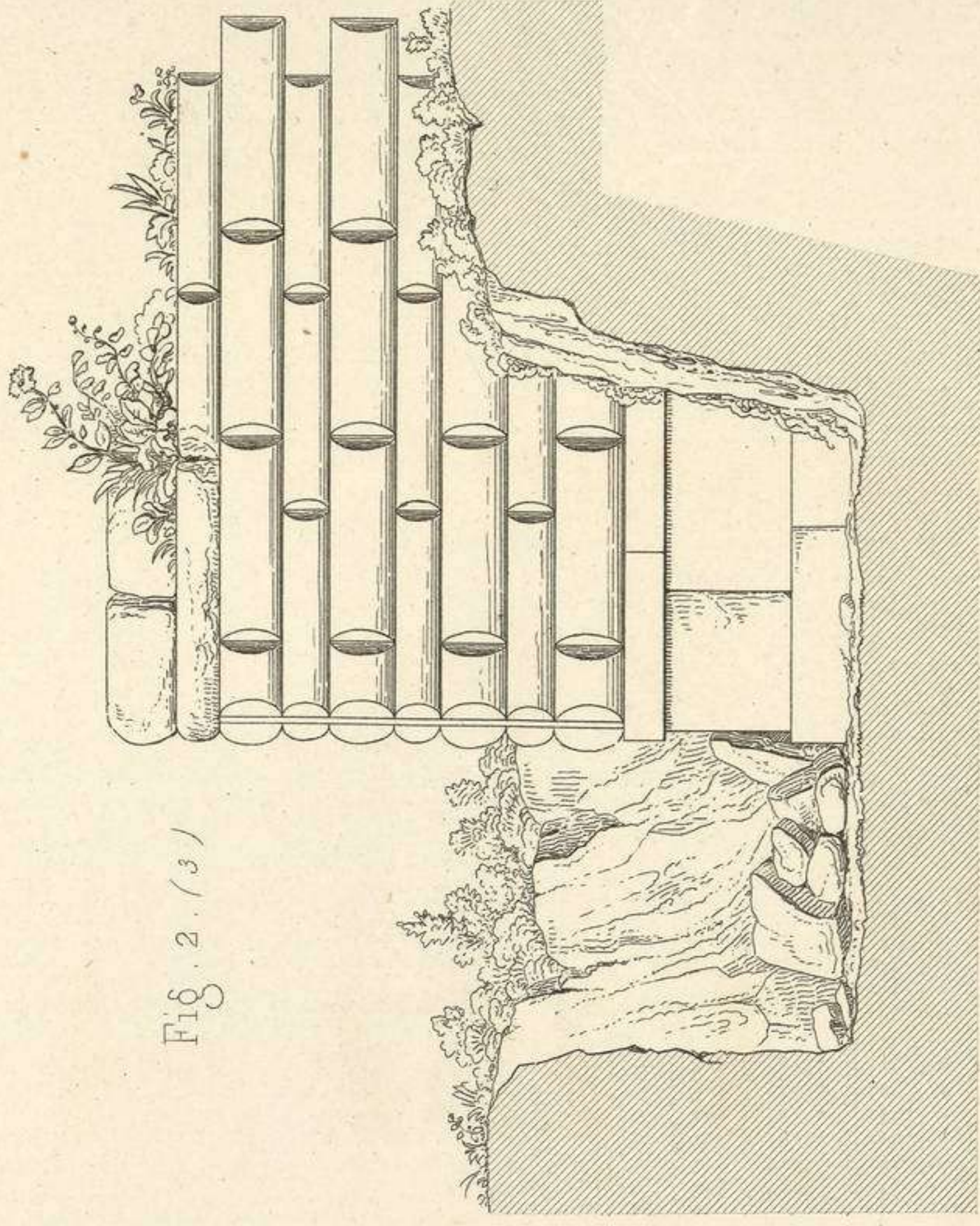

Fig. 3. (3.)

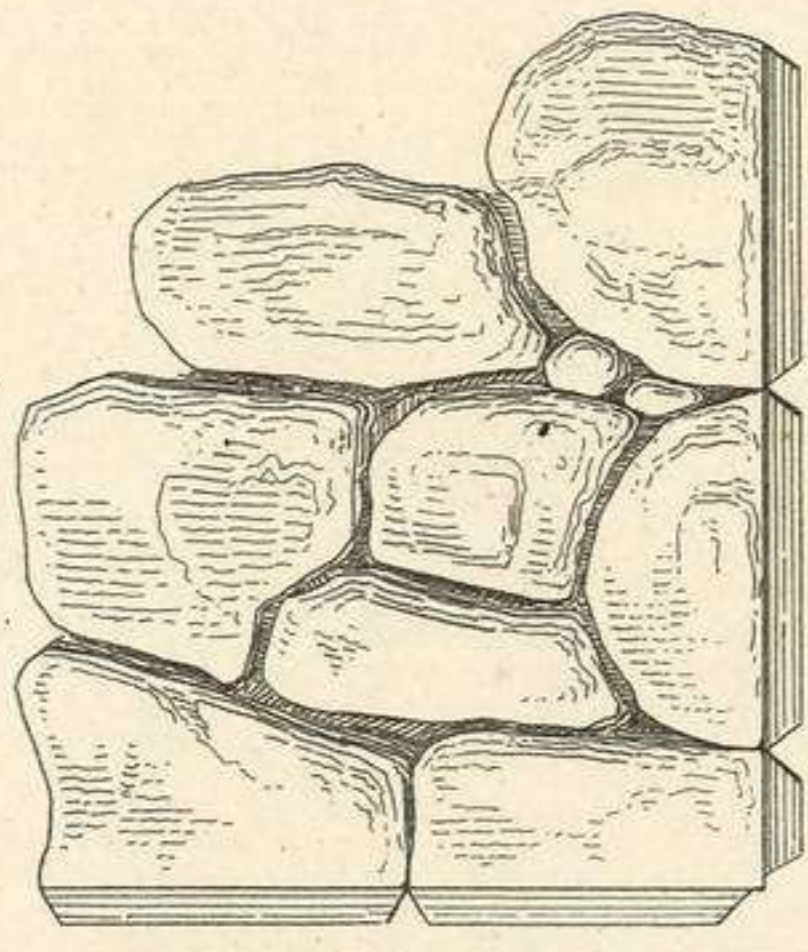
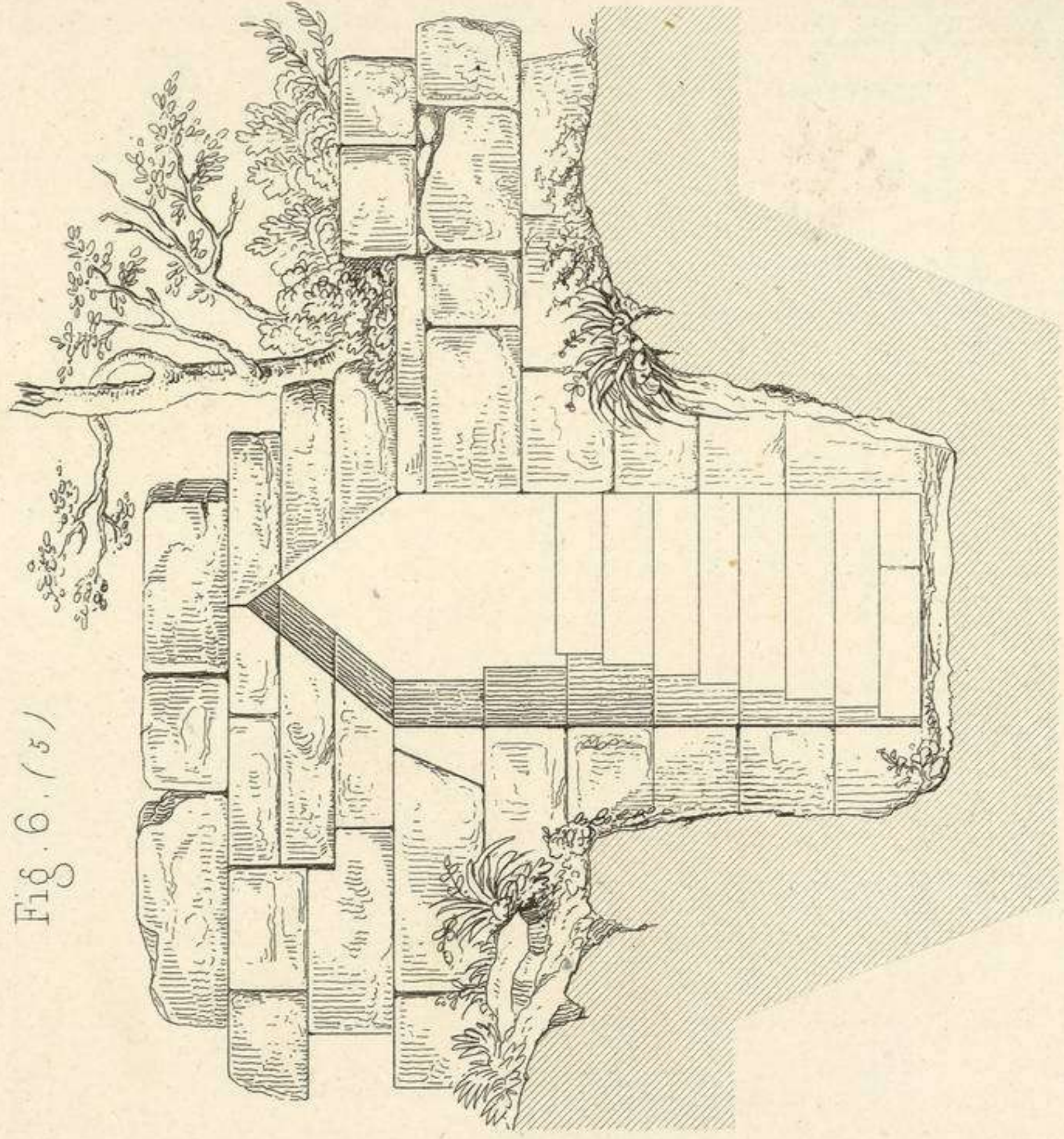

Fig. 6. (5.)



Blanché et Vernet del.

H. Roux sculp.

CONSTRUCTION EN PIERRES DE TAILLE.  
Appareil des Constructions antiques.



Fig. 3. (6)

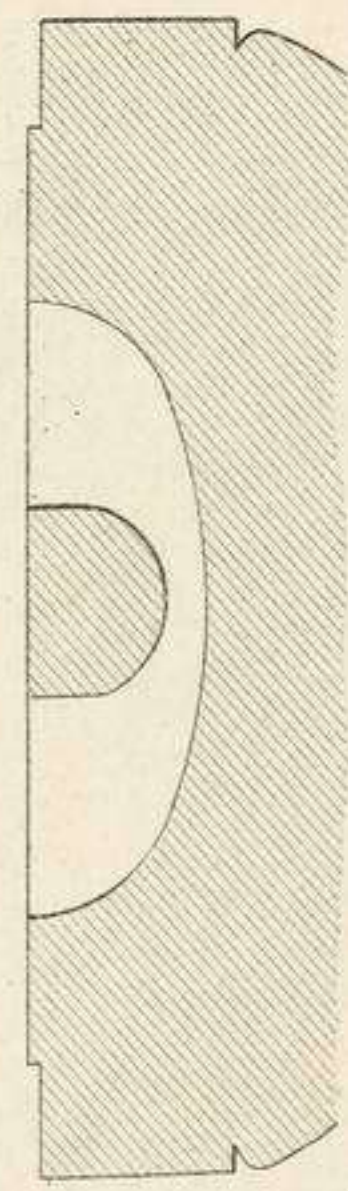

Fig. 1. (5)

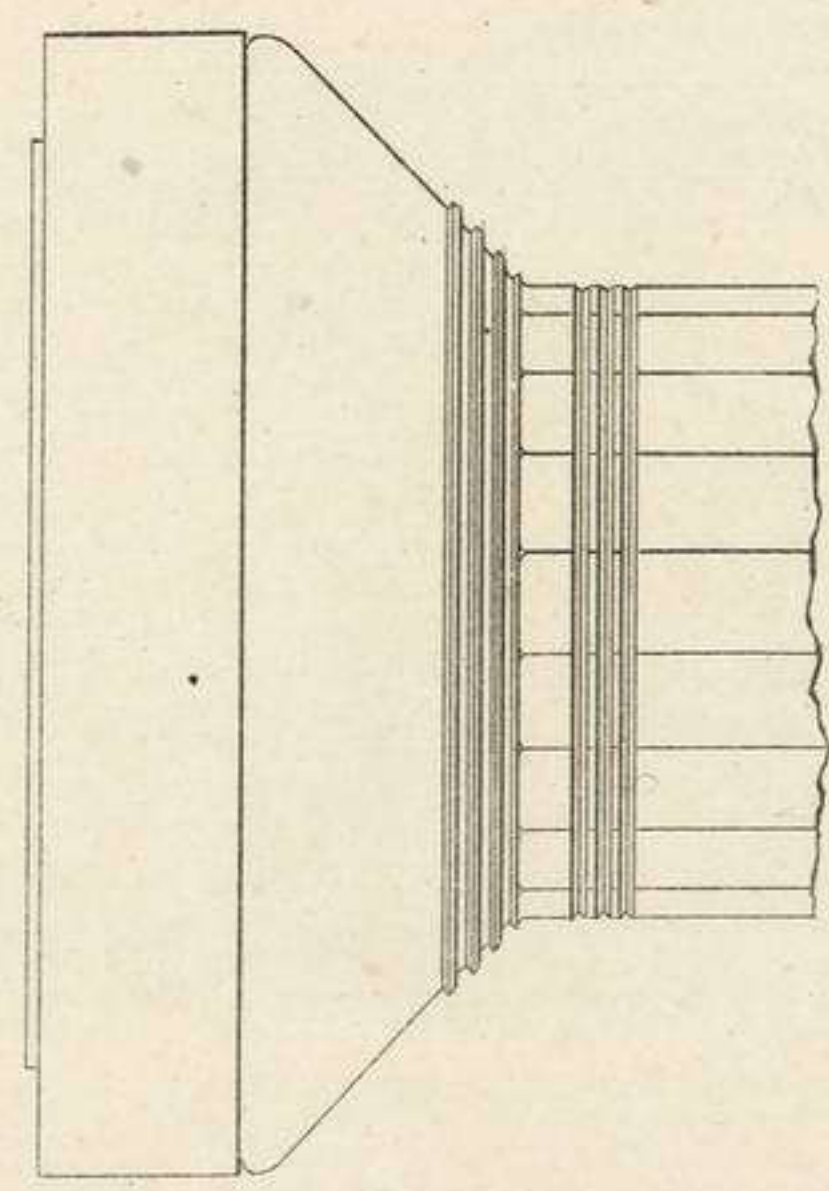

Fig. 2. (5)

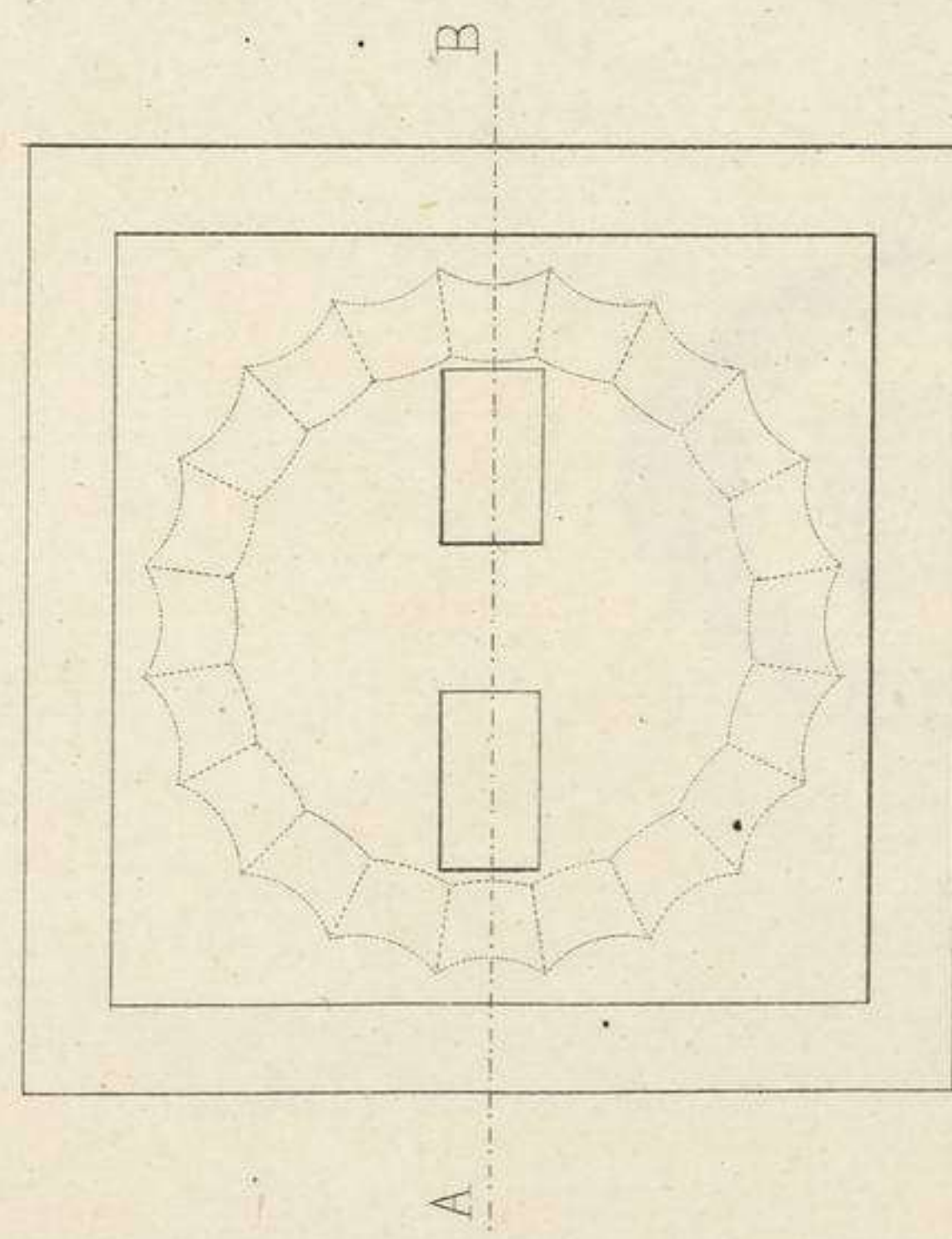

Fig. 4. (5)

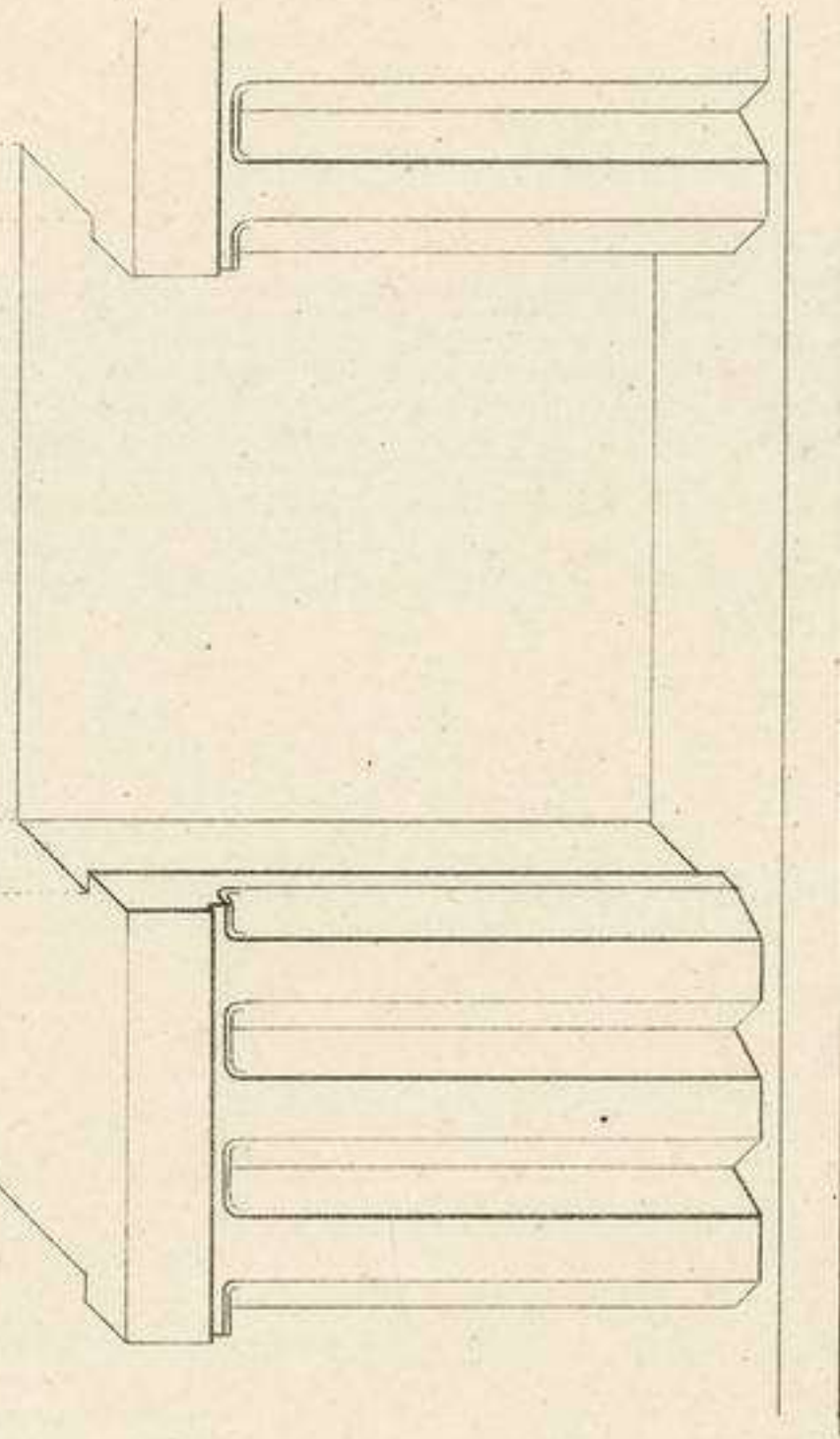

Fig. 6. (5)

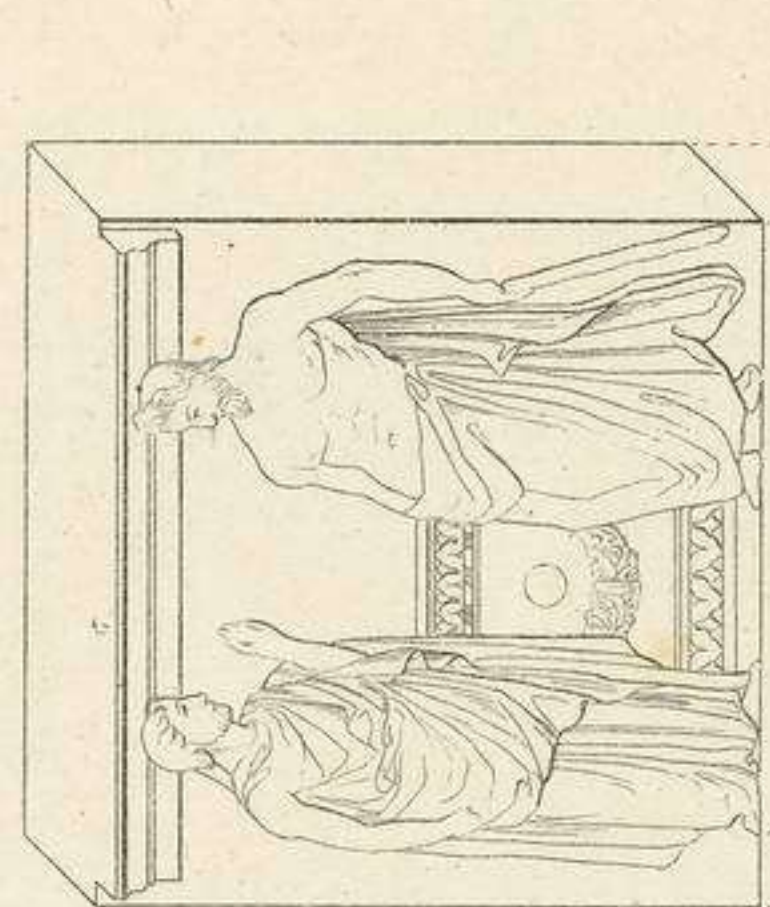

Fig. 7. (6)

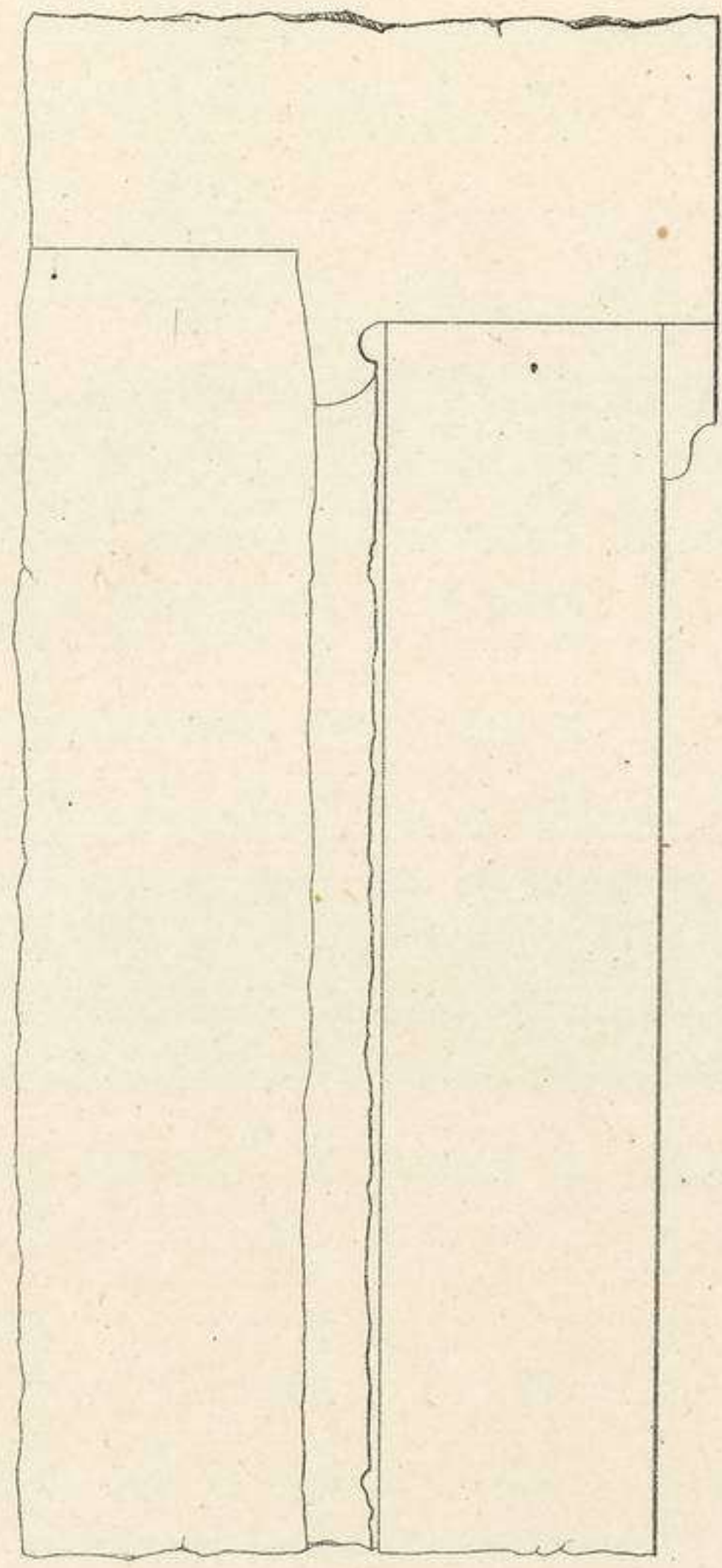

Fig. 8. (6)

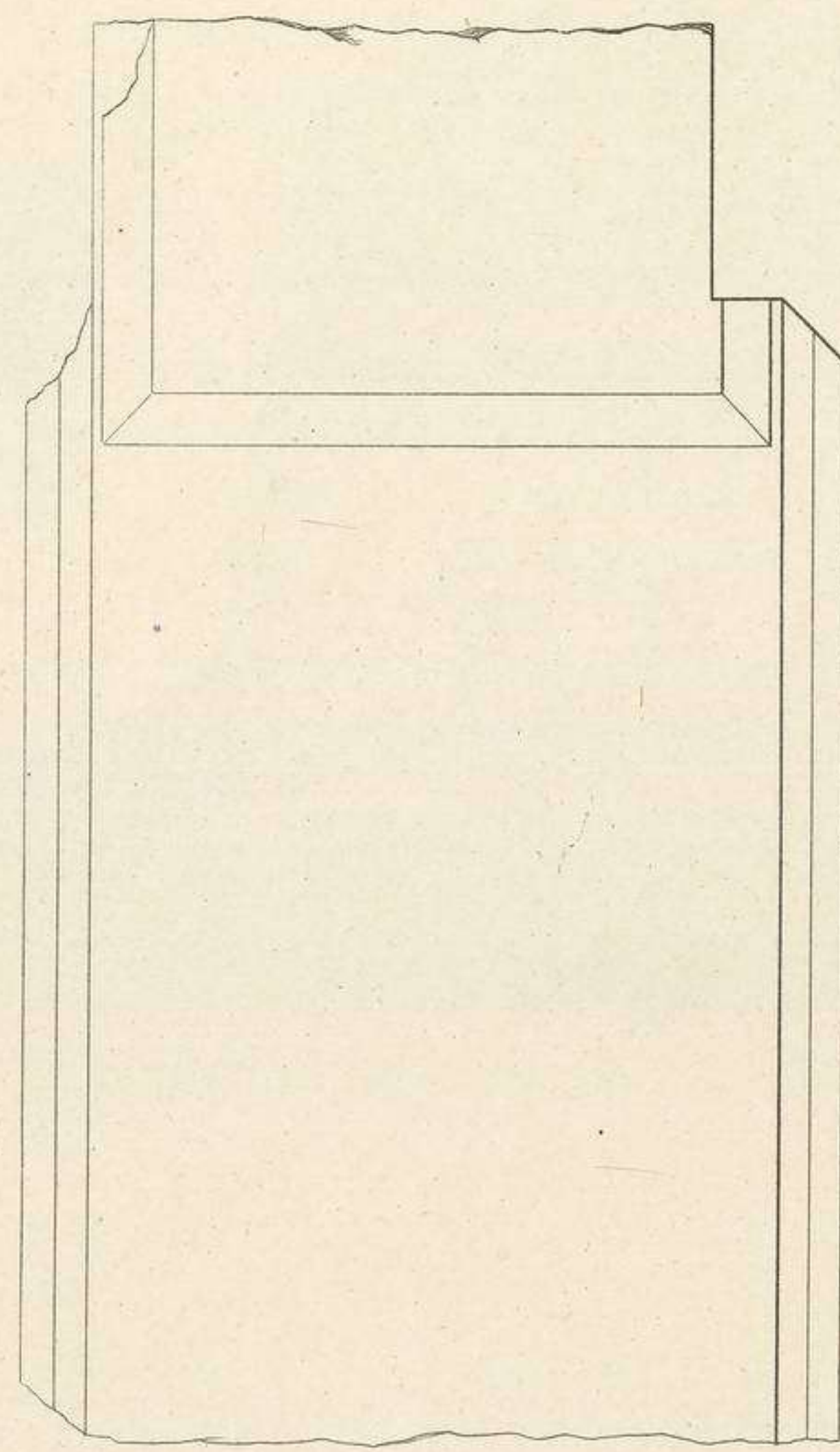

Fig. 10. (6)

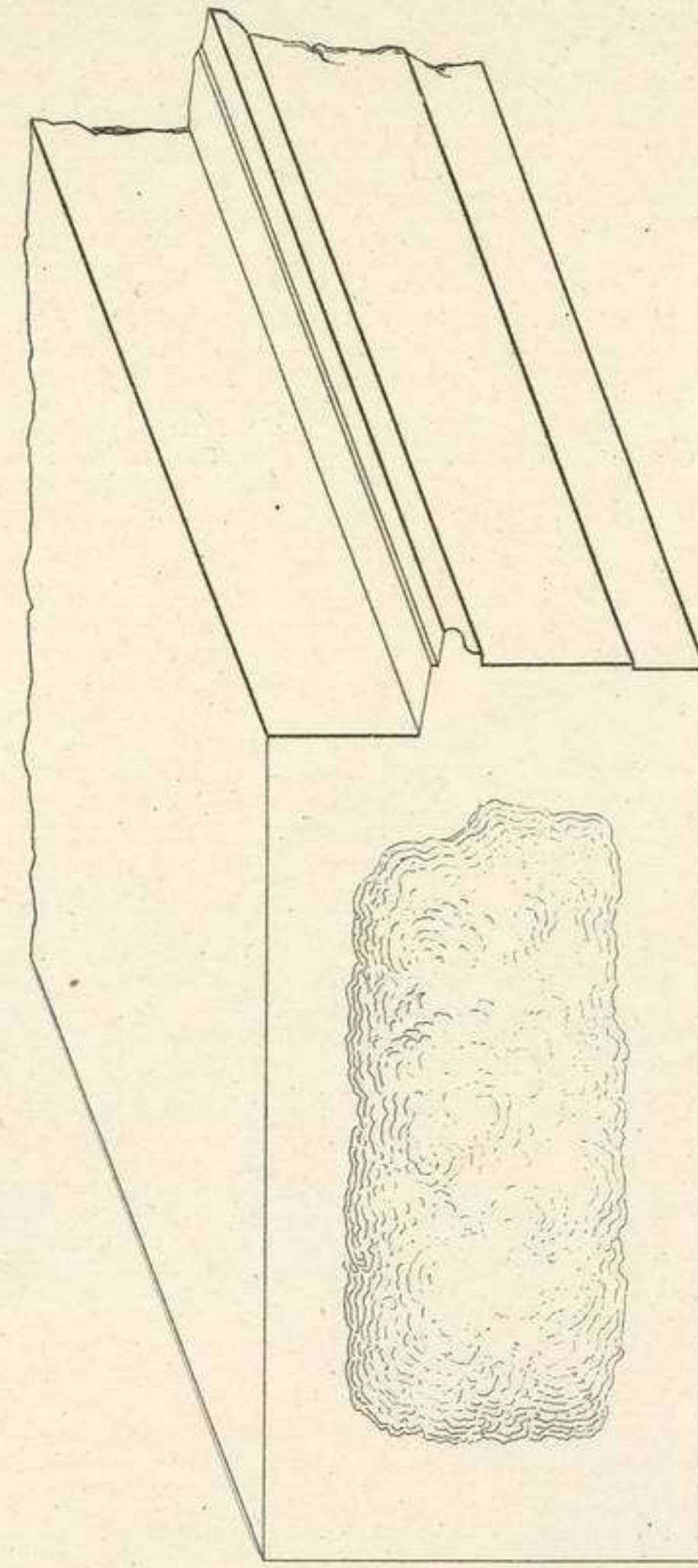

Fig. 12. (6)

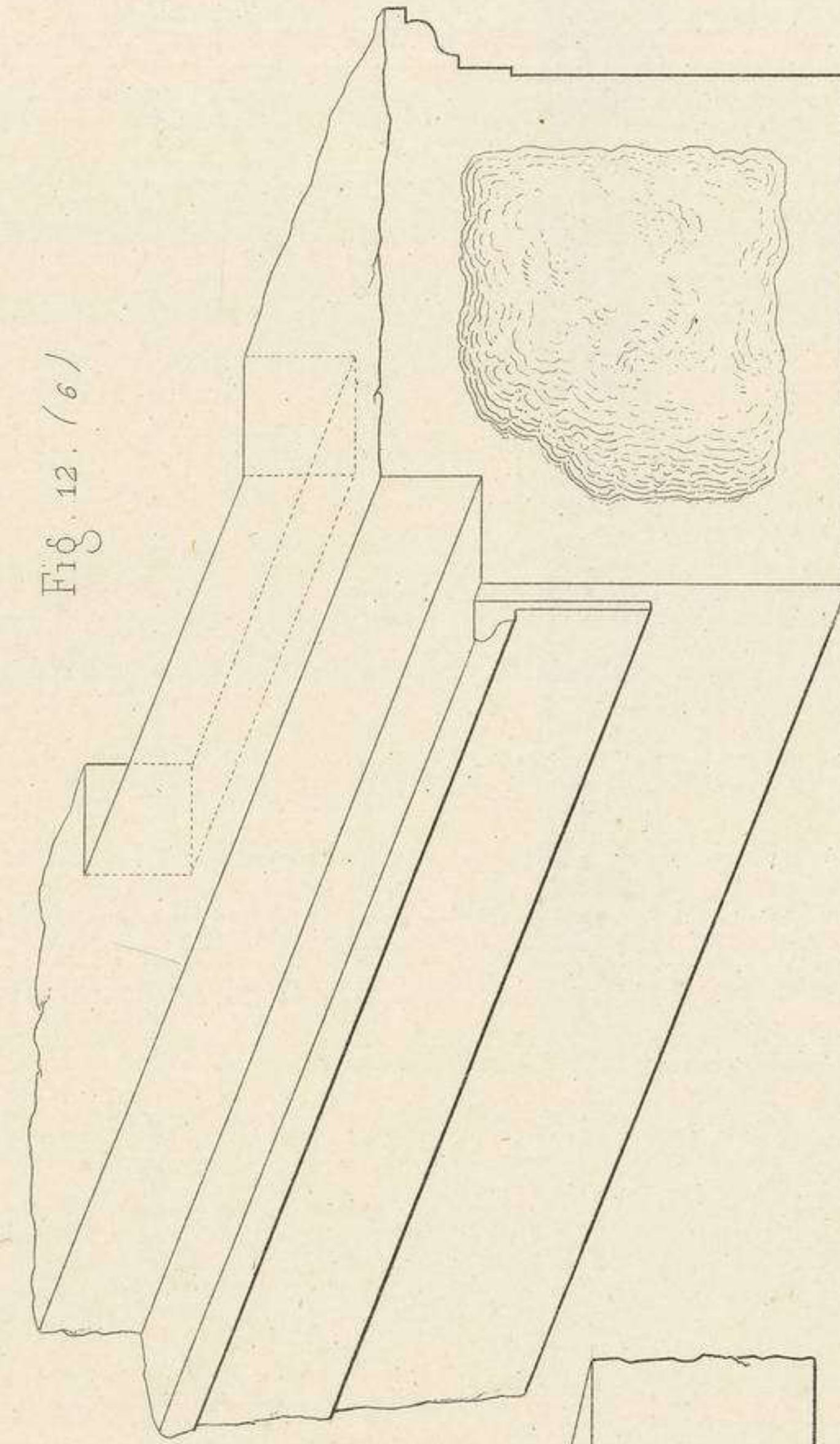

Fig. 11. (6)

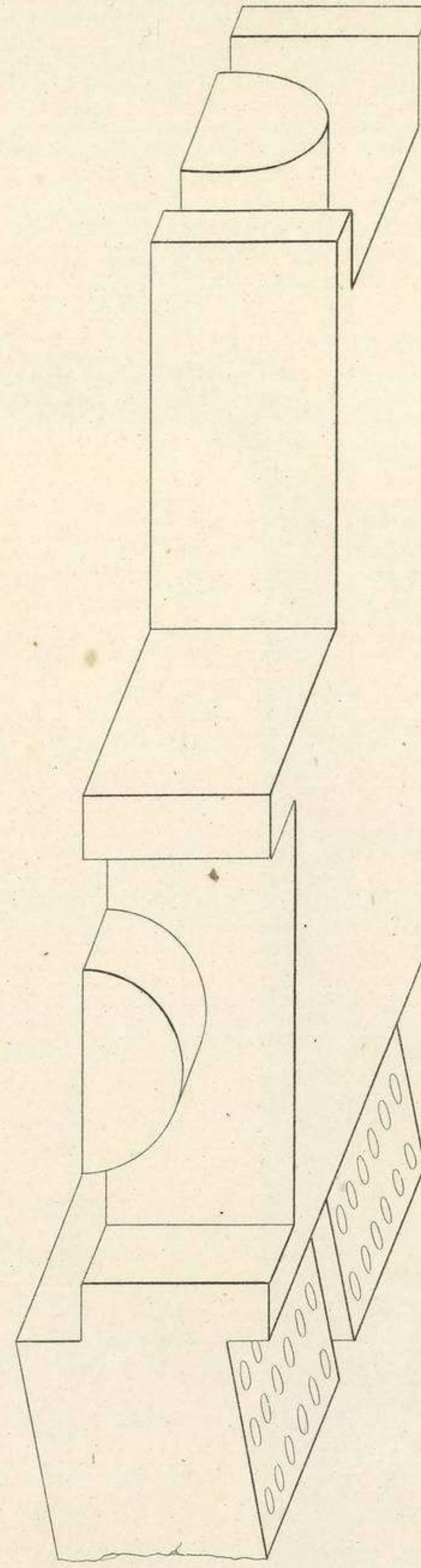
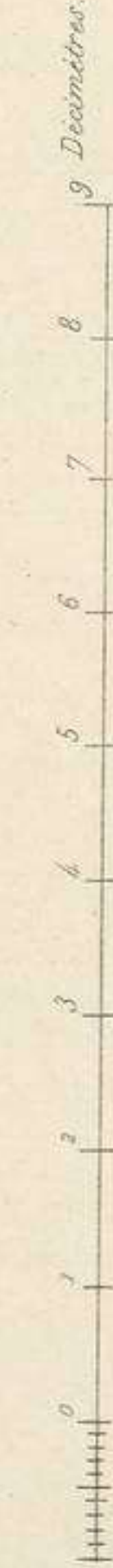
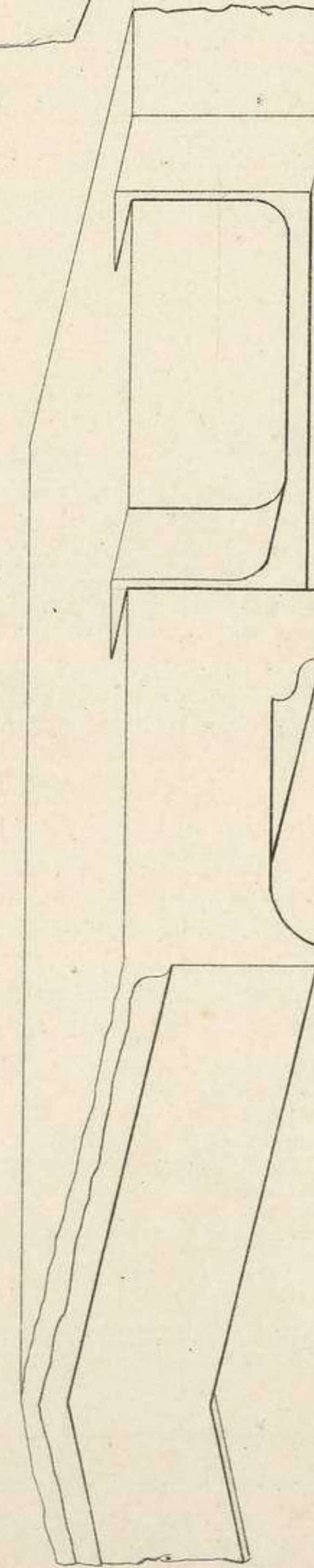
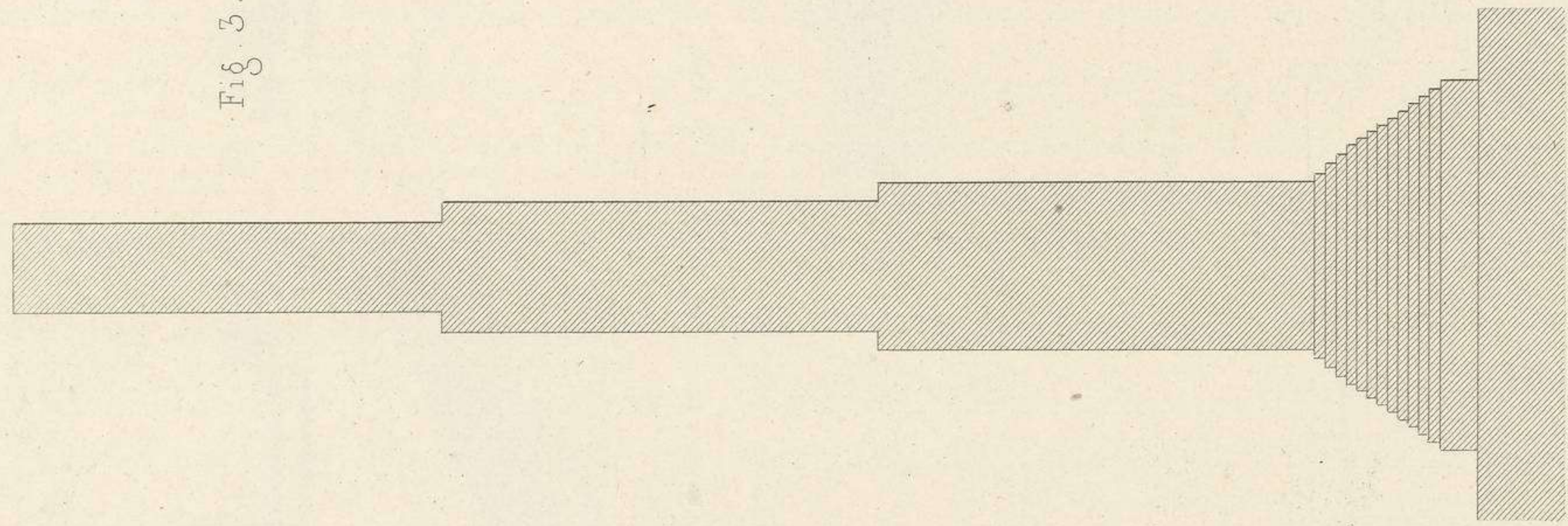
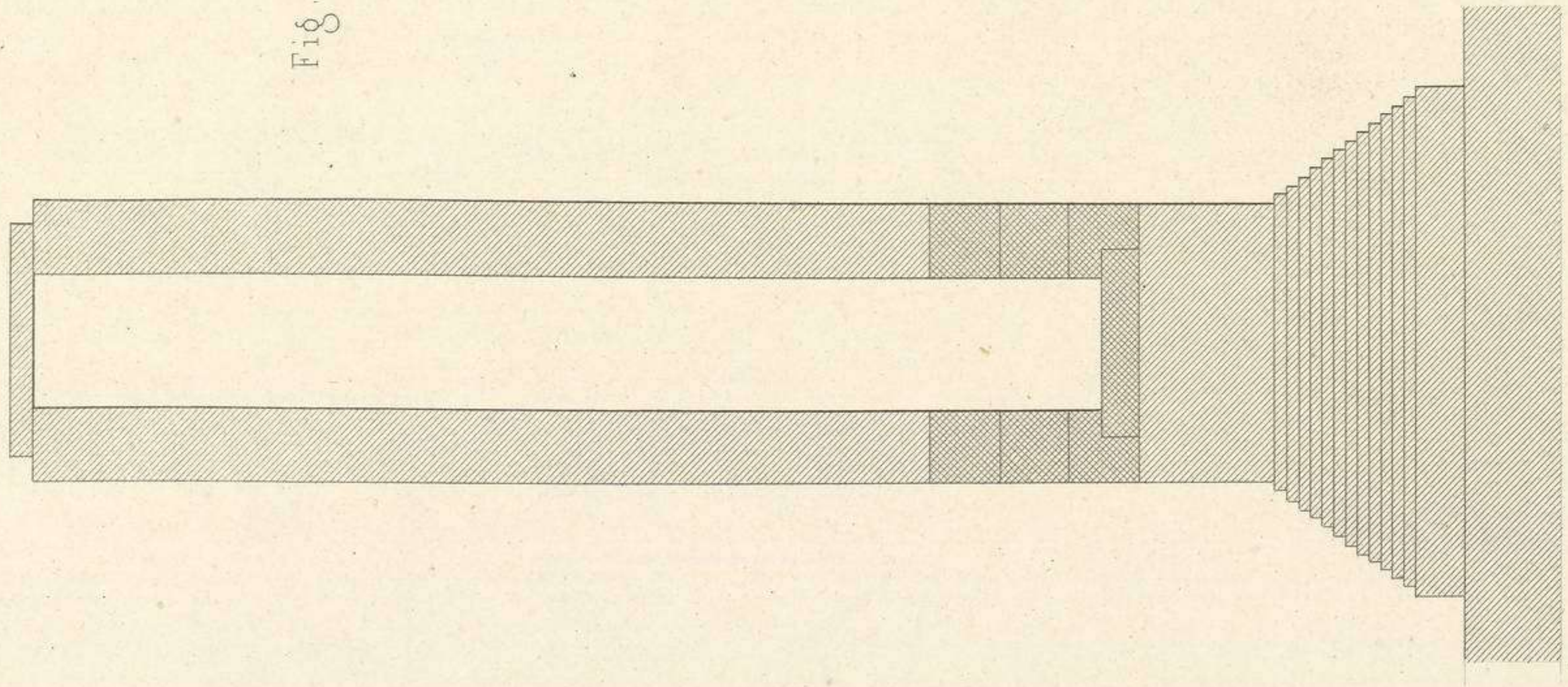
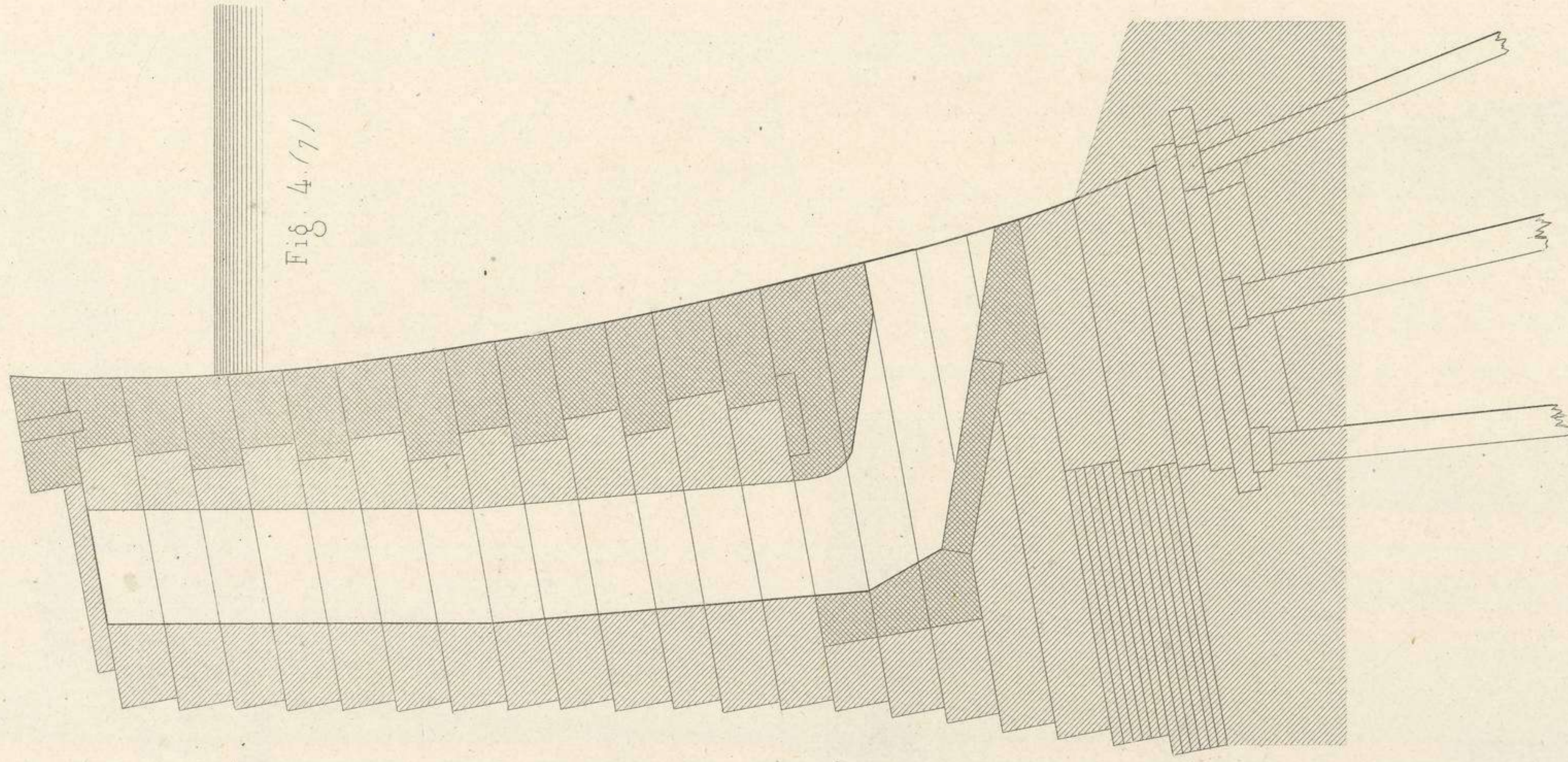
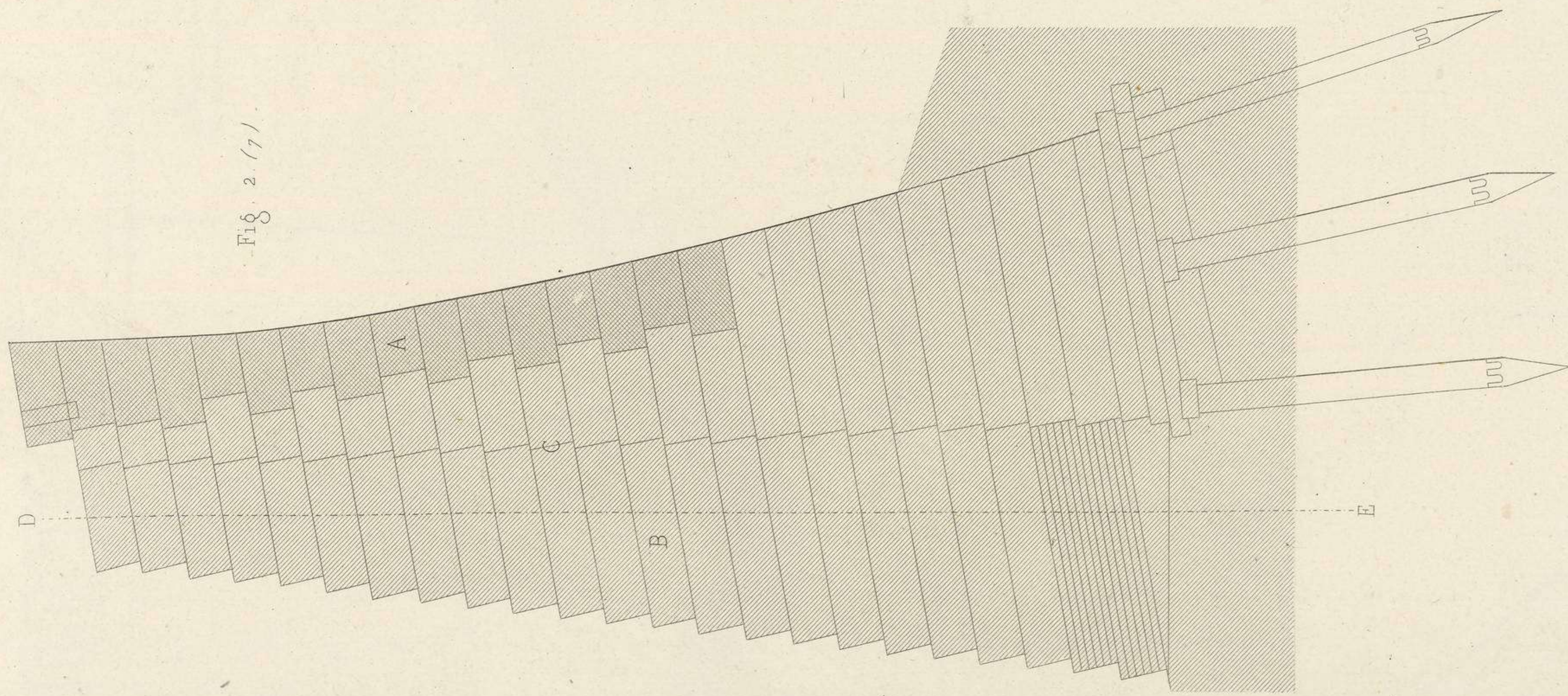

Fig. 13. (6)







Echelle des Fig. 2, 3, 4, 5. 10 Mètres.

Echelle de la Fig. 1. 10 Mètres.

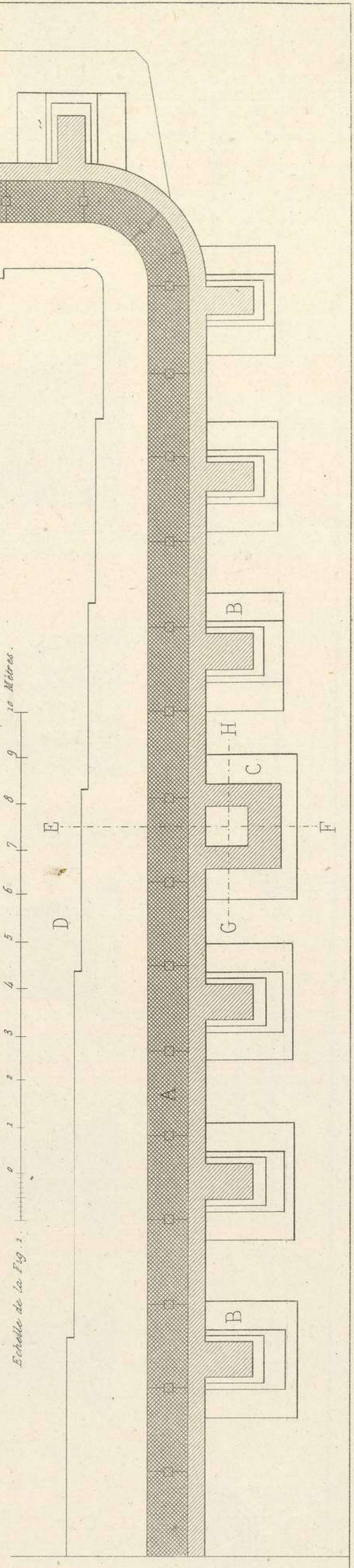

B. M. V. del.

H. B.

CONSTRUCTION EN PIERRES DE TAILLE.  
Massifs et Revêtements.



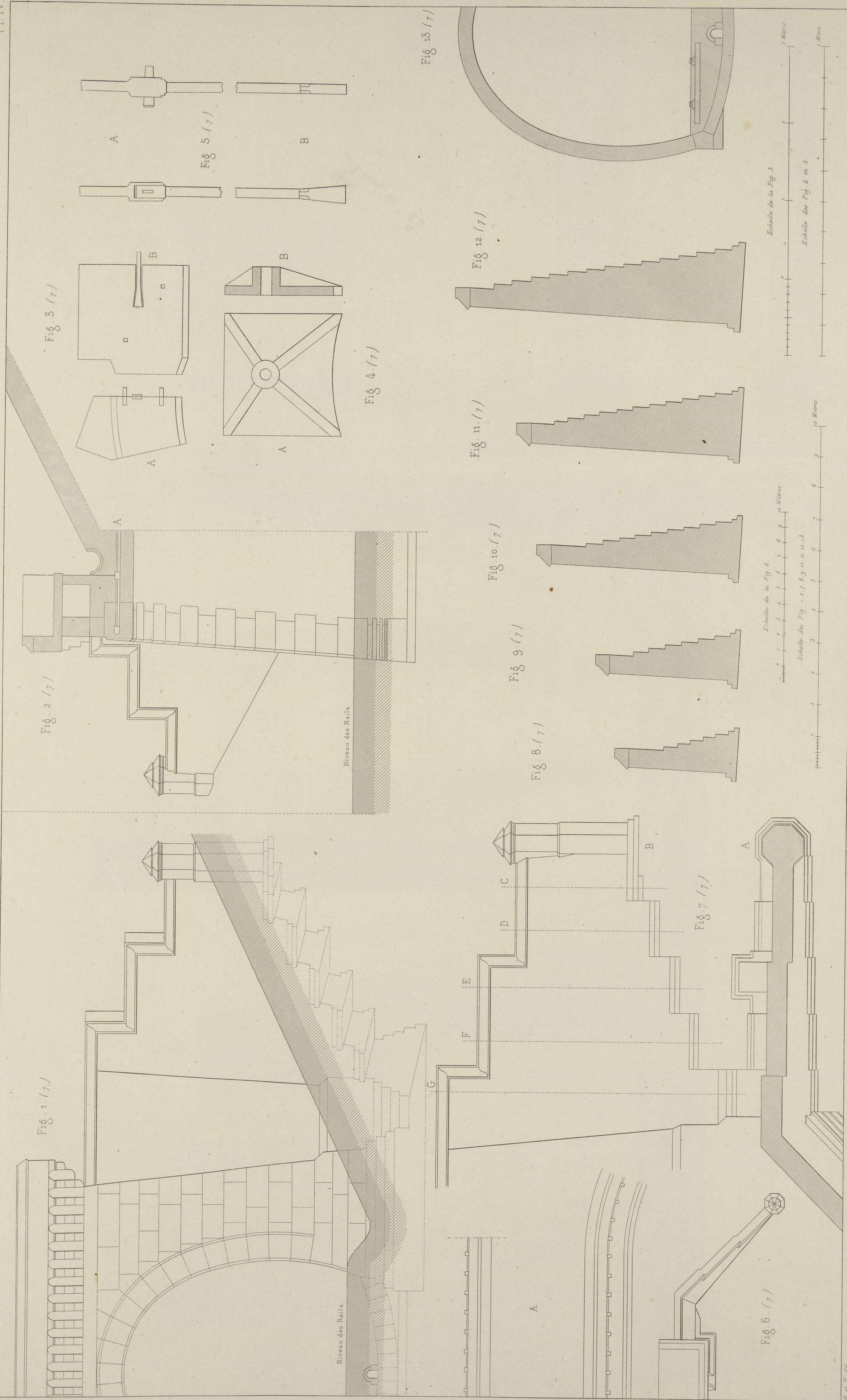



Fig. 2. (01)

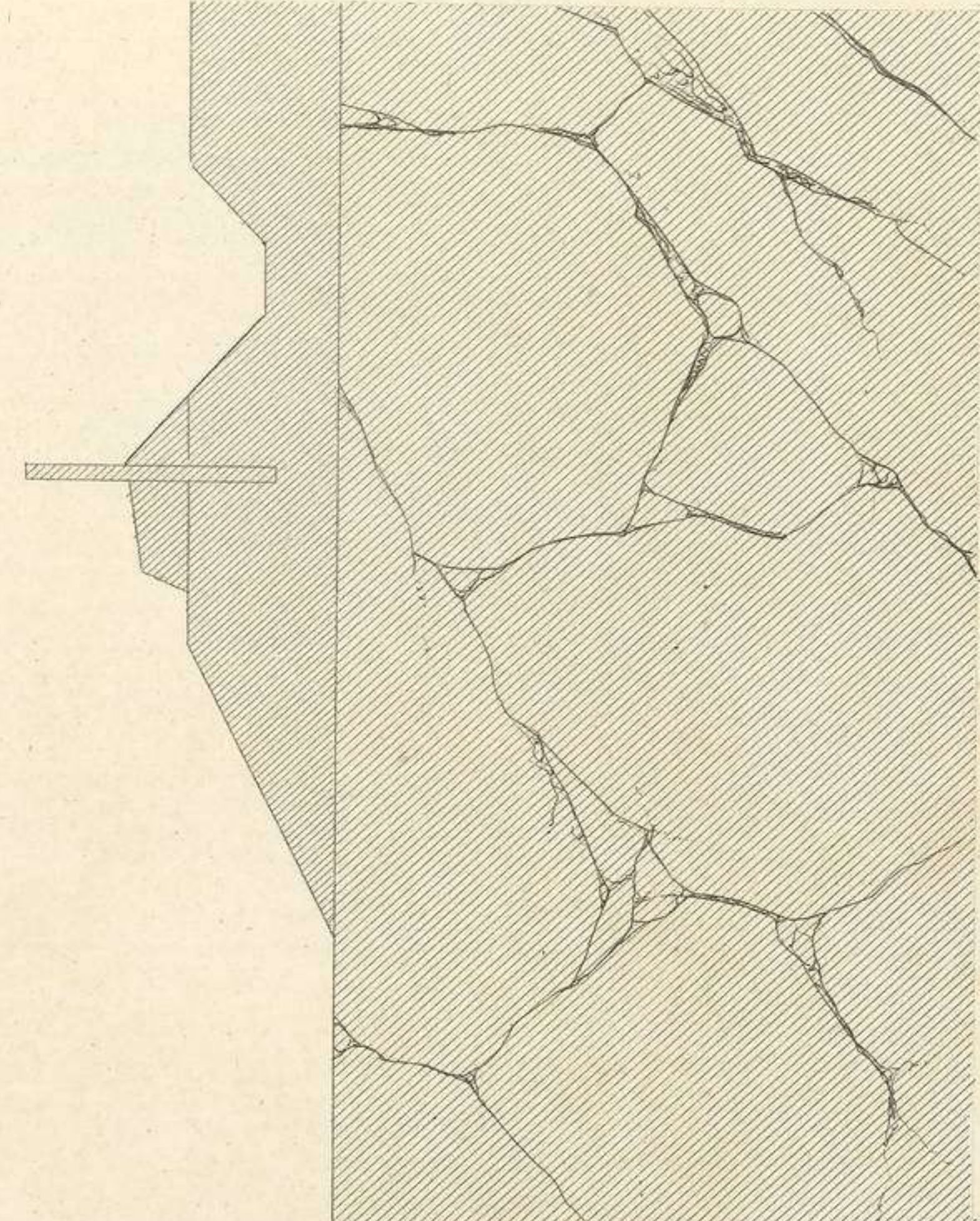
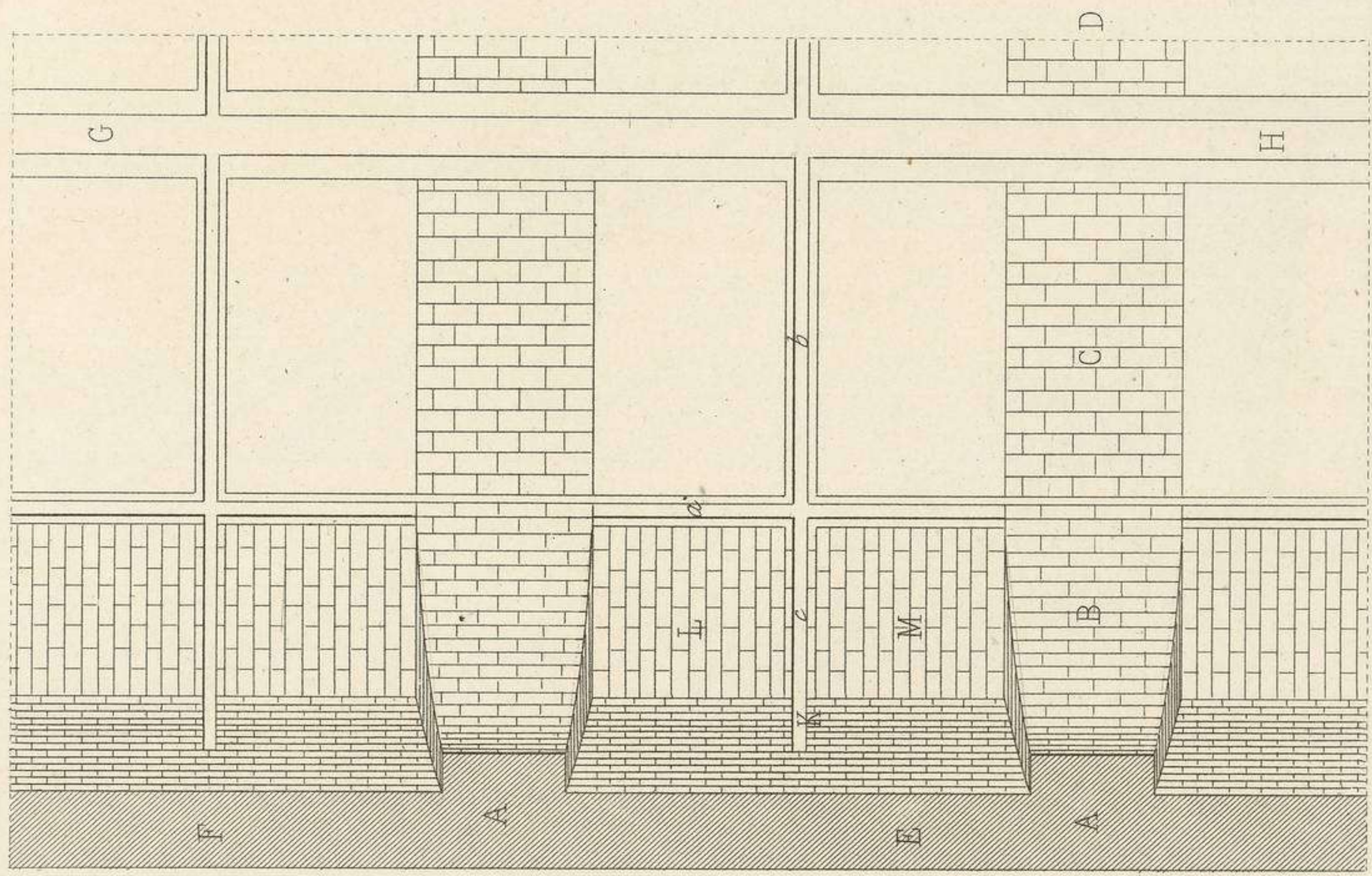

Fig. 3. (01)

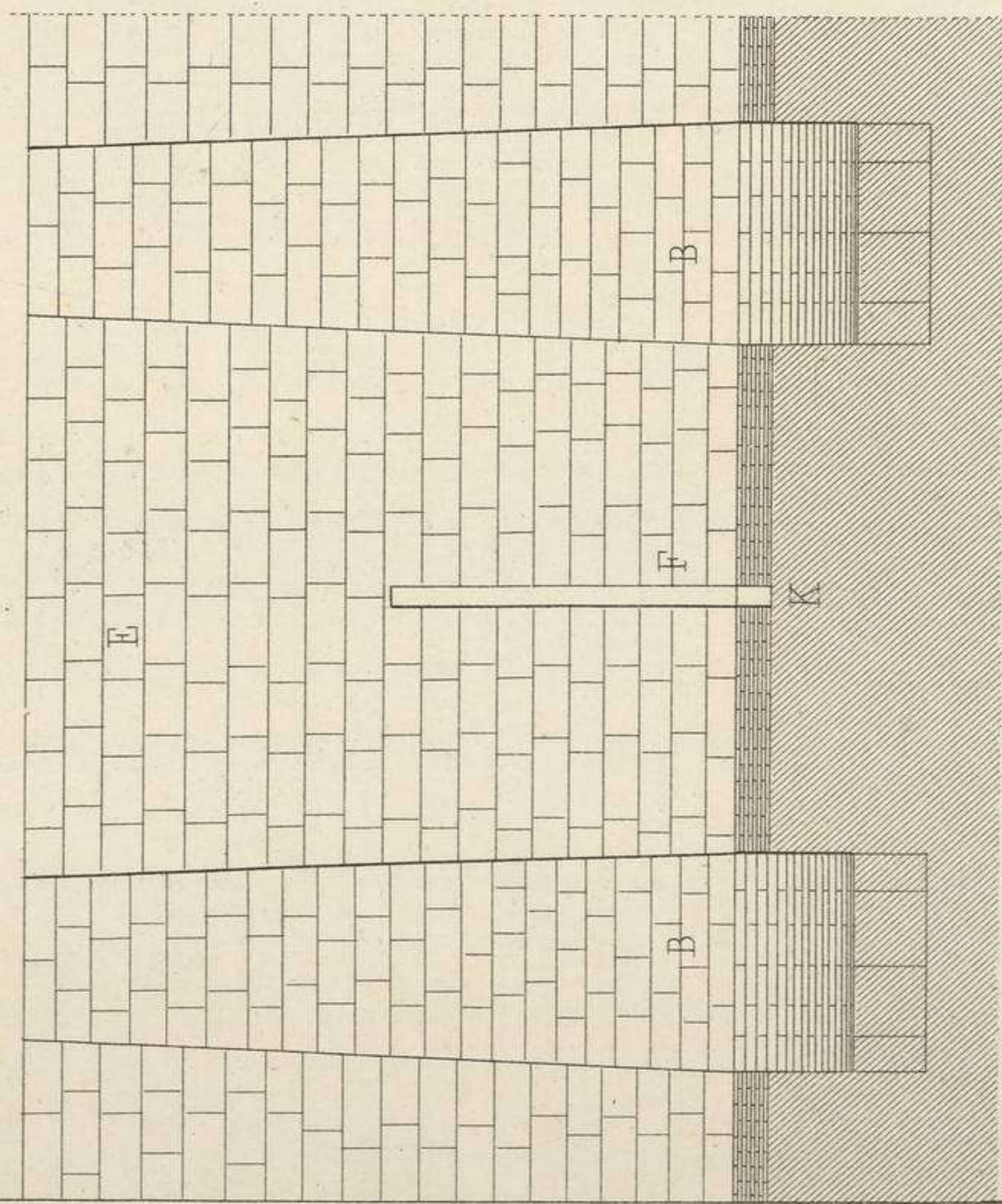

Fig. 1. (01)

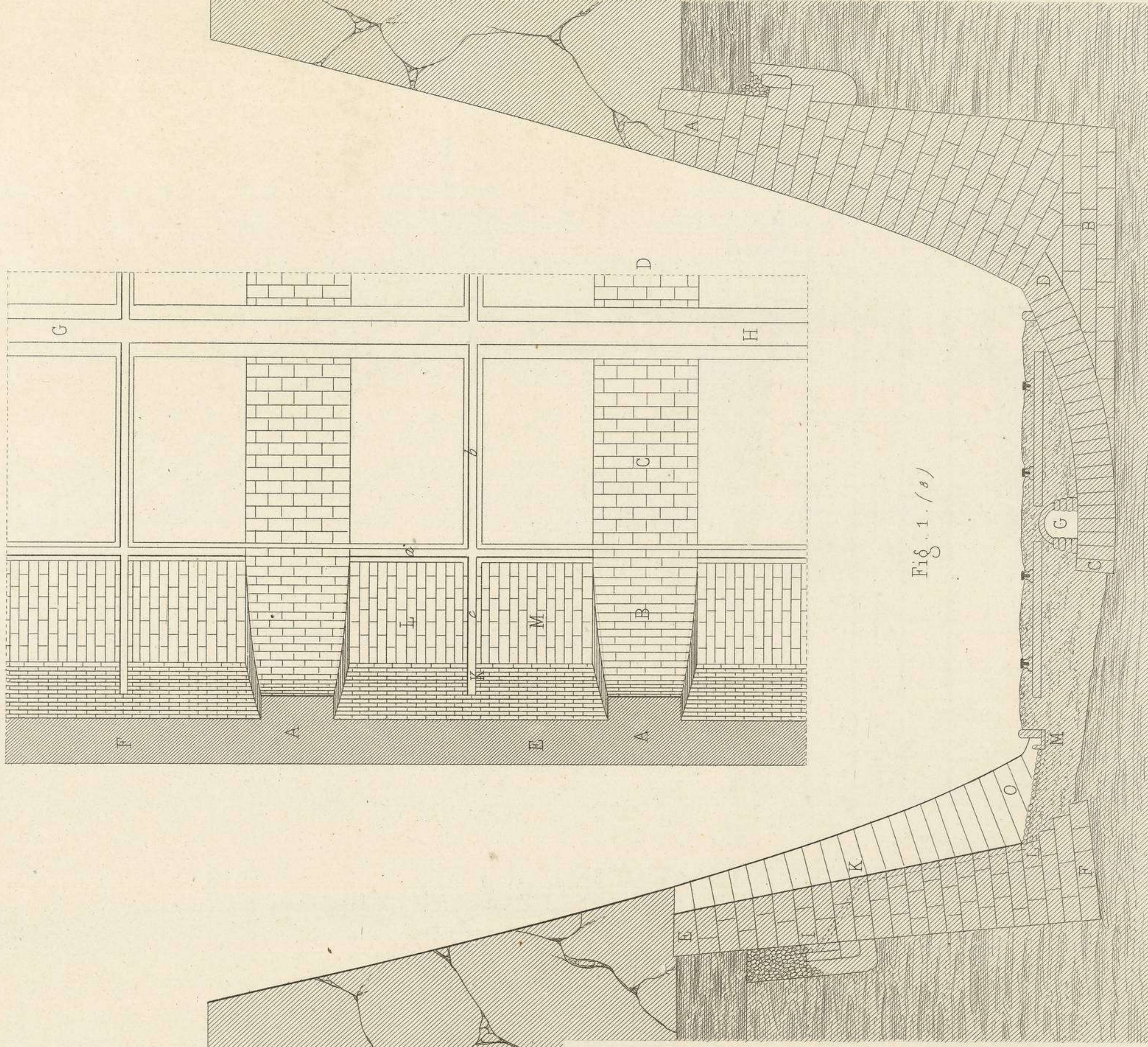

Fig. 4. (01)

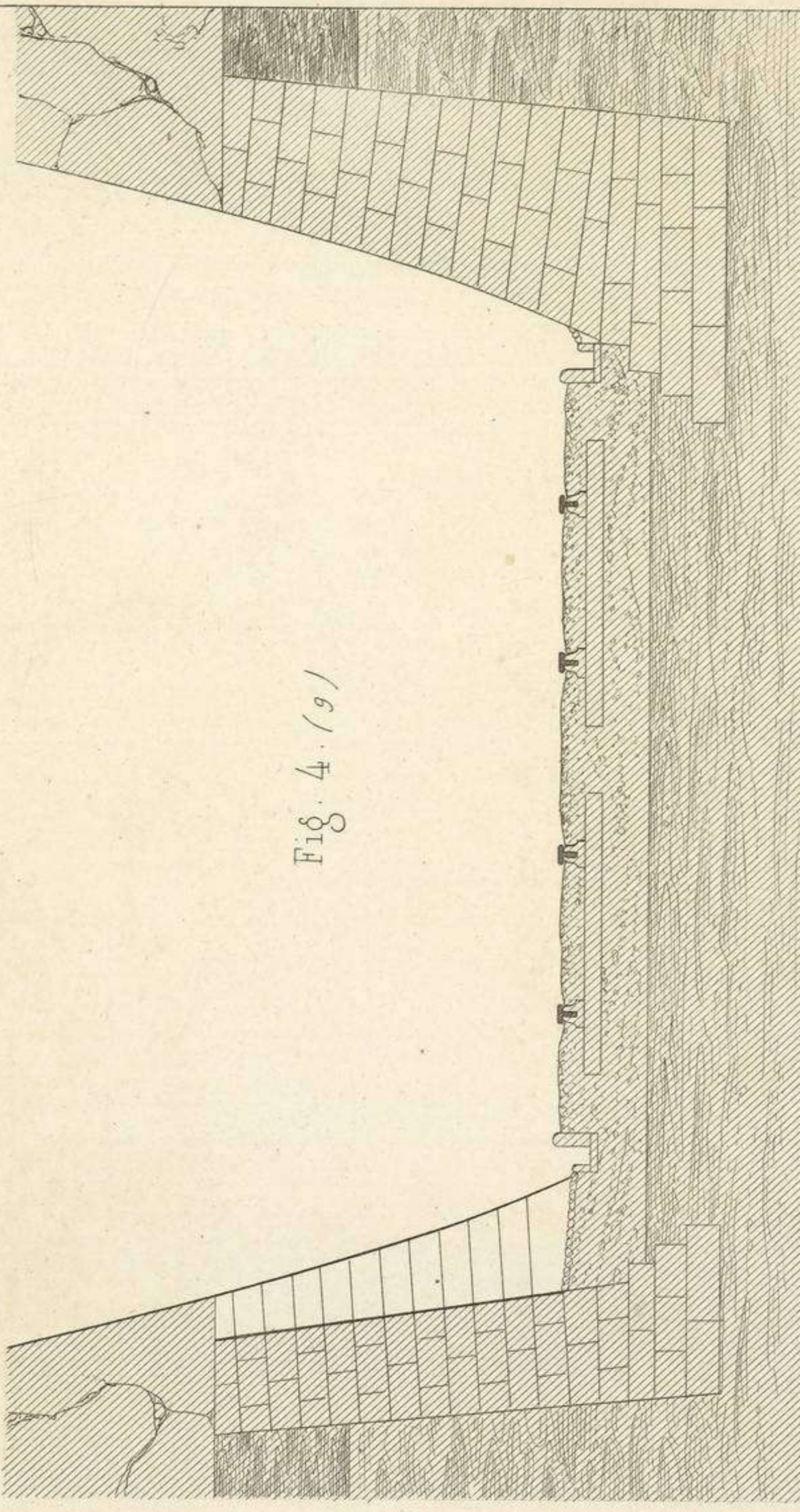
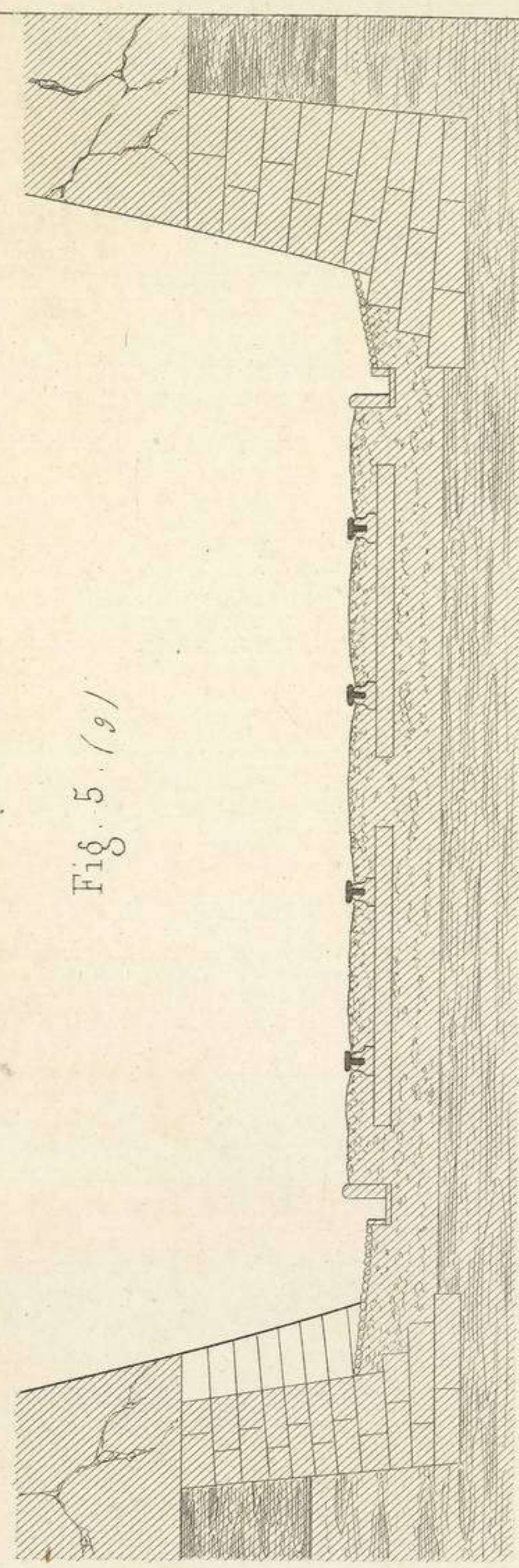

Fig. 5. (01)



0 1 2 3 4 5 6 7 8 9 10 11 12 13 14 15 16 17 18 19 toises

B. et V. del.

CONSTRUCTION EN PIERRES DE TAILLE.  
Massifs et Revêtements.

H.R.



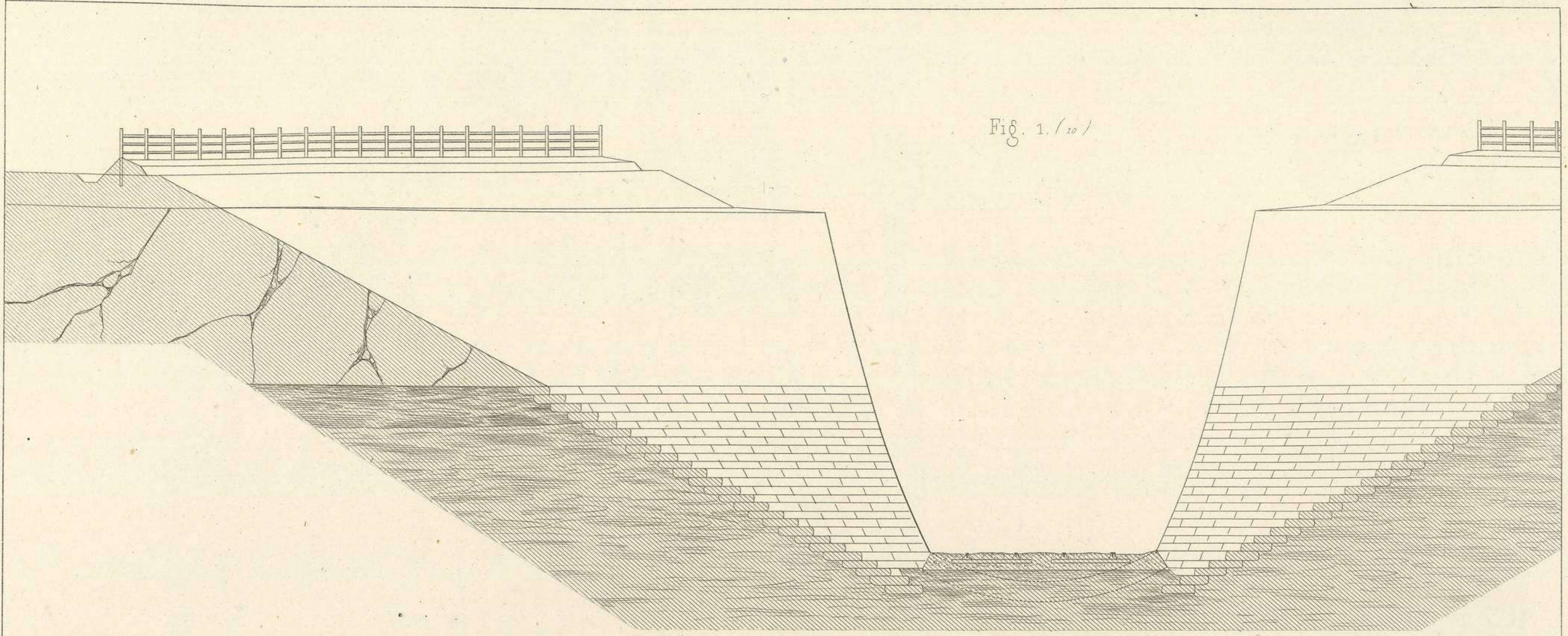
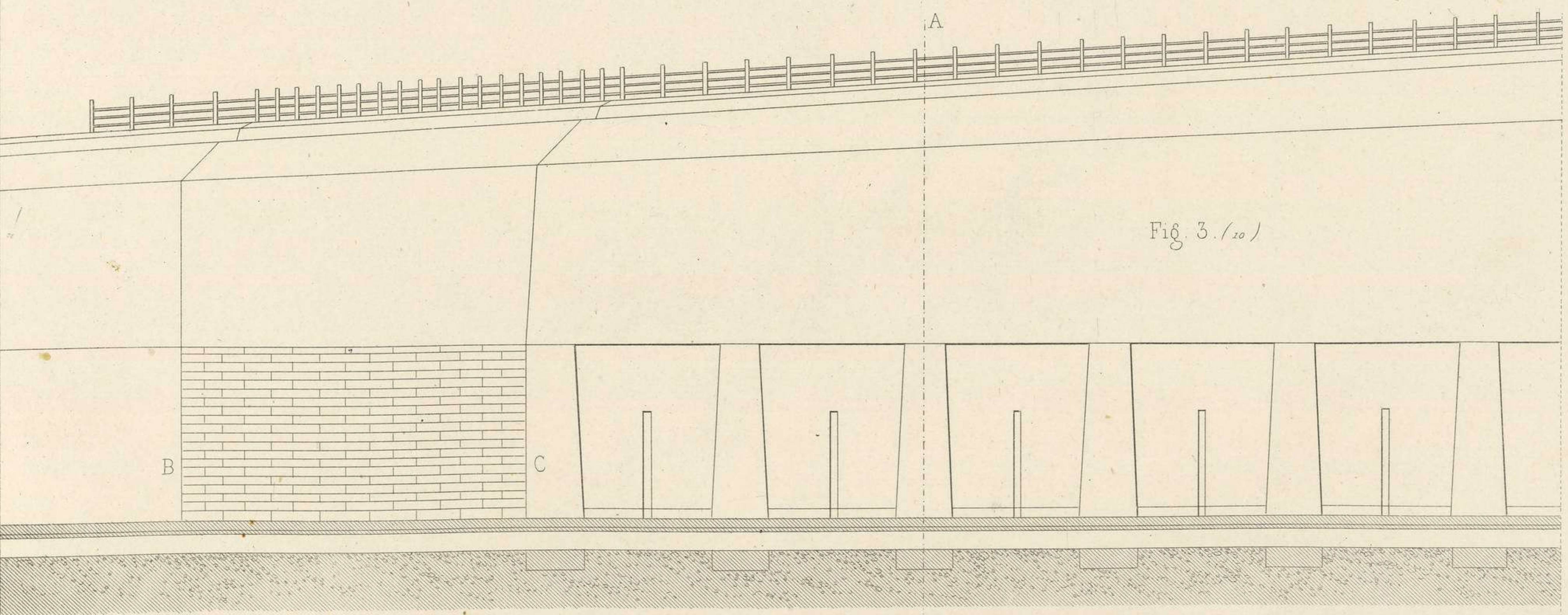
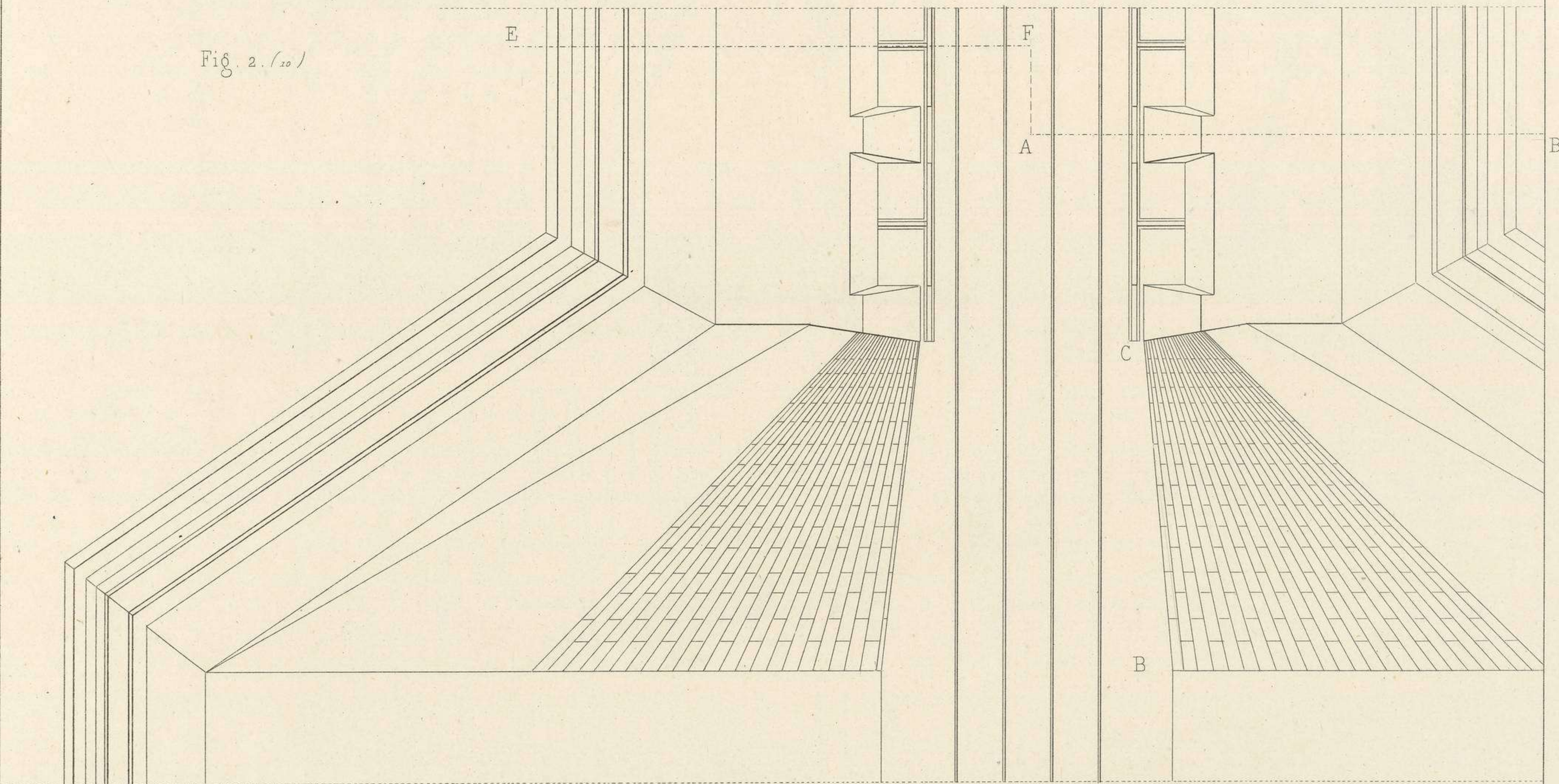

Fig. 2. (20)



0 1 2 3 4 5 6 7 8 9 10 11 12 13 14 15 16 17 18 19 20 21 22 23 24 25 Mètres

B. et V. del.

H. R.

CONSTRUCTION EN PIERRES DE TAILLE.  
Massifs et Revêtements.



Fig. 1. (n)

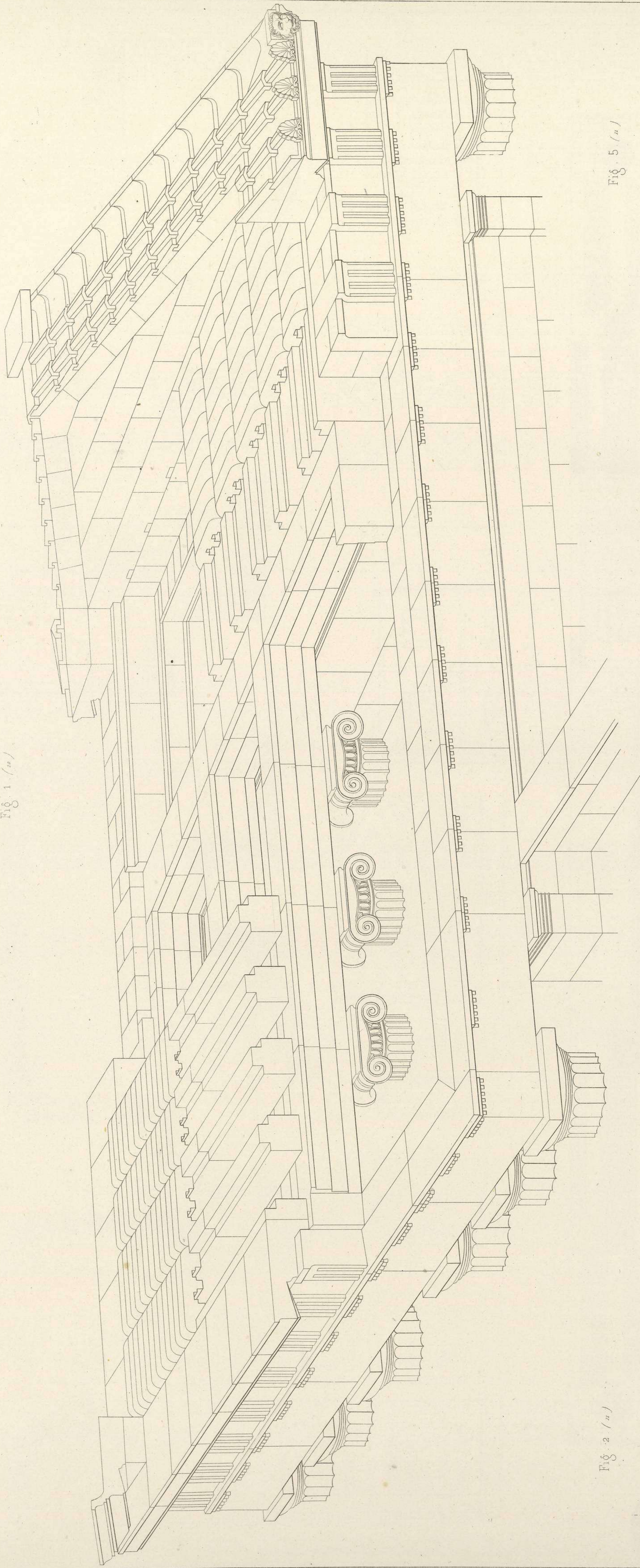

Fig. 2. (n)

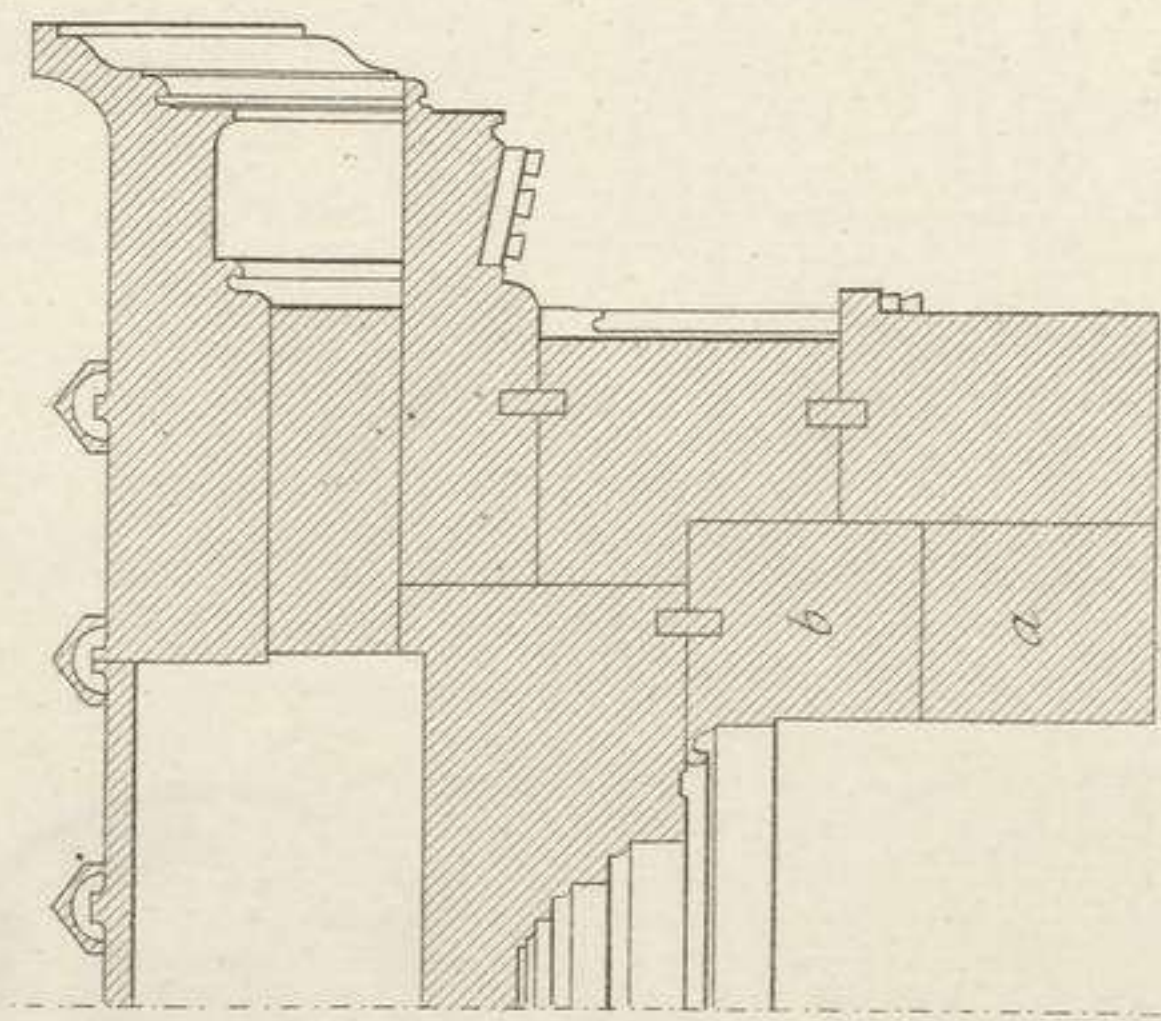

Fig. 4. (n)

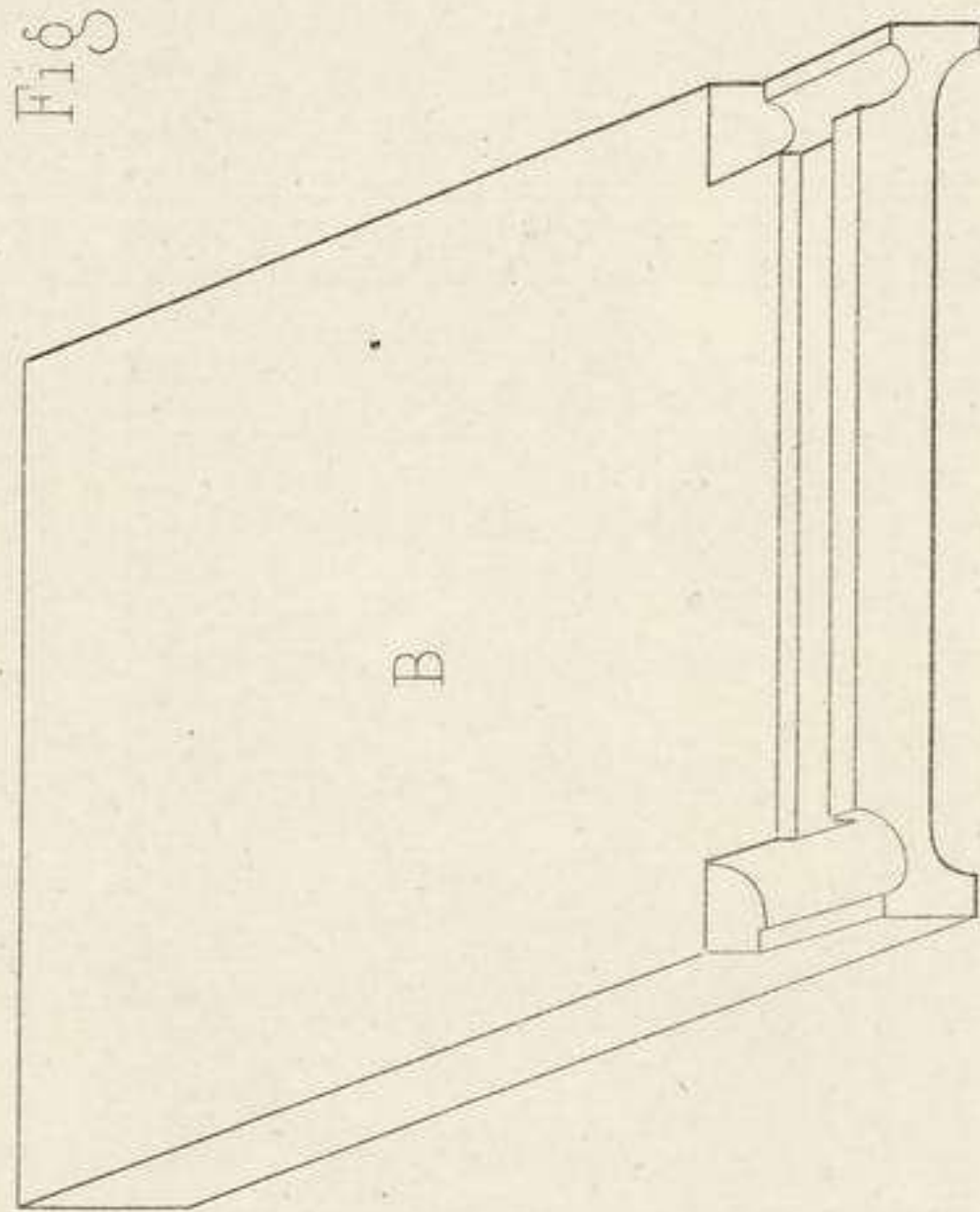

Fig. 3. (n)

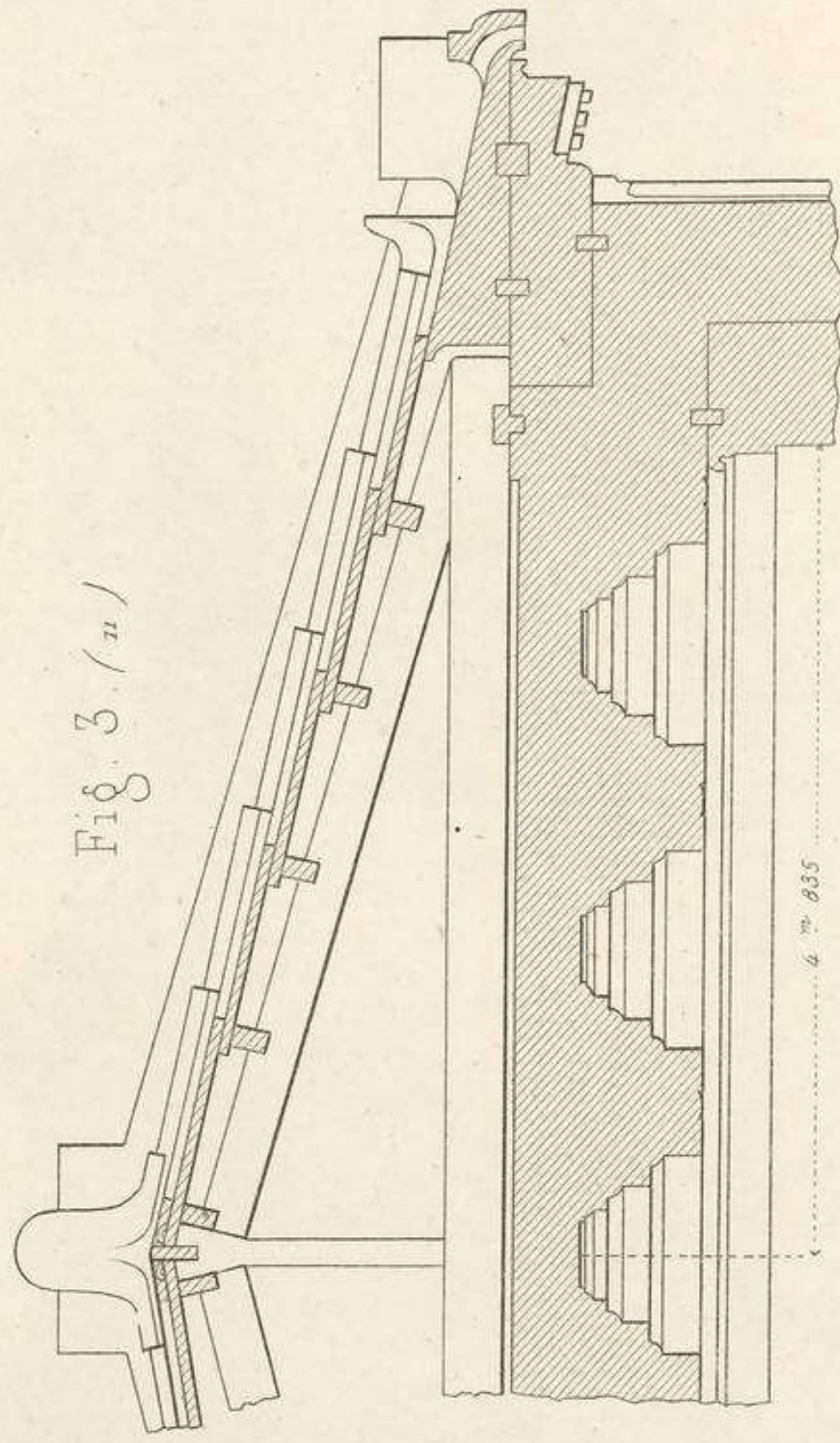
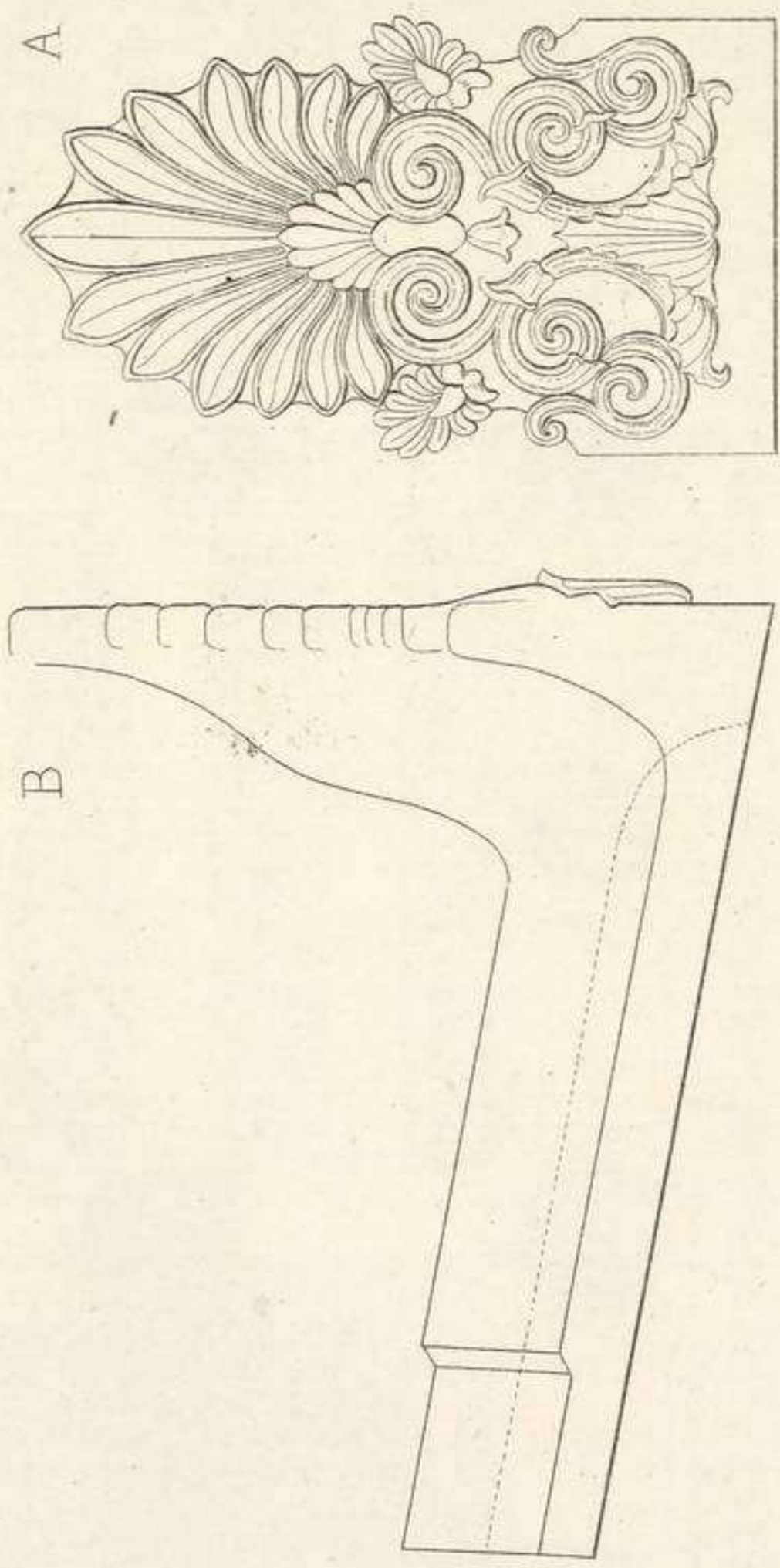

Fig. 5. (n)



Blanch et Verel del.

H. Roux sculp.

STÉRÉOTOMIE.  
Plates bandes et Plafonds non appareillés.







Fig. 1. (10)

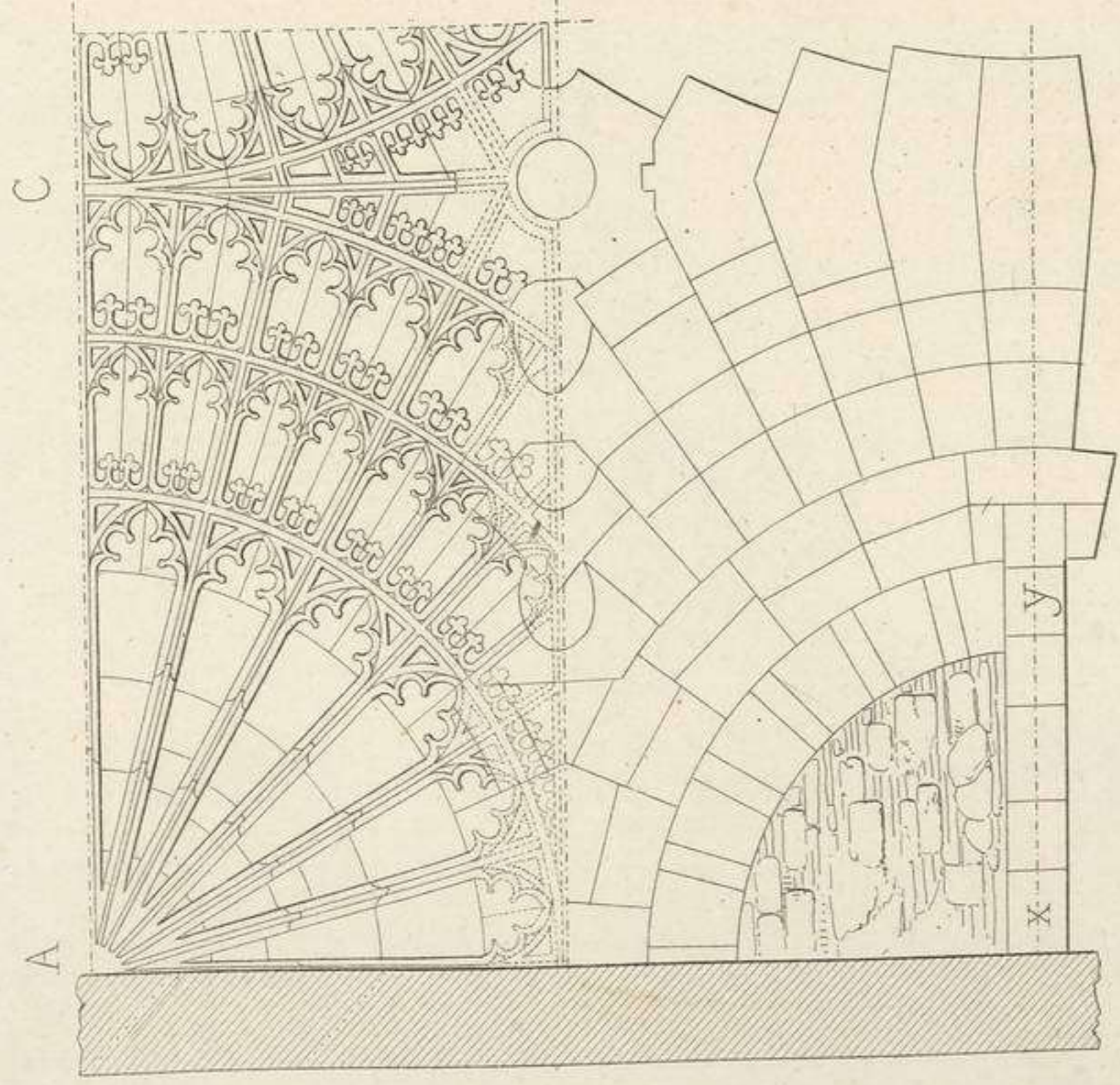

Fig. 2. (14)

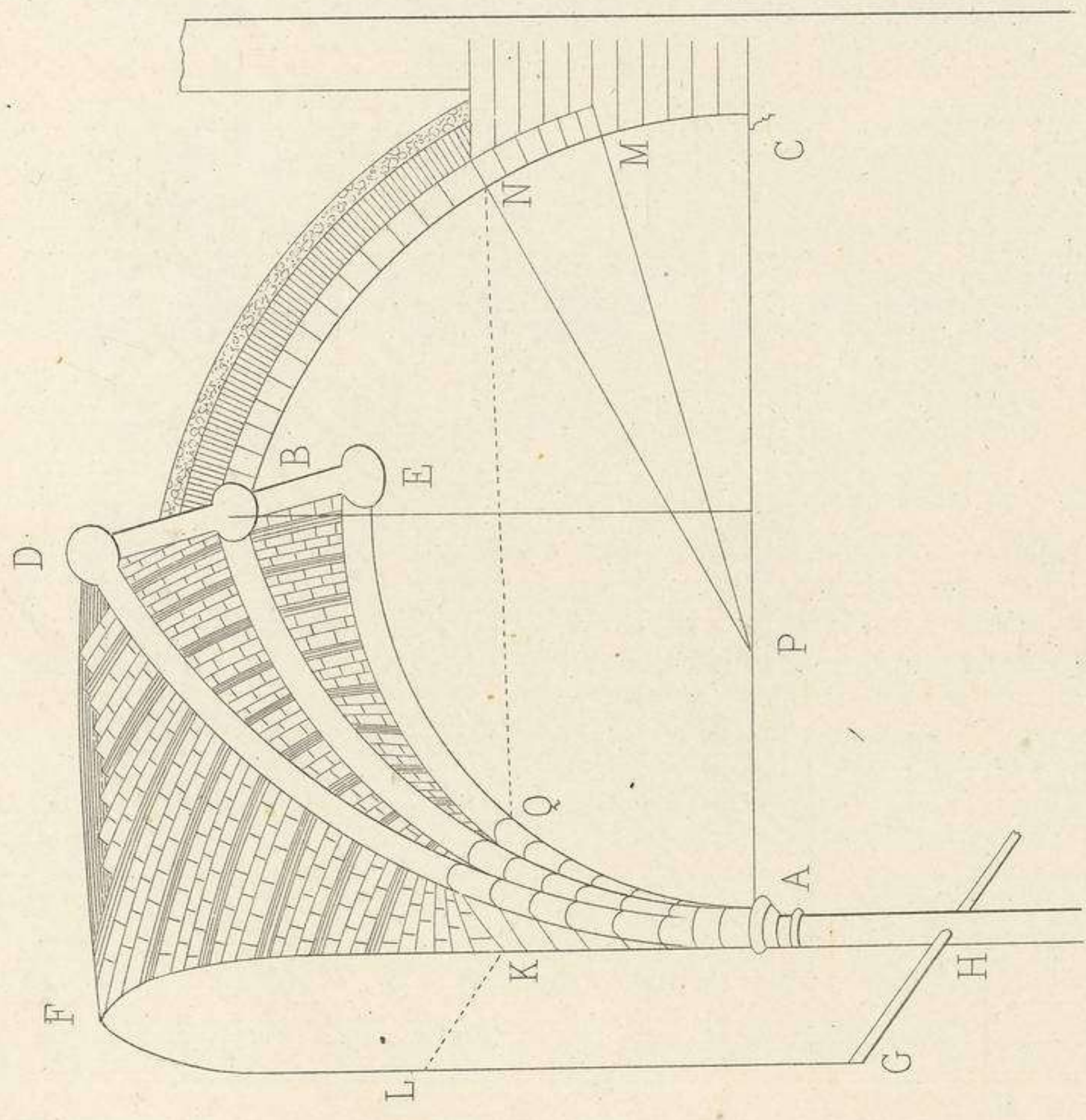

Fig. 3. (19)

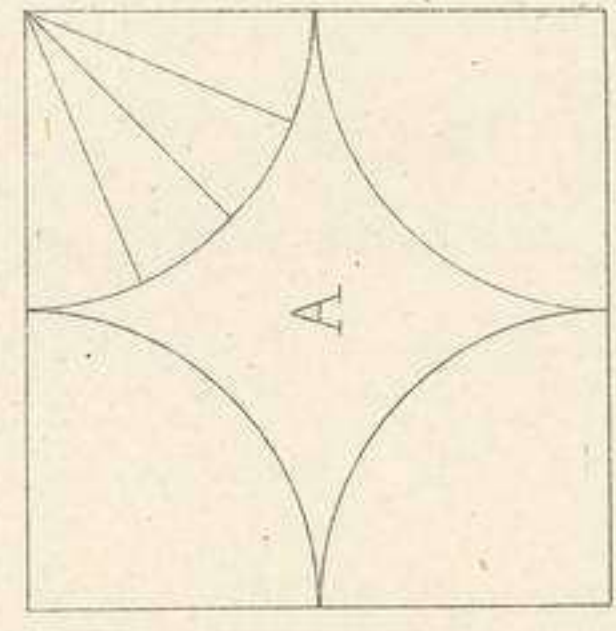

Fig. 4. (15)

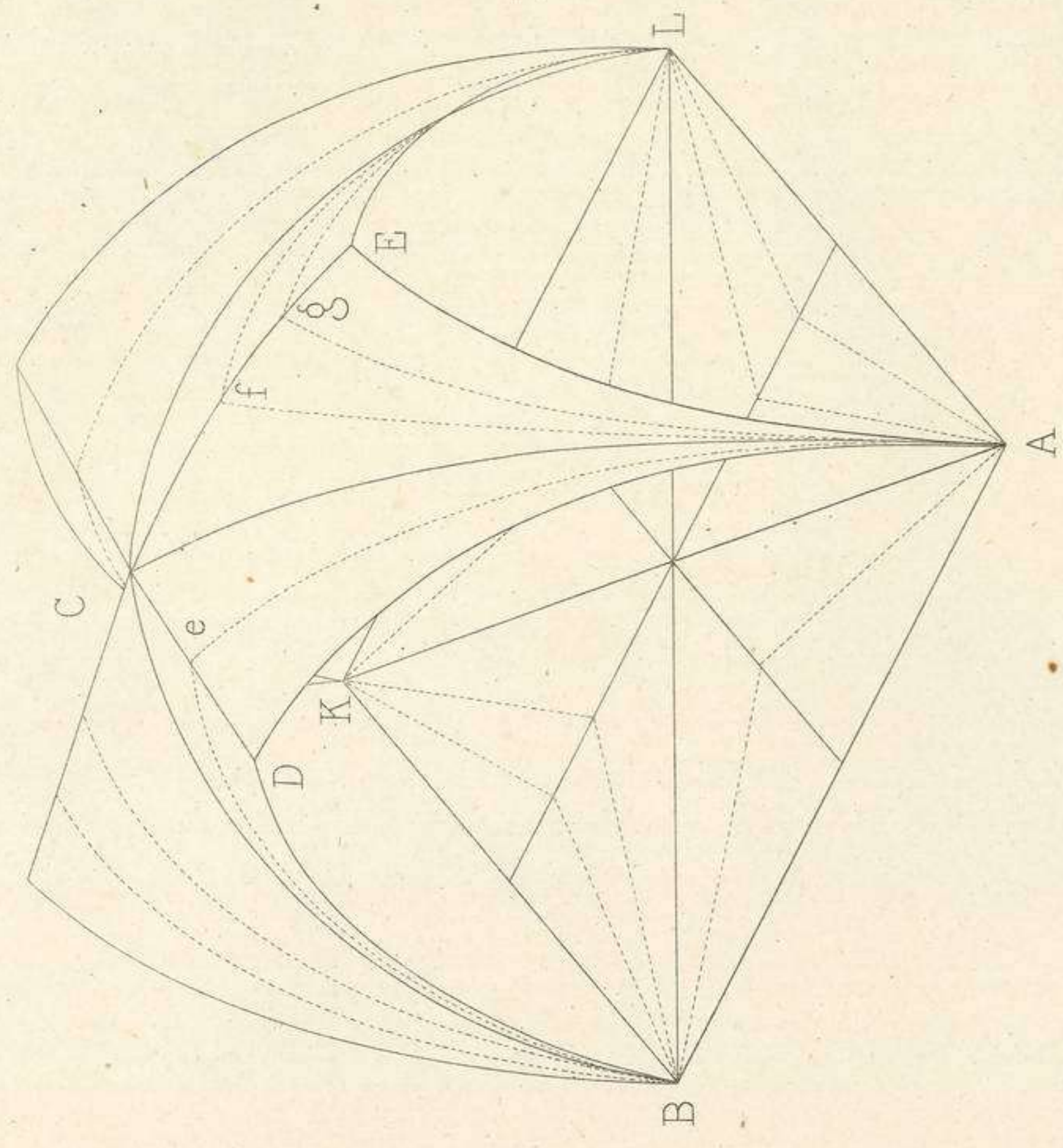

Fig. 5. (20)

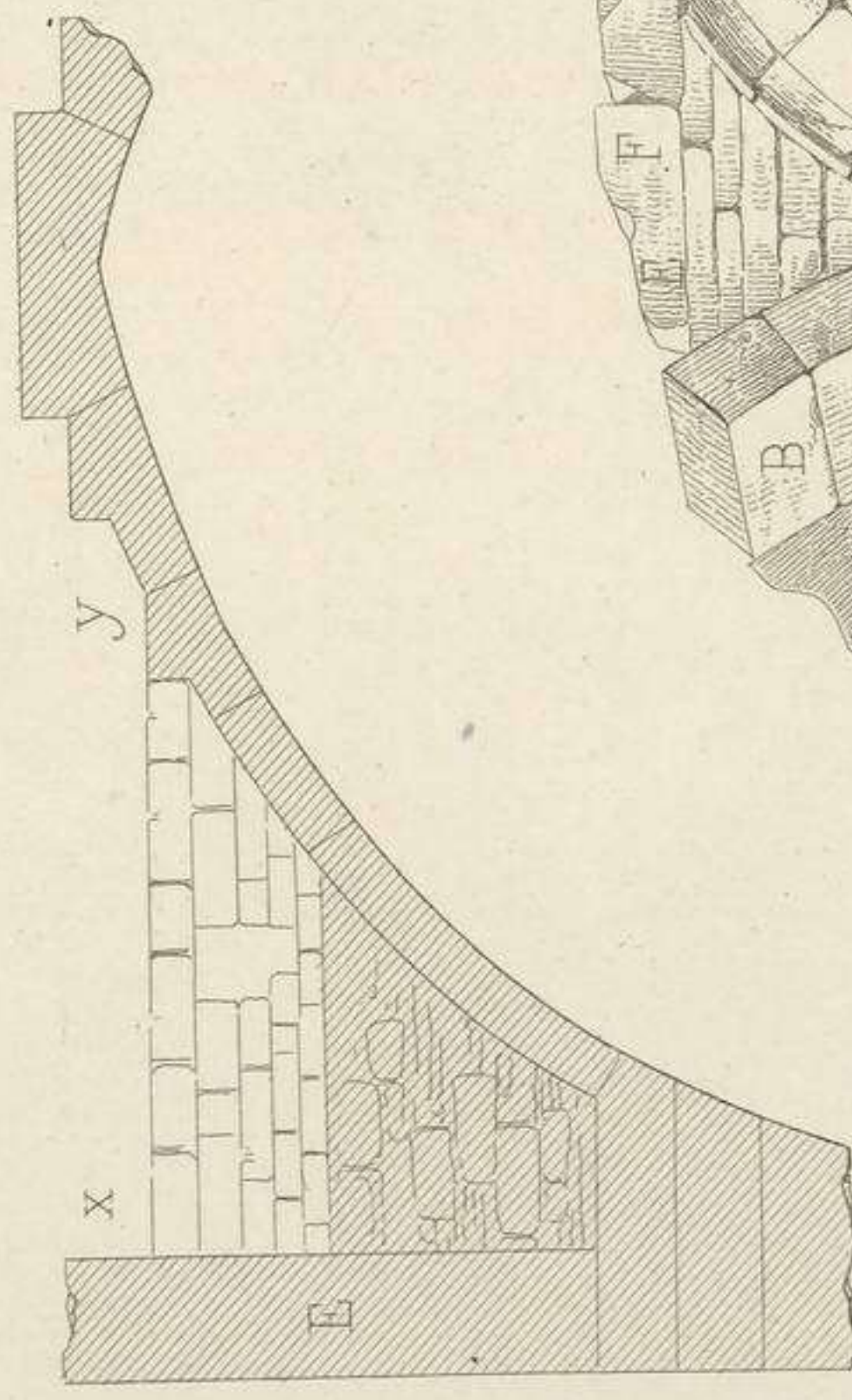

Fig. 6. (13)

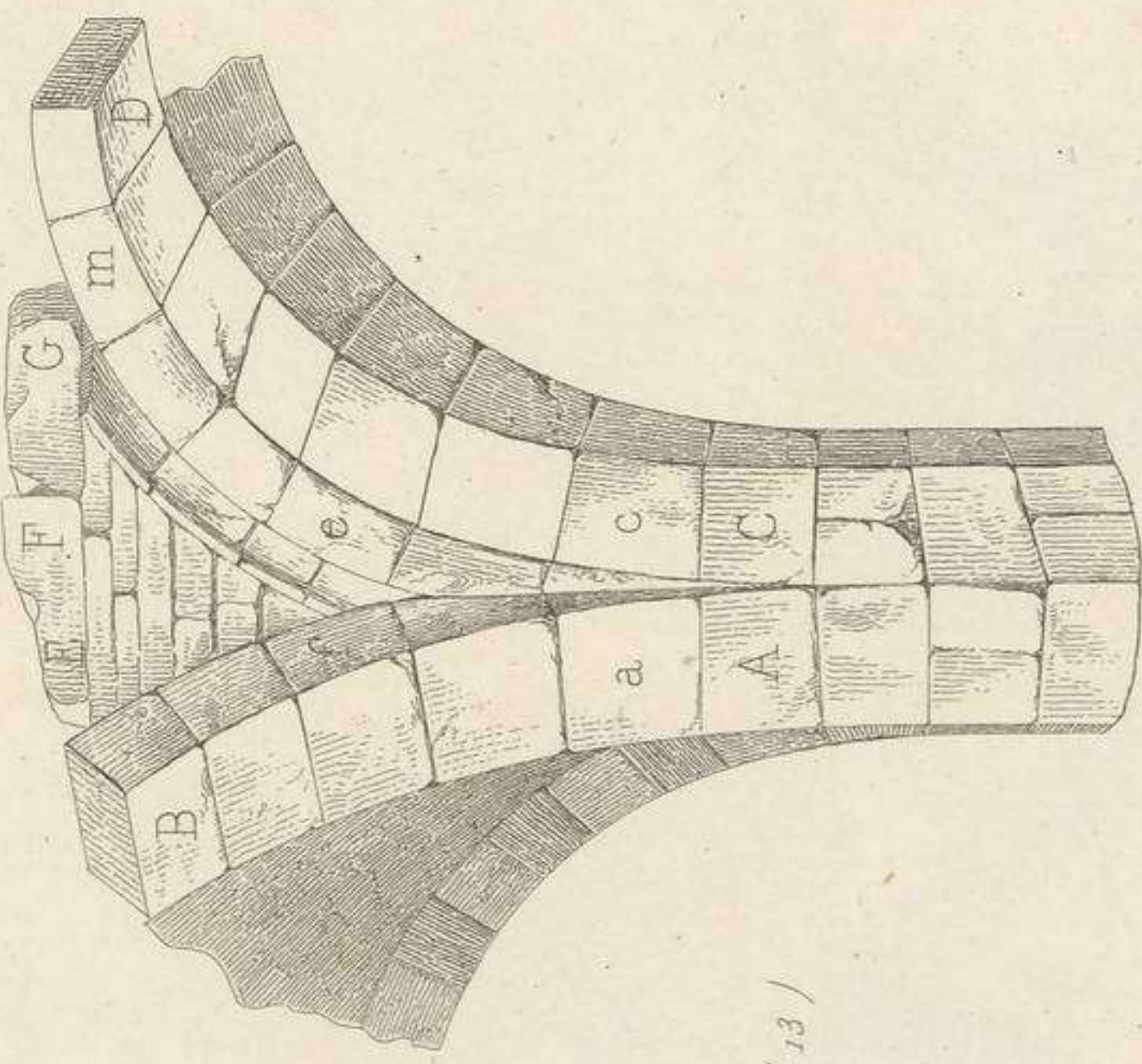

Fig. 7. (13)

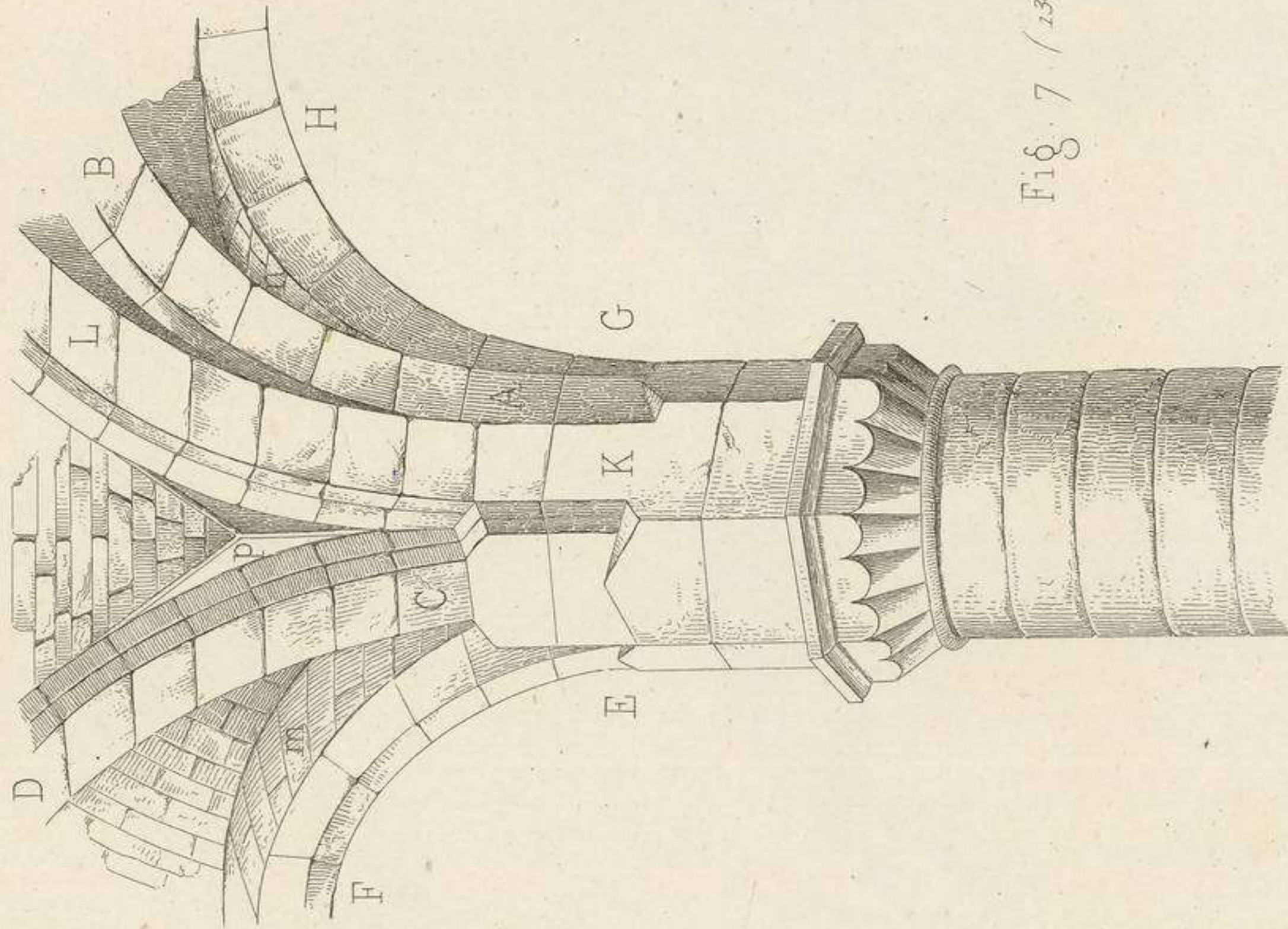
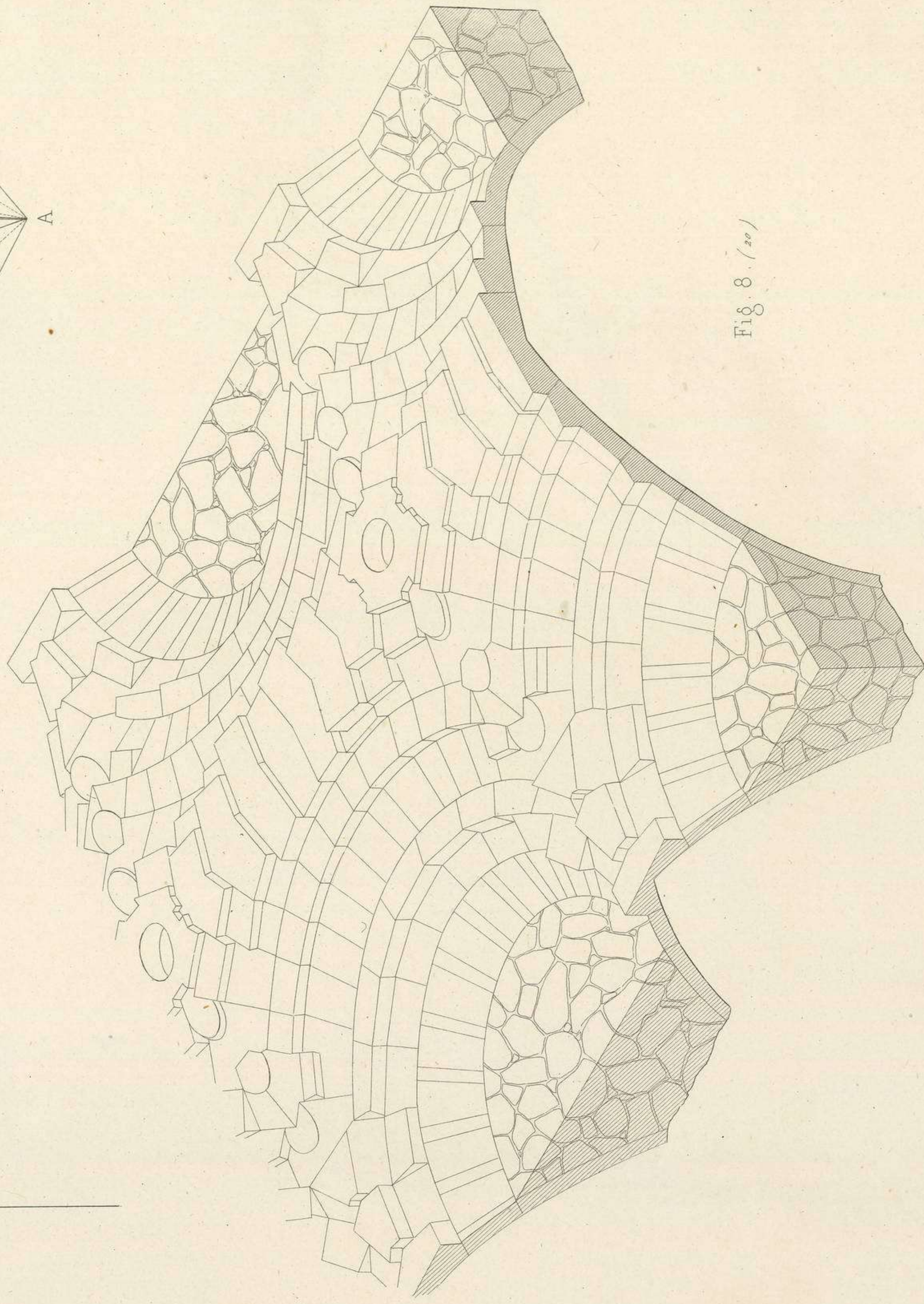

Fig. 8. (22)





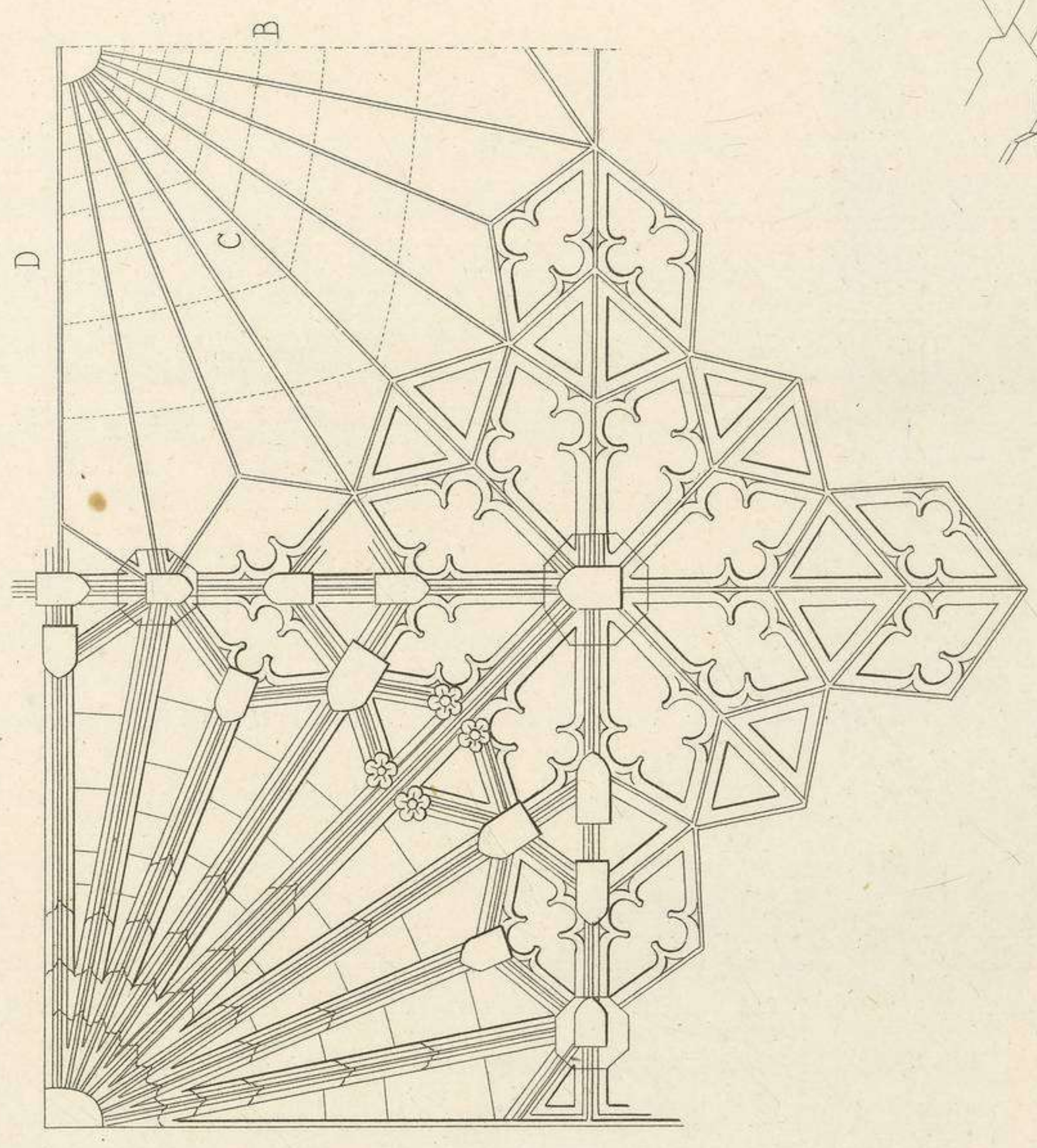
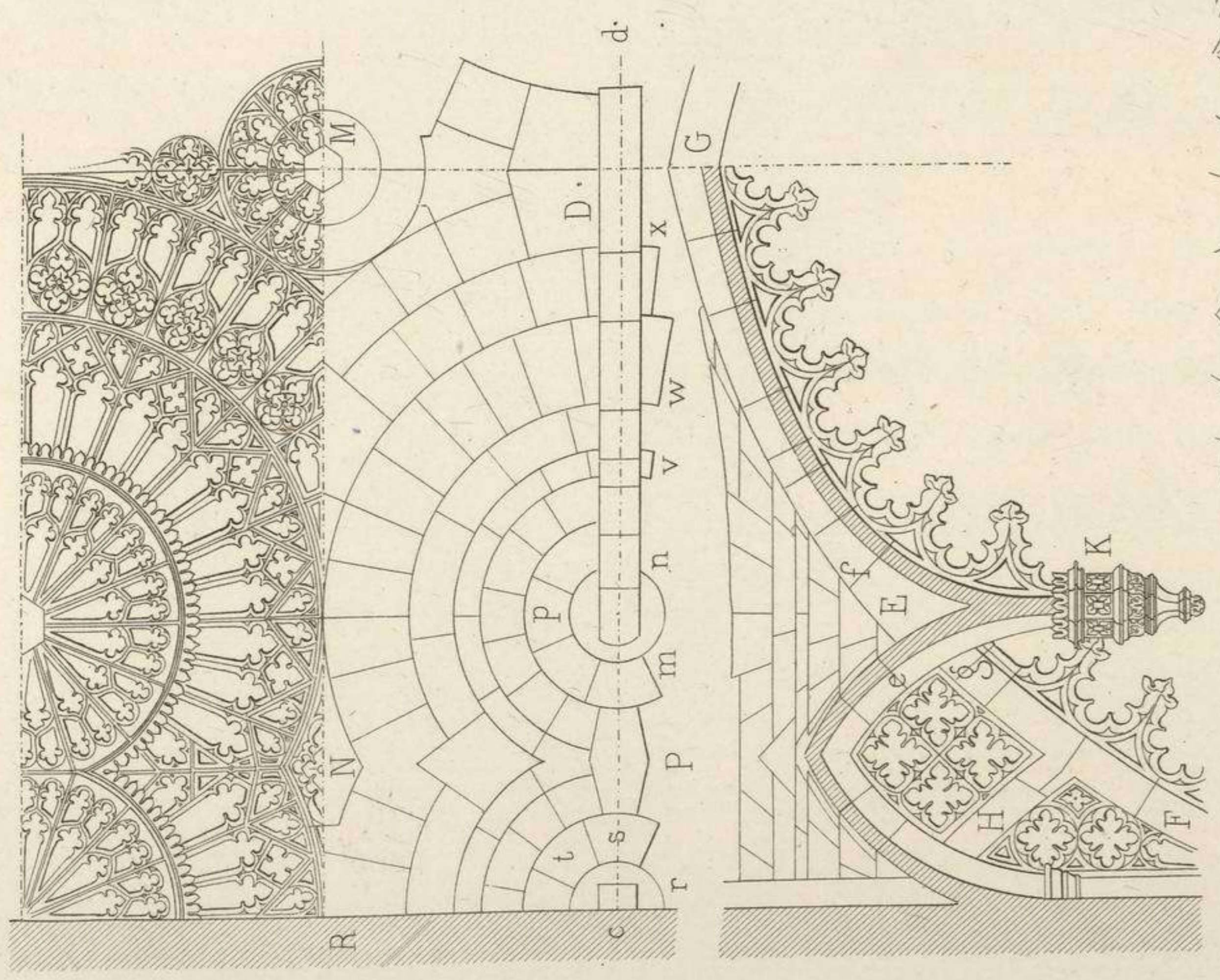

Fig. 5. (22)

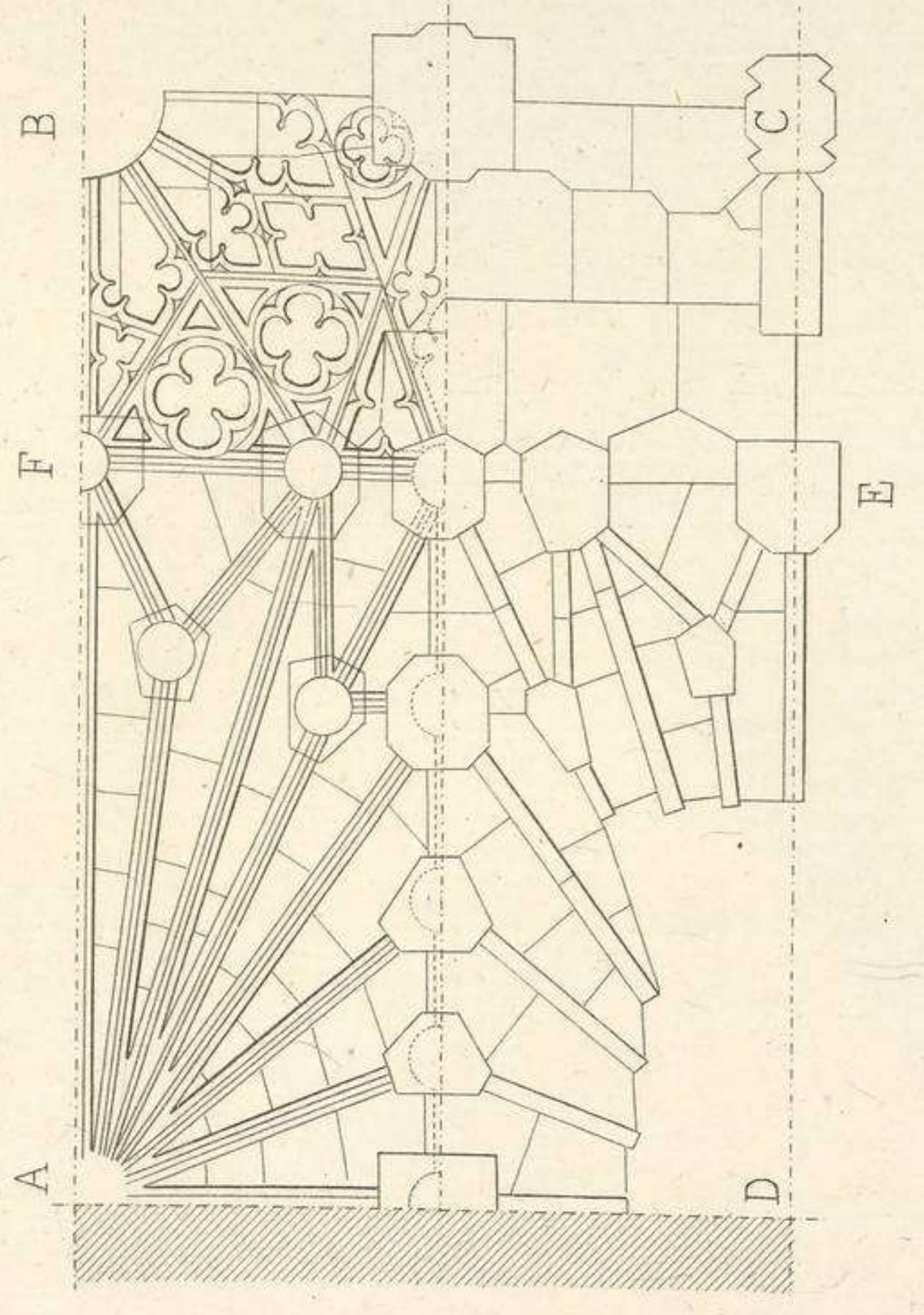

Fig. 6. (22)

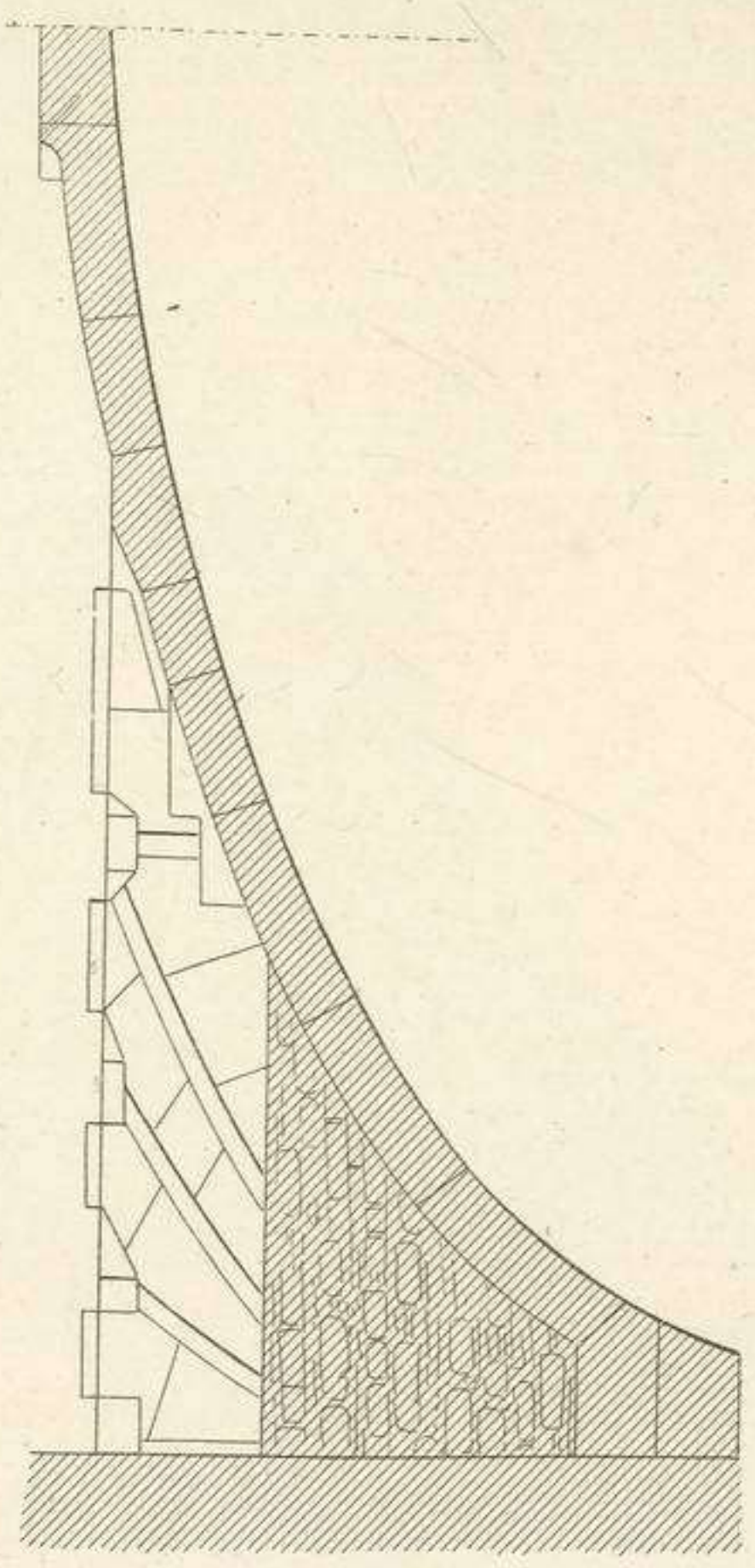
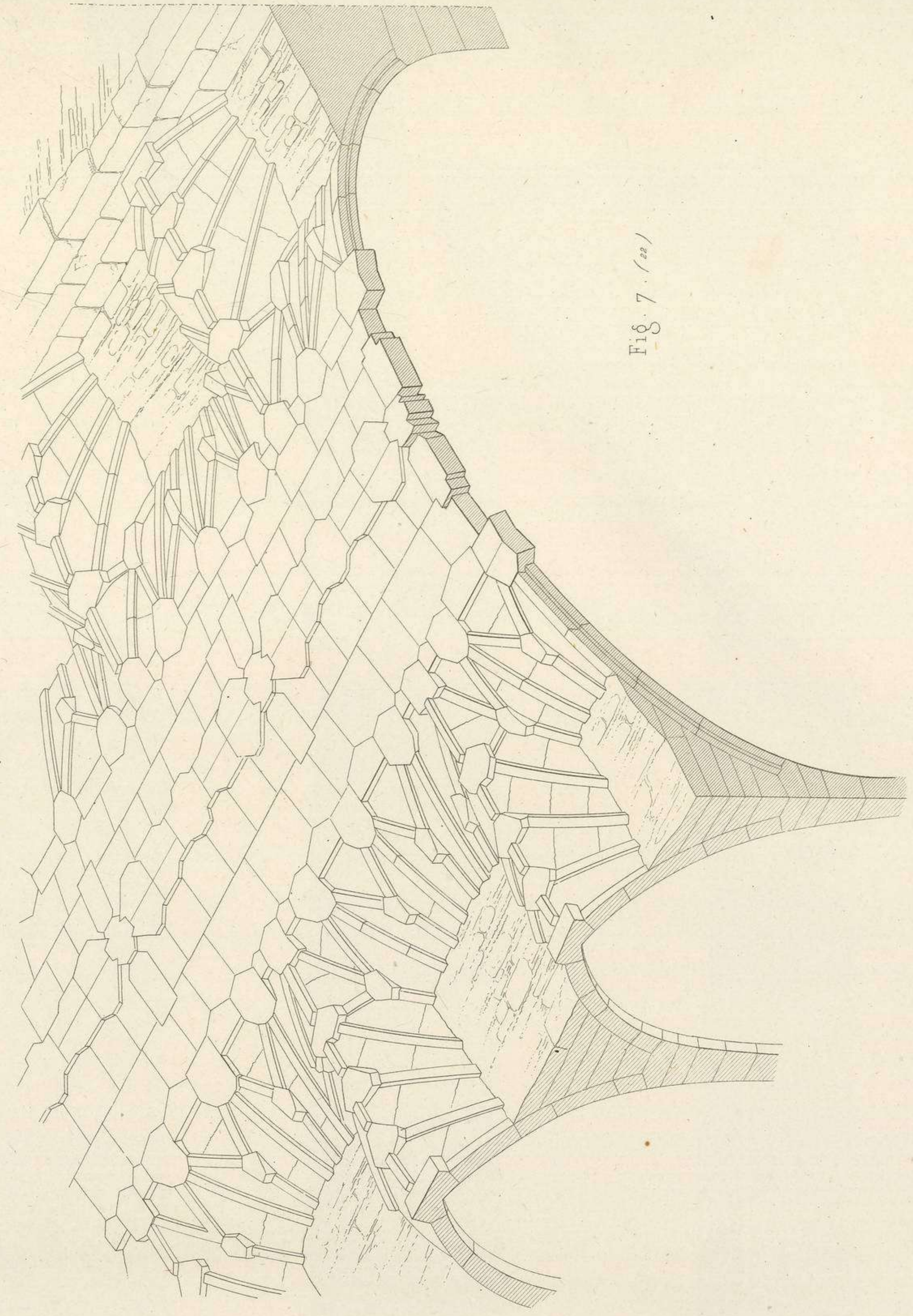
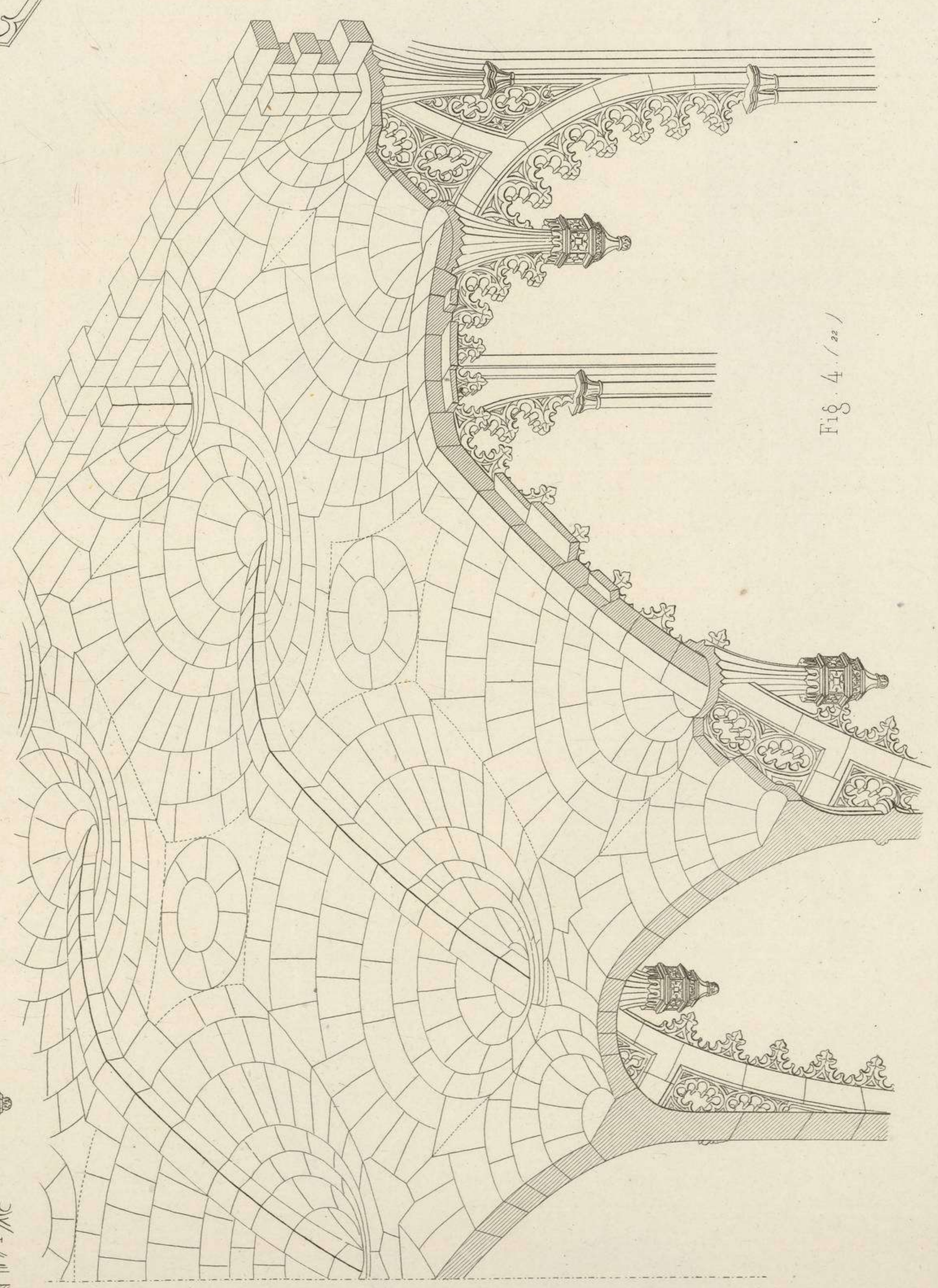
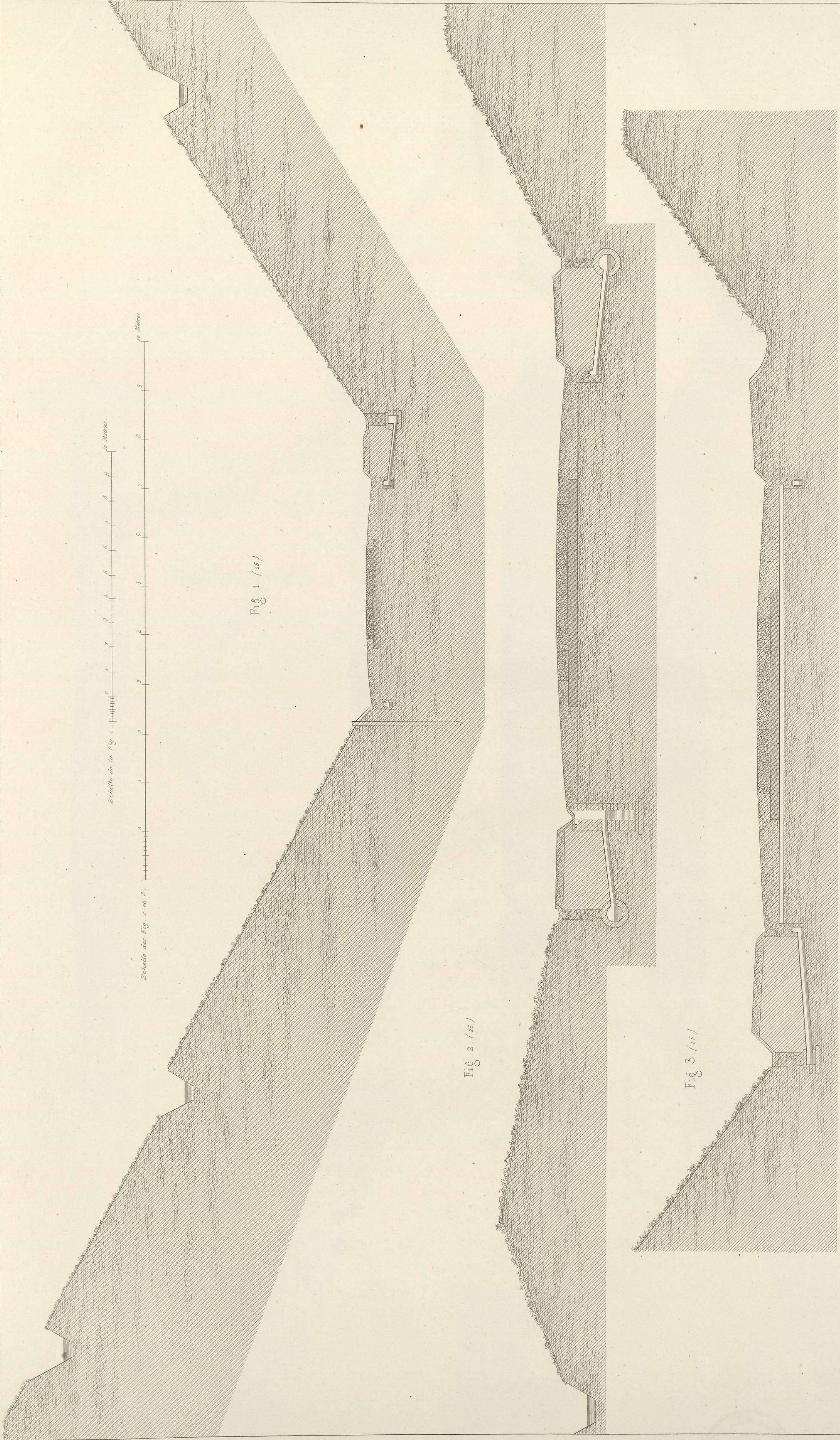

Fig. 3. (22)







Blouet et Virel, del. H. Beauvais, sculp.

MAÇONNERIE.  
Voies publiques et grands Chemins.



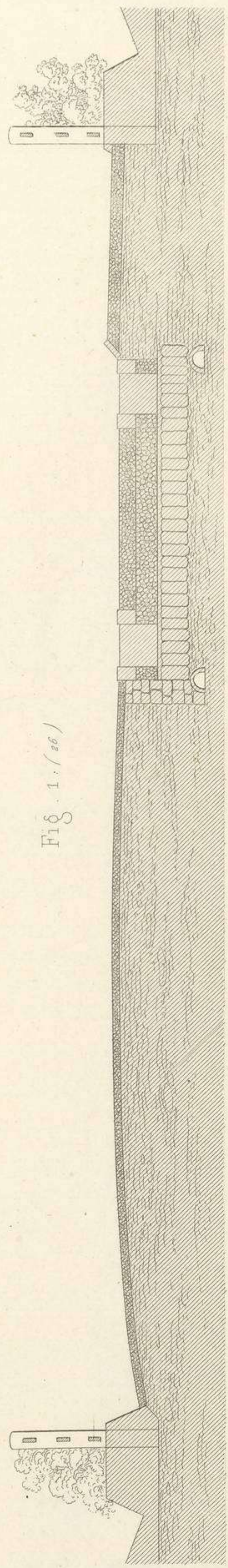

Fig. 1. (16)

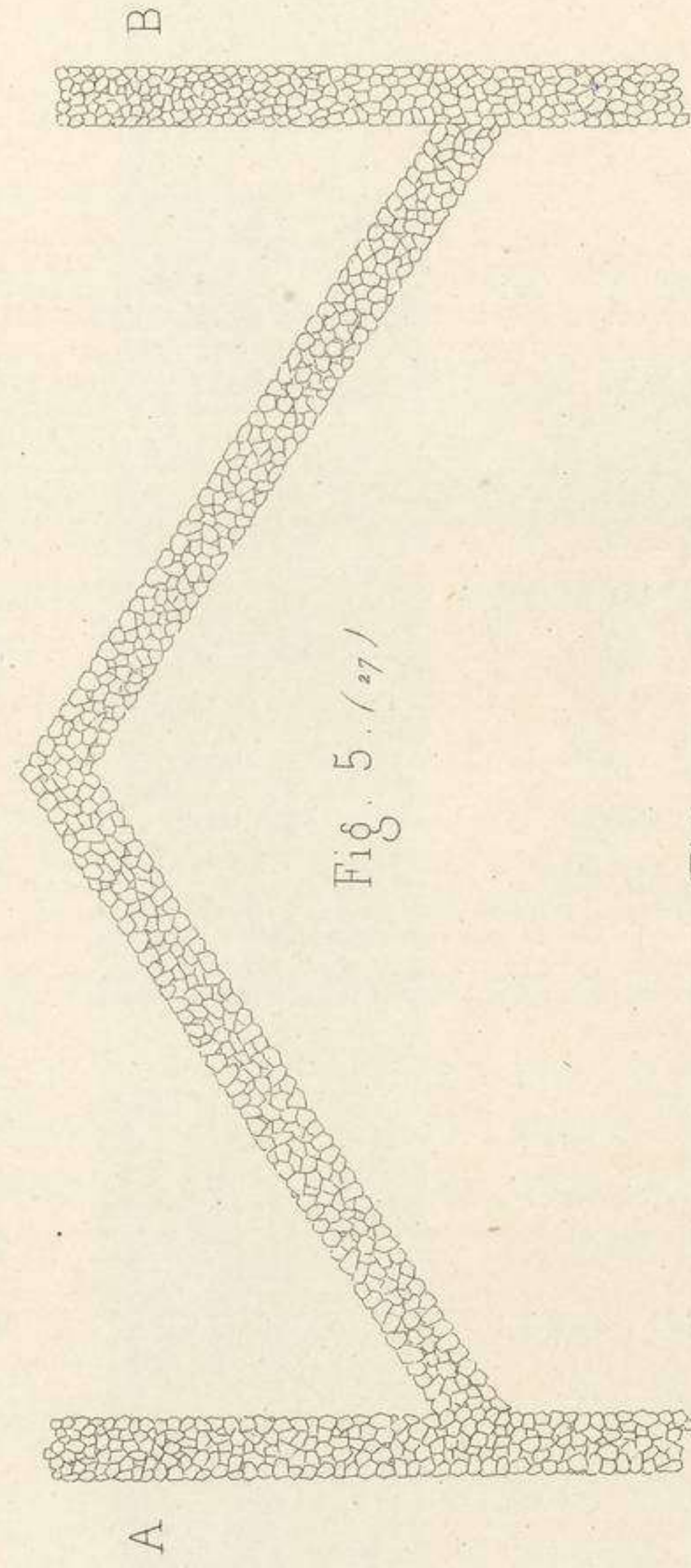

Fig. 5. (17)

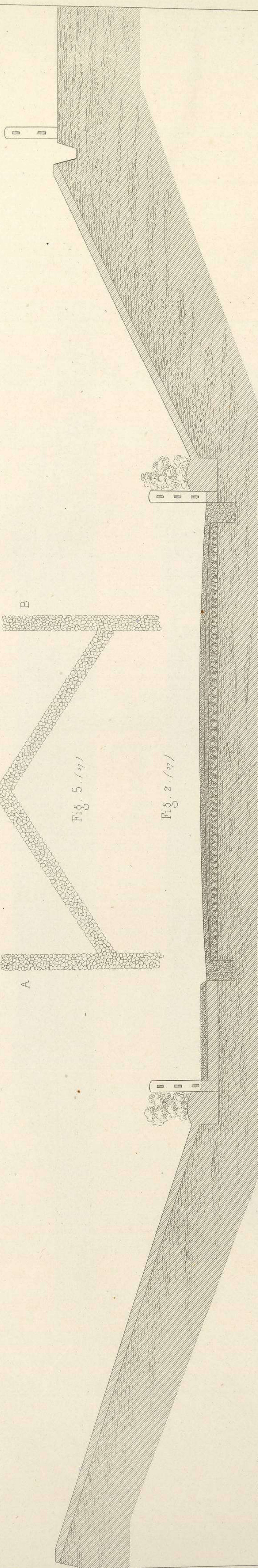

Fig. 2. (17)

Fig. 6. (17)

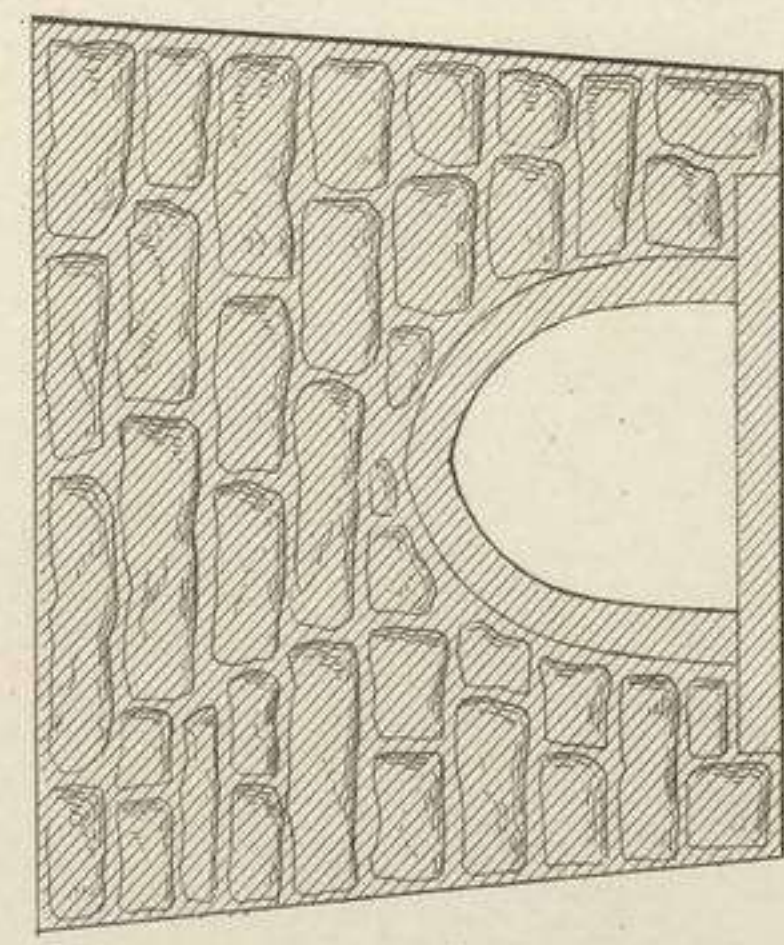

Fig. 7. (17)

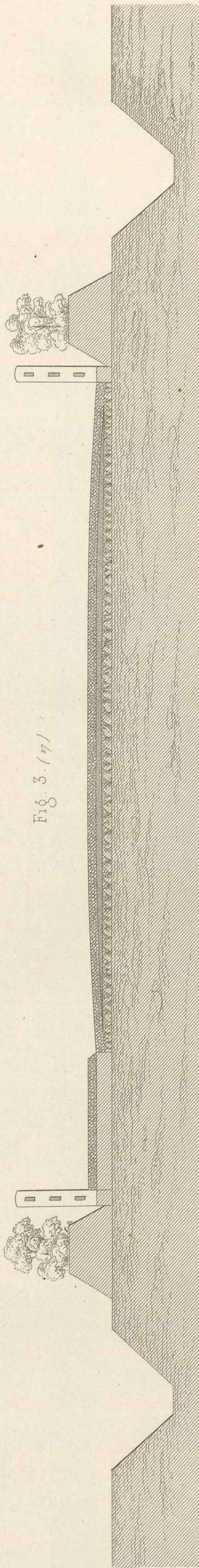
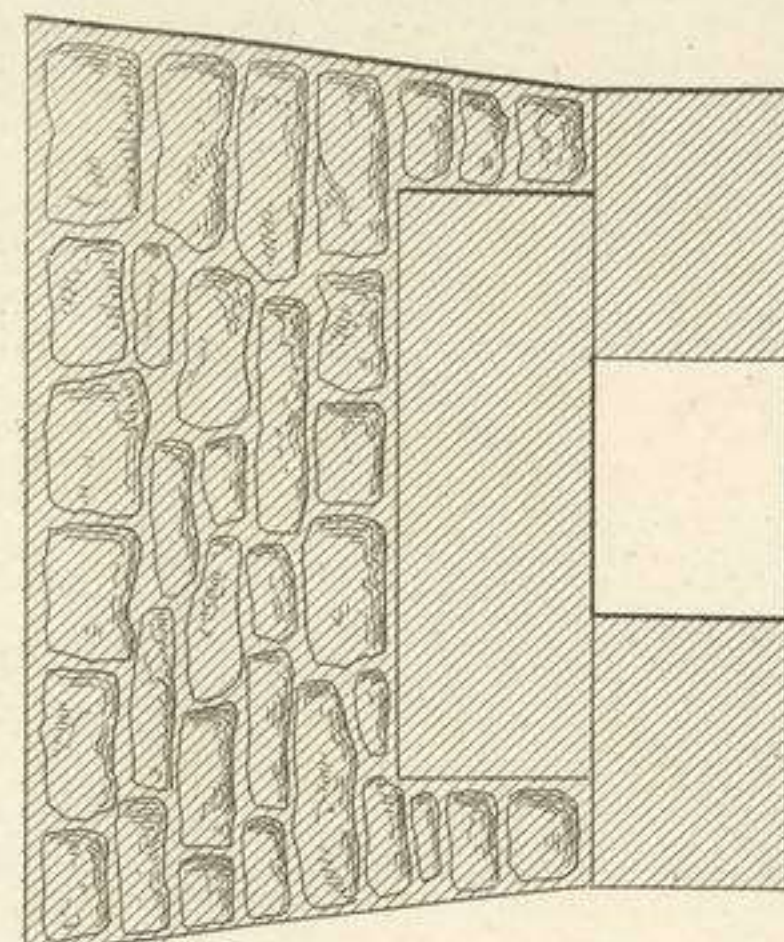

Fig. 3. (17)

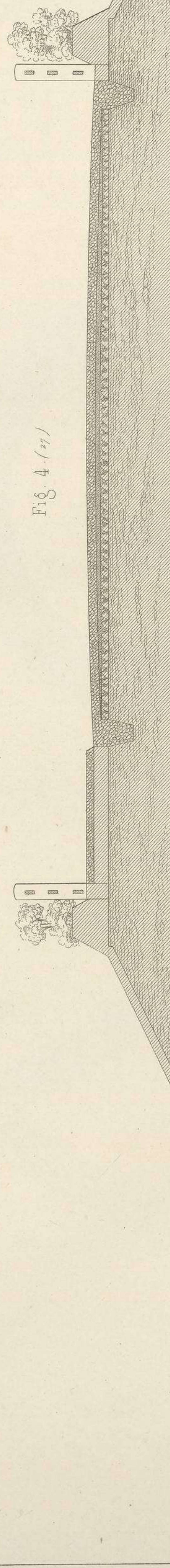
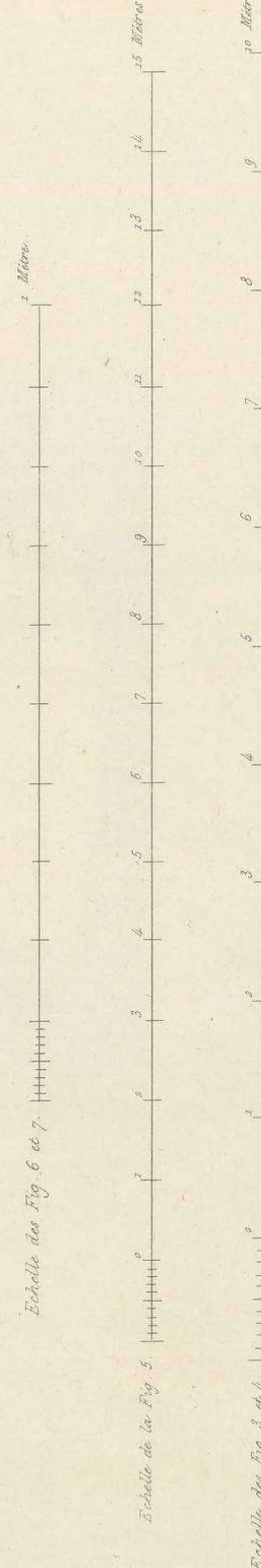

Fig. 4. (17)

Echelle des Fig. 6 et 7

Echelle de la Fig. 5

Echelle des Fig. 3 et 4



B. de V. del.

H. R.



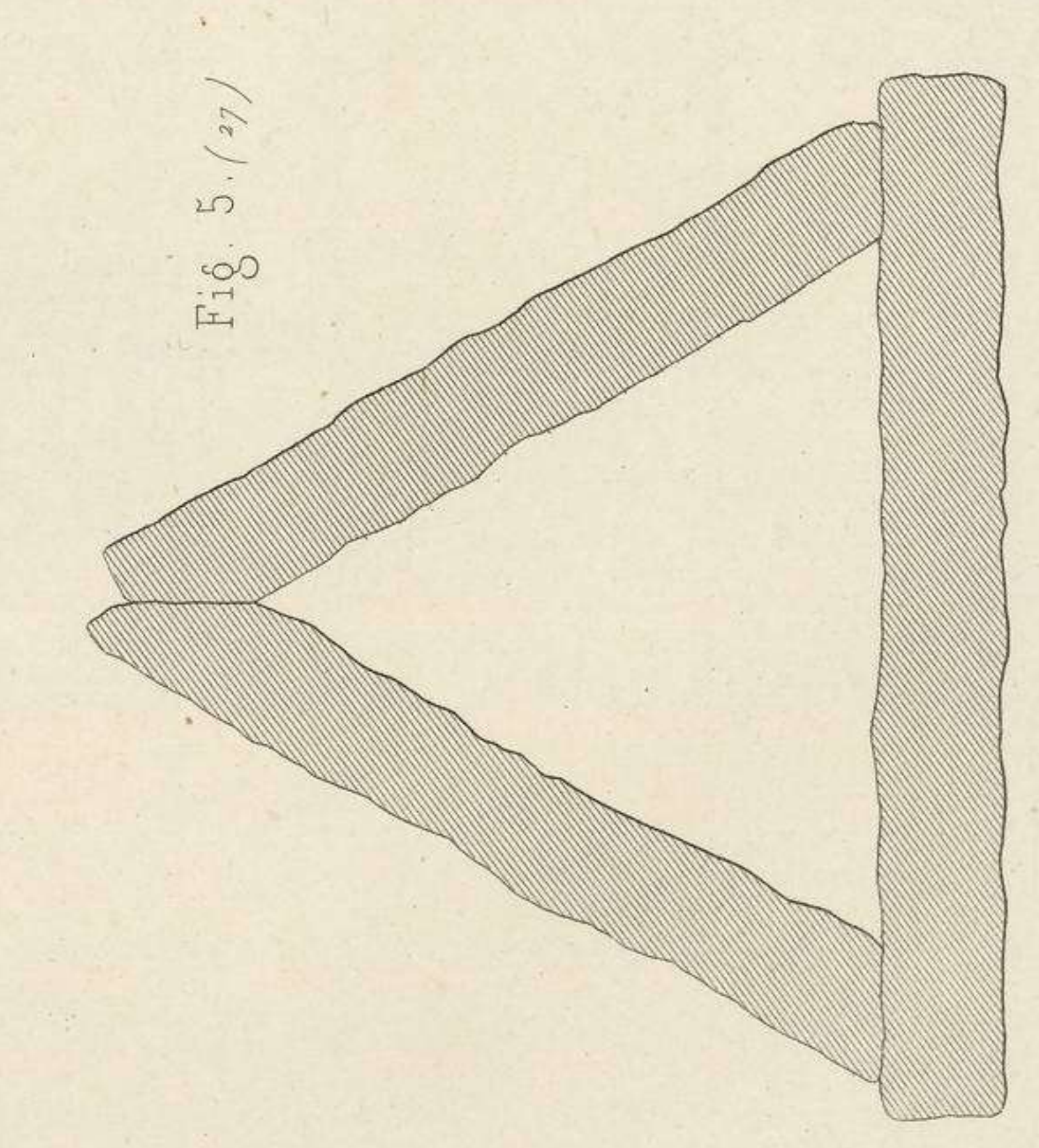
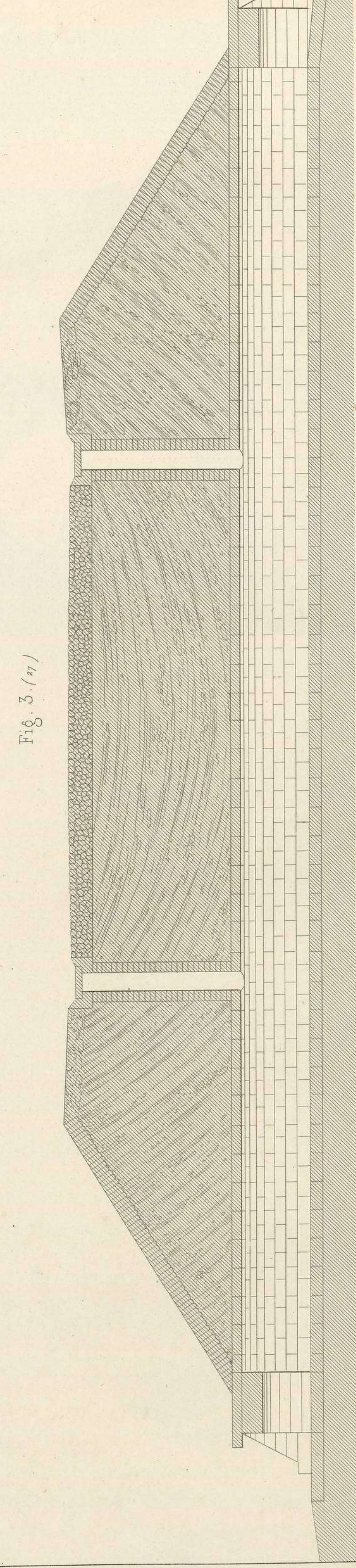
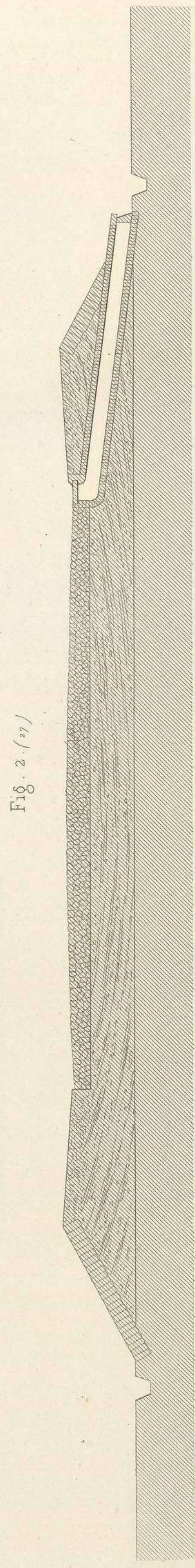
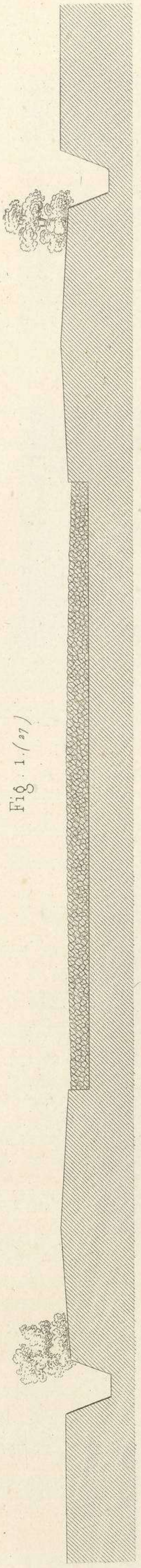

Echelle des Fig. 4, 5, 6.

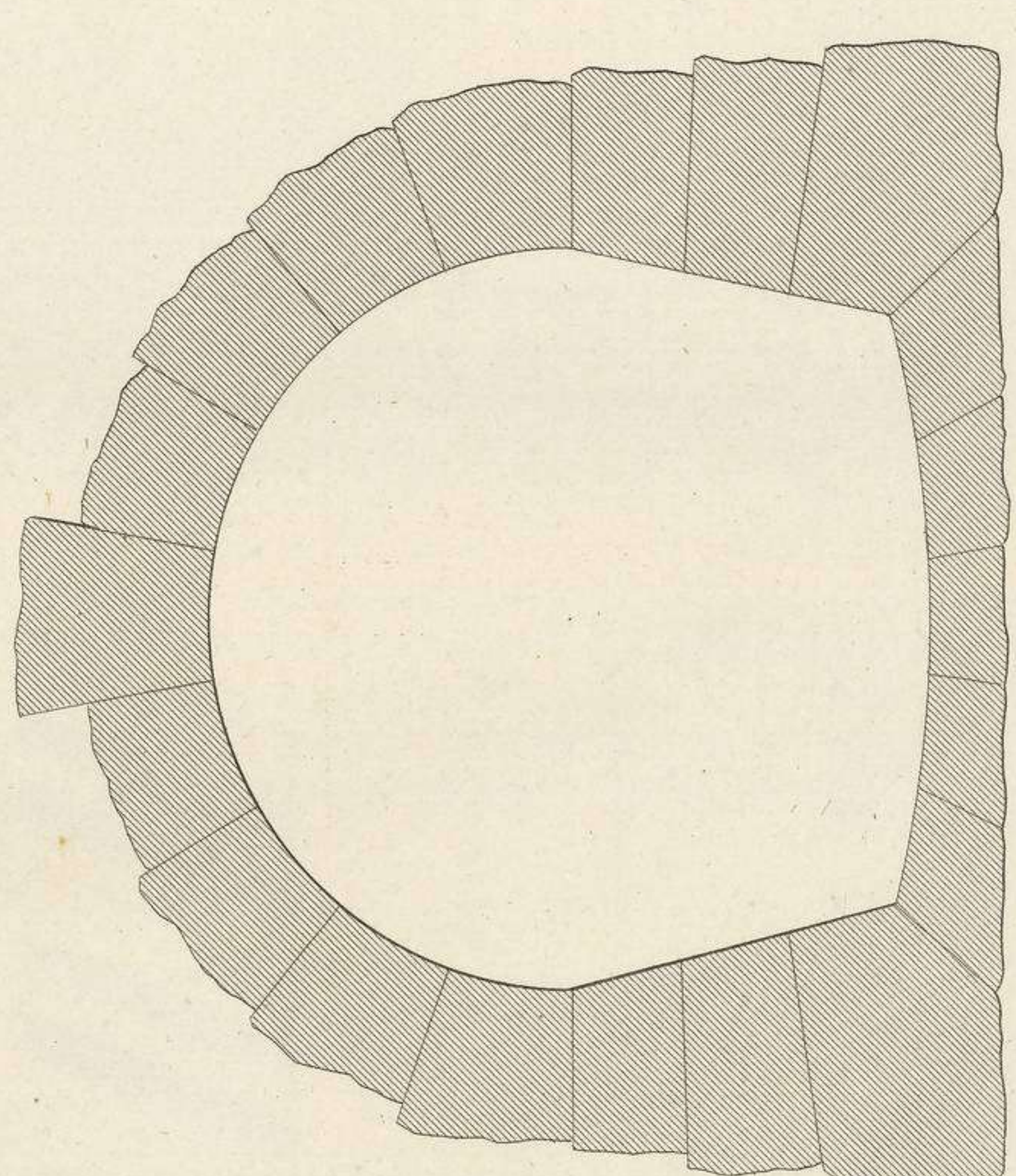

Echelle des Fig. 1, 2, 3.

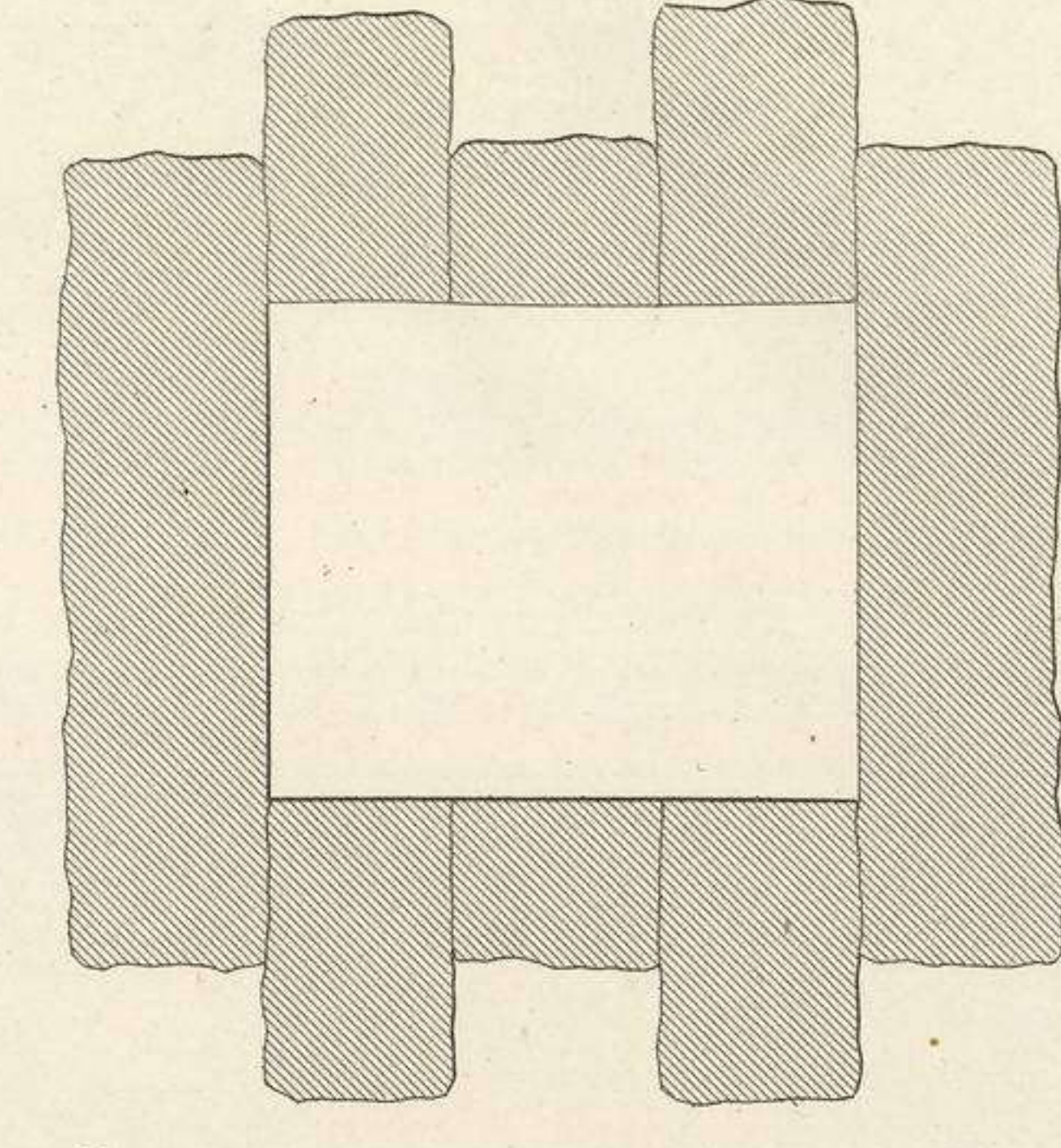

B. et V. del.

H. R.

MAÇONNERIE  
Voies publiques et grands Chemins.



Fig. 1. (29)

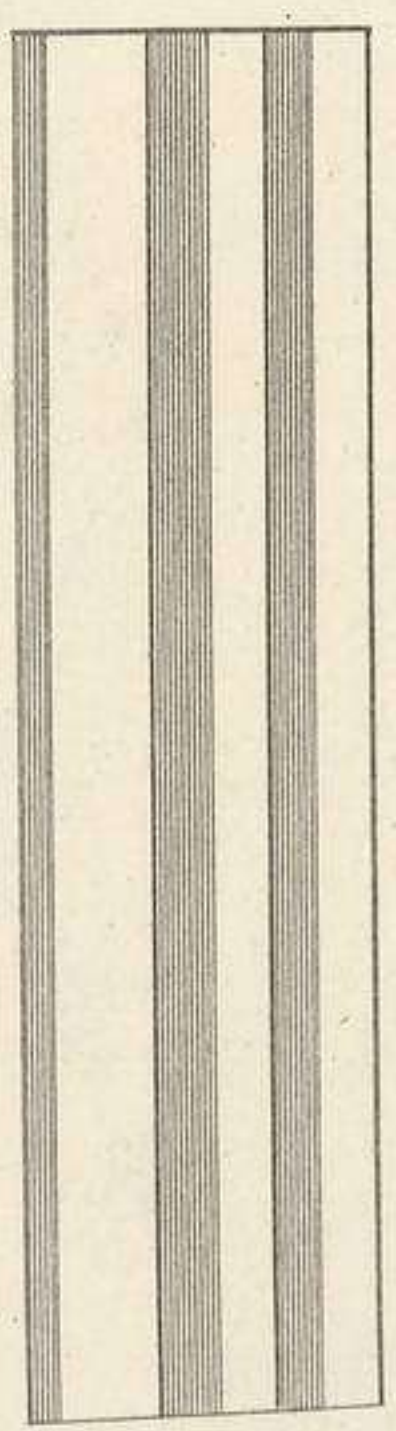

Fig. 2. (29)

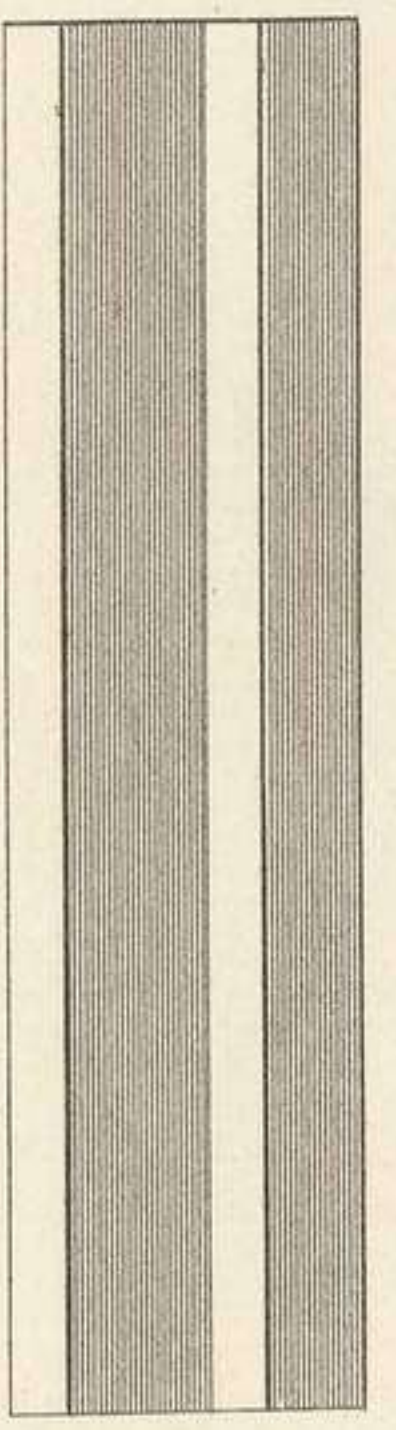

Fig. 4. (29)

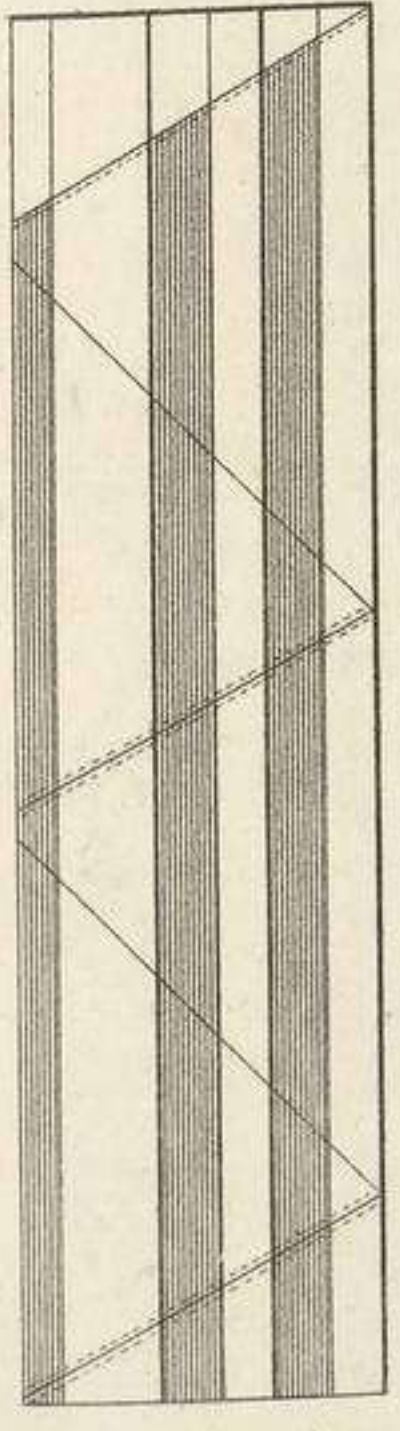

Fig. 5. (29)

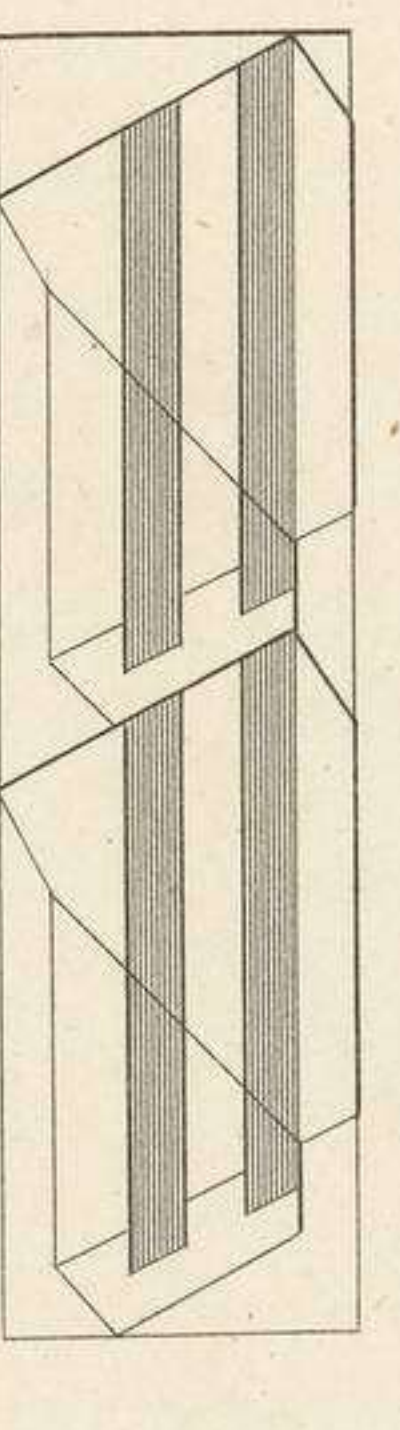

Fig. 6. (30)

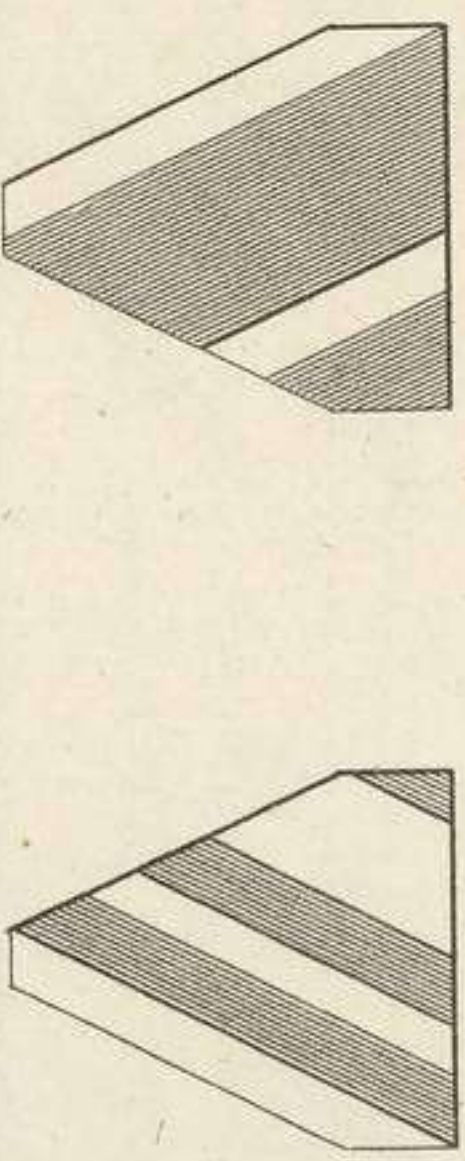

Fig. 7. (30)

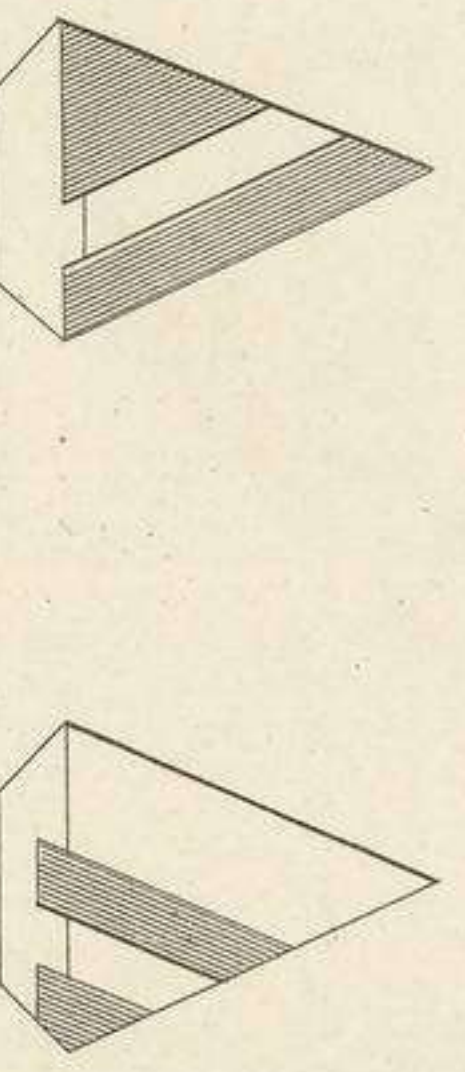

Fig. 8. (30)

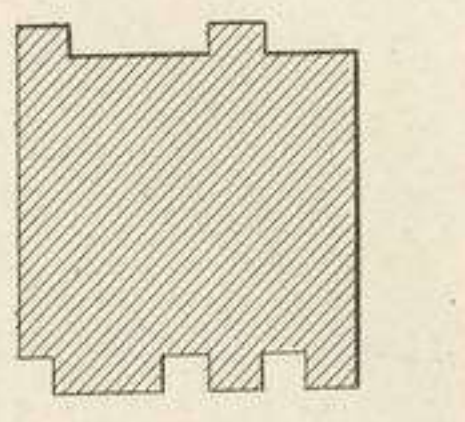

Fig. 9. (30)

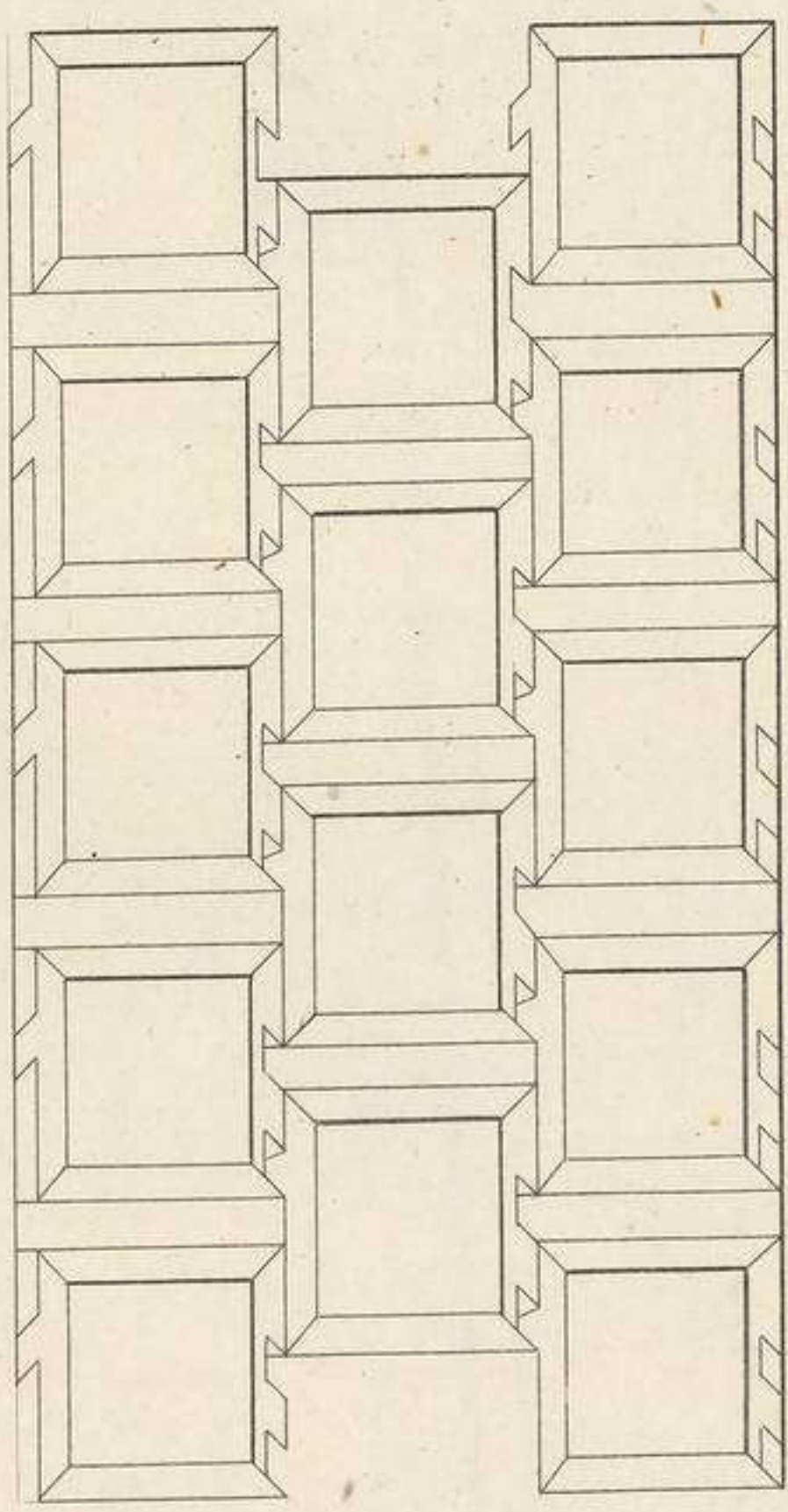

Fig. 10. (30)

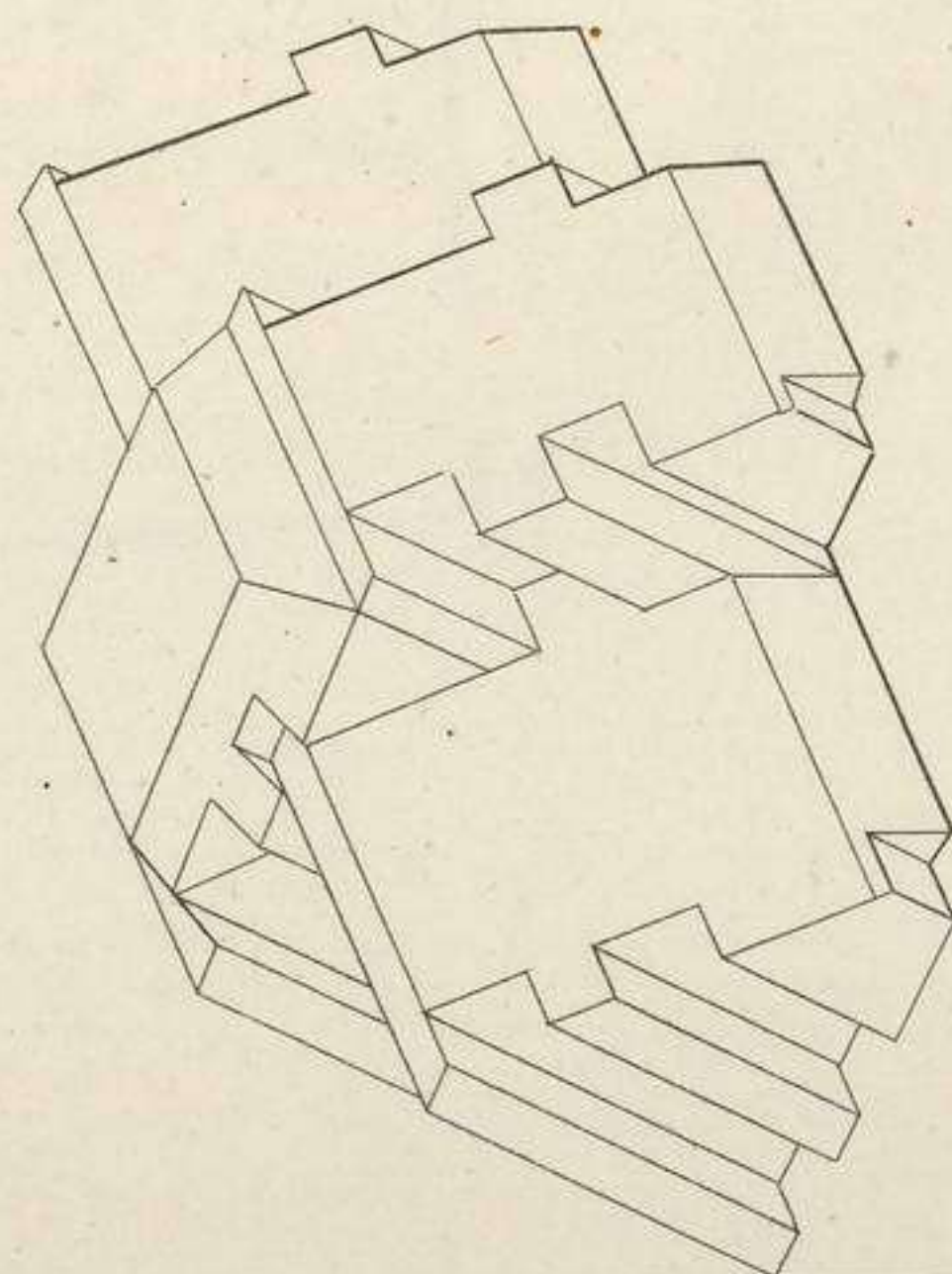

Fig. 8. (30)

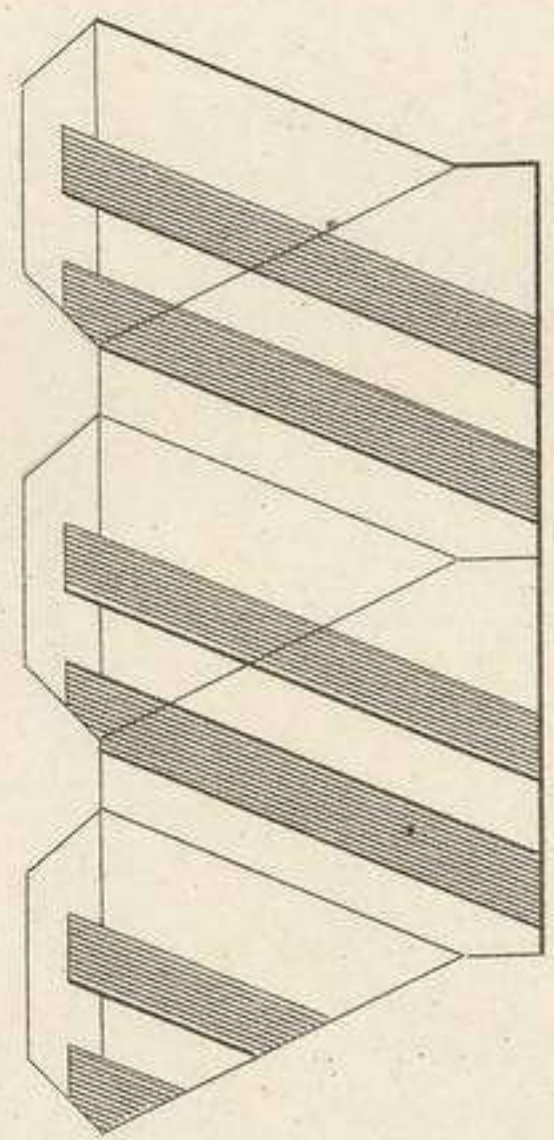

Fig. 12. (31)

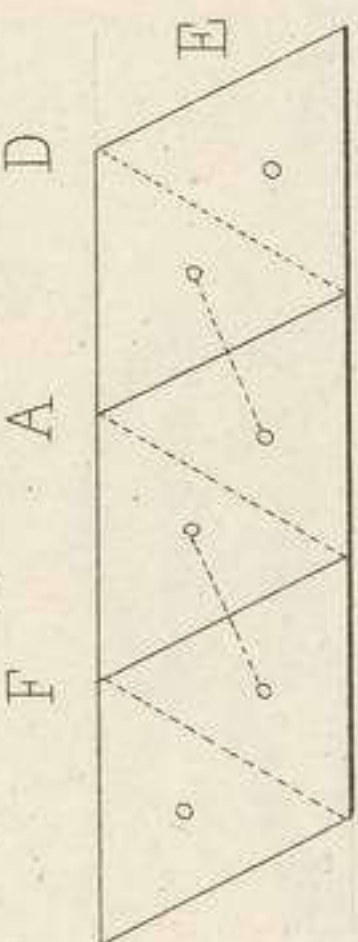

Fig. 11. (30)

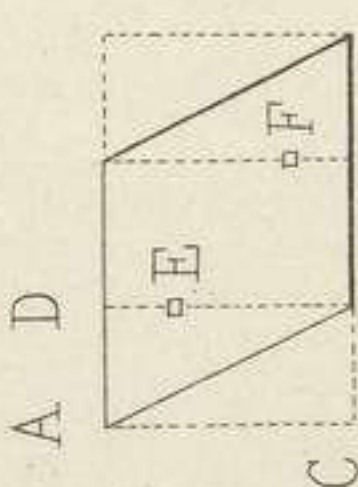

Fig. 13. (31)

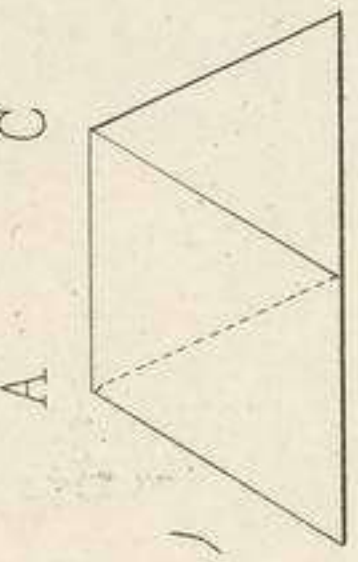

Fig. 14. (31)

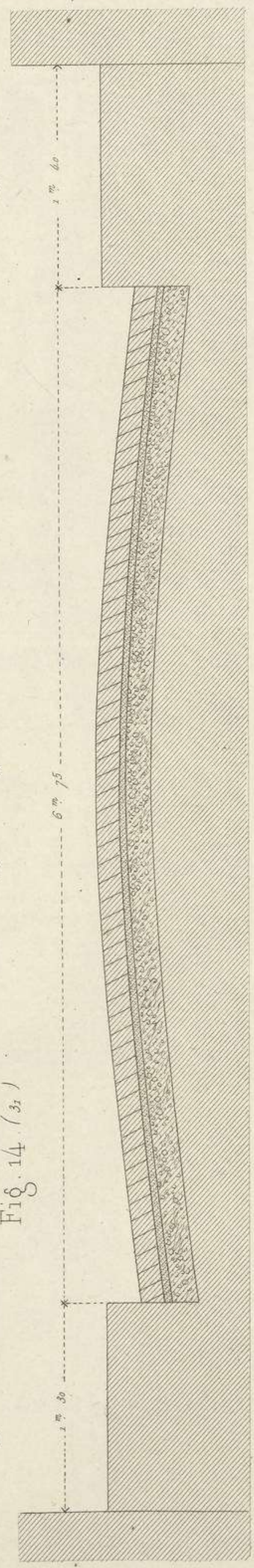

Fig. 15. (32)

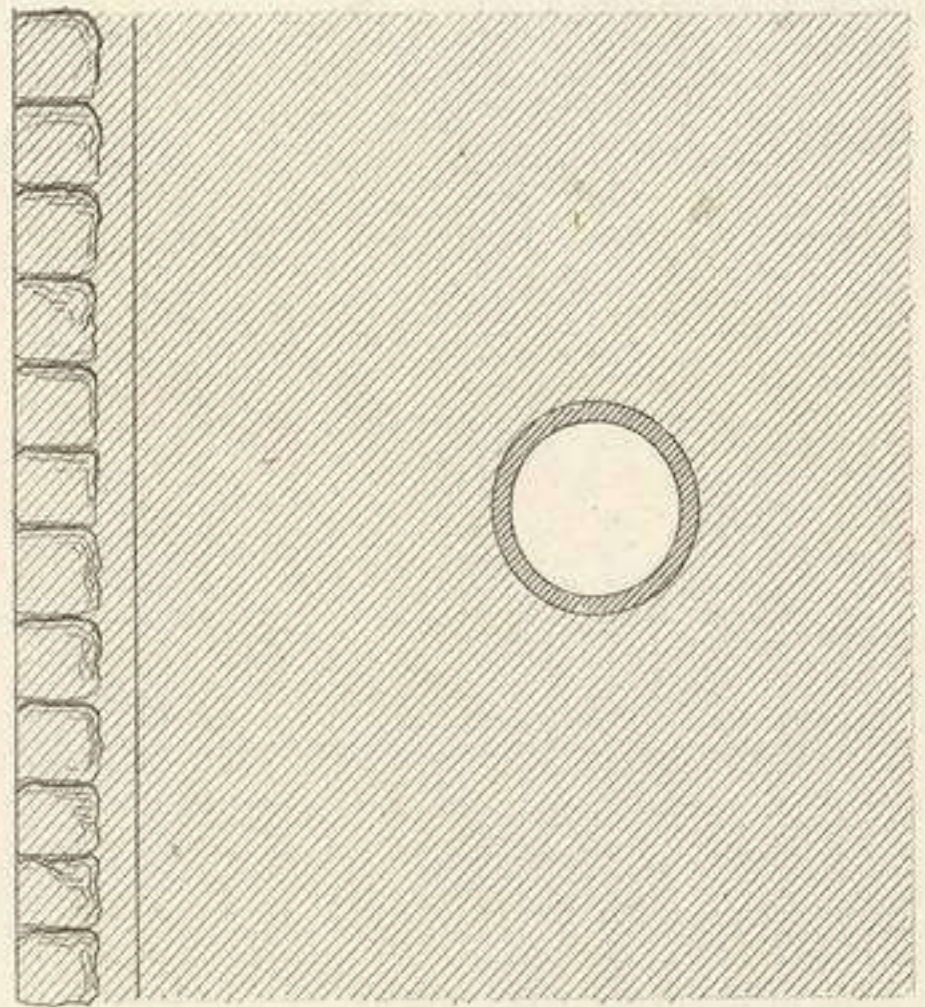

Fig. 16

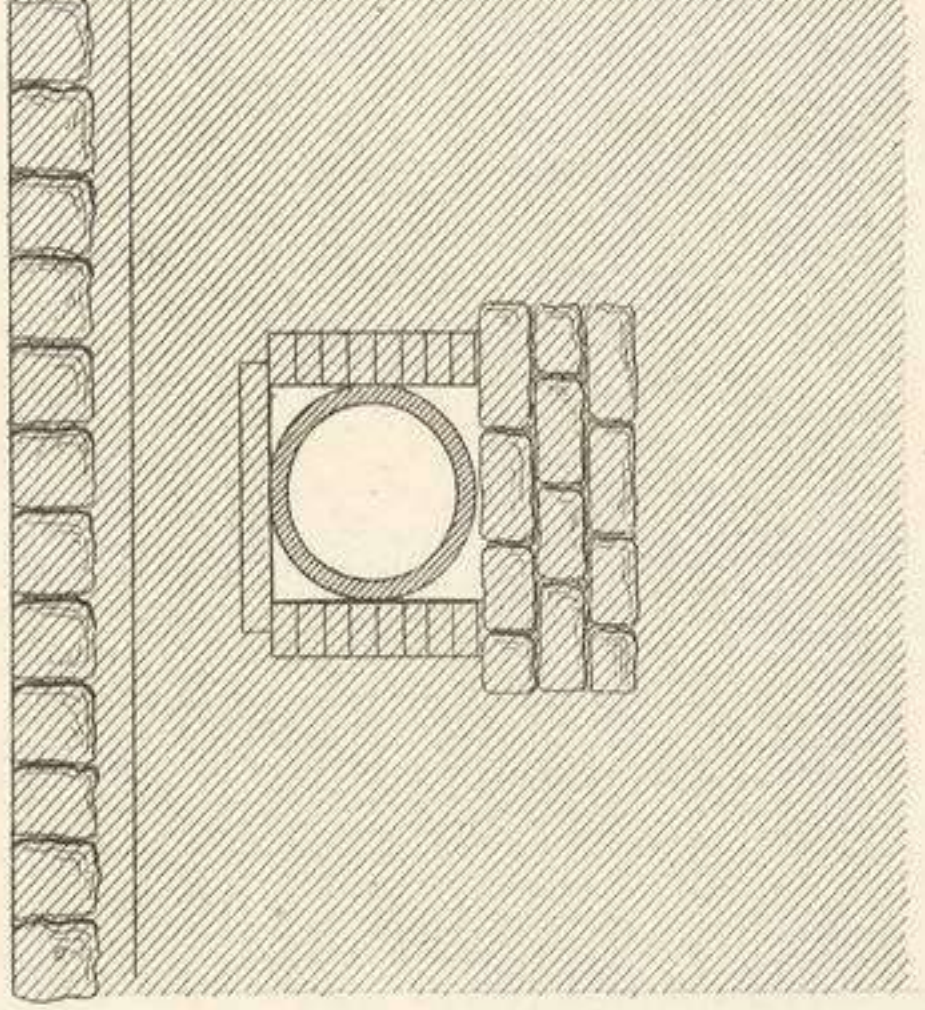

Fig. 18. (32, 34)

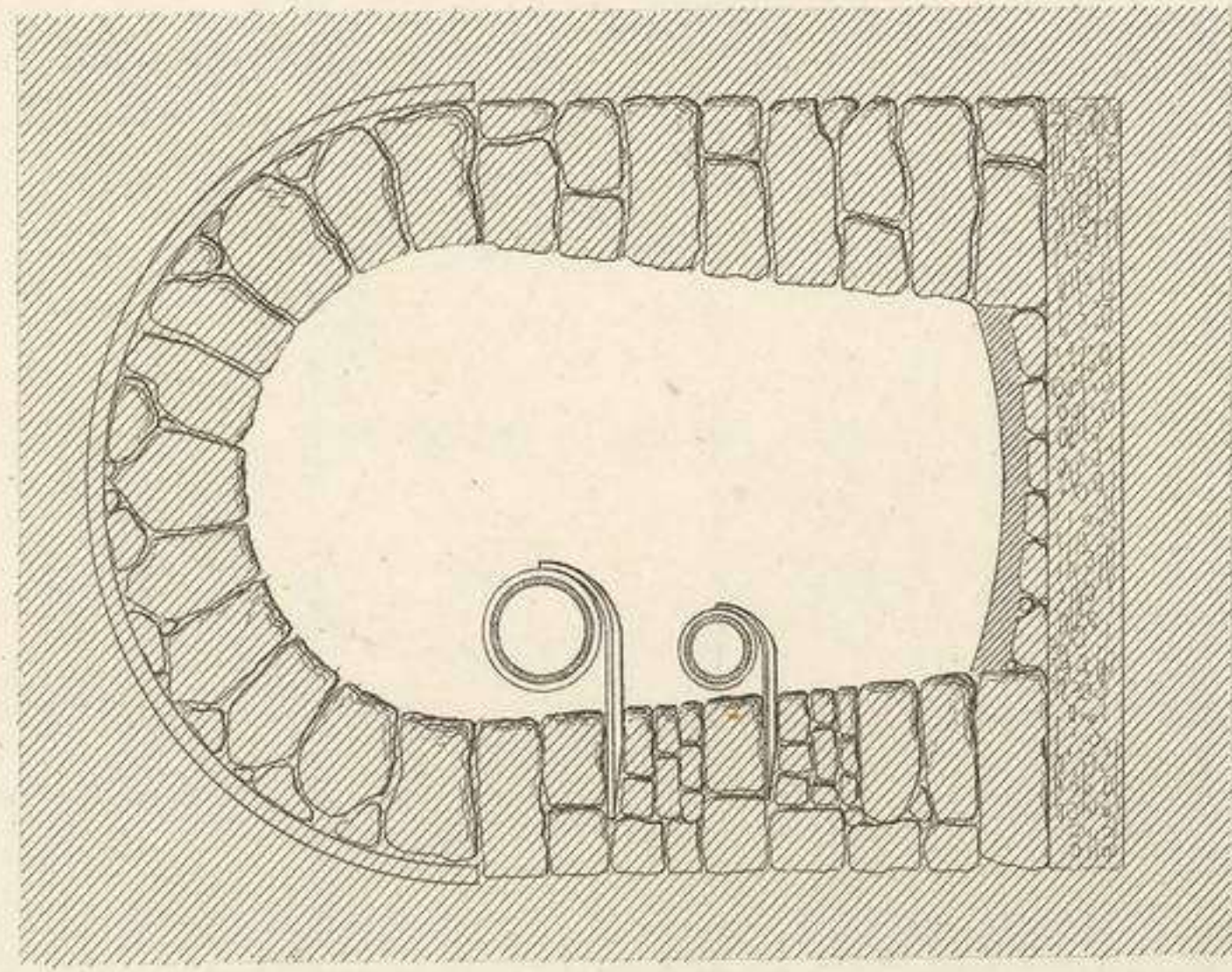

Fig. 17. (33)

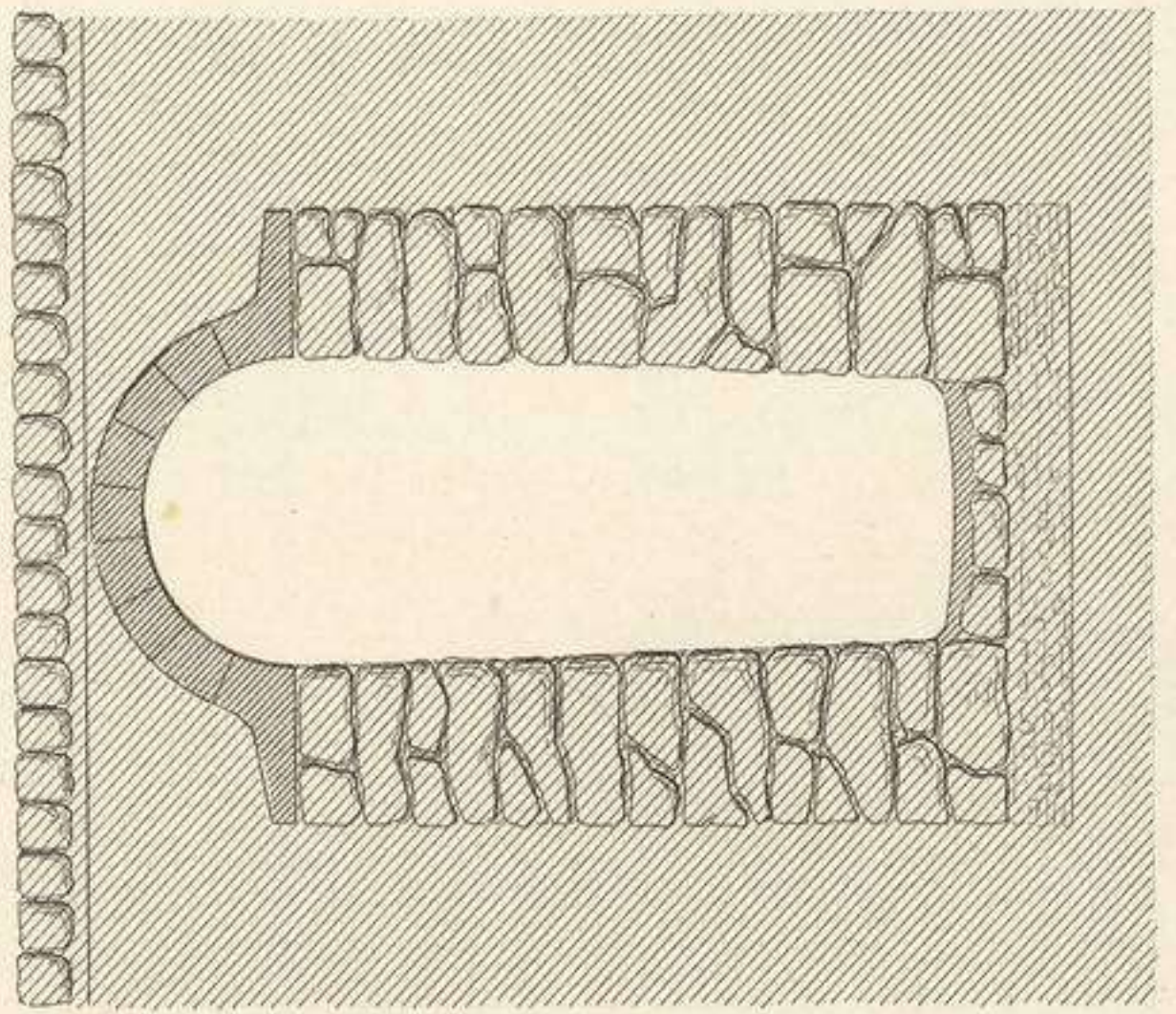

Fig. 20. (34)

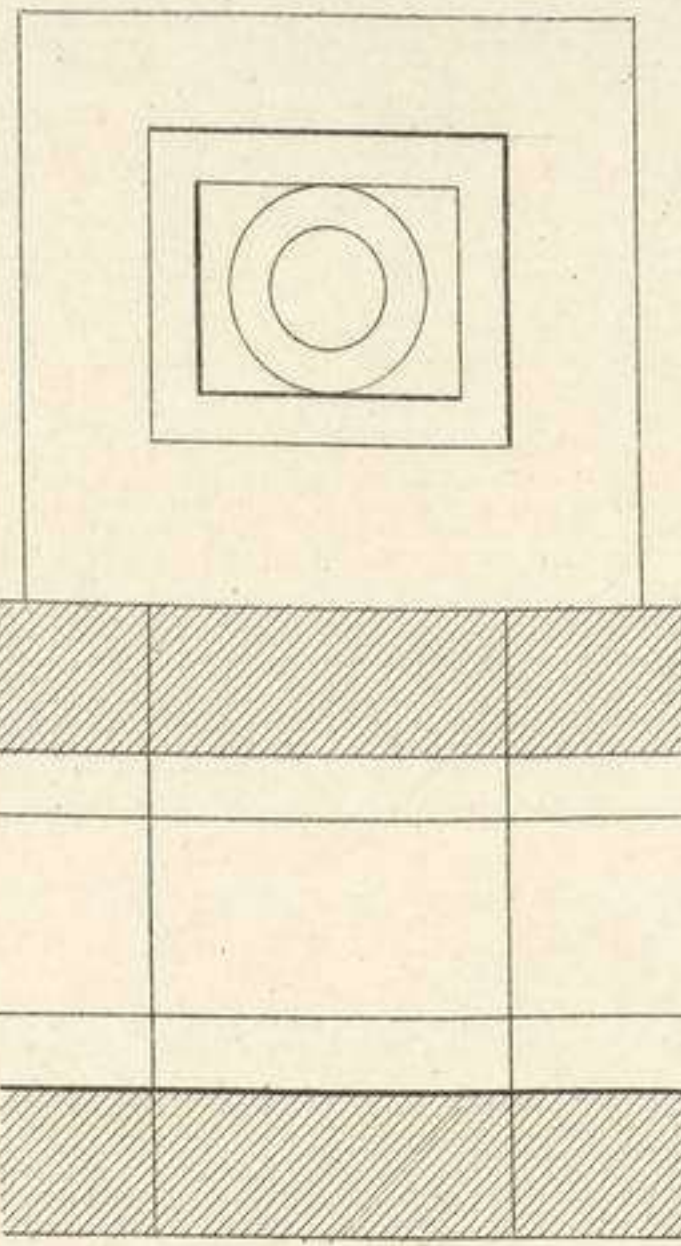

Fig. 19. (34)

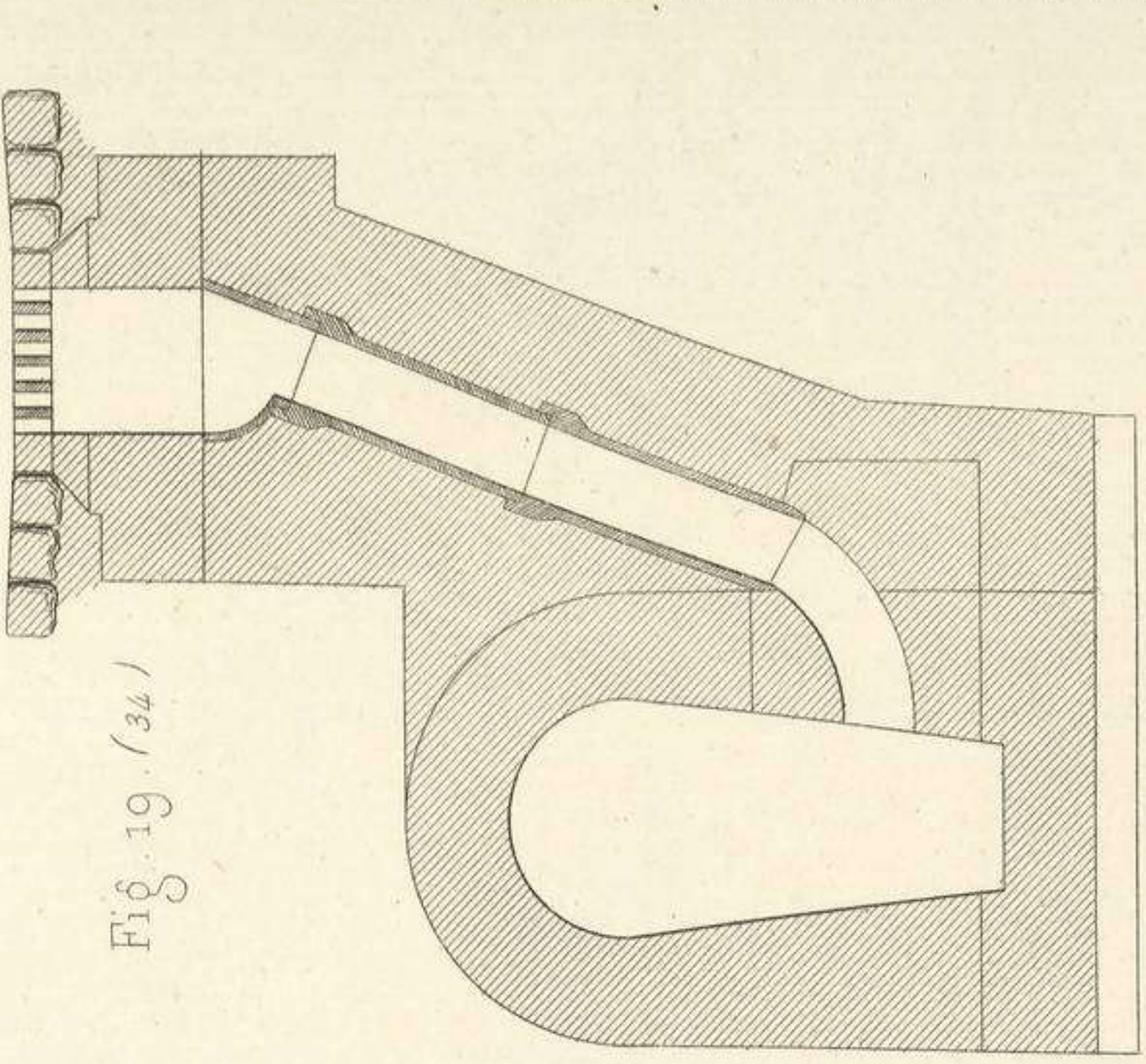

Fig. 21. (34)

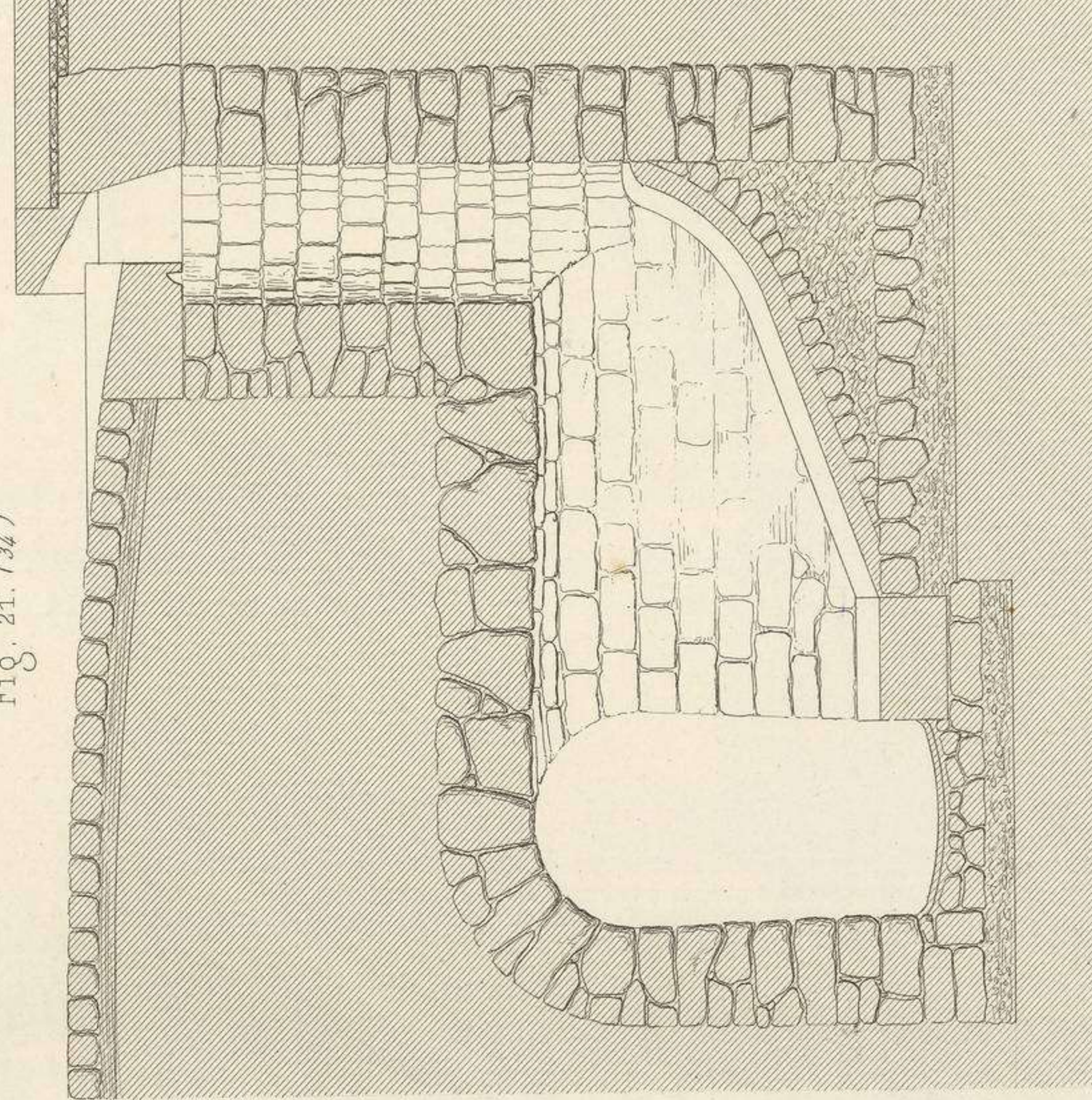
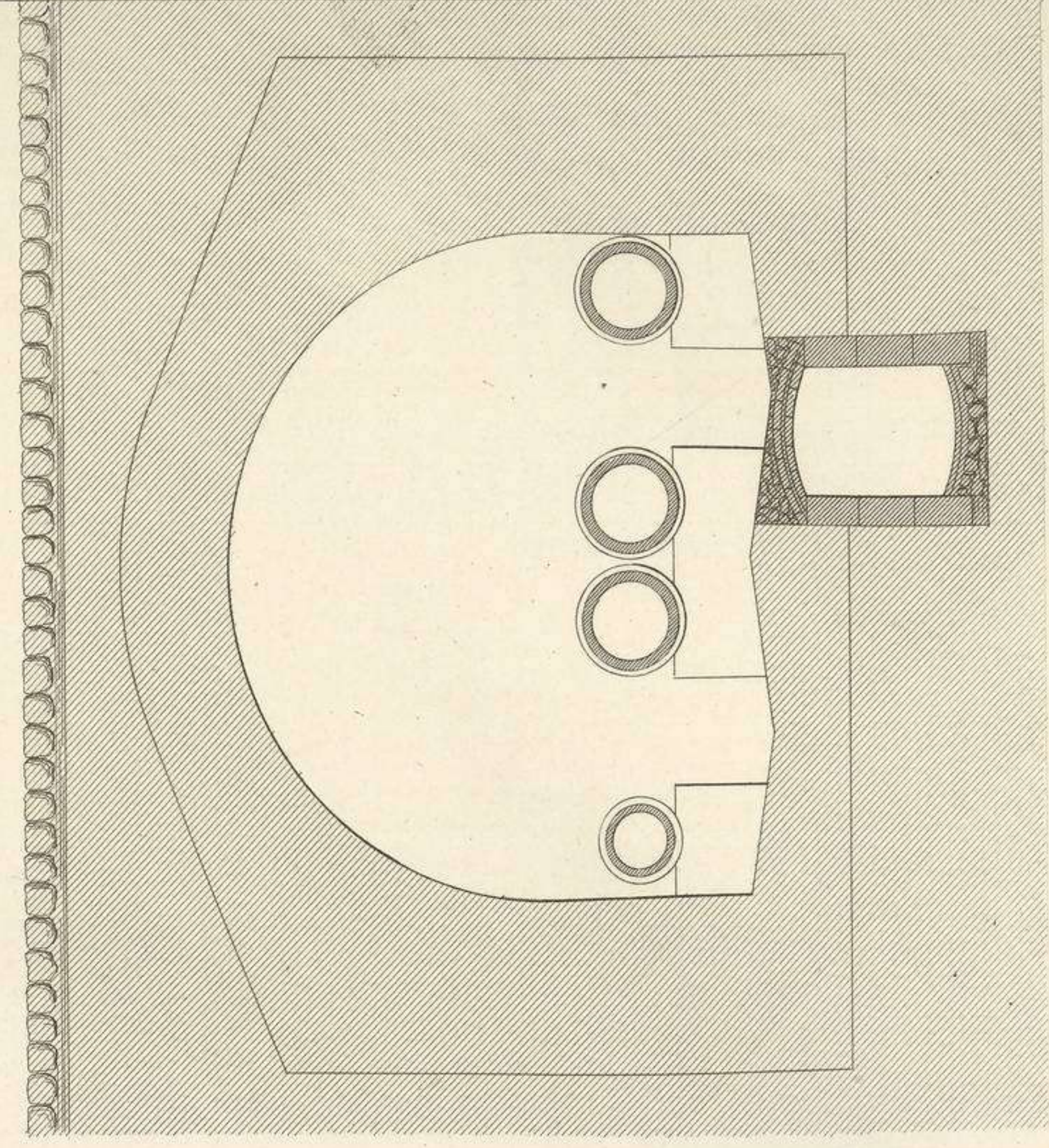

Fig. 22. (32, 34)



Echelle des Fig. 15, 16, 17, 18, 19, 20, 21, 22

Echelle des Fig. 1, 2, 3, 4, 5, 6, 7, 8, 9

Echelle des Fig. 11, 12, 13

1<sup>er</sup> Mètre

1<sup>er</sup> Mètre

1<sup>er</sup> Mètre

1<sup>er</sup> Mètre

1<sup>er</sup> Mètre

B. et V. del.

H. R.

MAÇONNERIE  
Voies publiques et grands Chemins



Fig. 3. (55.)

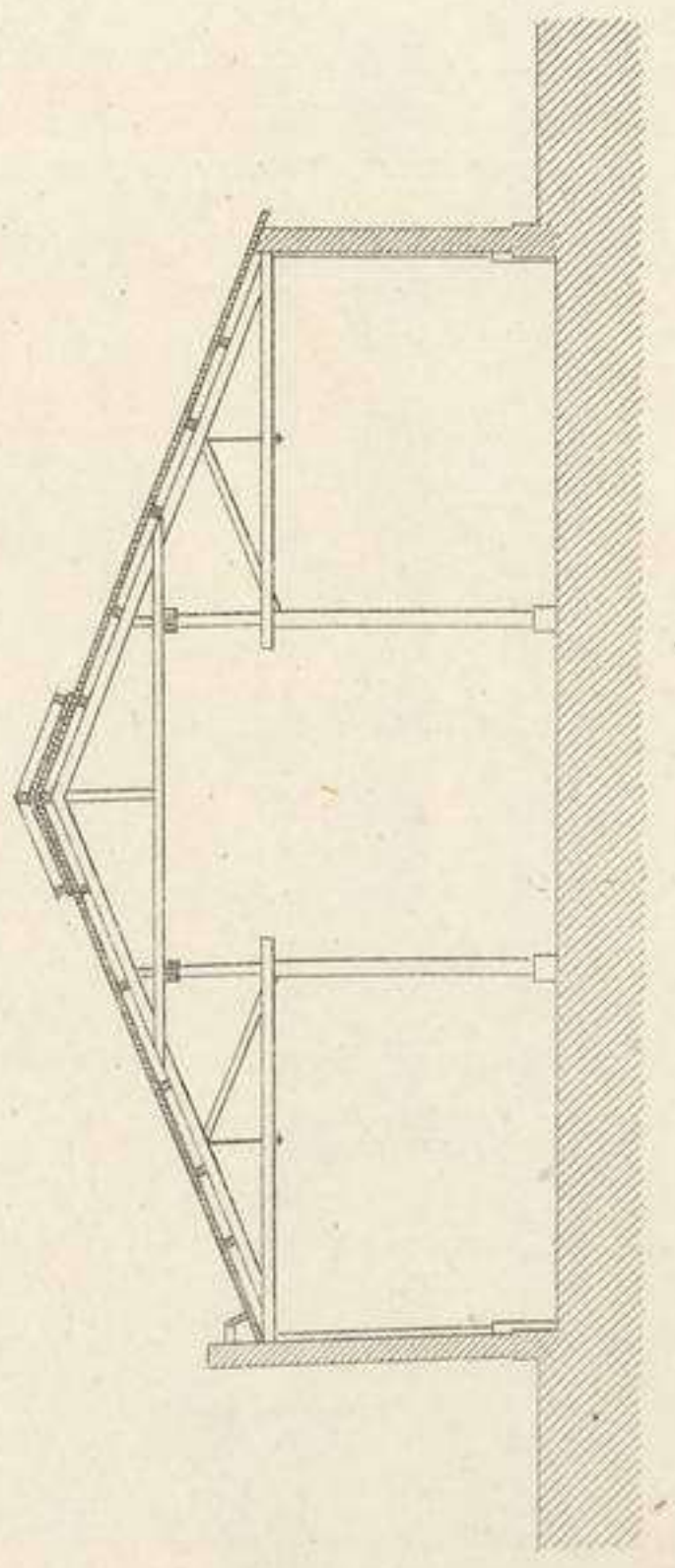

Fig. 4. (55.)

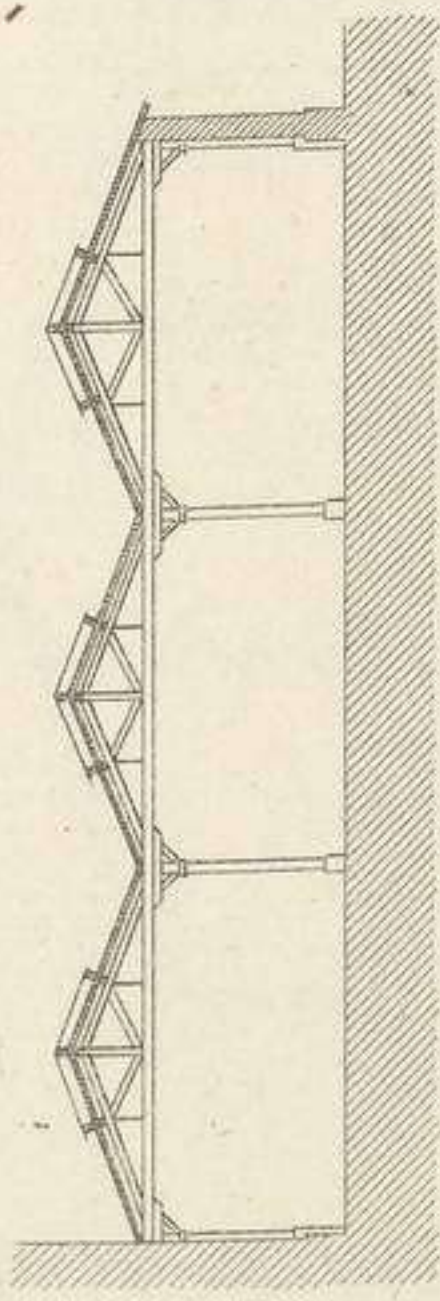

Fig. 2. (55.)

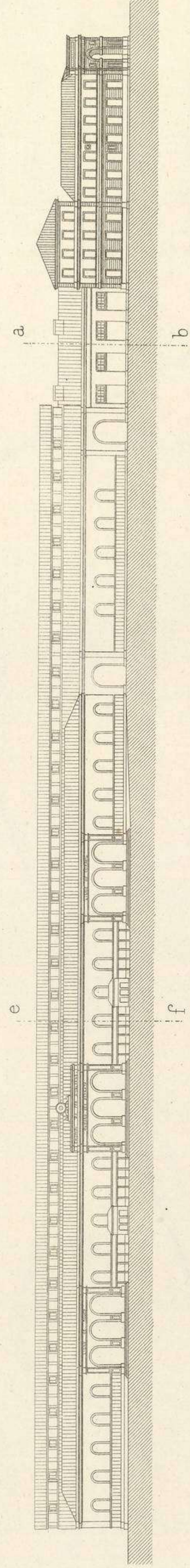

Fig. 5. (55.)

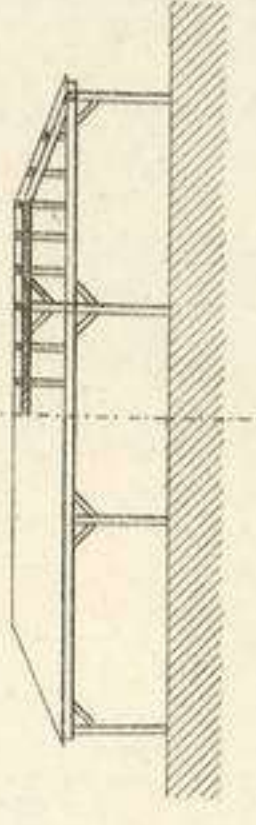

Fig. 6. (55.)

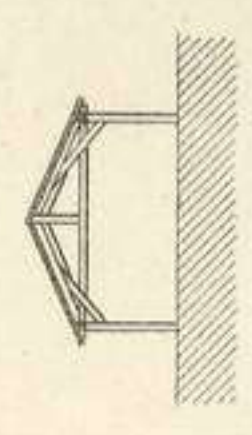

Fig. 1. (55.)

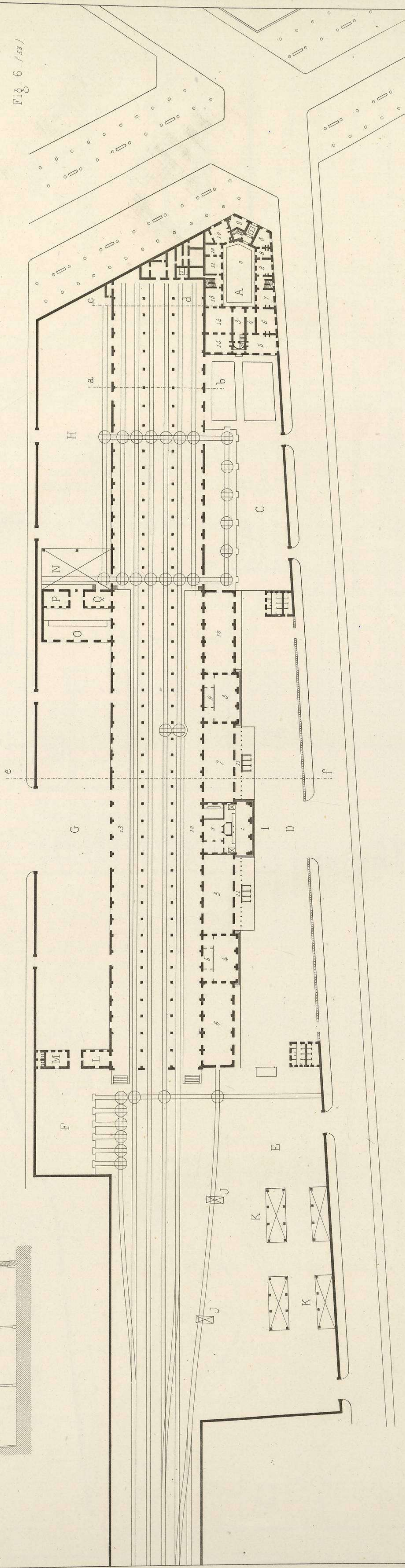

Fig. 7. (55.)

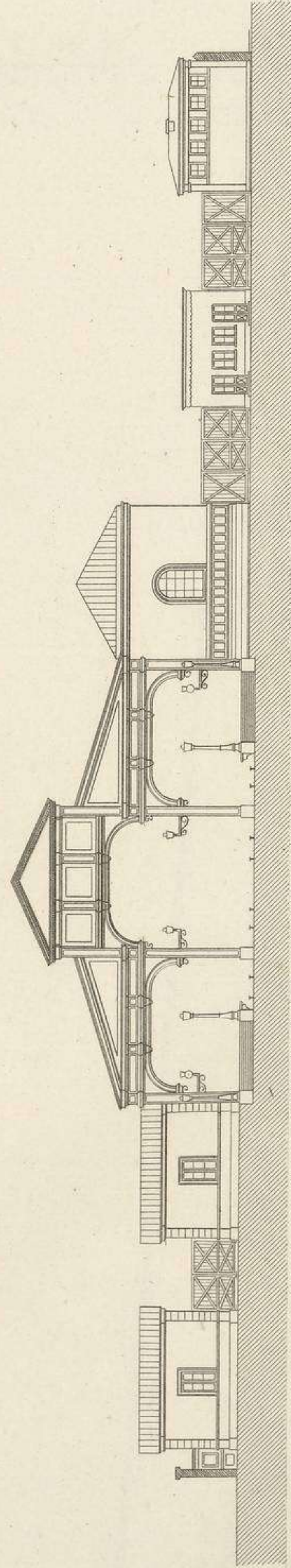

Fig. 8. (55.)

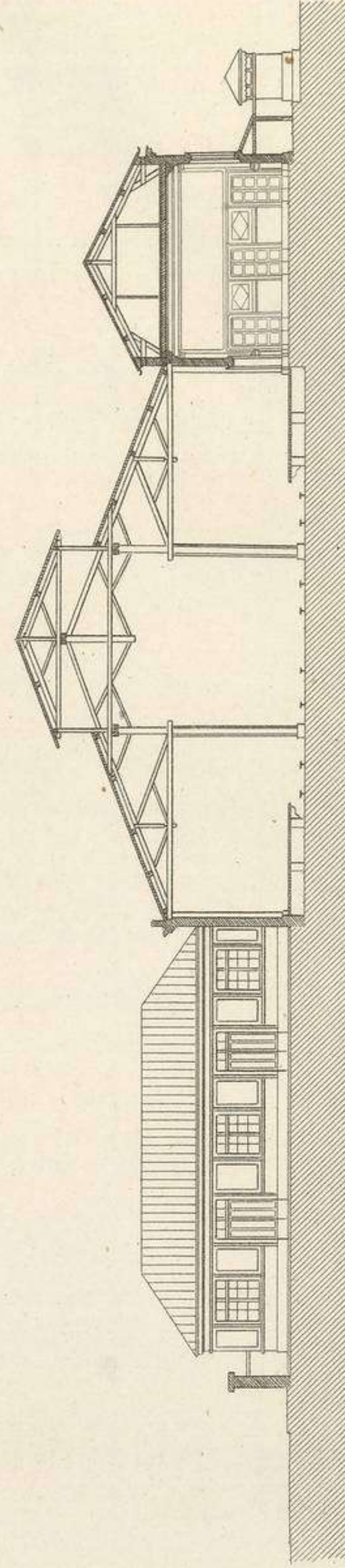
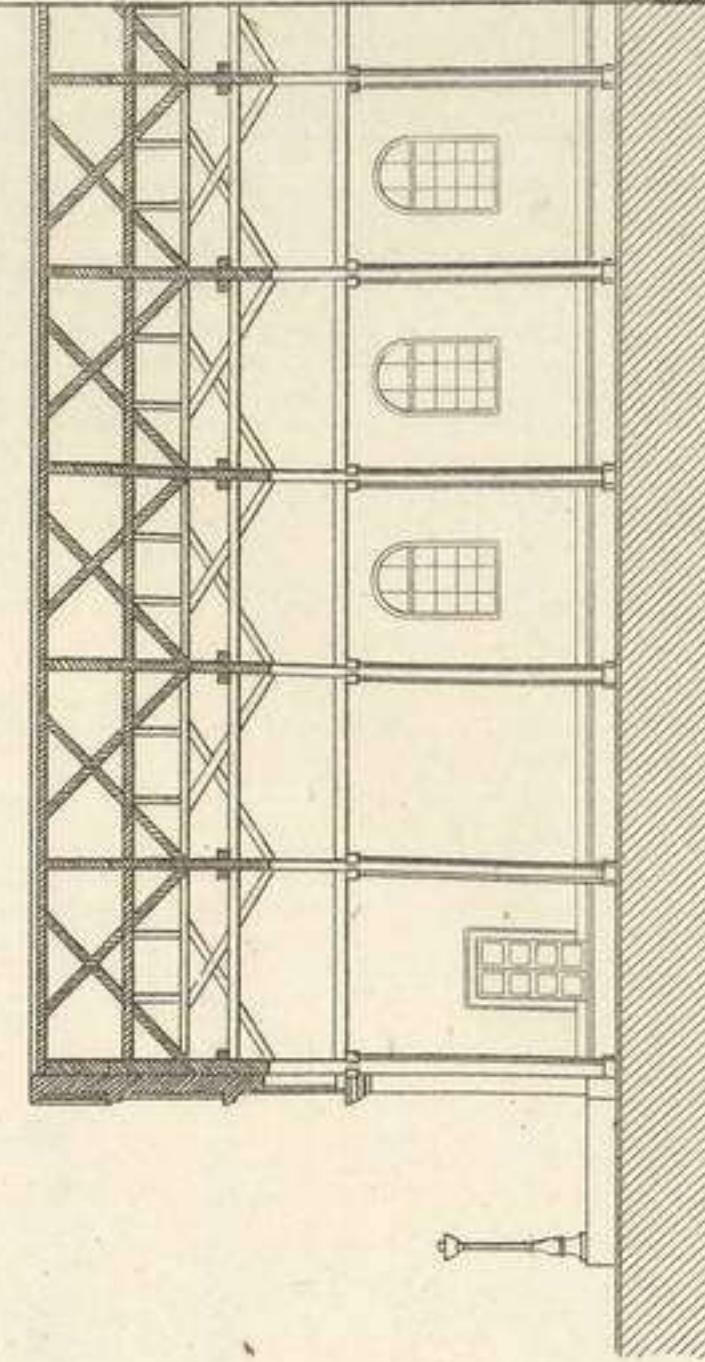

Fig. 9. (55.)



Echelle des Fig. 1 et 2.





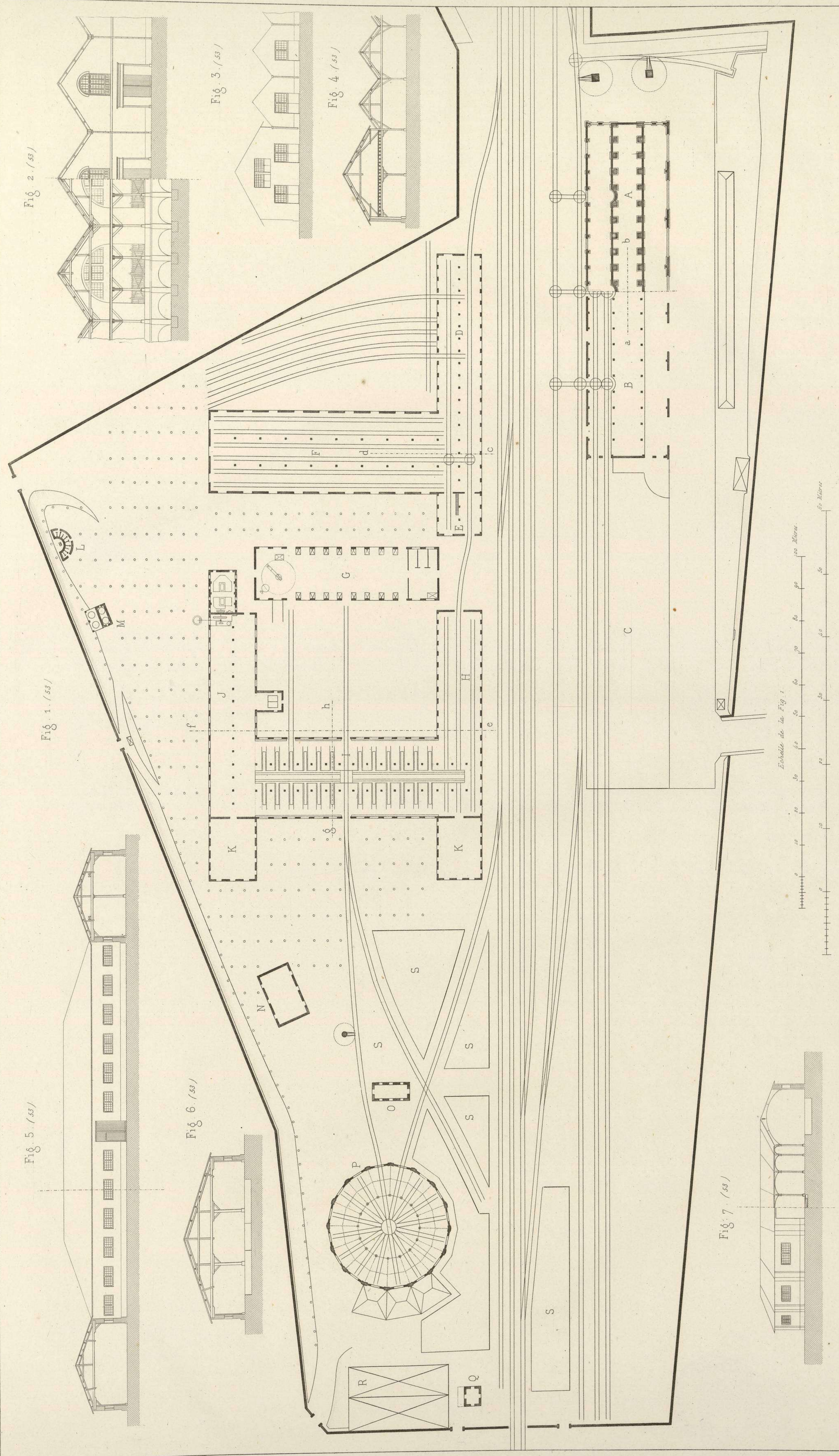

H. R.

B. et V. del.



Pl. 17 (T. 3, P. 54.)

Fig. 10. (56)

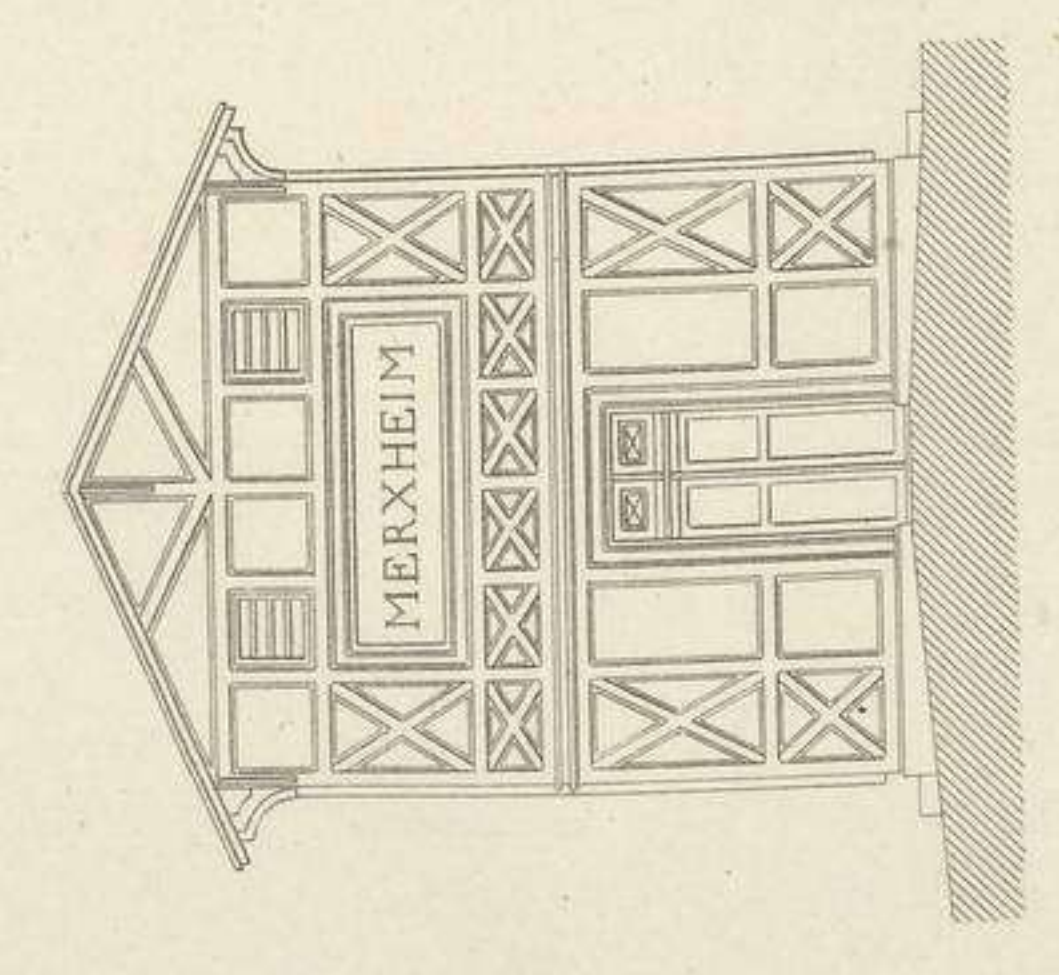

Fig. 11. (56)

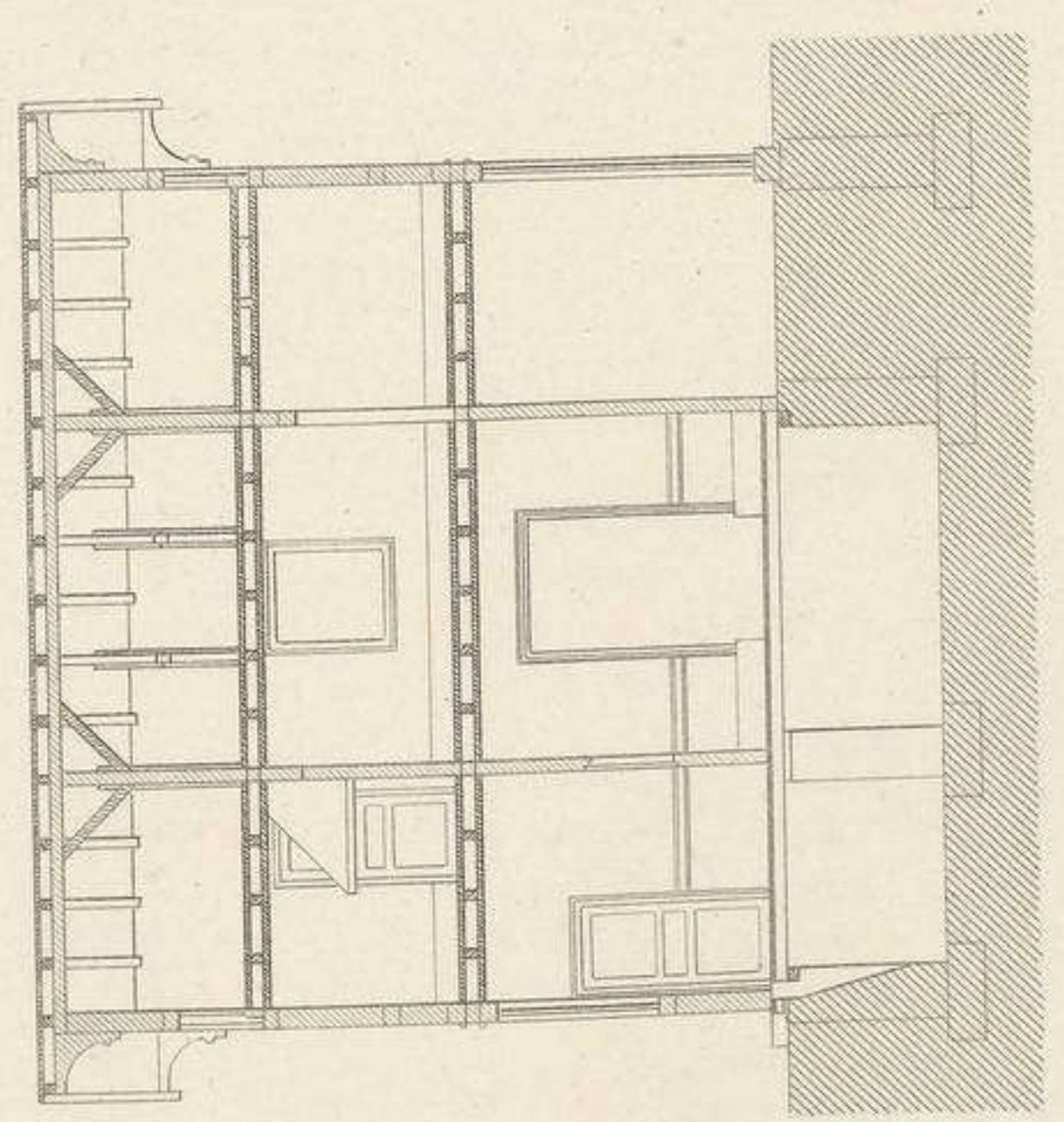

Fig. 4. (55)

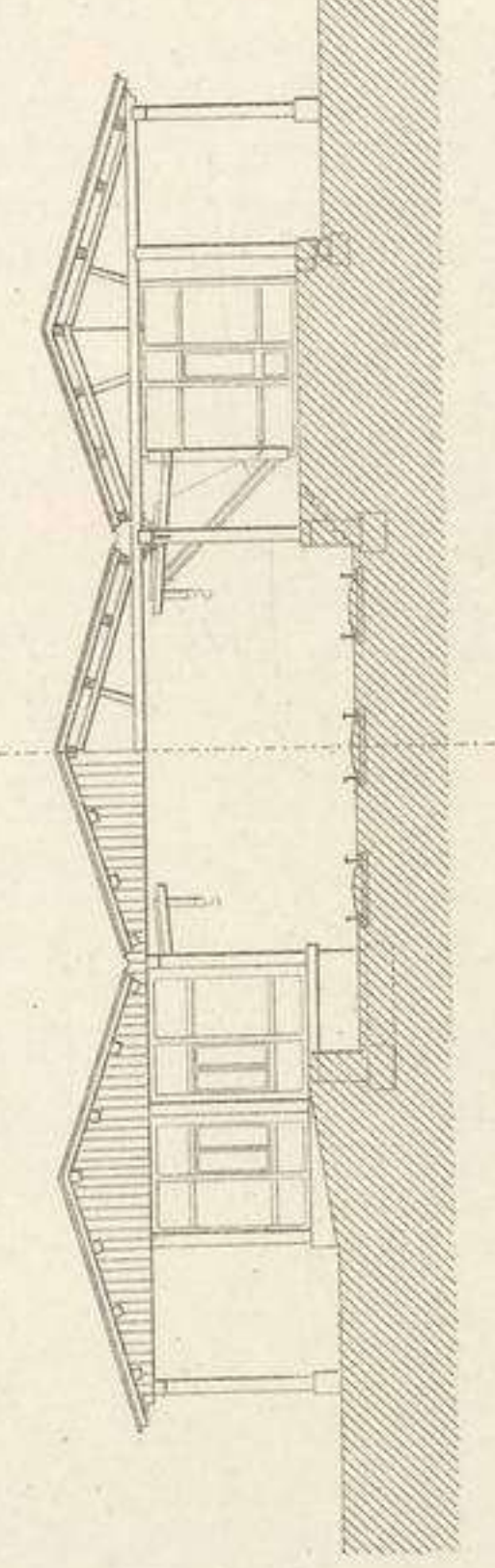

Fig. 5. (55)

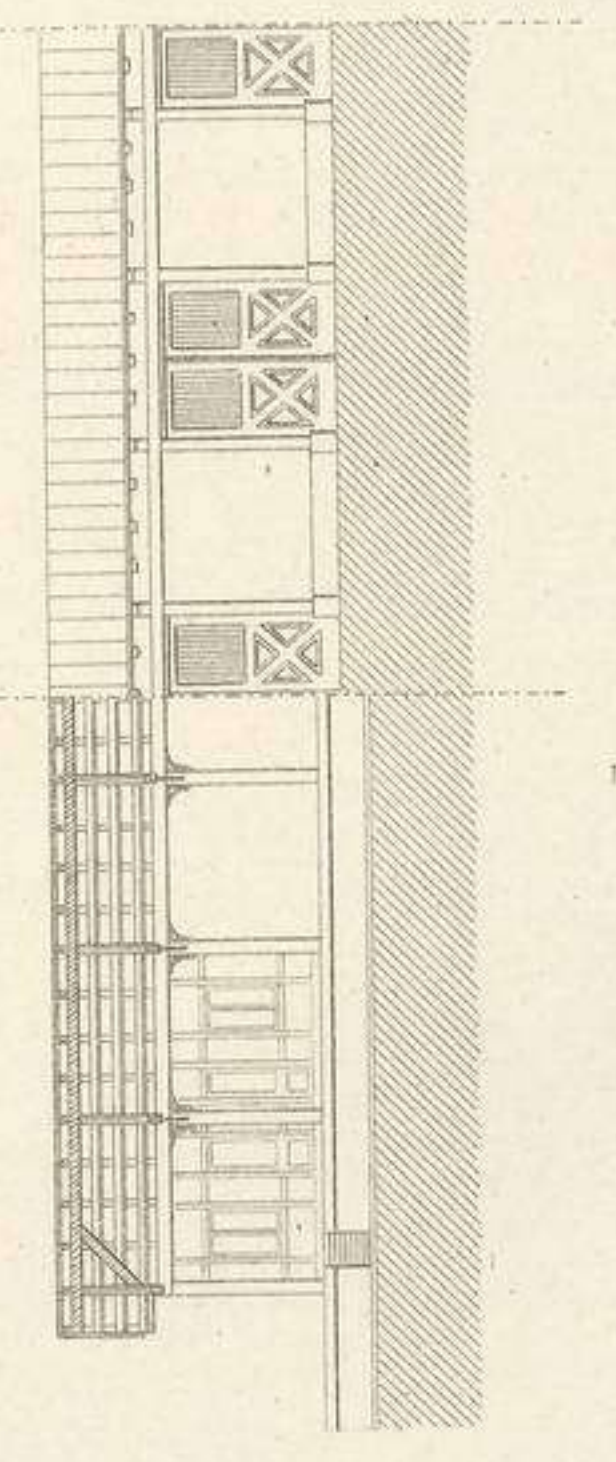

Fig. 6. (55)

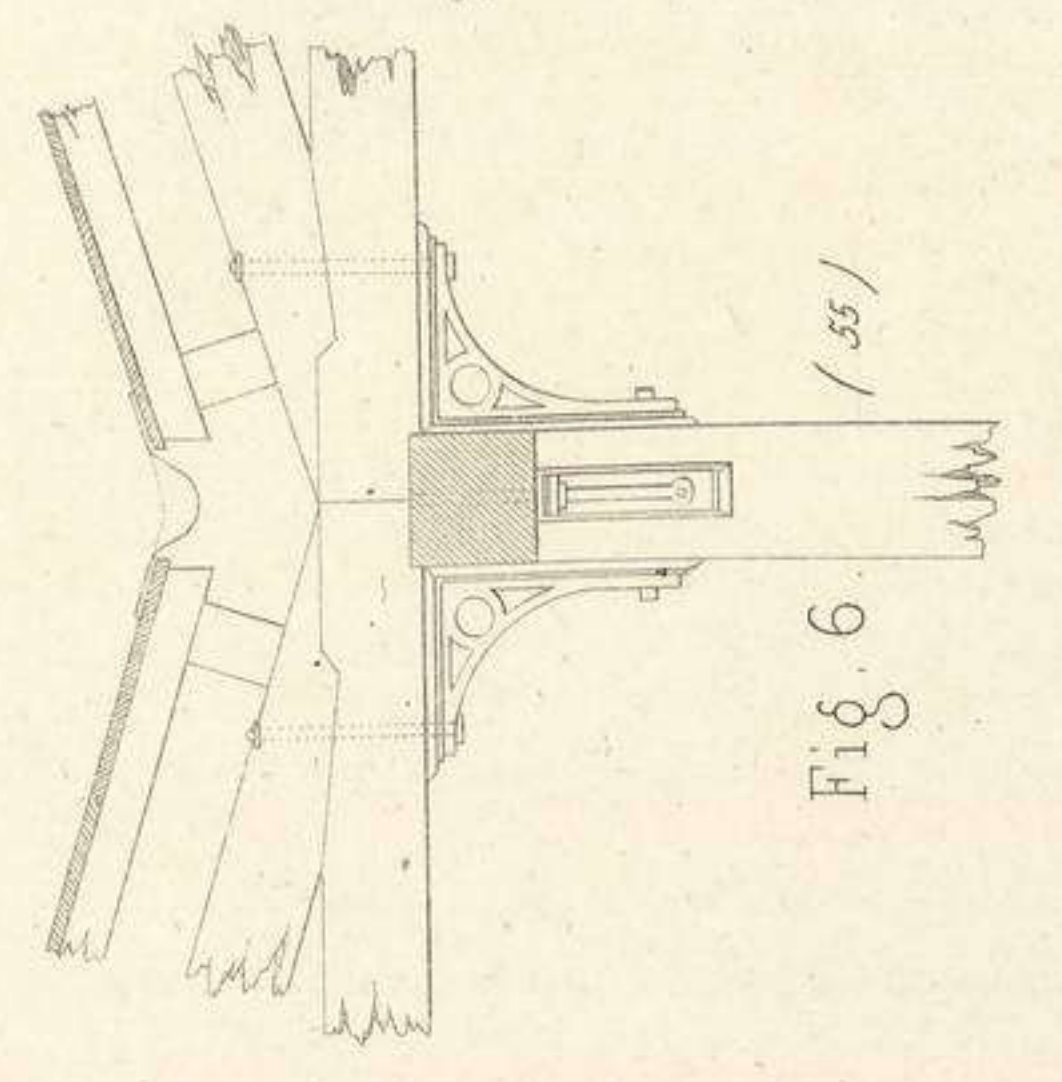

Fig. 7. (55)

Fig. 1. (54)

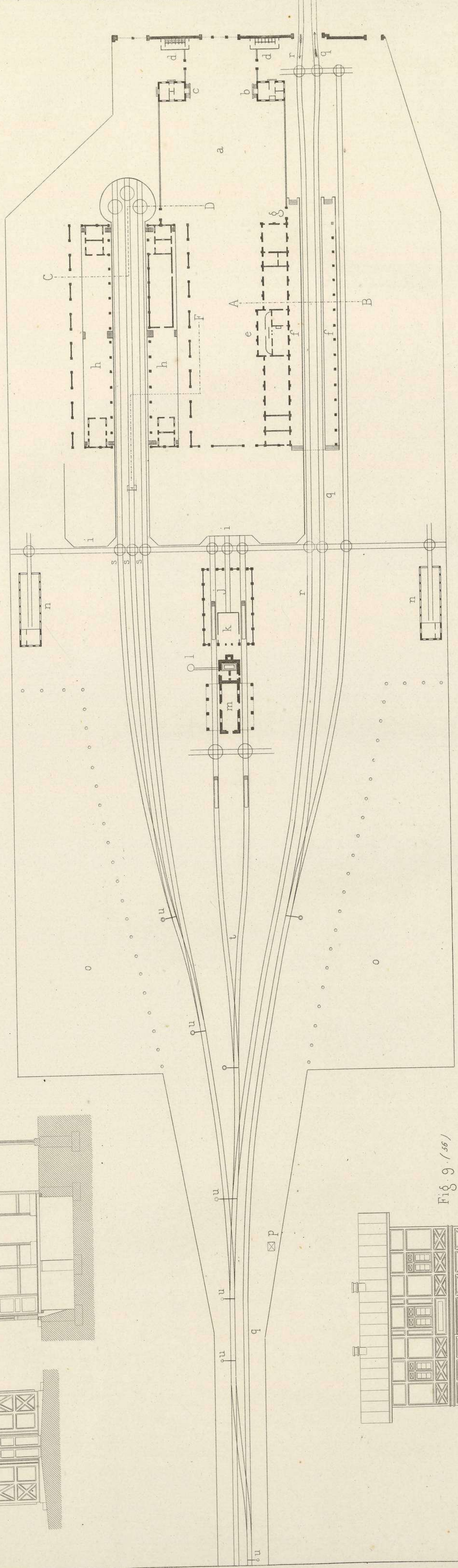

Fig. 2. (55)

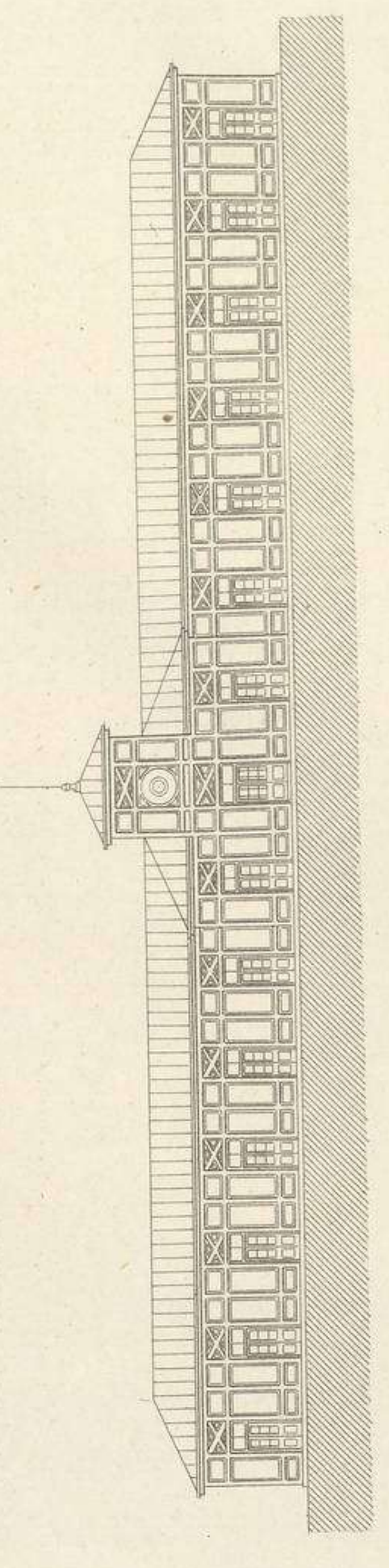

Fig. 3. (55)

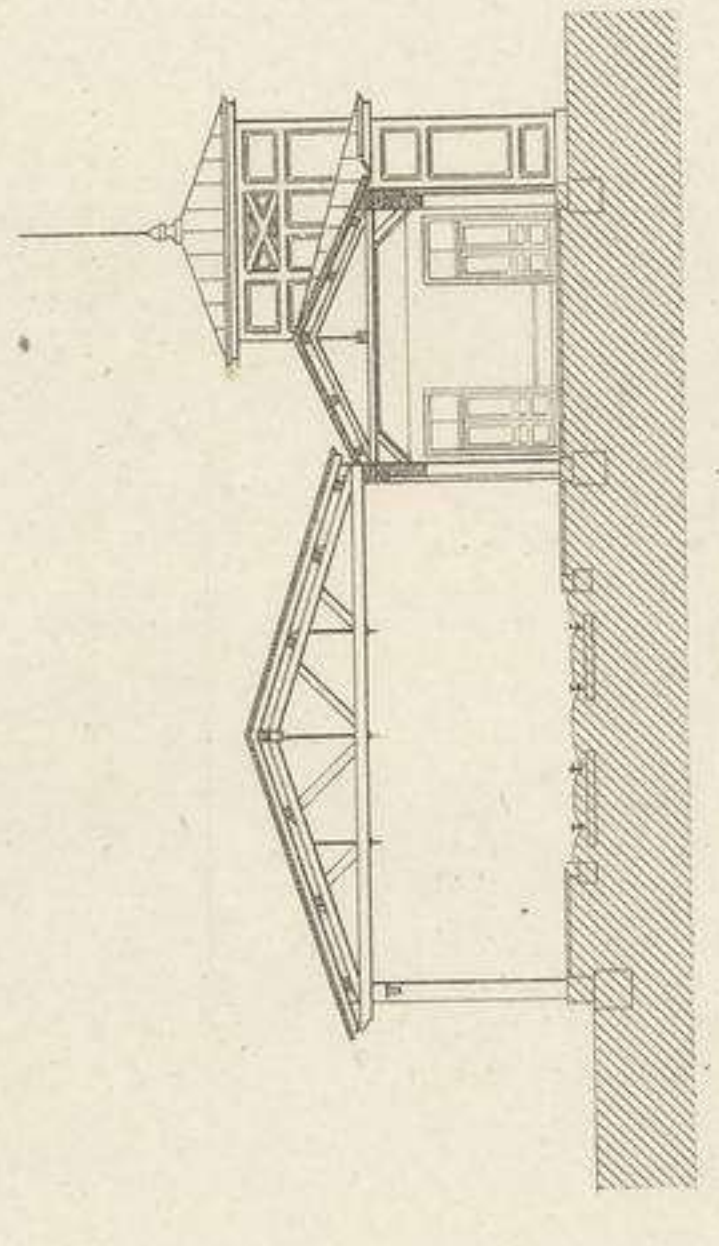

Fig. 9. (56)

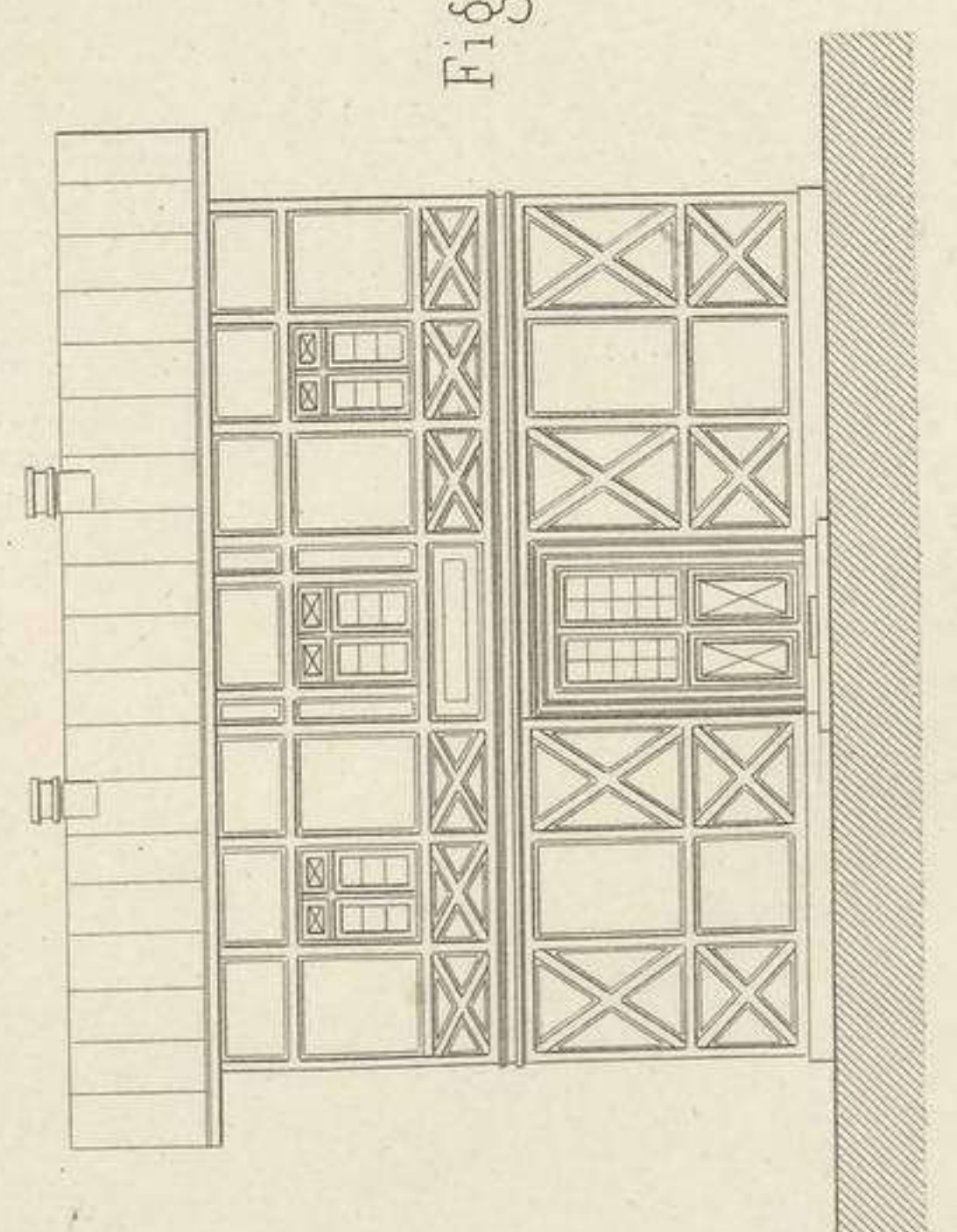
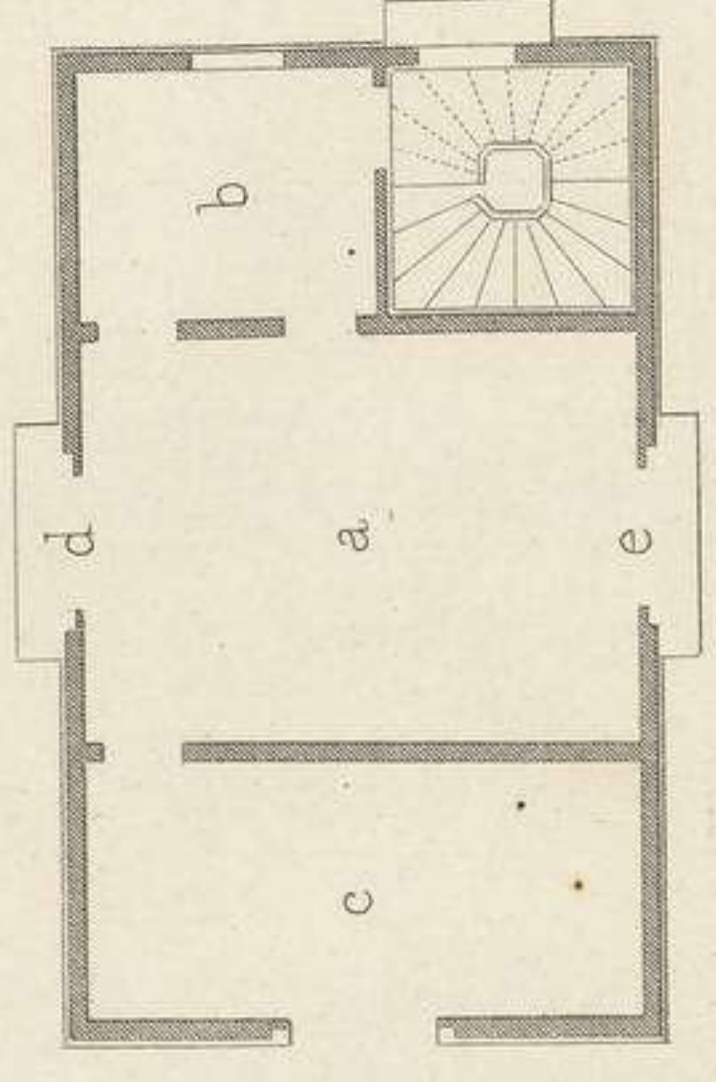

Fig. 8. (55)



Echelle de la Fig. 1. ++++++ 10 20 30 40 50 60 70 80 90 100 Mètres.

Echelle des Figs. 8, 9, 10. ++++++ 1 2 3 4 5 6 7 8 9 10 Mètres.

CHEMINS DE FER.  
Stations.

H. R.



Fig. 1. (57)

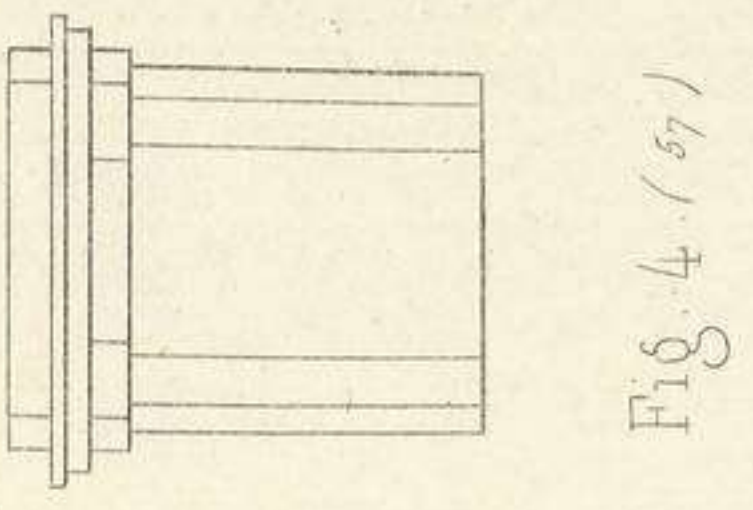
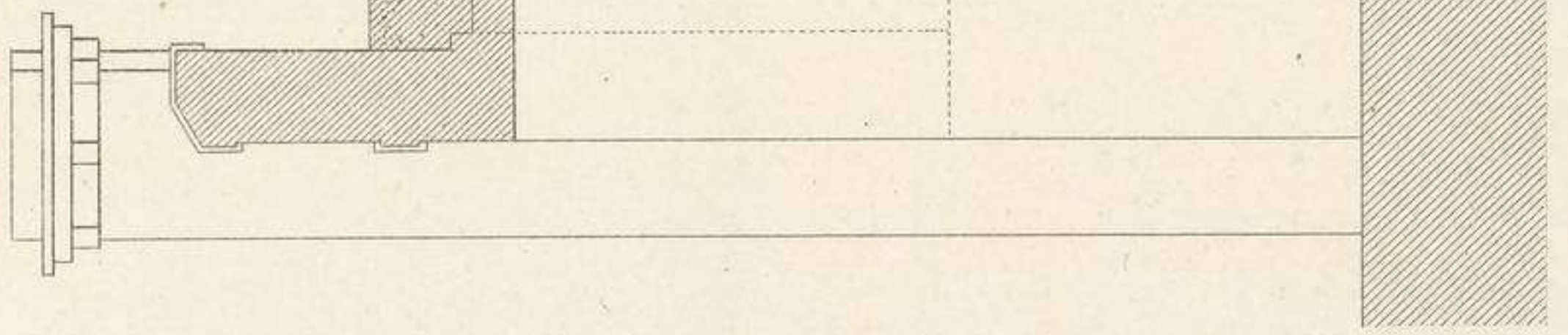
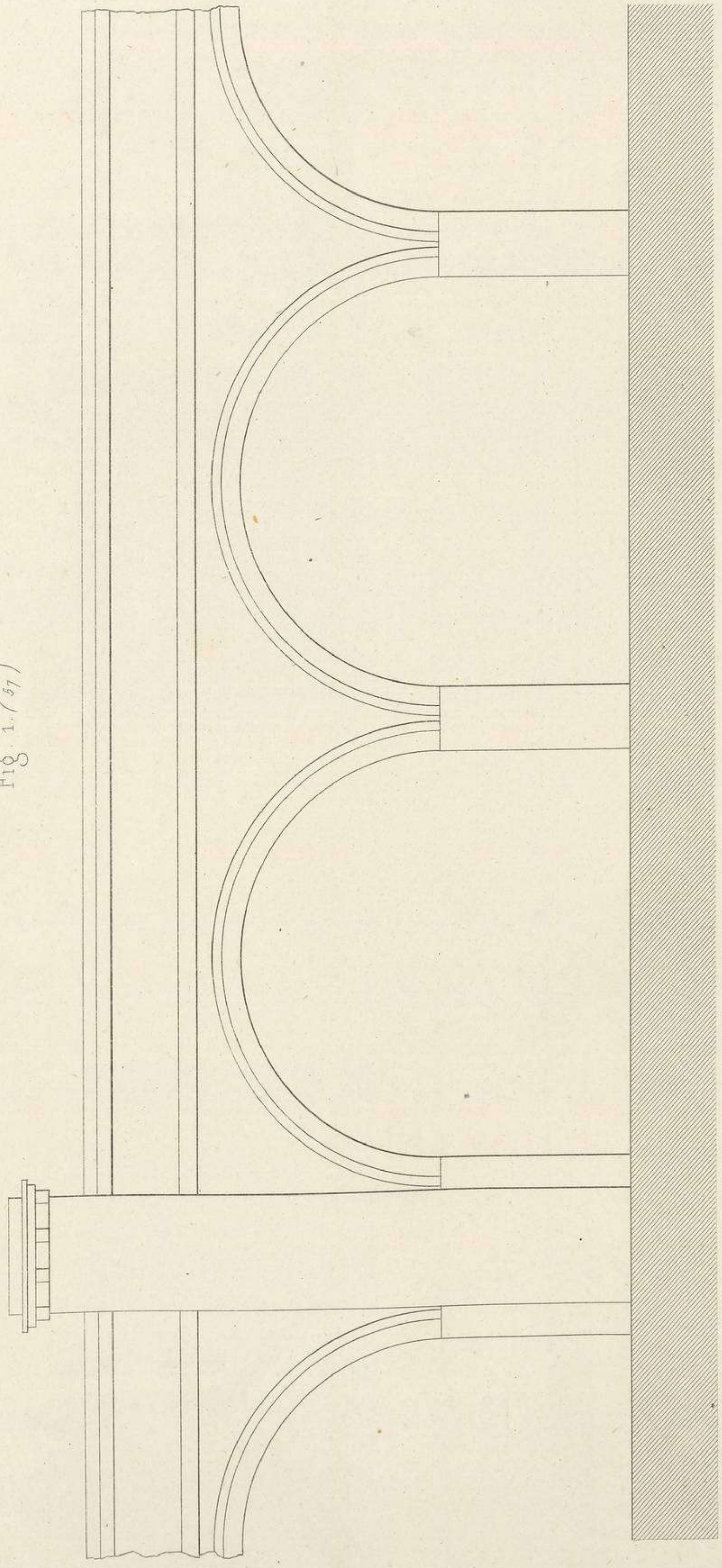

Fig. 8. (58)



Echelle des Fig. 1., 3., 4. 10 Mètres



Fig. 3. (57)

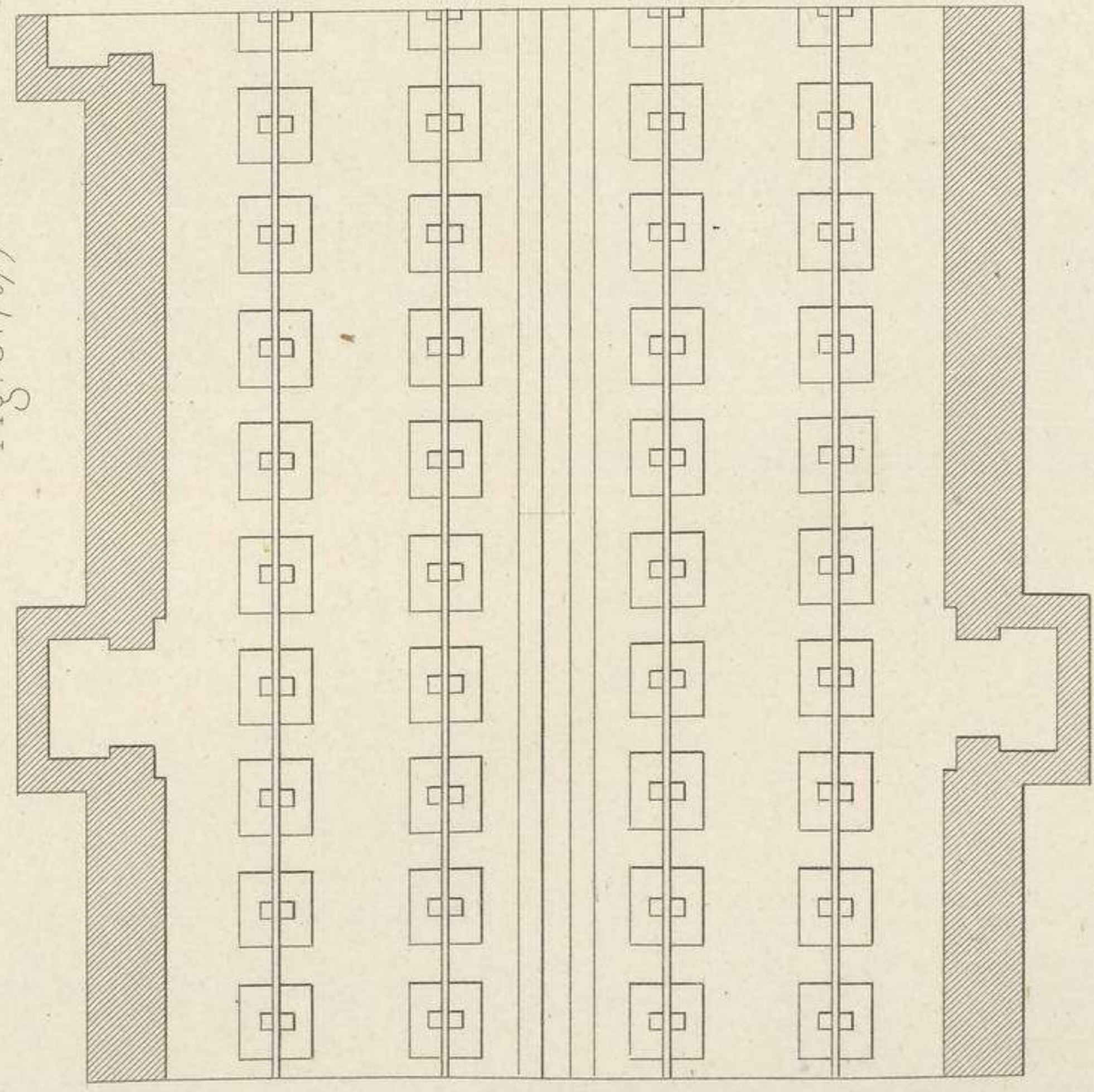

Fig. 5. (57)

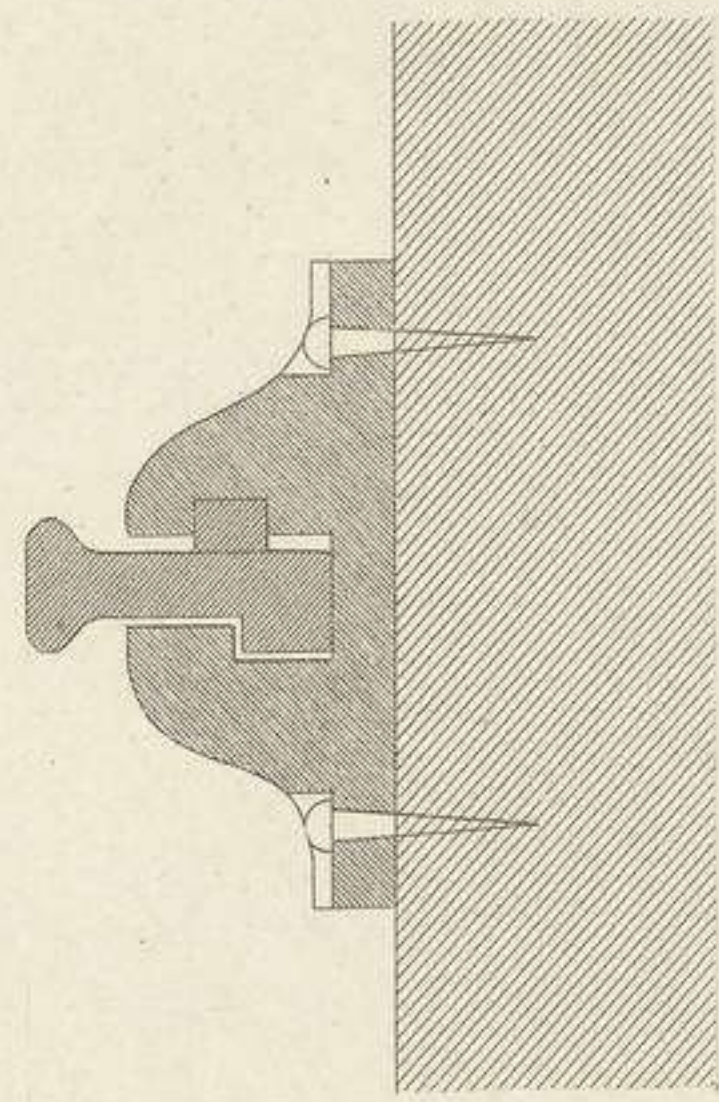

Fig. 6. (57)

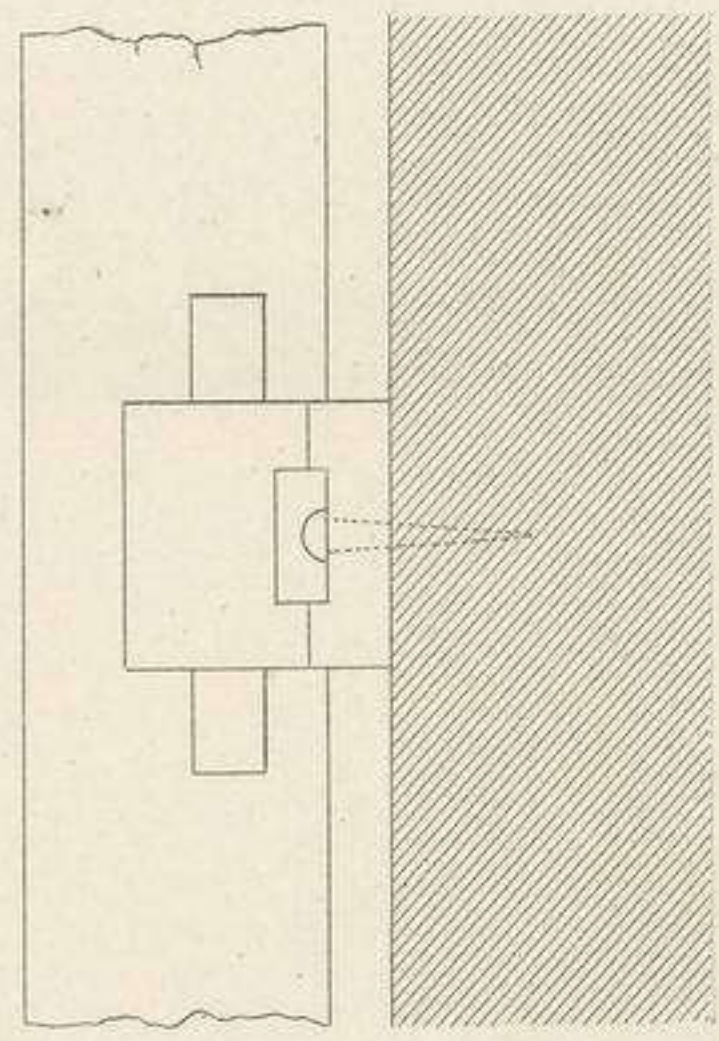

Fig. 9. (58)

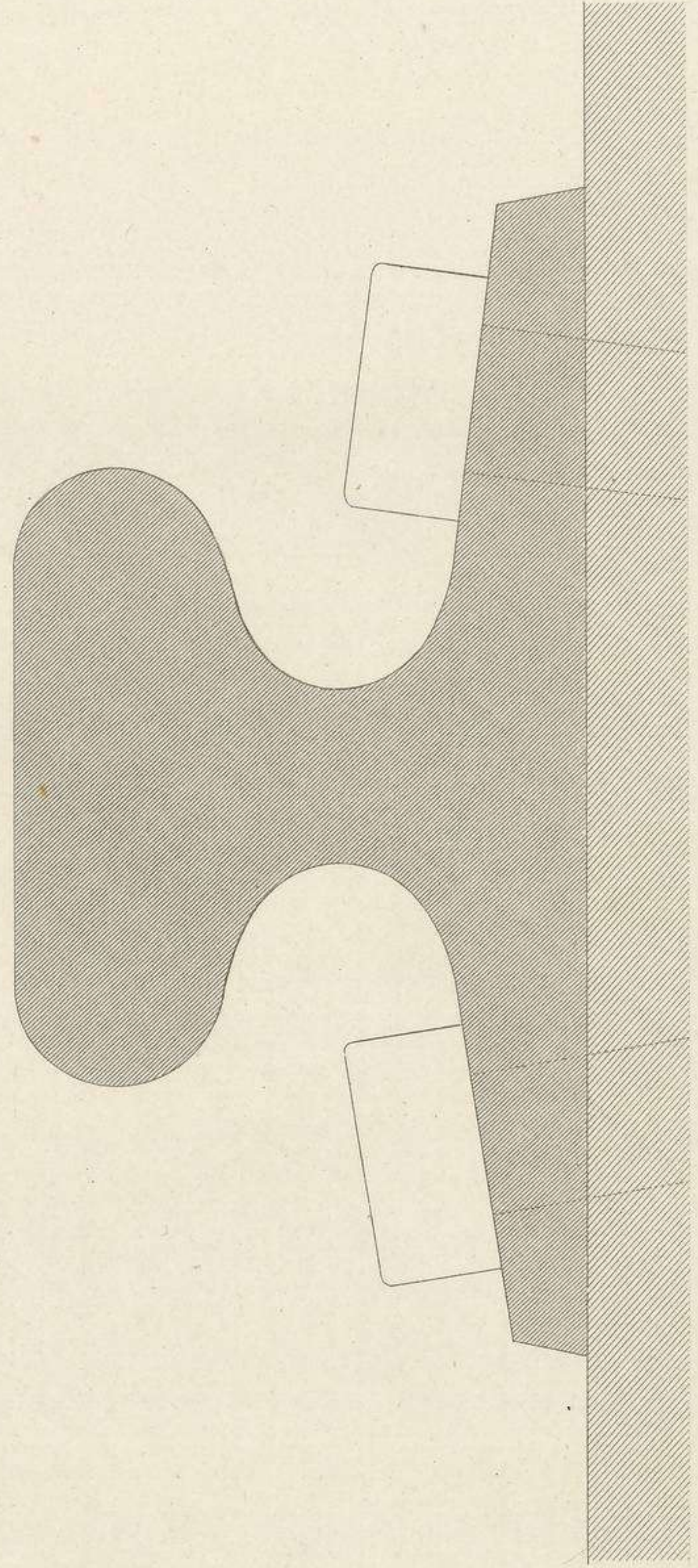

Fig. 10. (58)

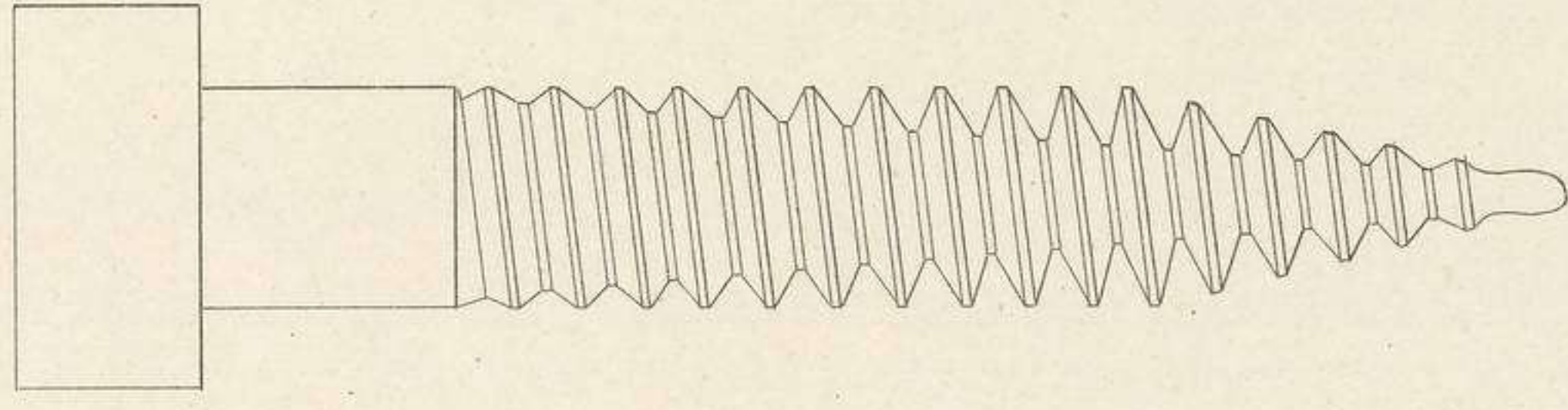
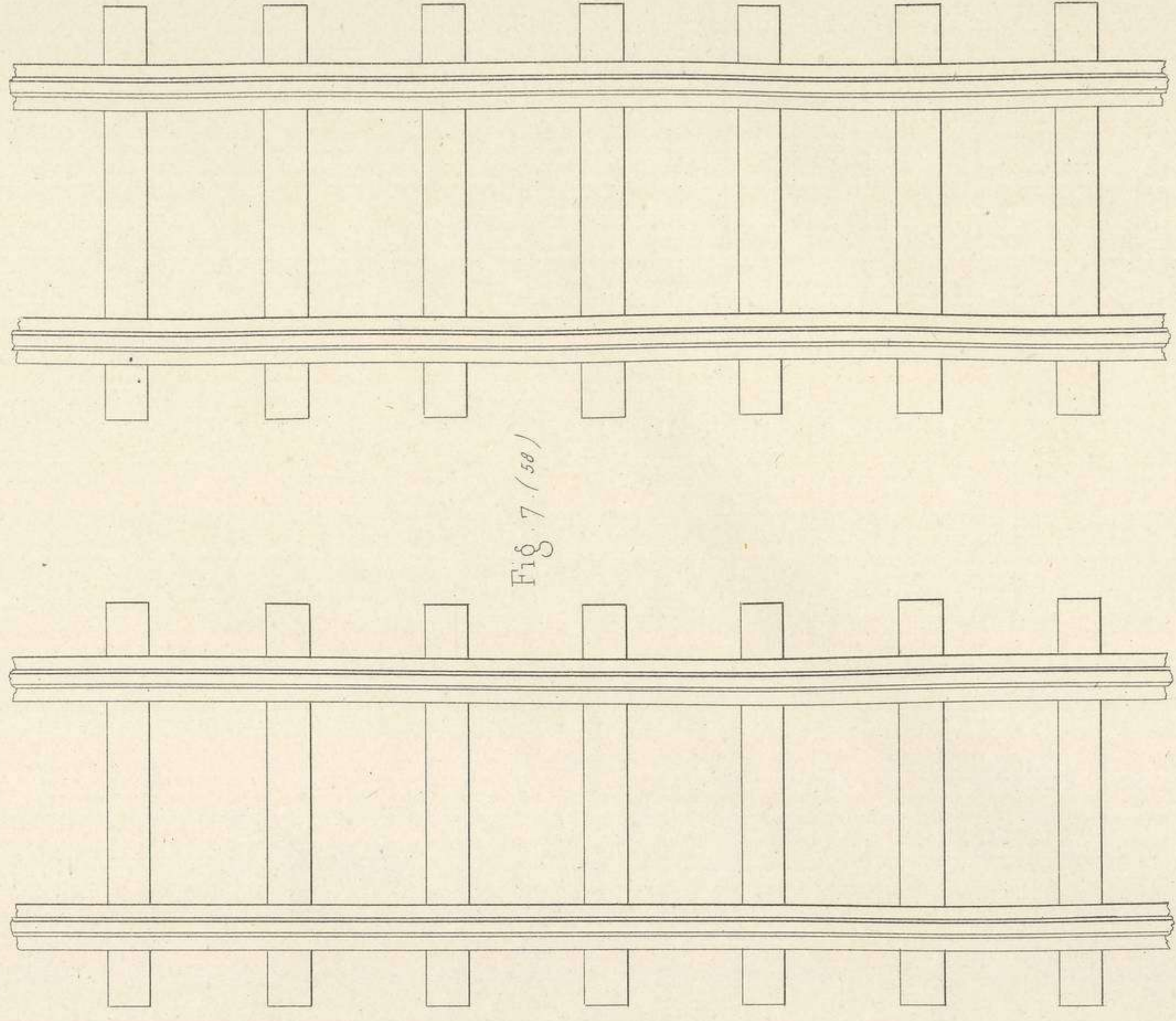
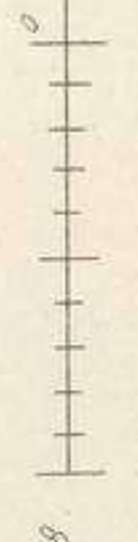

Fig. 7. (58)



Echelle des Fig. 7. et 8. 6 Mètres





Pl. 19. (T. 1. P. 58.)

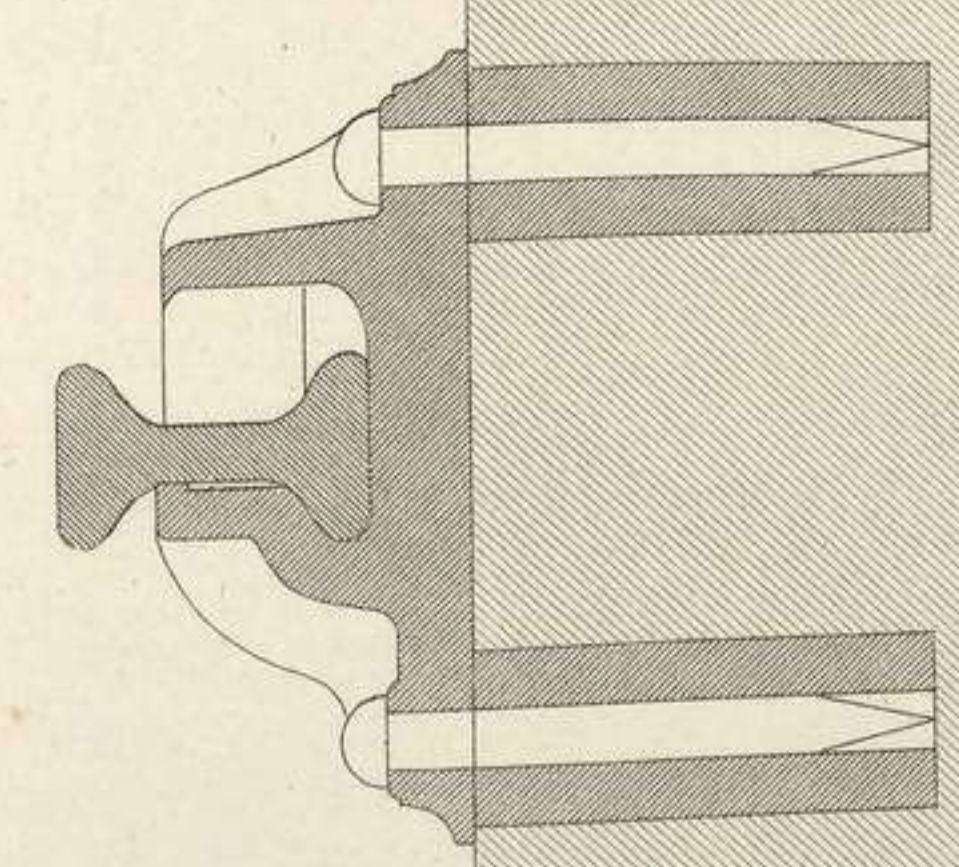

Fig. 3. (58)

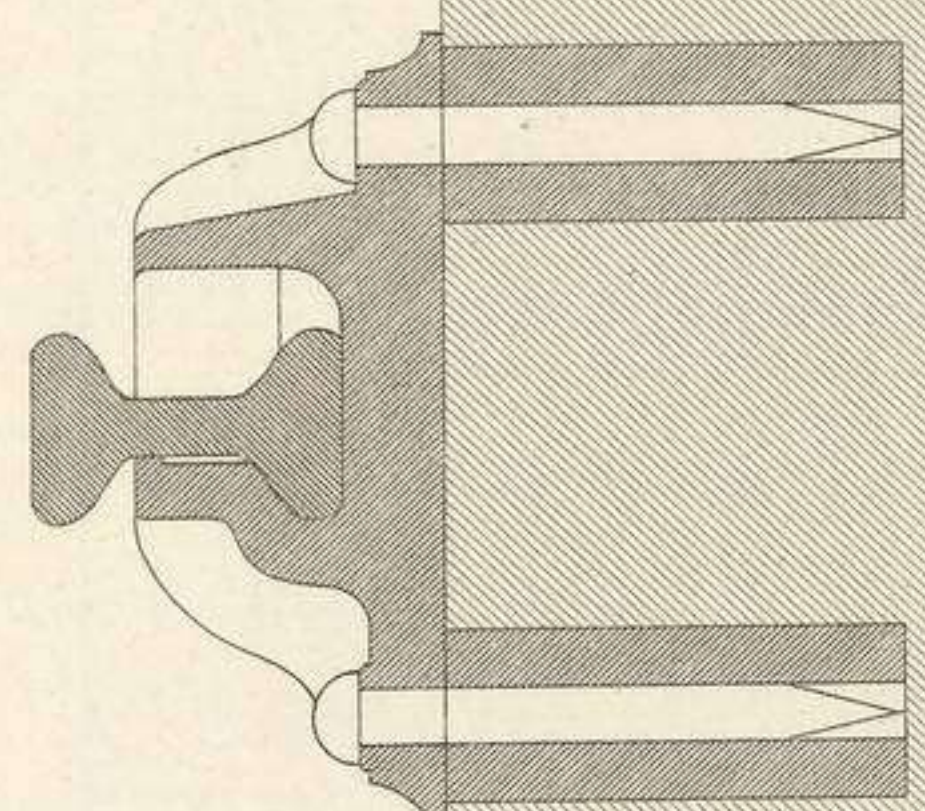

Fig. 6. (58)

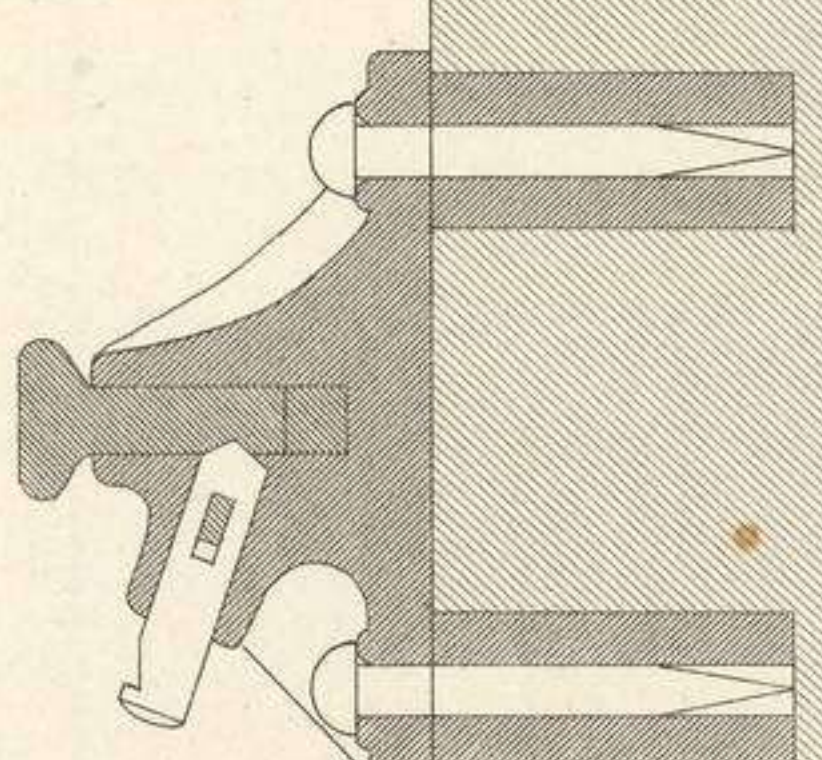

Fig. 9. (59)

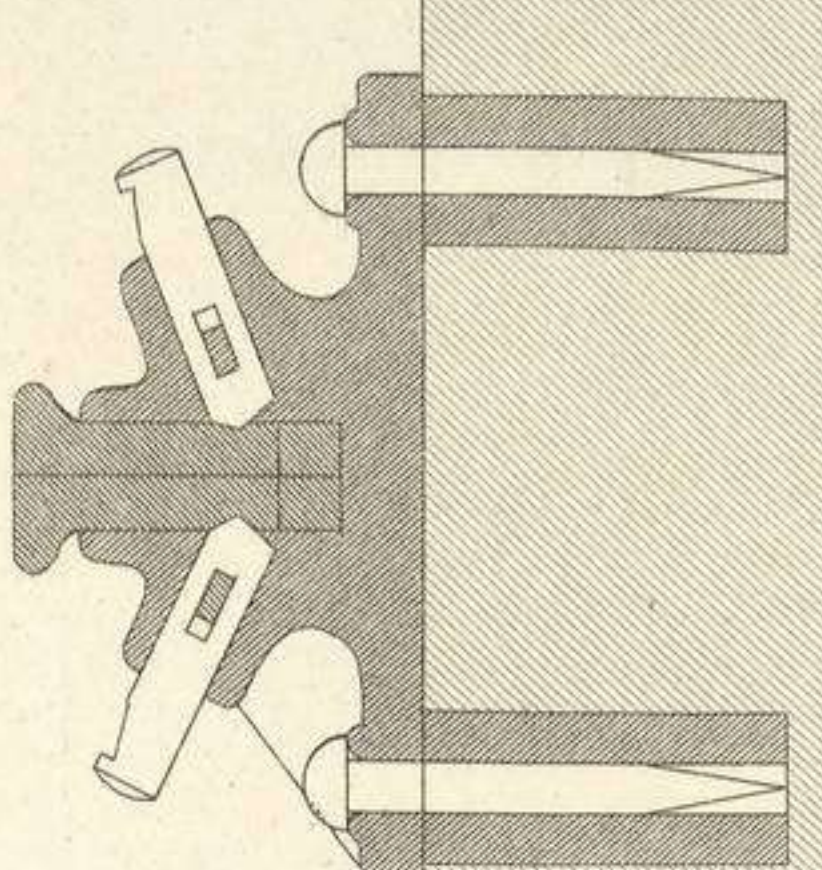

Fig. 12. (59)

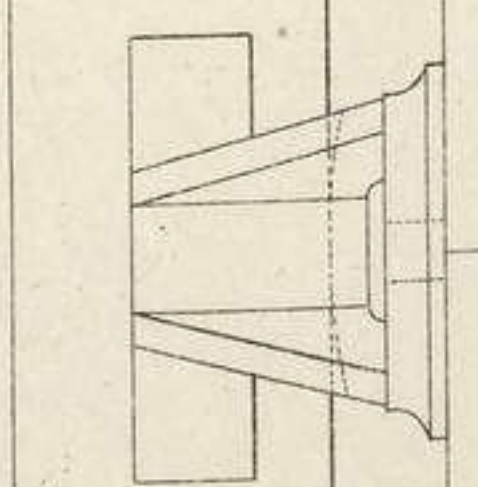

Fig. 2. (58)

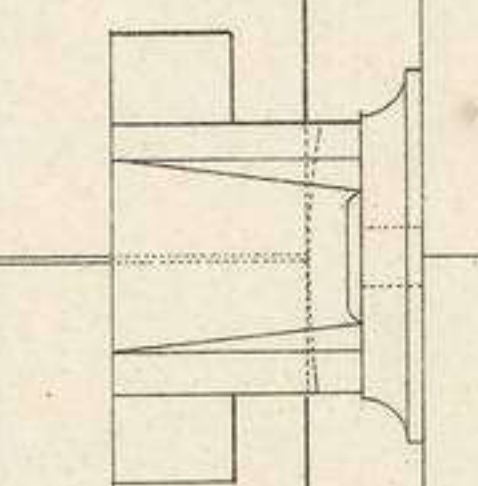

Fig. 5. (58)

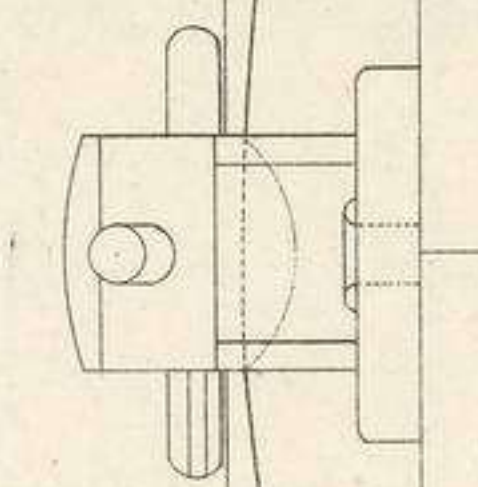

Fig. 8. (59)

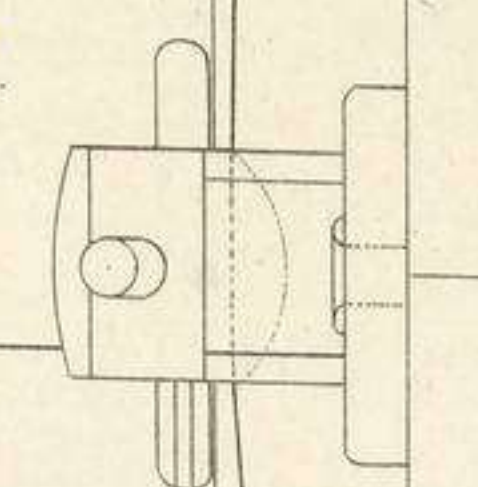

Fig. 11. (59)

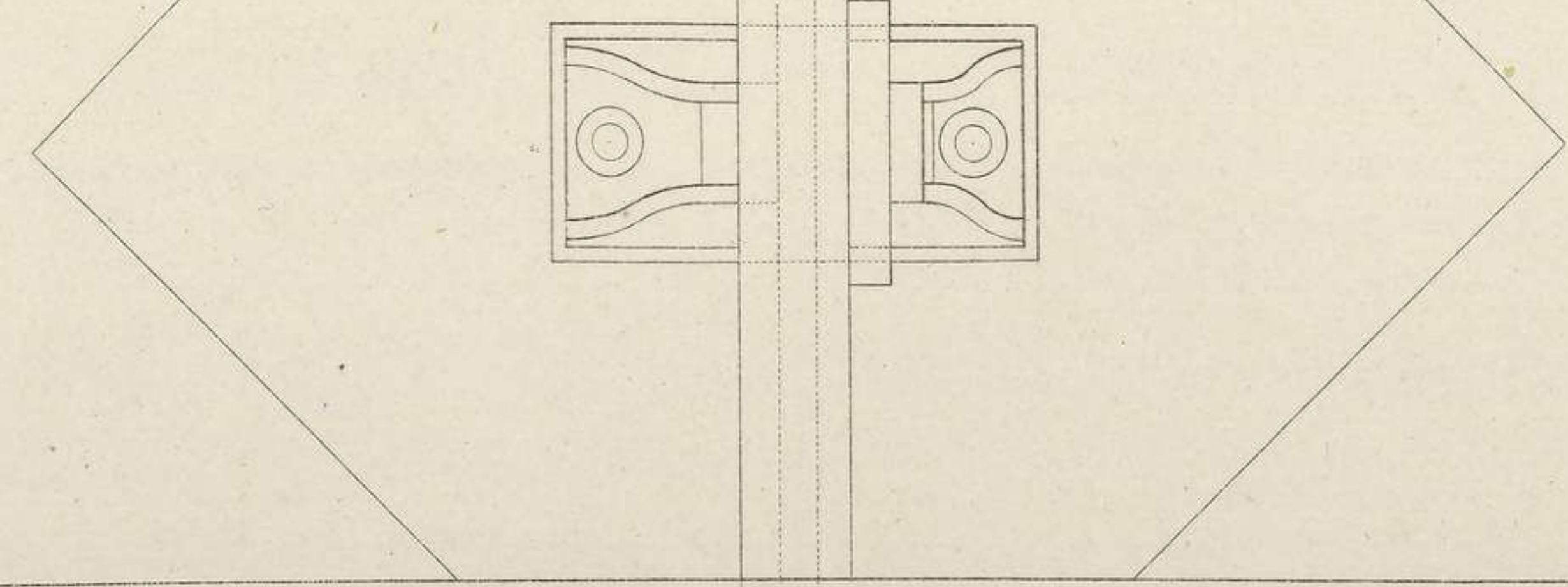

Fig. 1. (58)

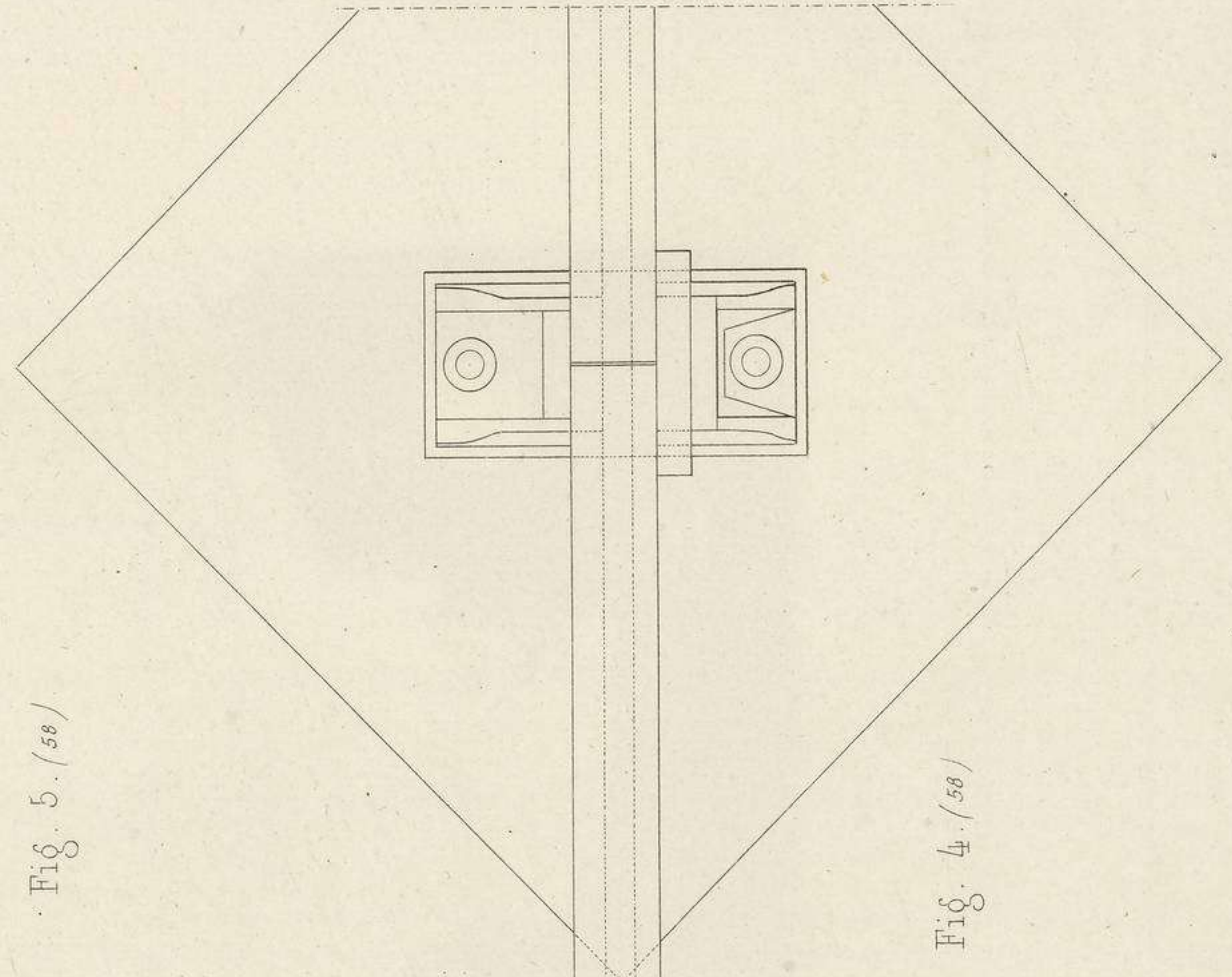

Fig. 4. (58)

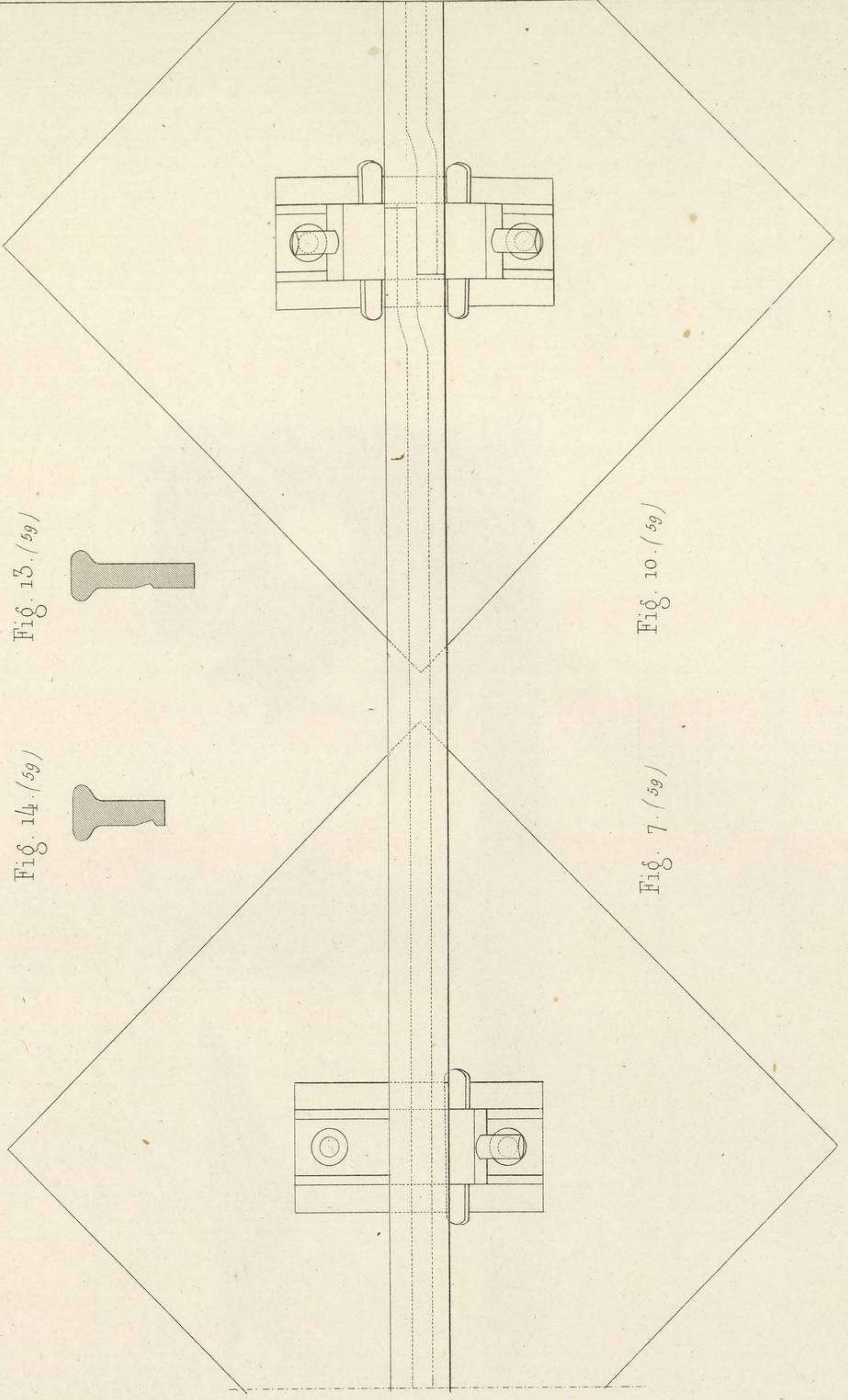

Fig. 7. (59)

Fig. 10. (59)

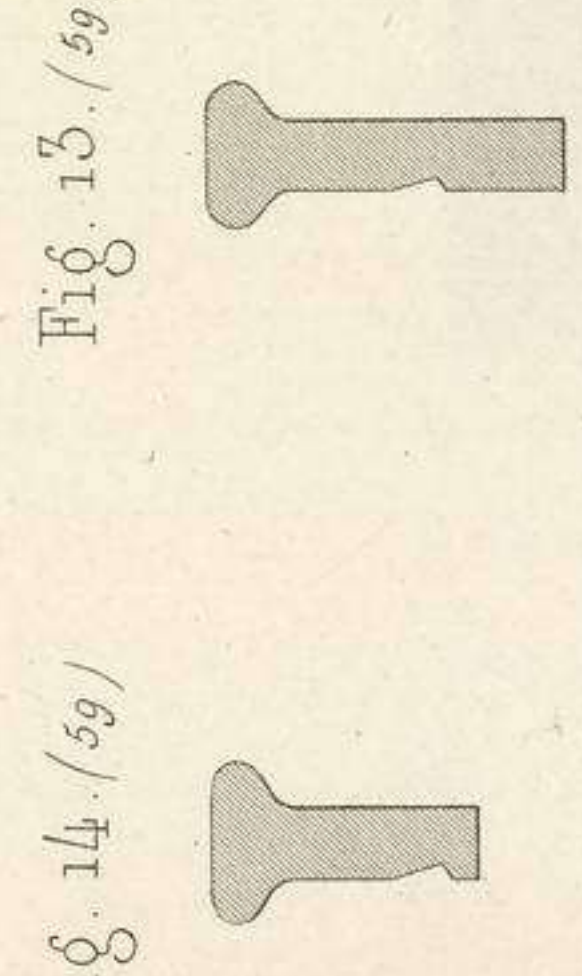

Fig. 14. (59)

Fig. 13. (59)



B. de V. del.



Fig. 1. (a.)

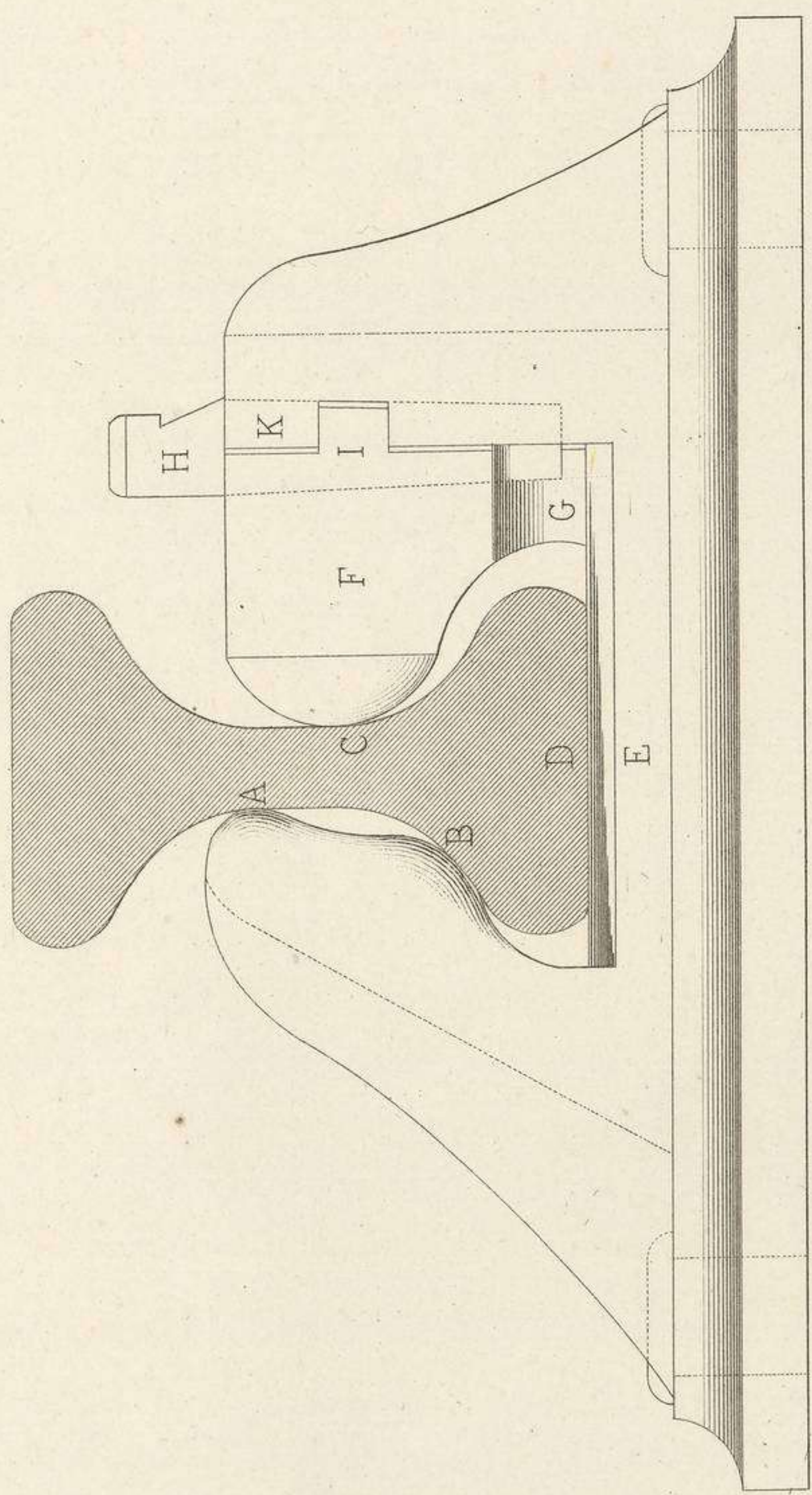

Fig. 3. (a.)

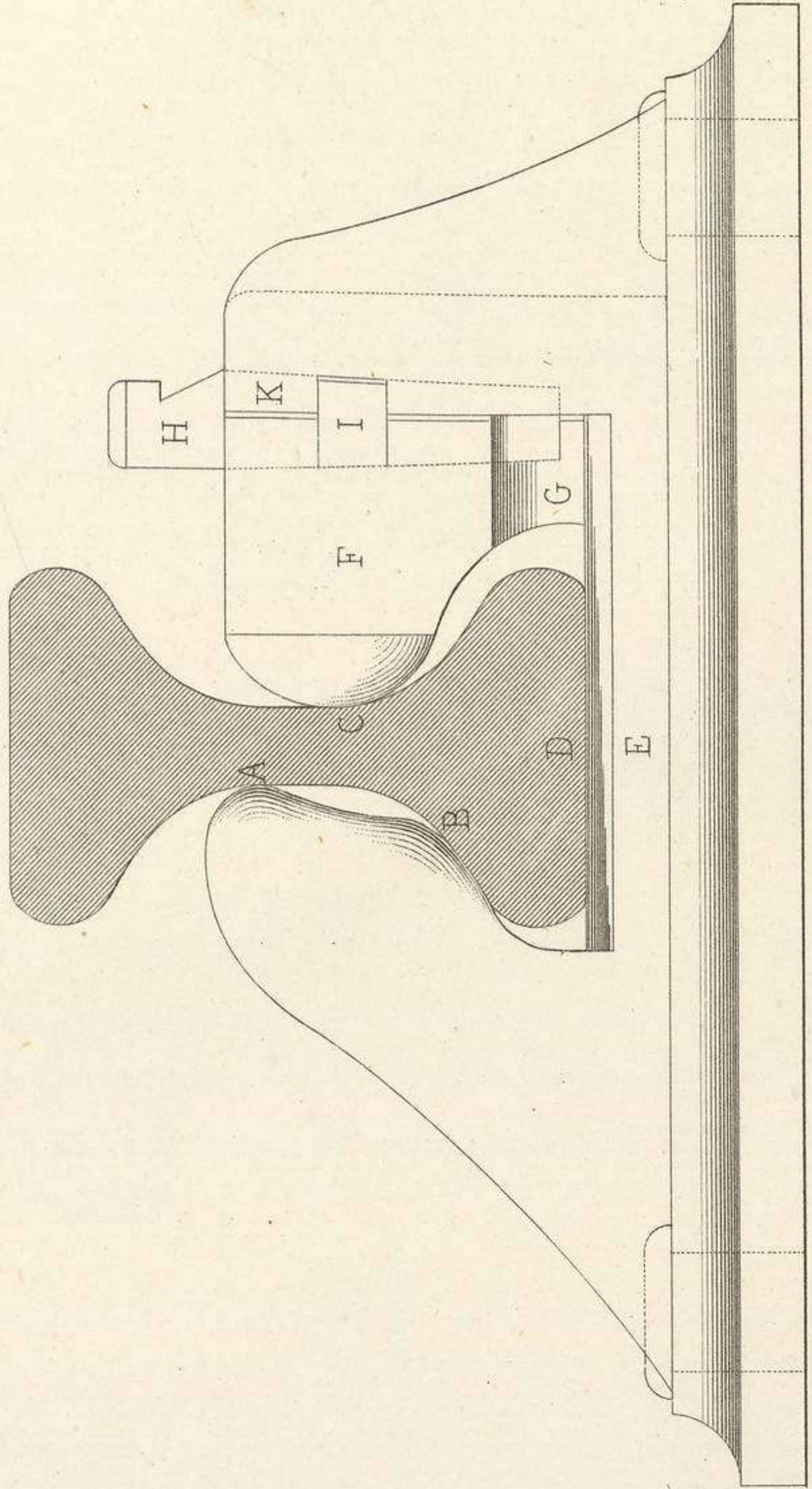

Fig. 2. (a.)

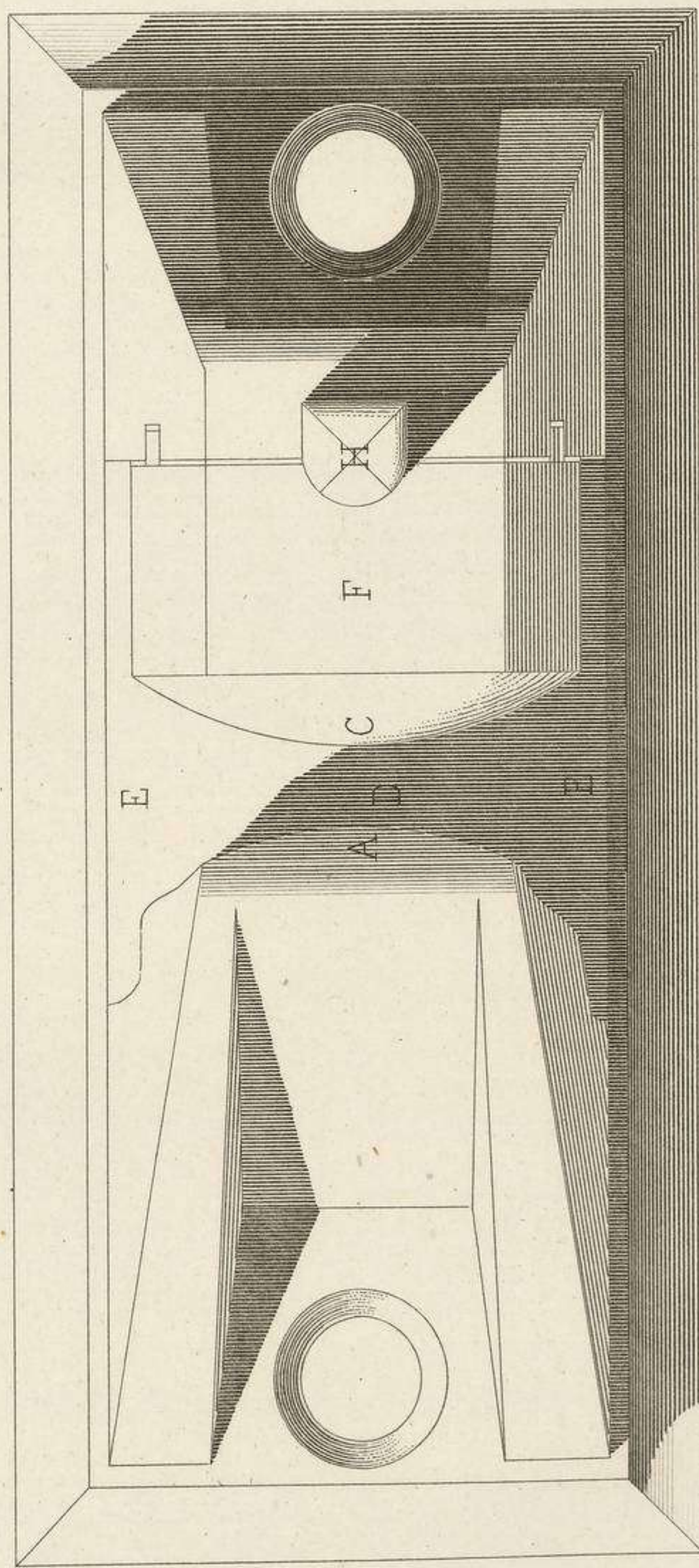
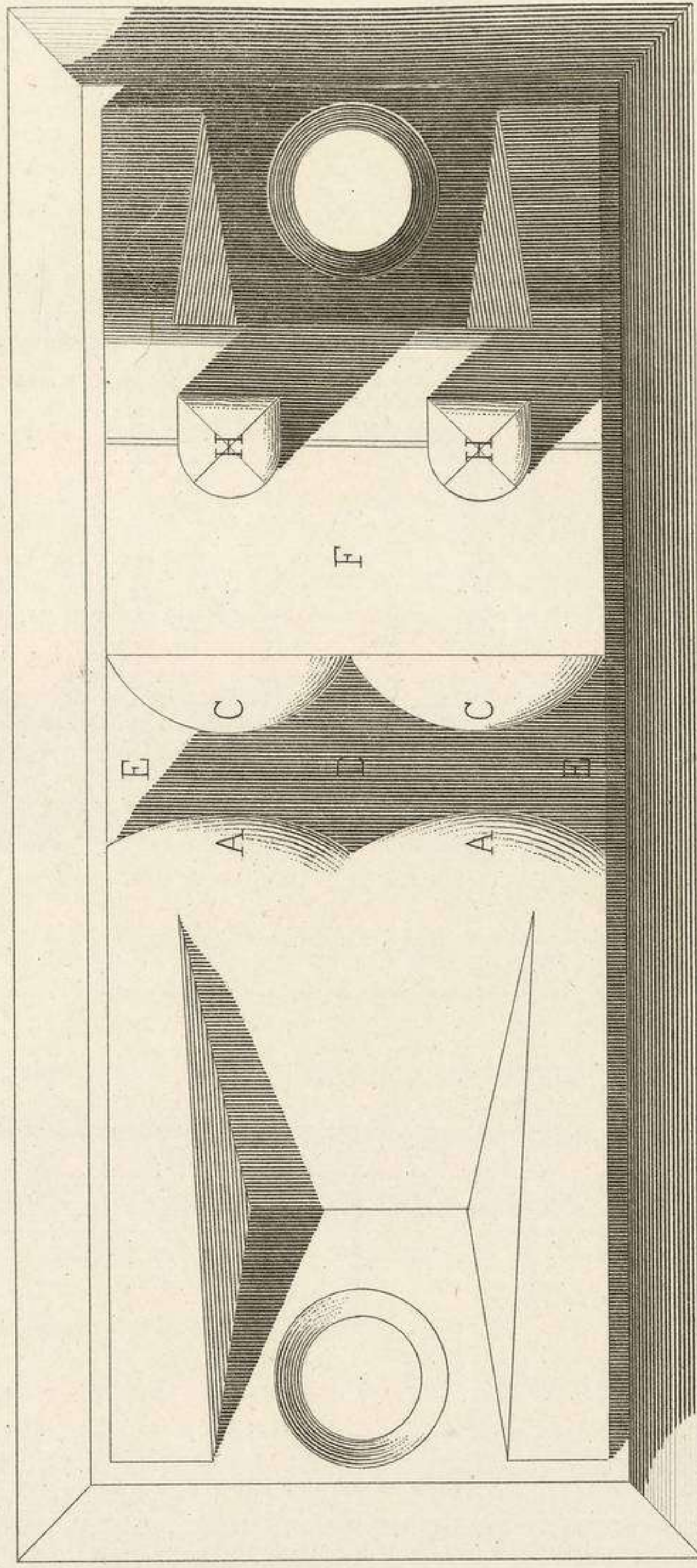

Fig. 4. (a.)



B. et V. del.

CHEMINS DE FER.  
Cousinets

H. R.



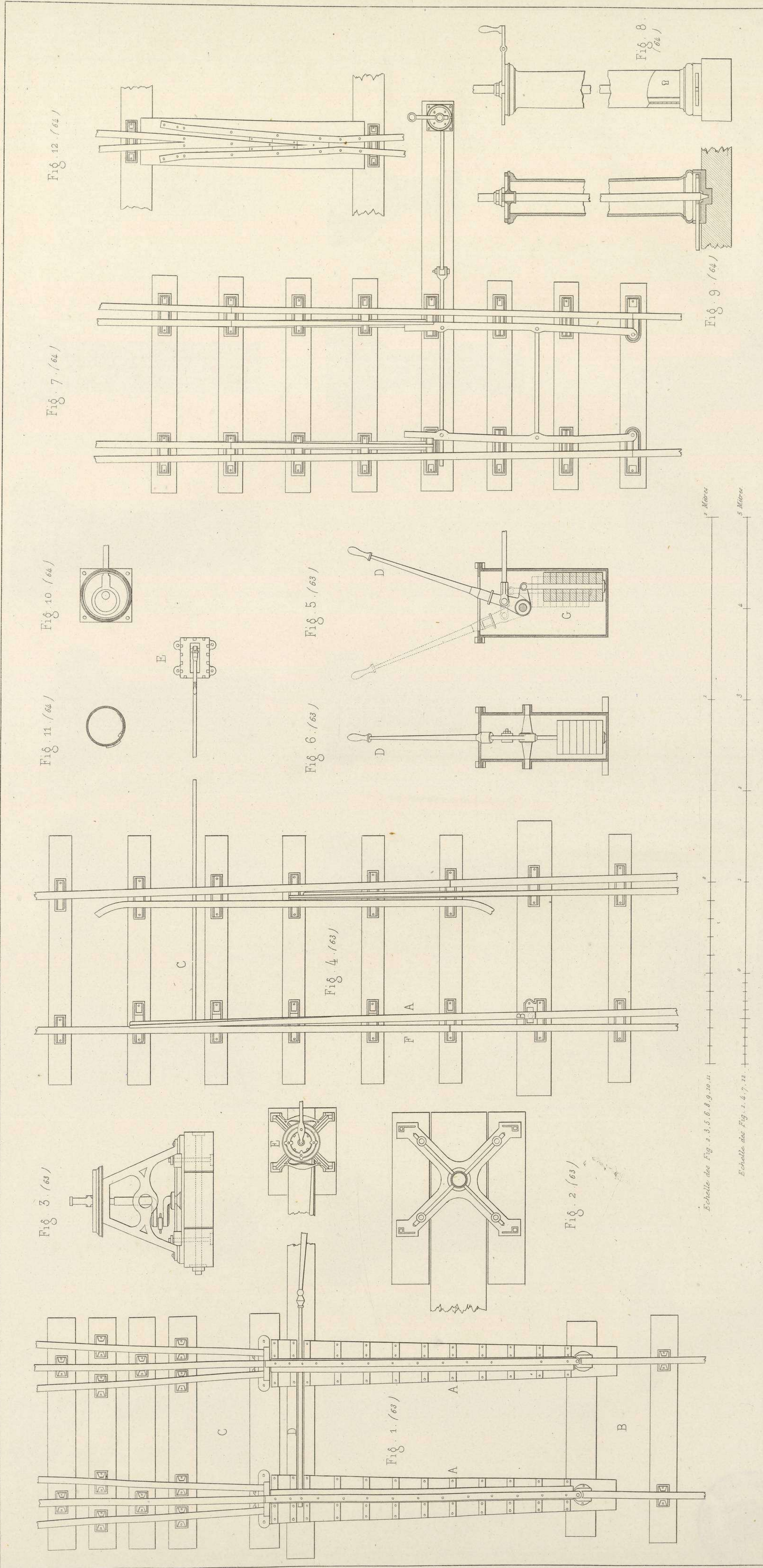

Echelle des Fig. 1, 3, 5, 6, 8, 9, 10, 11.  
 Echelle des Fig. 2, 4, 7, 12.

B. de V. del.

H. R.

CHEMINS DE FER.  
 Changements de Voie



Fig. 1. (64.)

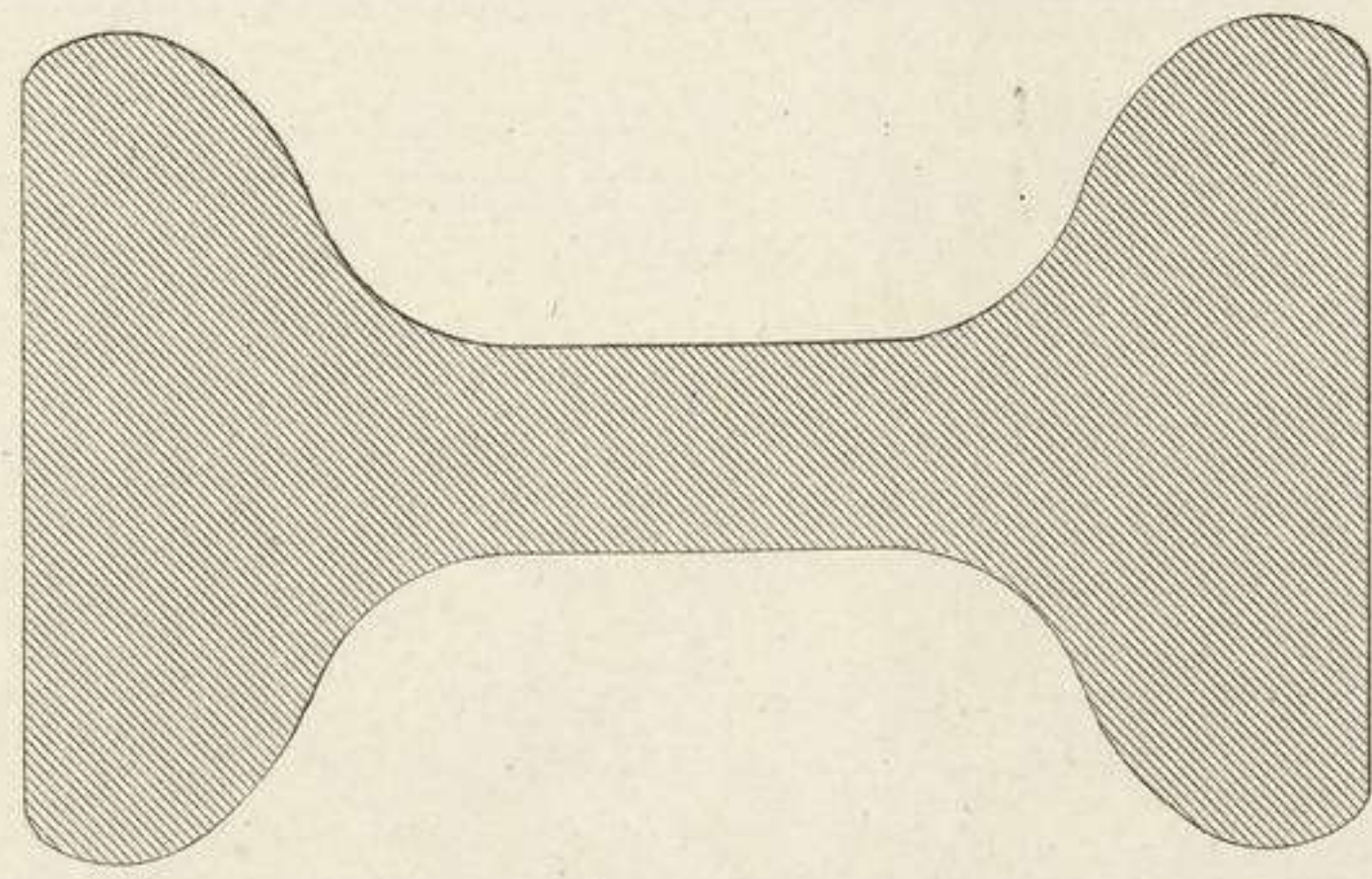

Fig. 2. (64.)

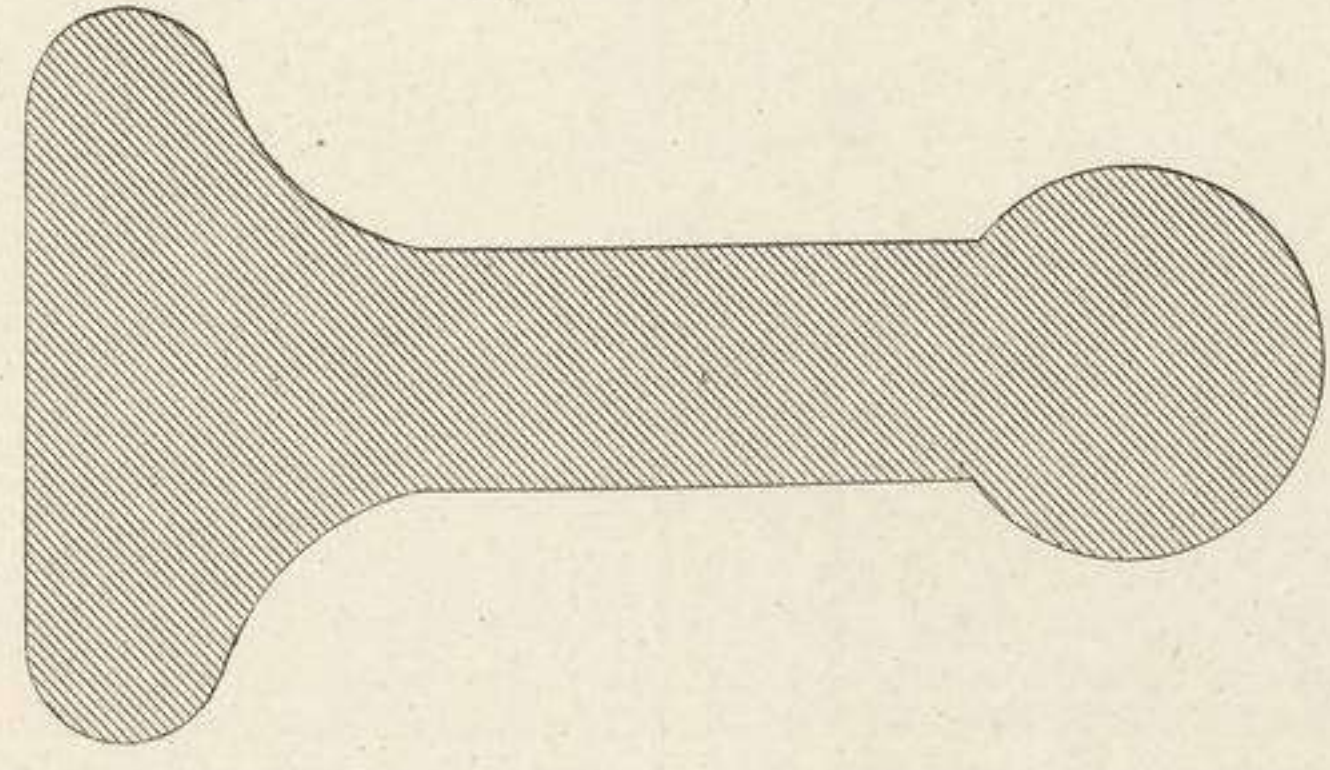

Fig. 3. (64.)

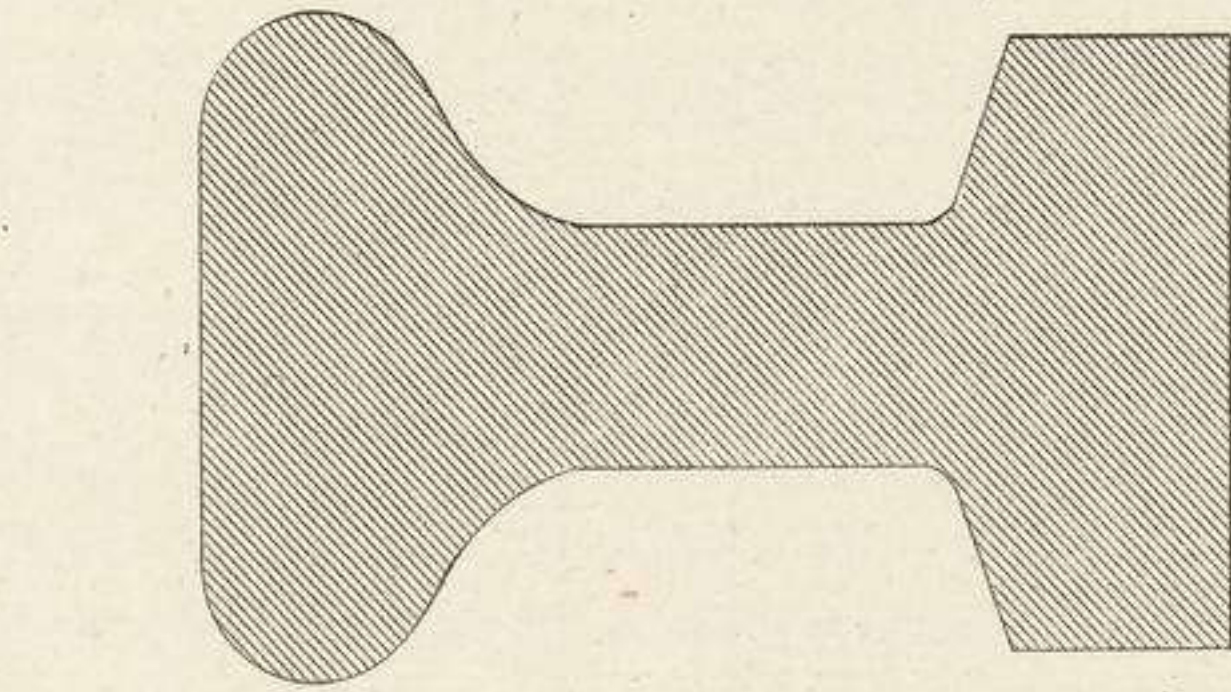

Fig. 4. (64.)

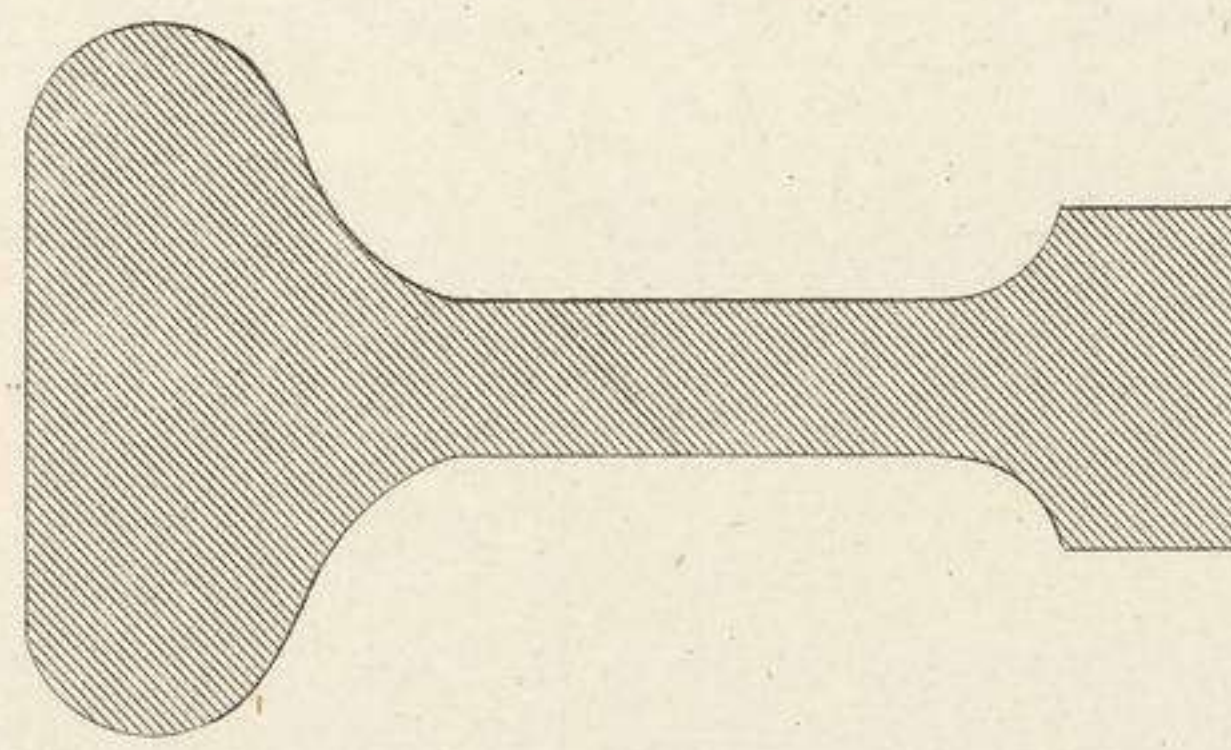

Fig. 5. (64.)

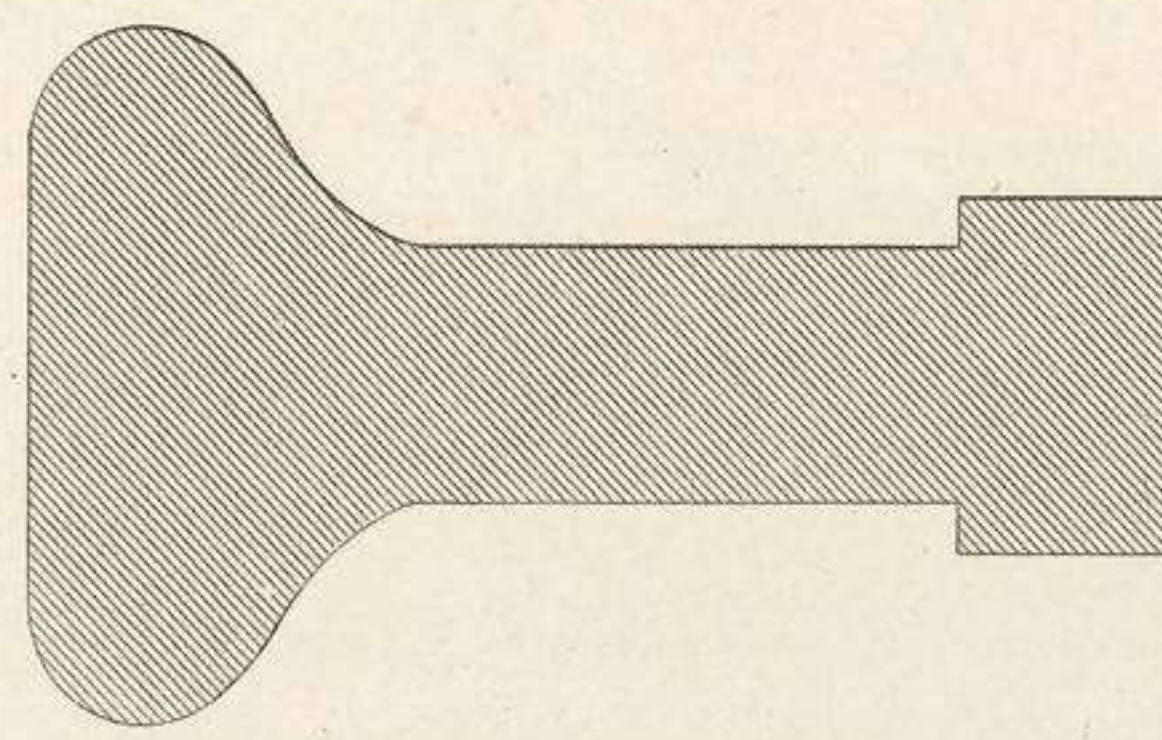

Fig. 6. (64. 65.)

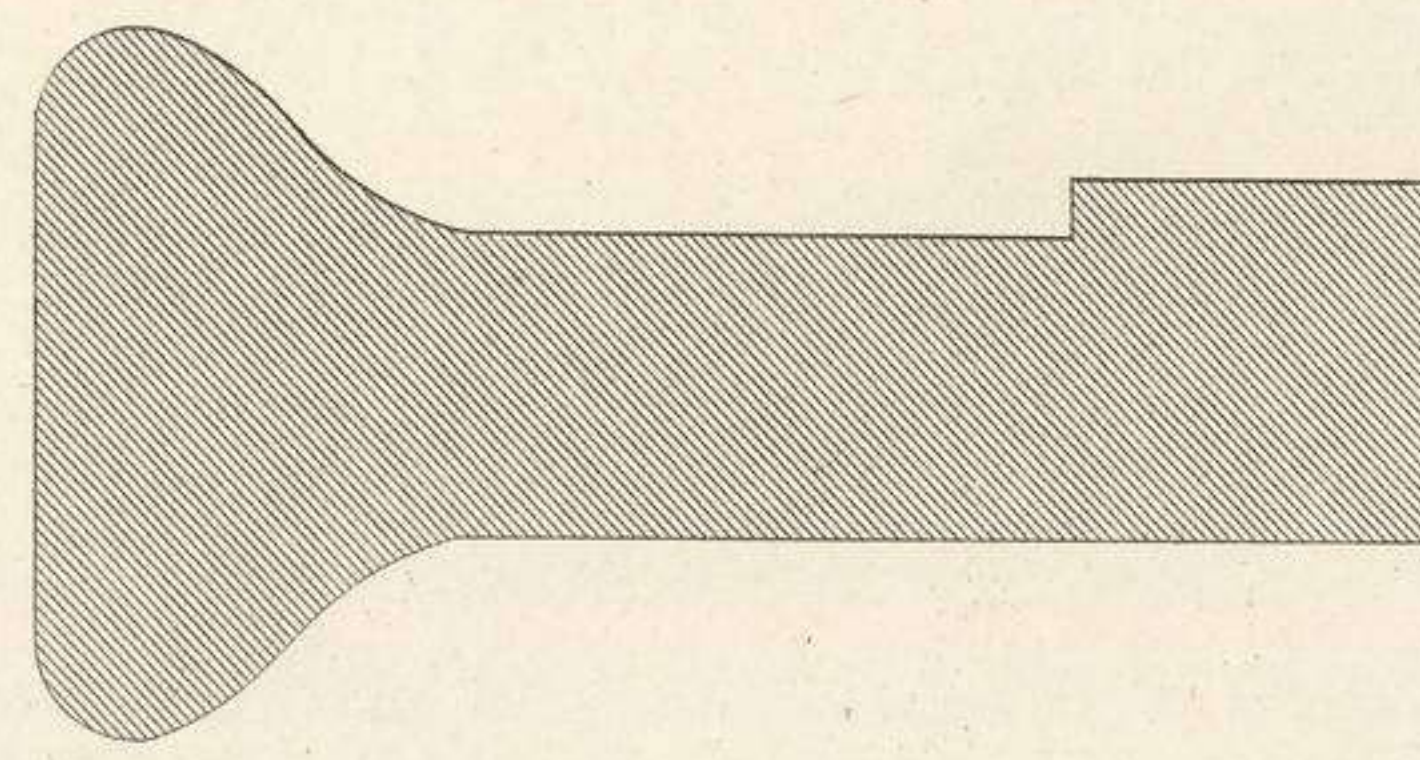

Fig. 7. (64. 65.)

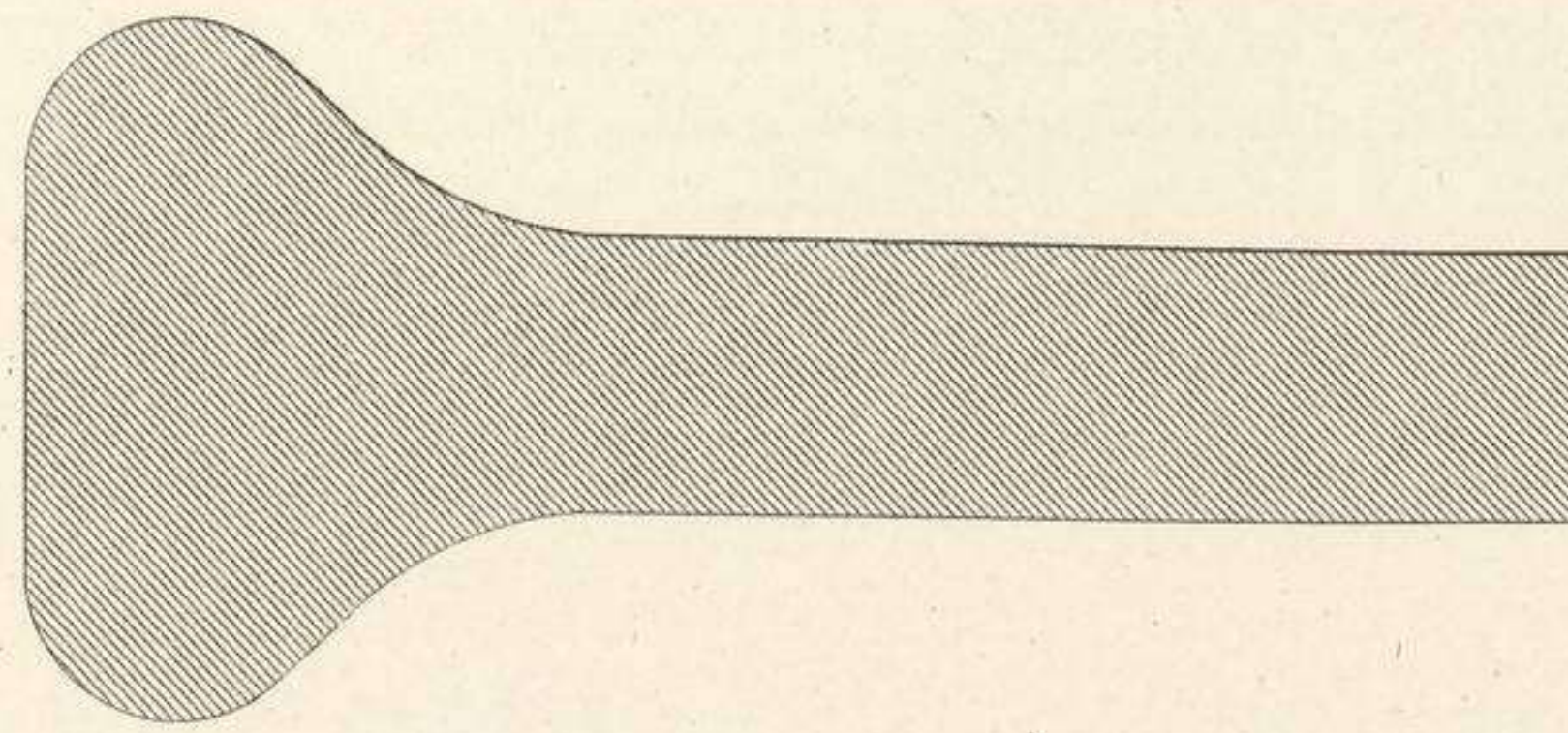

Fig. 8. (64. 65.)

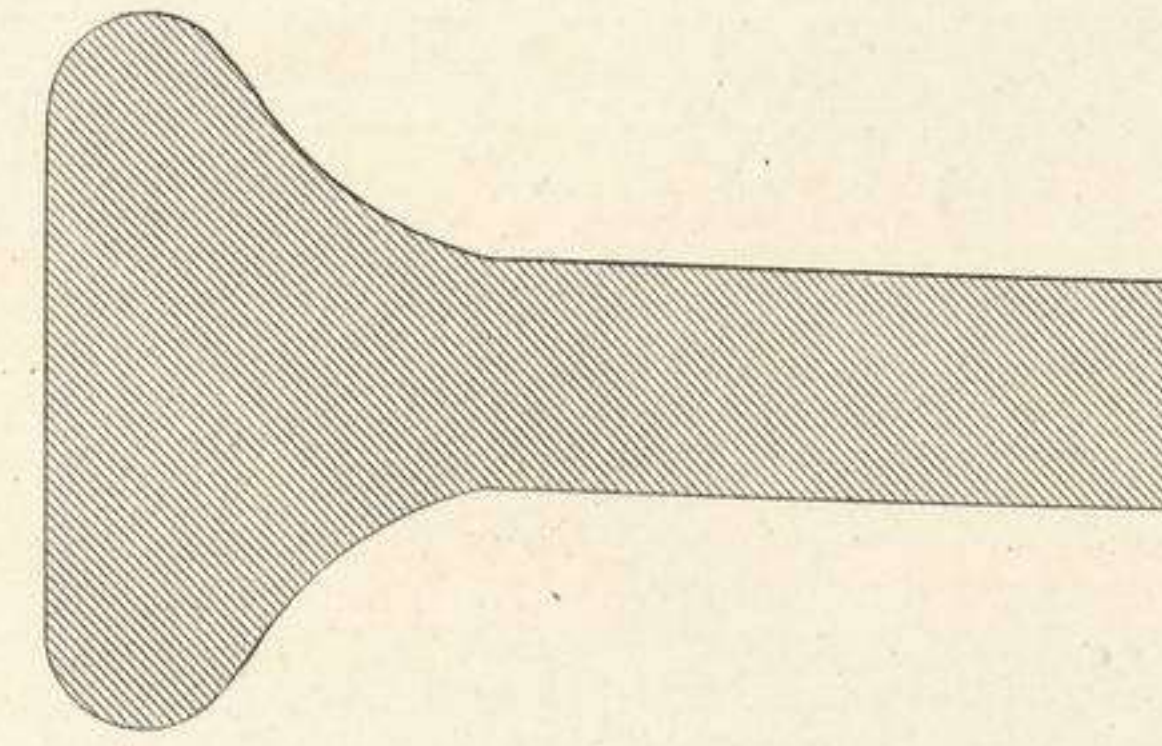

Fig. 9. (64. 65.)

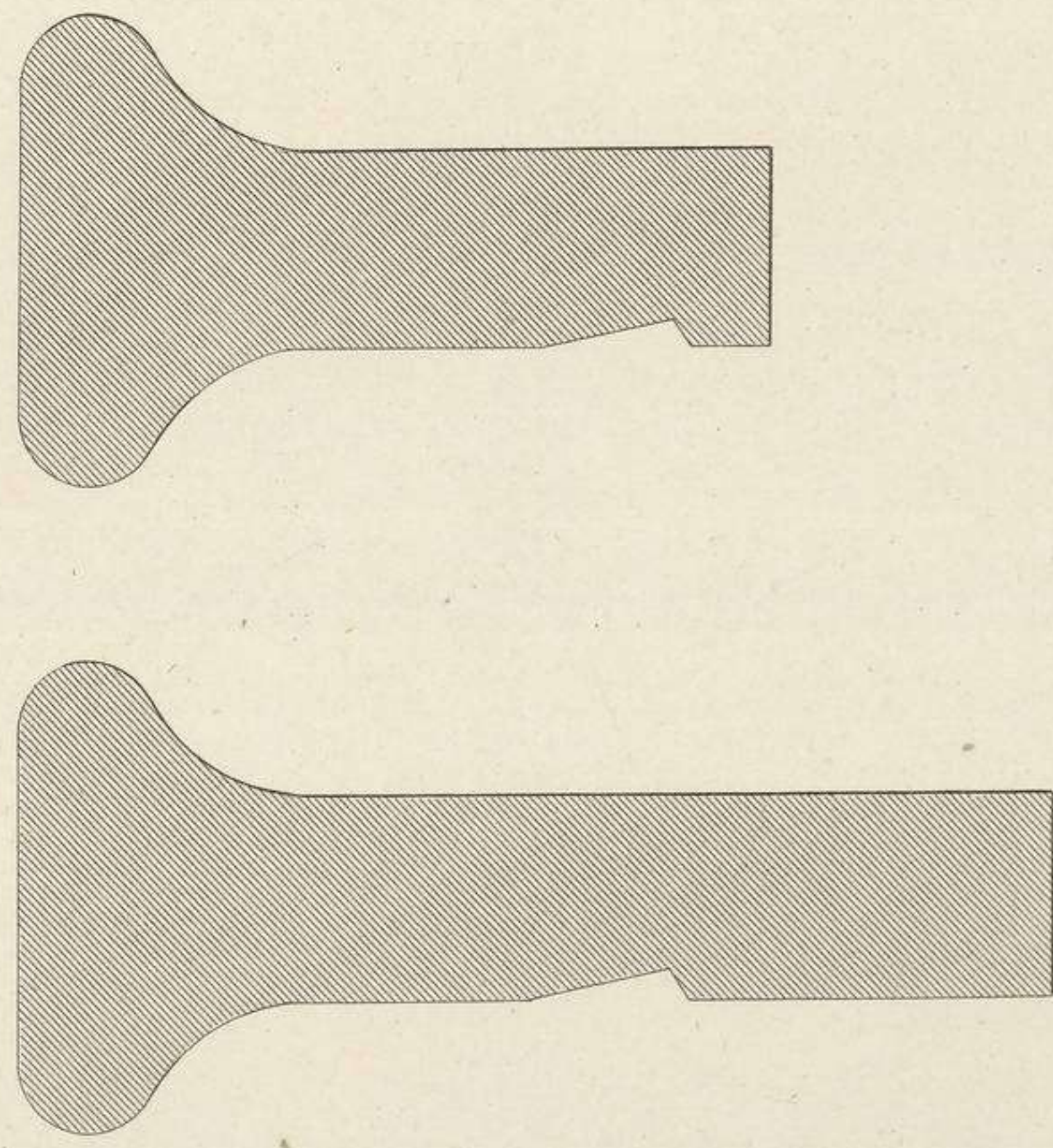

Fig. 10. (64. 65.)

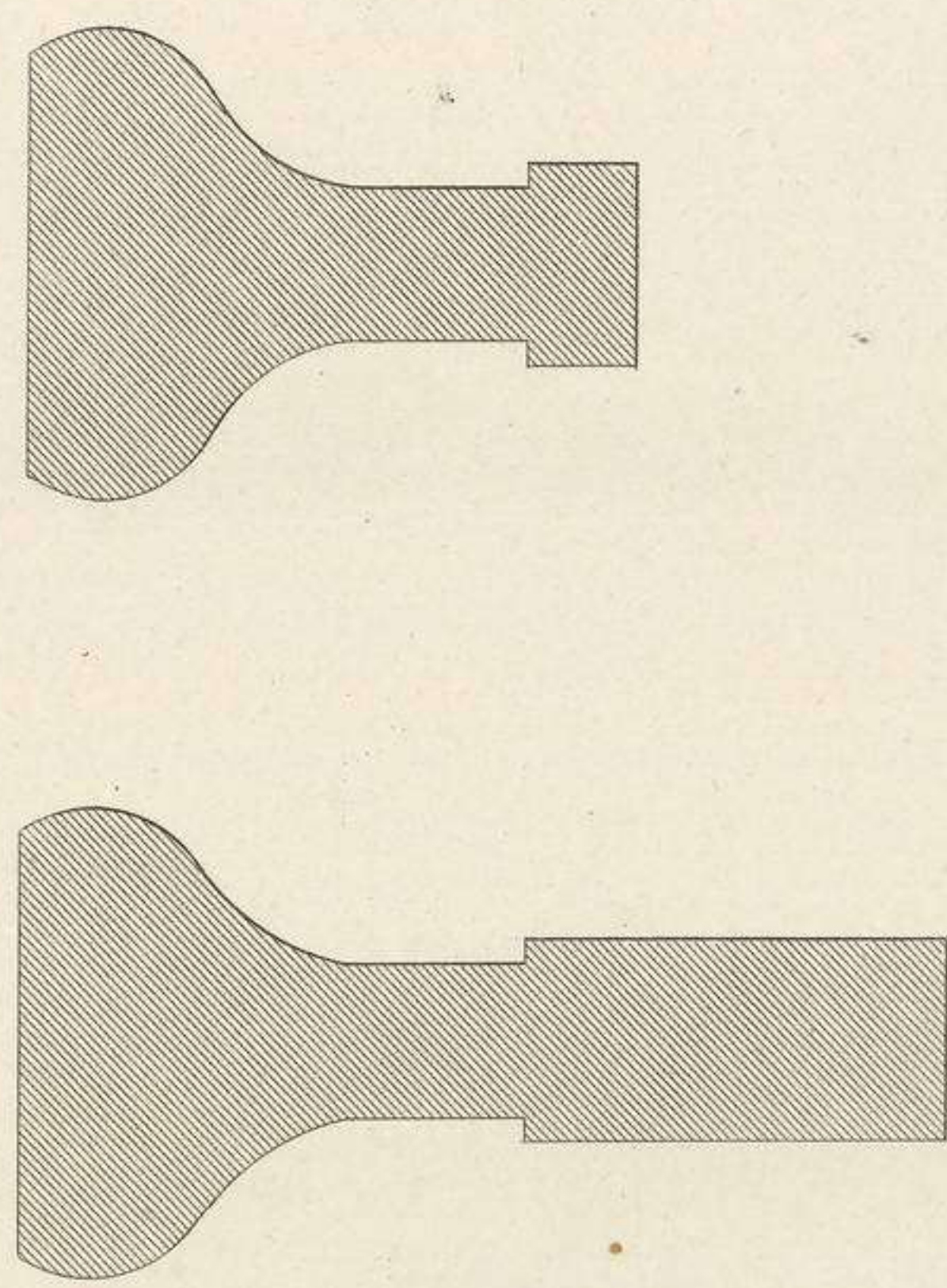

Fig. 11. (64. 65.)

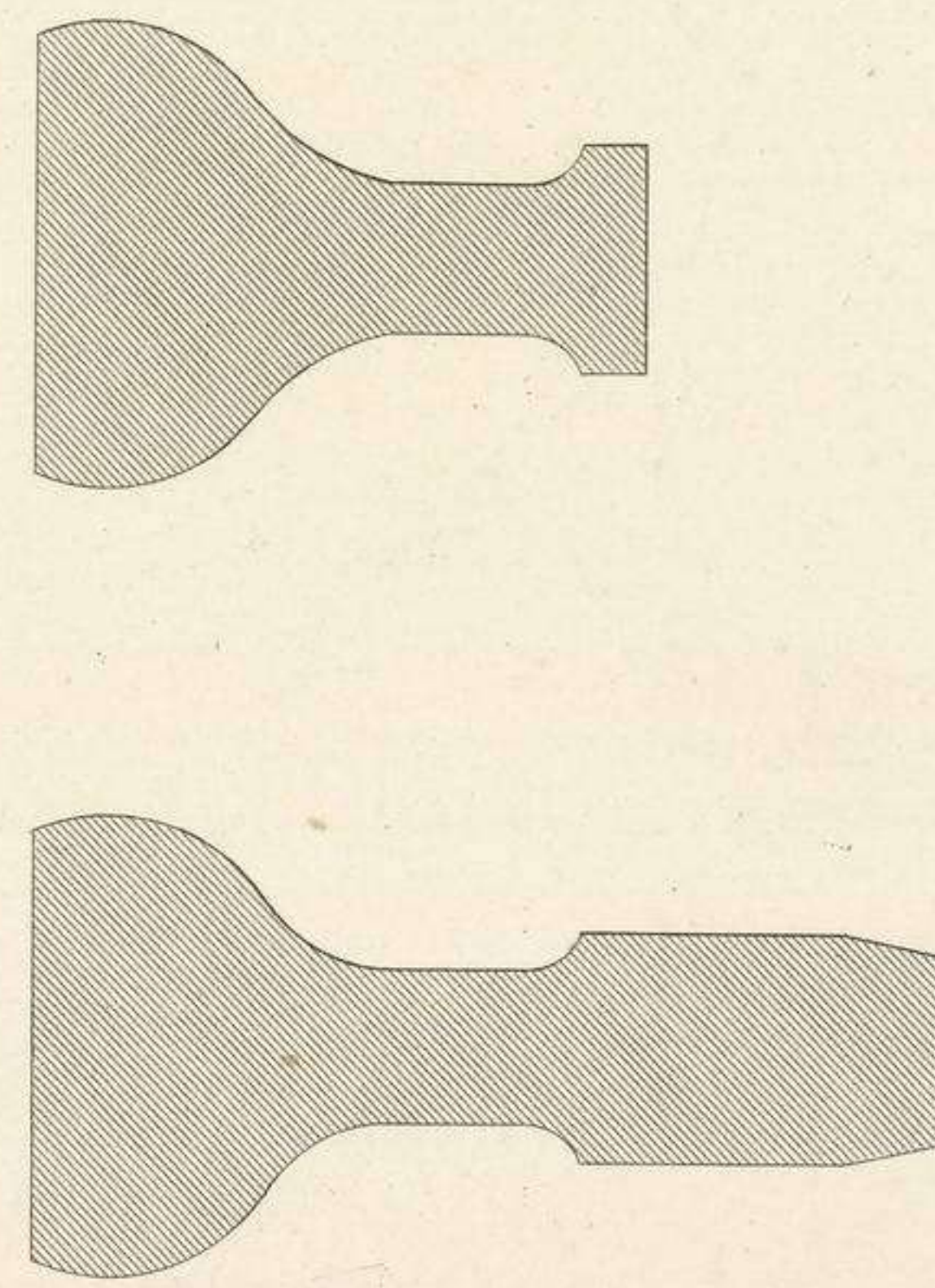

Fig. 12. (64. 65.)

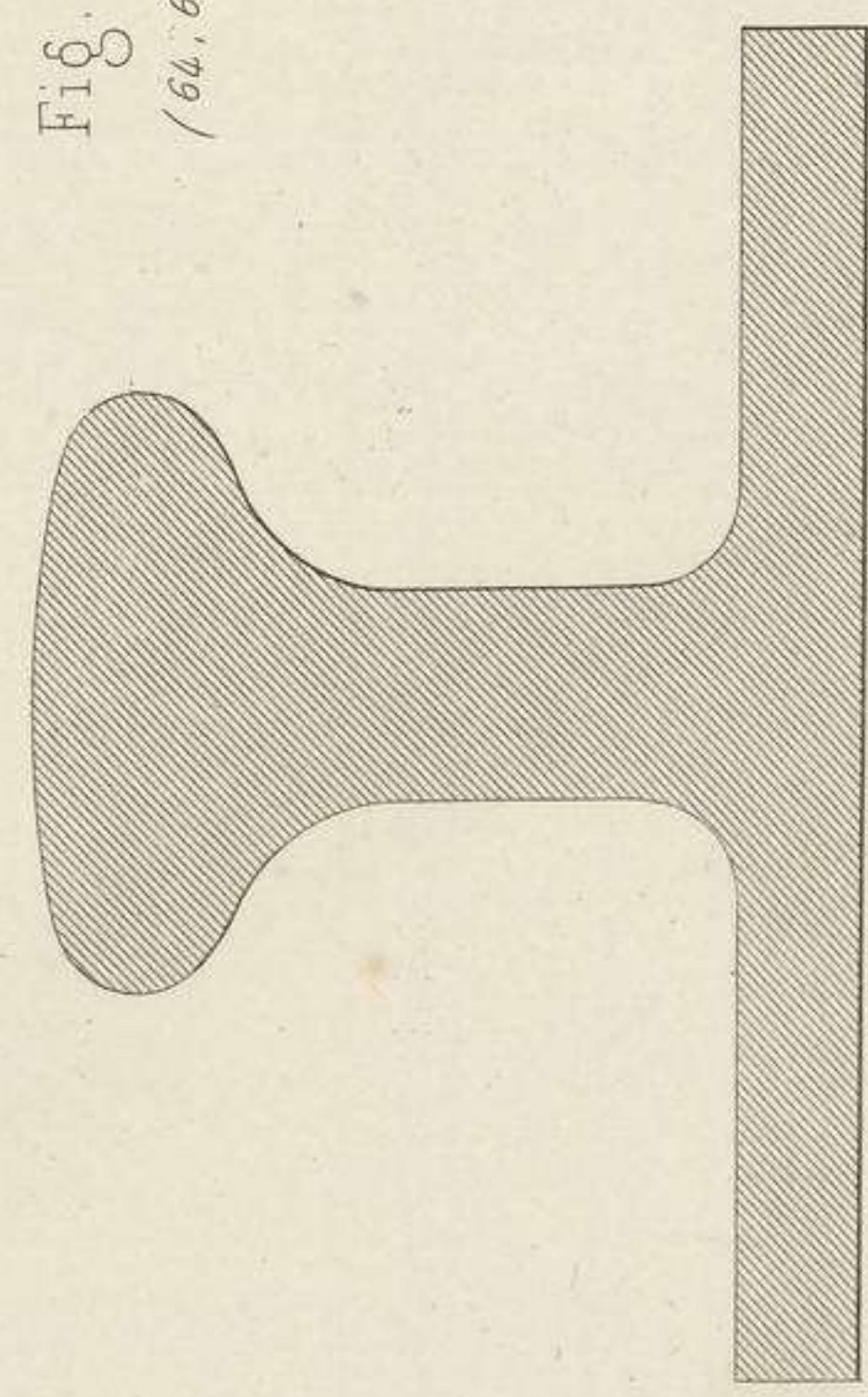

Fig. 13. (64. 65.)

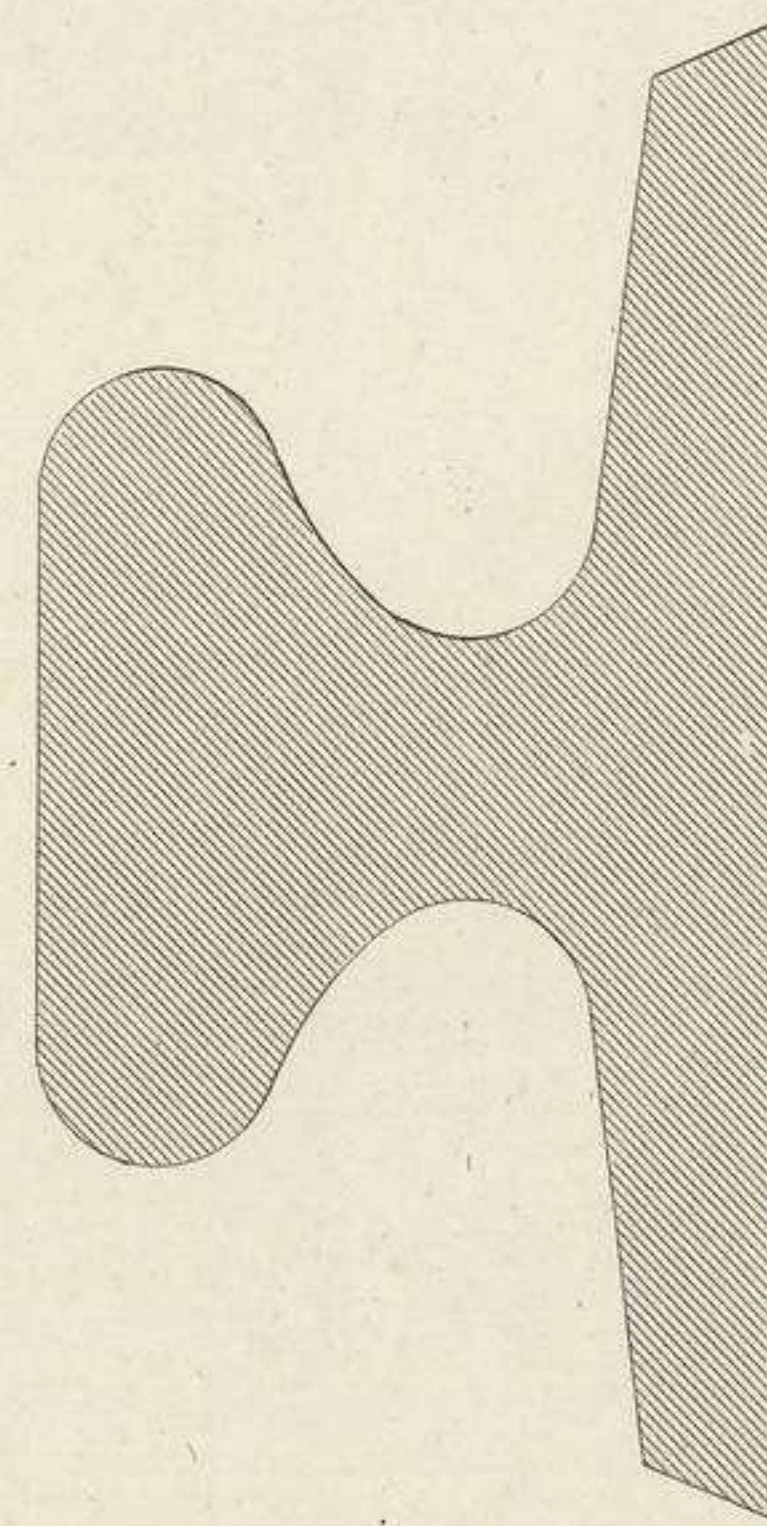

Fig. 14. (64. 65.)

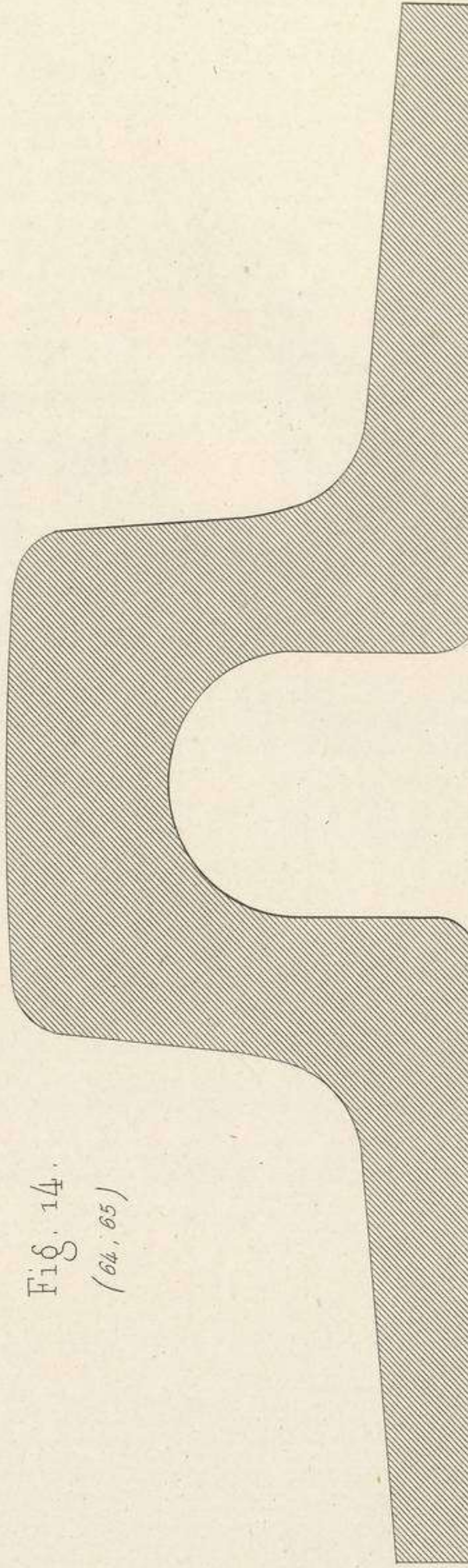



Fig. 1. / 65 /

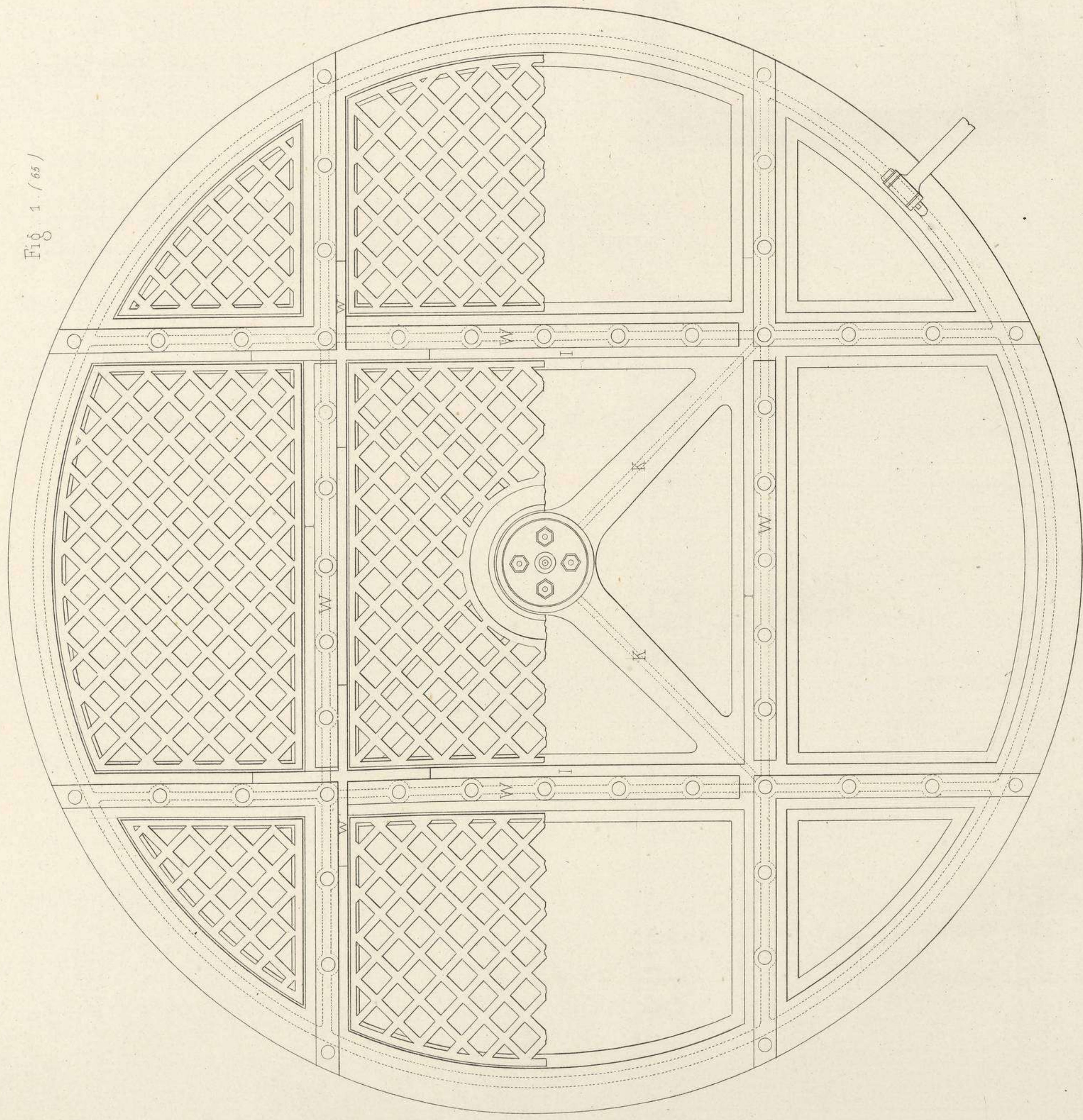

Fig. 2. / 65 /

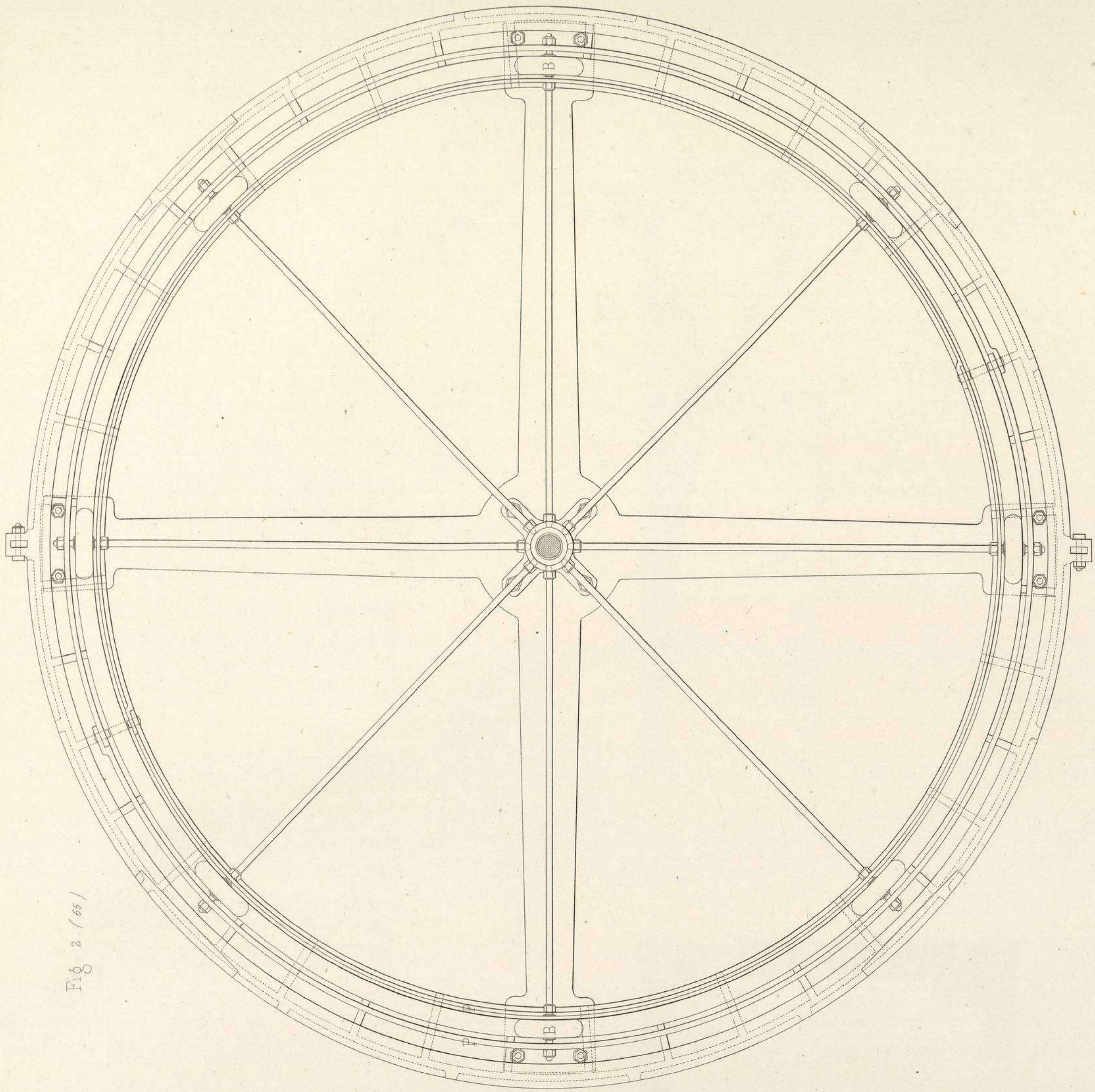

Fig. 4. / 65 /

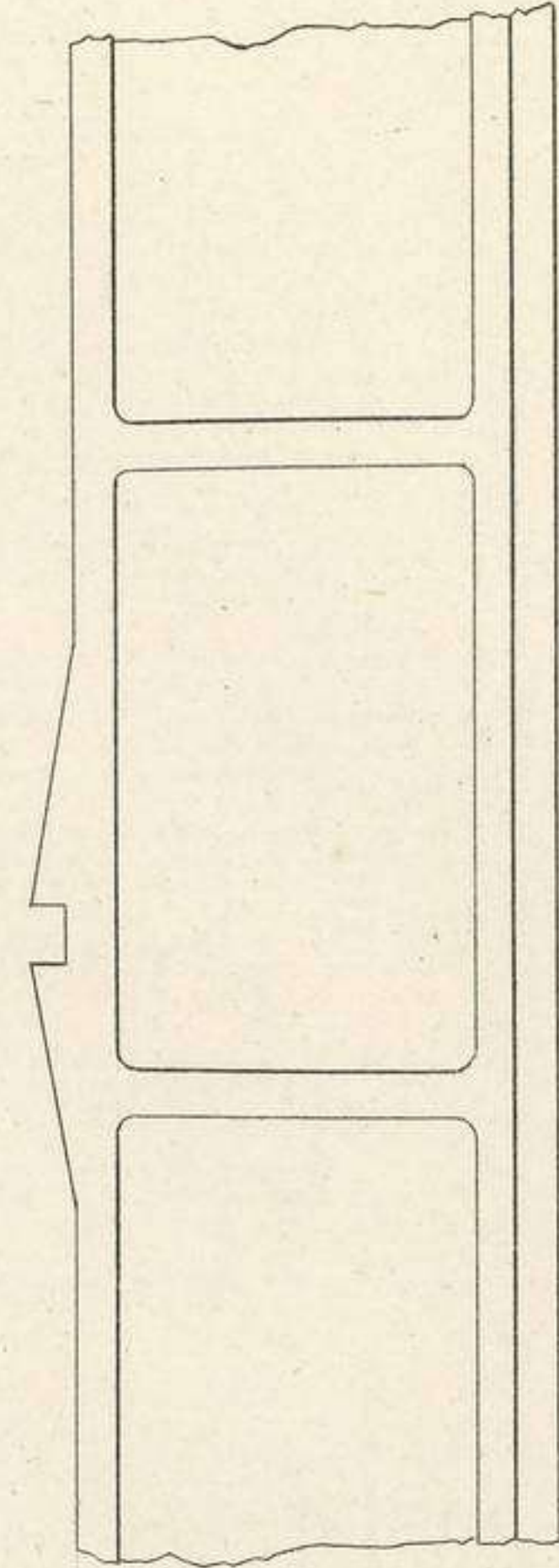
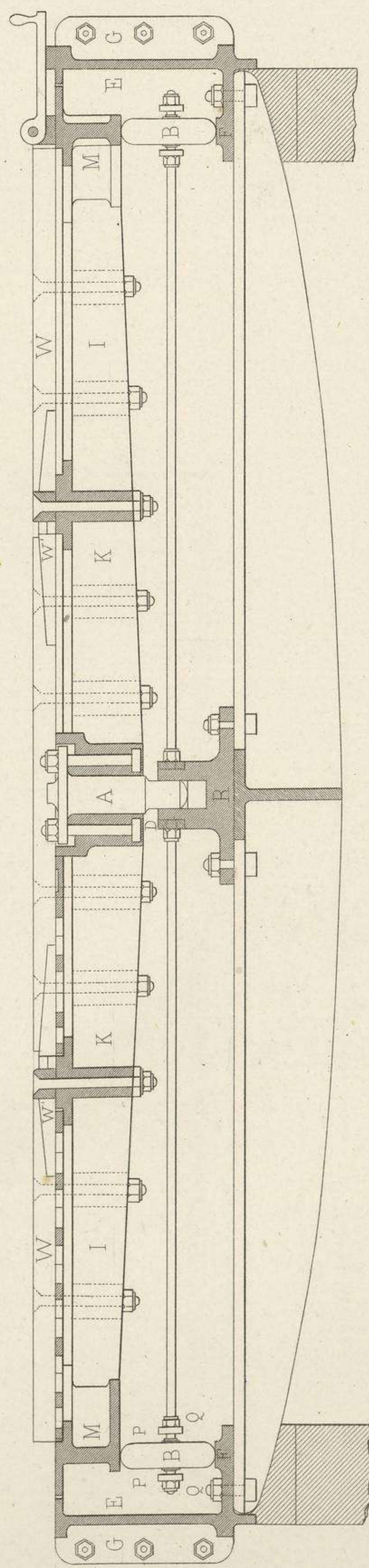

Fig. 5. / 65 /



CHEMINS DE FER.  
Plates-formes tournantes.

F. de V. del.

B. R.



Fig. 1. (71.)

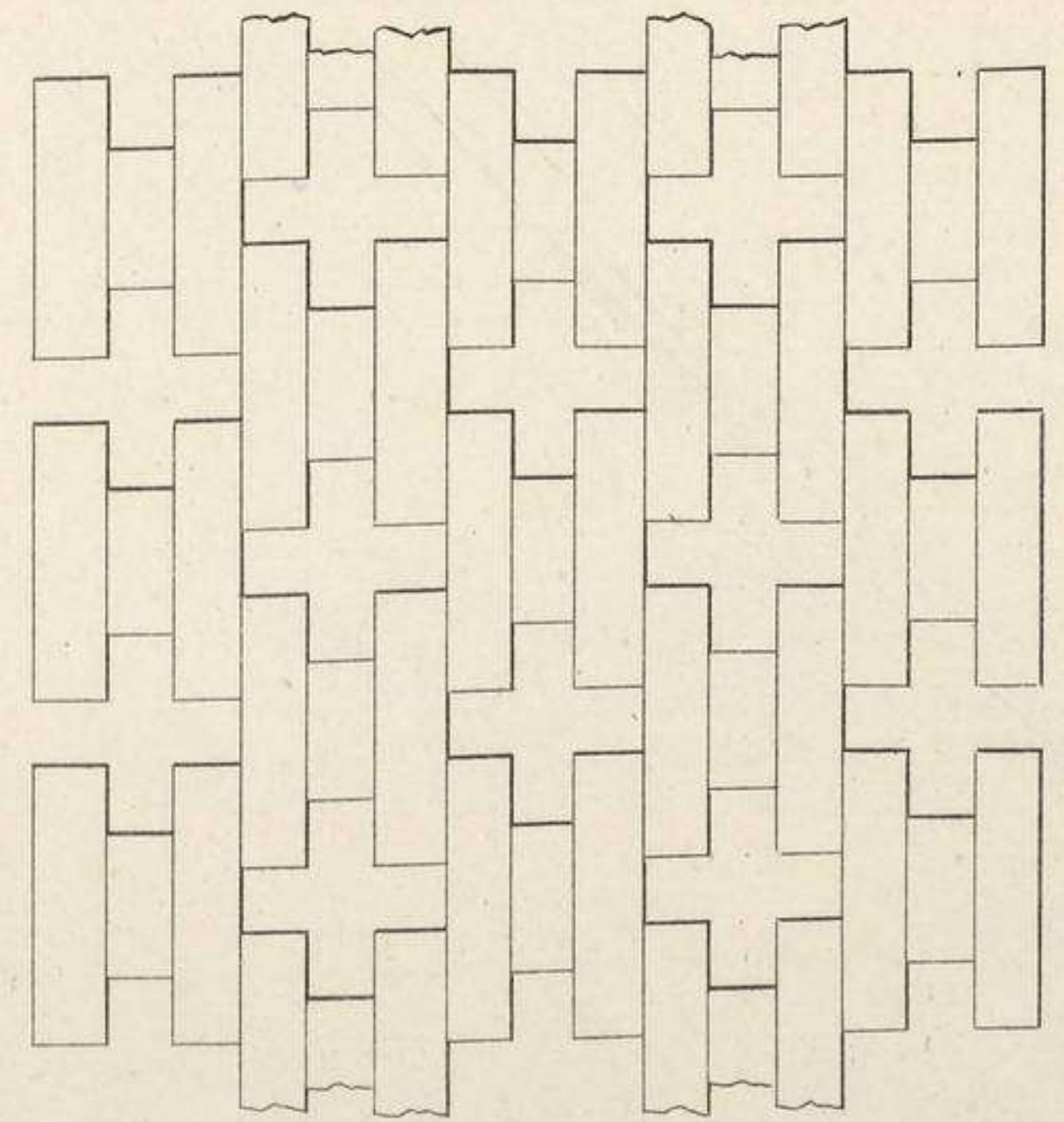

Fig. 2. (71.)

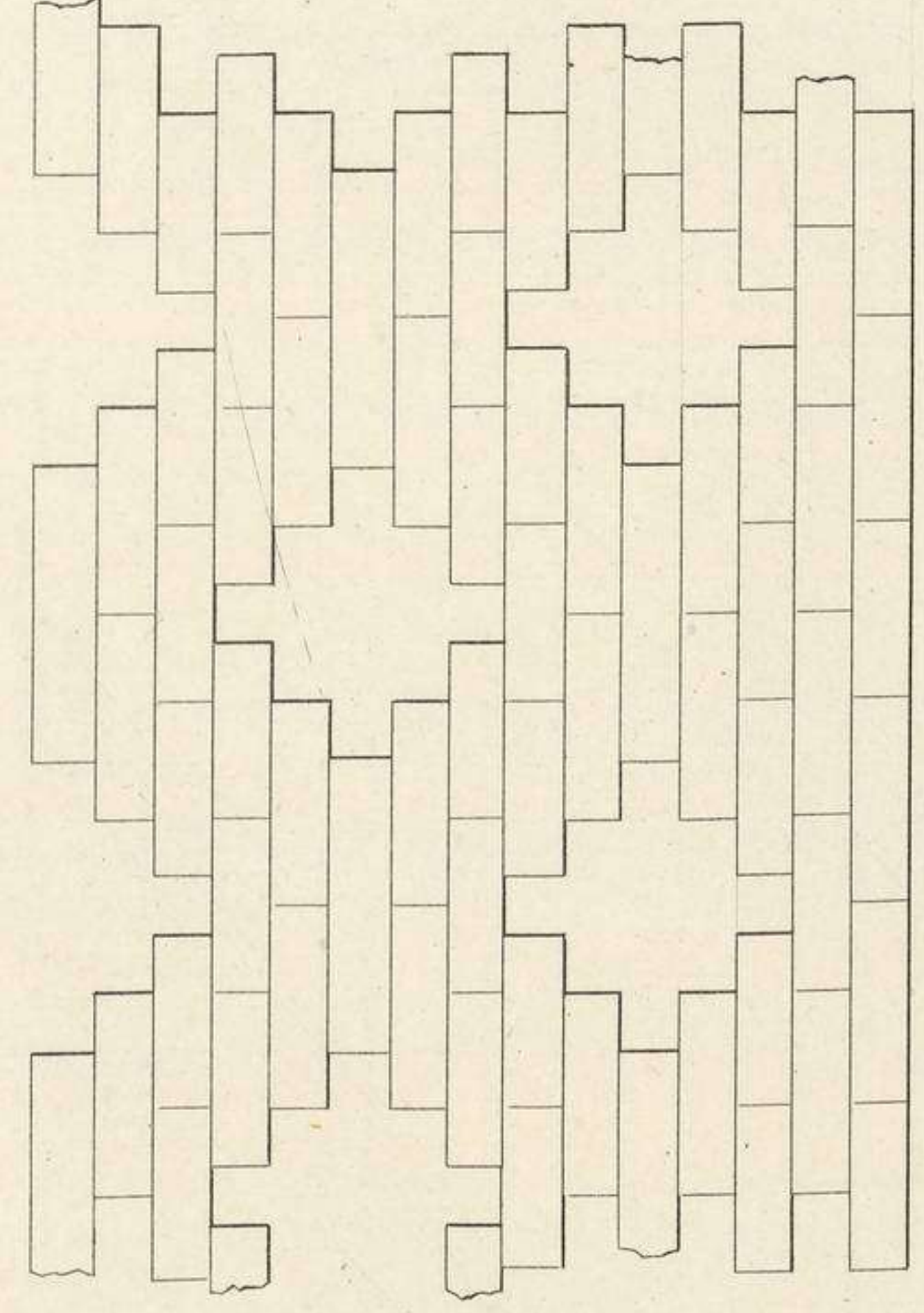

Fig. 3. (71.)

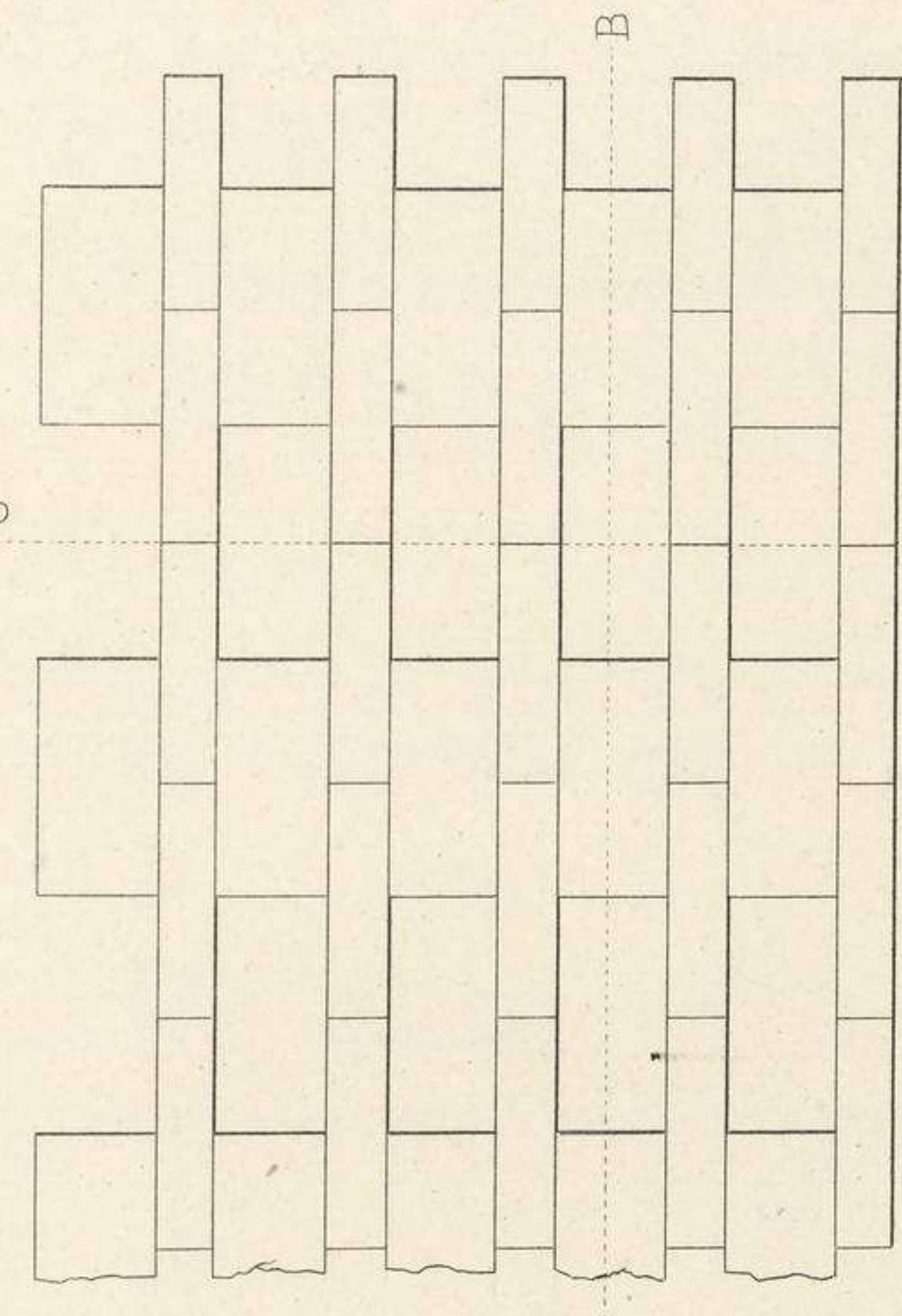

Fig. 5. (71.)

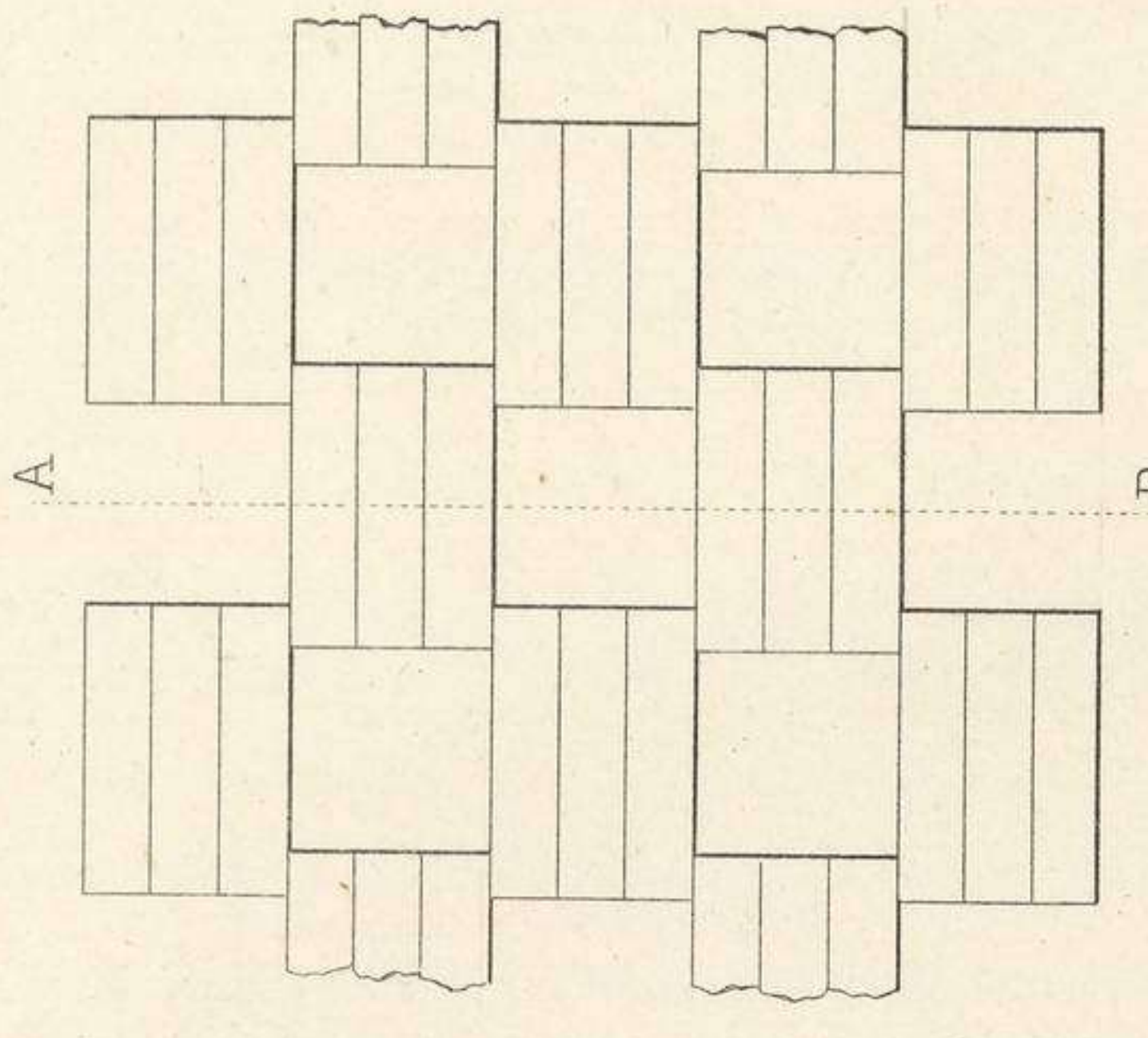
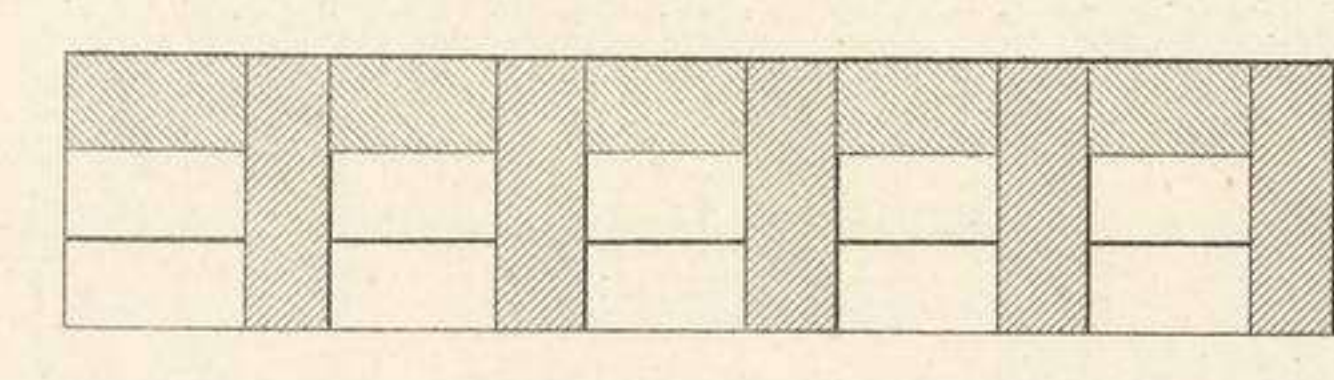

Fig. 7. (71.)

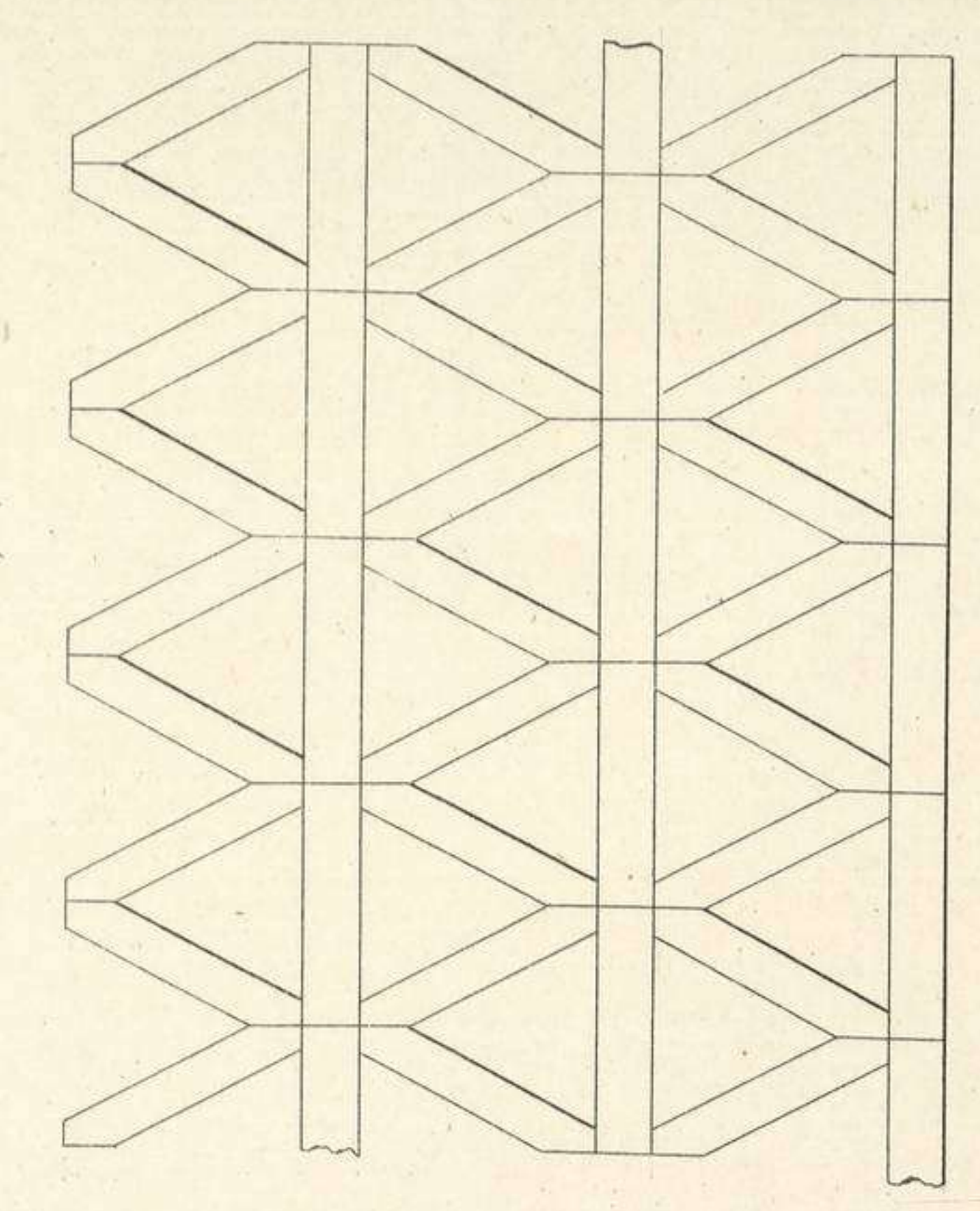

Fig. 8. (71.)

Fig. 9. (69.)

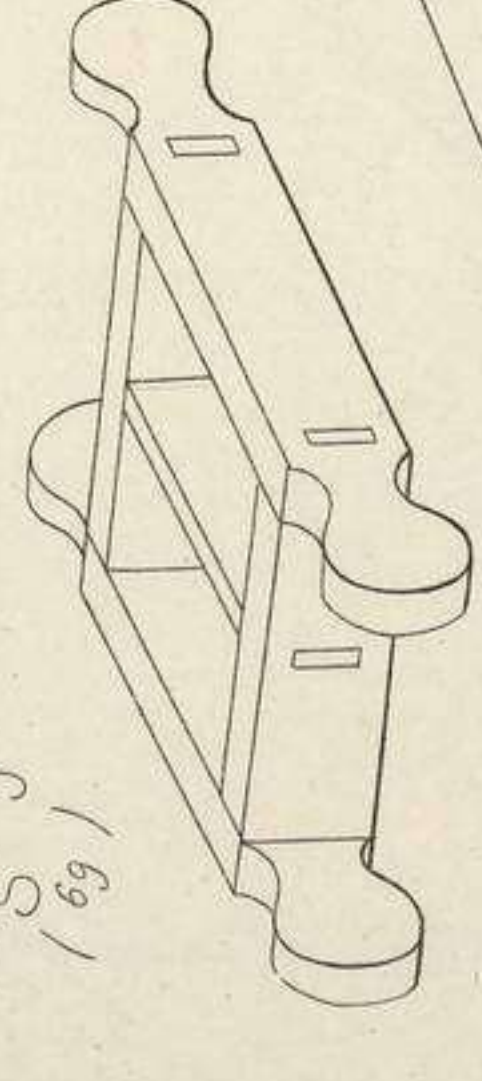

Fig. 10. (71.)

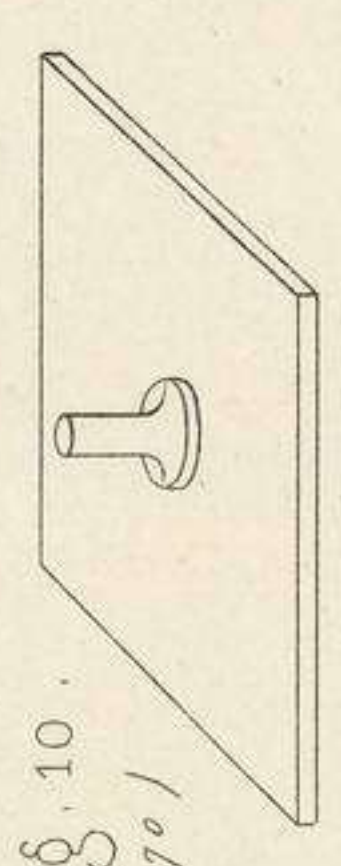

Fig. 13. (71.)

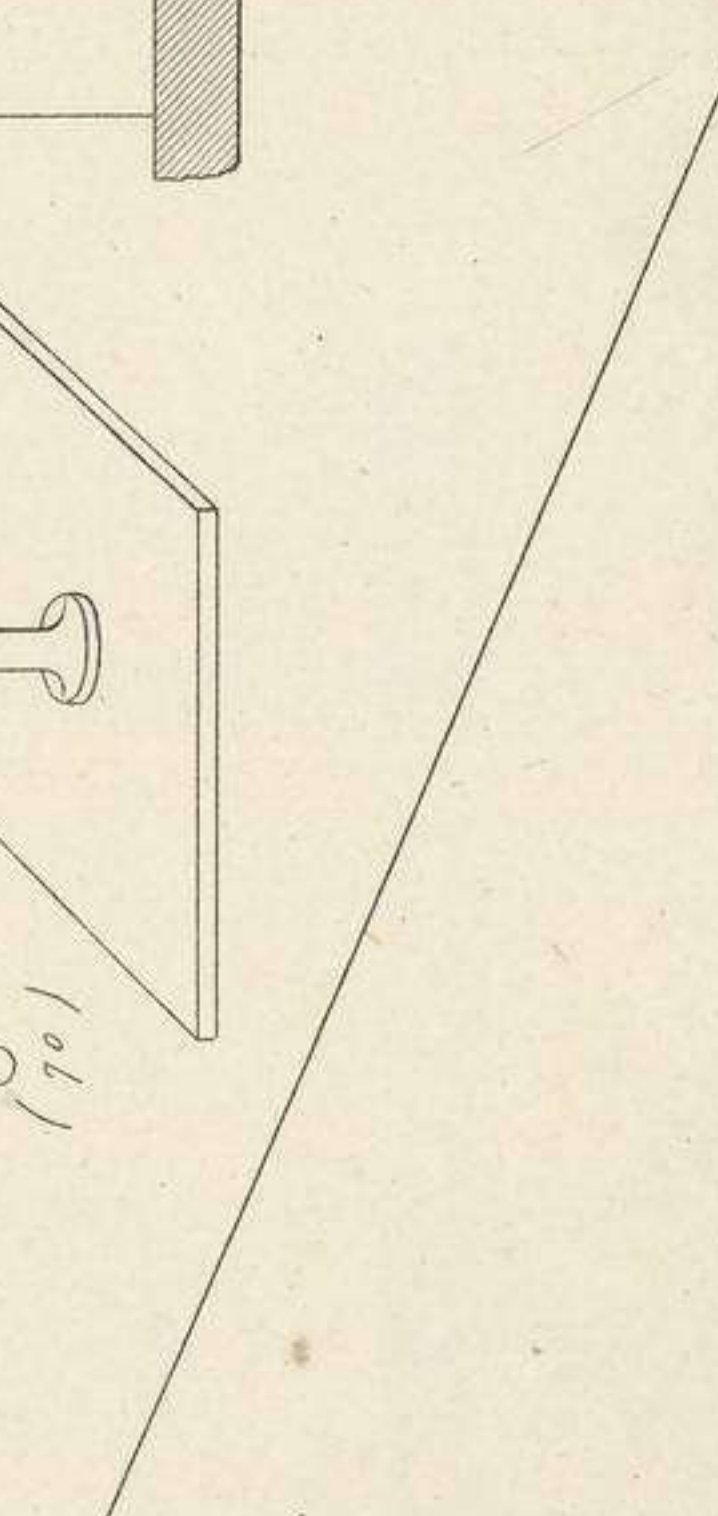

Fig. 4. (71.)

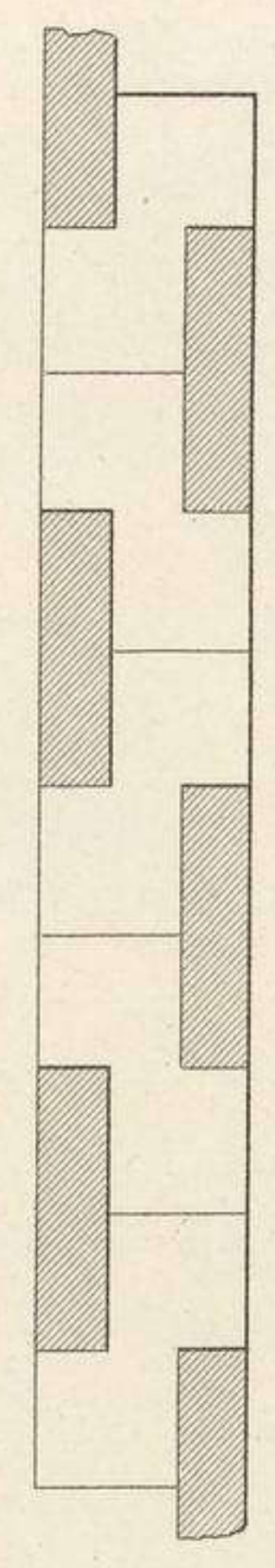

Fig. 11. (69.)

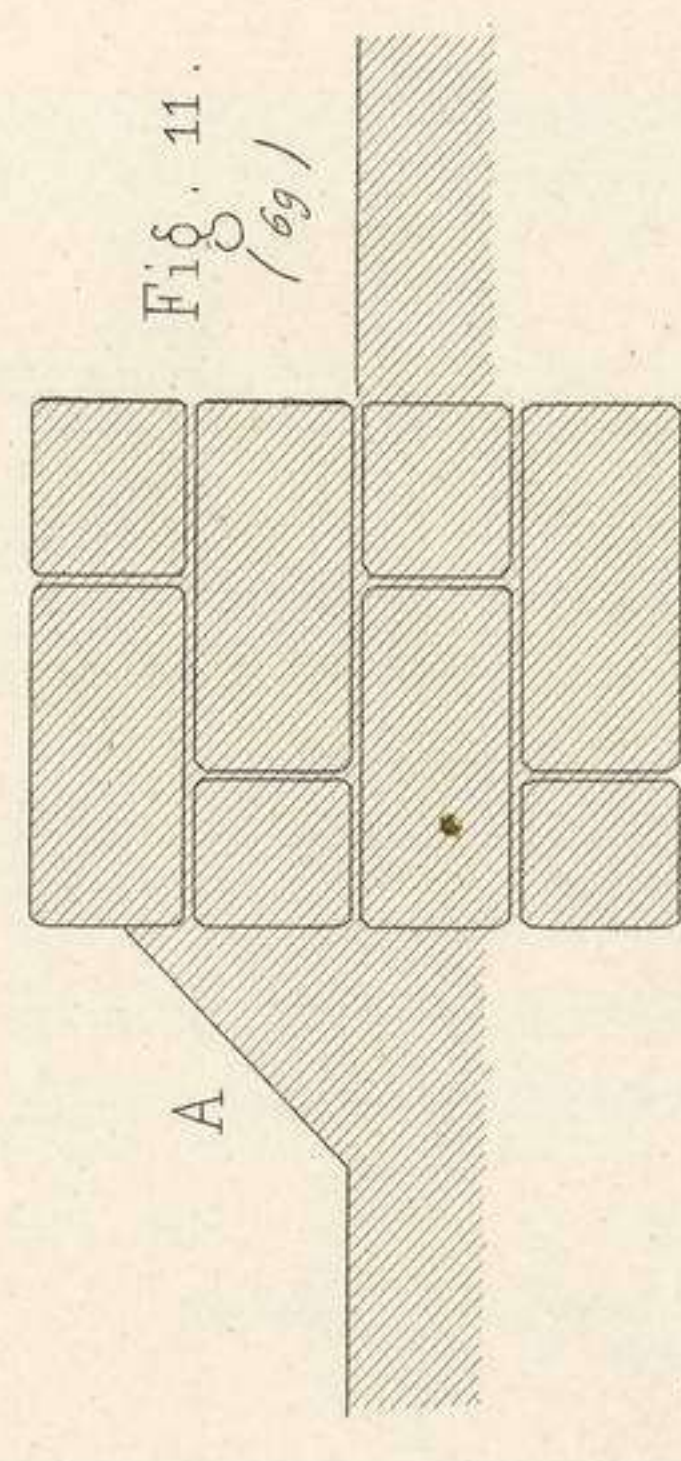

Fig. 12. (70.)

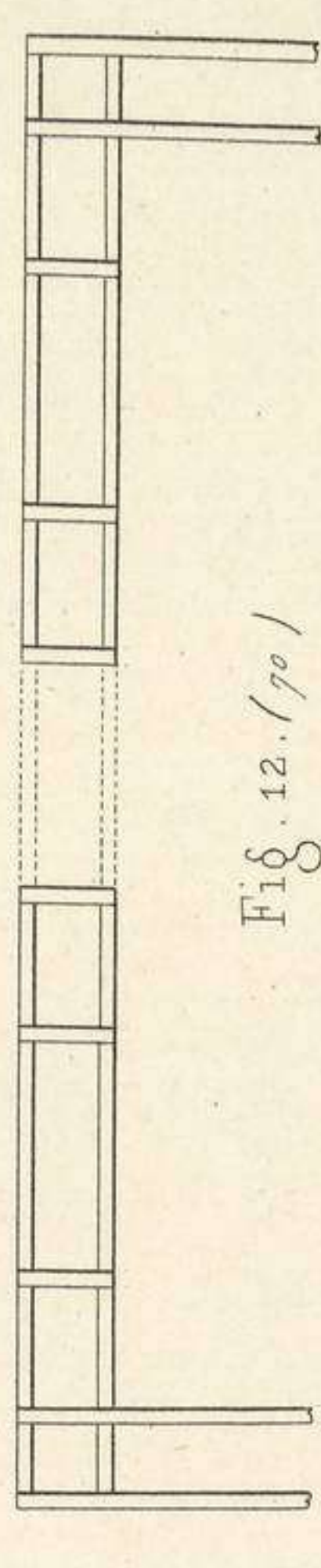

Fig. 16. (69.)

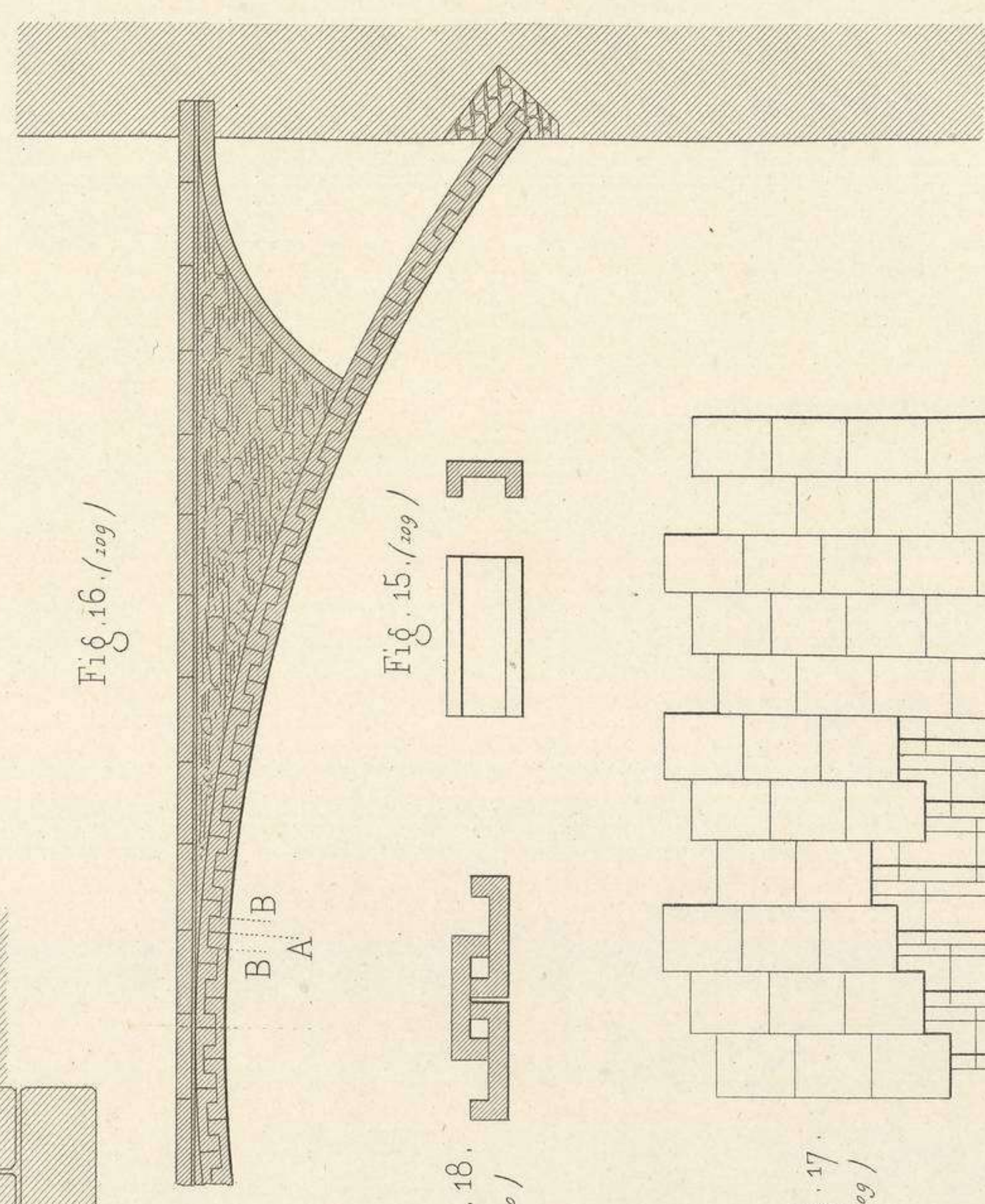

Fig. 15. (69.)

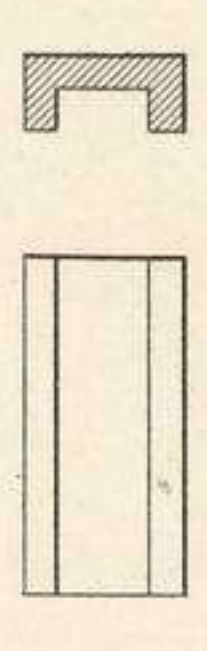

Fig. 18. (69.)

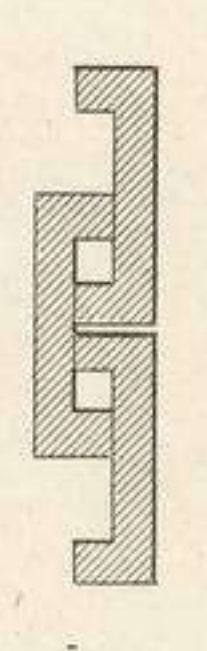

Fig. 17. (69.)

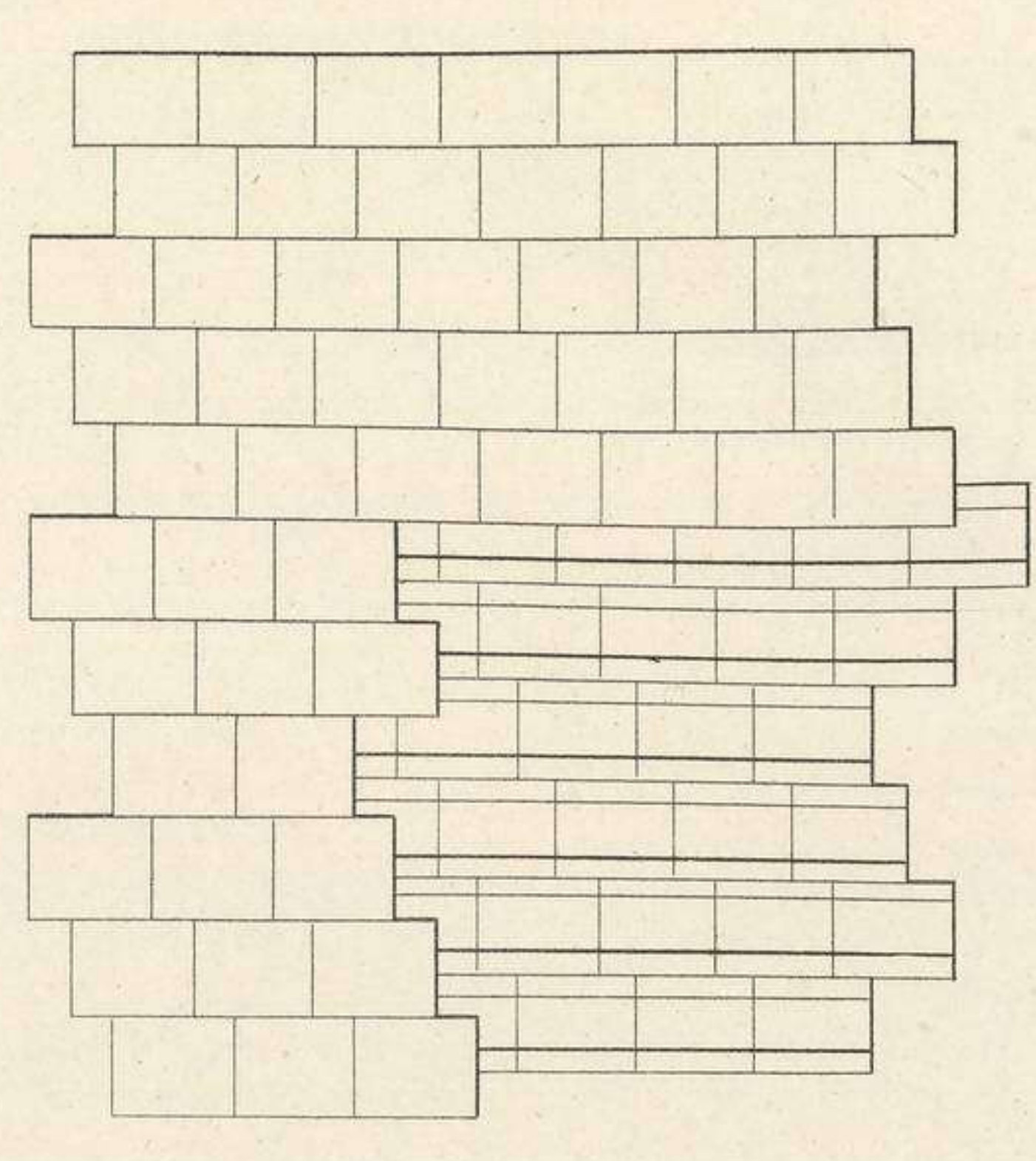
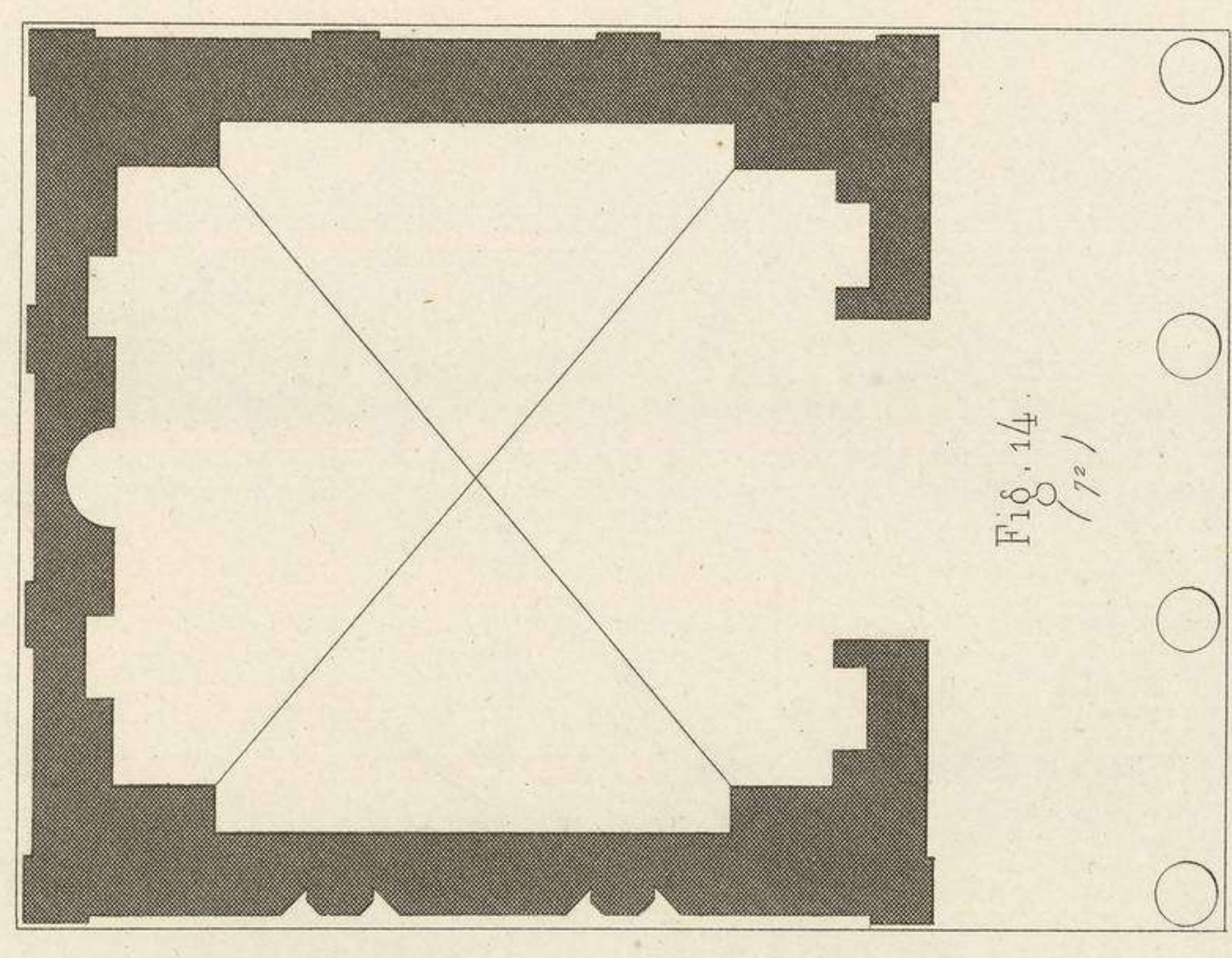

Fig. 14. (71.)



Echelle de la Fig. 13.



Echelle de la Fig. 16.

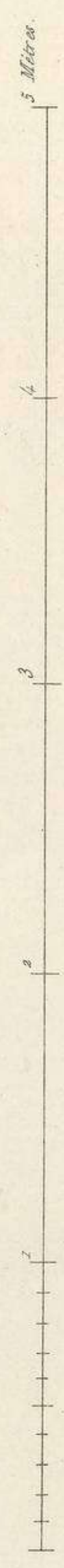

Echelle des Fig. 1, 2, 3, 4, 5, 6, 7, 8.





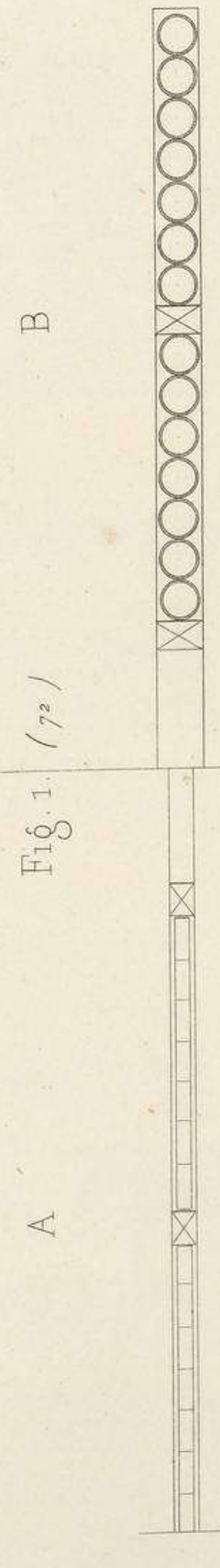
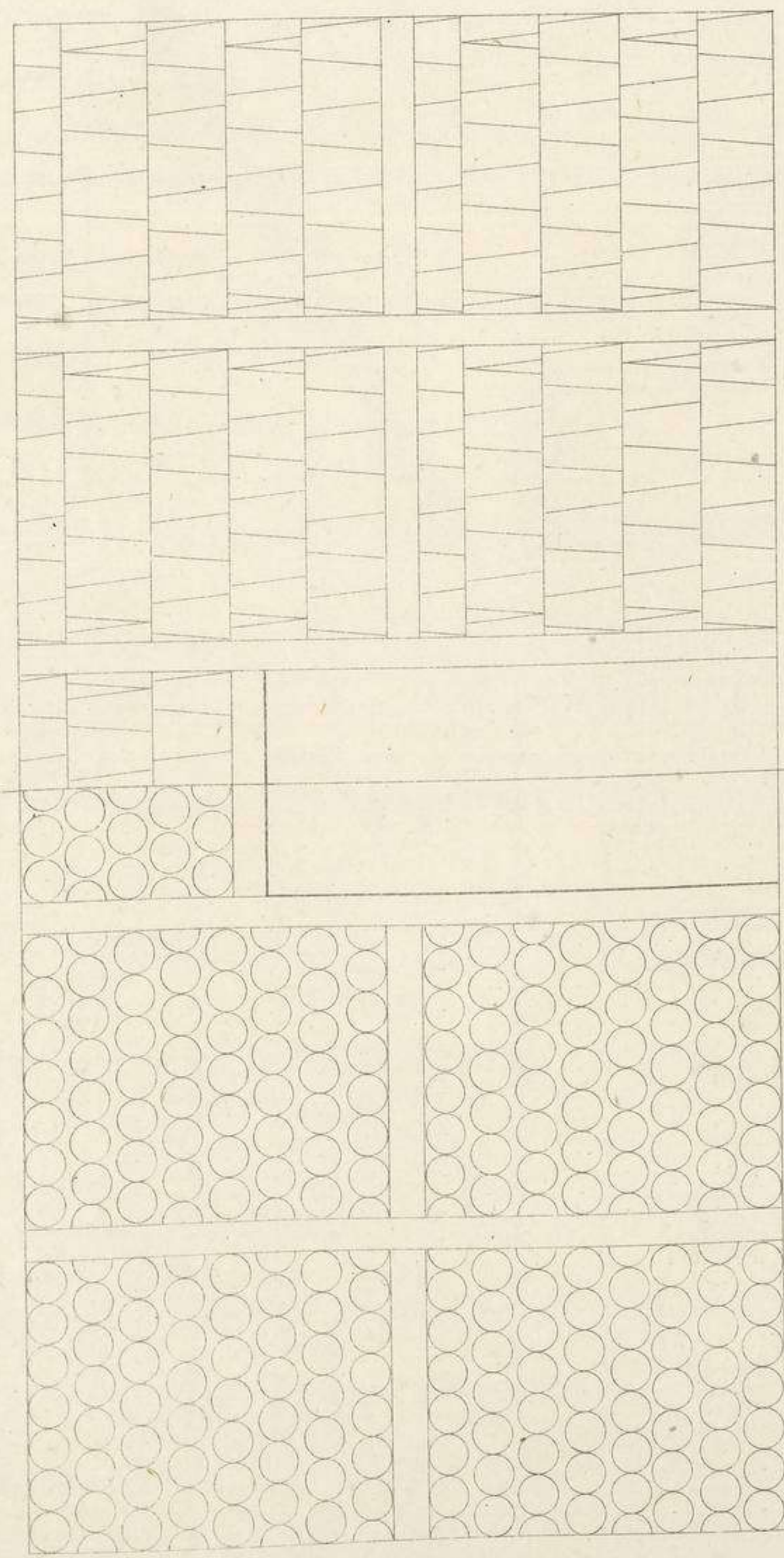

Fig. 2 (72)

Fig. 3 (73)

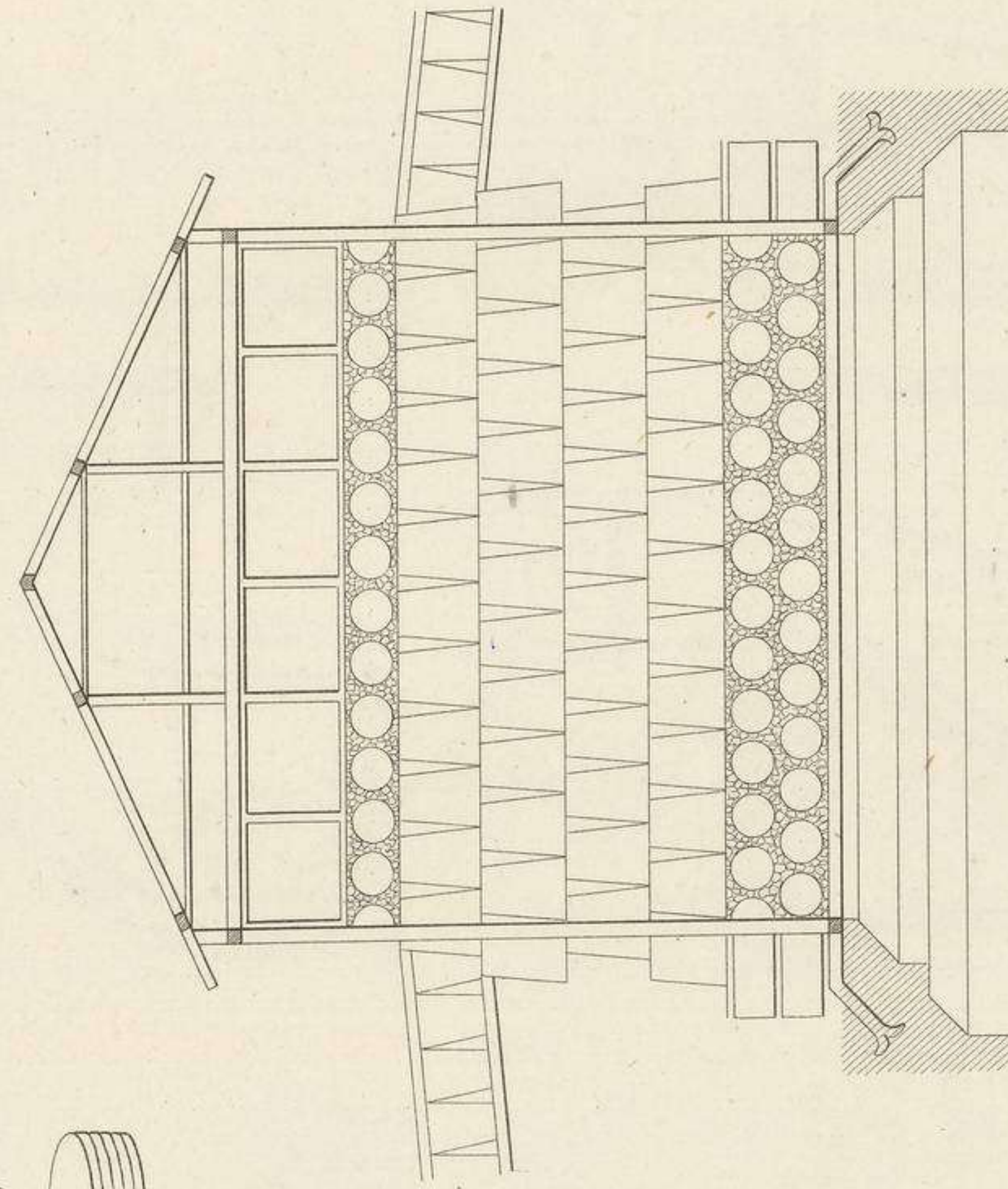

Fig. 7 (73, 74)

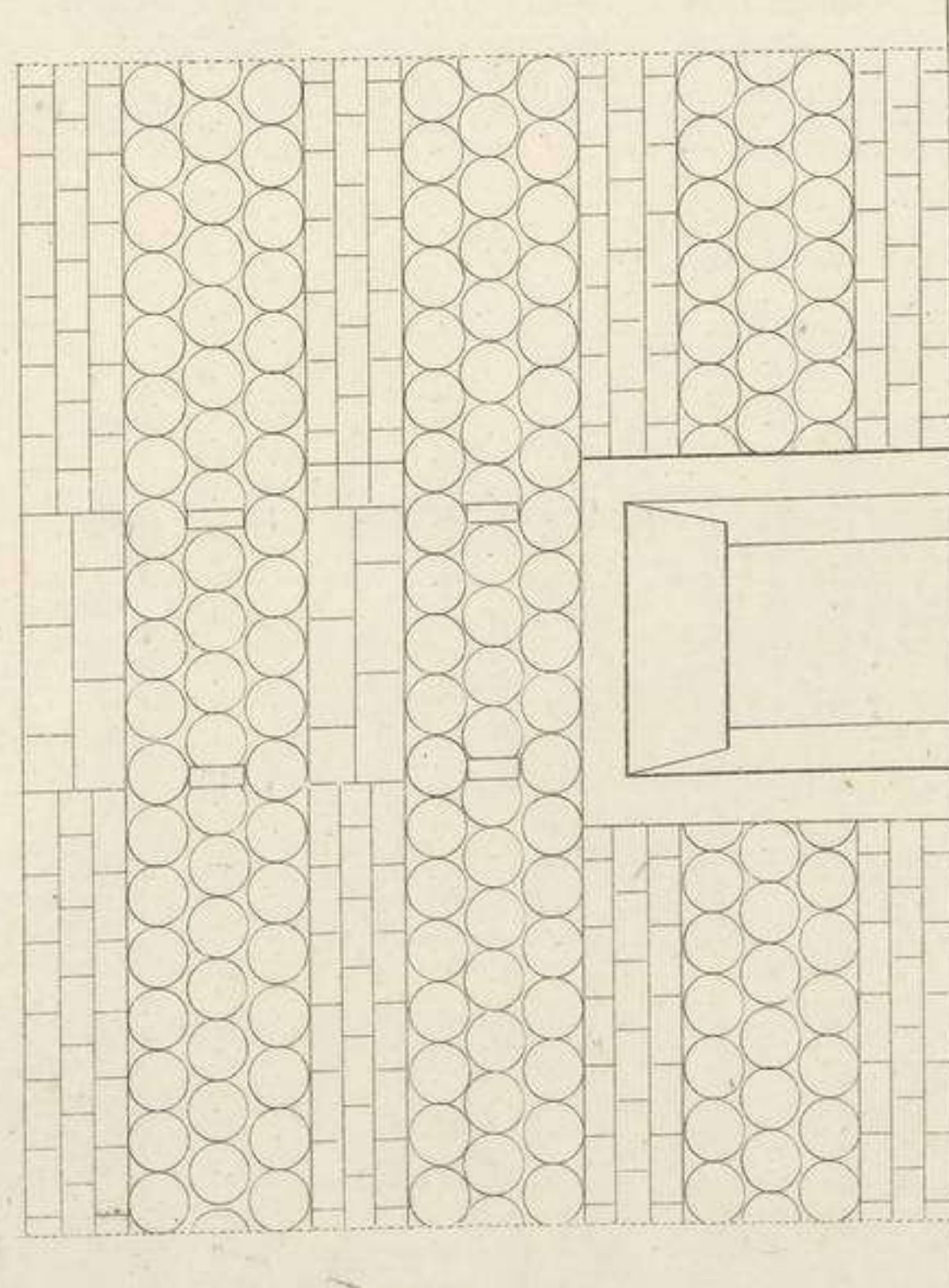

Fig. 8 (74)

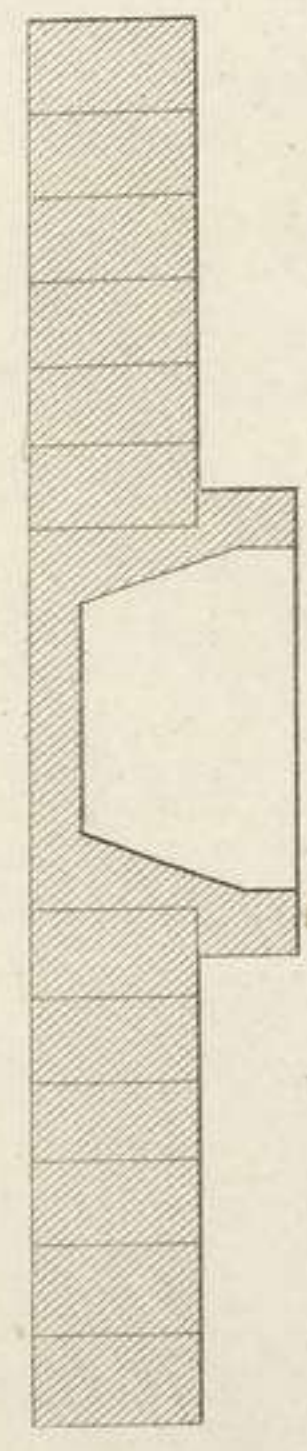
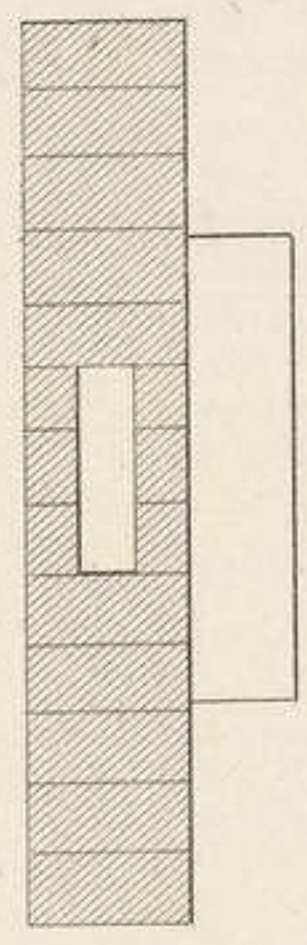

Fig. 9 (74)



Echelle des Fig. 10, 11, 12, 13, 14.

Echelle des Fig. 1, 3, 7, 8, 9, 14.



Fig. 4 (74)

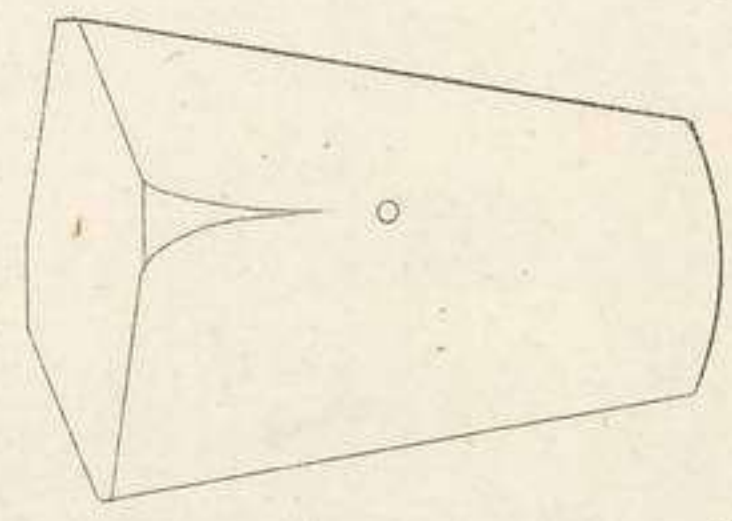

Fig. 5 (73)

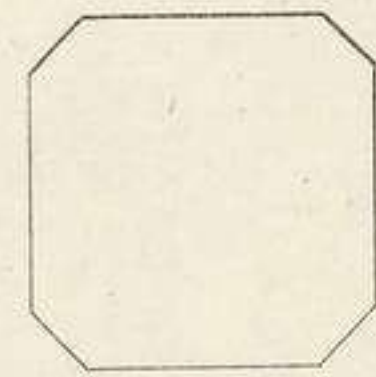

Fig. 6 (73)

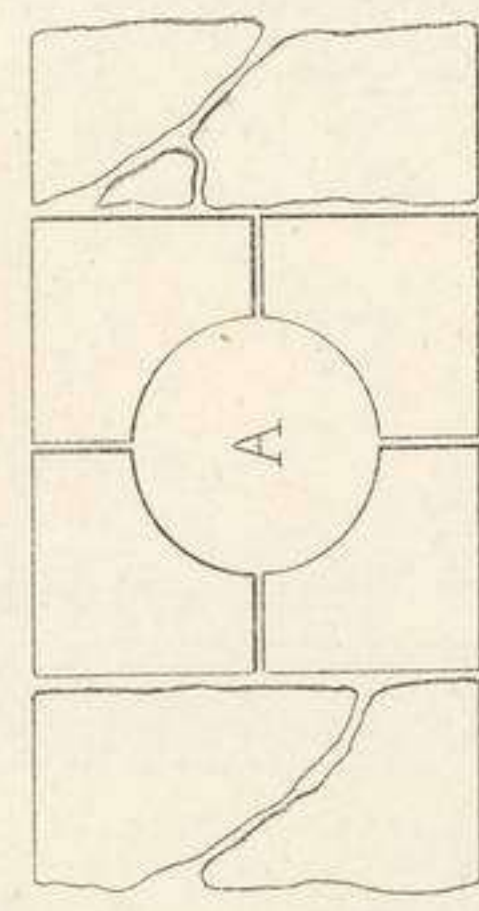
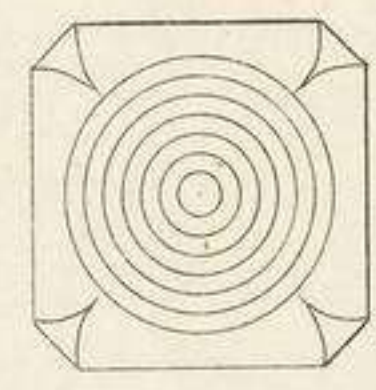

Fig. 10 (77)

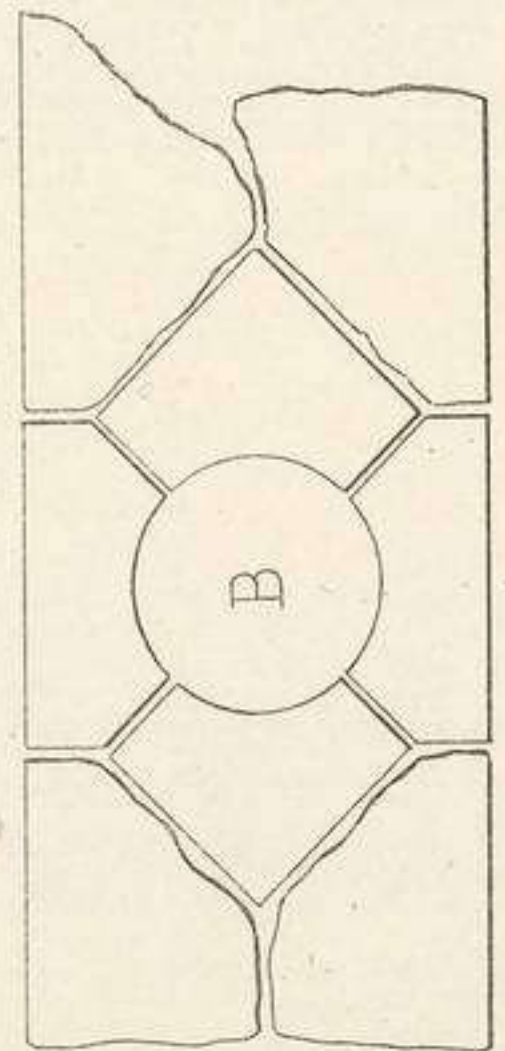

Fig. 11 (77)

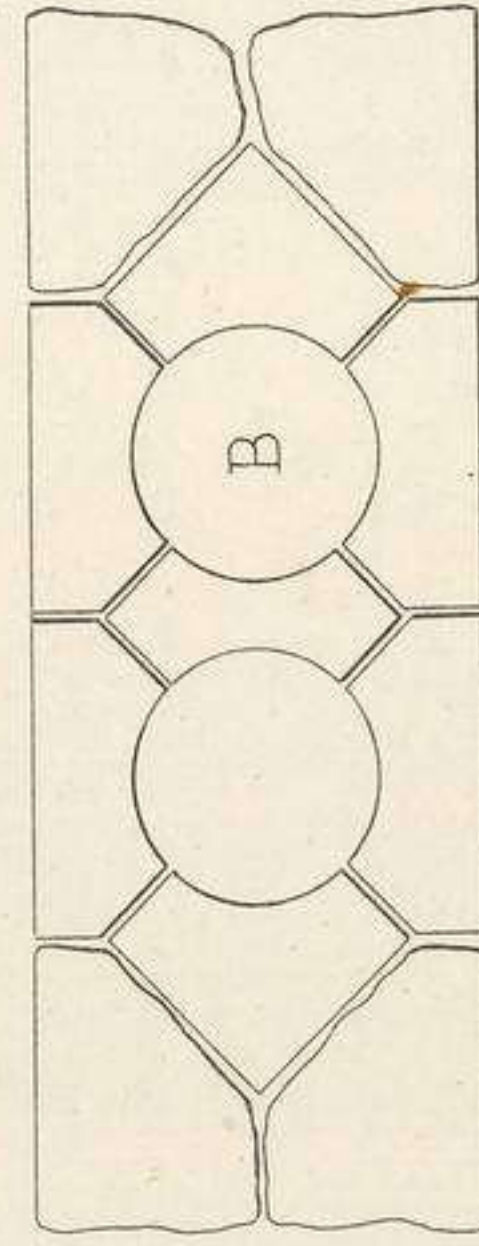

Fig. 12 (77)

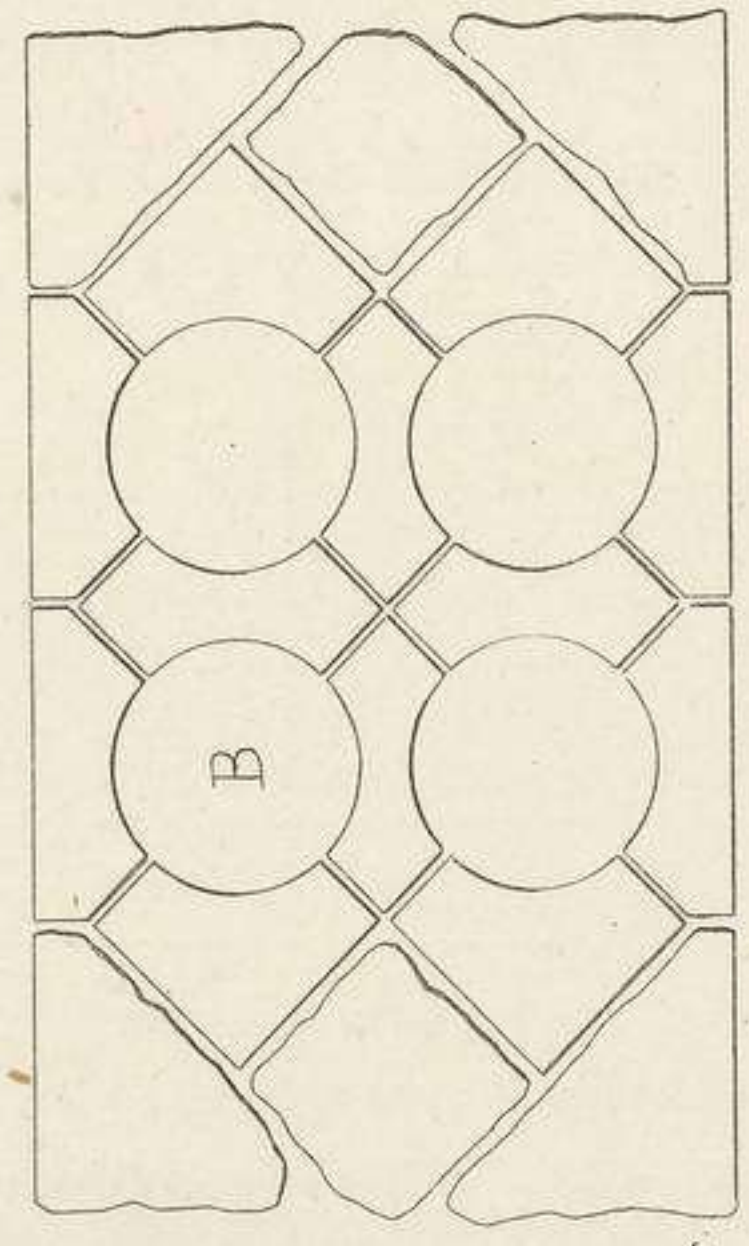

Fig. 13 (78)

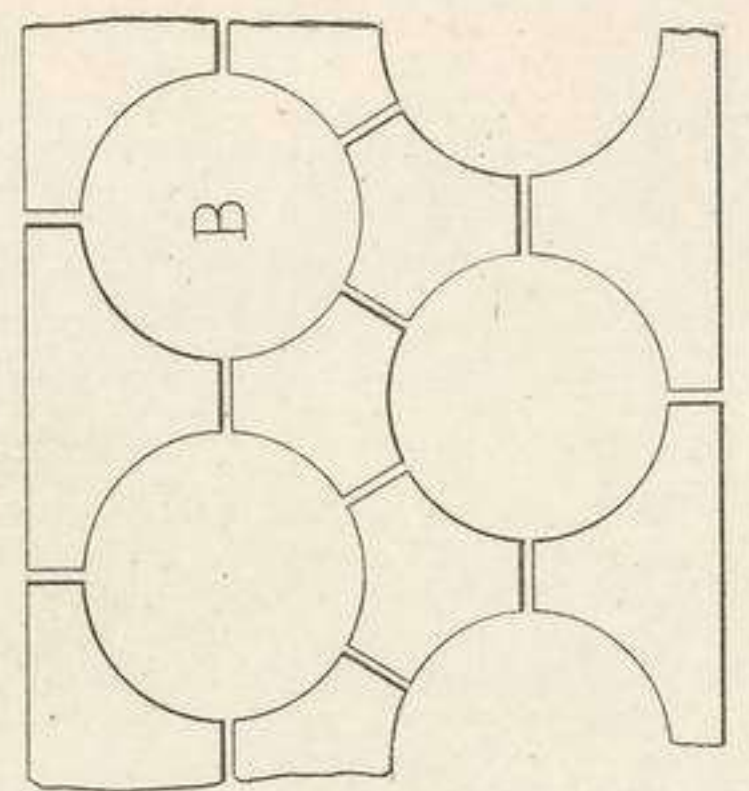

Fig. 14 (78)

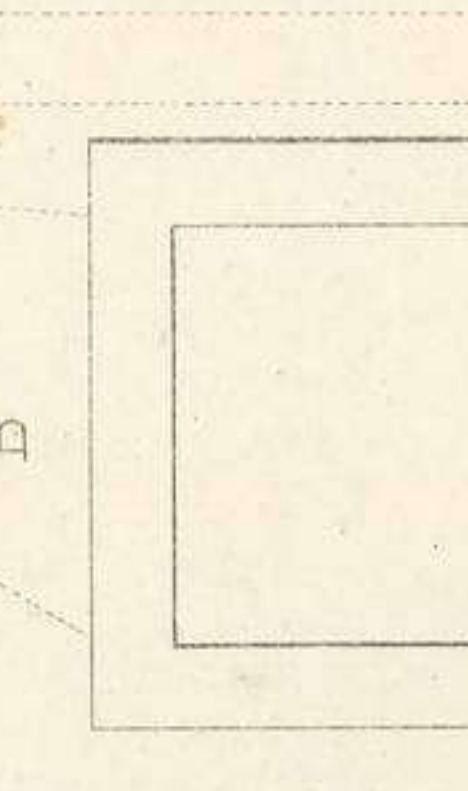

Fig. 15 (78)

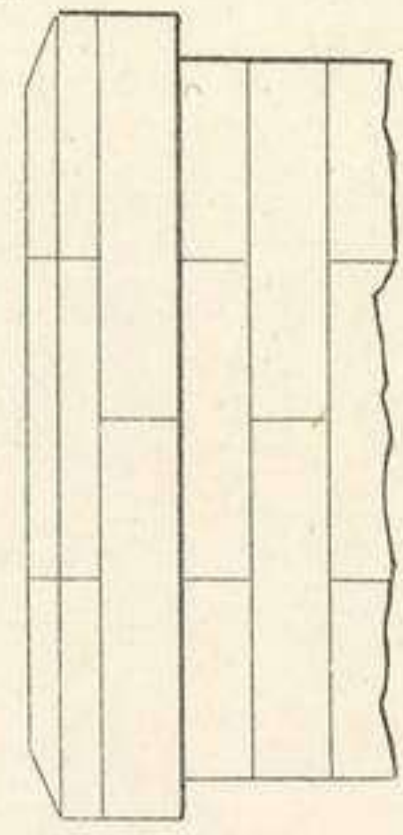

Fig. 17 (78)

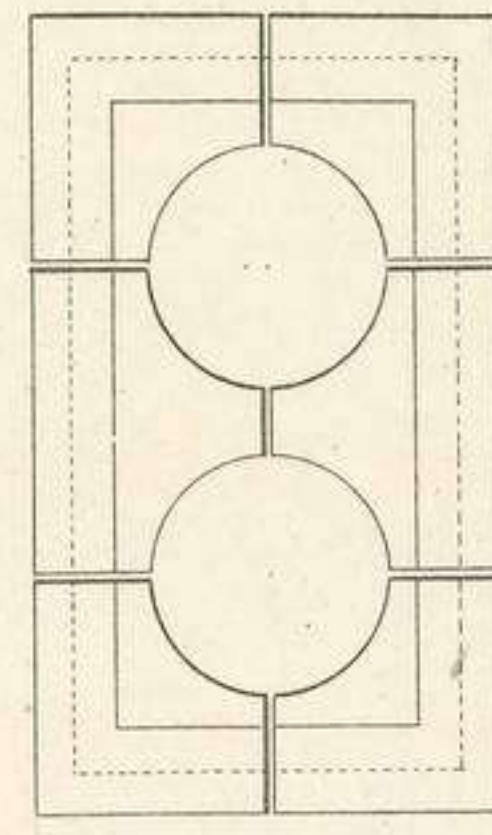

Fig. 18 (78)

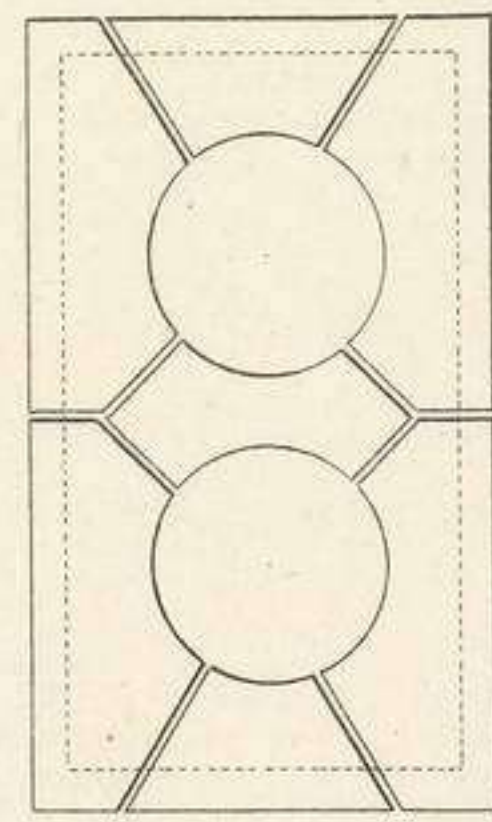

Fig. 19 (78)

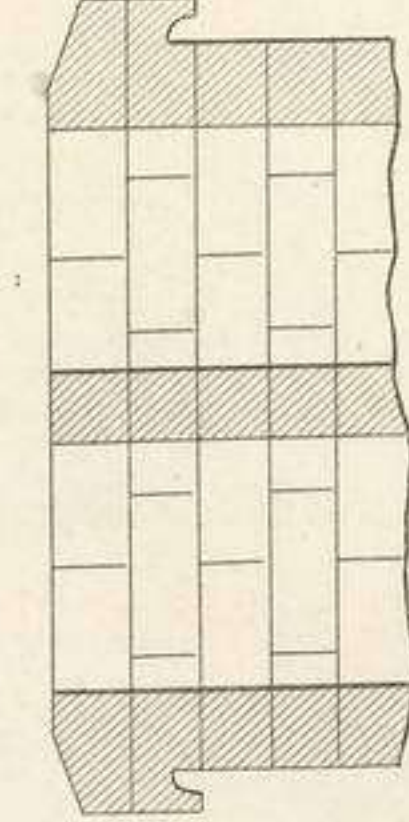

Fig. 20 (79)

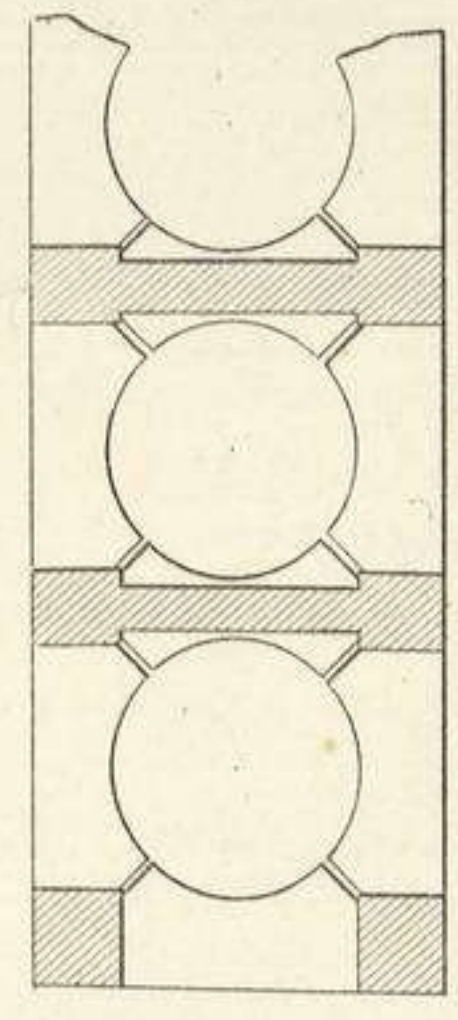

Fig. 21 (79)

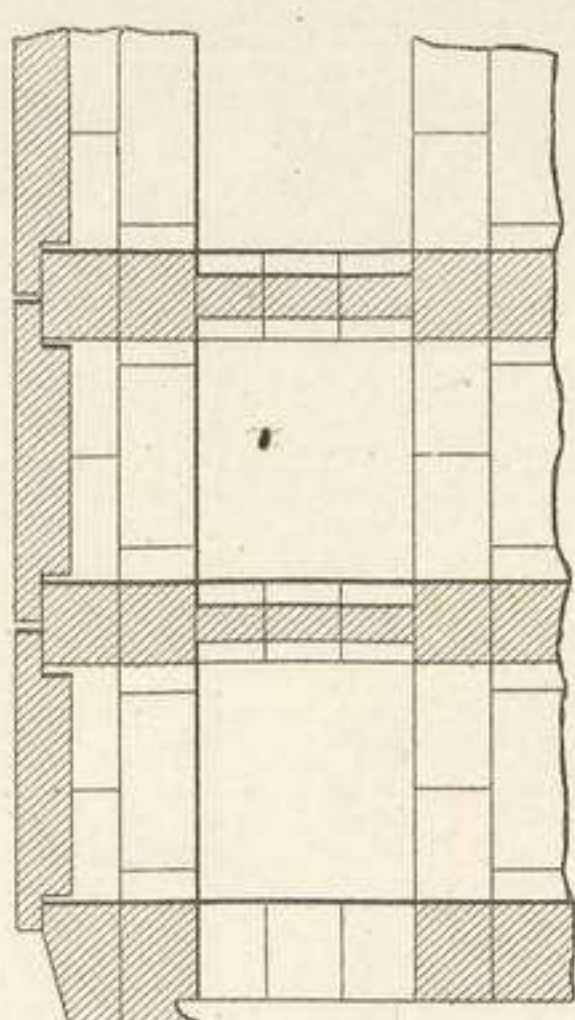

Fig. 22 (79)

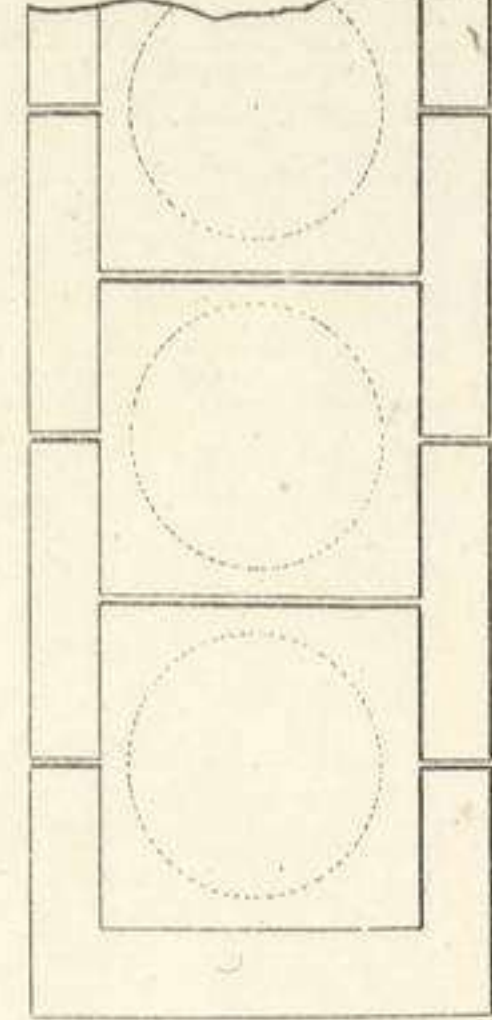

Fig. 23 (79)

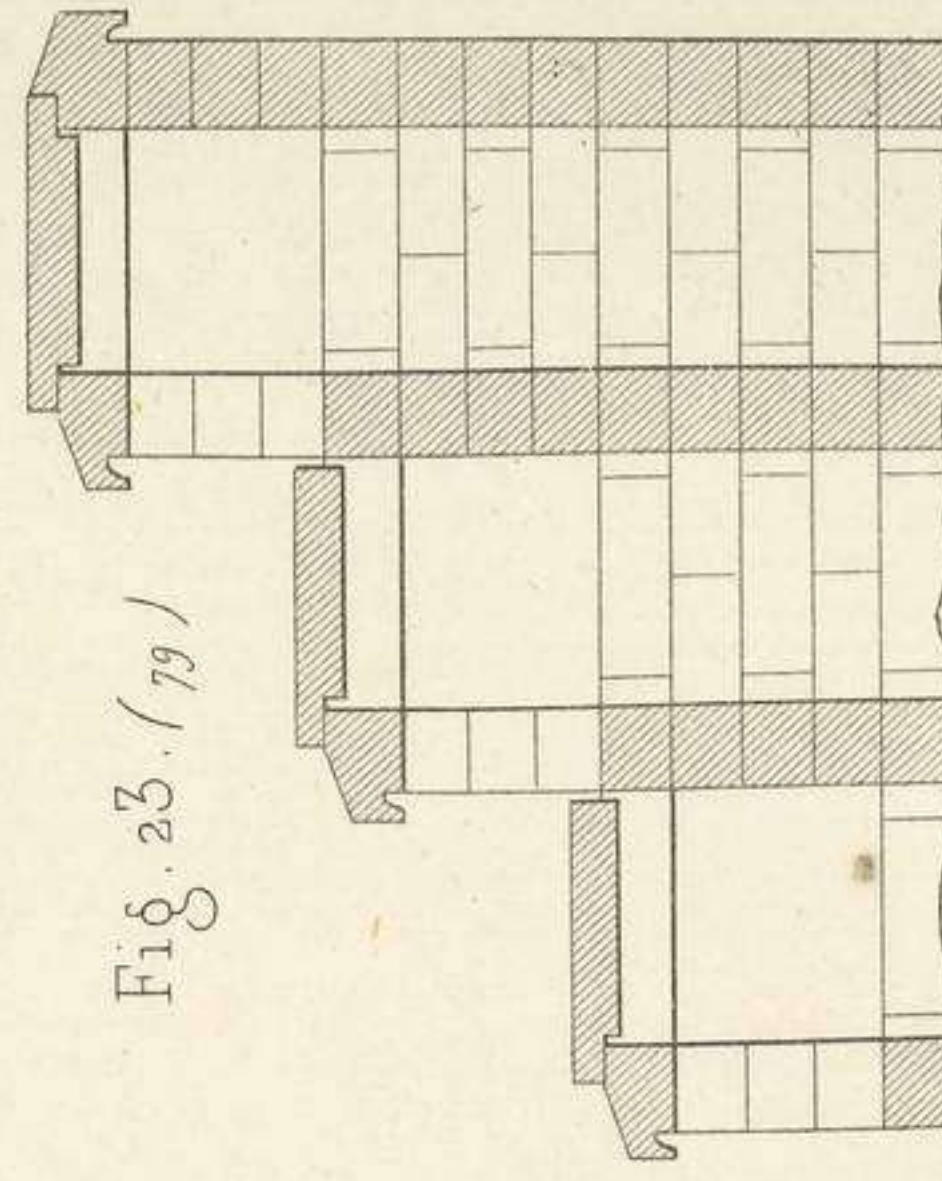
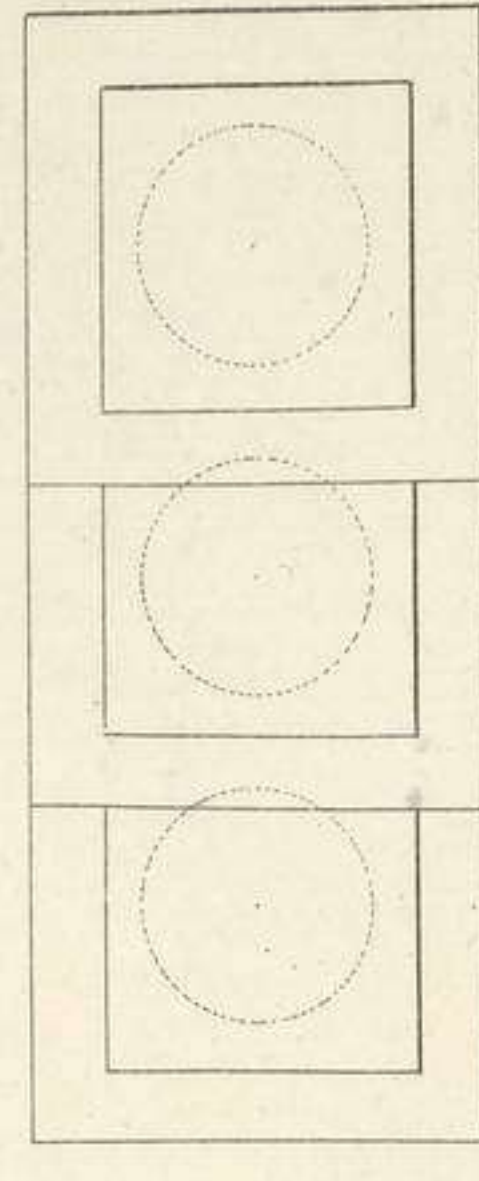
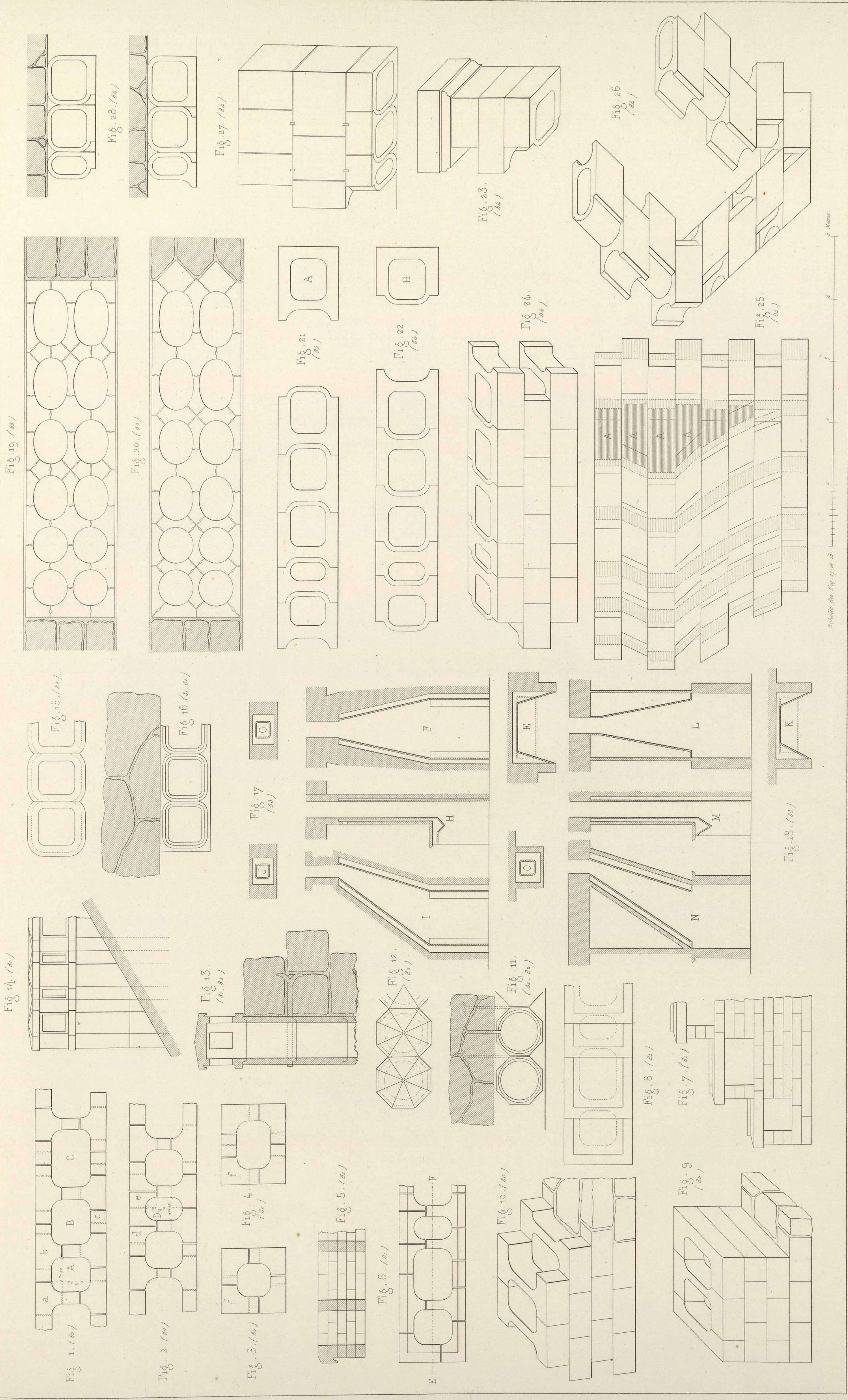

Fig. 24 (79)









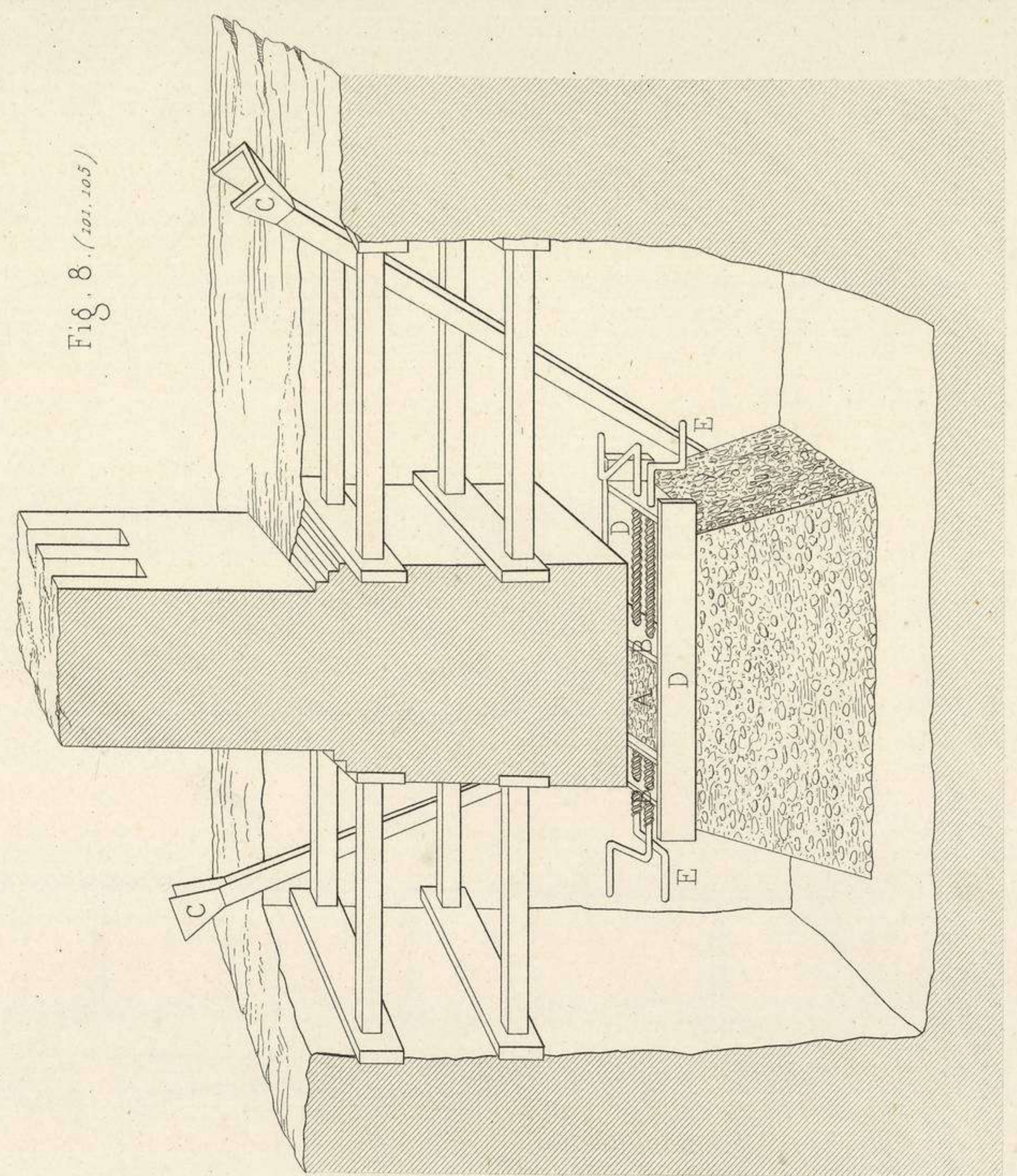
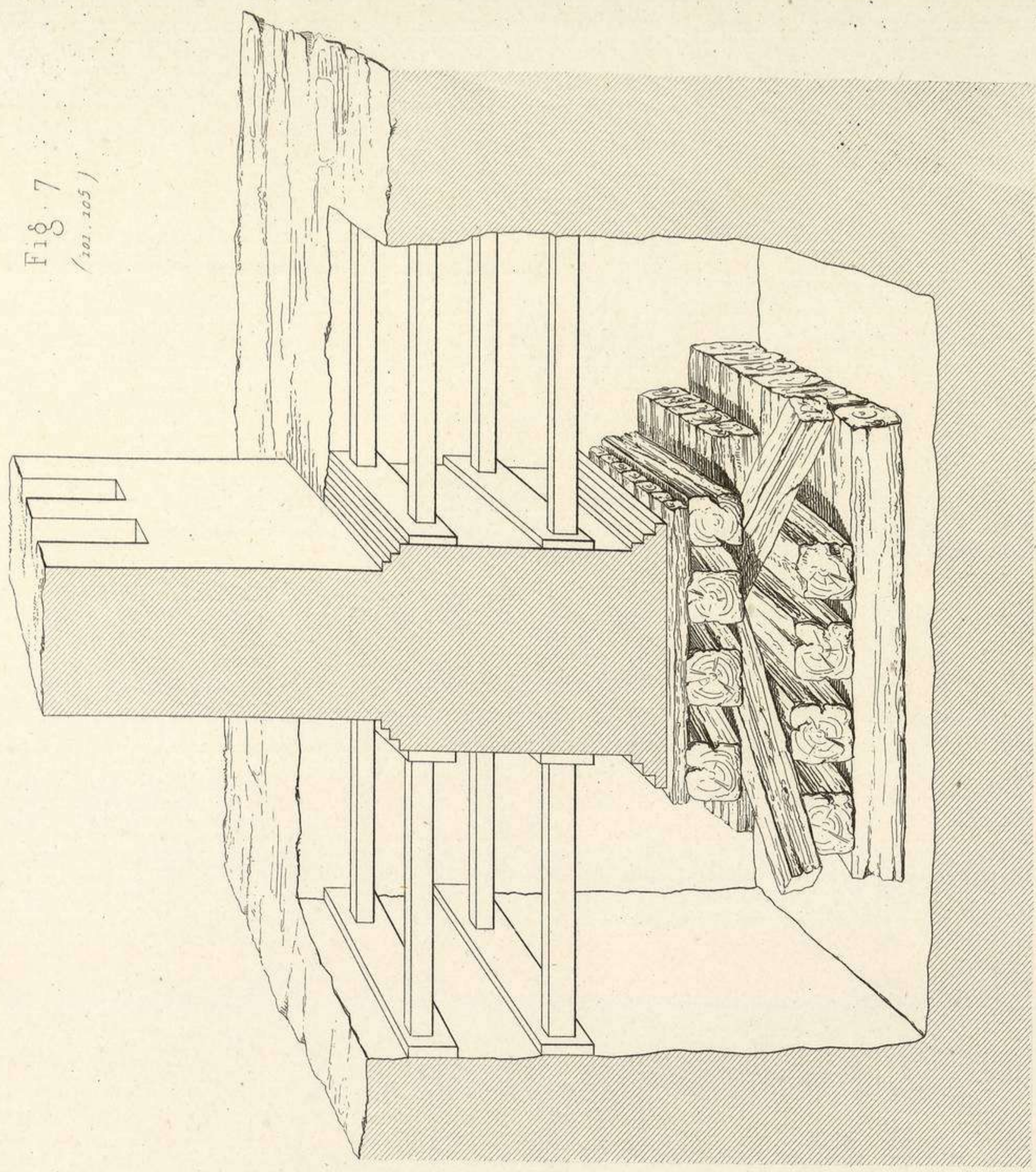
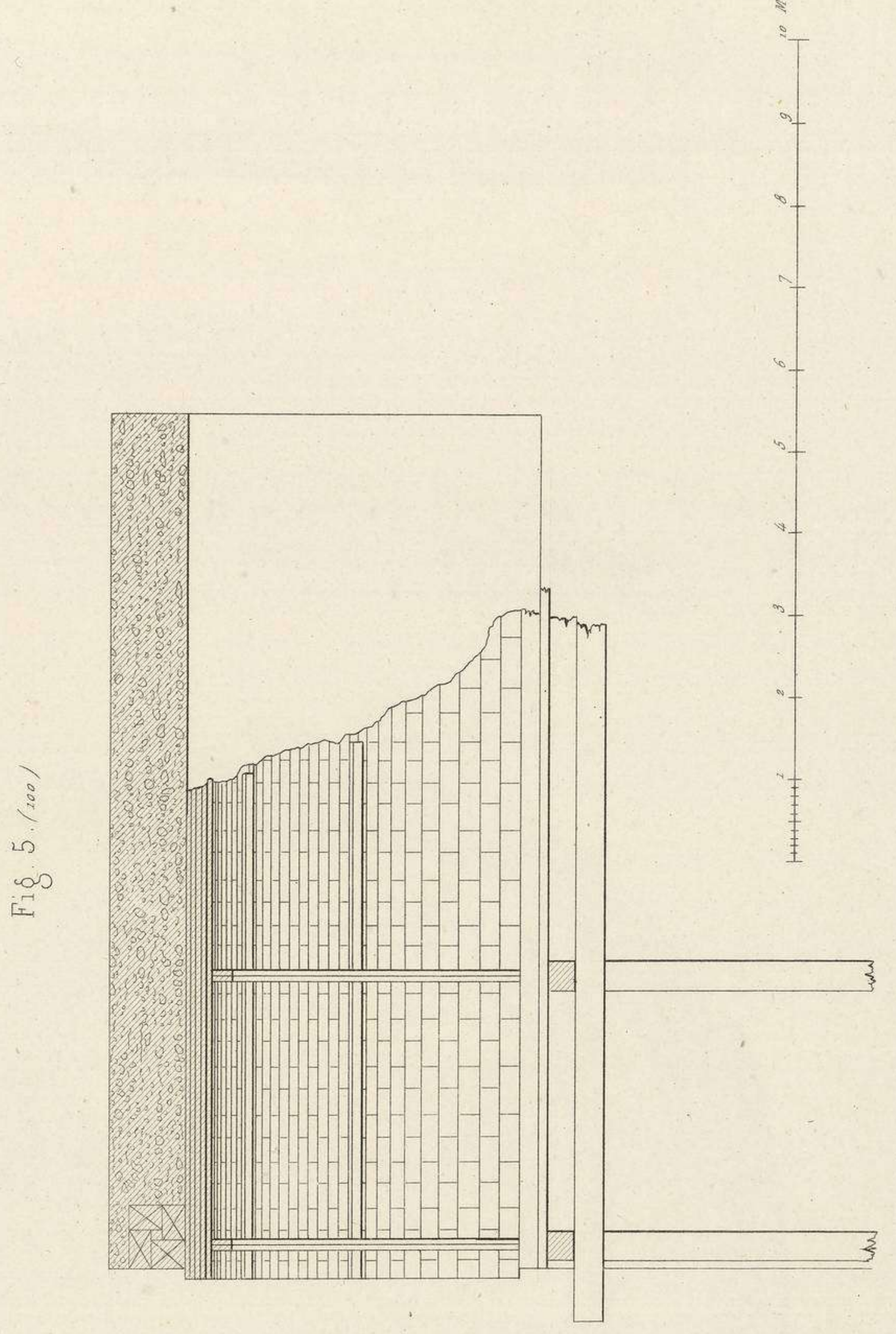
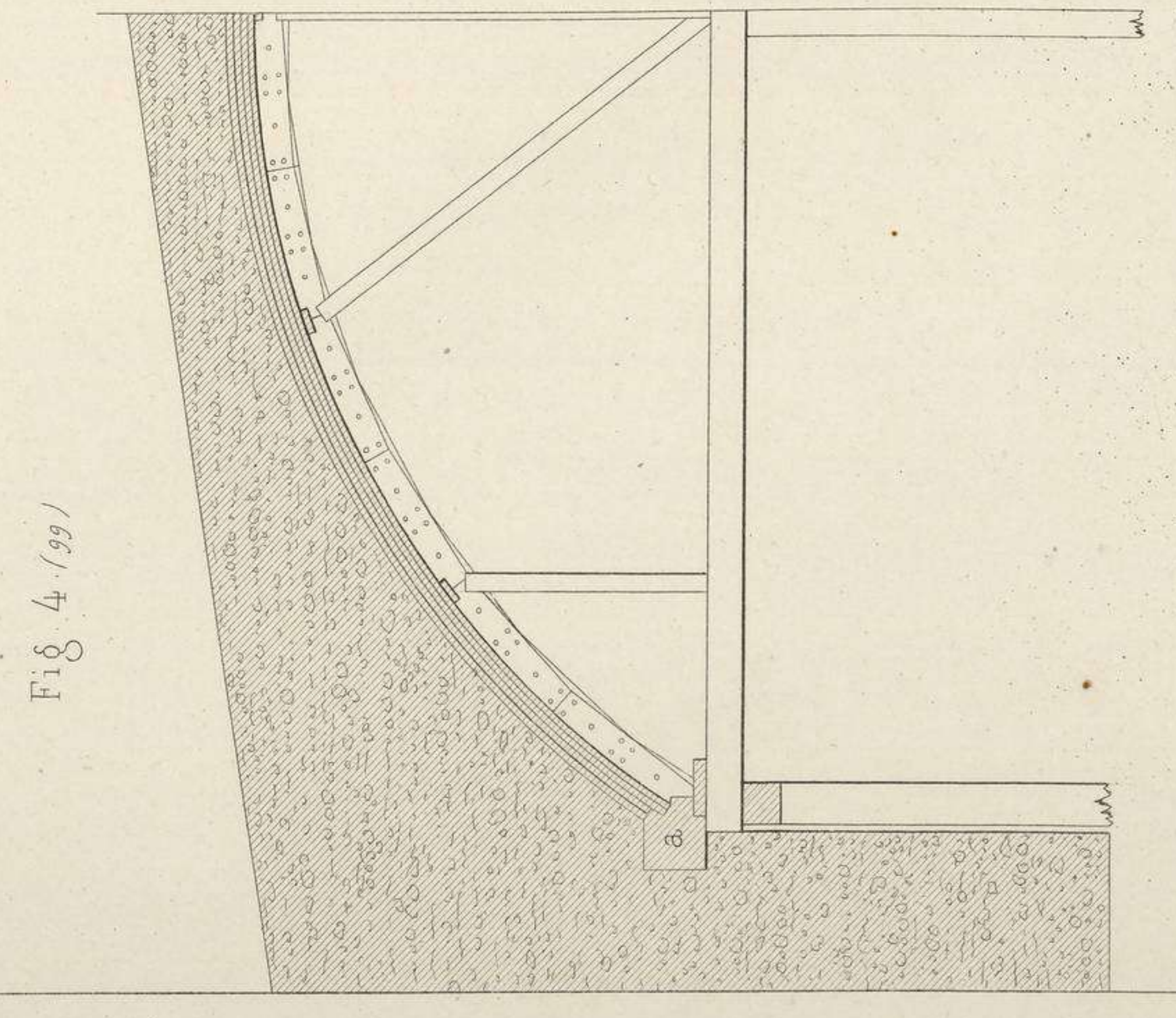
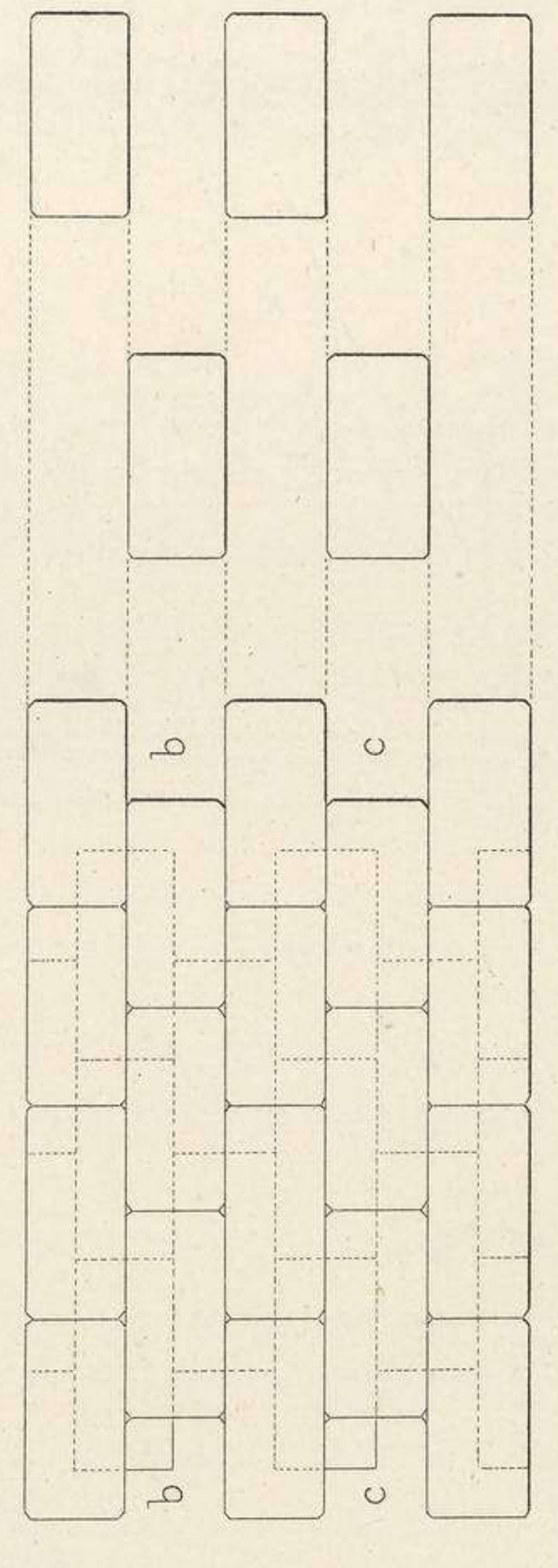
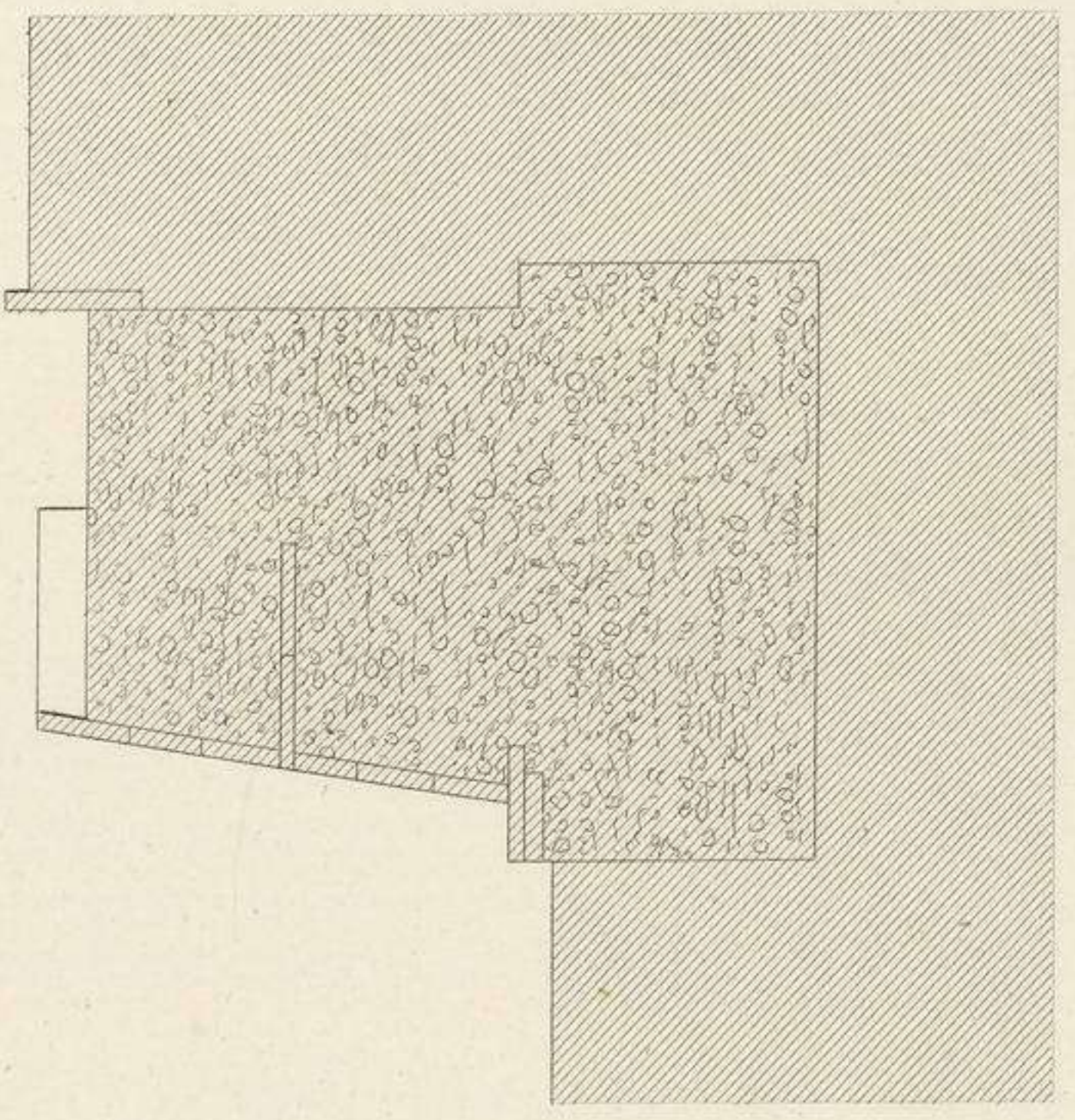
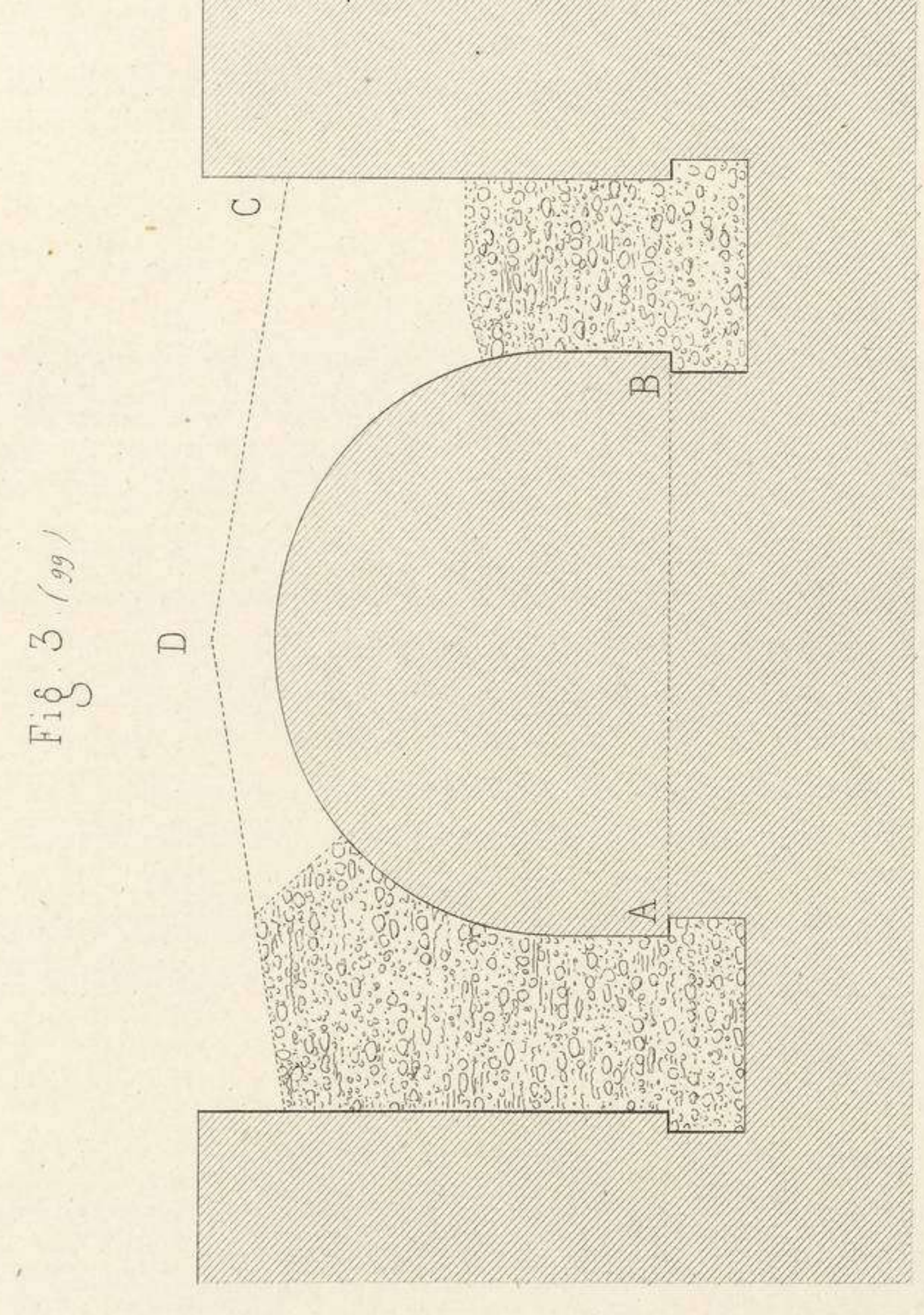
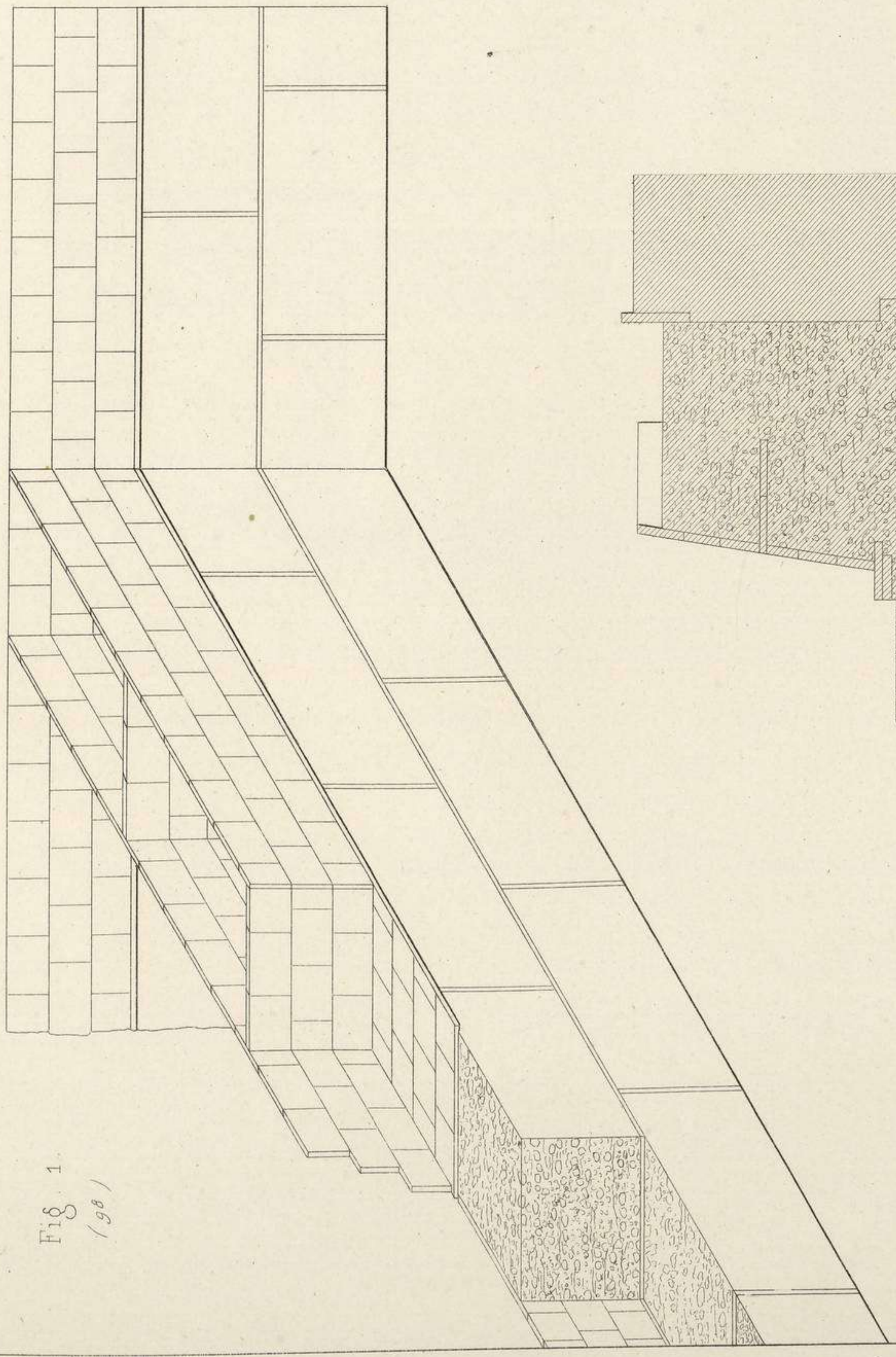



Fig. 1.

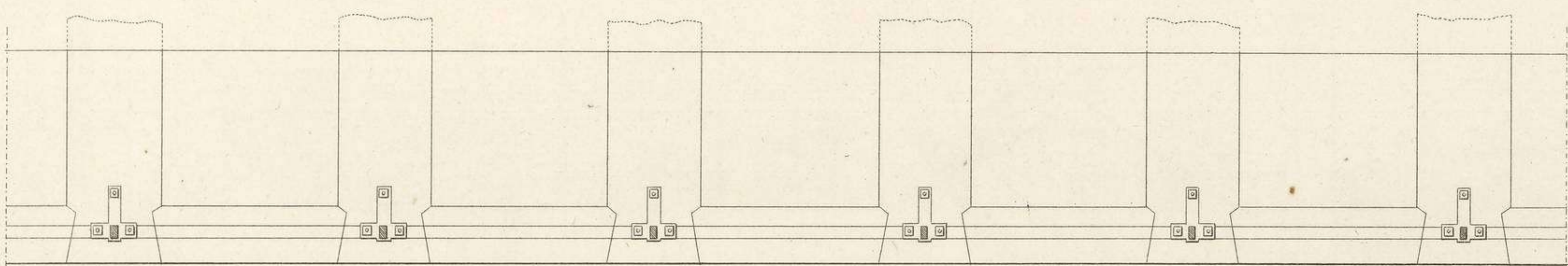
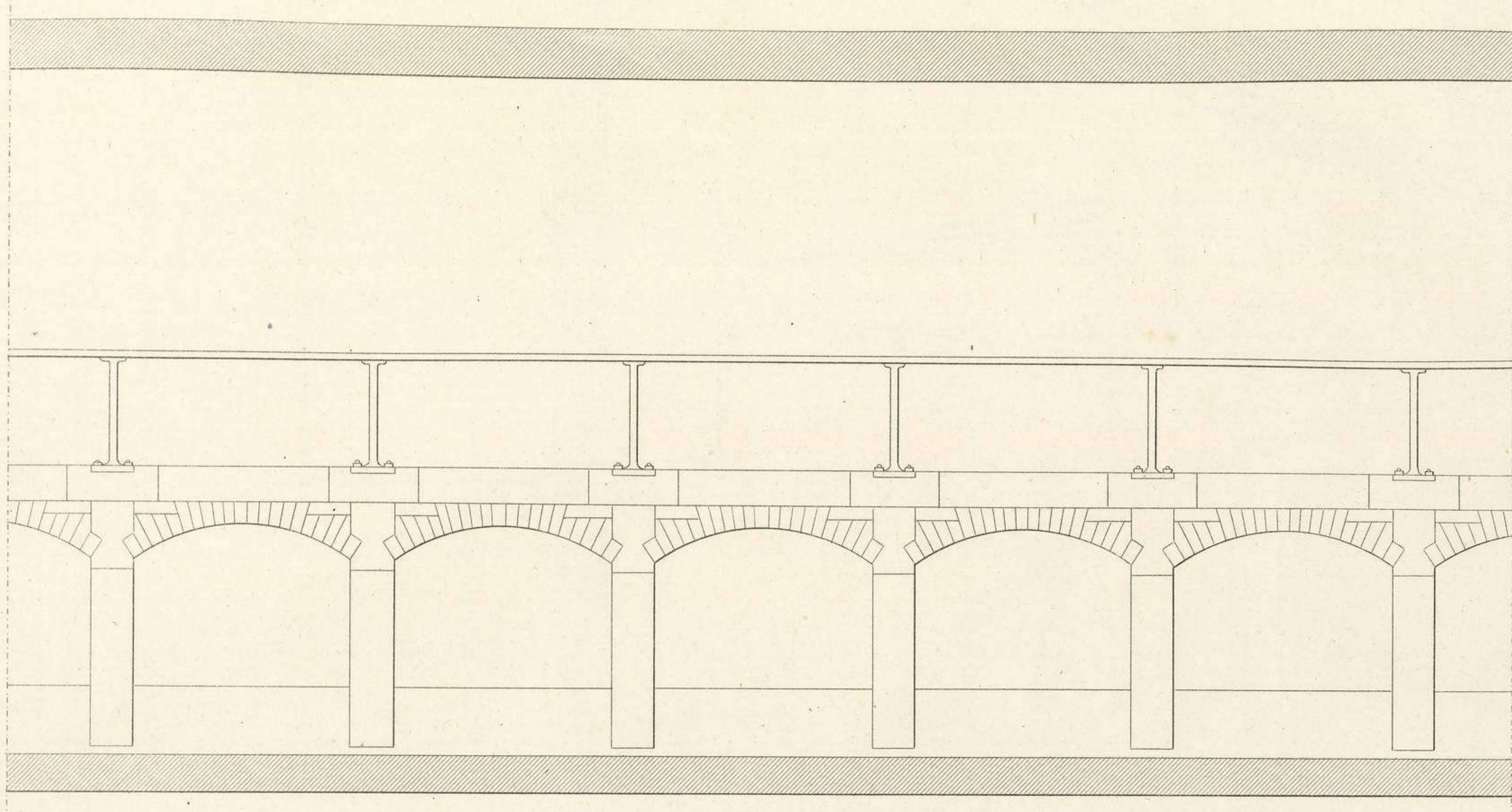

Fig. 2.

Fig. 3.

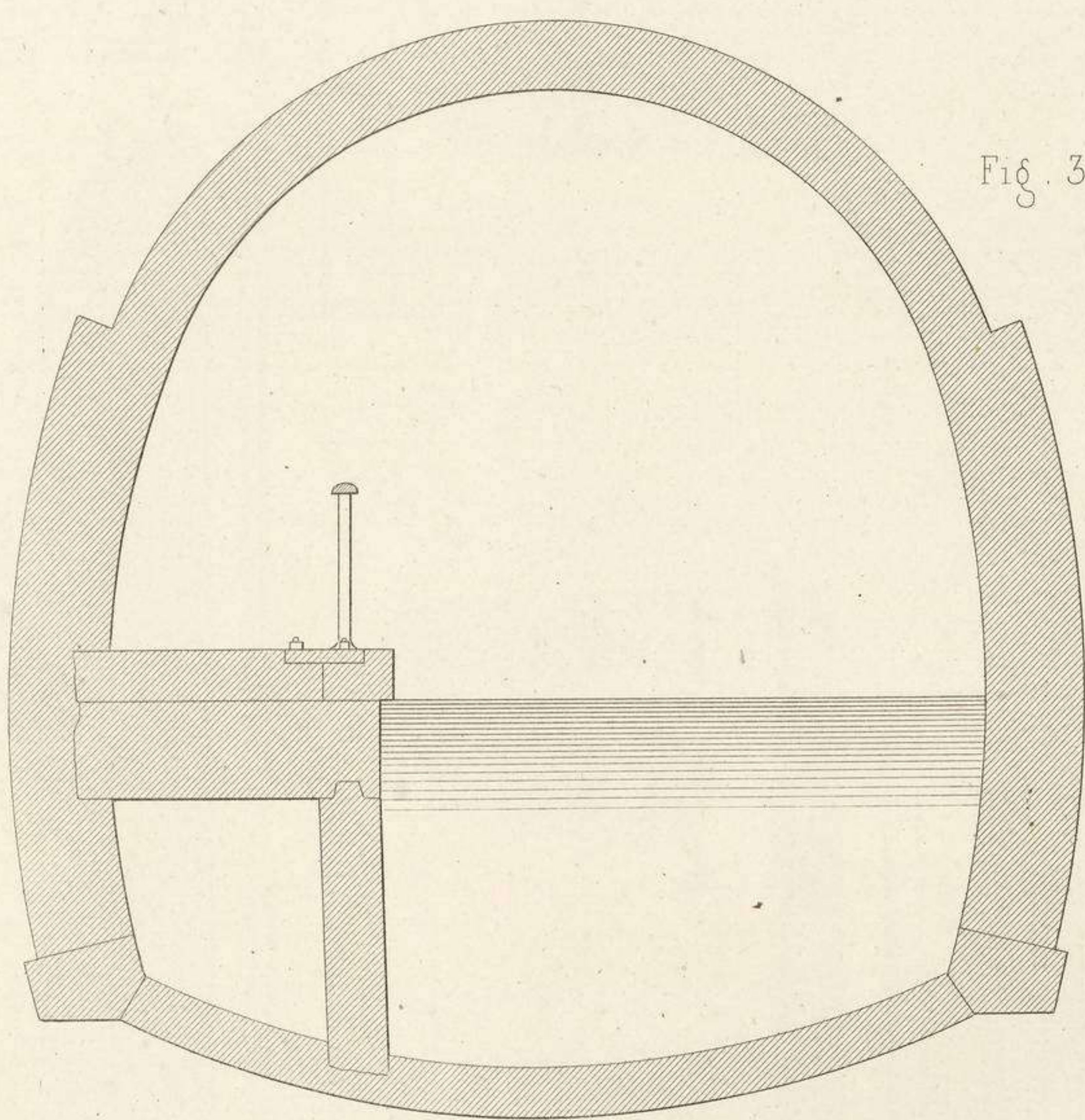
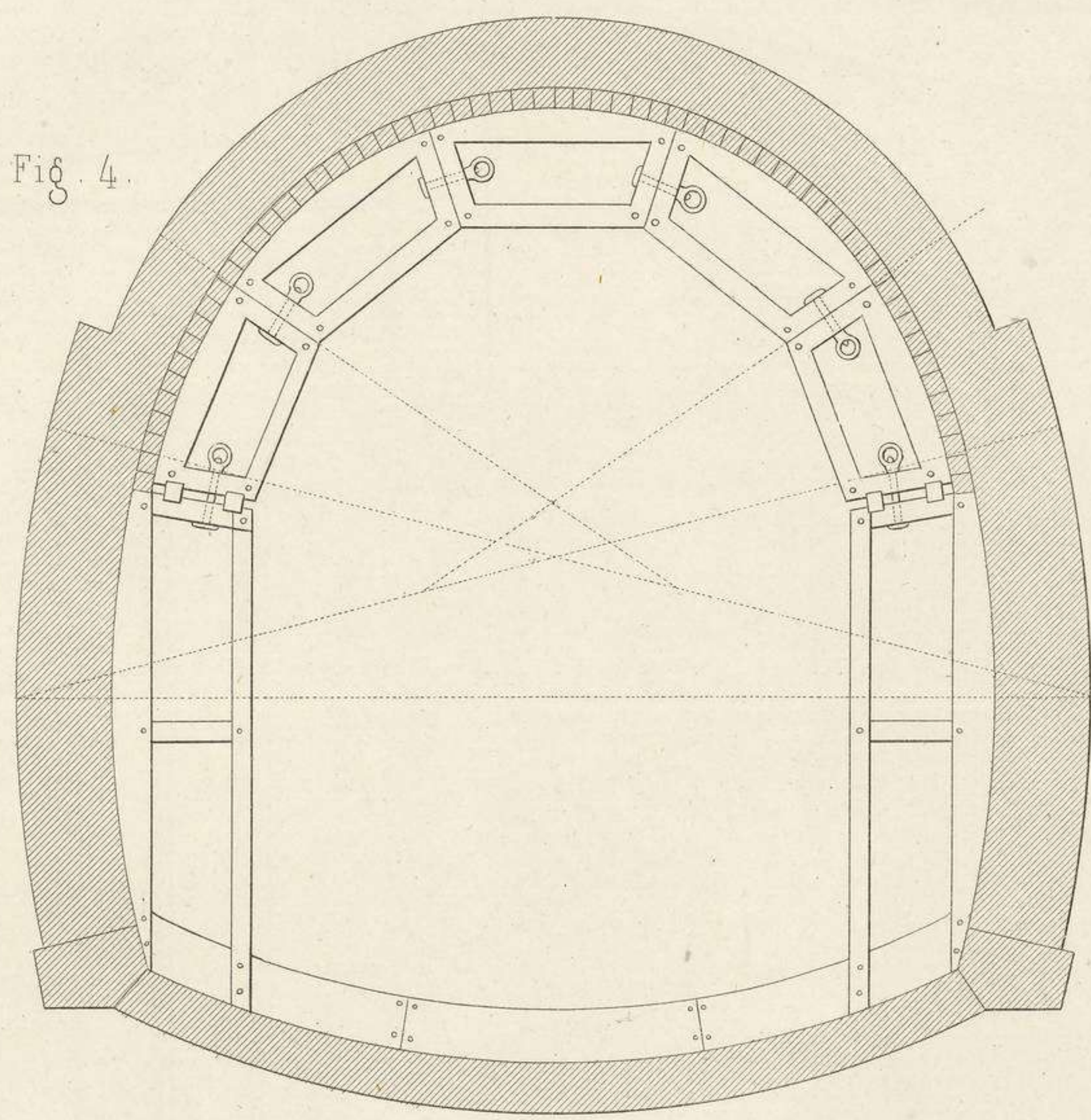

Fig. 4.



B. et V. del.

H. R.

MAÇONNERIE.  
Tunnels.



Fig. 1.  
(107)

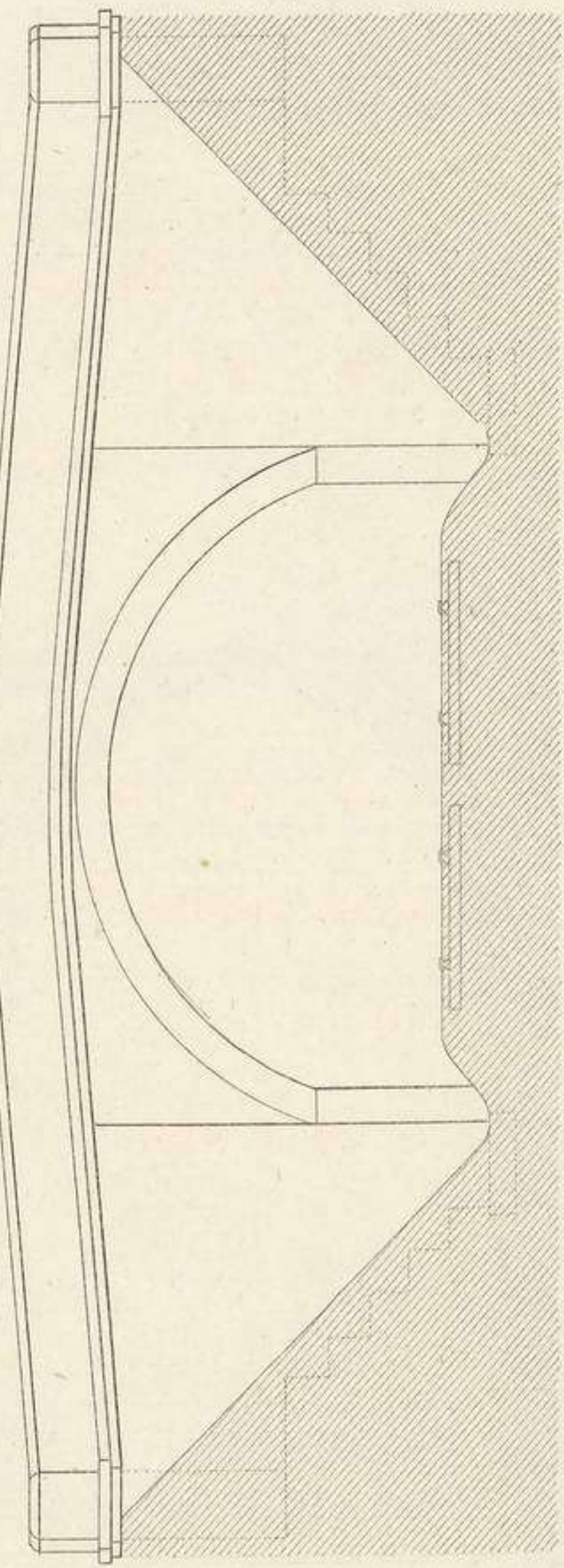

Fig. 2.  
(107)

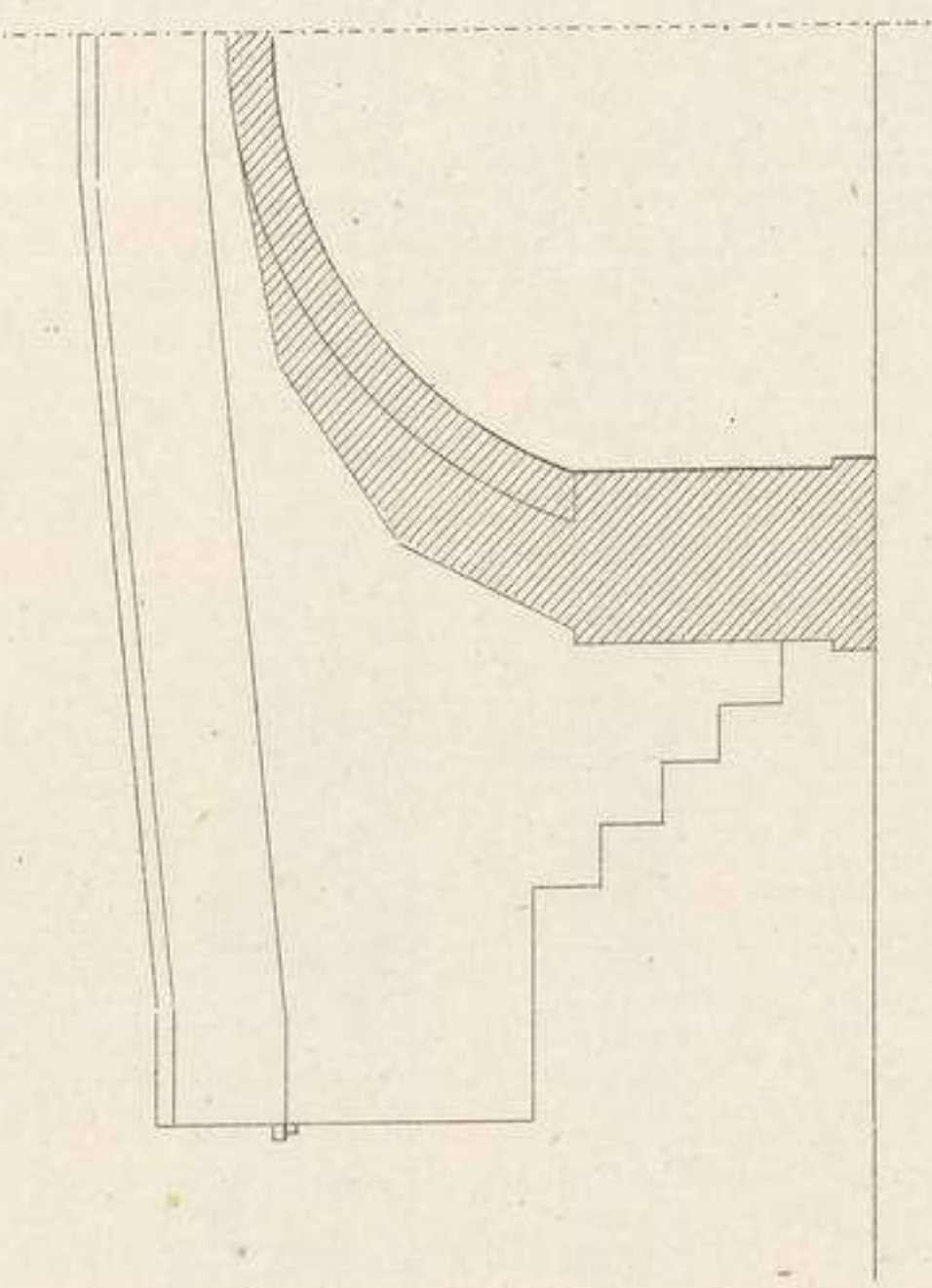

Fig. 3.  
(107)

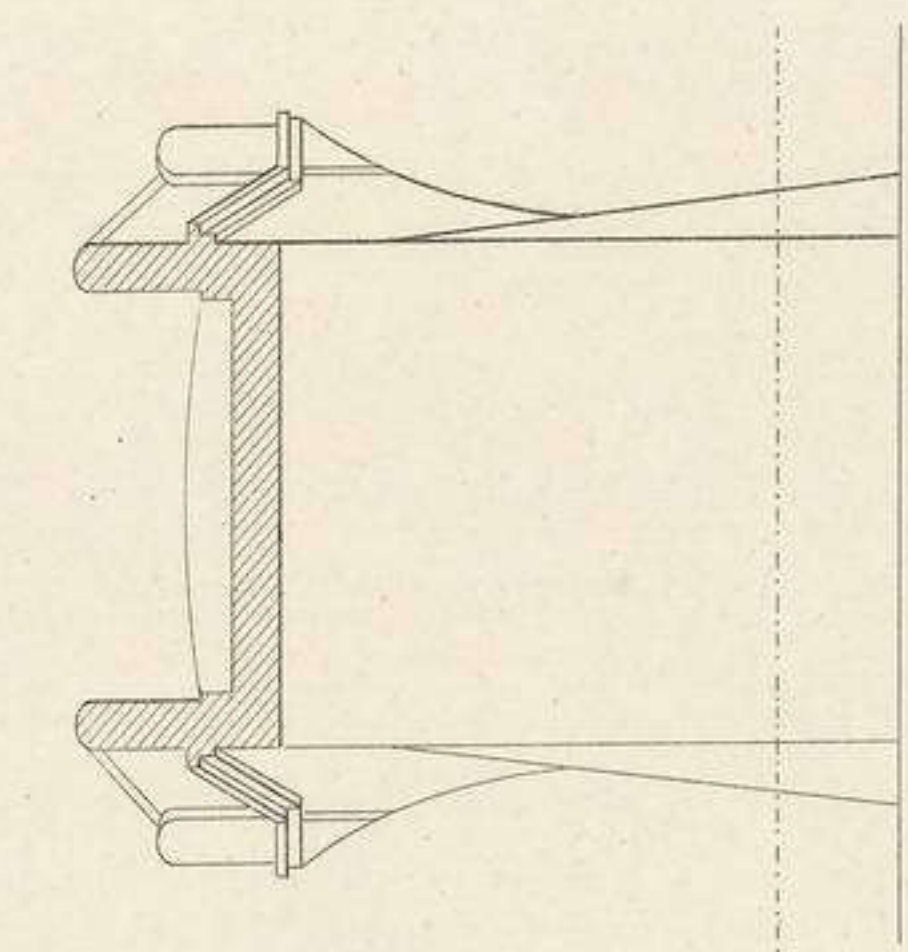

Fig. 6.  
(108)

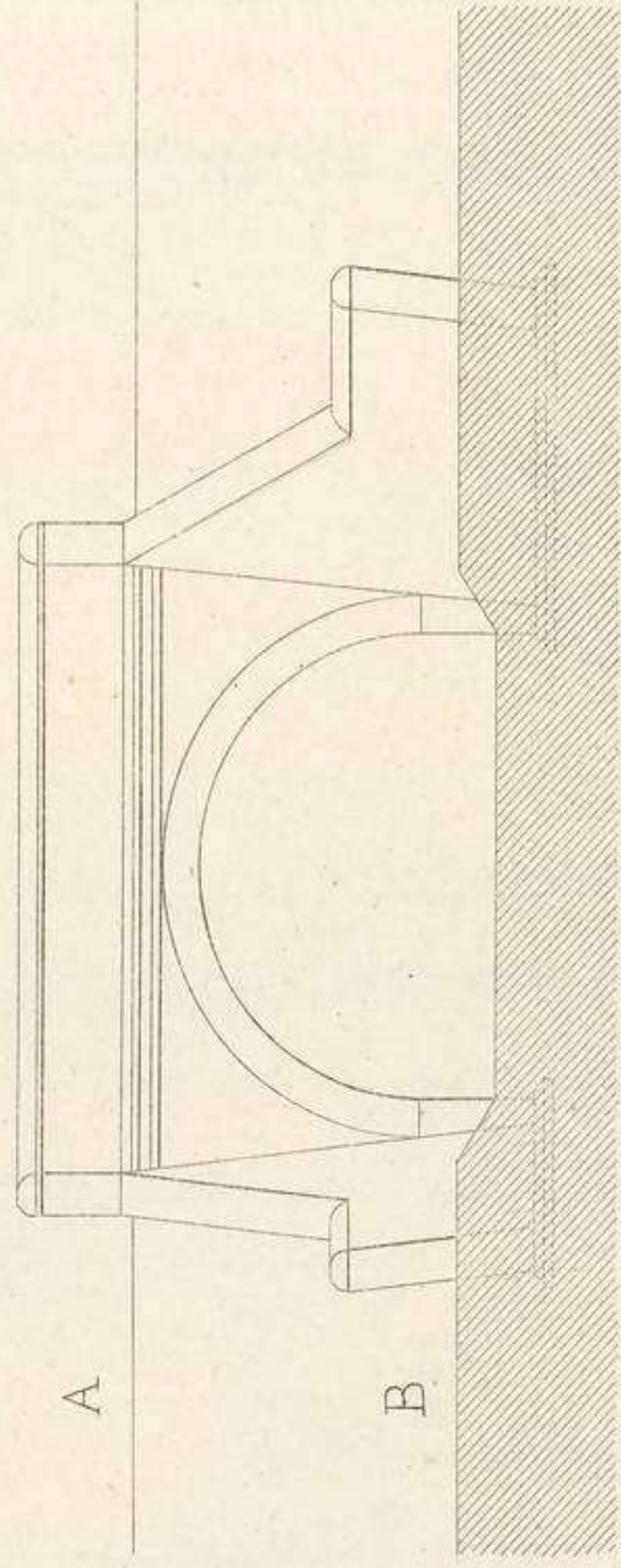

Fig. 7.  
(108)

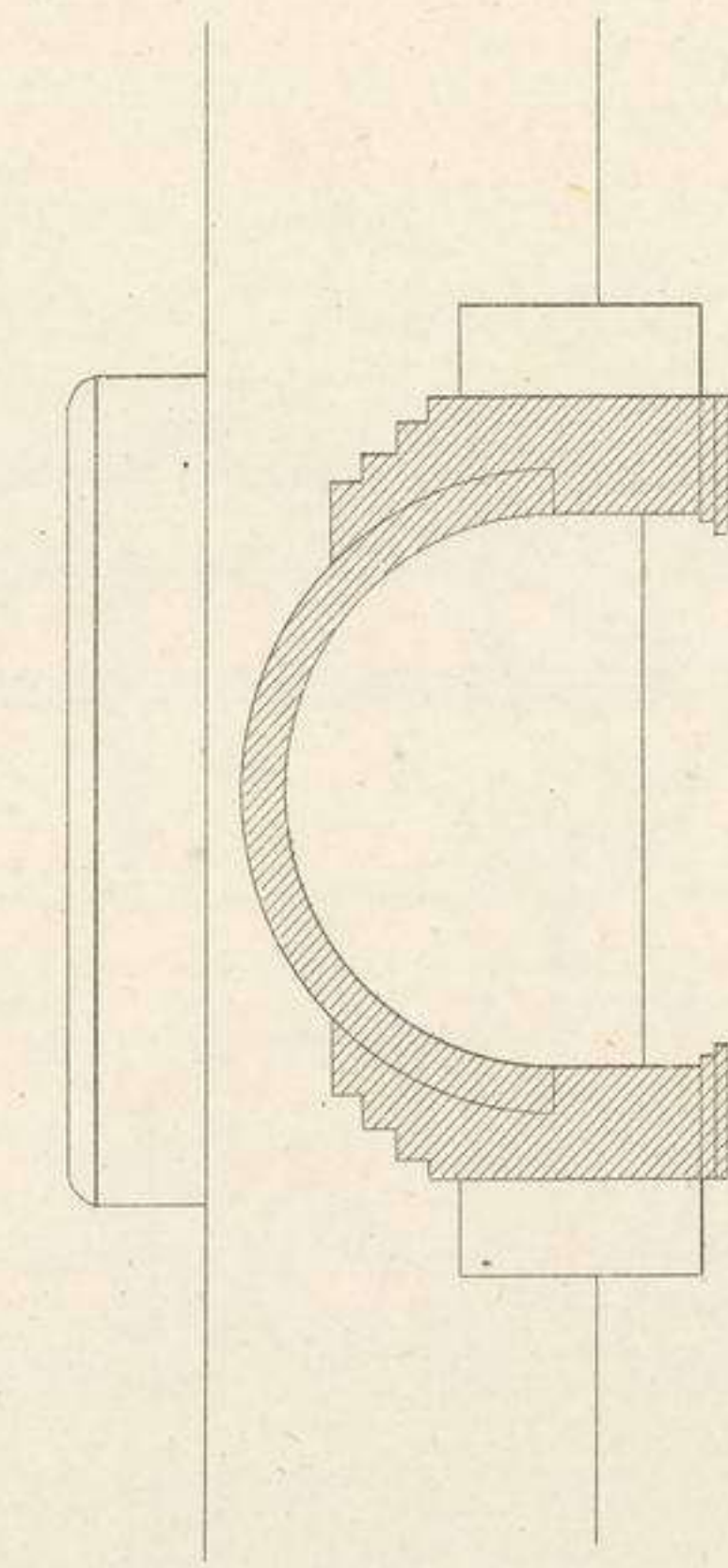

Fig. 8.  
(108)

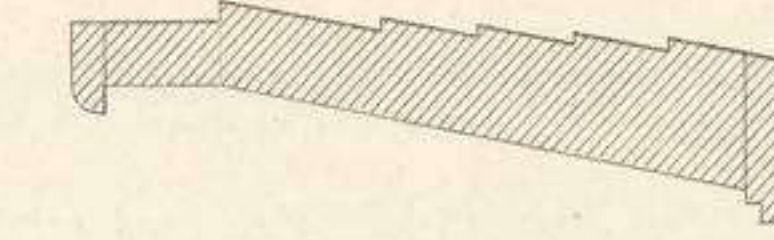

Fig. 4.  
(108)

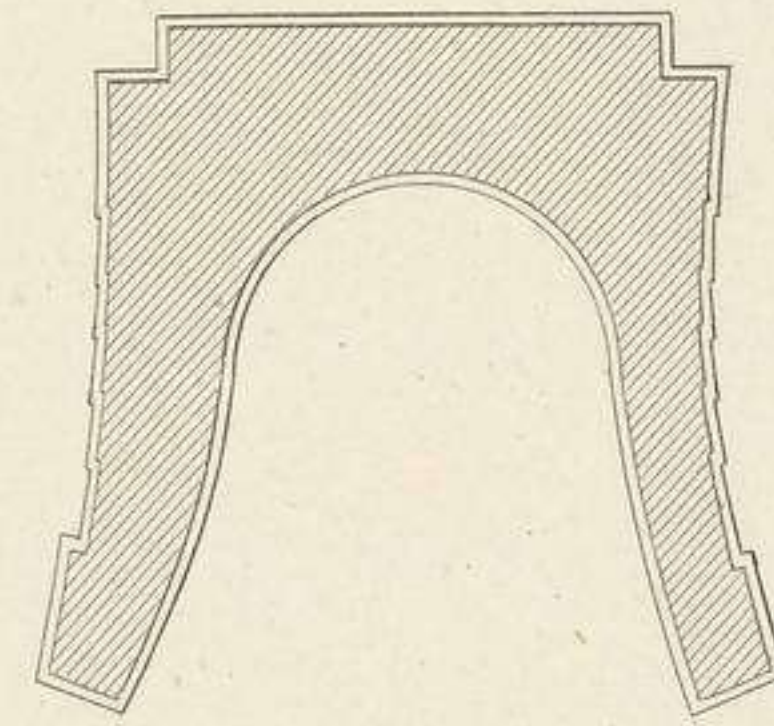

Fig. 5.  
(108)

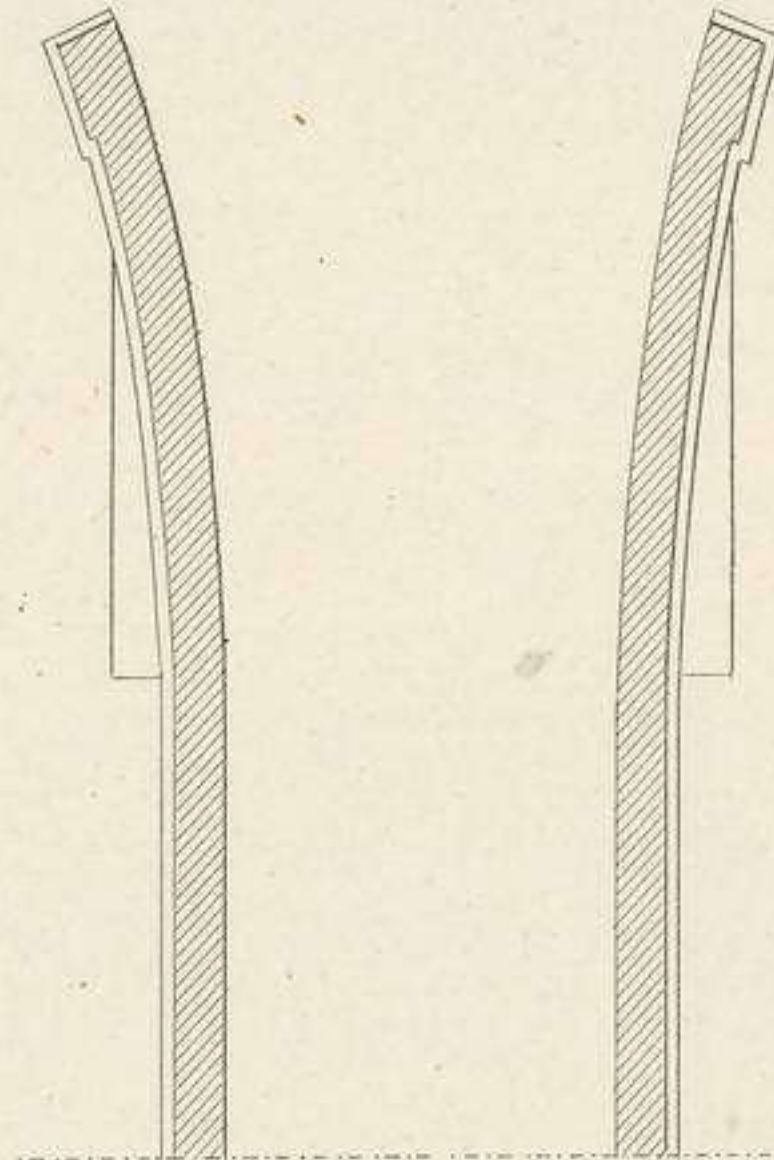

Fig. 9.  
(108)

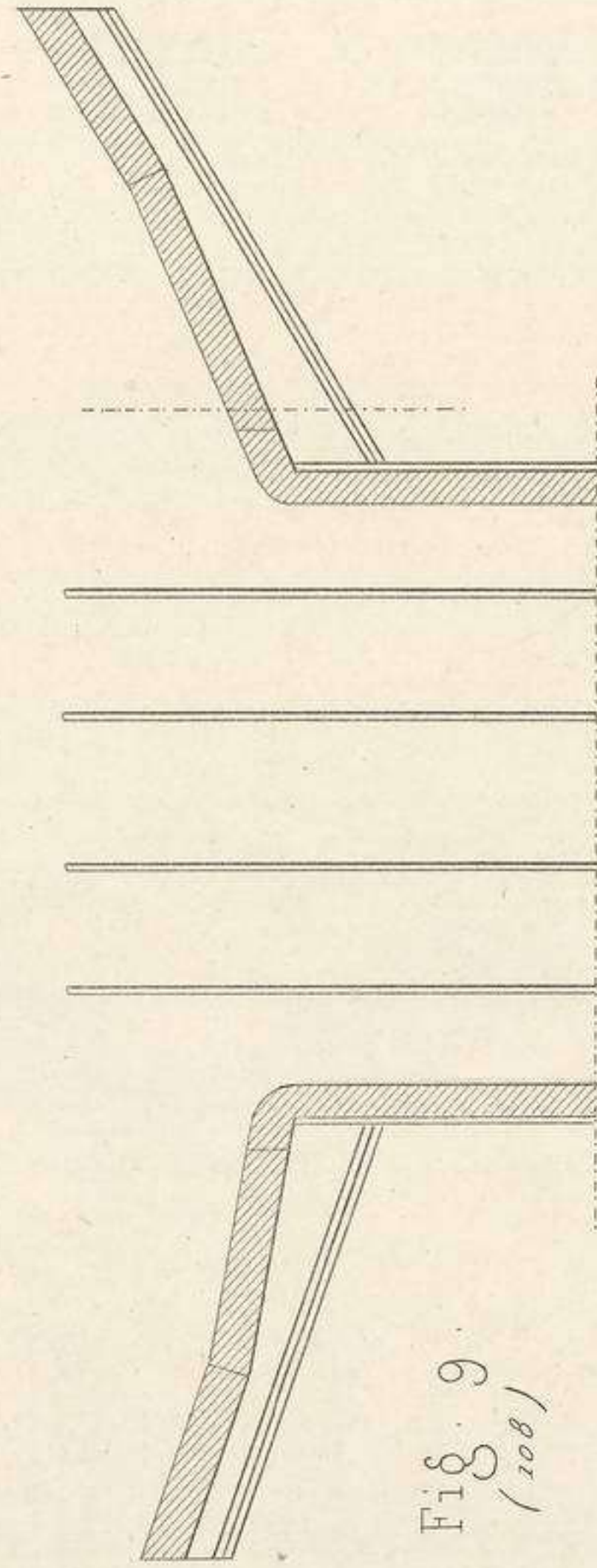
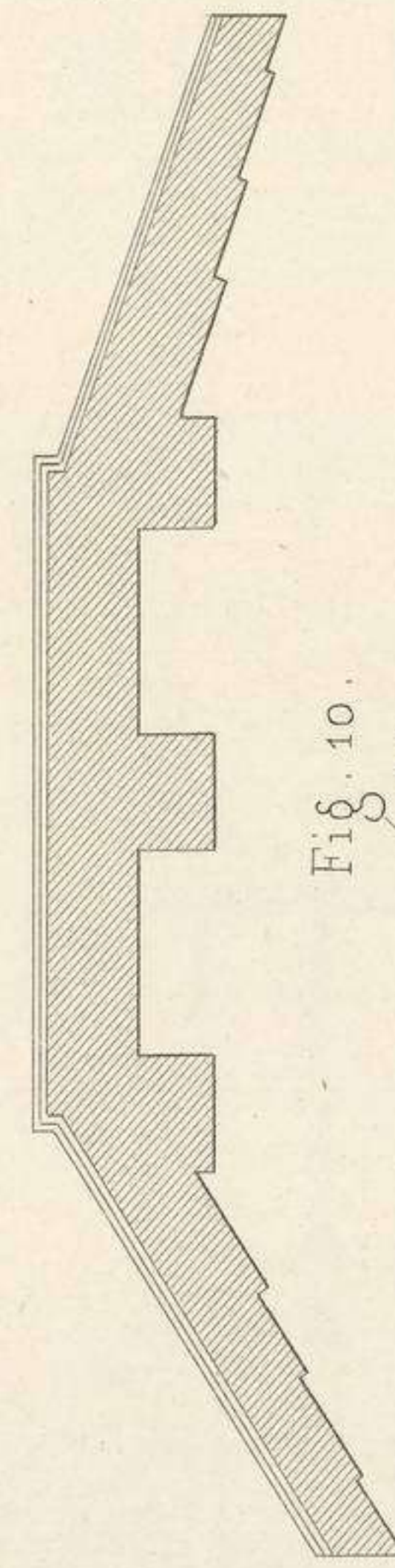

Fig. 10.  
(108)



0 1 2 3 4 5 6 7 8 9 10 11 12 13 14 15 16 17 18 19 20 Mètres.

B. del. V. del.

H. R.

MAÇONNERIE.  
Ponts.



Fig 1

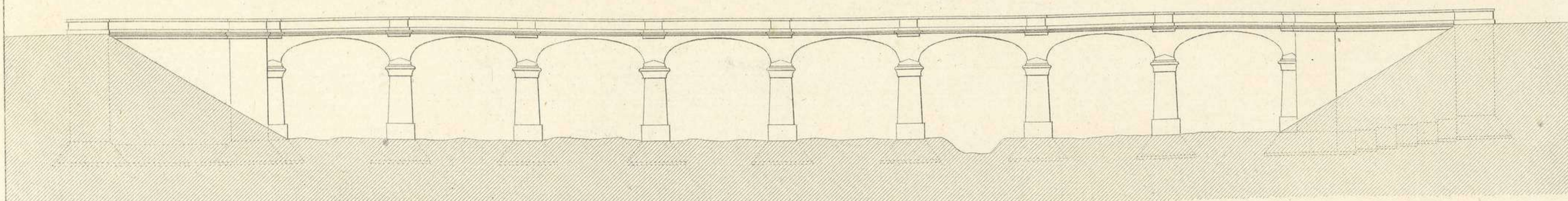

Fig 2

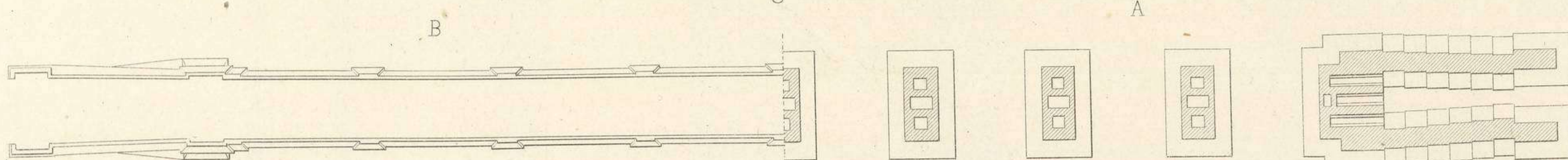

Fig 3

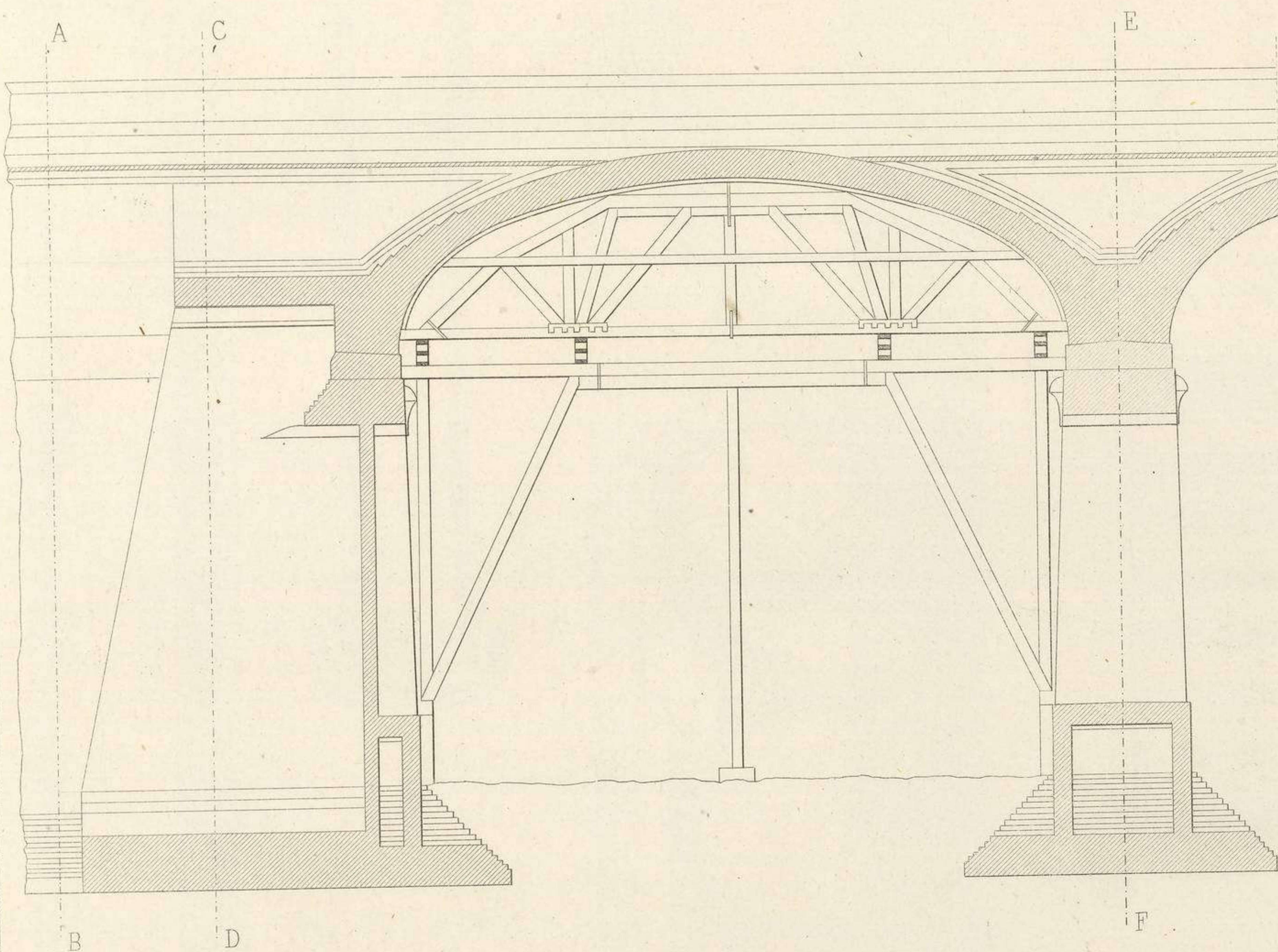

Fig 4

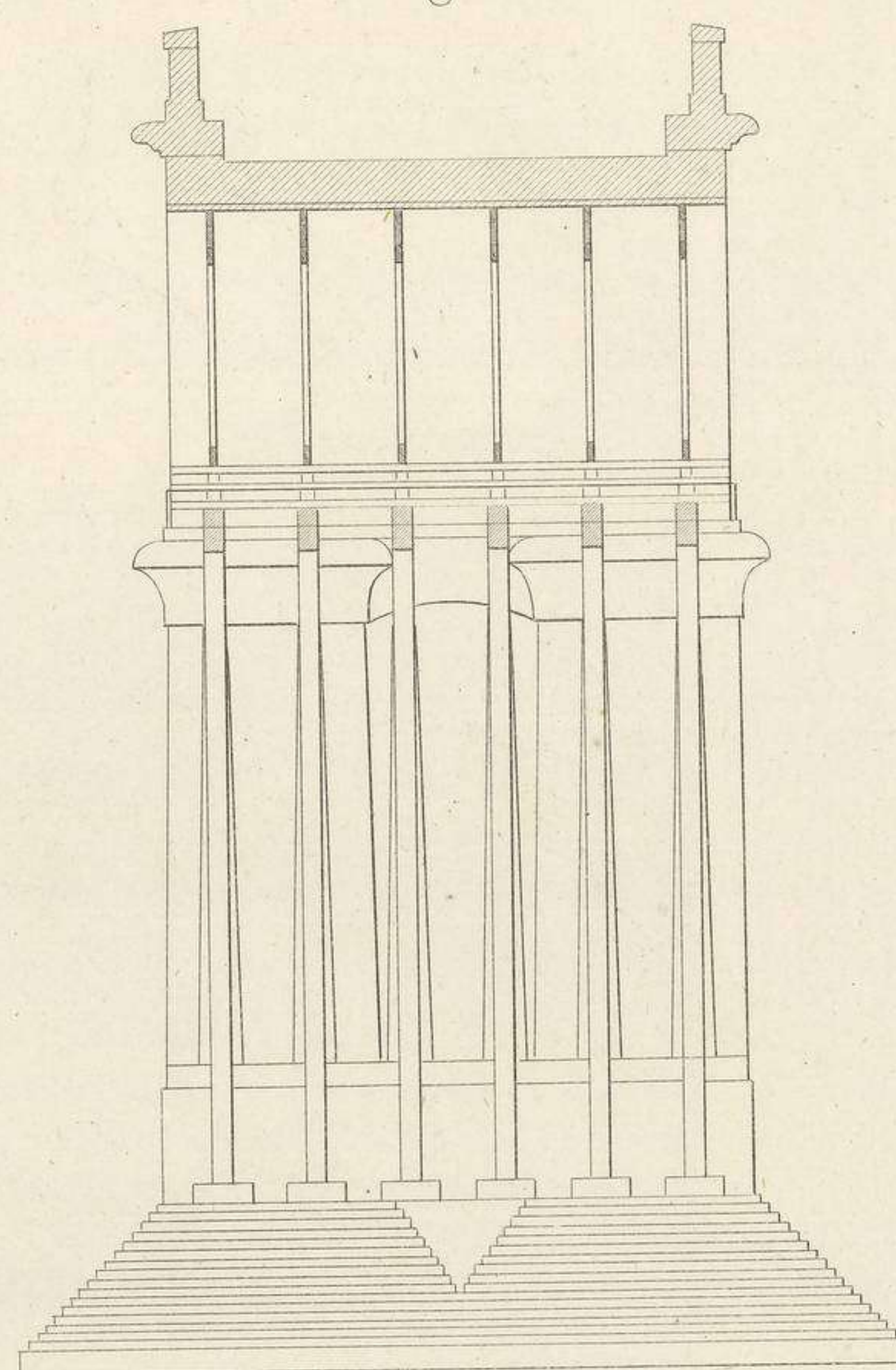

Fig 5

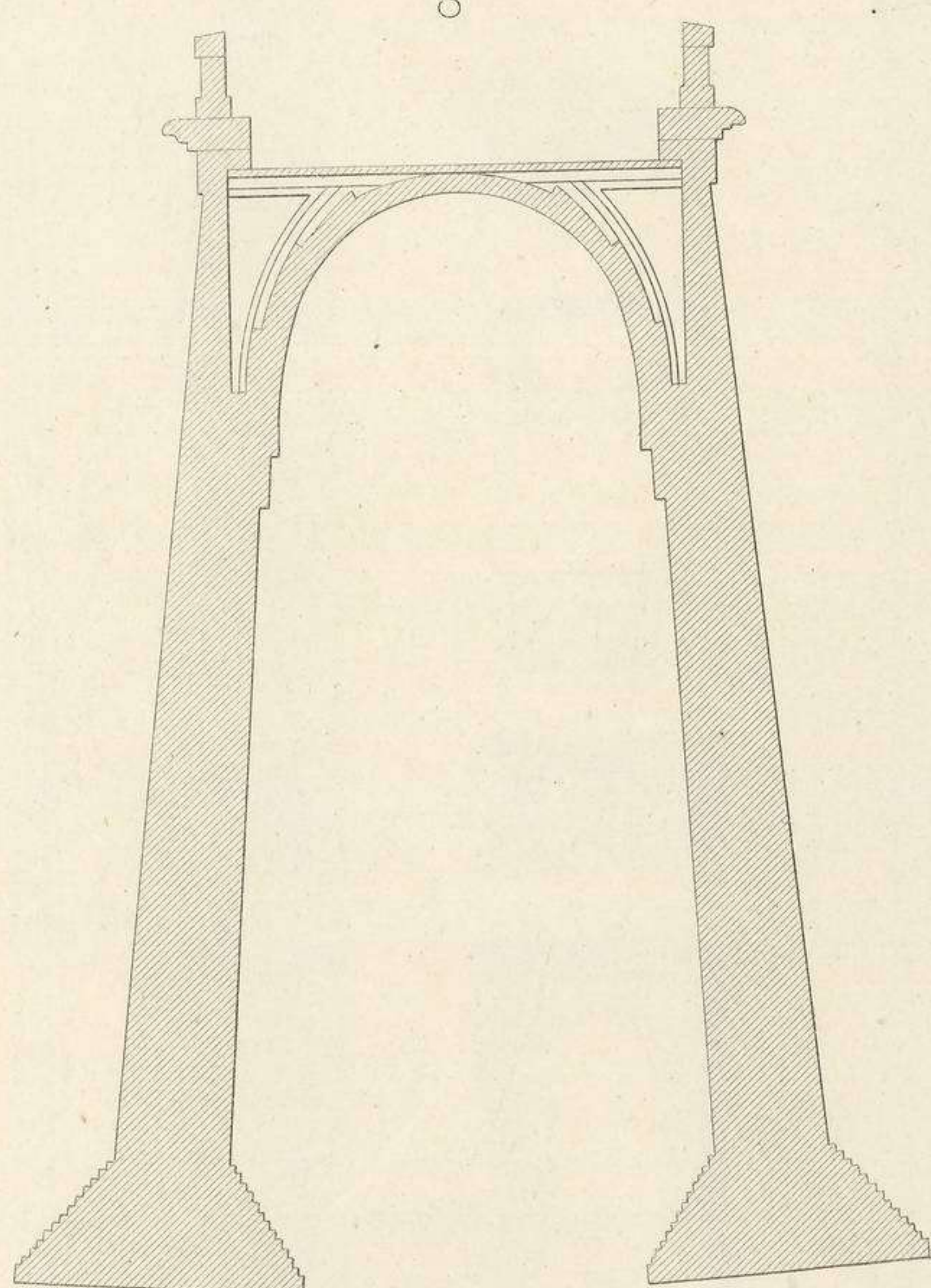

Fig 6

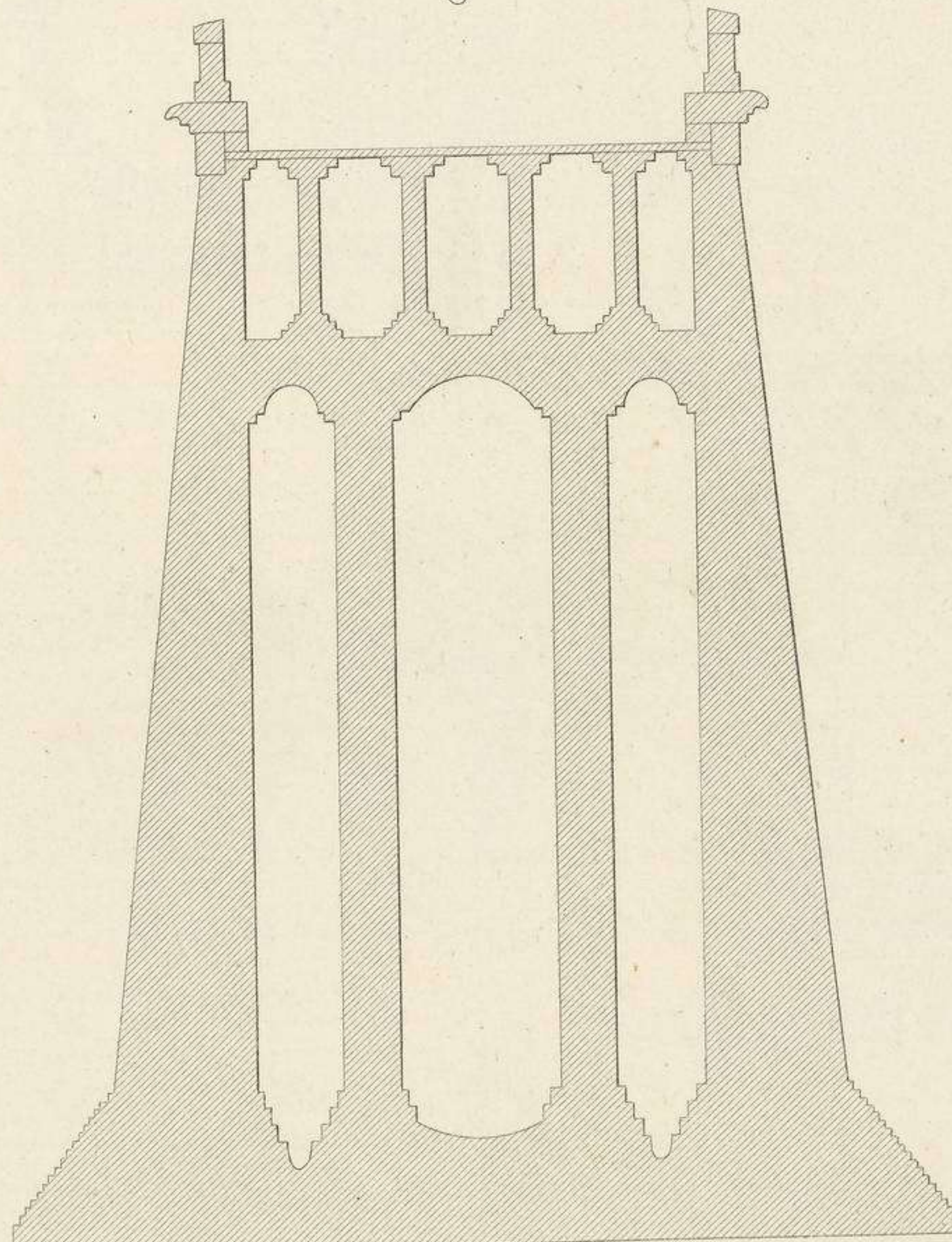
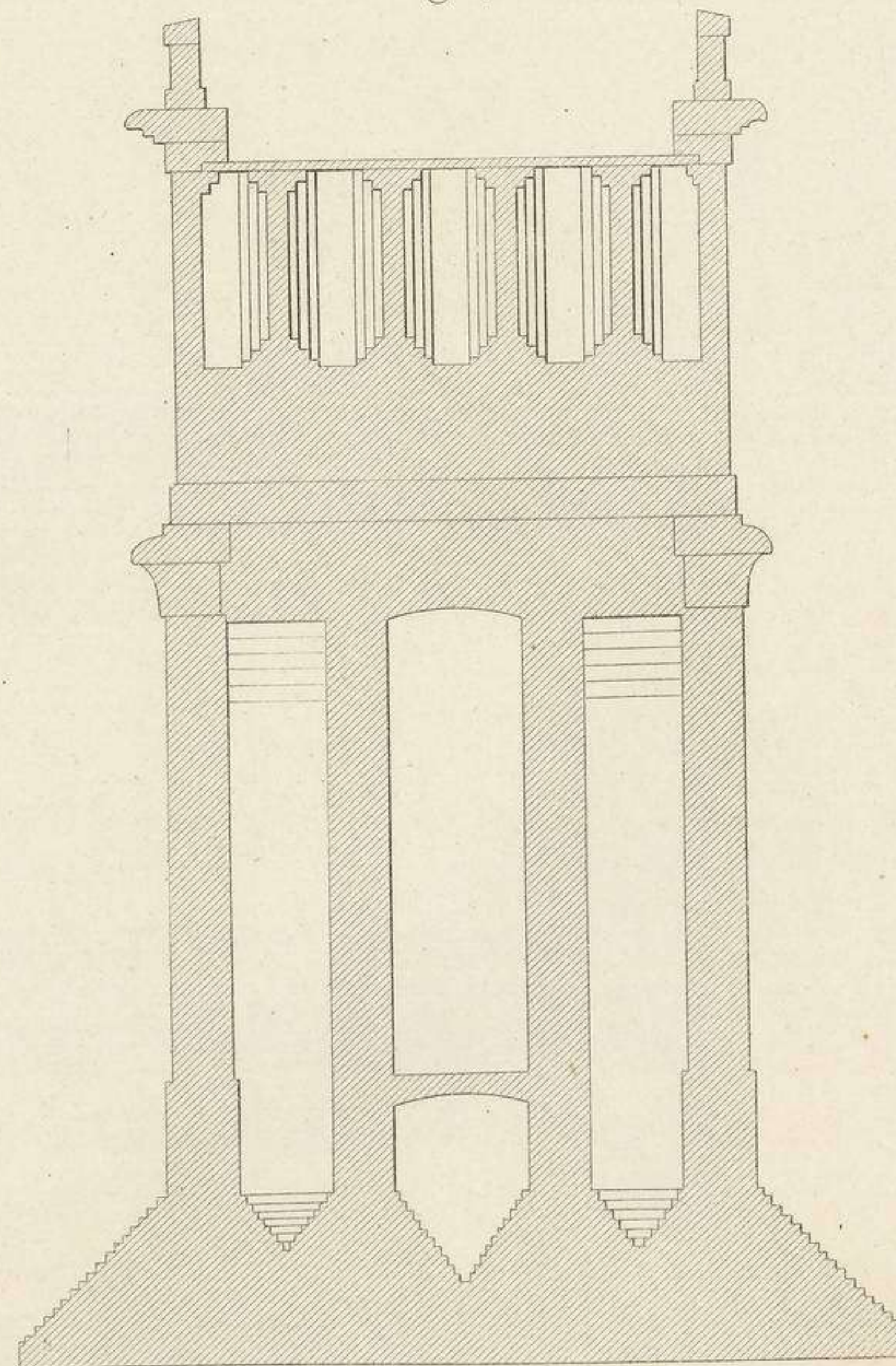

Fig 7



Echelle des Fig. 1 et 2. 0 10 20 30 40 50 60 70 80 90 100 Mètres

Echelle des Fig. 3, 4, 5, 6, 7. 0 1 2 3 4 5 10 15 20 Mètres

B. et V. del.

MAÇONNERIE.  
Ponts



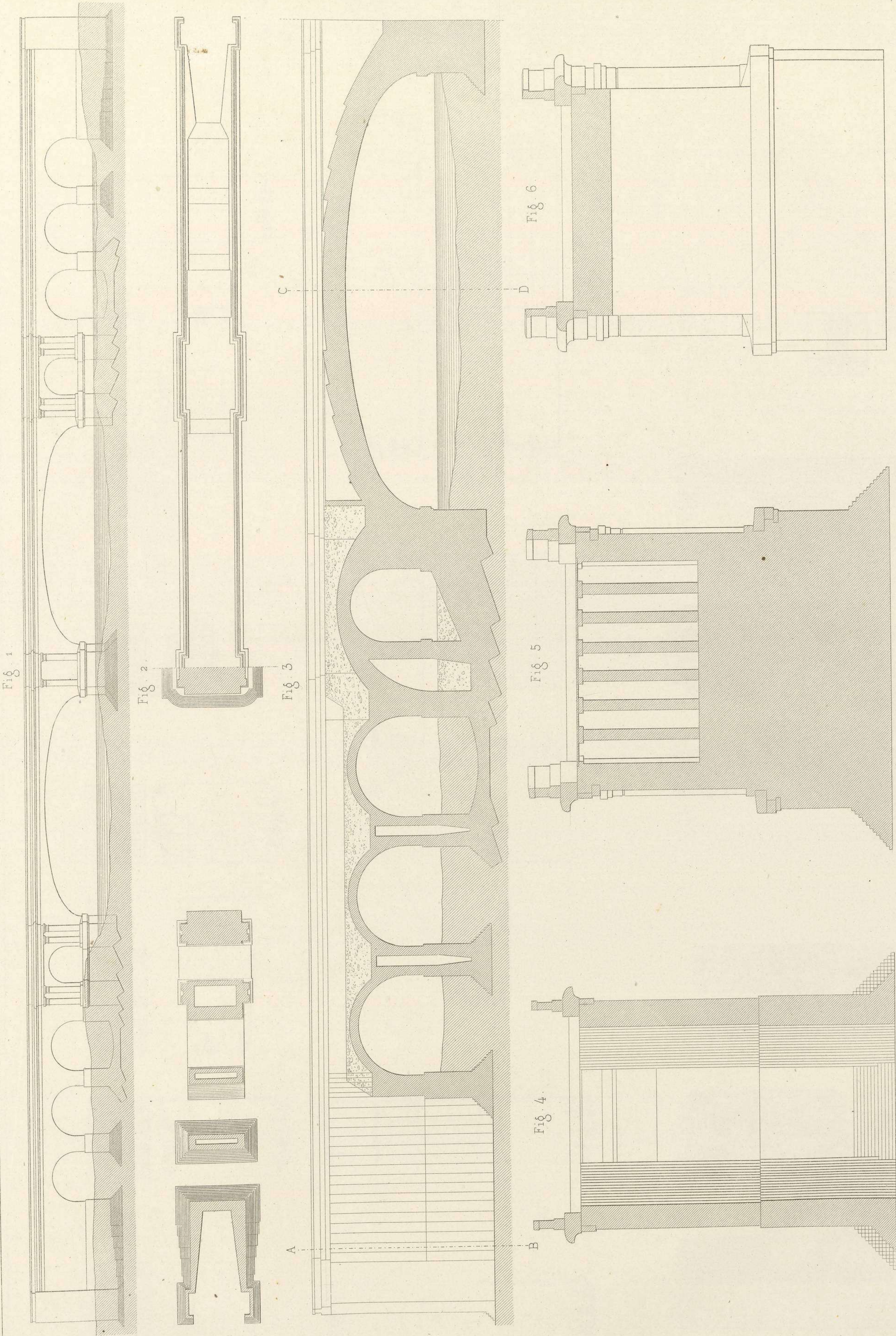

Echelle des Fig. 4, 5, 6  
 Echelle des Fig. 5  
 Echelle des Fig. 5

MAÇONNERIE.  
 Ponts.

H. R.

B. et V. del.



Fig. 1.

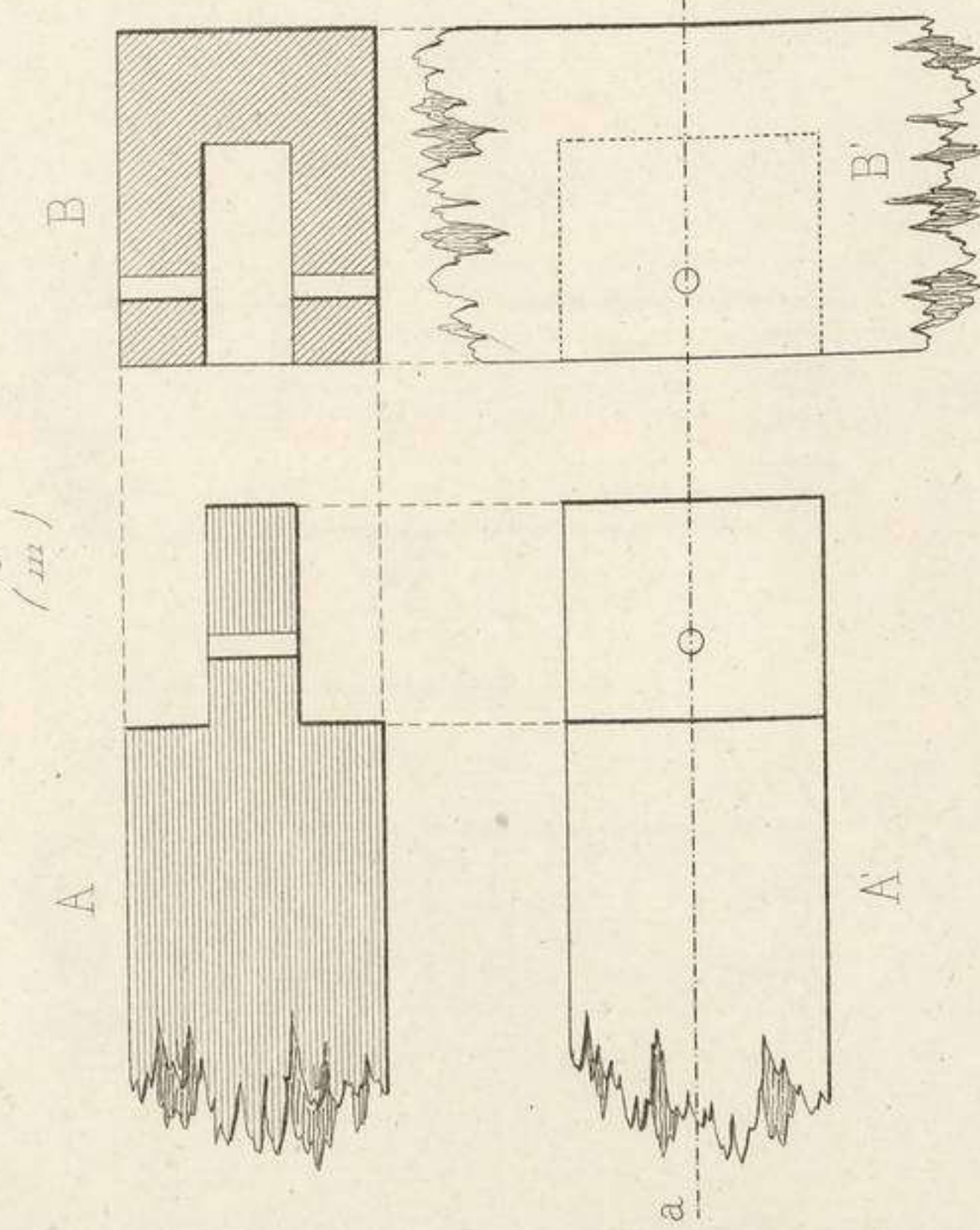

Fig. 2.

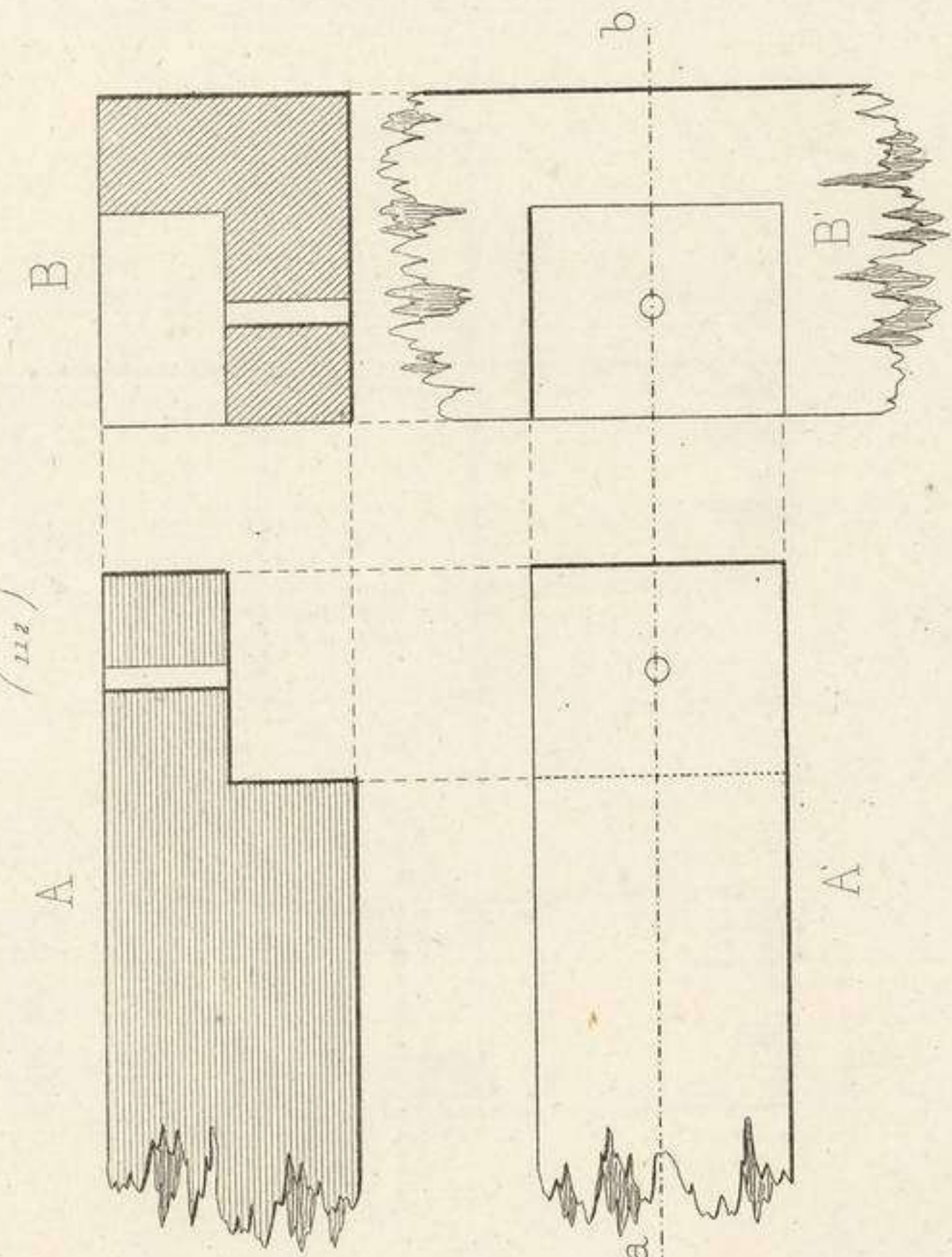

Fig. 3.

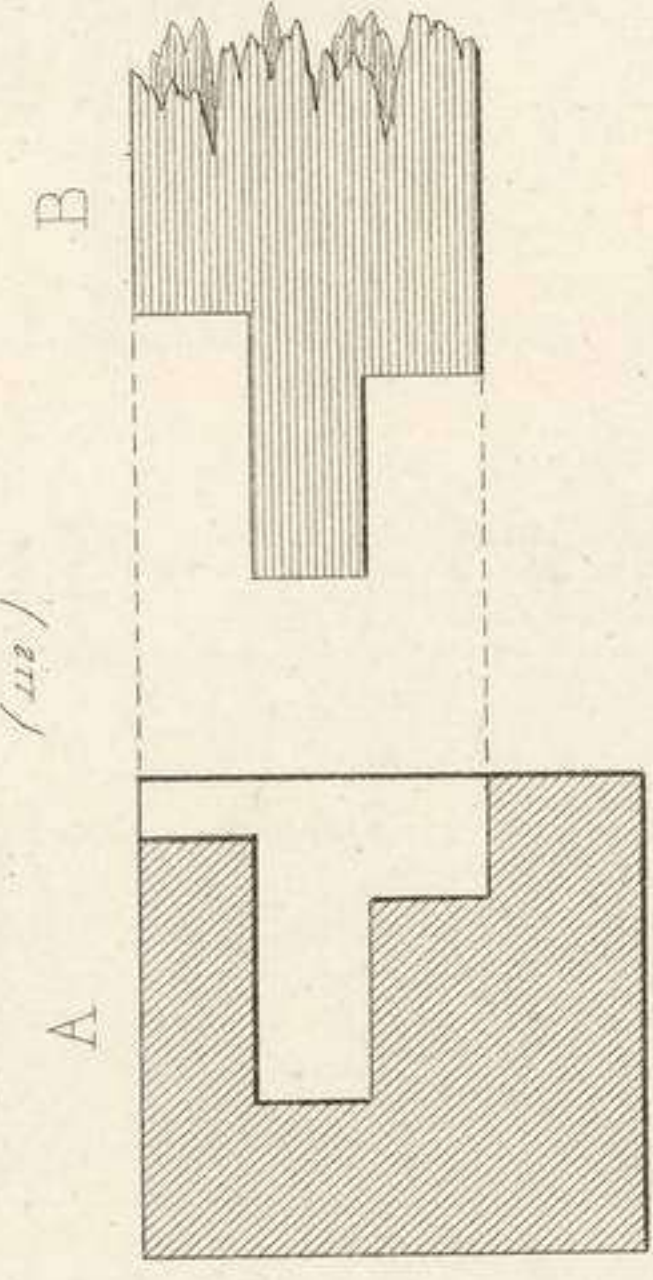

Fig. 5.

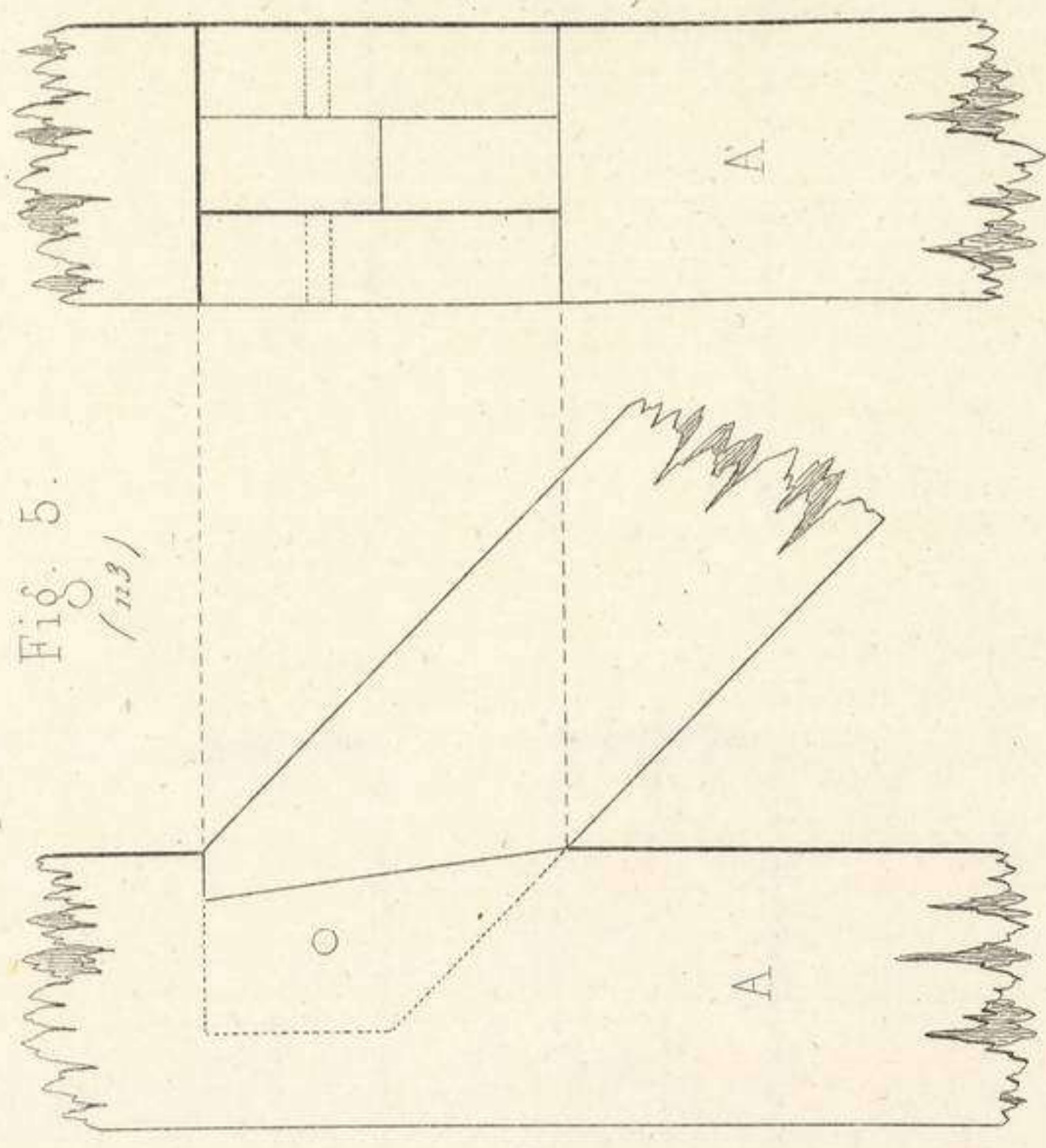

Fig. 4.

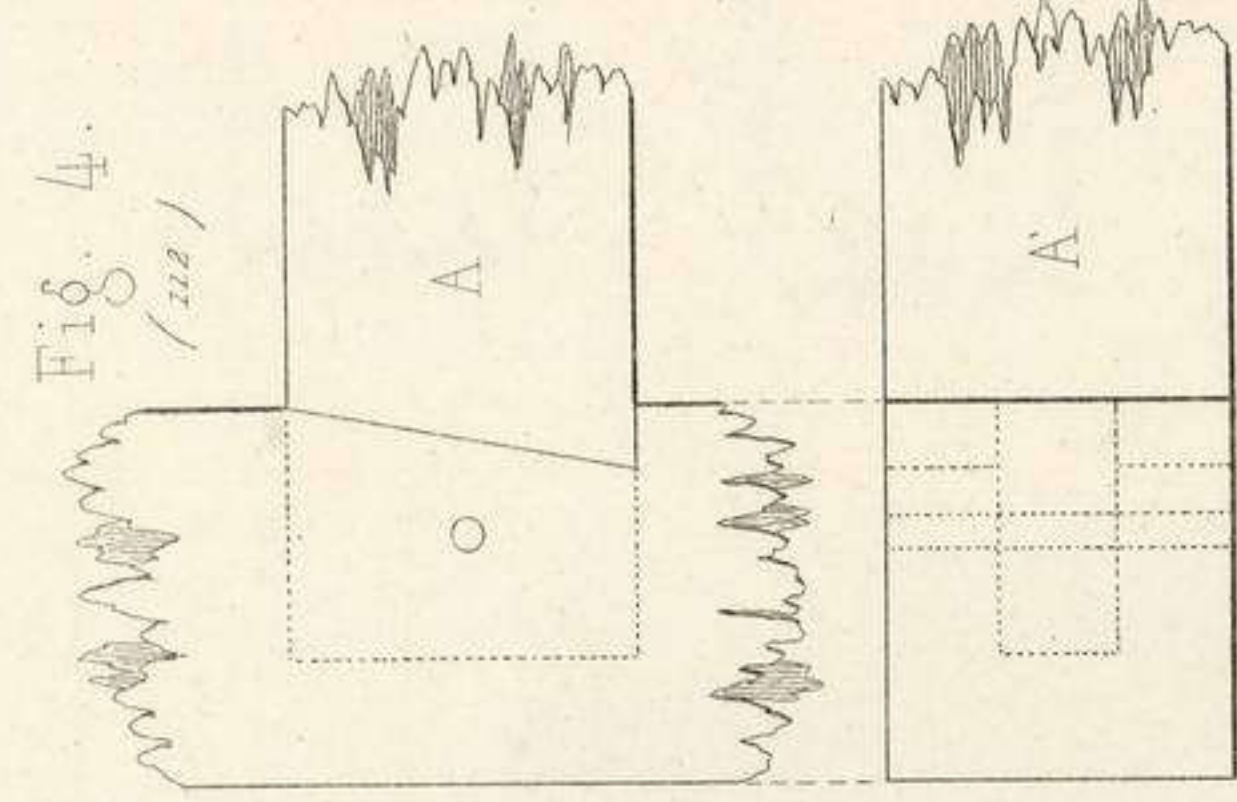

Fig. 6.

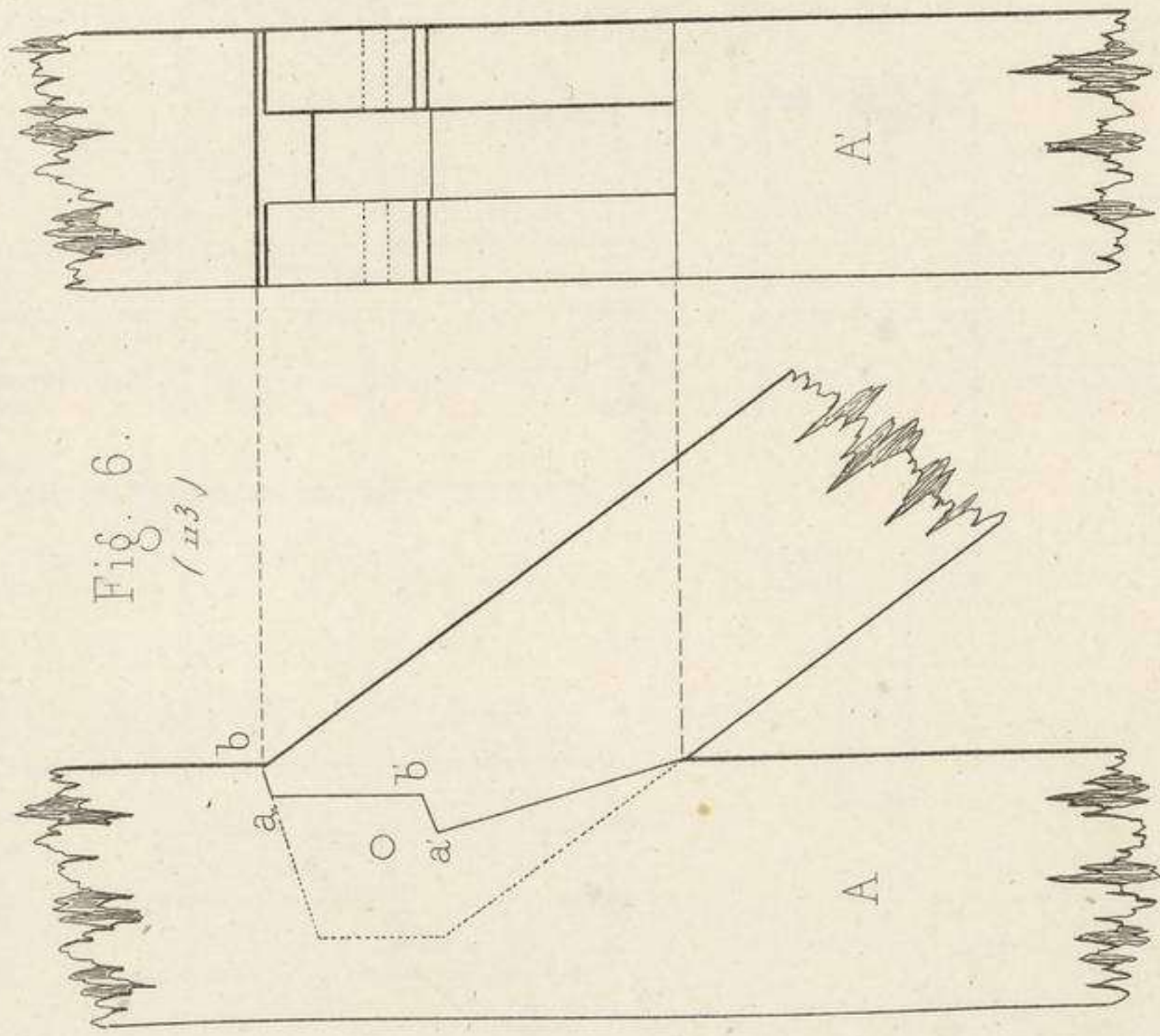

Fig. 7.

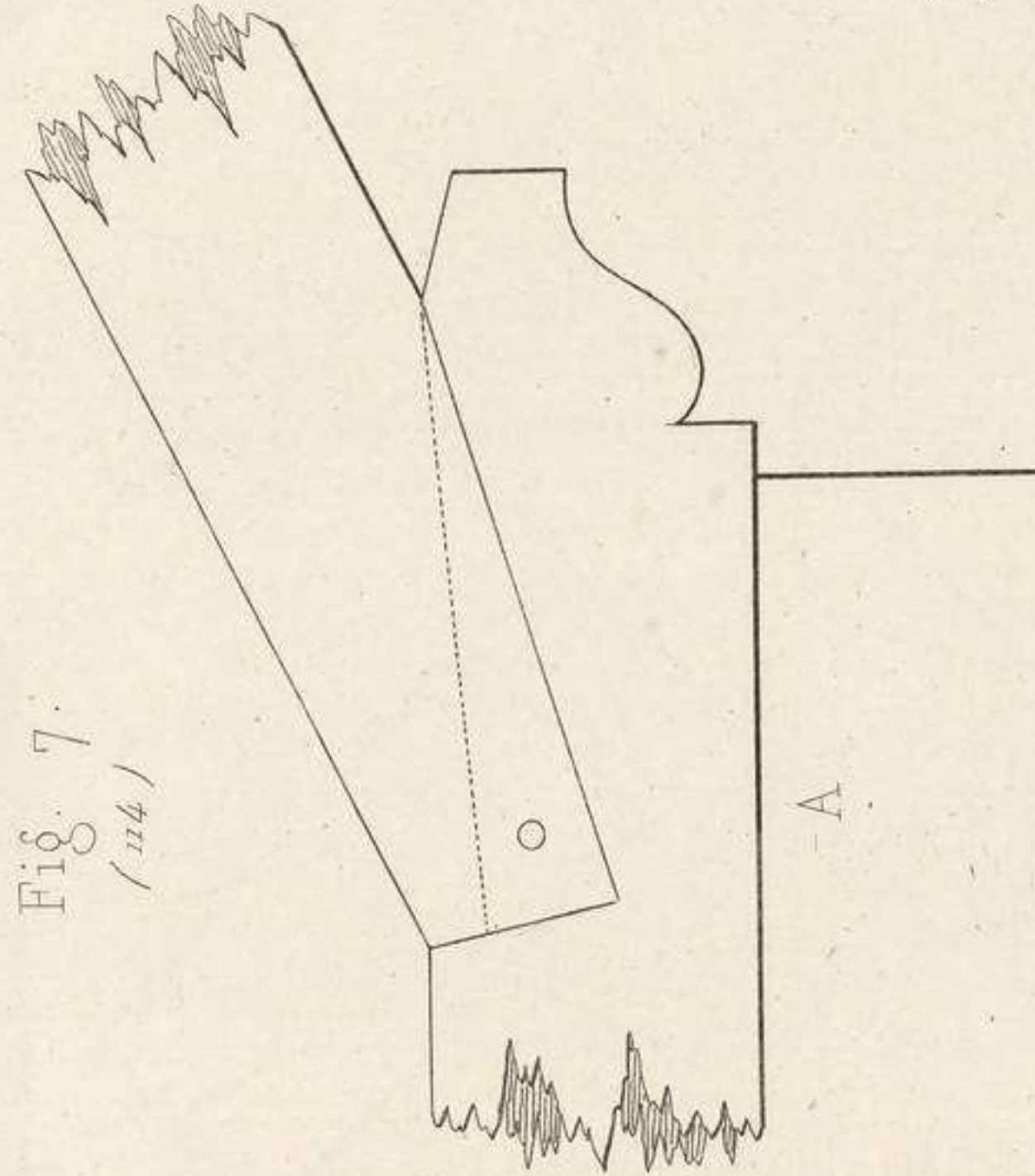

Fig. 8.

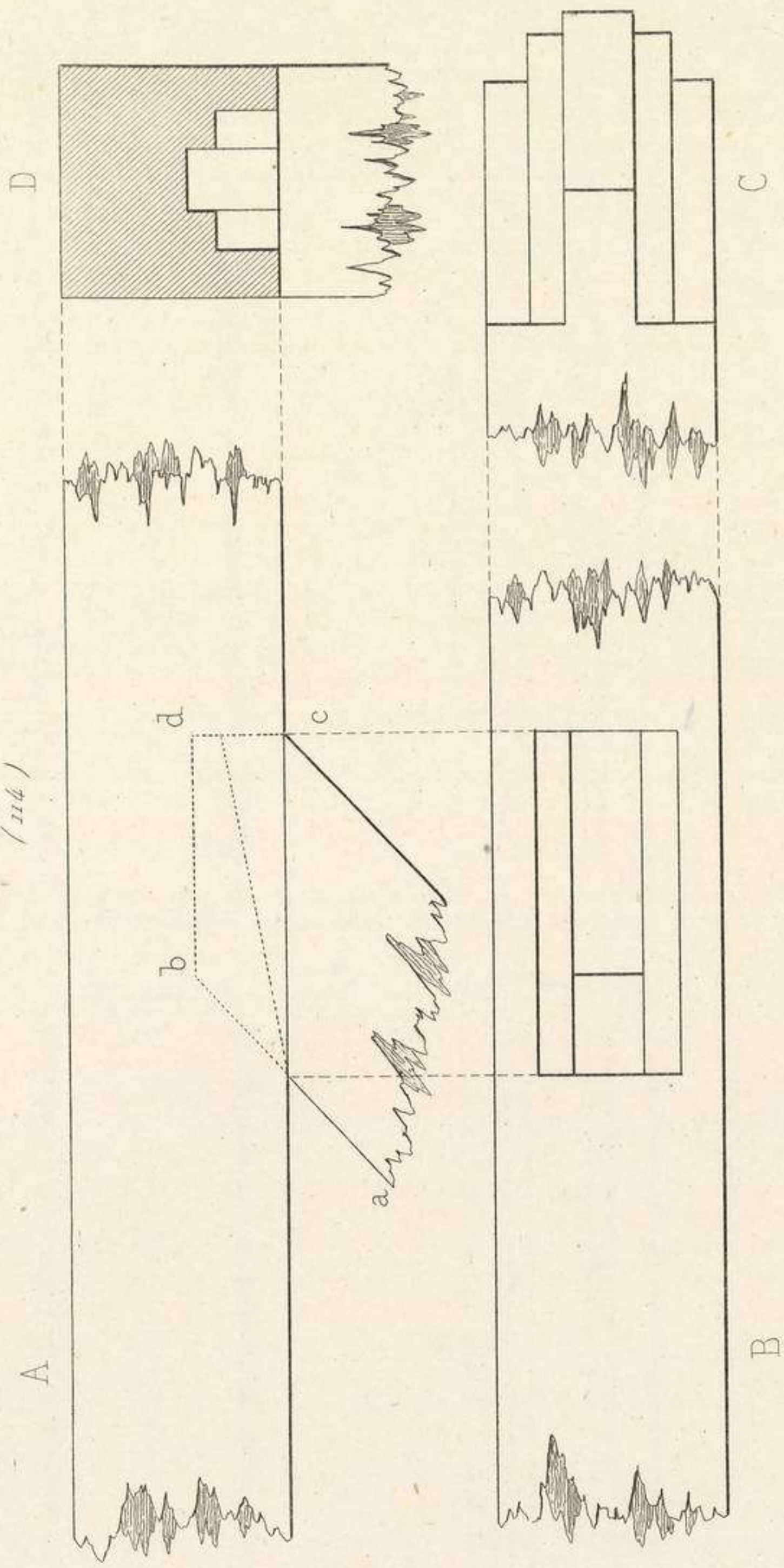

Fig. 9.

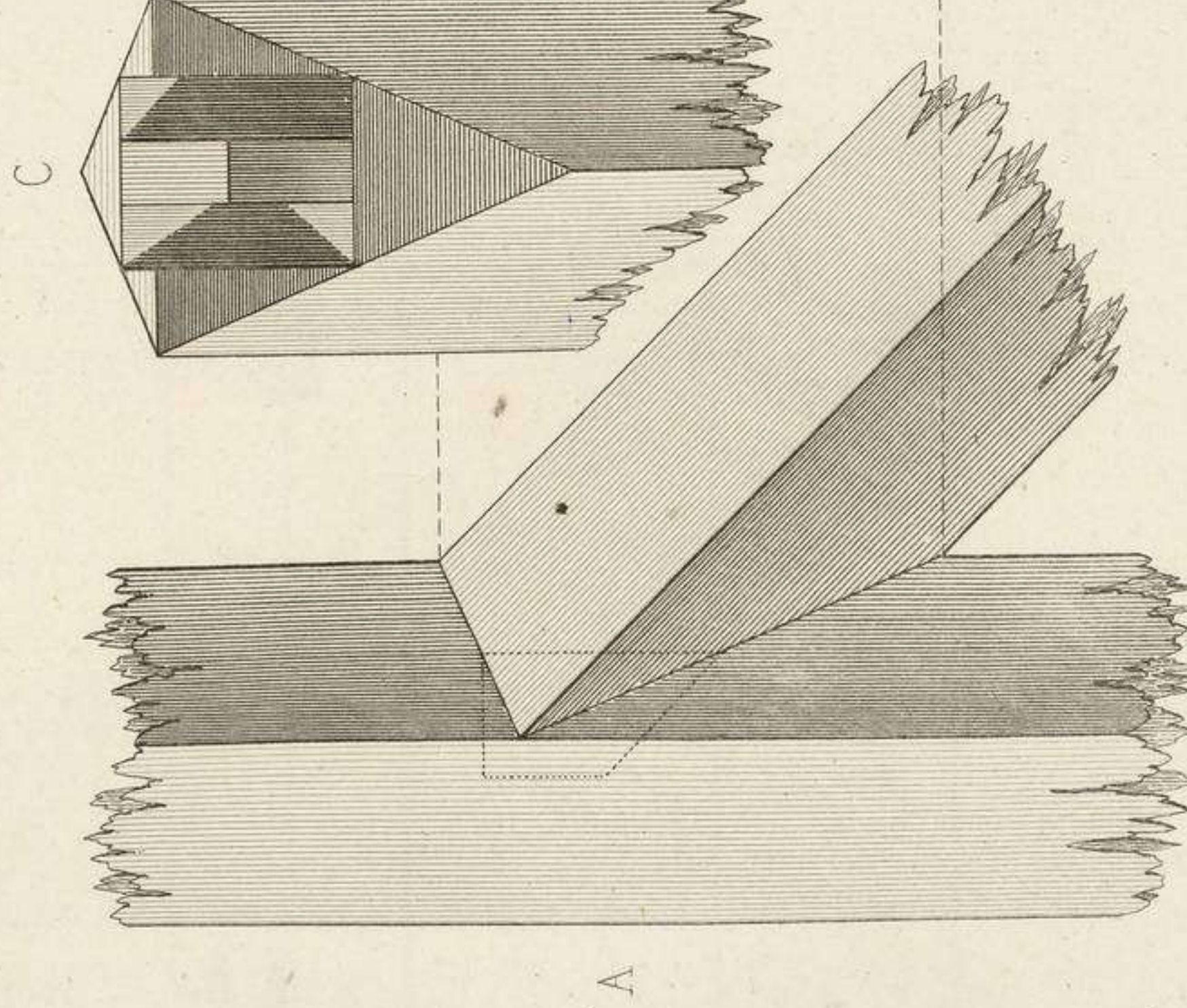

Fig. 10.

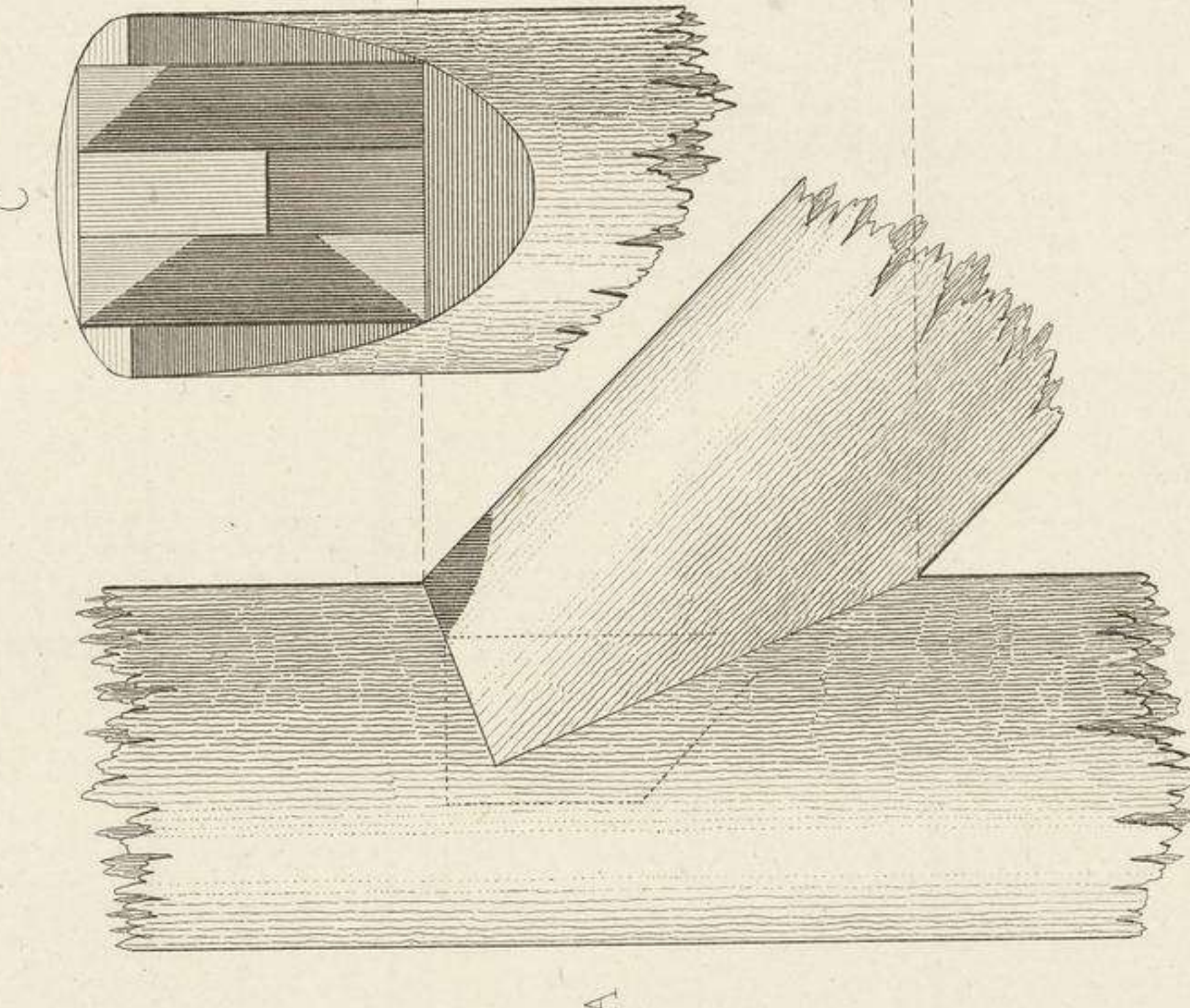
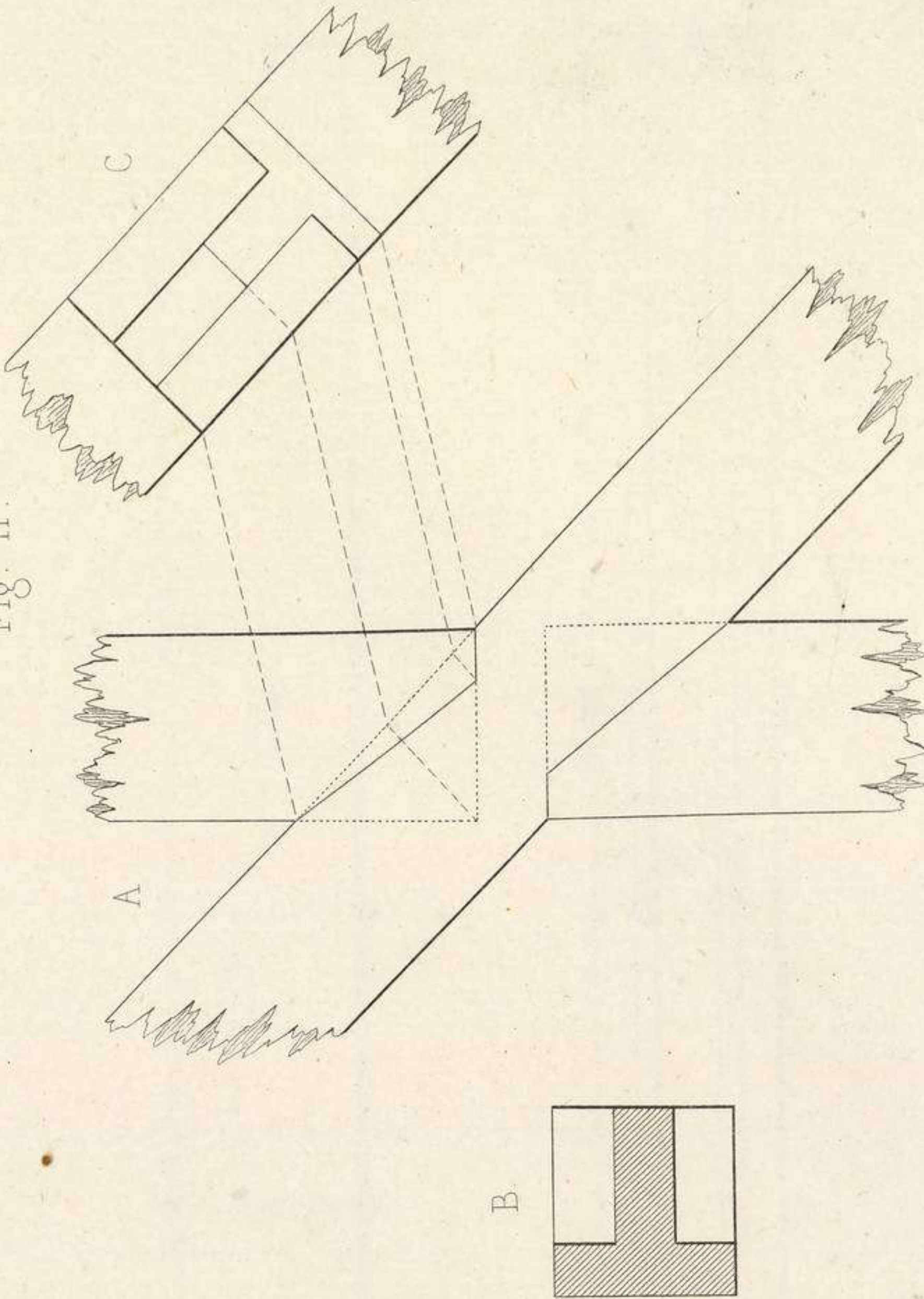

Fig. 11.





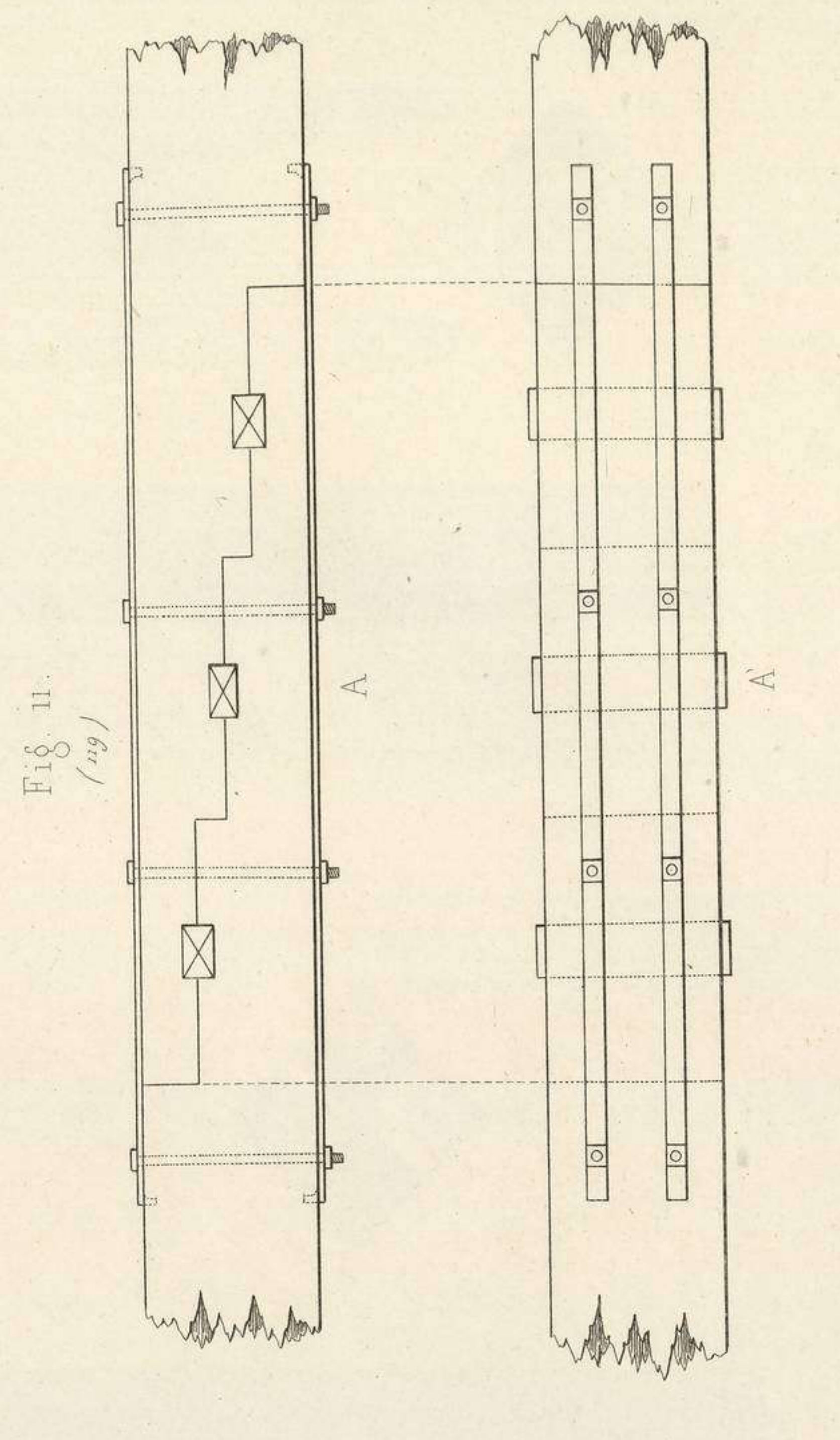
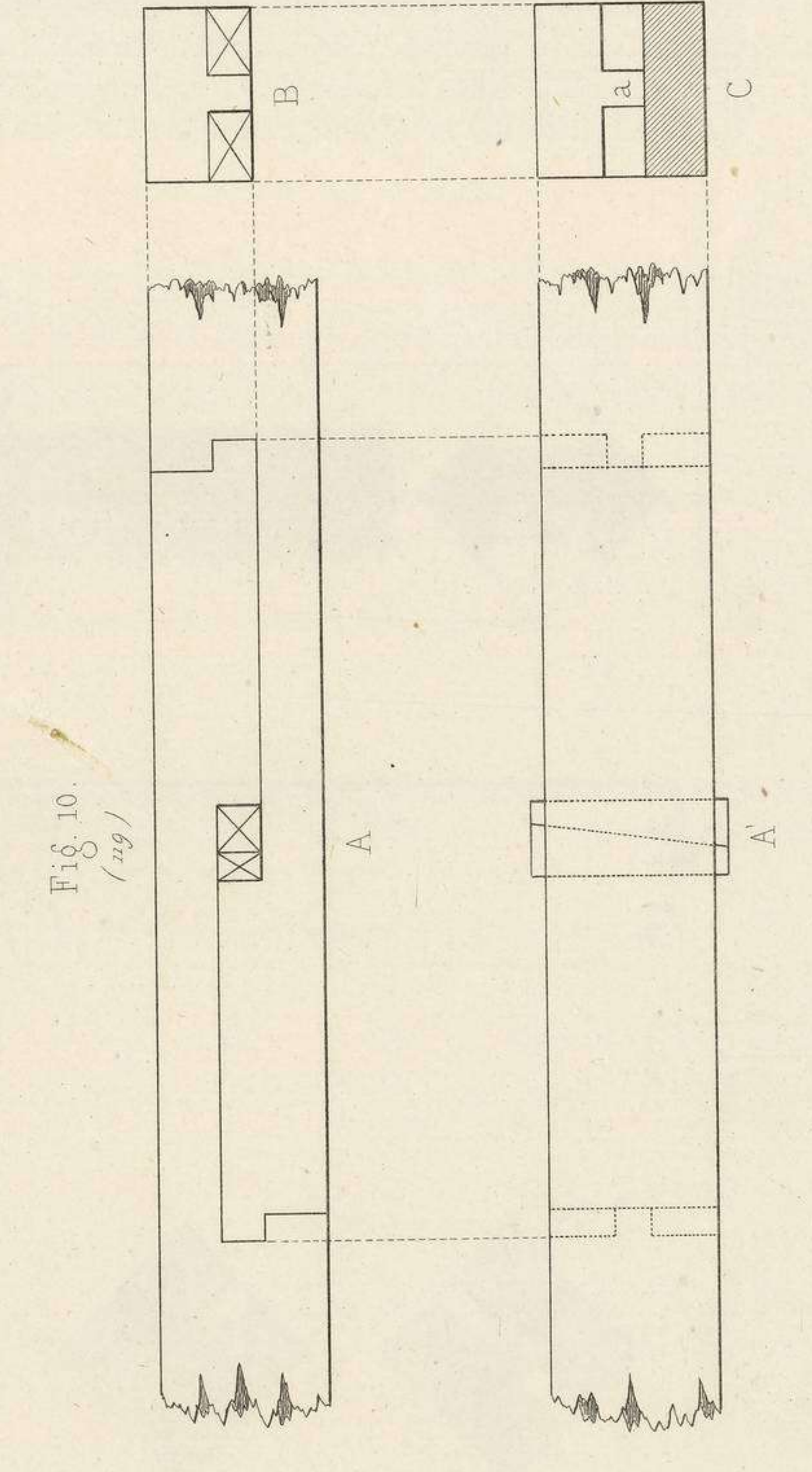
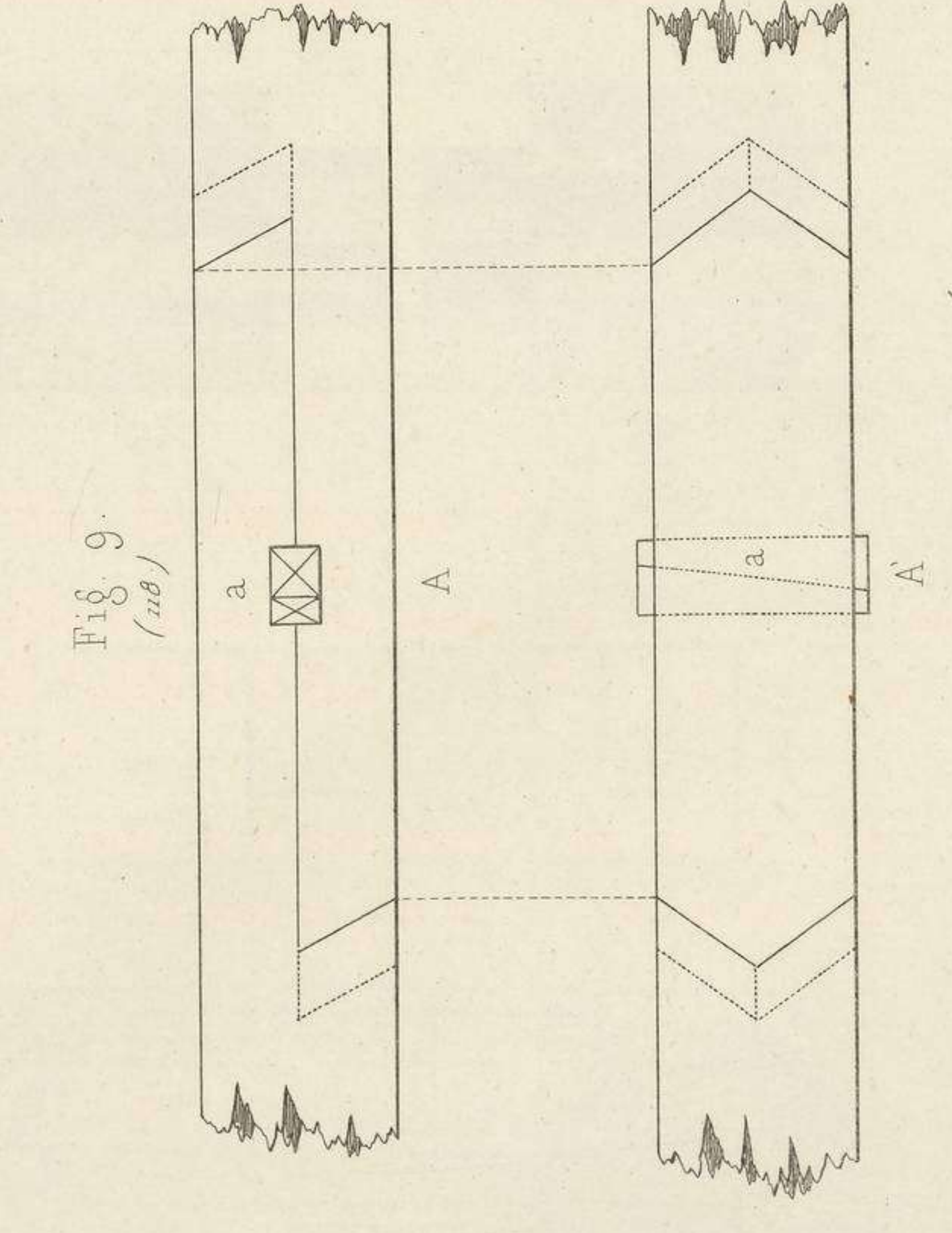
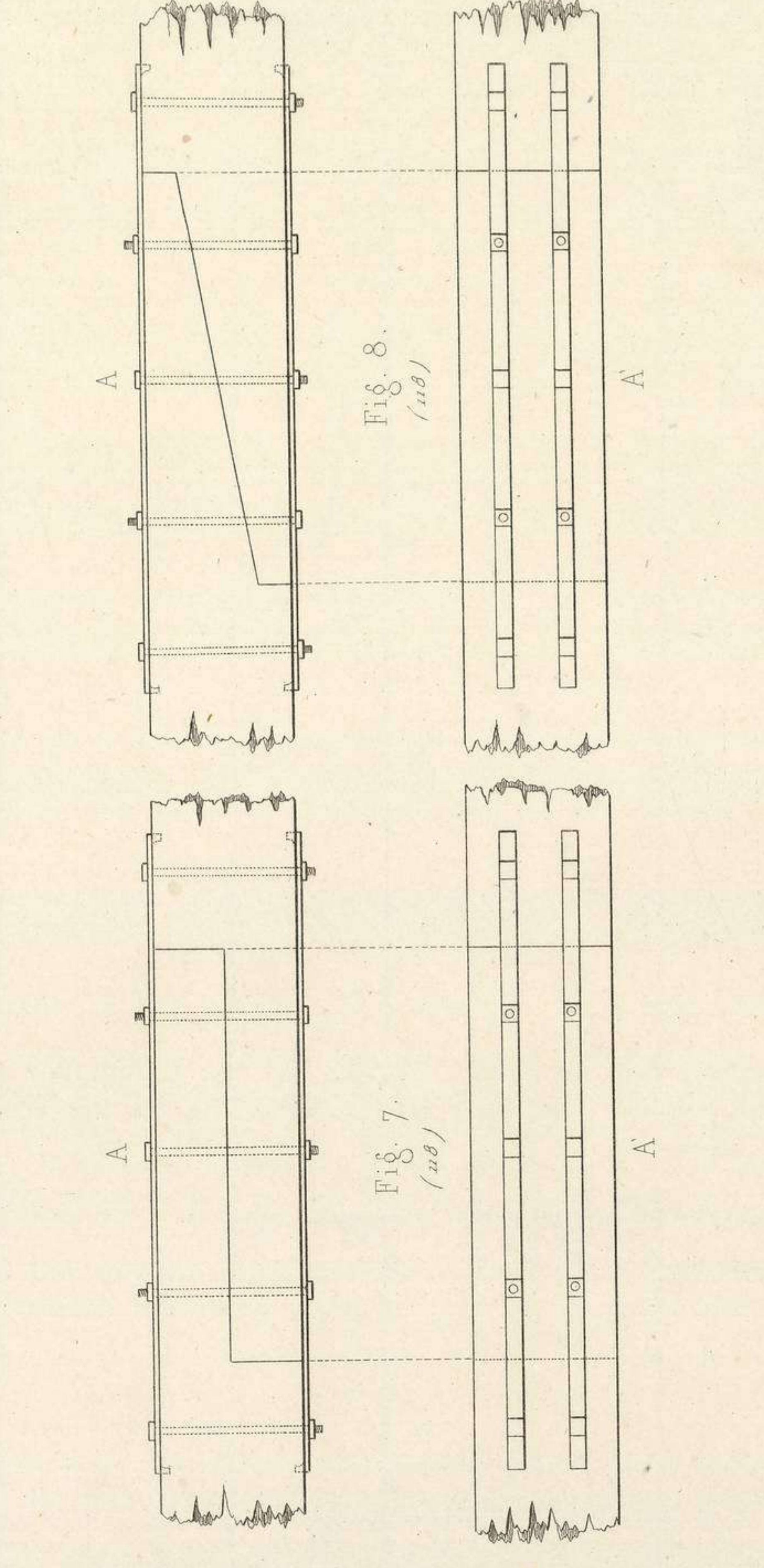
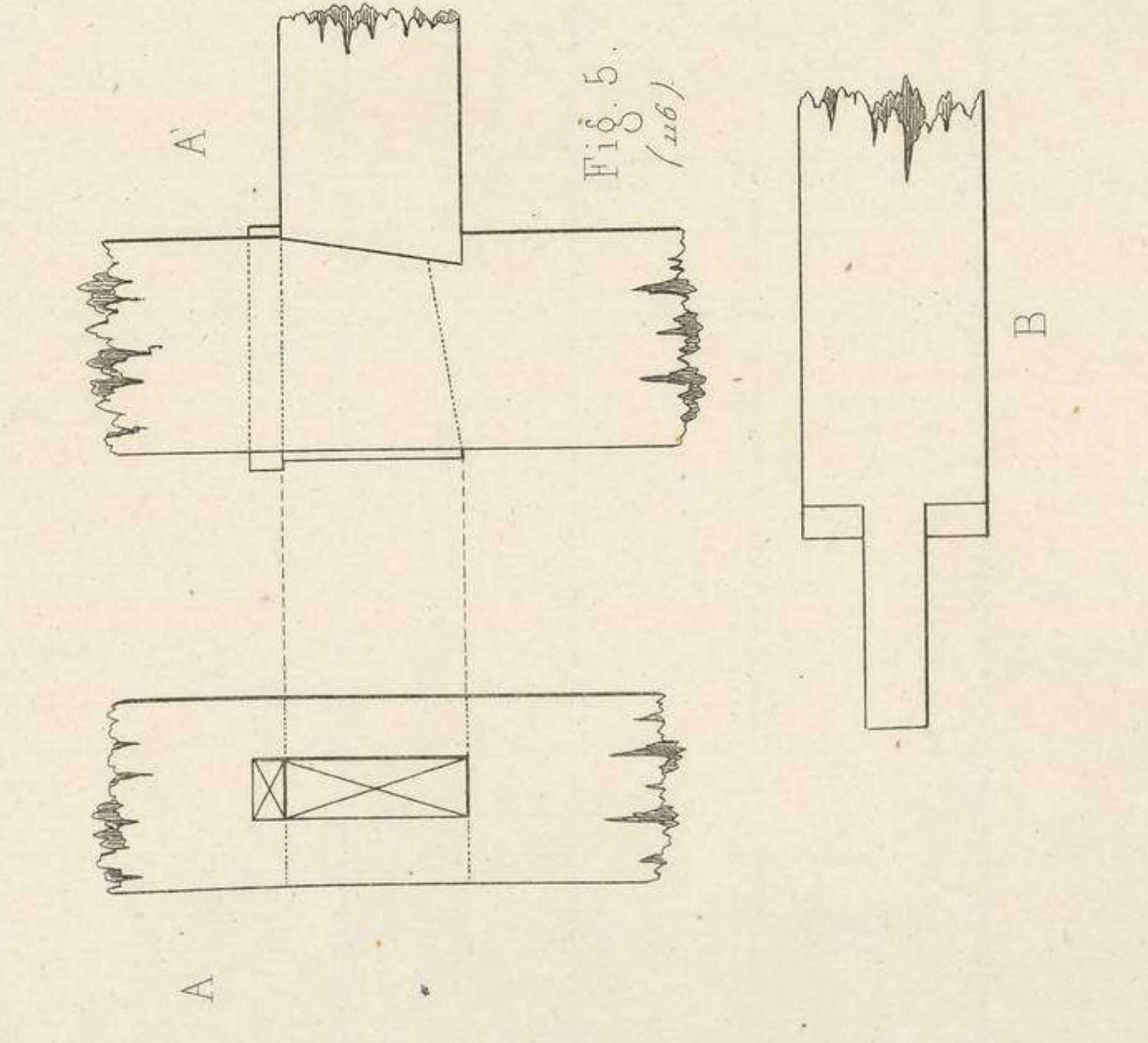
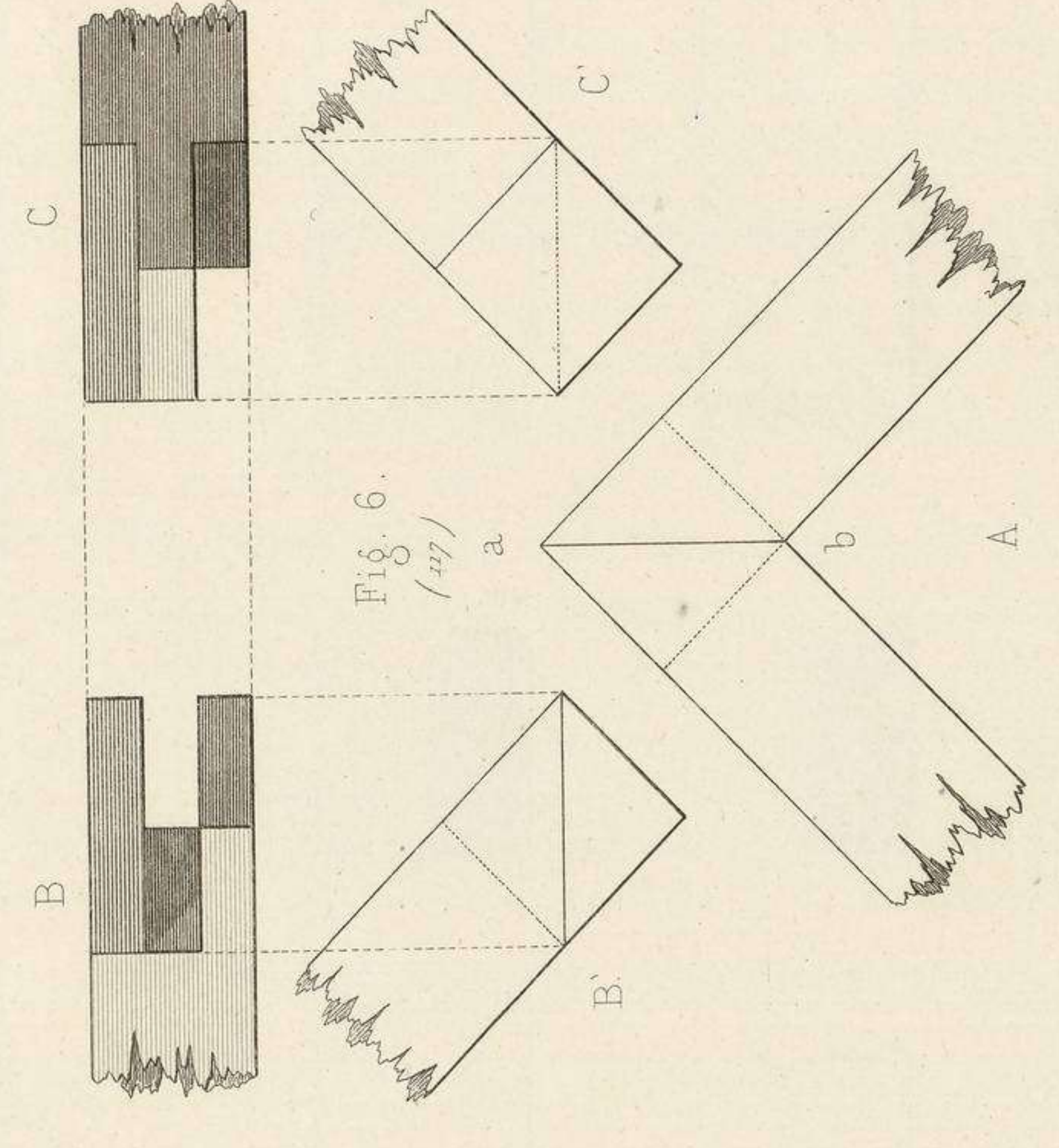
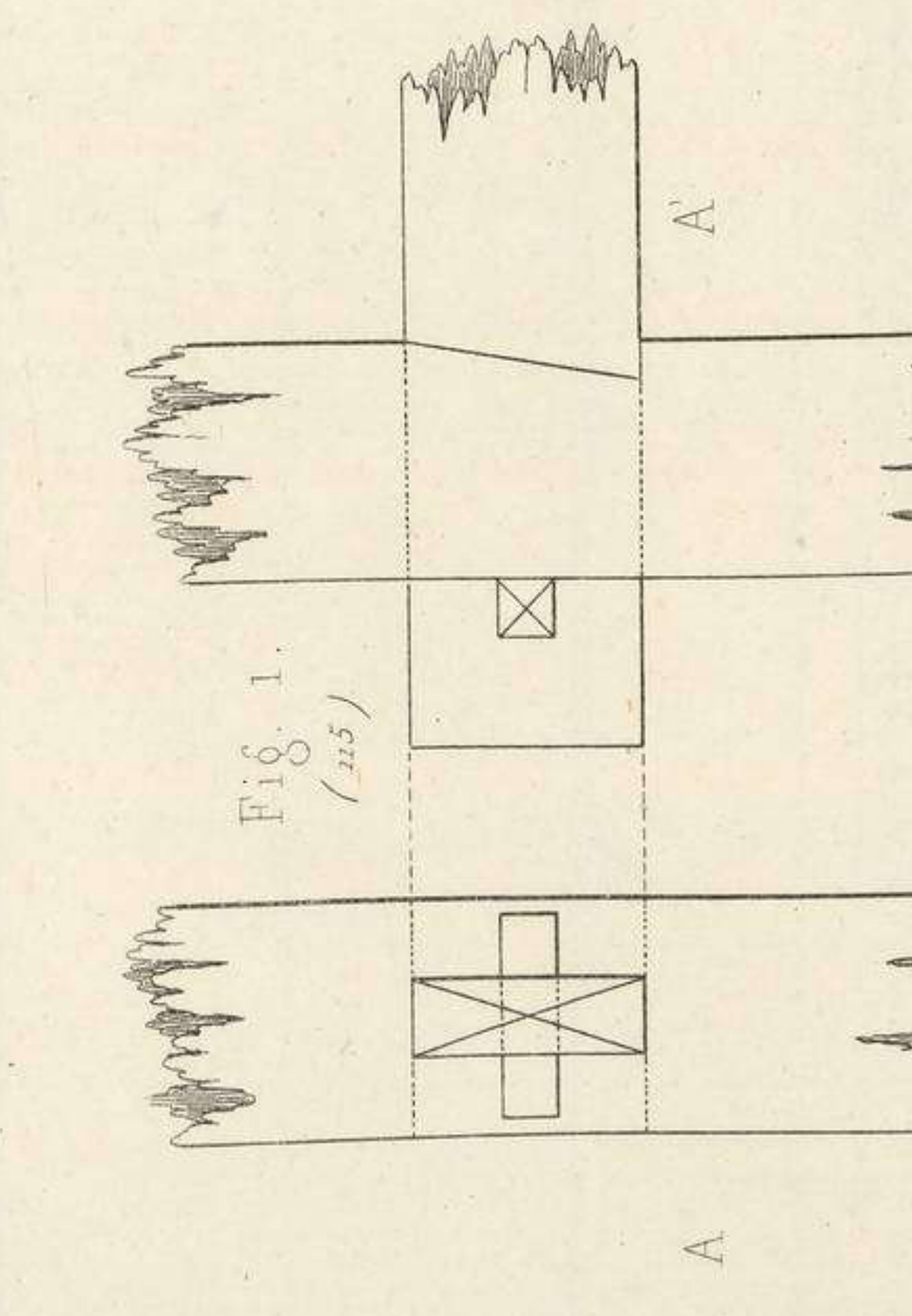
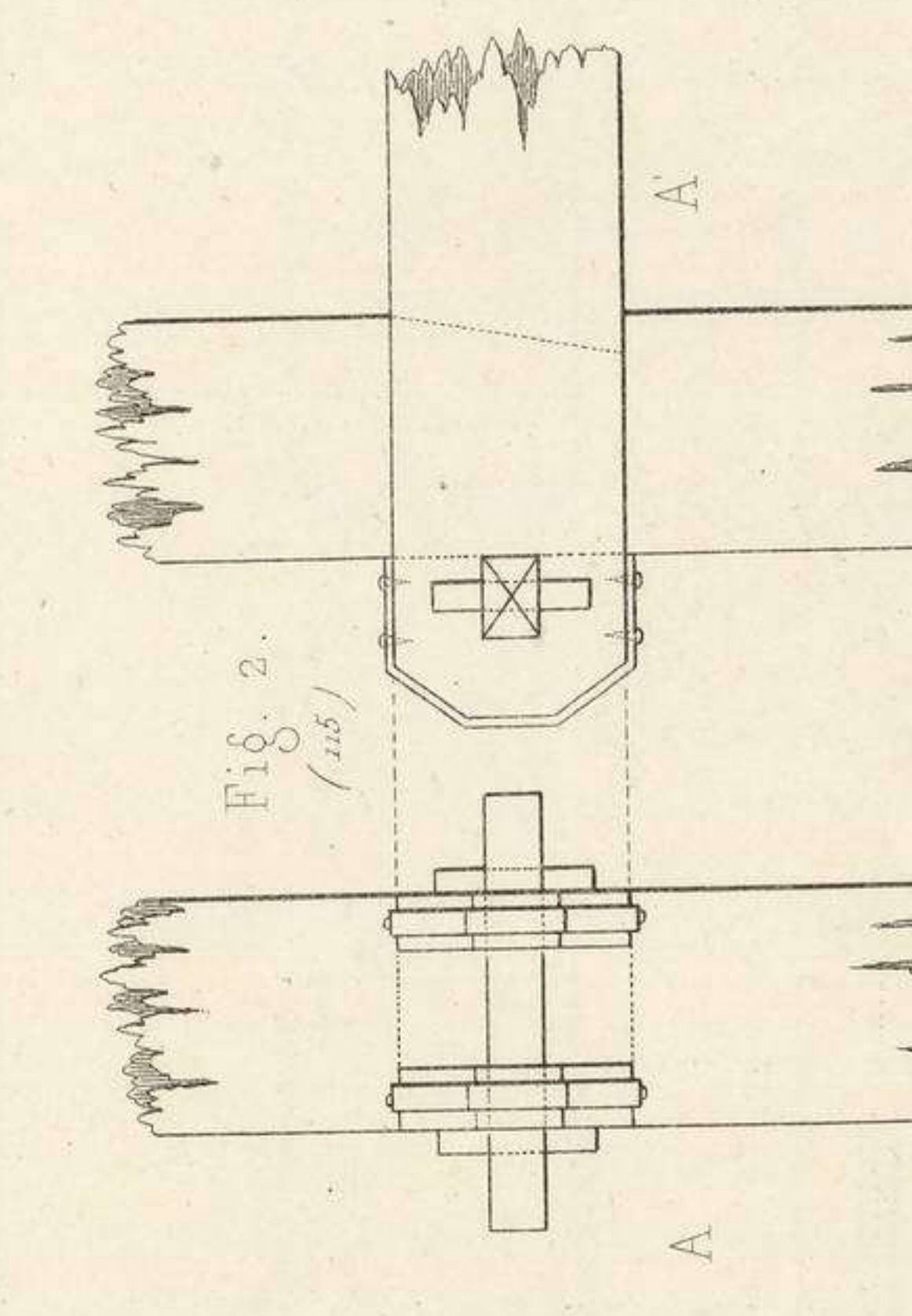
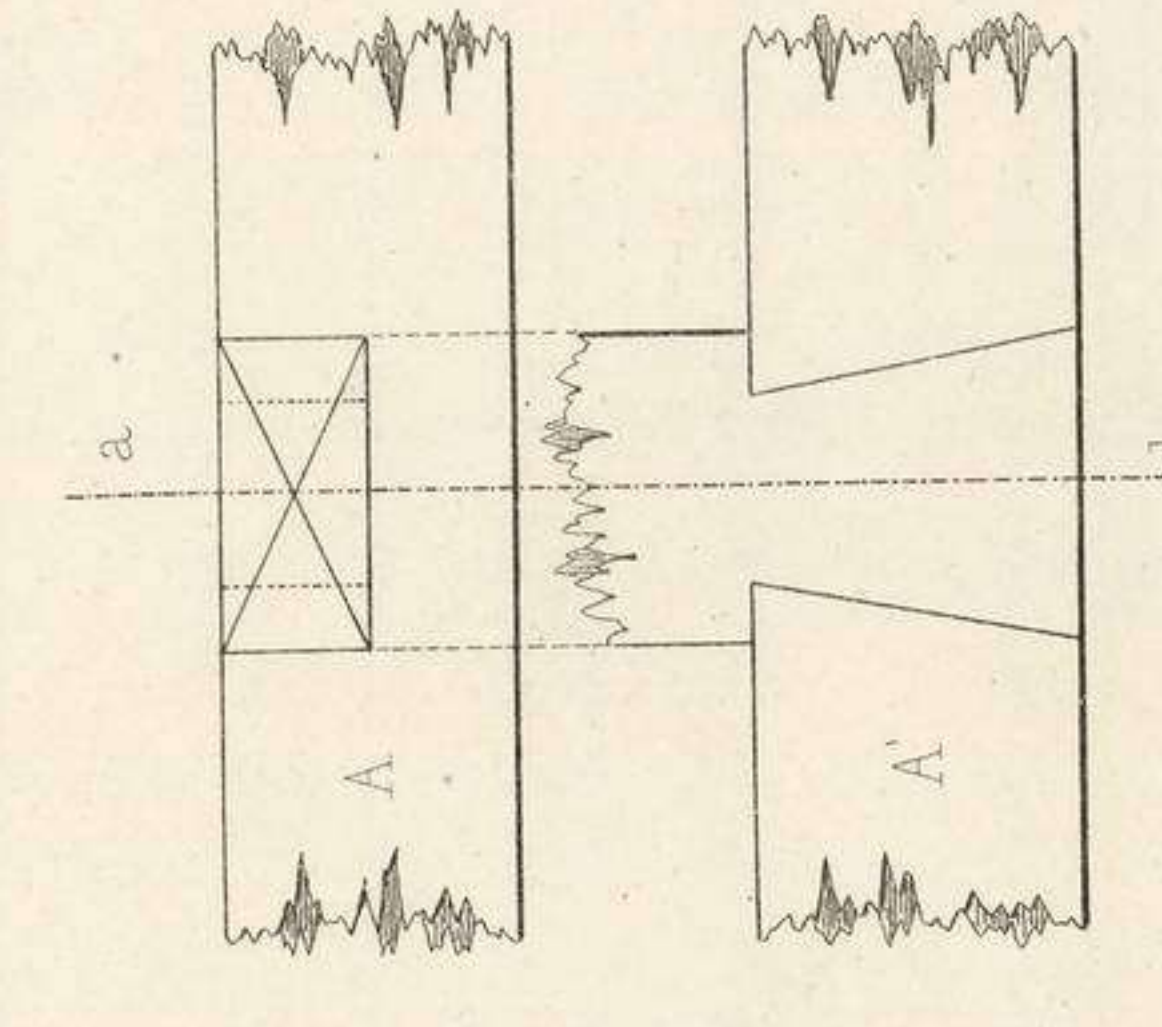
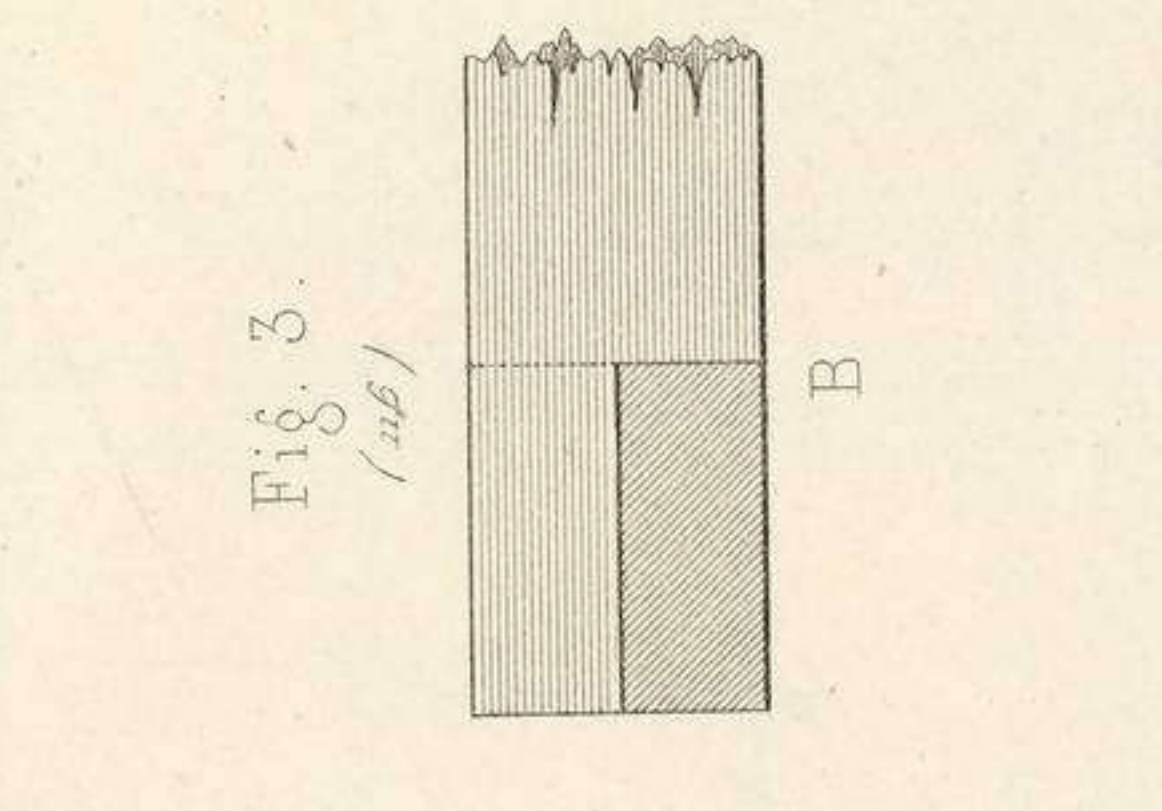
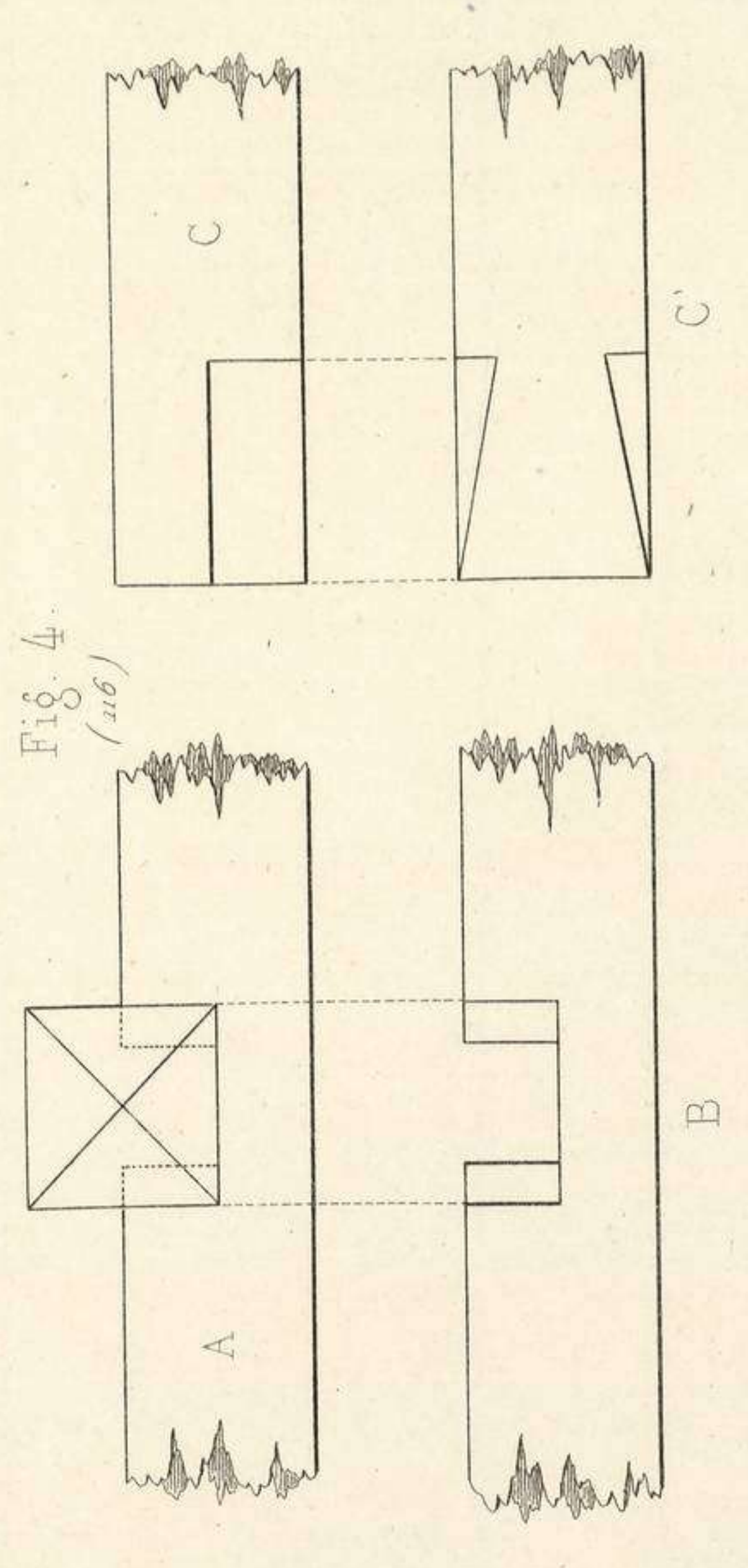



Fig. 1. (119)

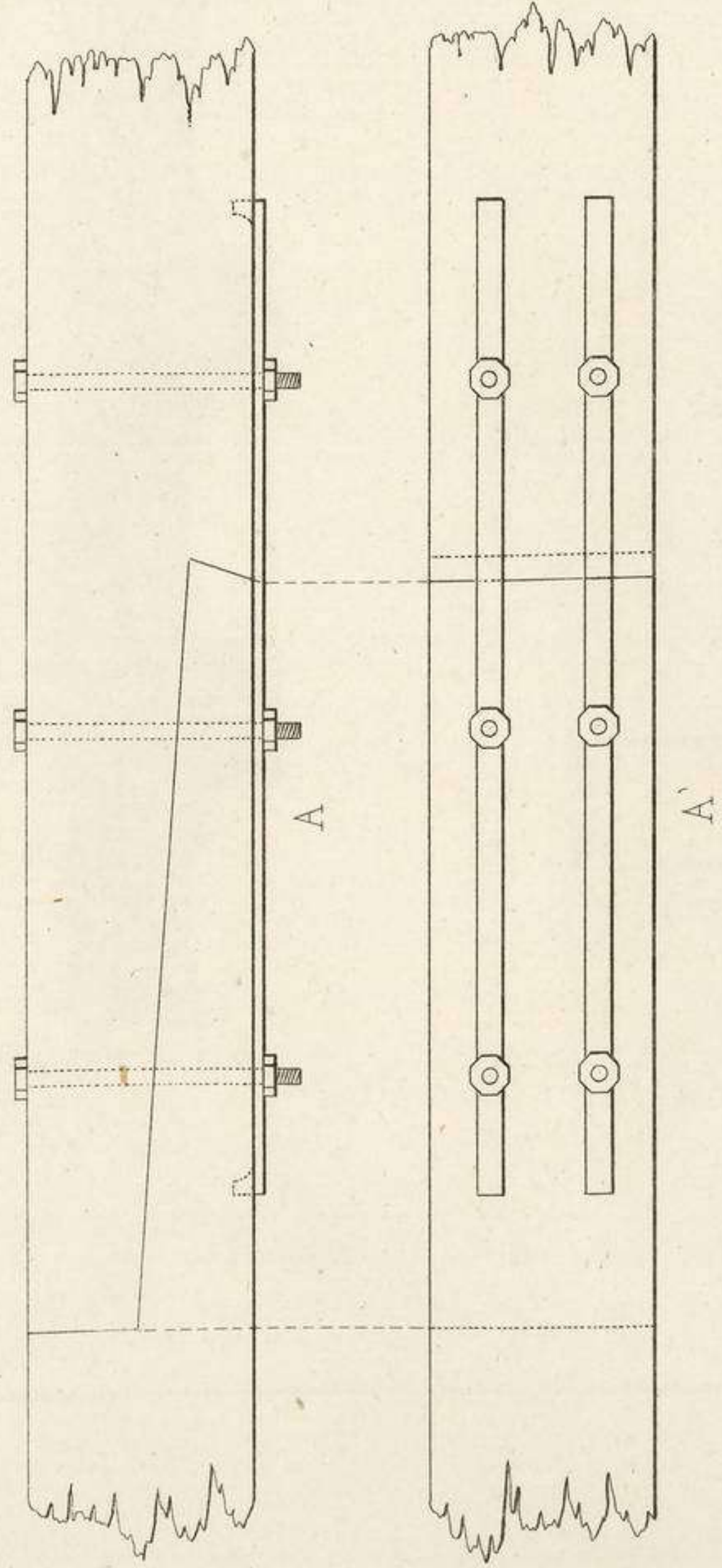

Fig. 2. (120)

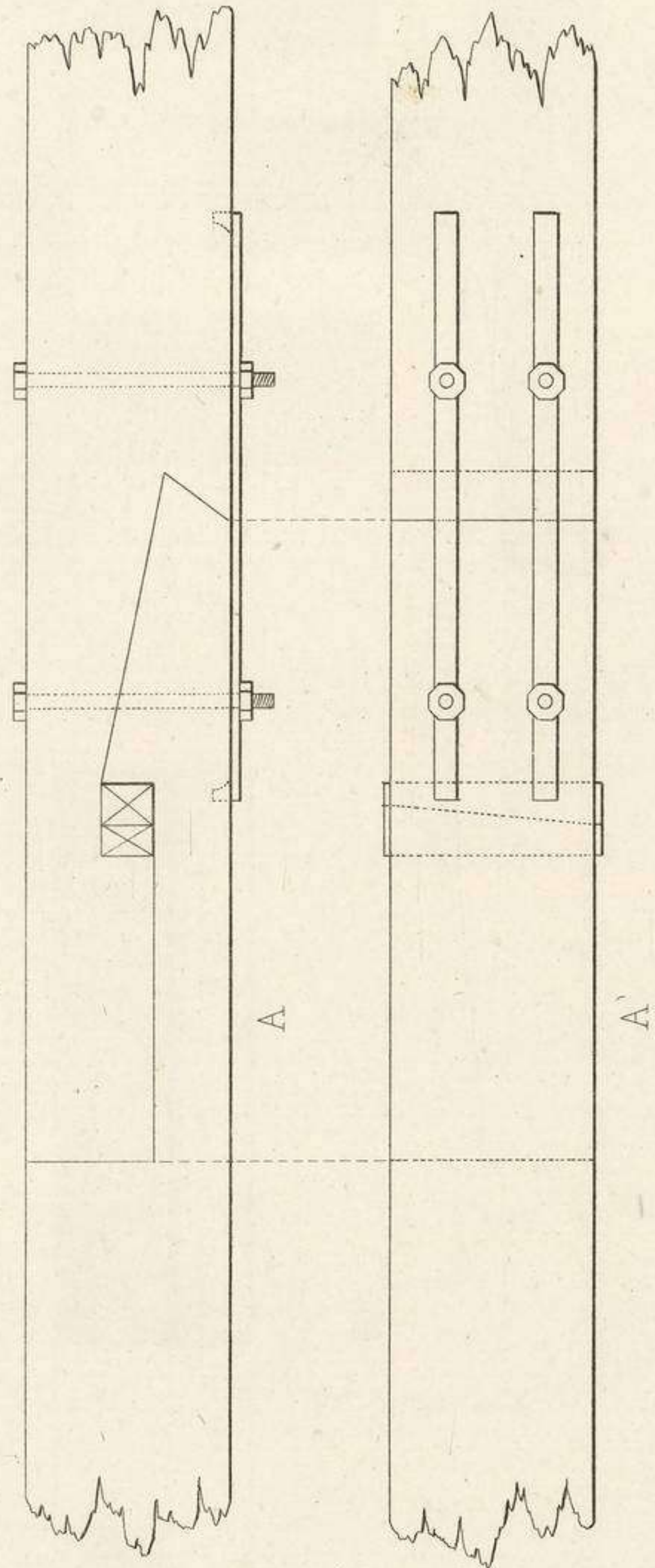

Fig. 6. (120)

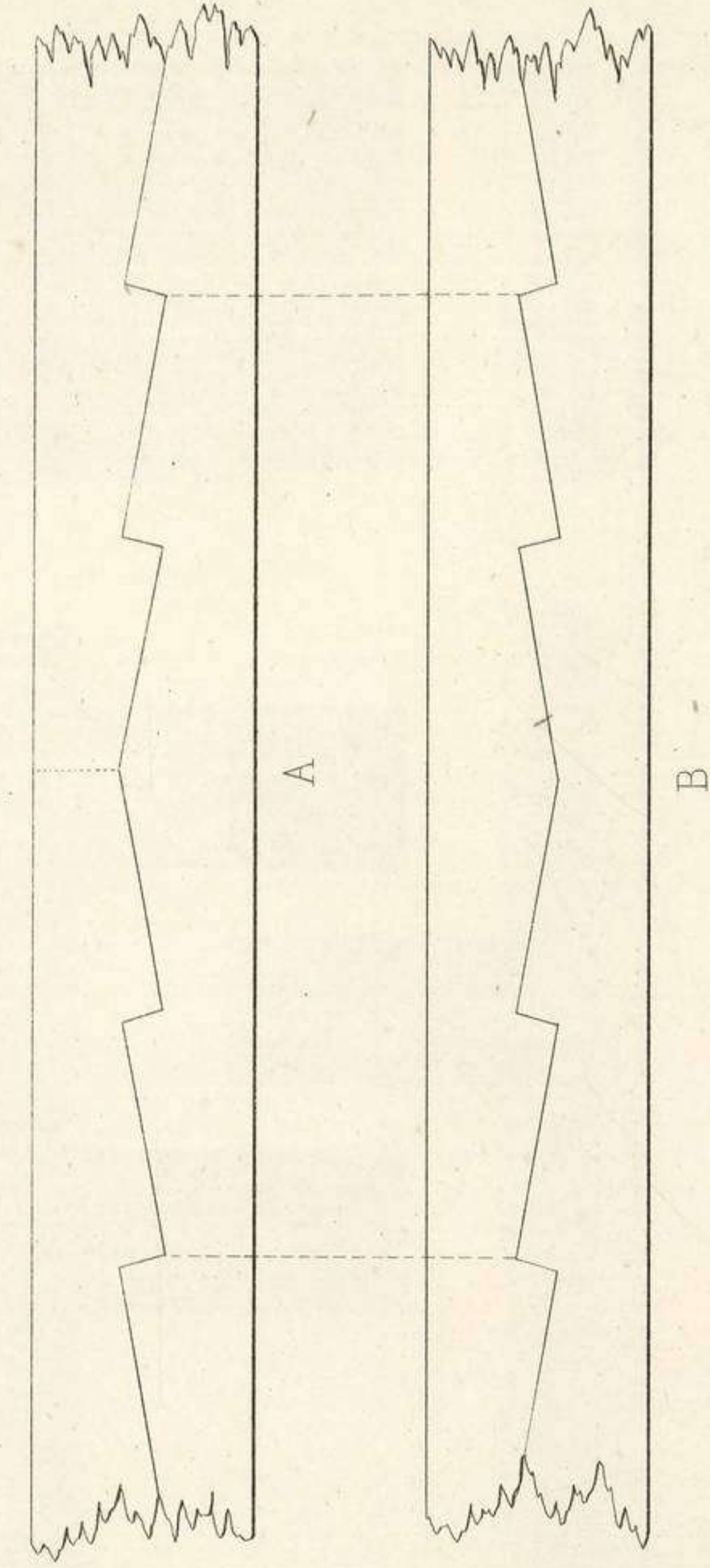

Fig. 3. (120)

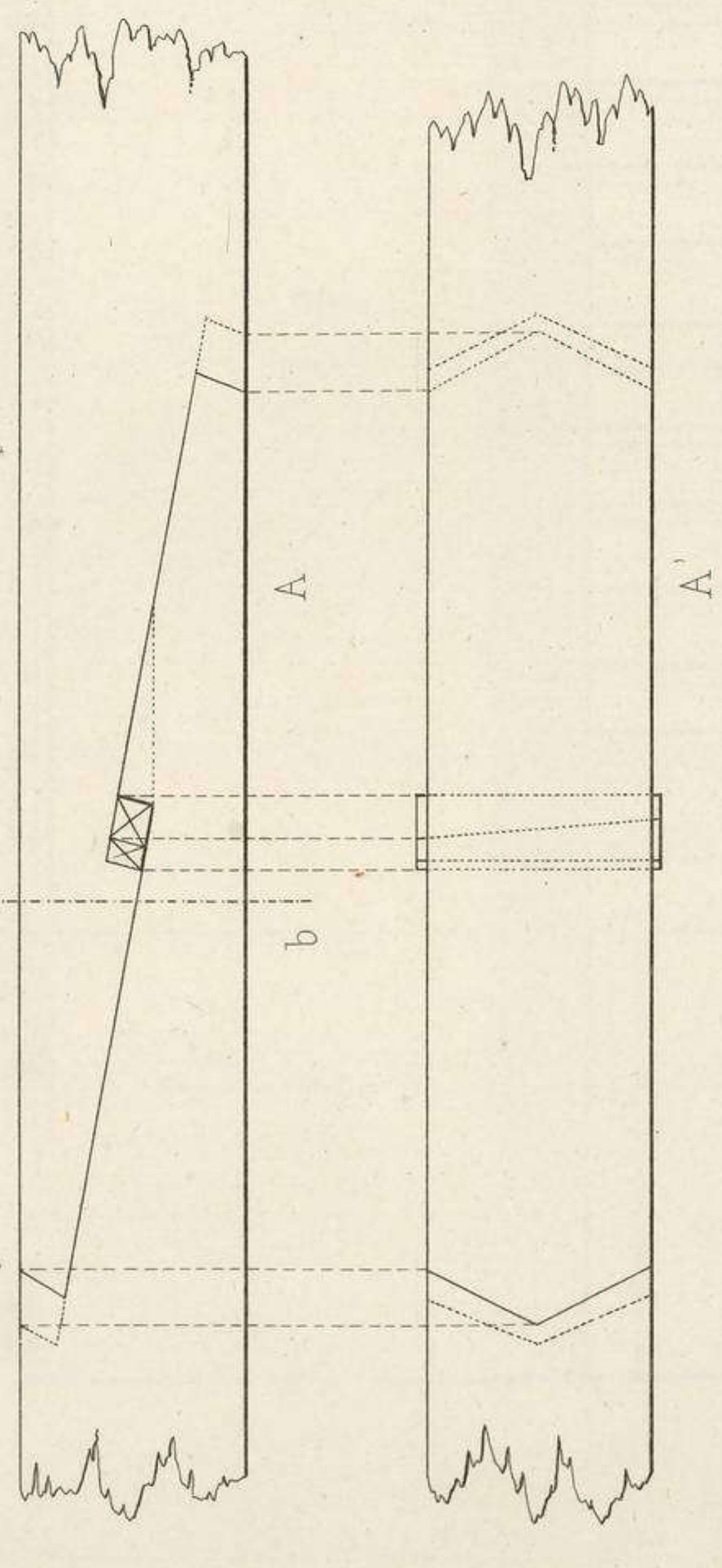

Fig. 4. (120)

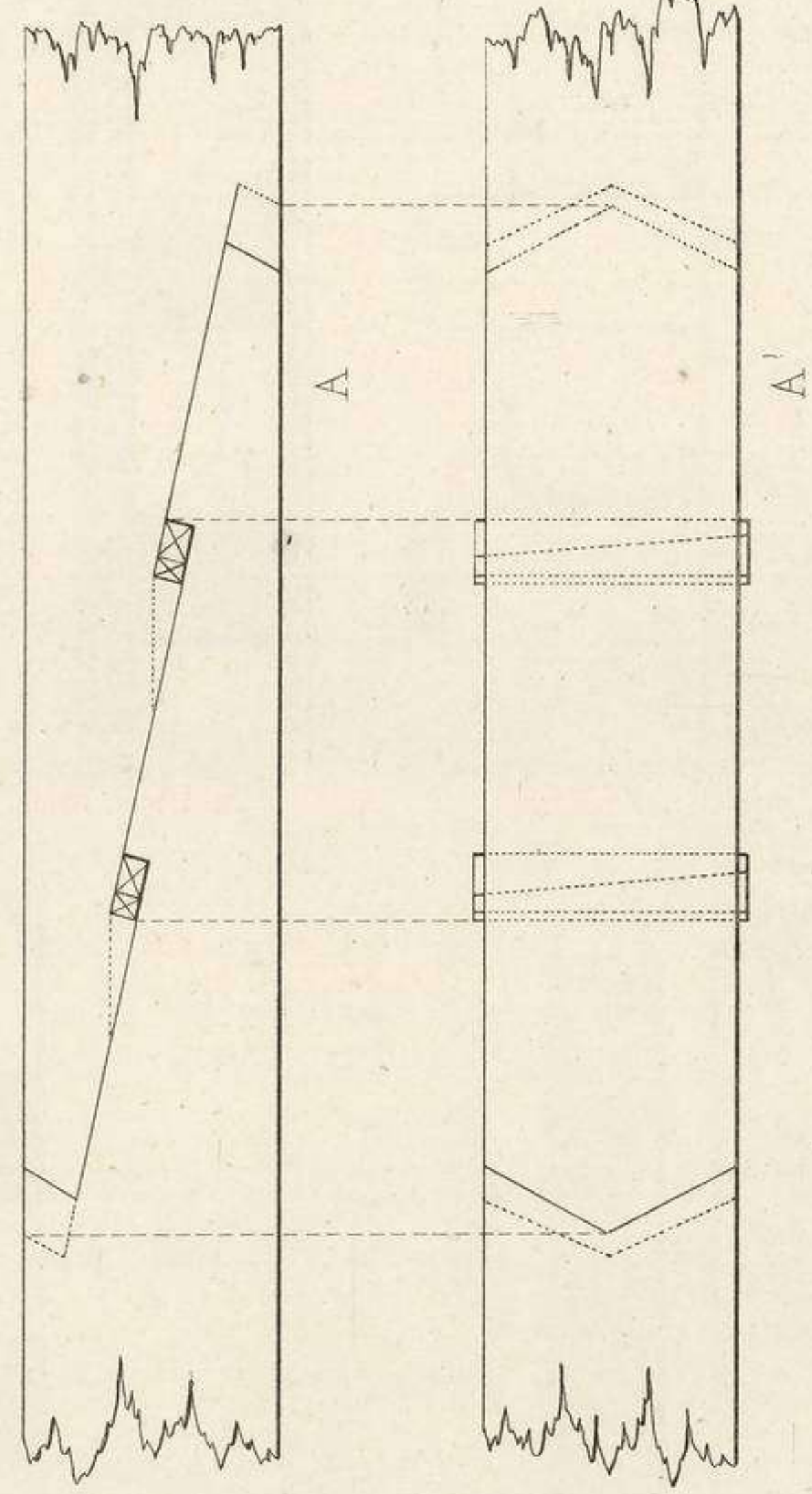

Fig. 5. (120)

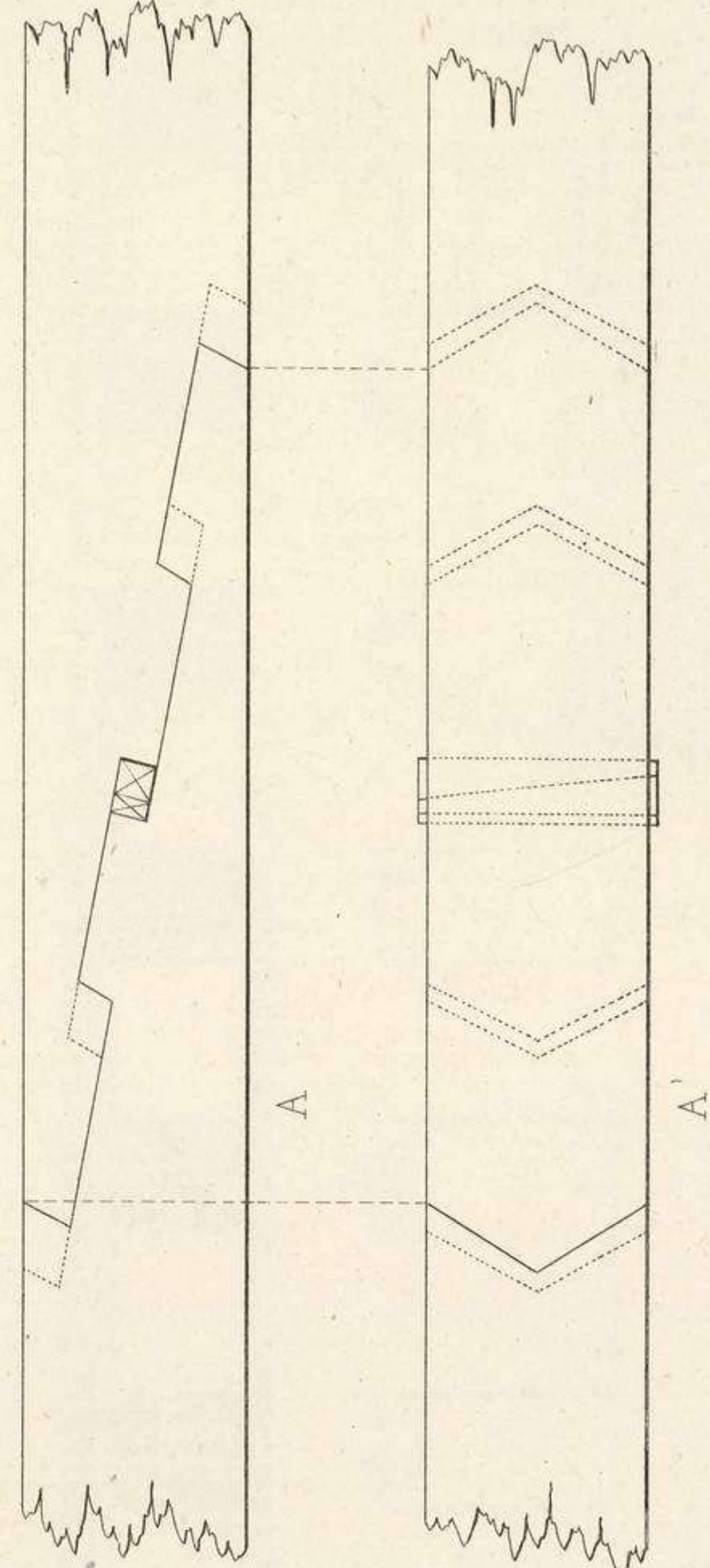

Fig. 7. (121)

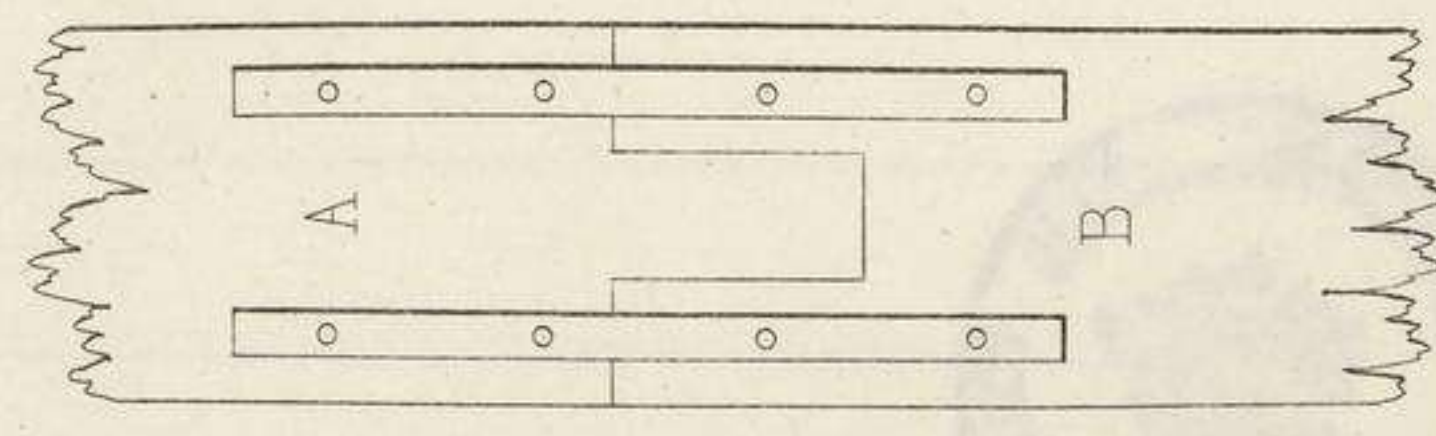

Fig. 8. (121)

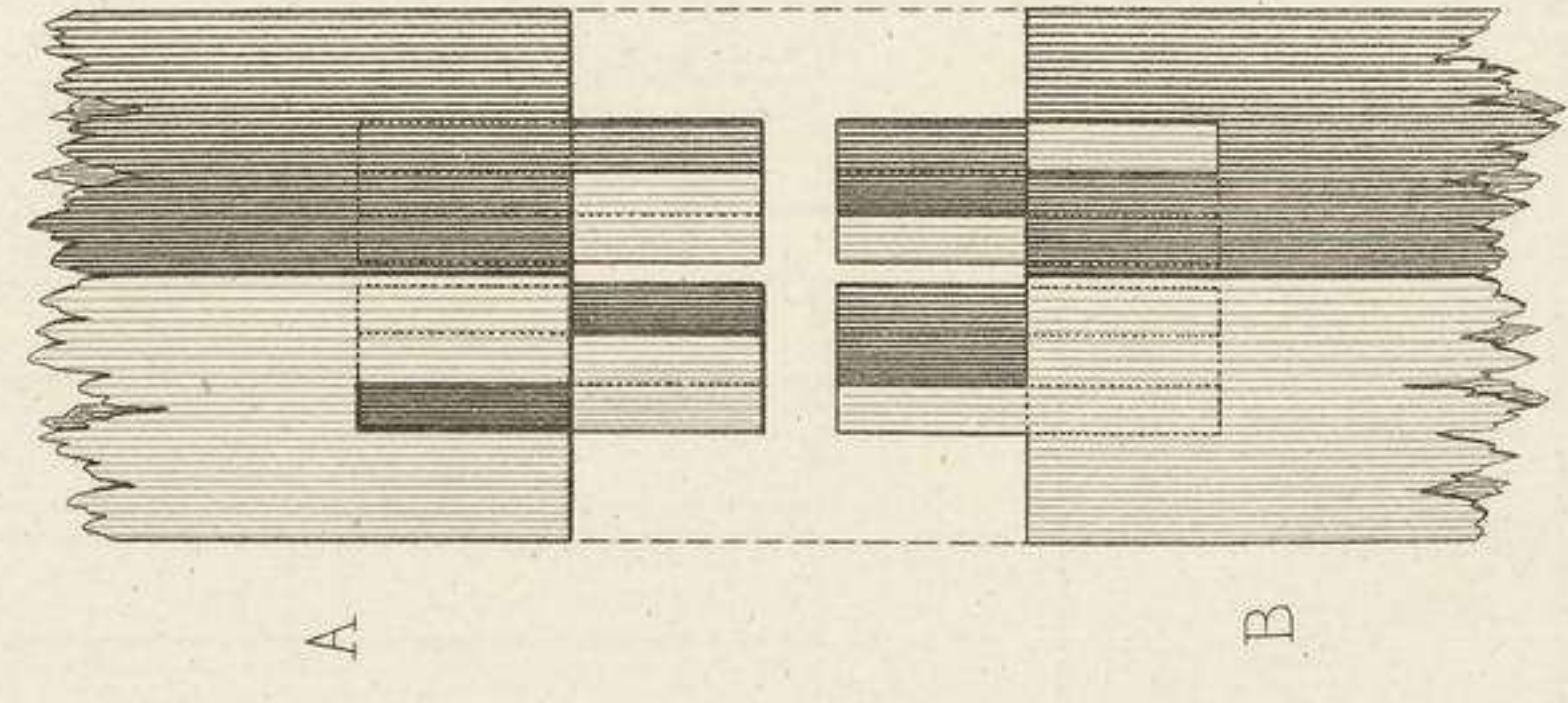

Fig. 9. (122)

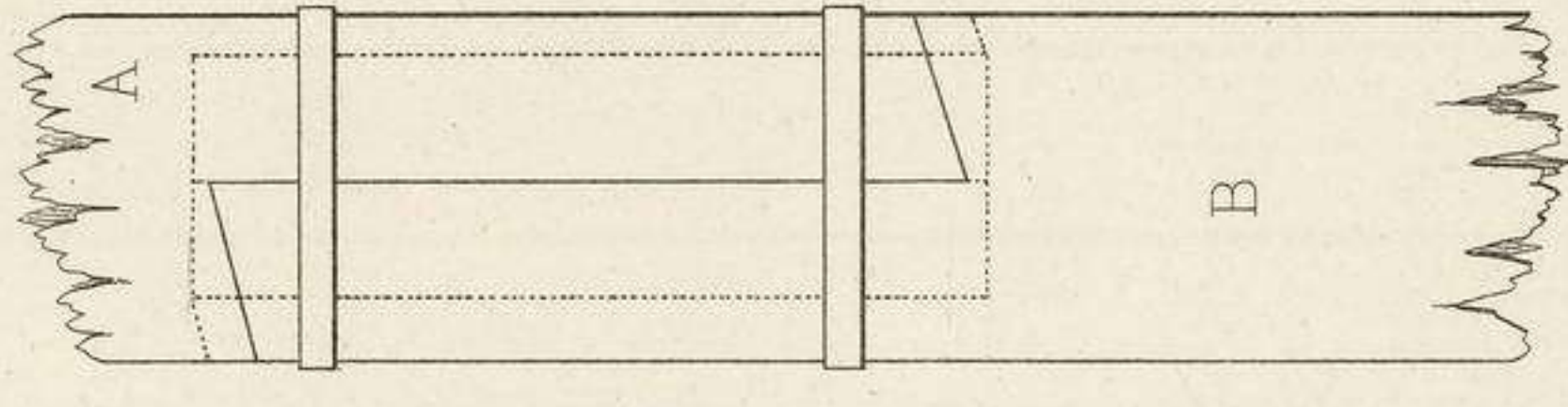

Fig. 11. (122)

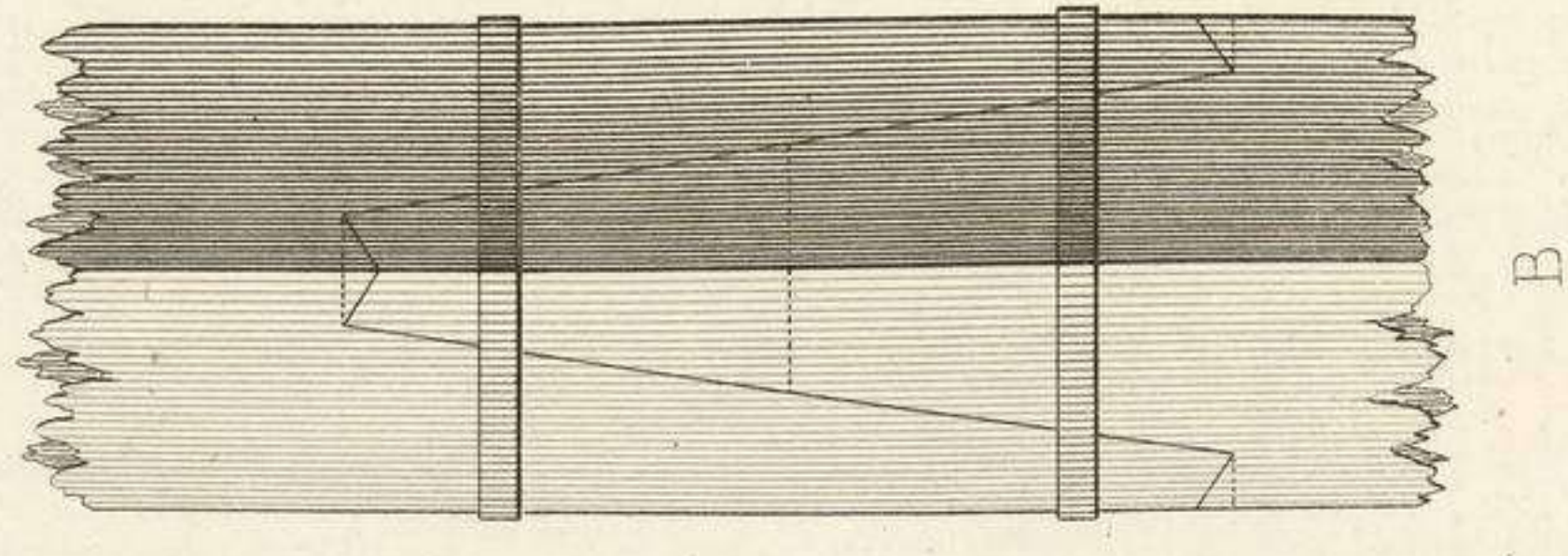

Fig. 10. (122)

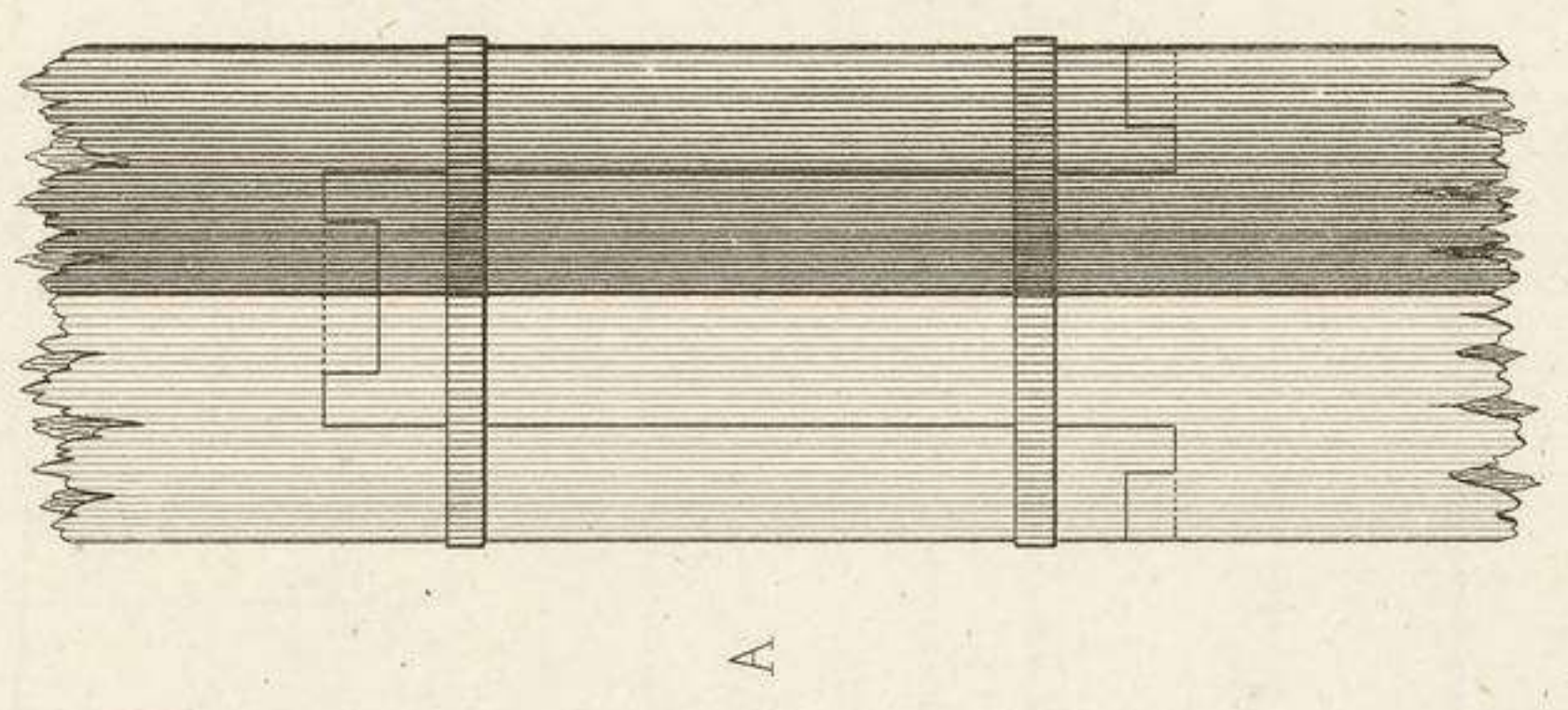
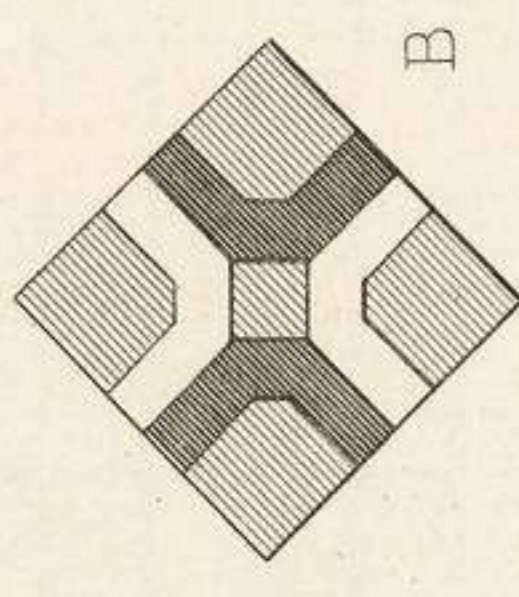
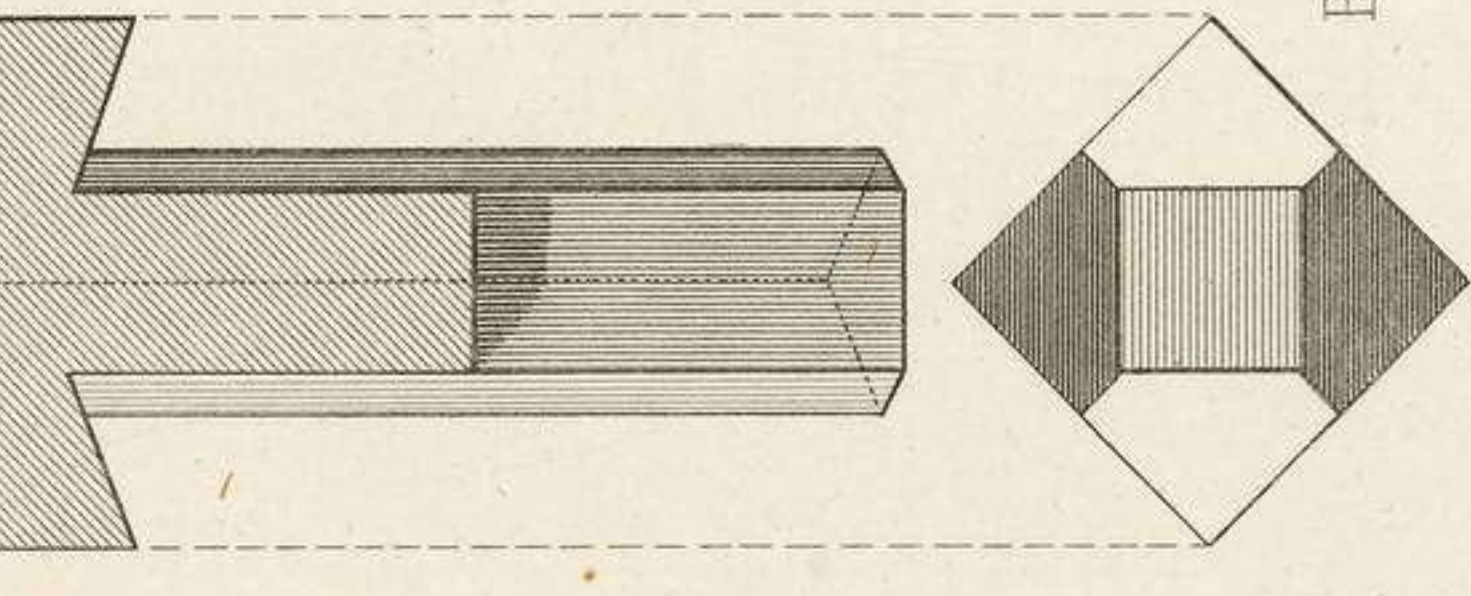

Fig. 12. (122)



B de l'anc.

H. R.



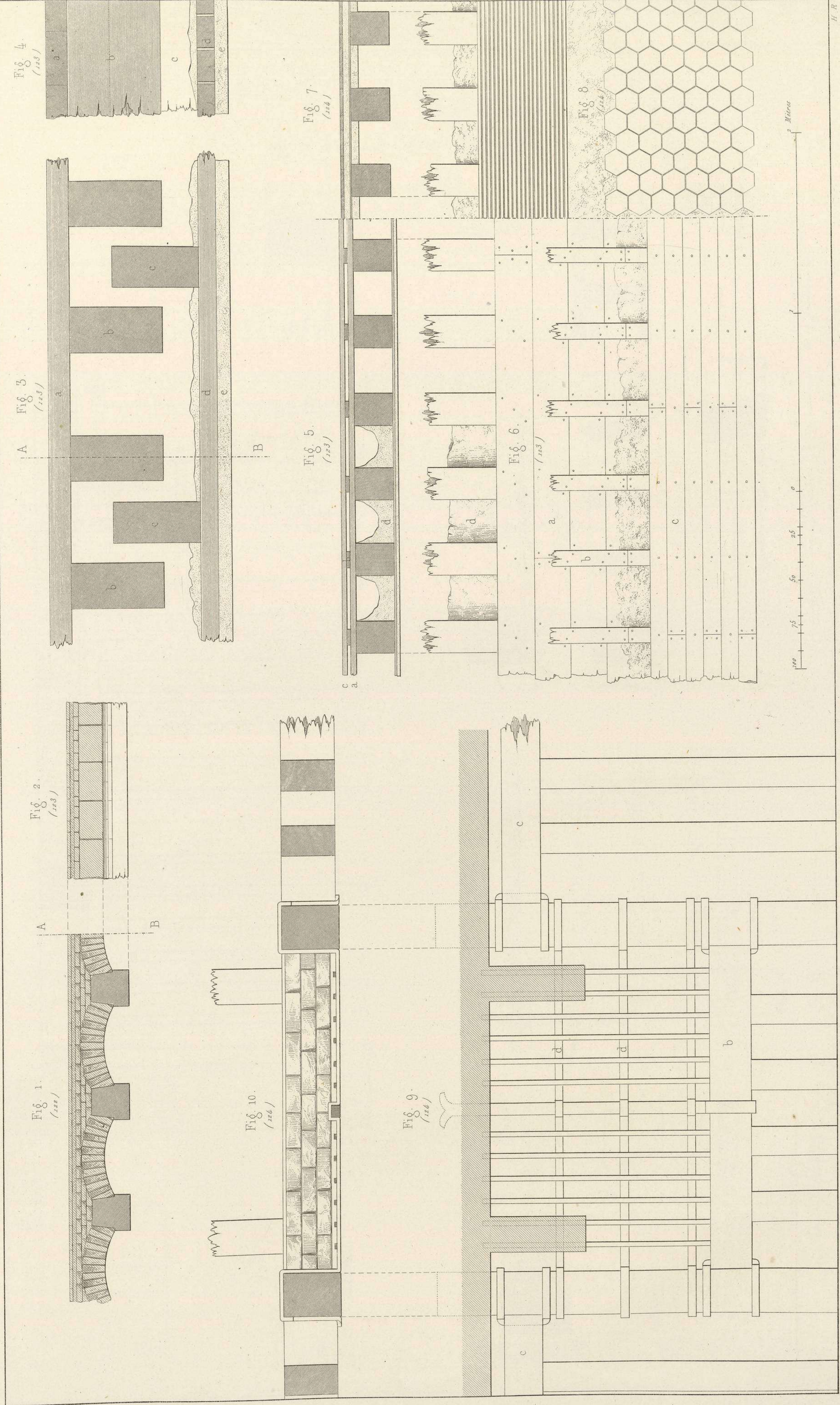

CHARPENTE,  
Planchers.

B et V del.



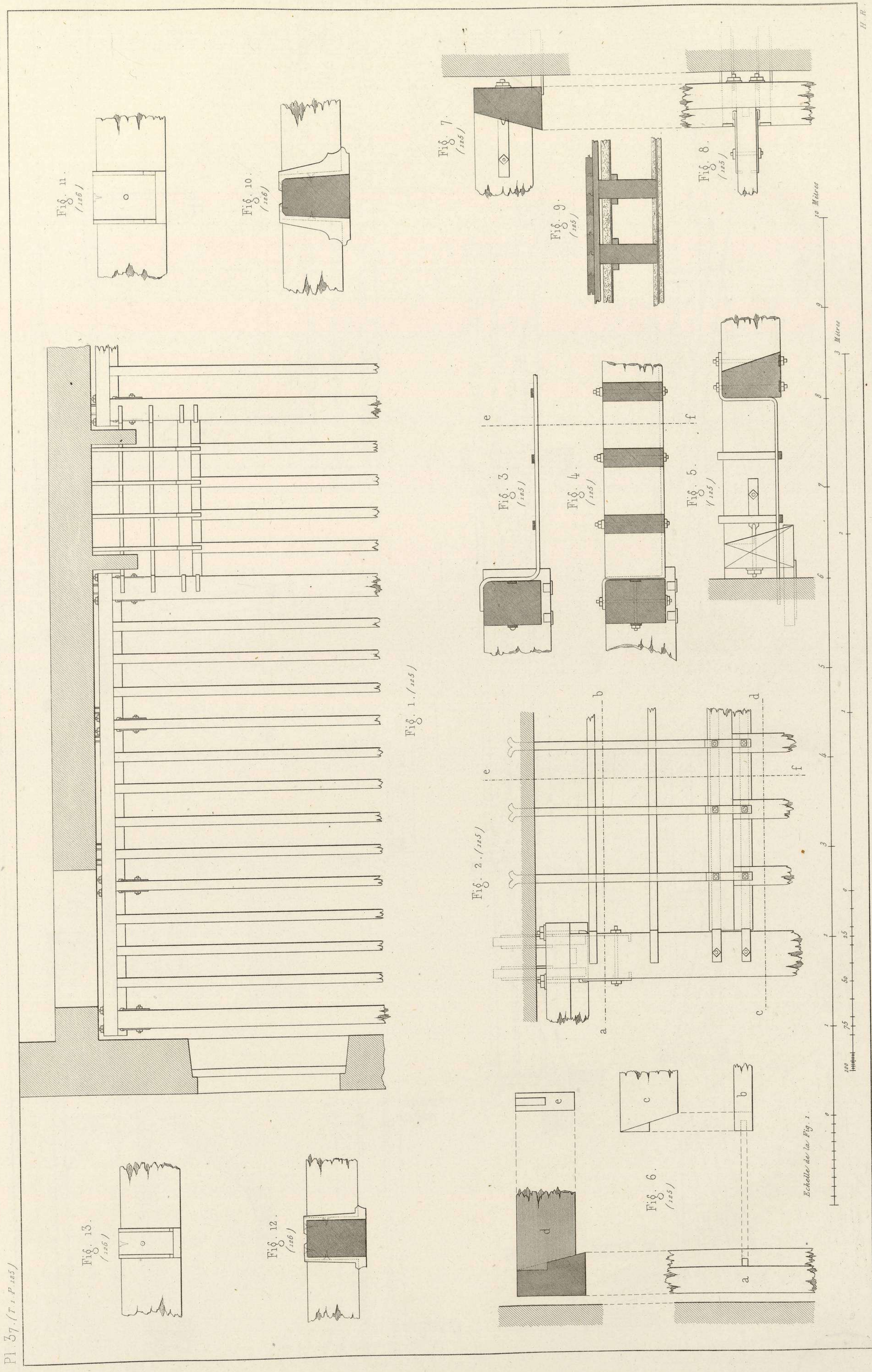

CHARPENTE.  
Plancher sans scellement.

Pl. 37. (T. 1. P. 125.)

Fig. 13.  
(126)

Fig. 12.  
(126)

Fig. 11.  
(126)

Fig. 10.  
(126)

Fig. 1. (125)

Fig. 2. (125)

Fig. 3.  
(125)

Fig. 4.  
(125)

Fig. 5.  
(125)

Fig. 7.  
(126)

Fig. 9.  
(126)

Fig. 8.  
(125)

B et V del.

H. R.



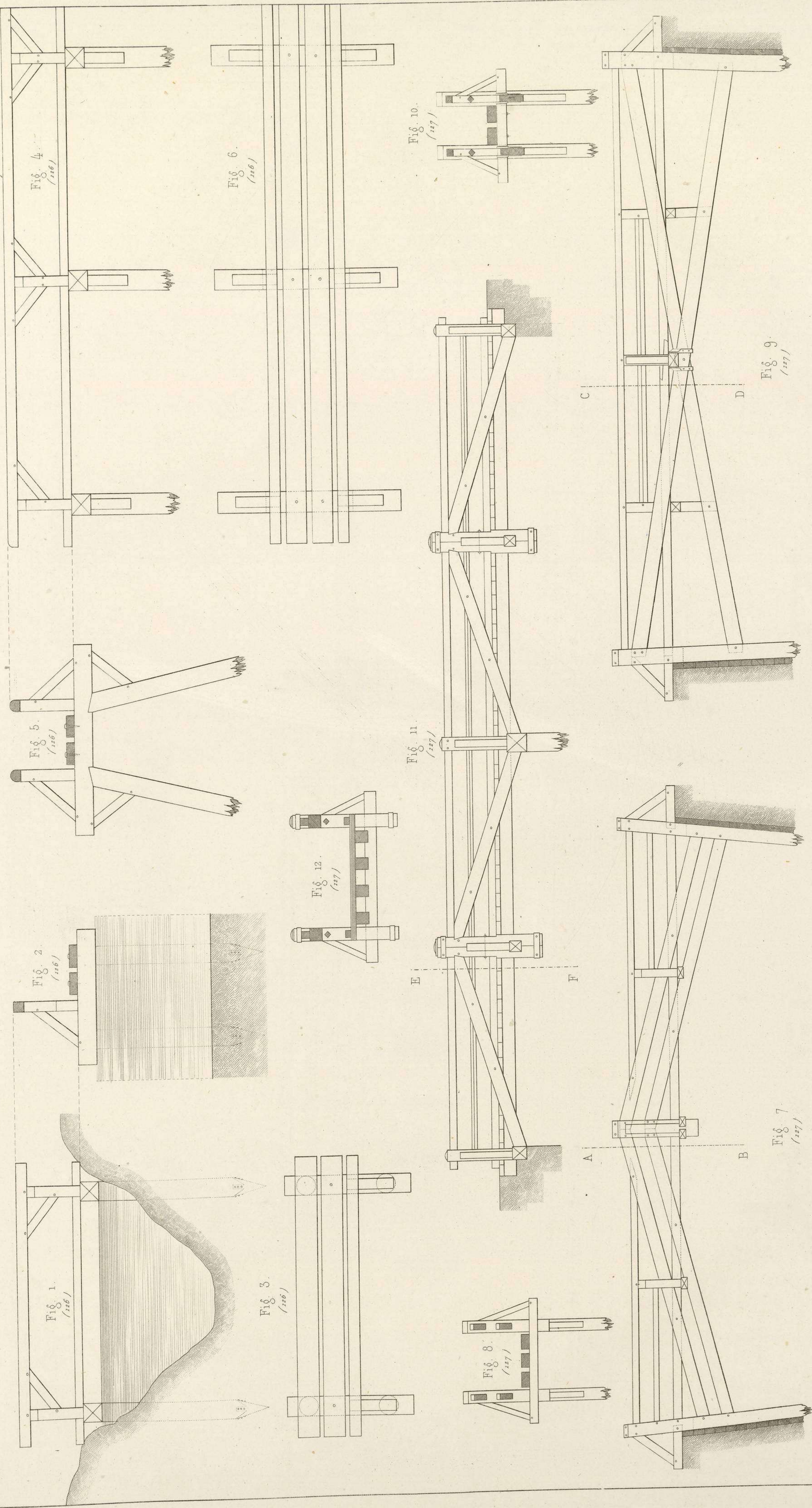

CHARPENTE,  
Passerelles.

B. et V. del.

H. R.



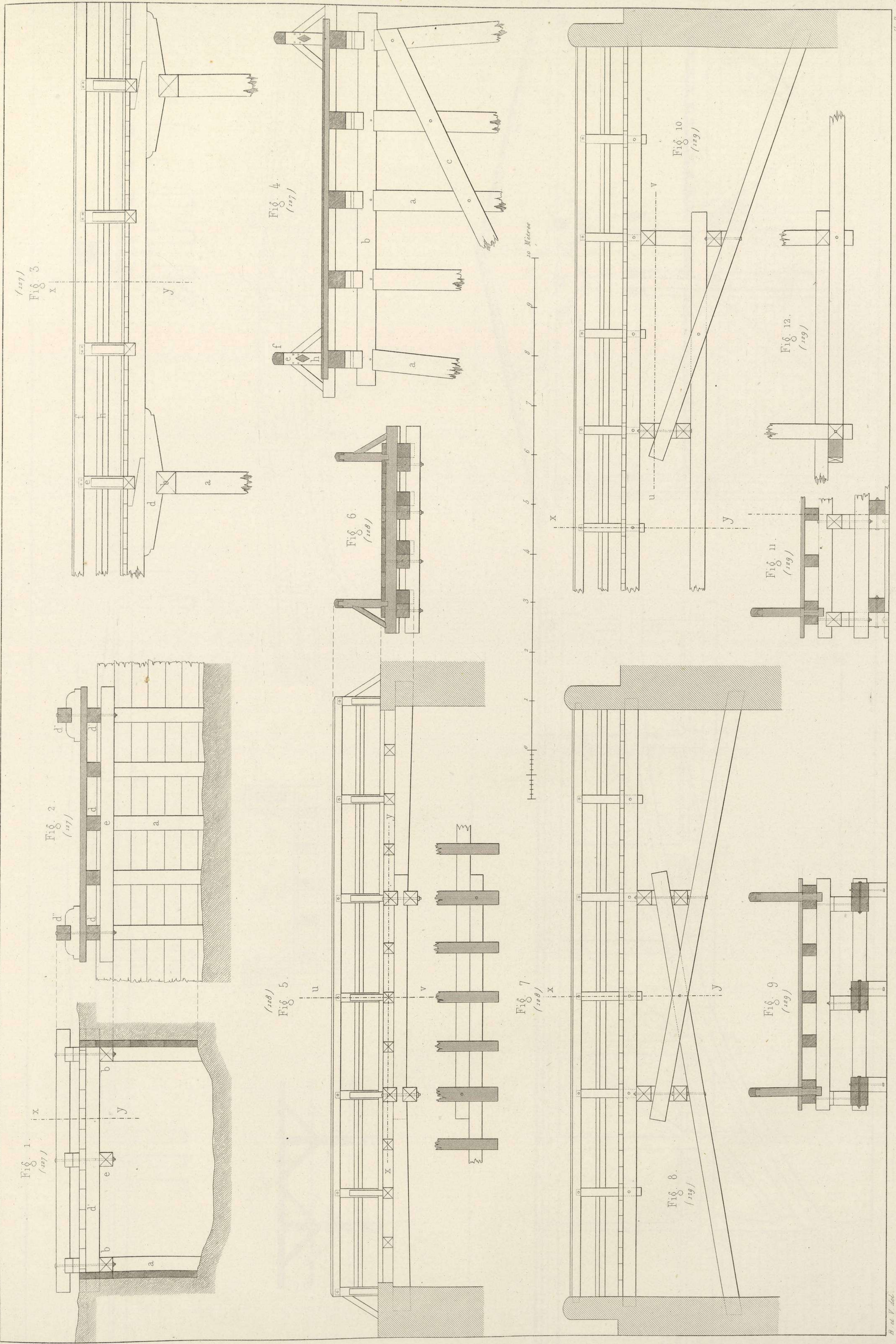



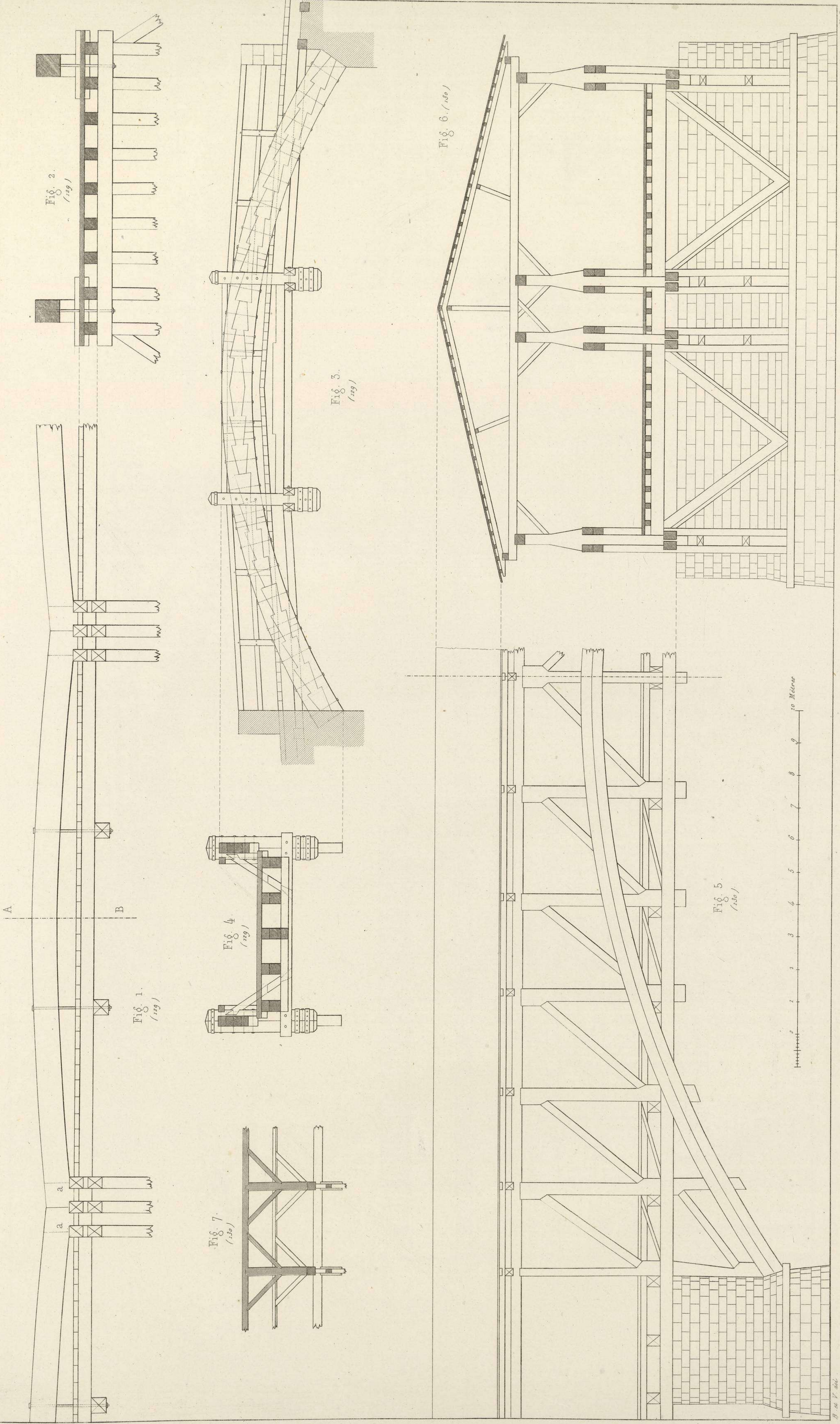

CHARPENTE, Ponts supportés par des cintres.

B. & V. del.

H. B.



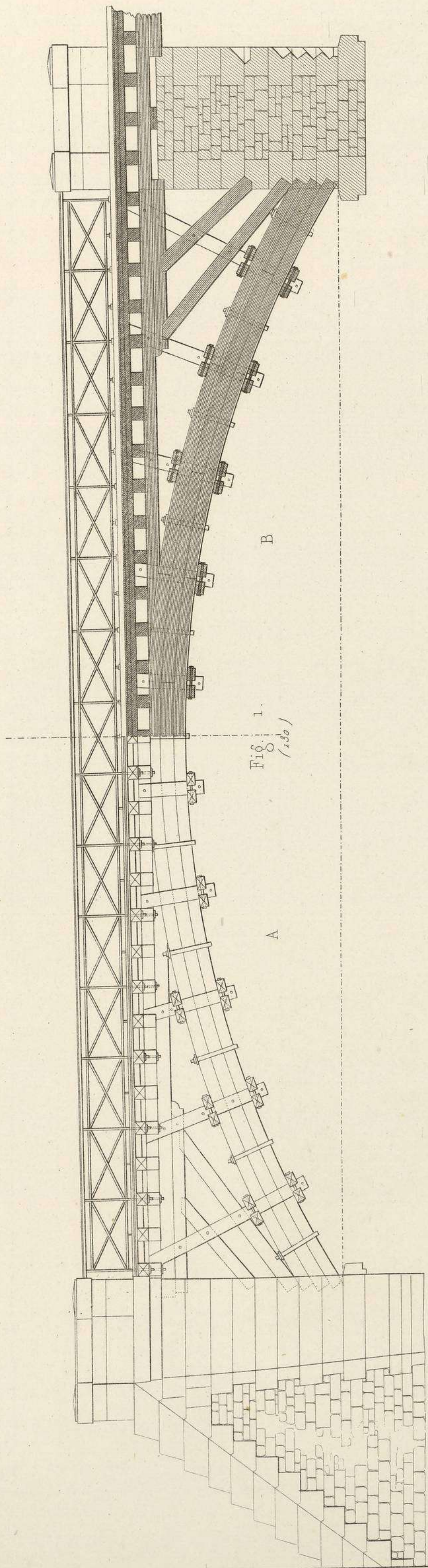

Fig. 1. (130.)

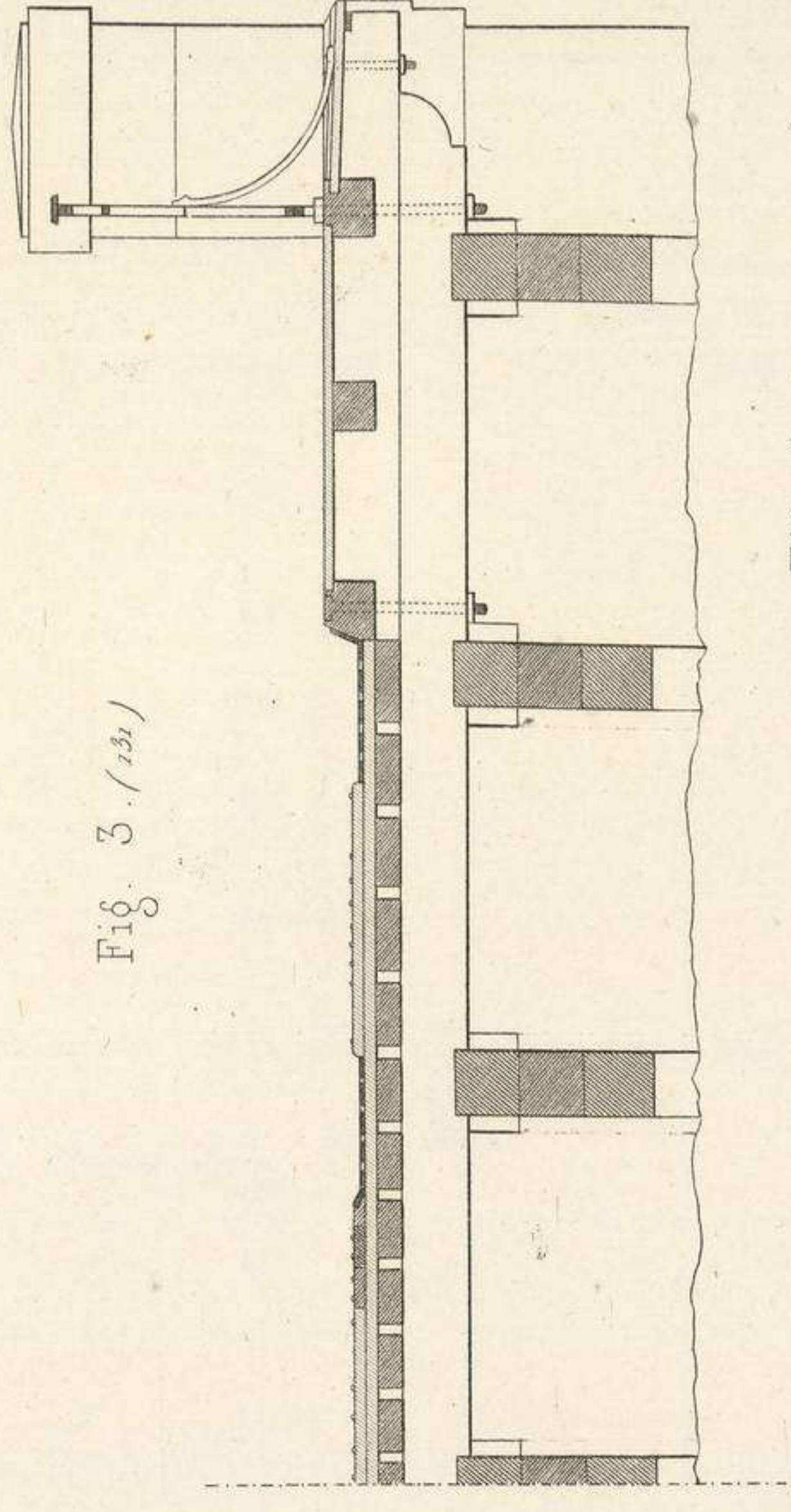

Fig. 3. (131.)

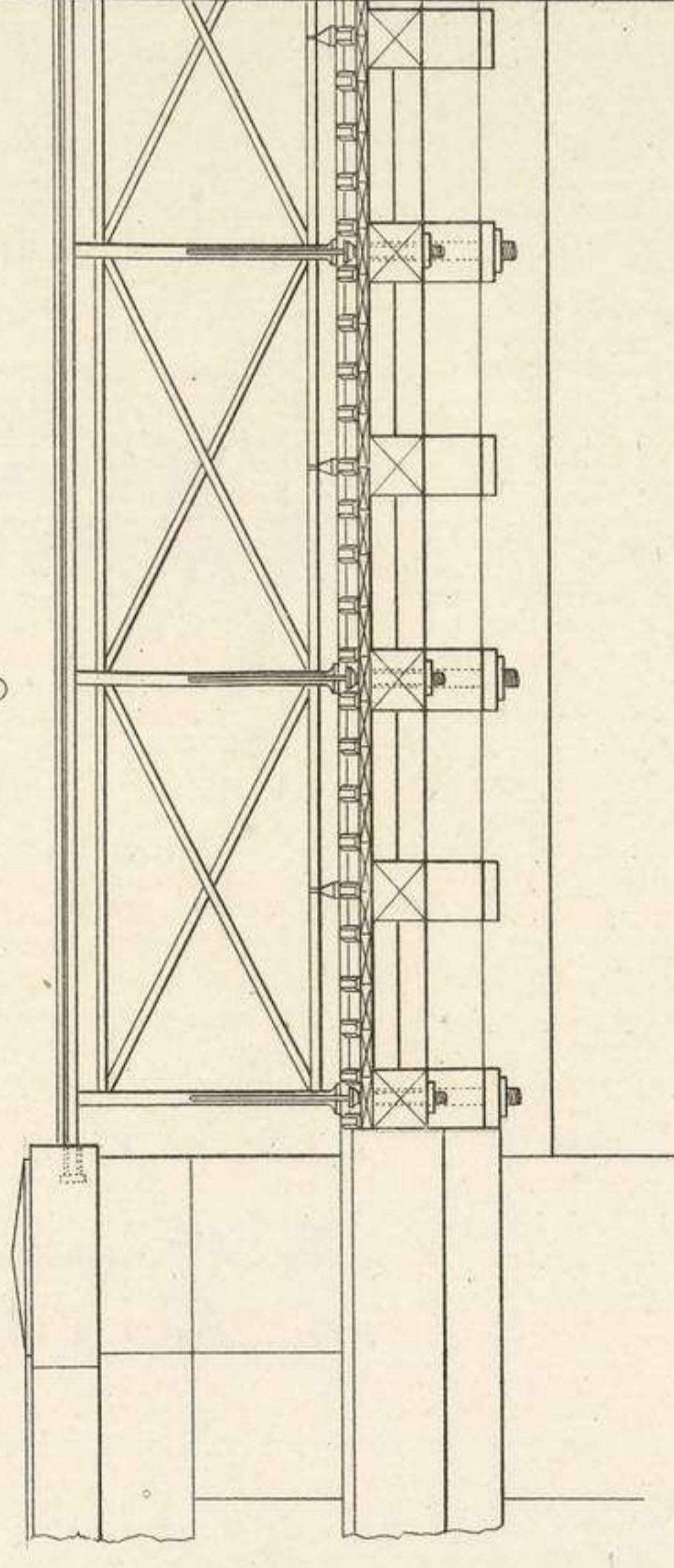

Fig. 4. (132.)

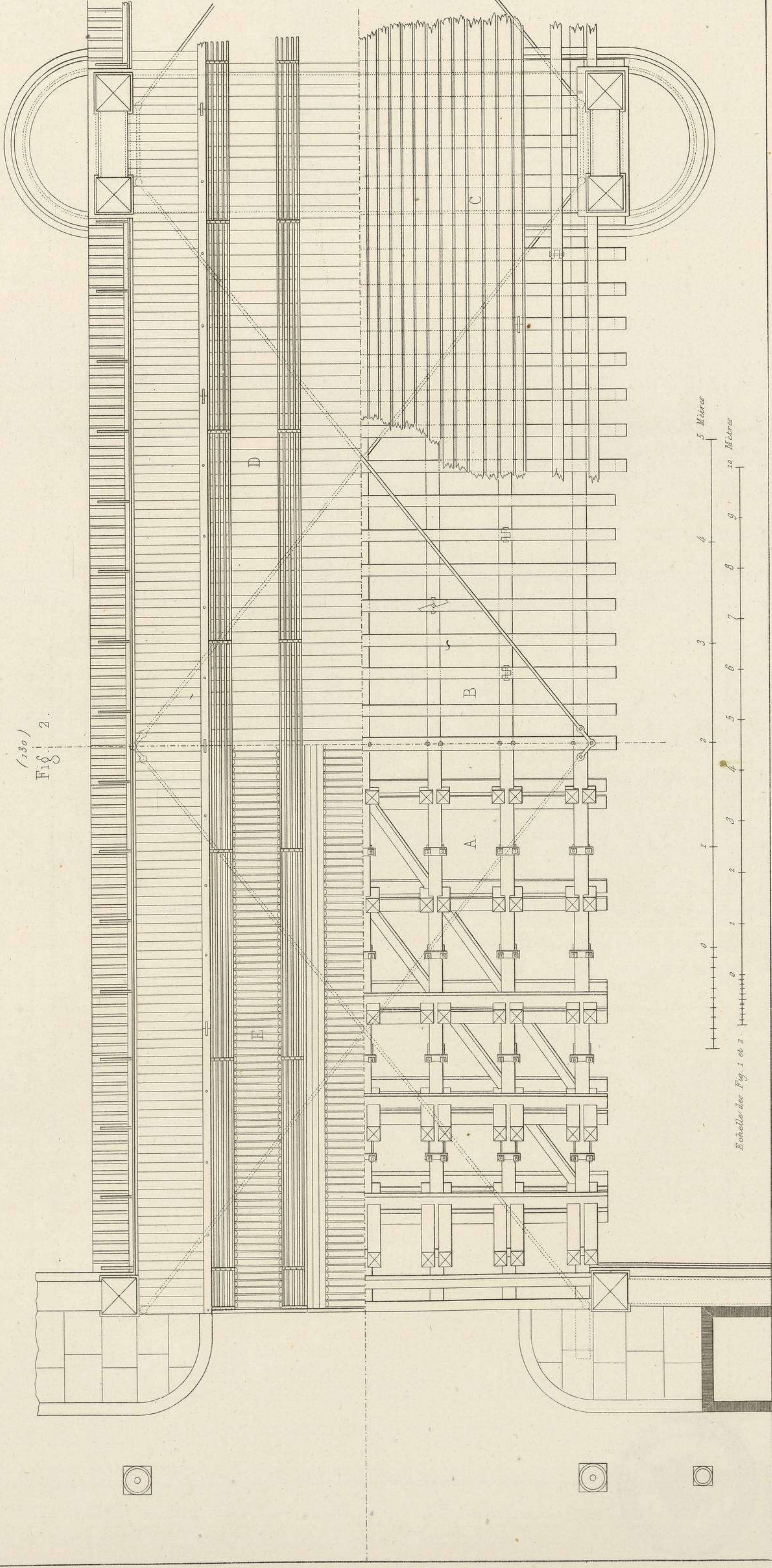

Fig. 2. (130.)

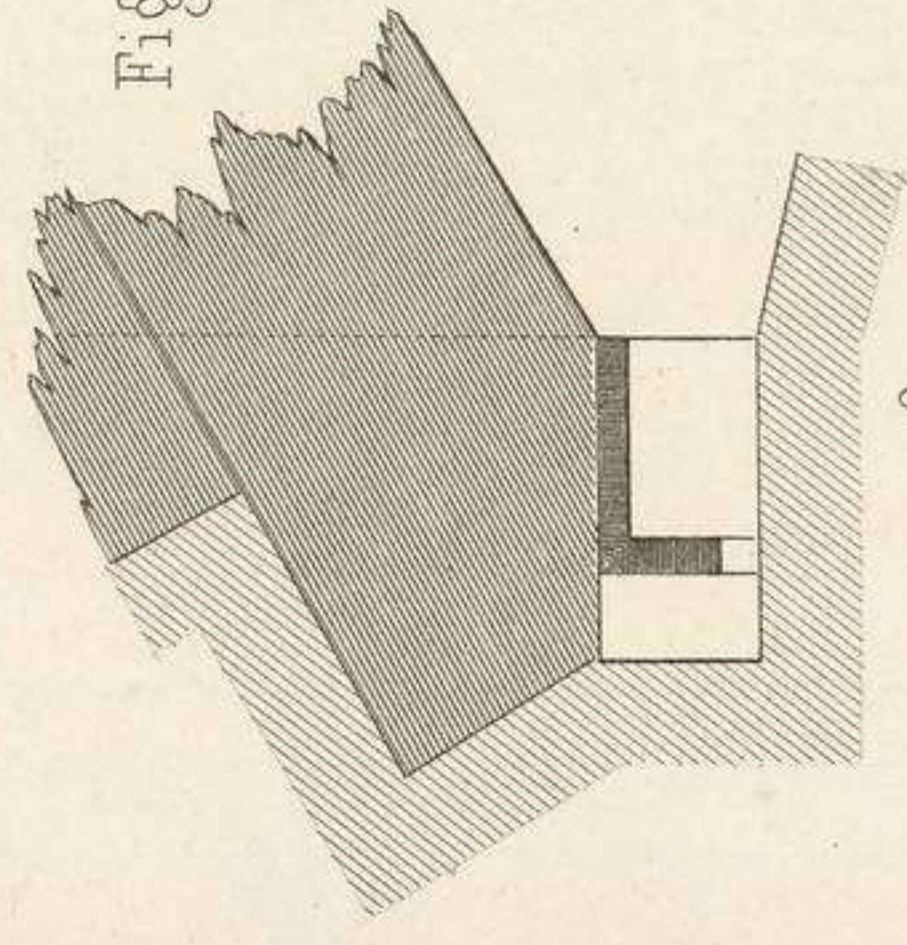

Fig. 5. (131.)

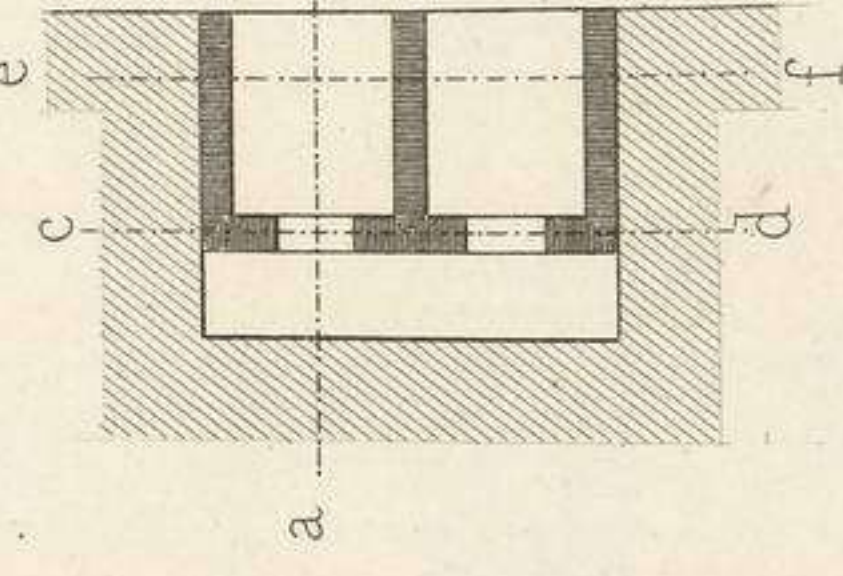

Fig. 6. (131.)



Fig. 7. (131.)



Fig. 8. (131.)

Echelle des Fig. 5, 6, 7 et 8.  
 25 50 75 1 Mètre

Echelle des Fig. 1 et 2.  
 0 1 2 3 4 5 6 7 8 9 10 Mètres  
 5 Mètres

B. et V. del.

CHARPENTE,  
 Pont sur cintres.



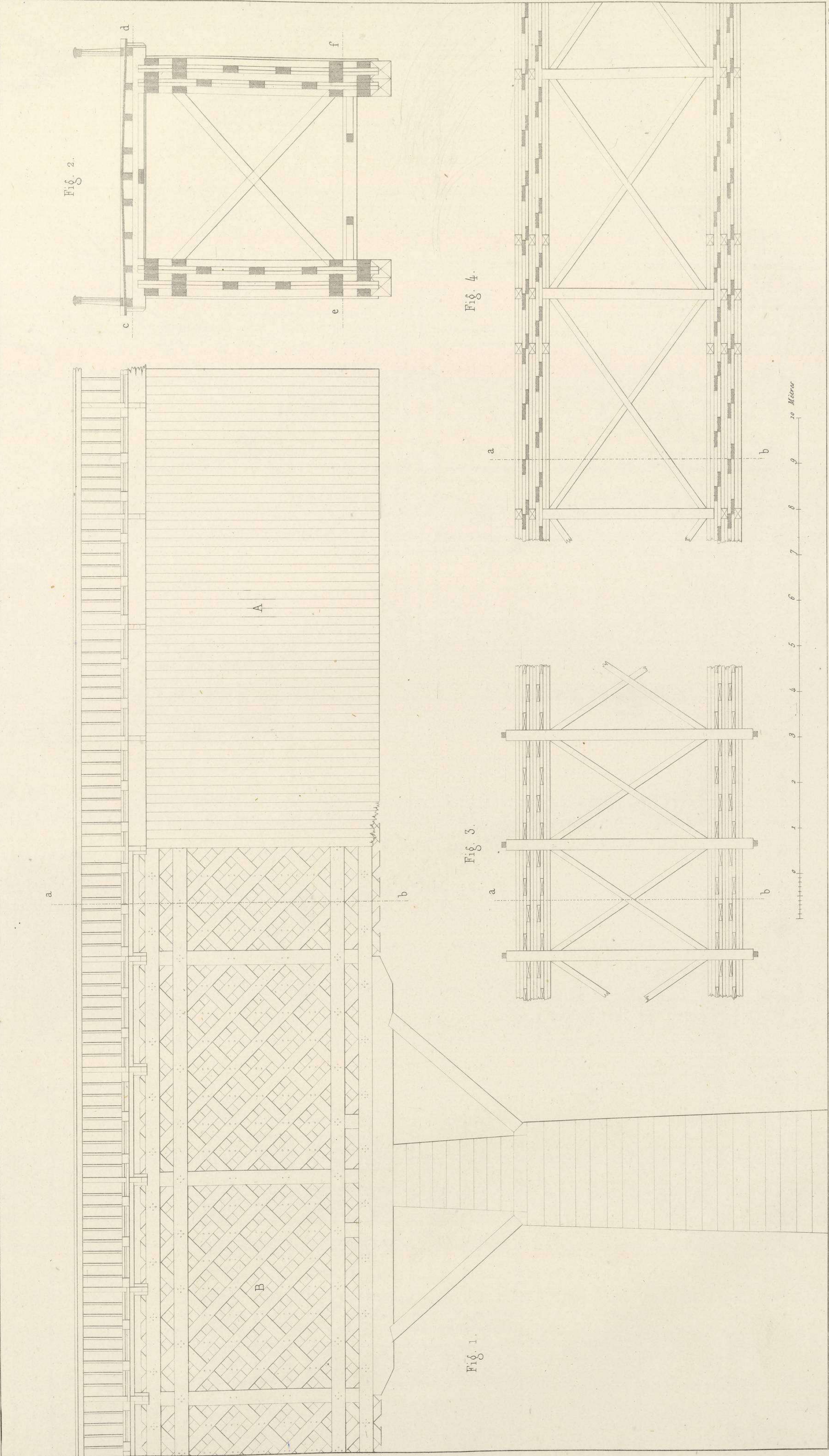

CHARPENTE,  
Pont en treillis

B. et P. del.



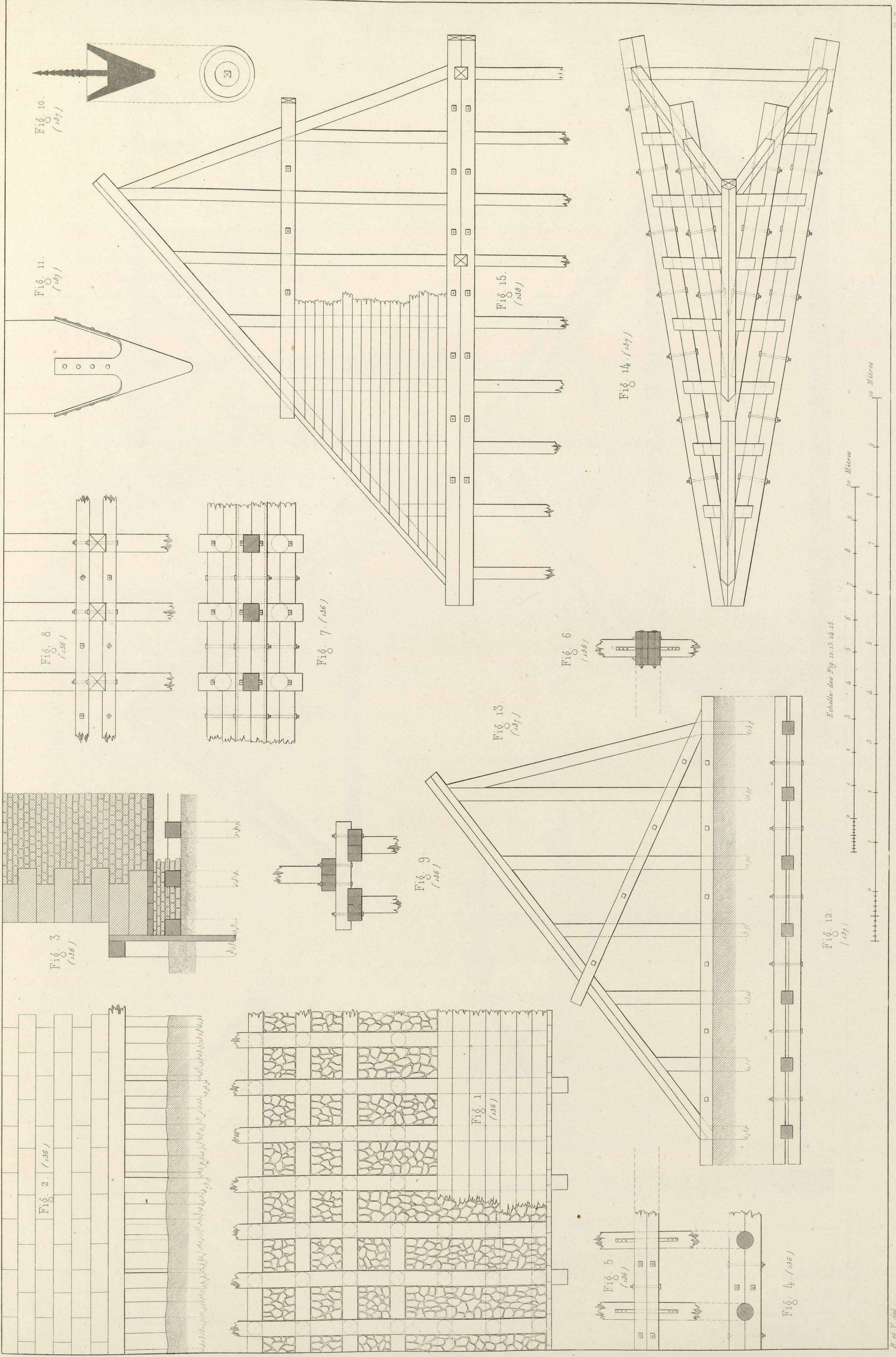

CHARPENTE,  
Pilotis et brise-glace.



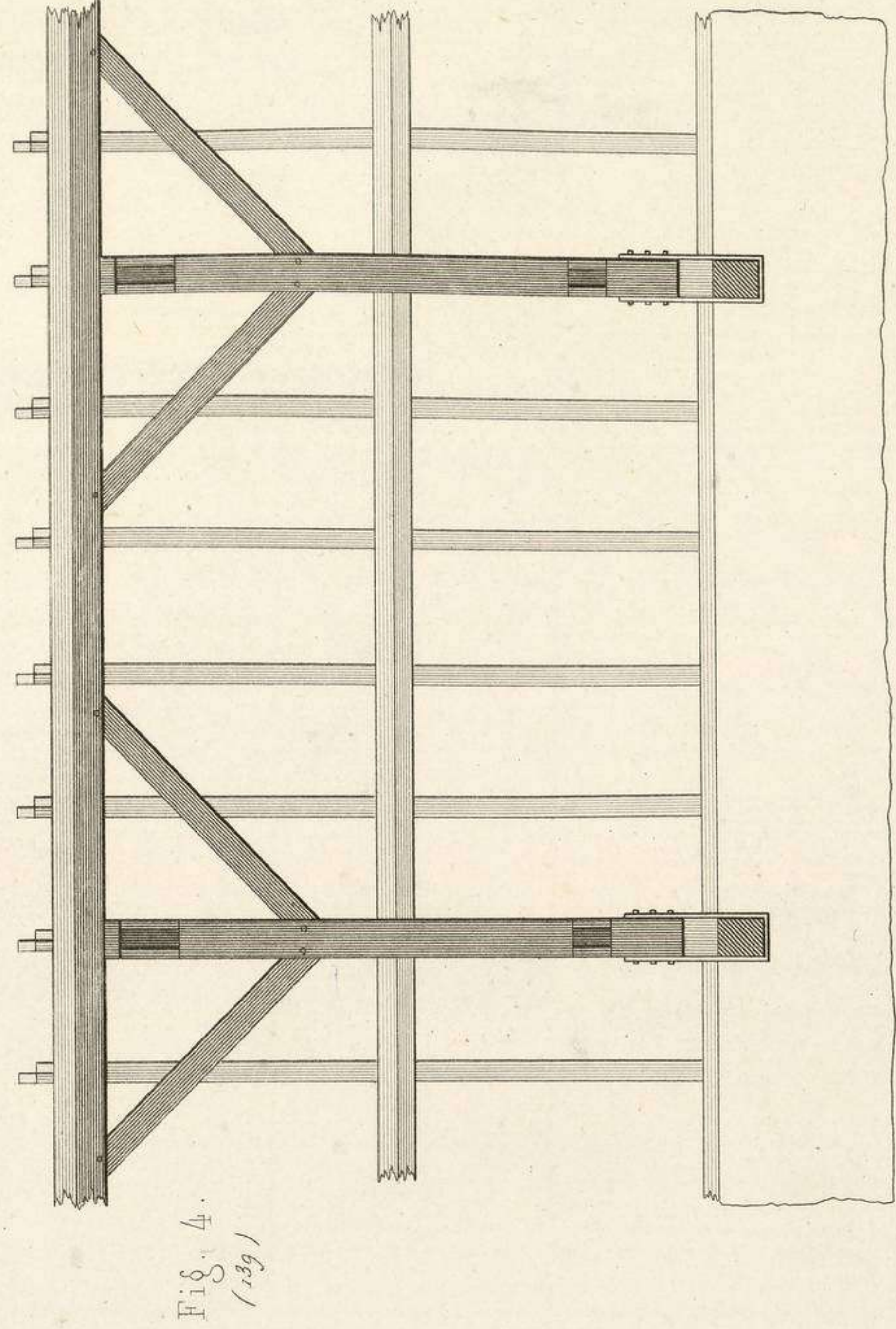
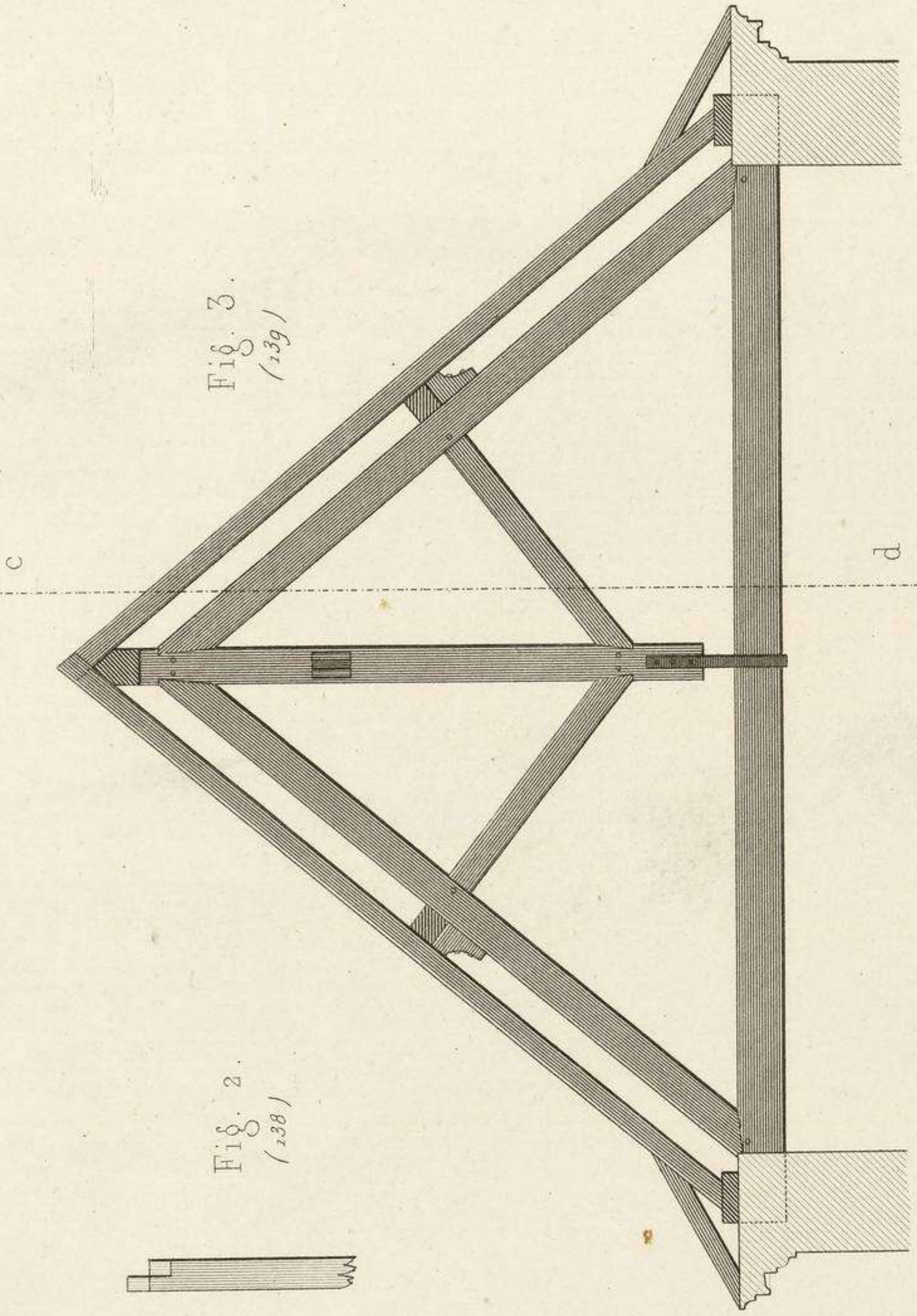
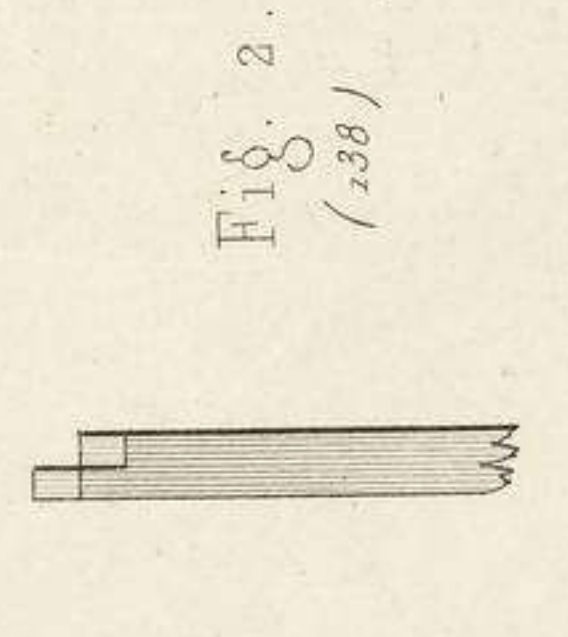
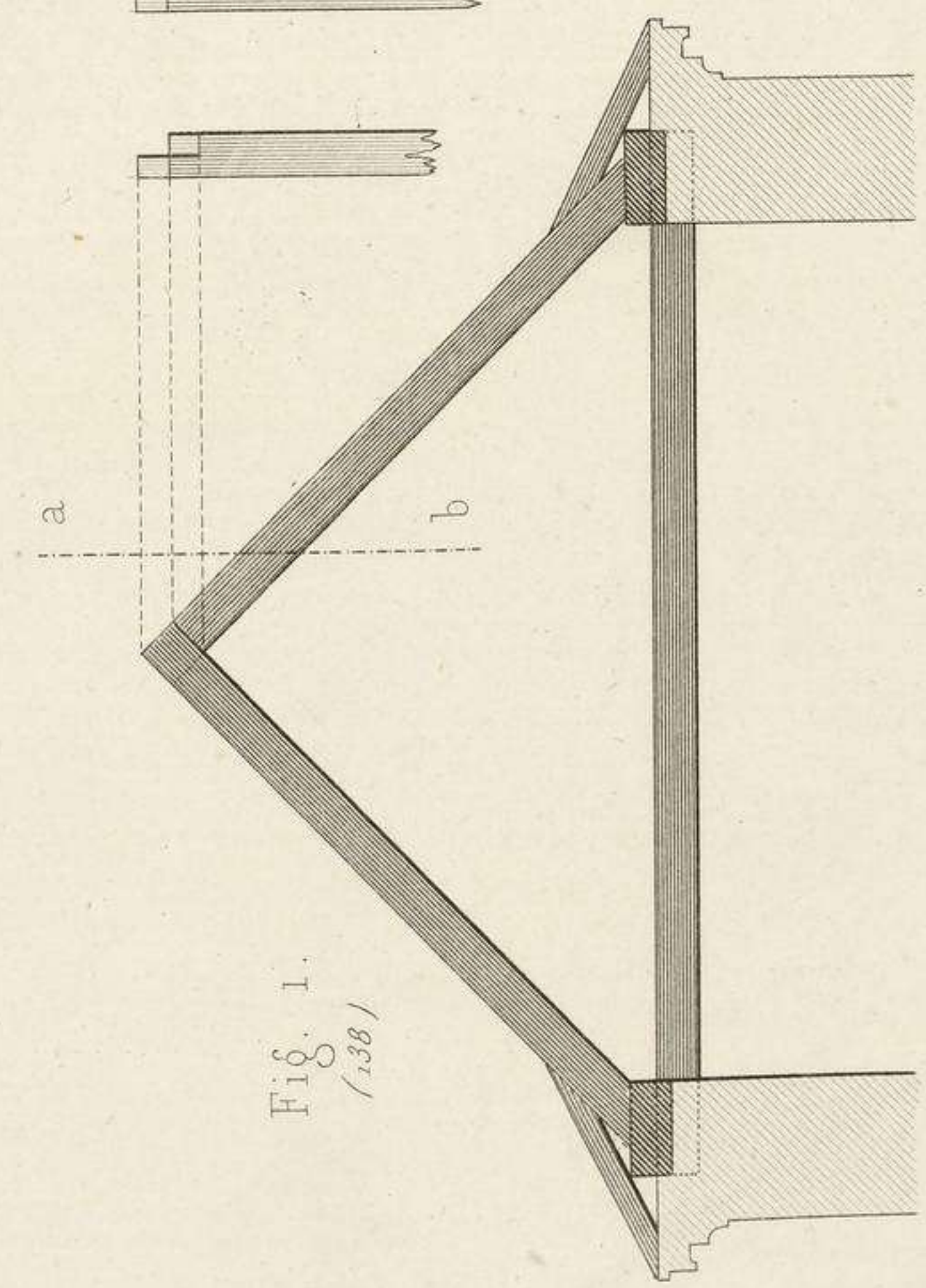

5 Mètres  
4  
3  
2  
1

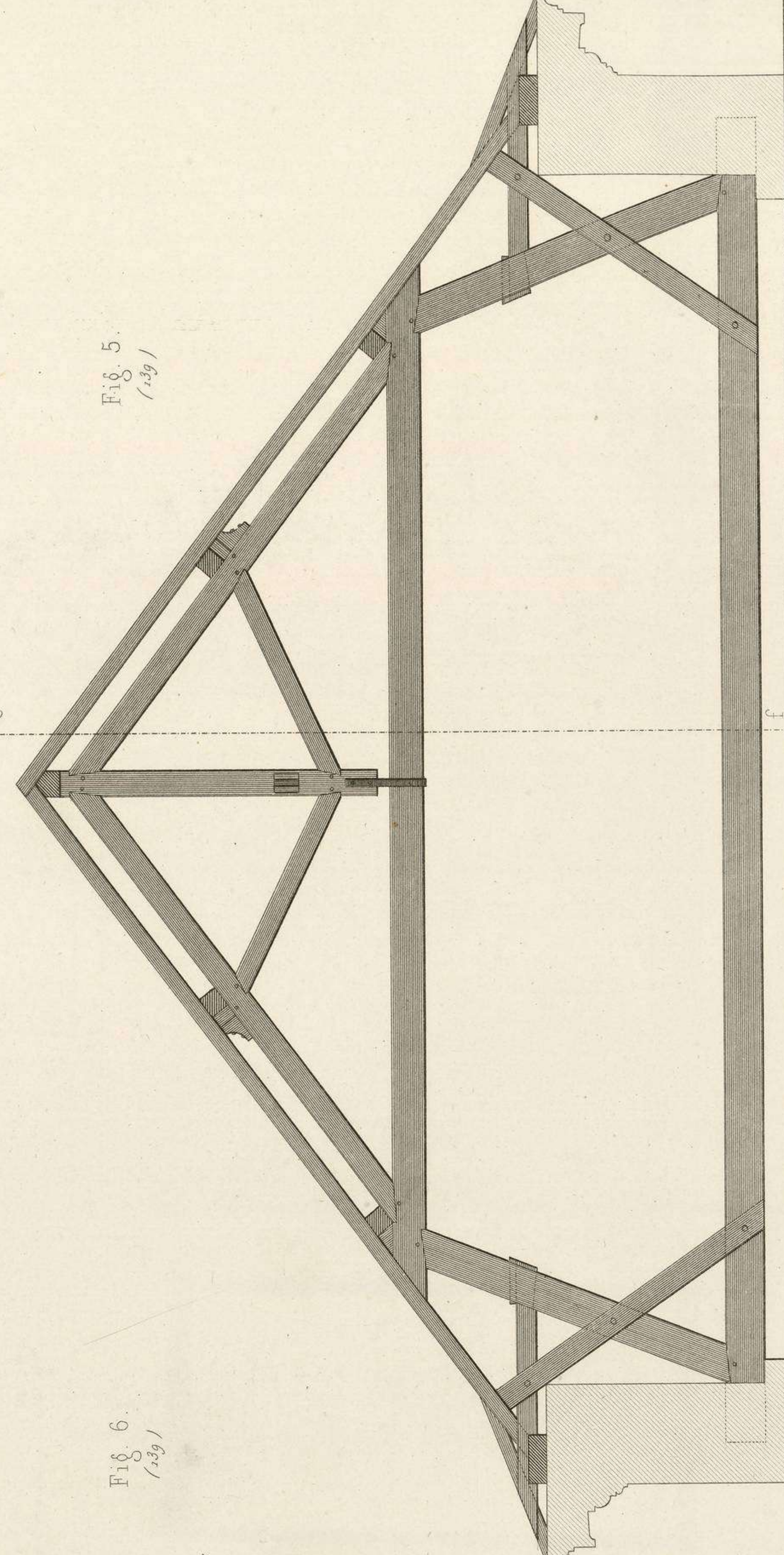
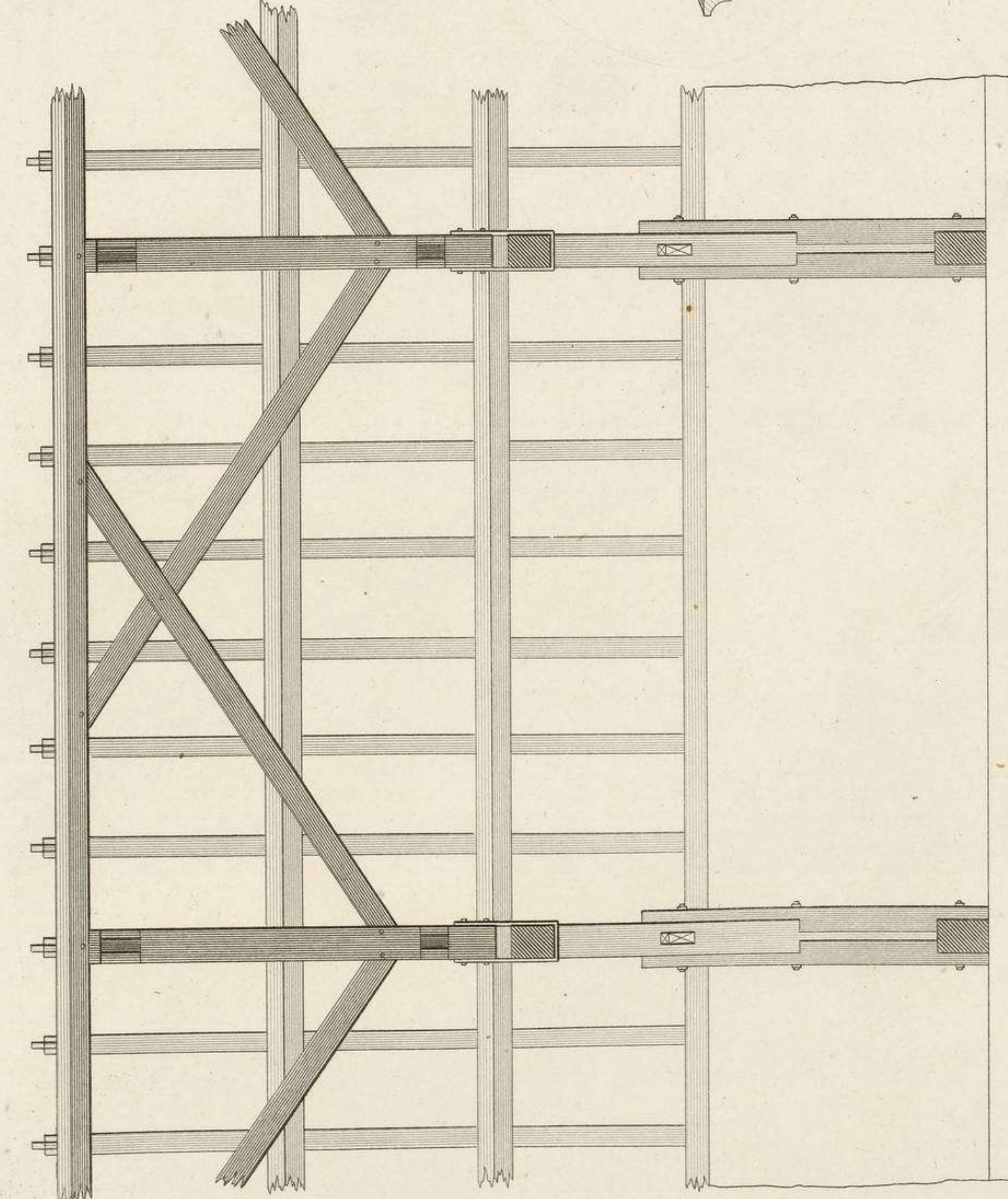

B. de V. del.

H. R.

CHARPENTE,  
Combles à surfaces planes.



Fig. 5. (142)

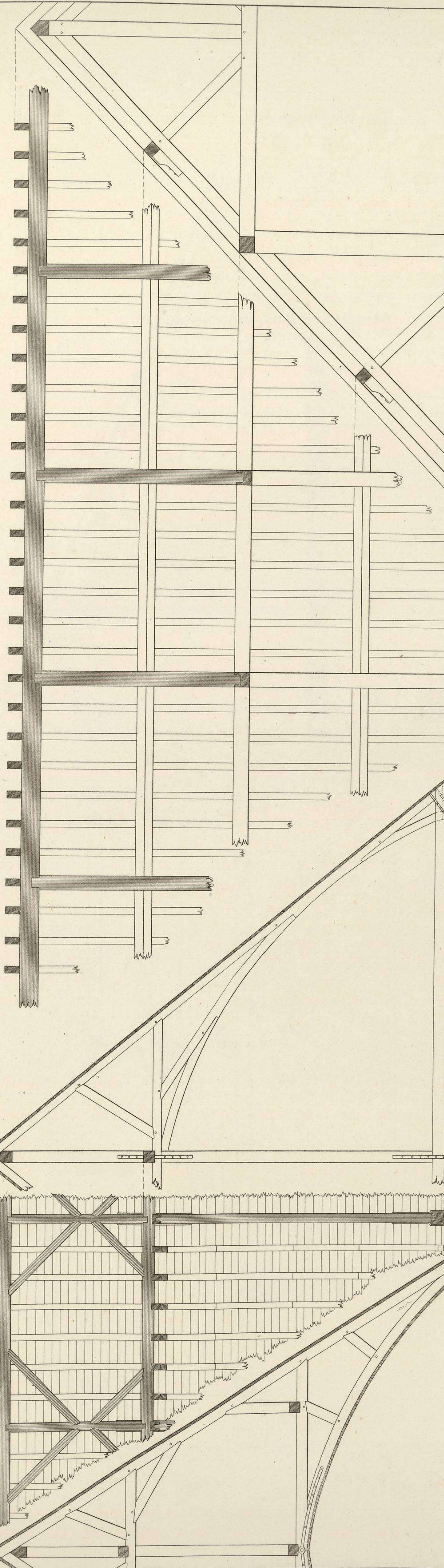

Fig. 4. (142)

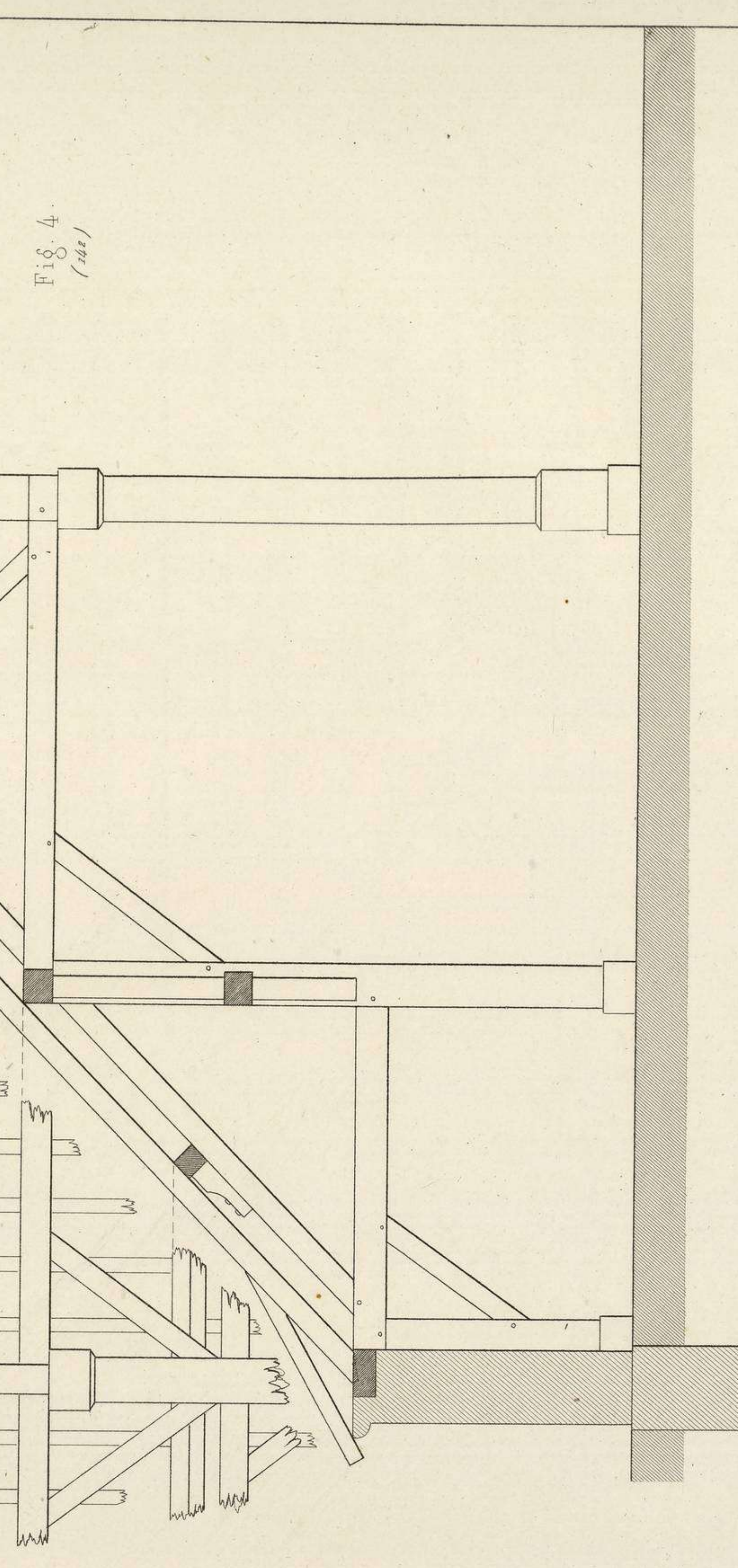

Fig. 2. (141)

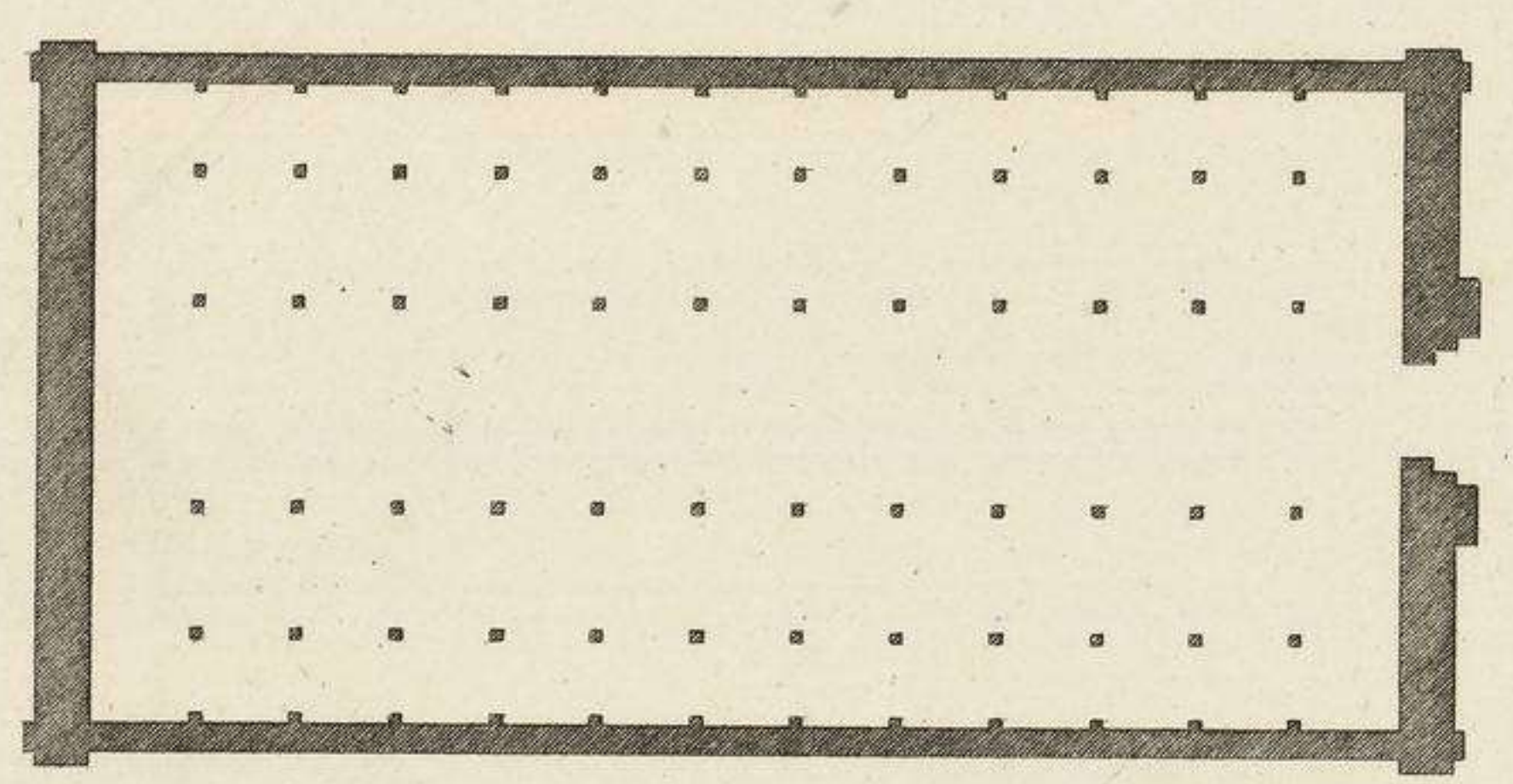

Fig. 6. (141)

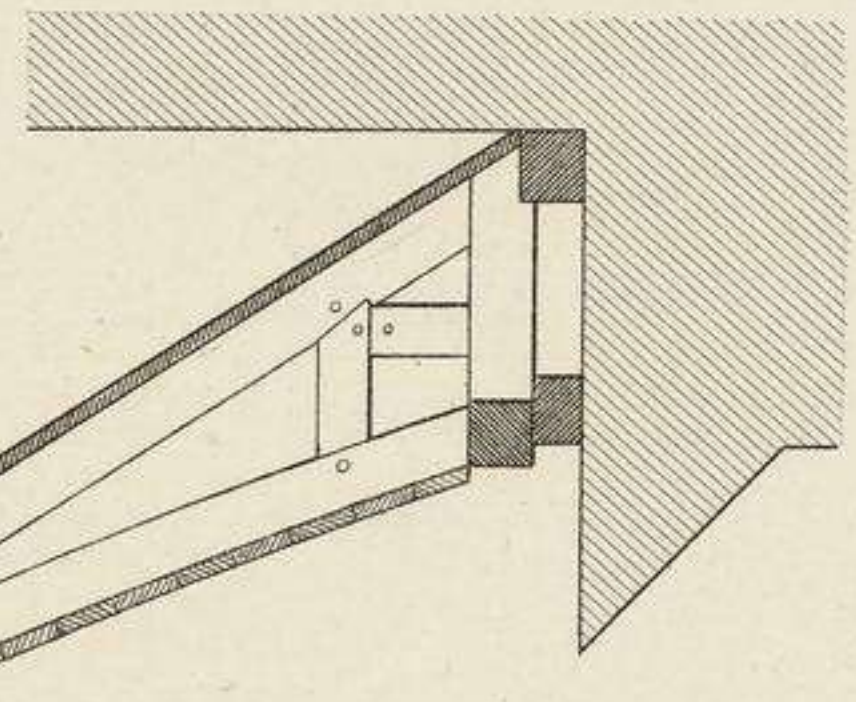

Fig. 3. (141)

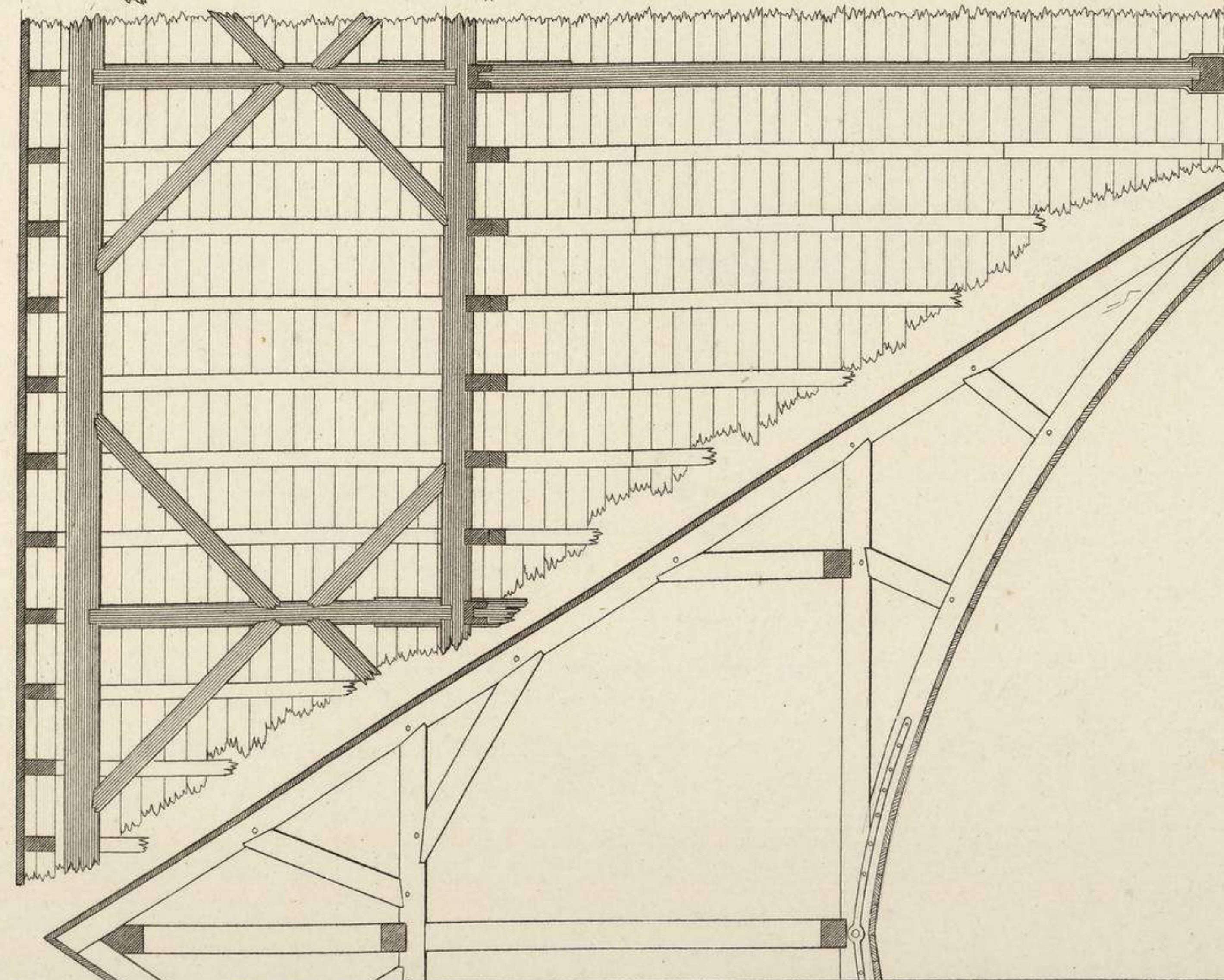
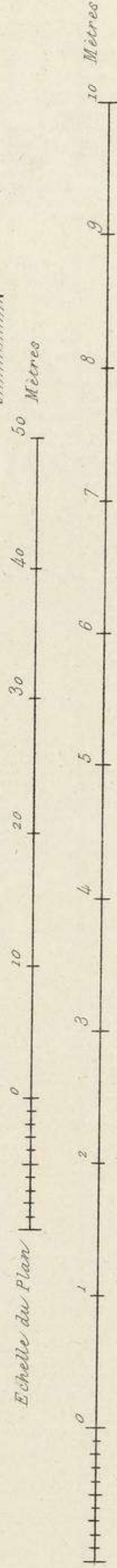
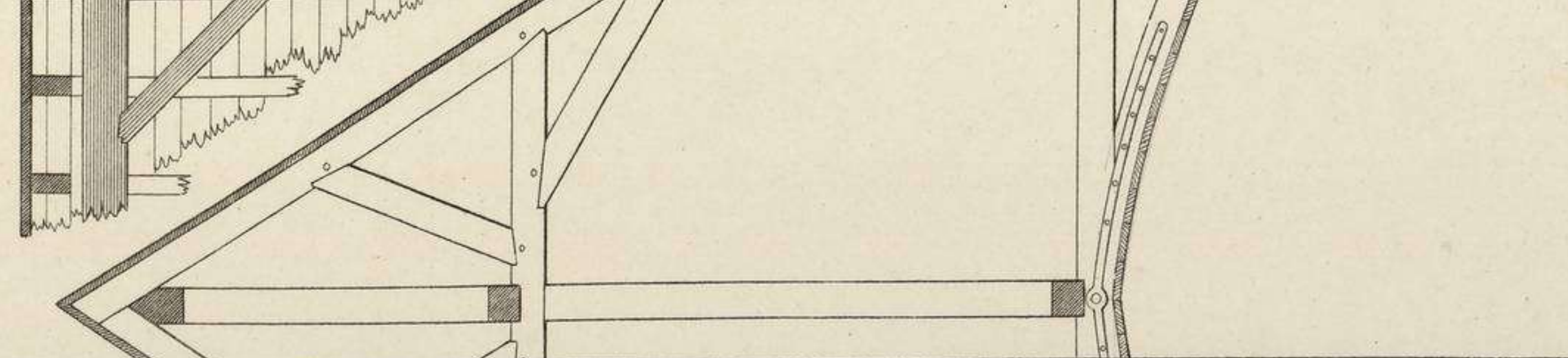

Fig. 1. (141)



CHARPENTE,  
Combles du moyen-âge.

B. de V. del.

H. R.



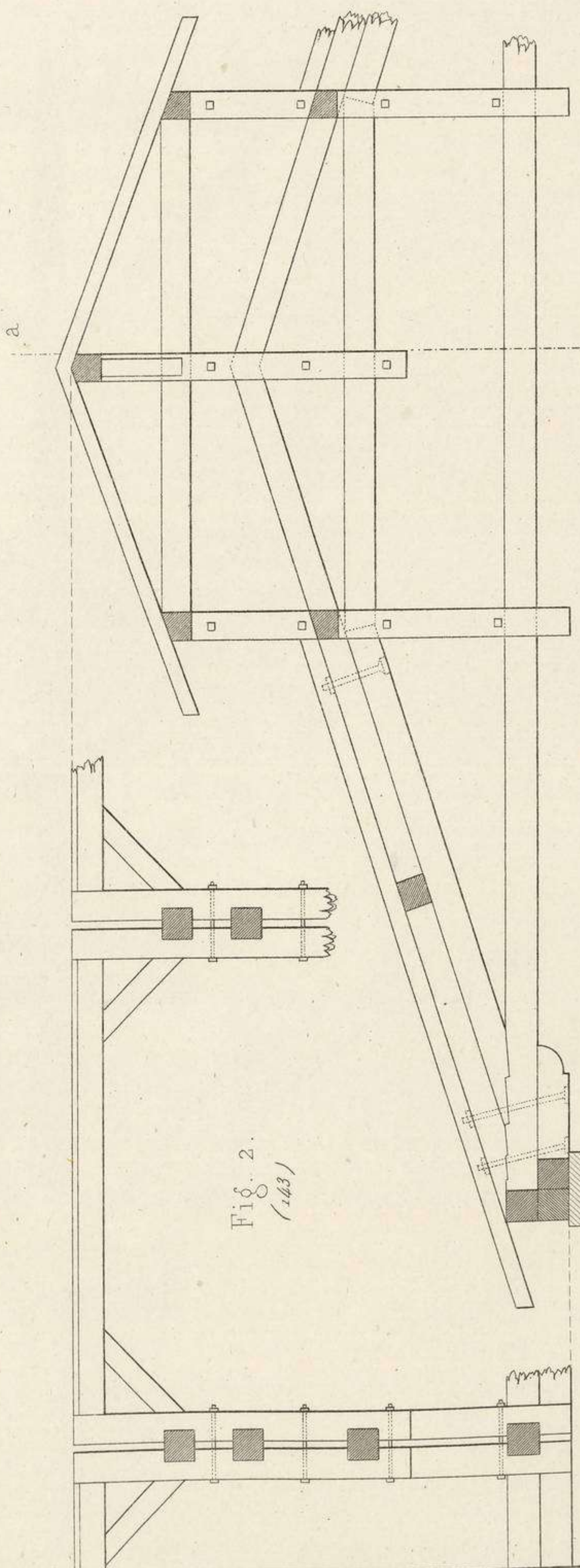

Fig. 4. (143)

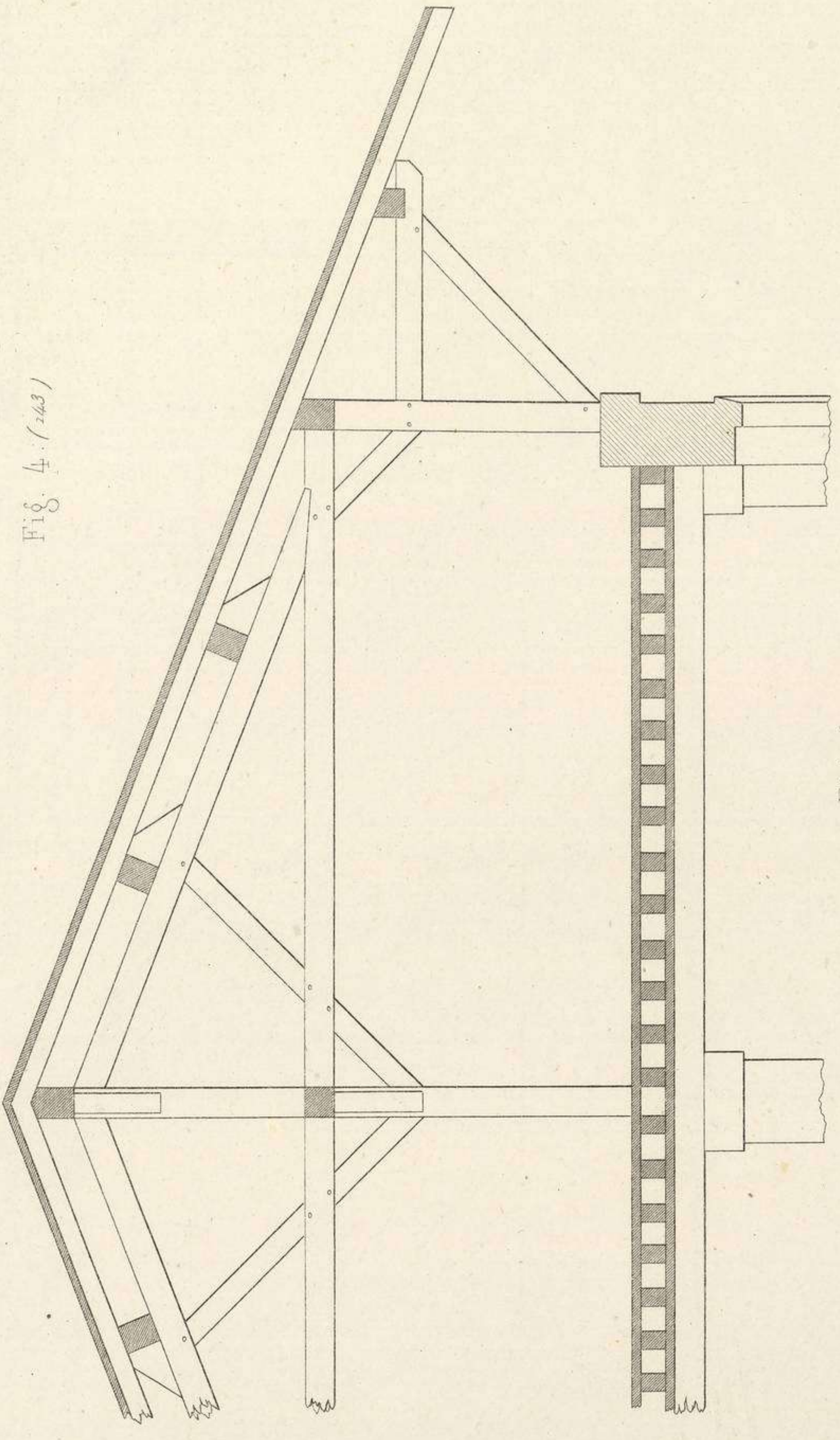

Fig. 1. (143)

a b

Fig. 3. (143)

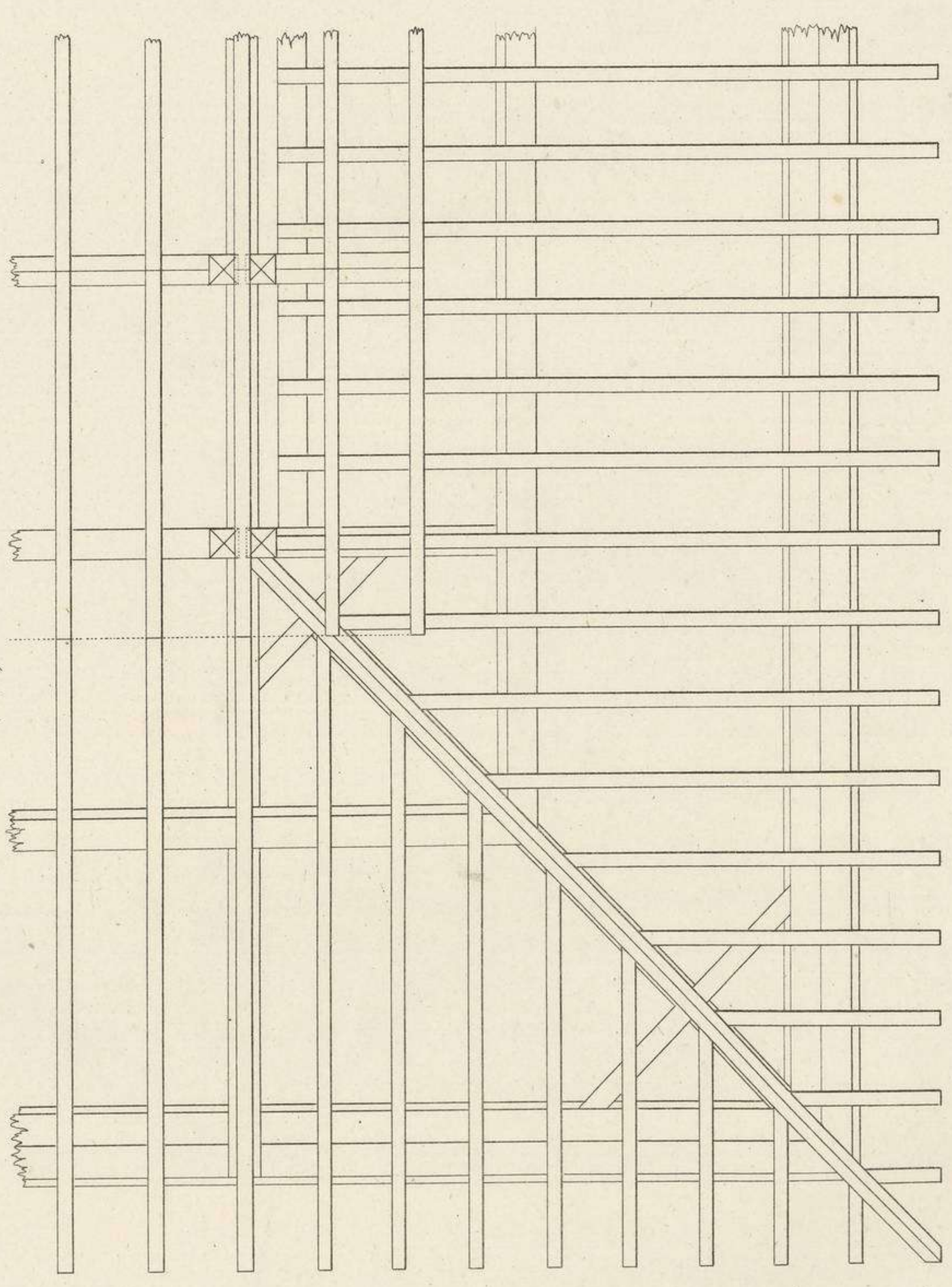
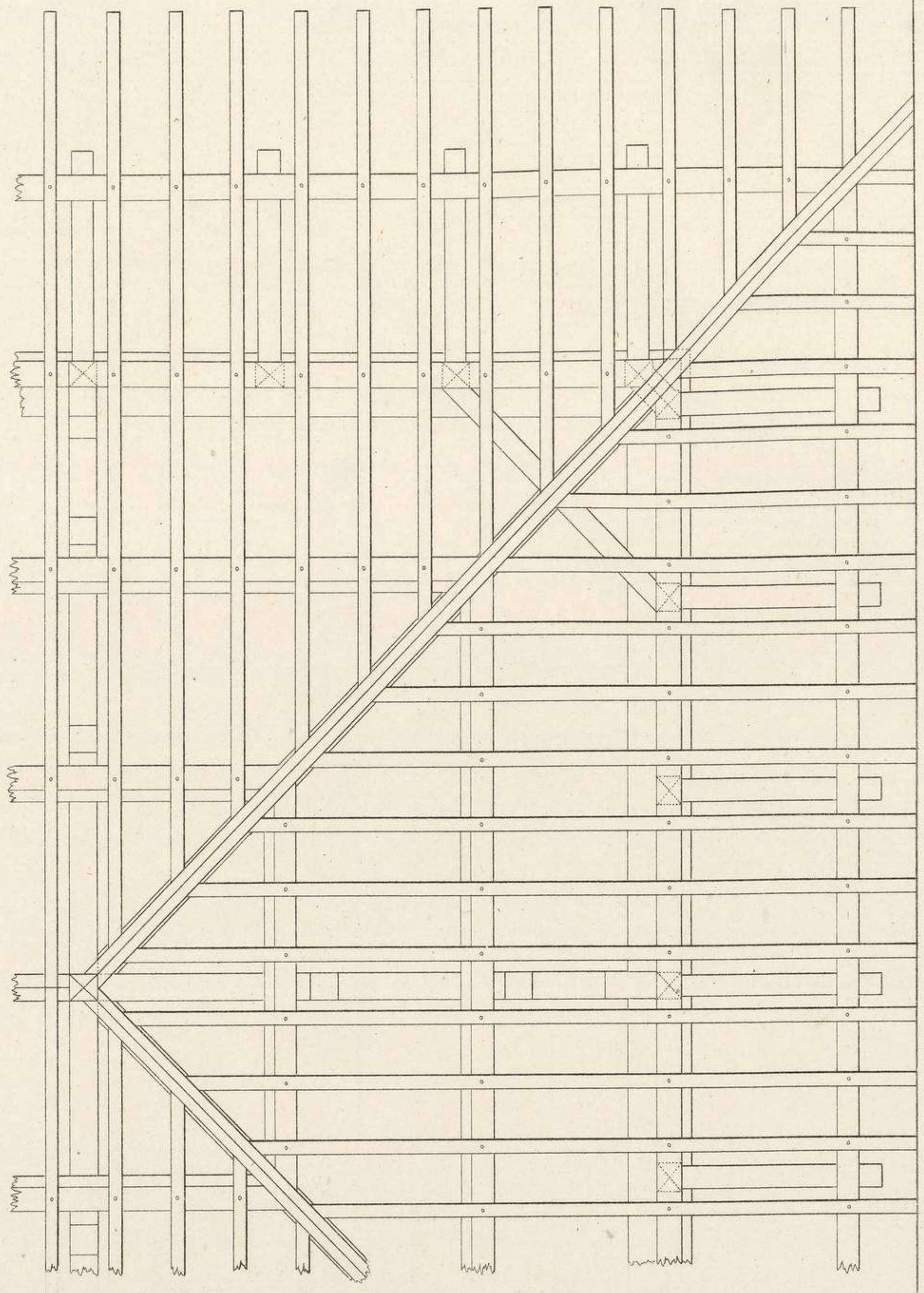

Fig. 5. (143)



H. V. del.

H. R.



Pl. 47. (T. I. P. 143)

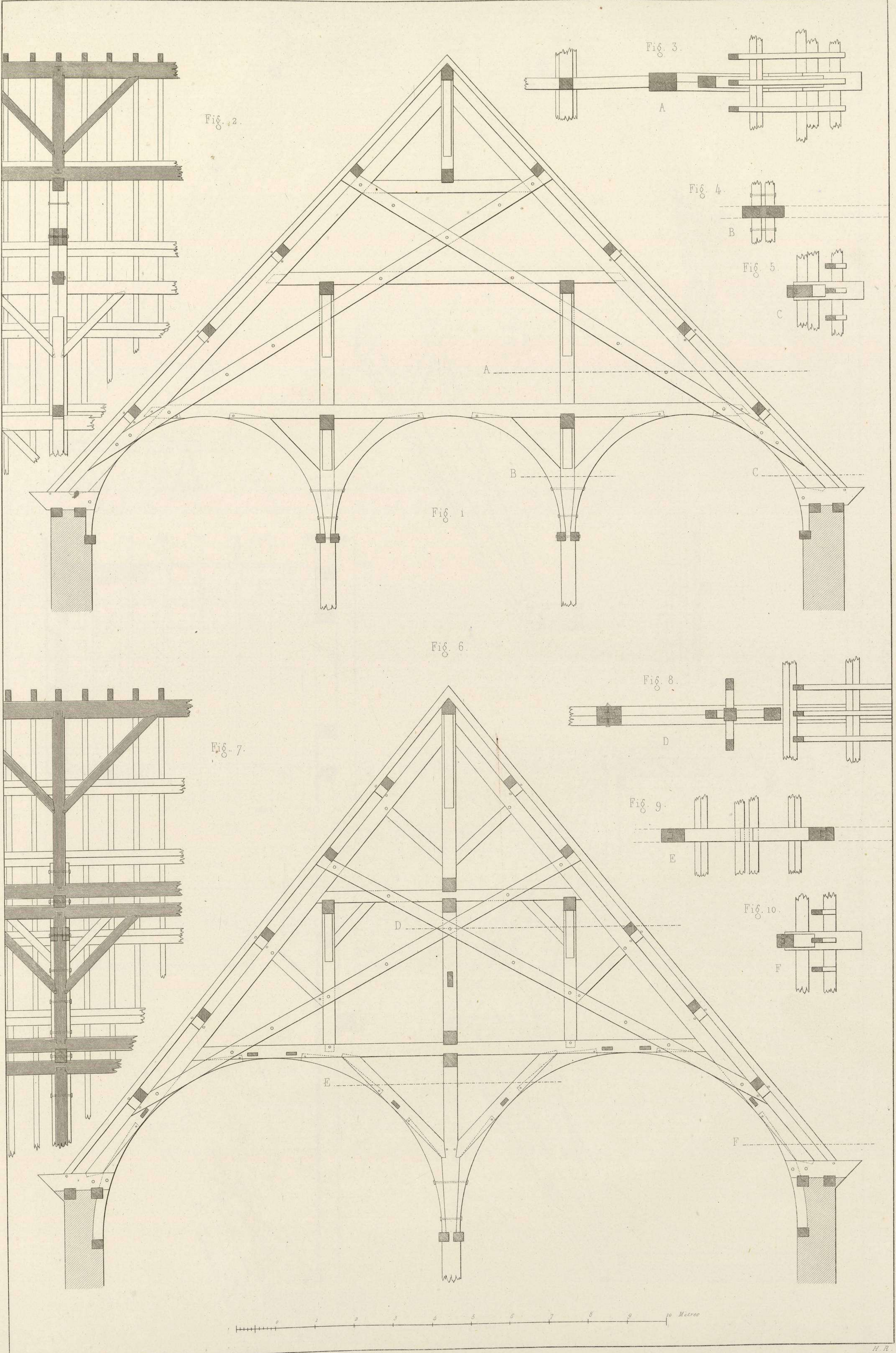

CHARPENTE.  
Combles surhaussés.

H. R.

H. et V. del.



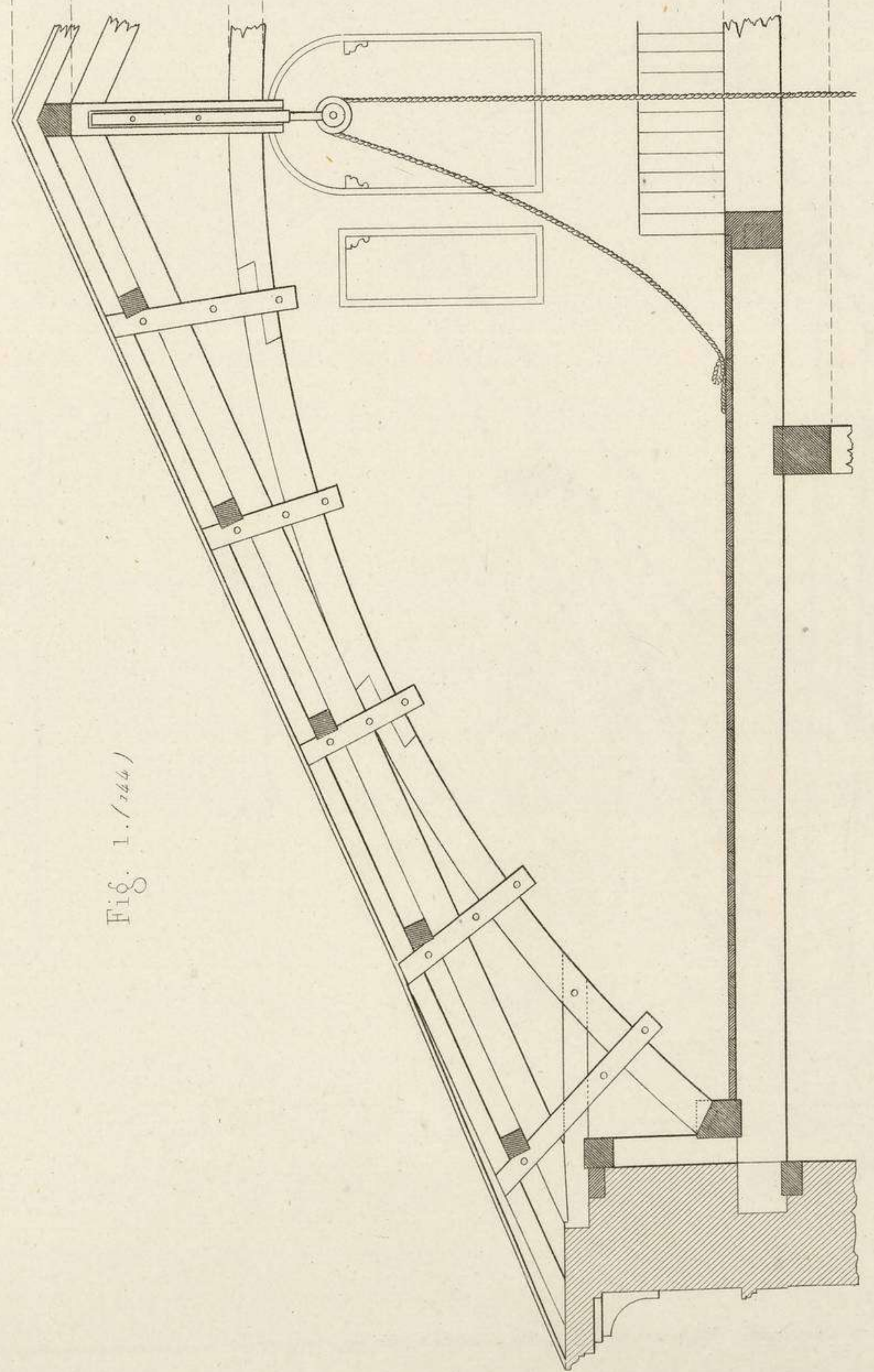

Fig. 1. (144)

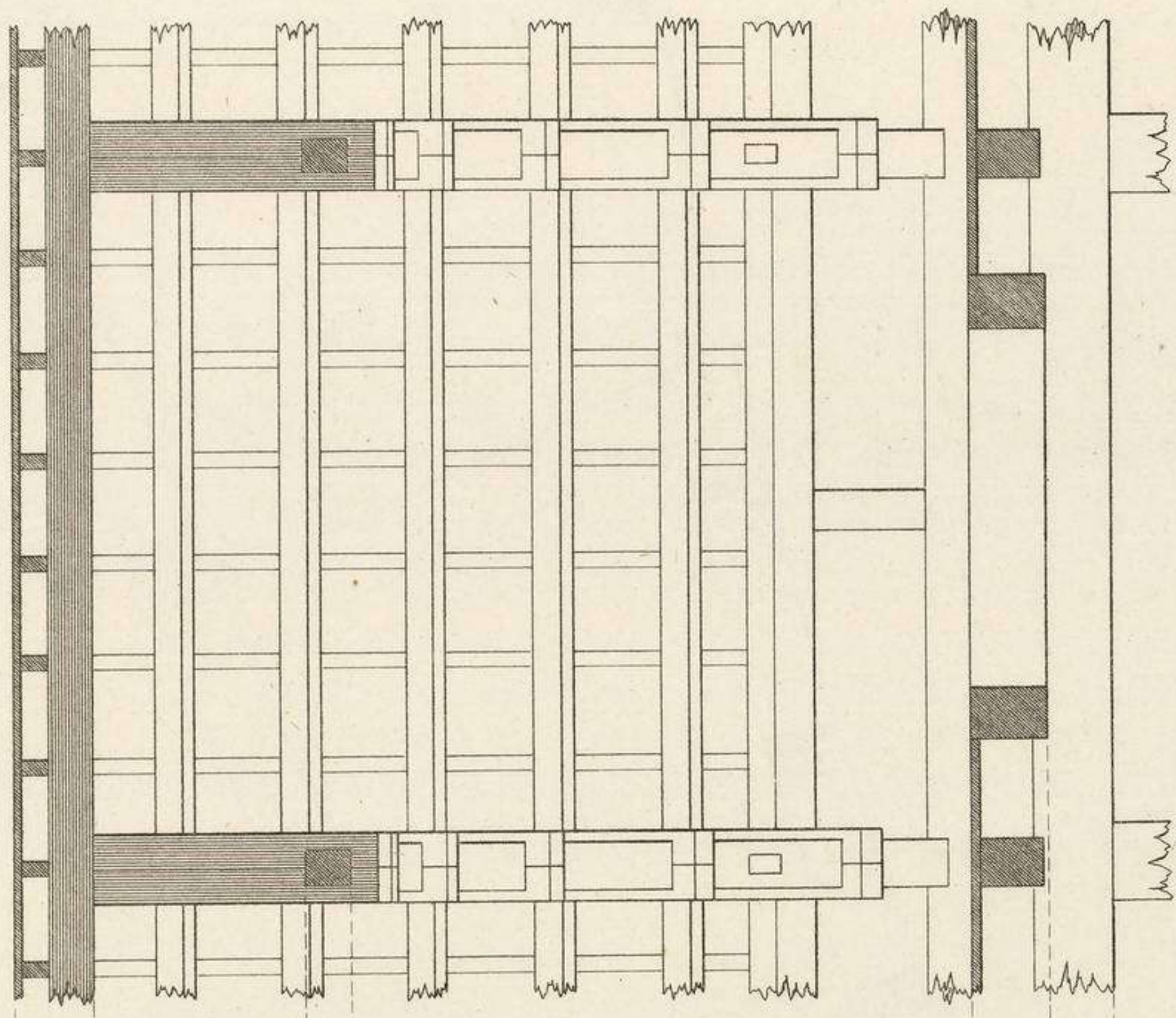

Fig. 2. (144)

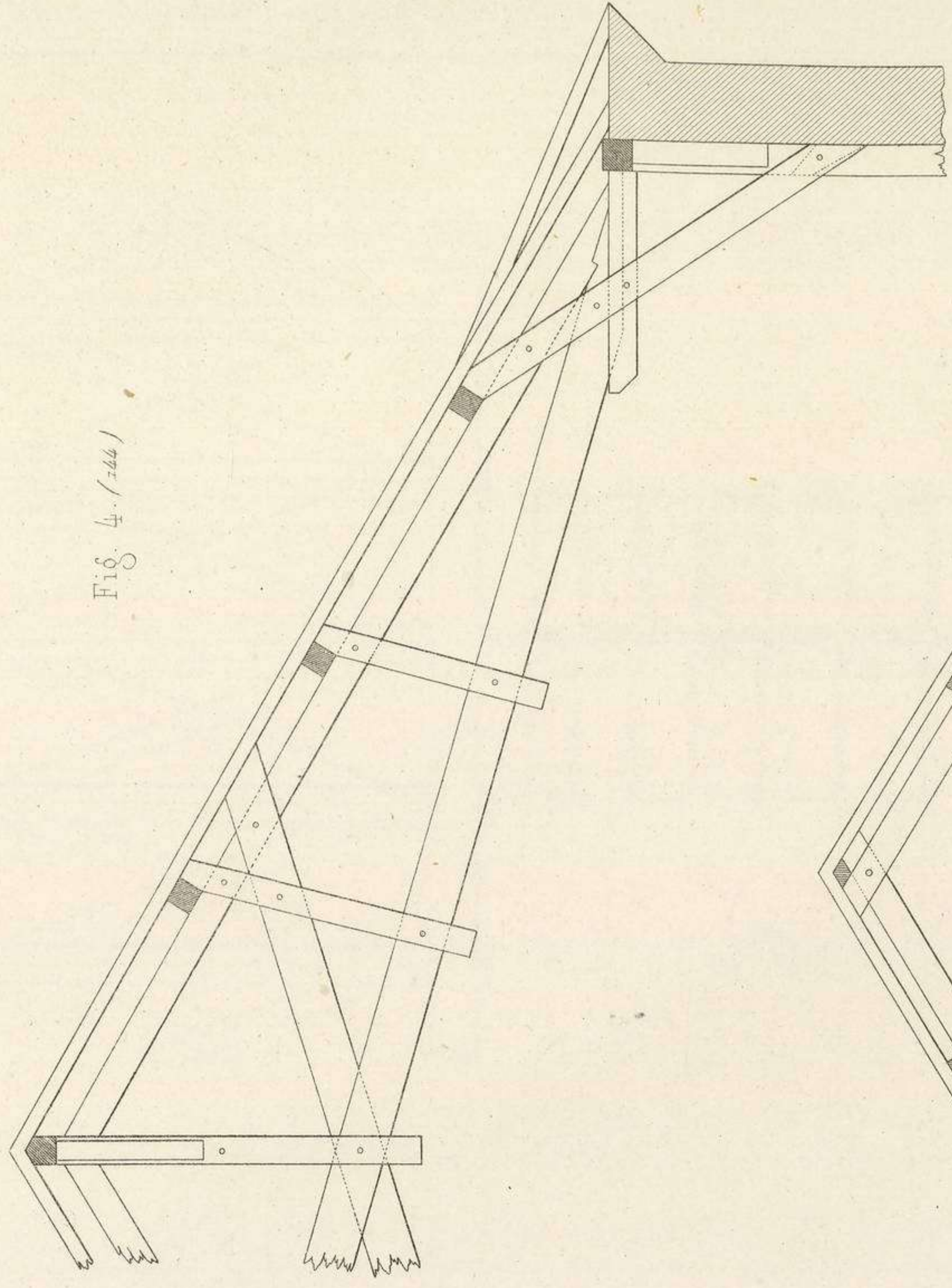

Fig. 4. (144)

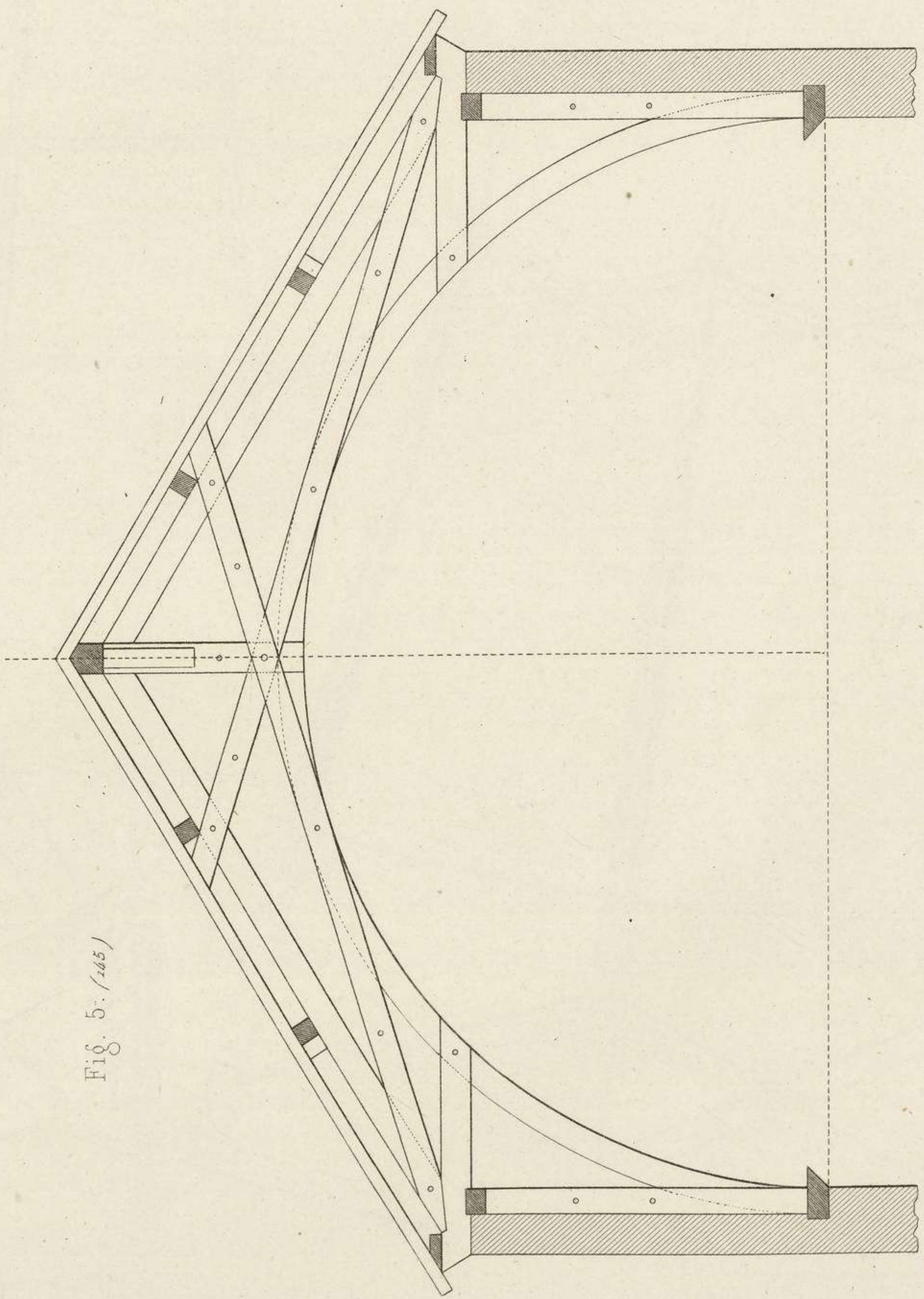

Fig. 5. (145)

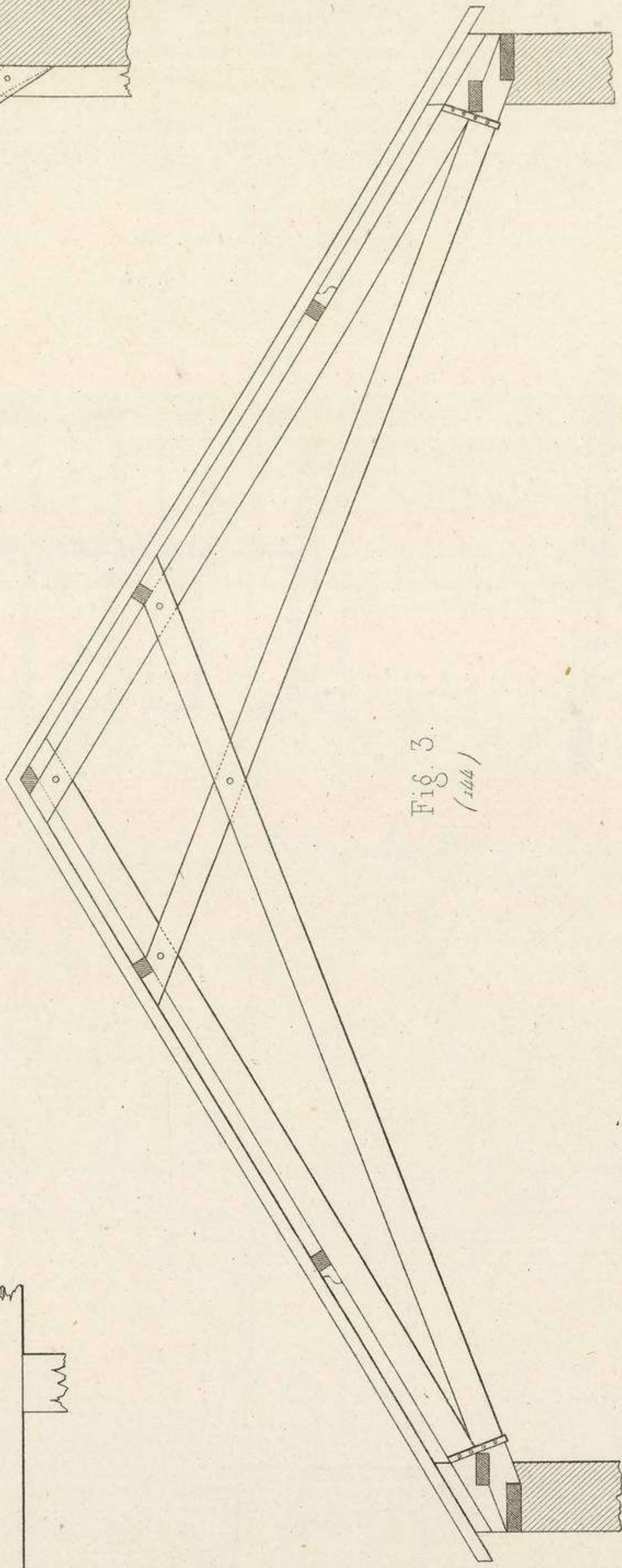

Fig. 3. (144)

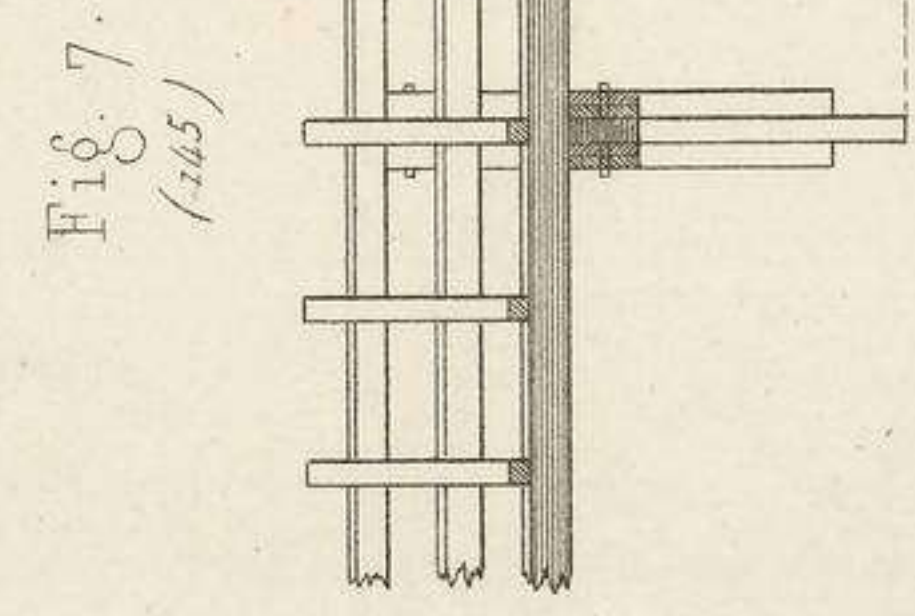

Fig. 7. (145)

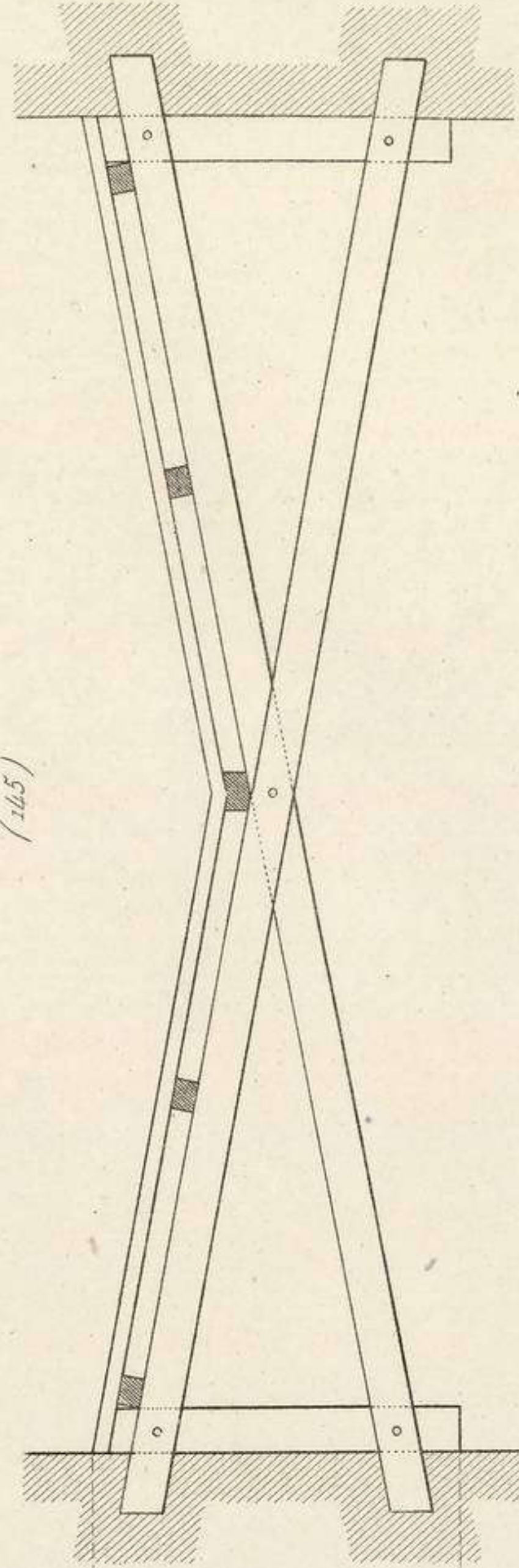

Fig. 6. (145)





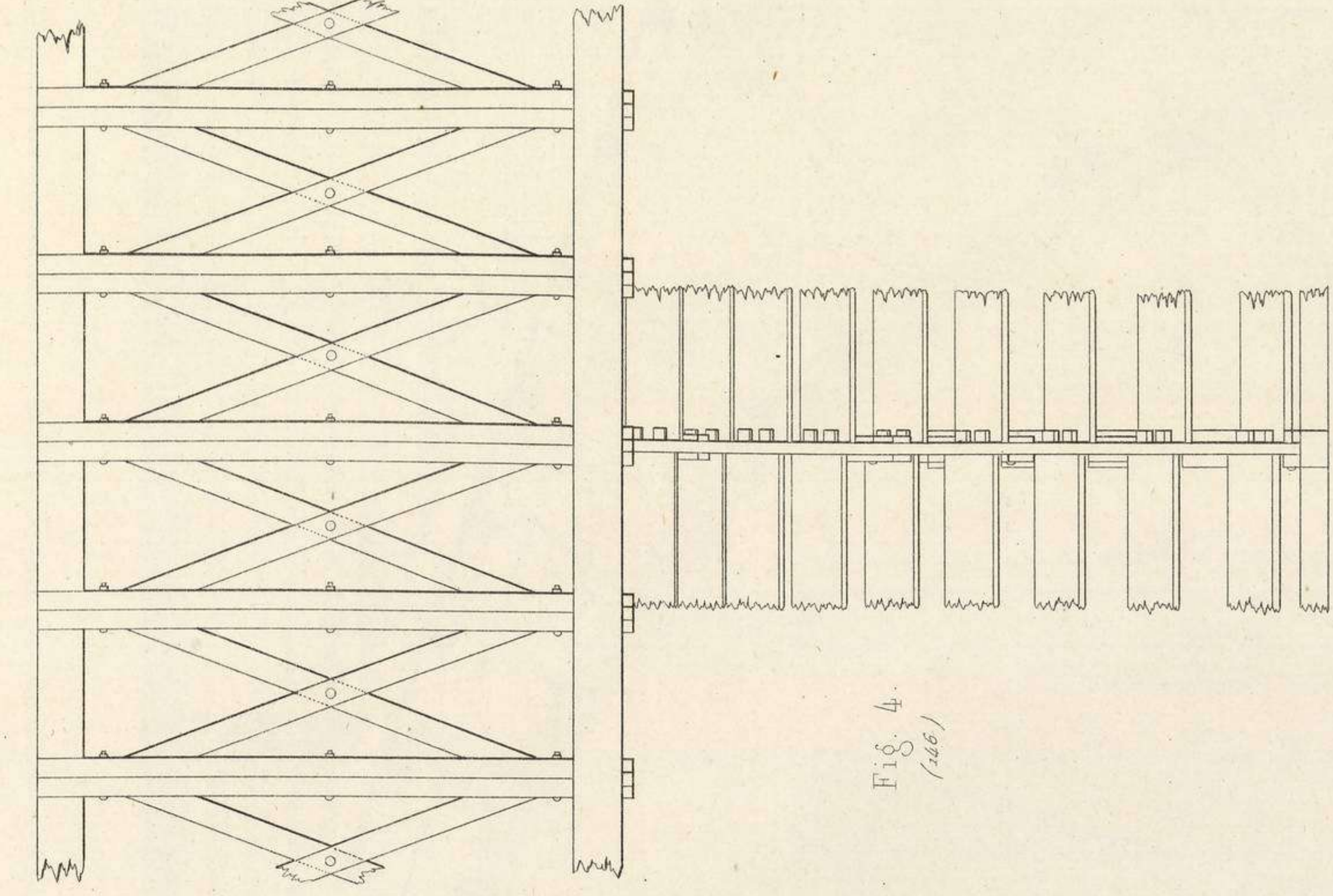

Fig. 4.  
(146)

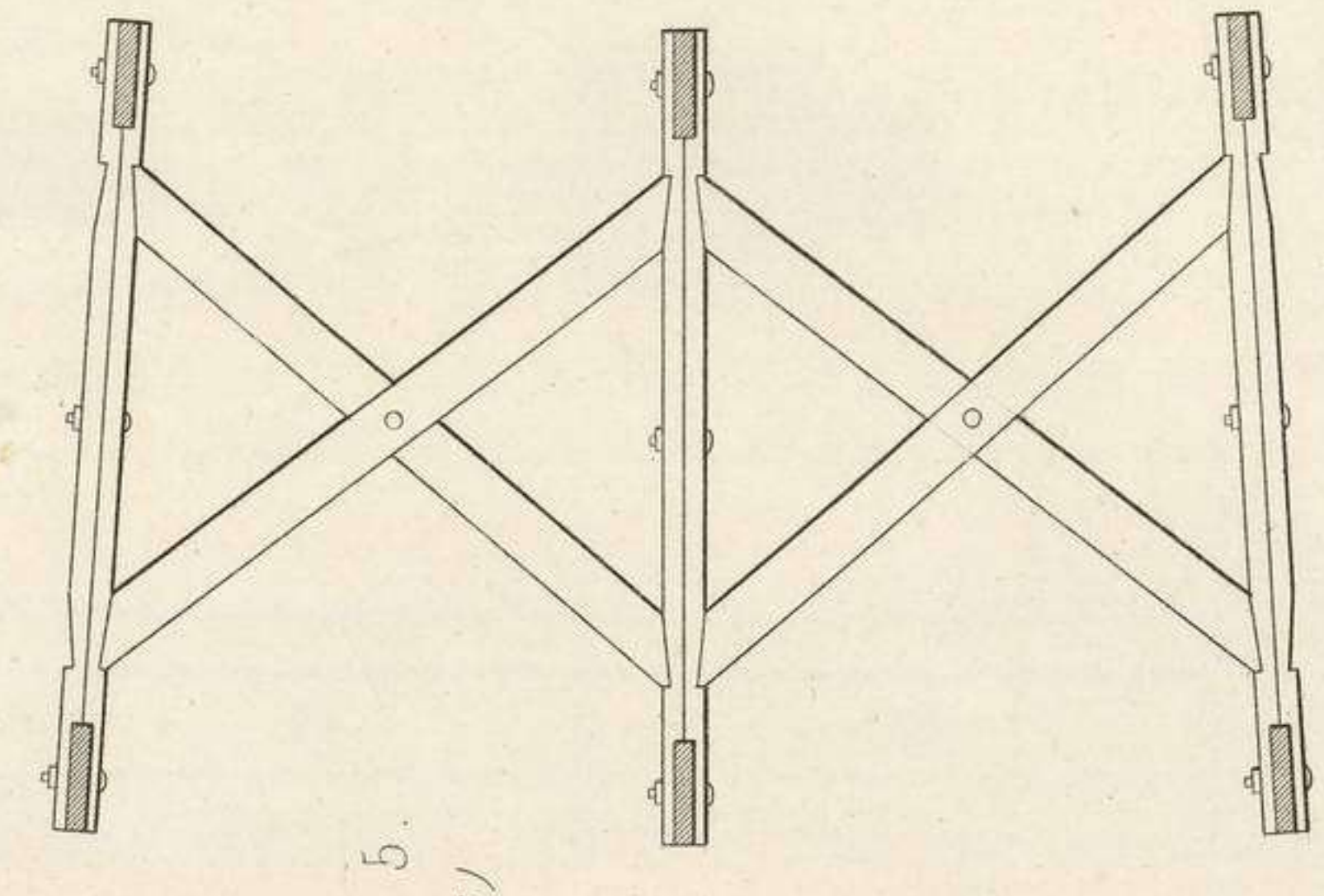

Fig. 5.  
(146)

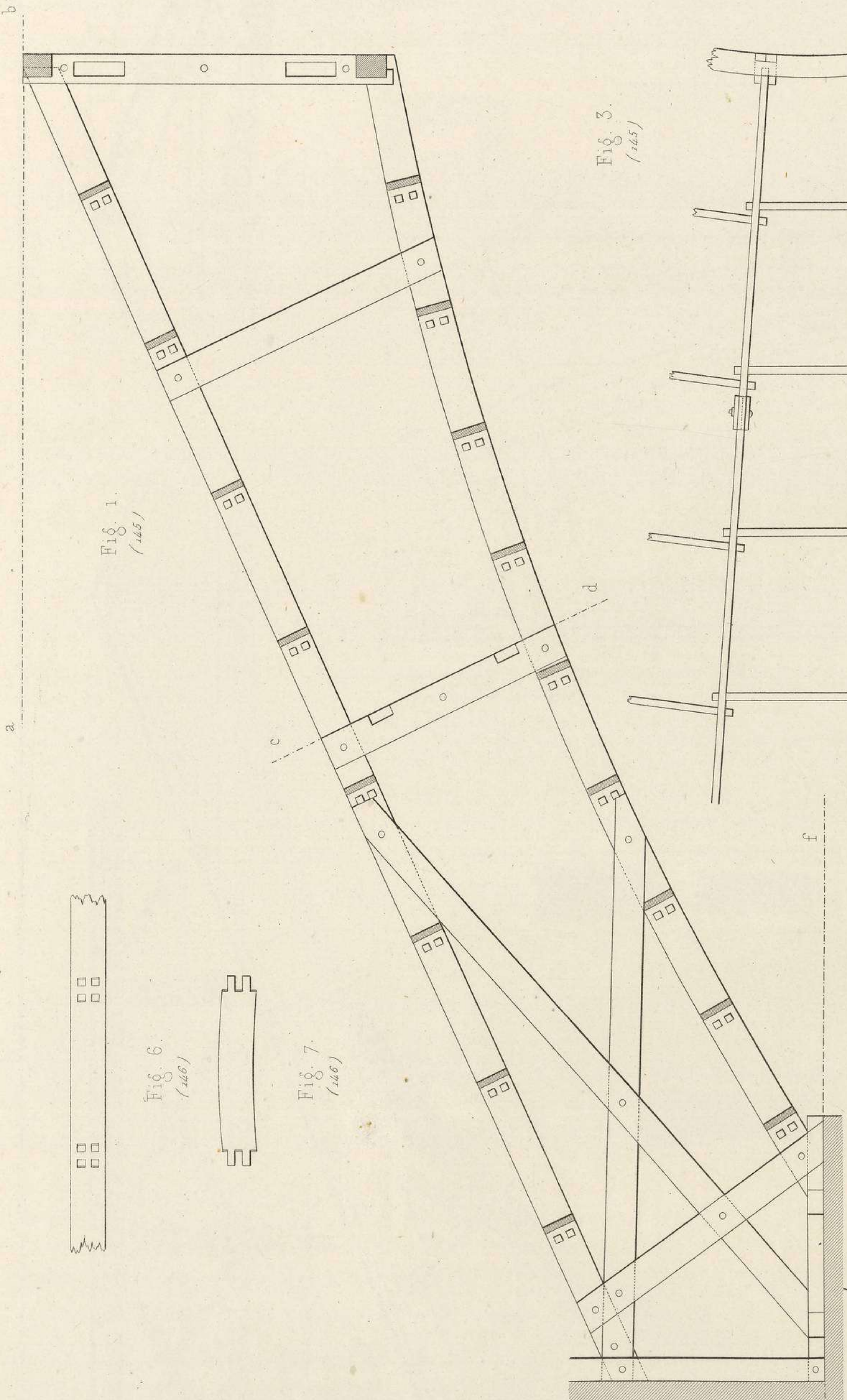

Fig. 1.  
(145)

Fig. 3.  
(145)

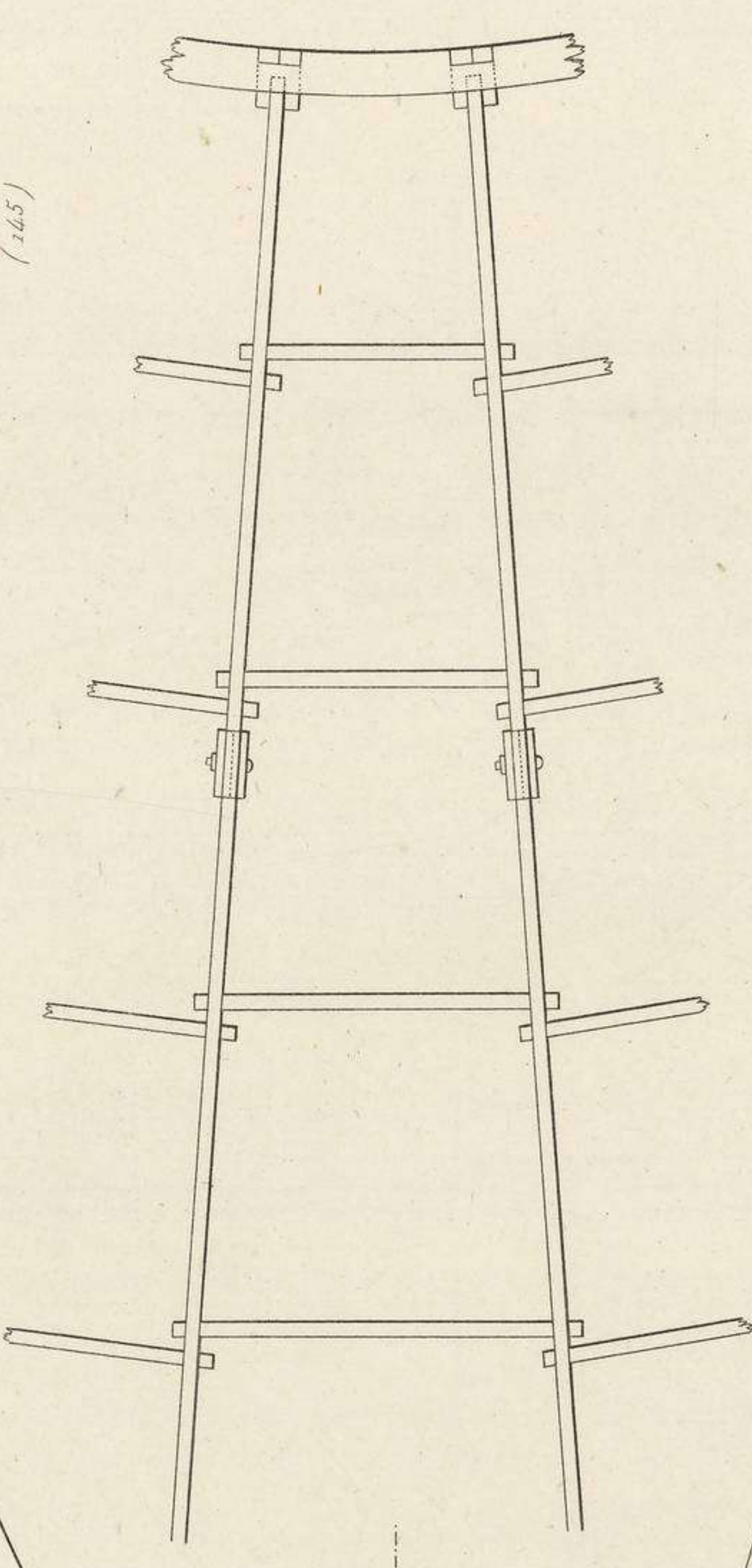

Fig. 2.  
(145)

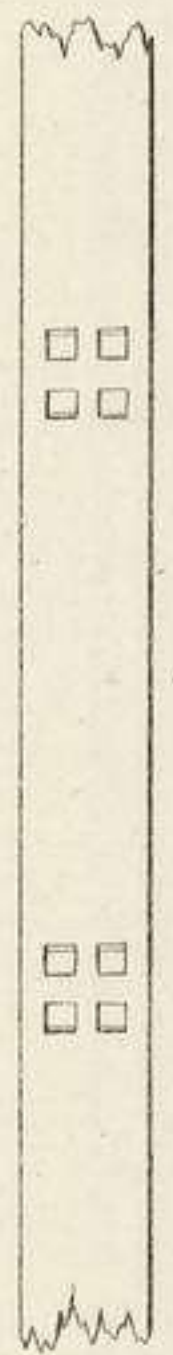
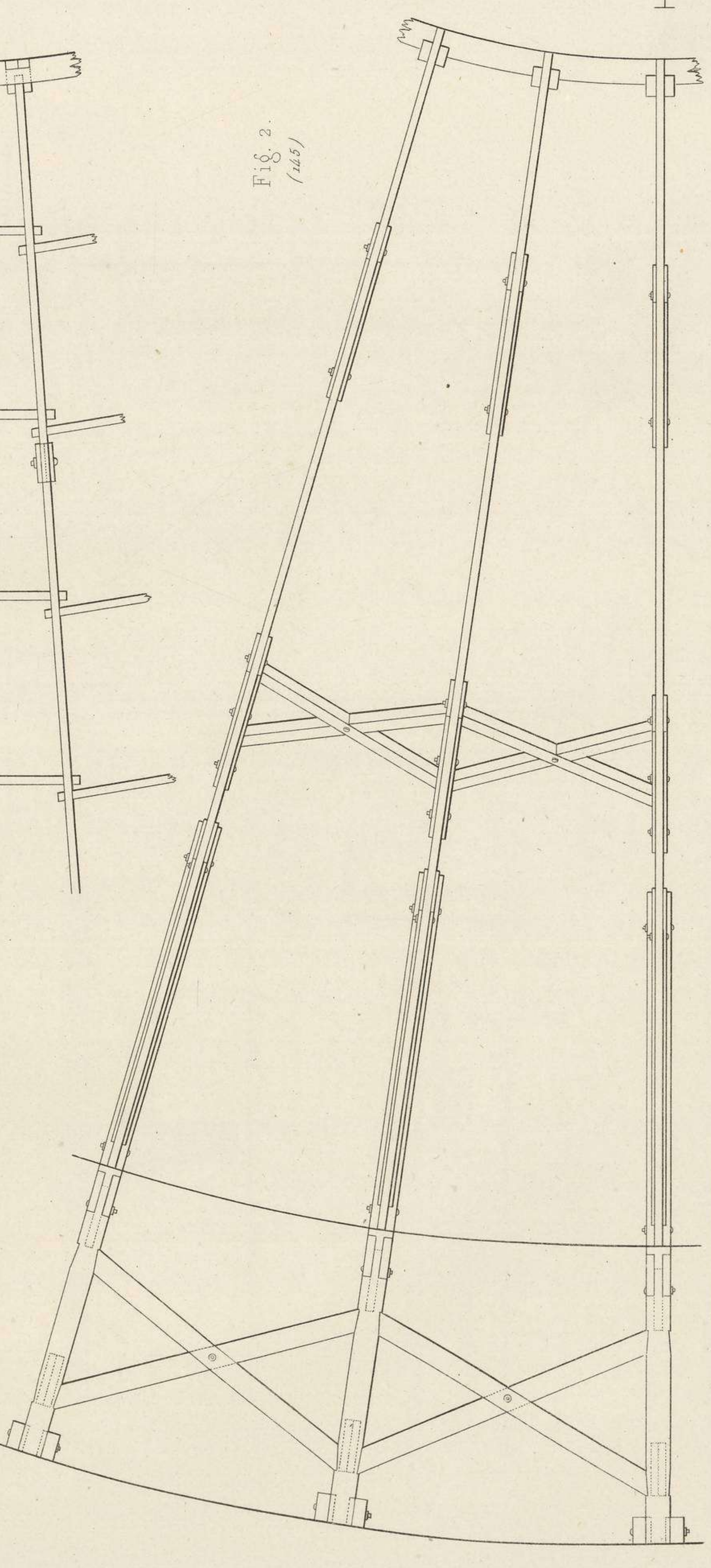

Fig. 6.  
(145)

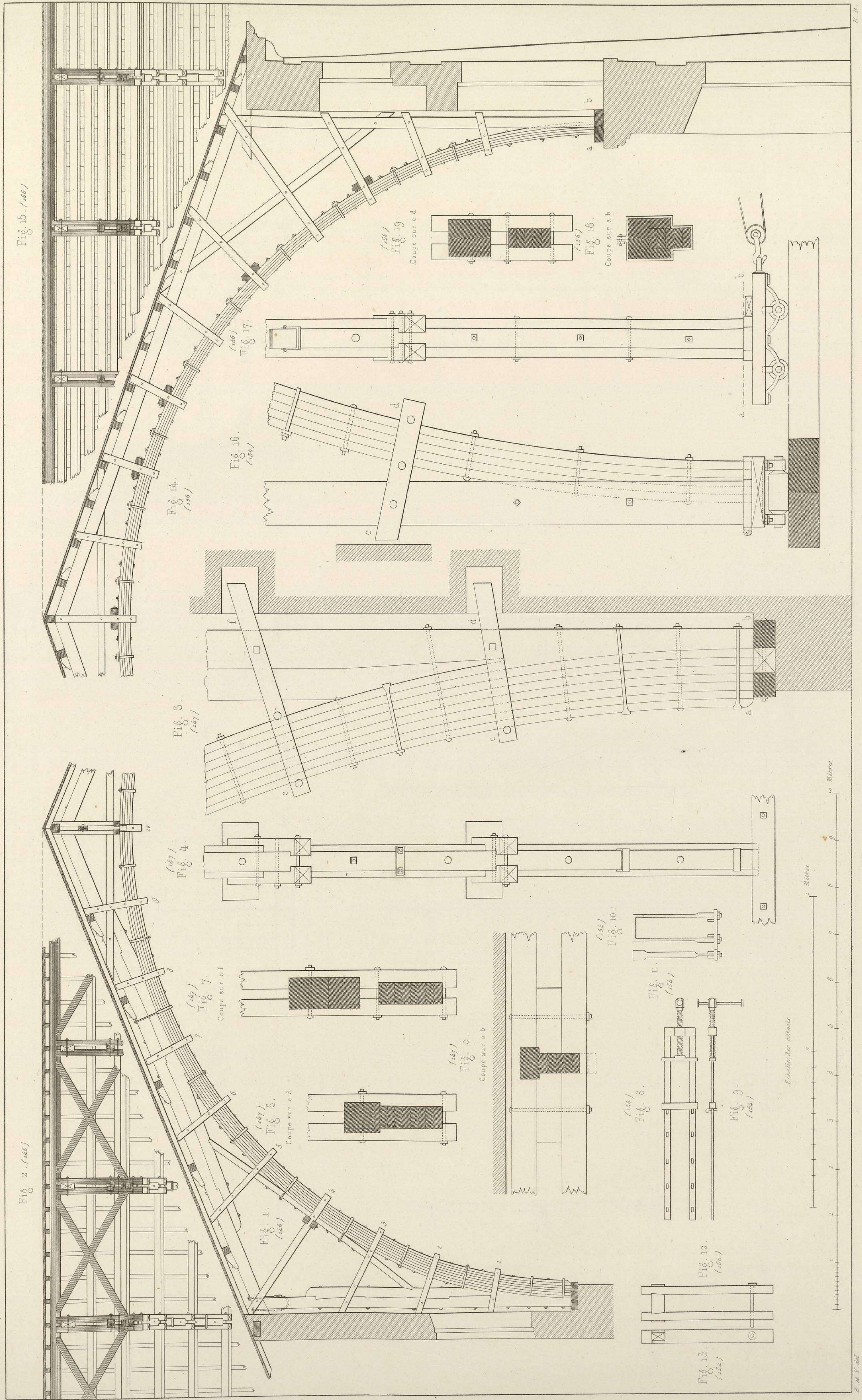

Fig. 7.  
(146)

CHARPENTE.  
Comble en bois plats.

B. de V. del.





CHARPENTE, Cintre en madriers courbés sur leur plat.

B. de V. del.

H. R.



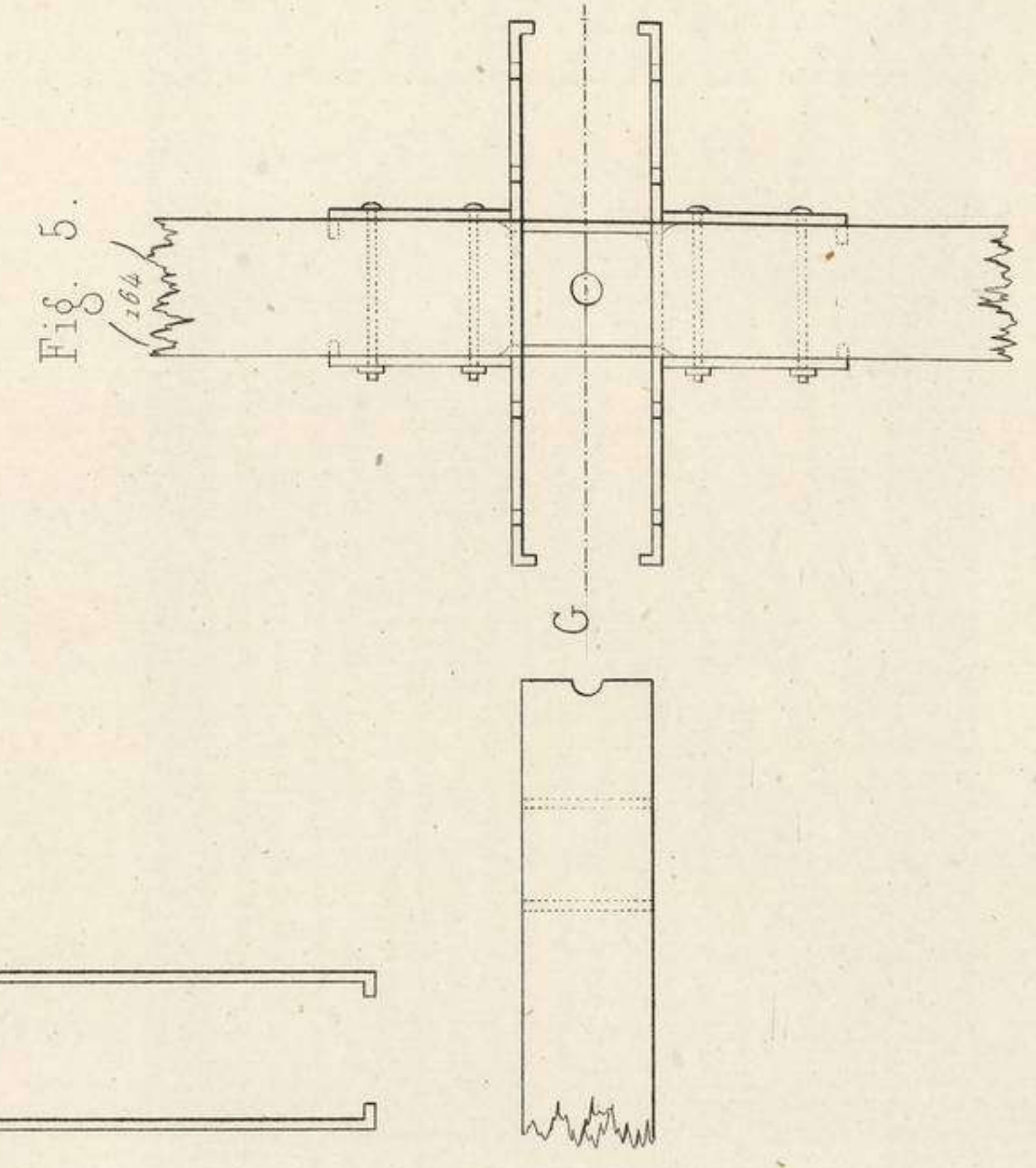
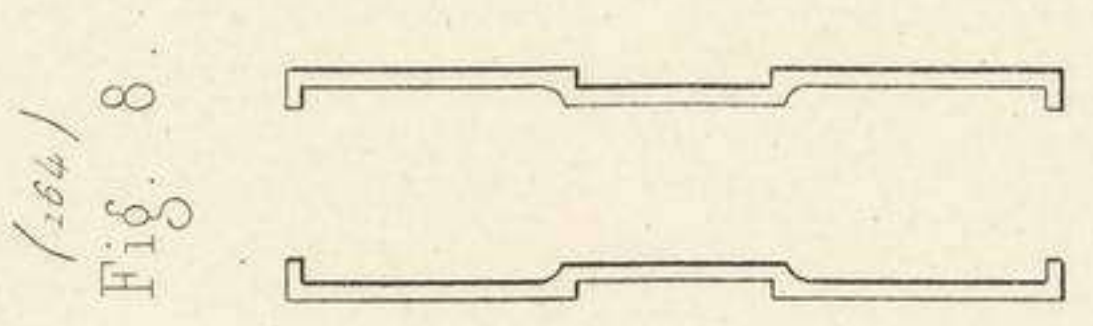
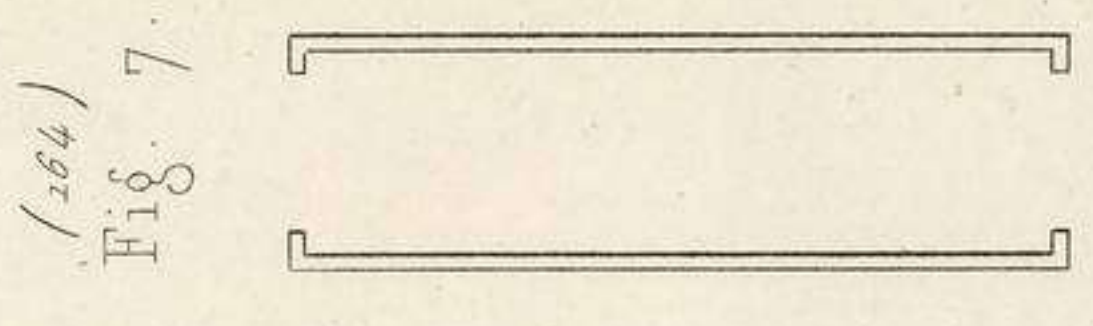
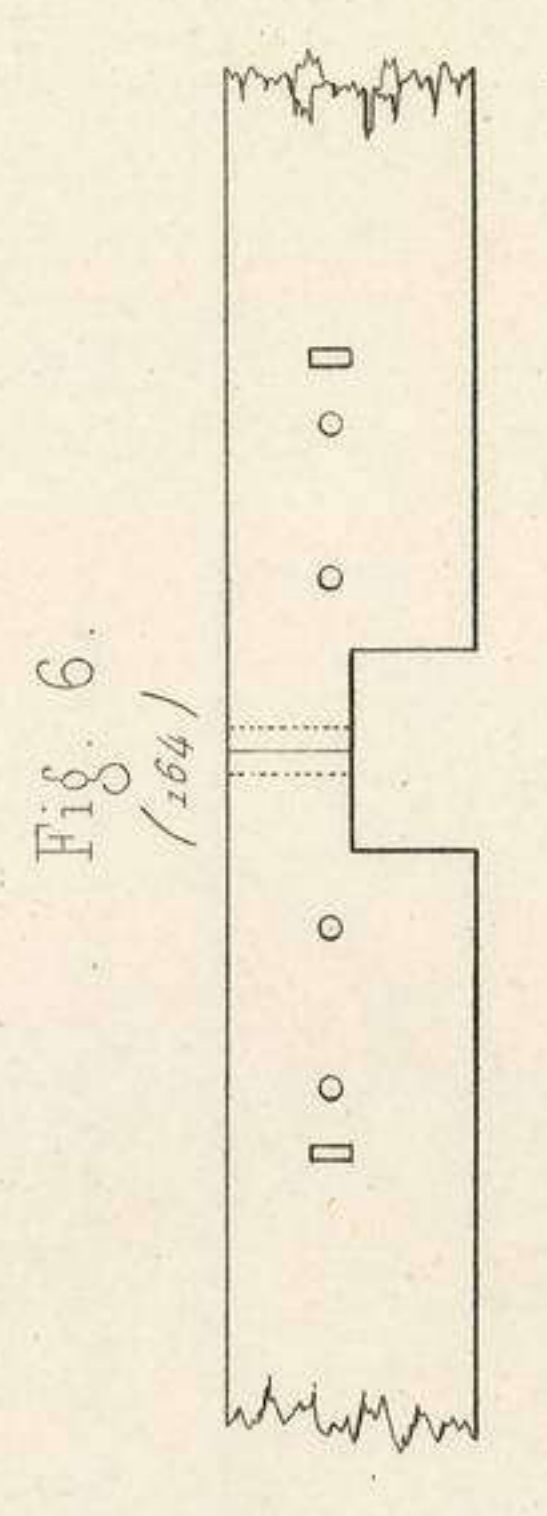
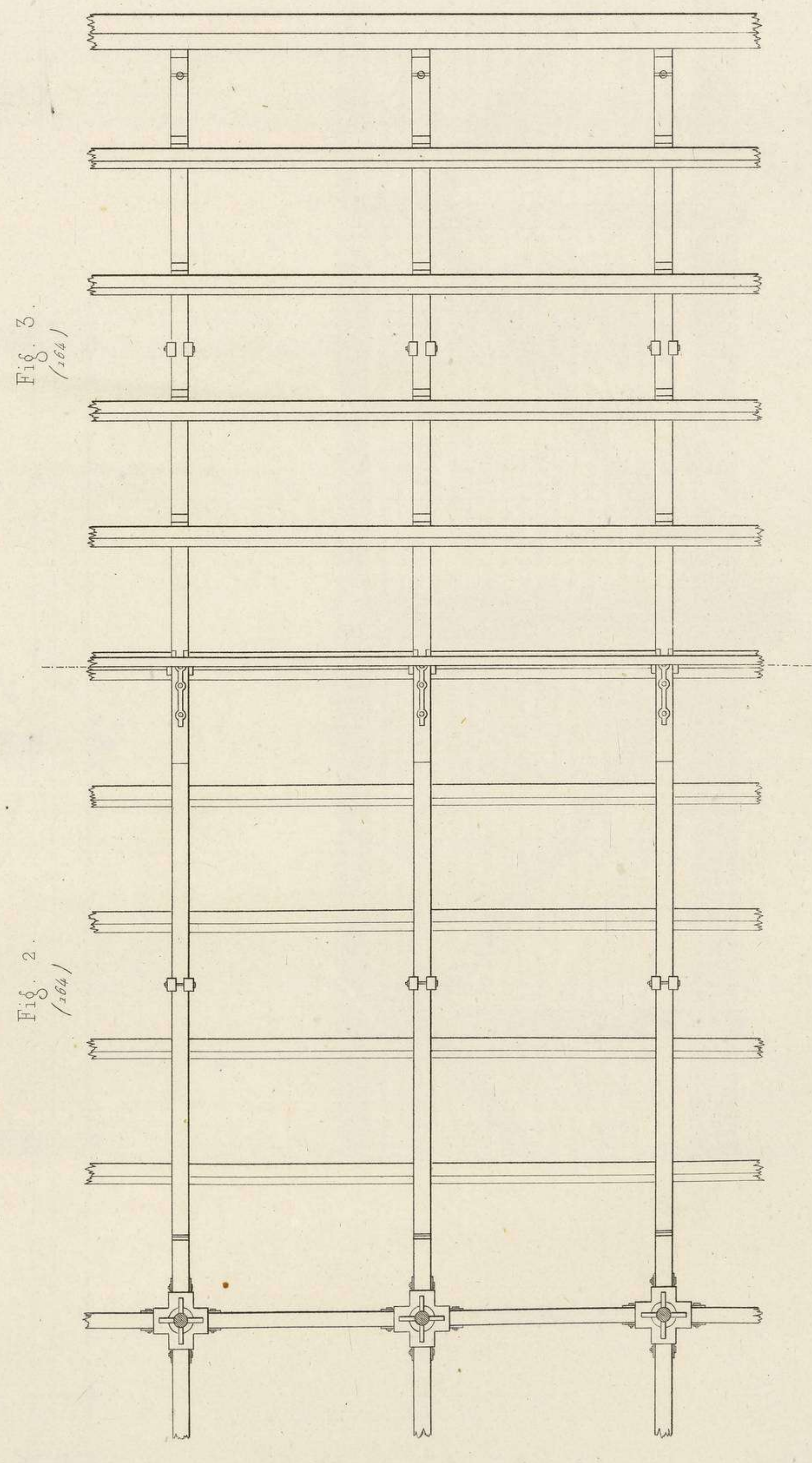
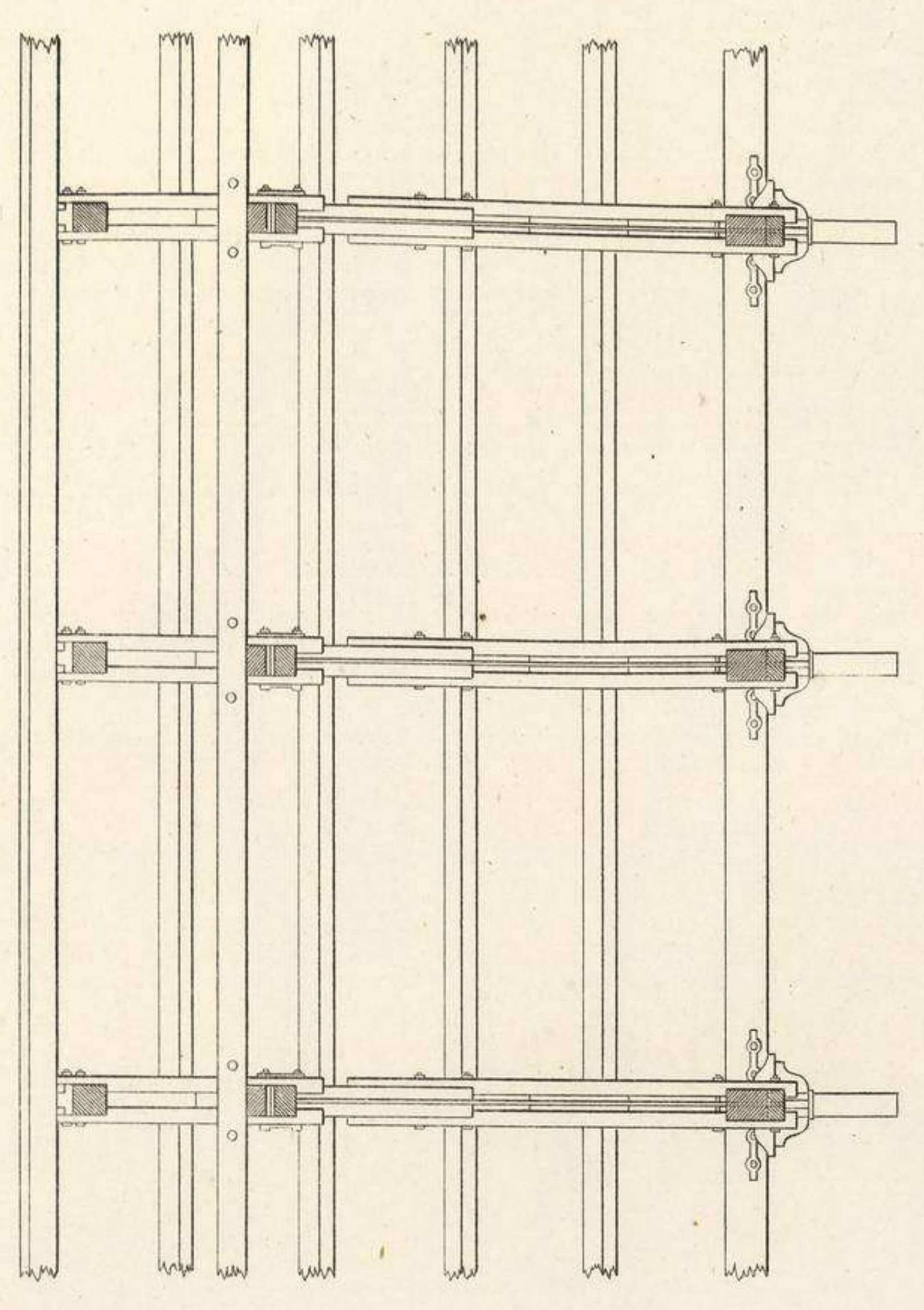
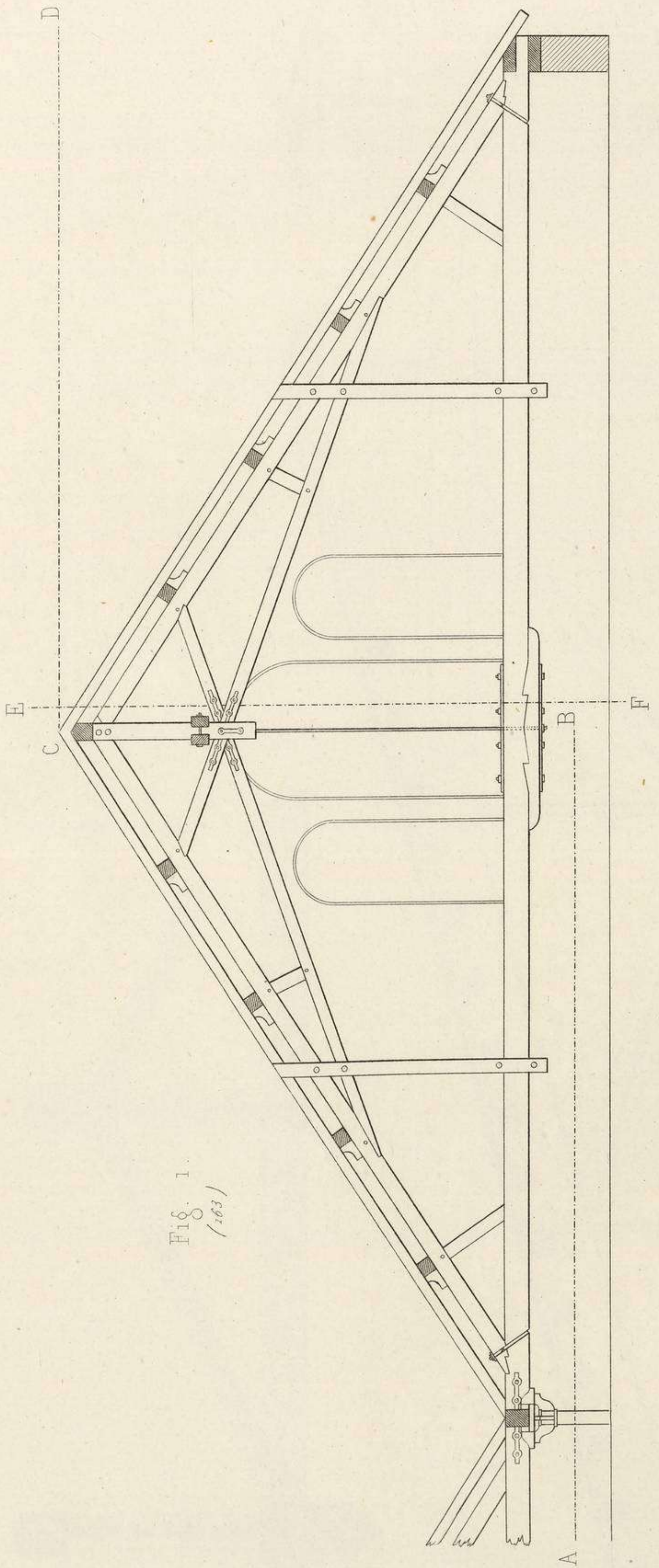

1 2 3 4 5 6 7 8 9 10 Mètres

B. et V. del.

H. R.

CHARPENTE,  
Combinaison du bois et du Fer.



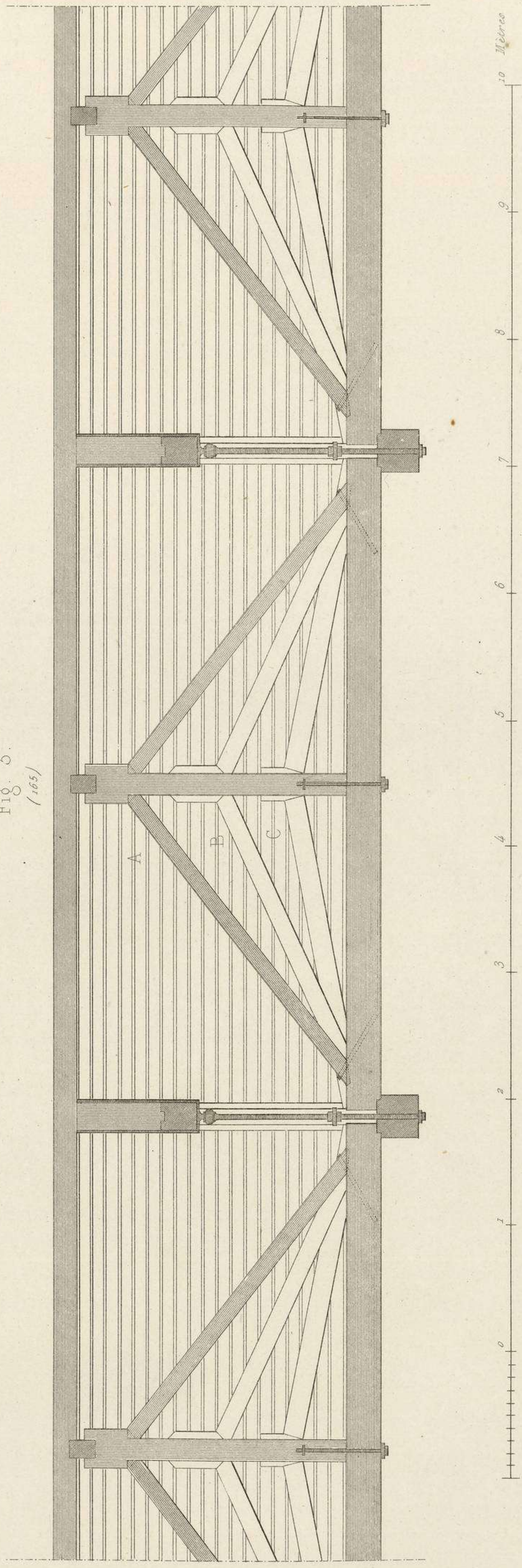
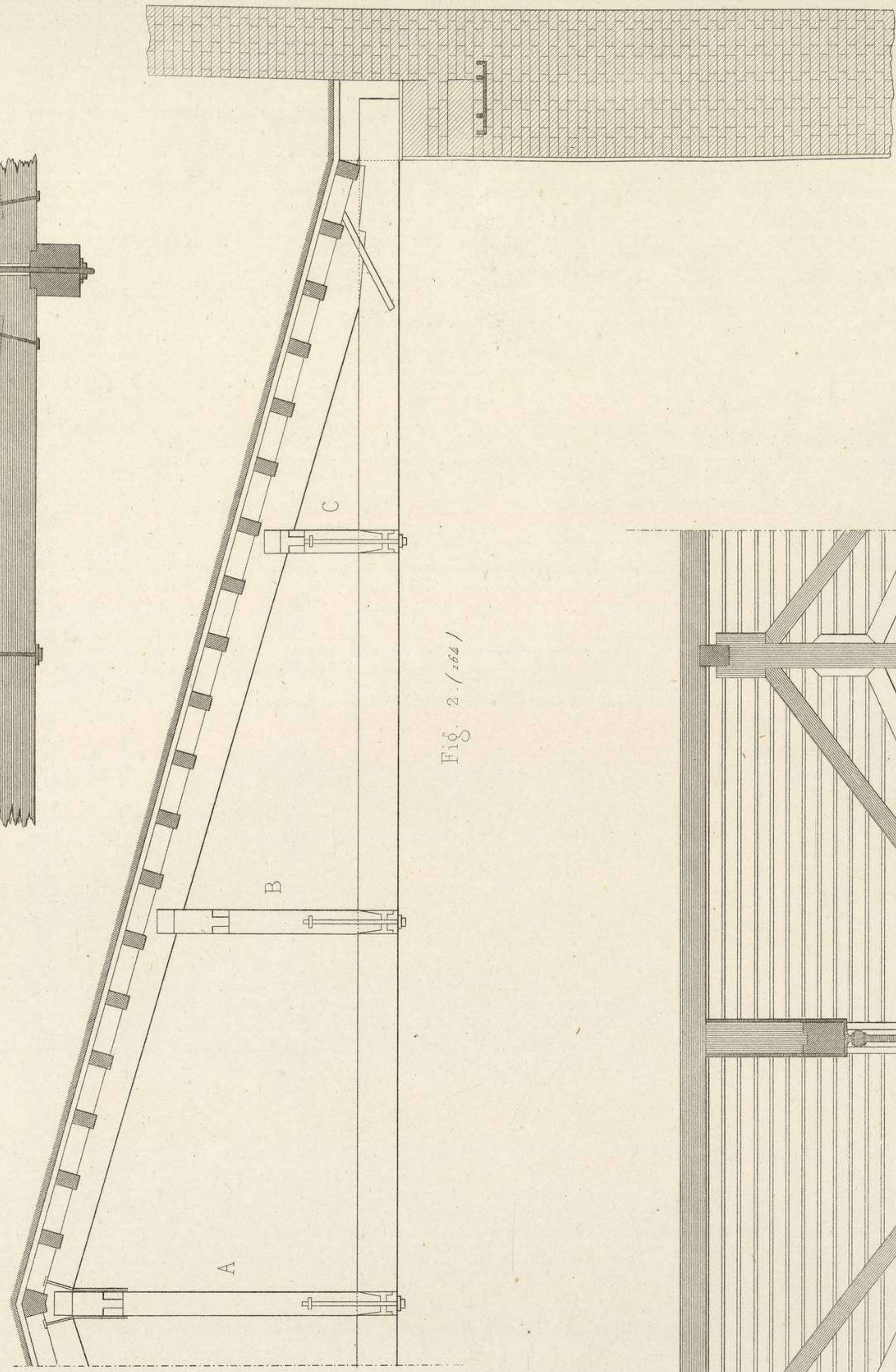
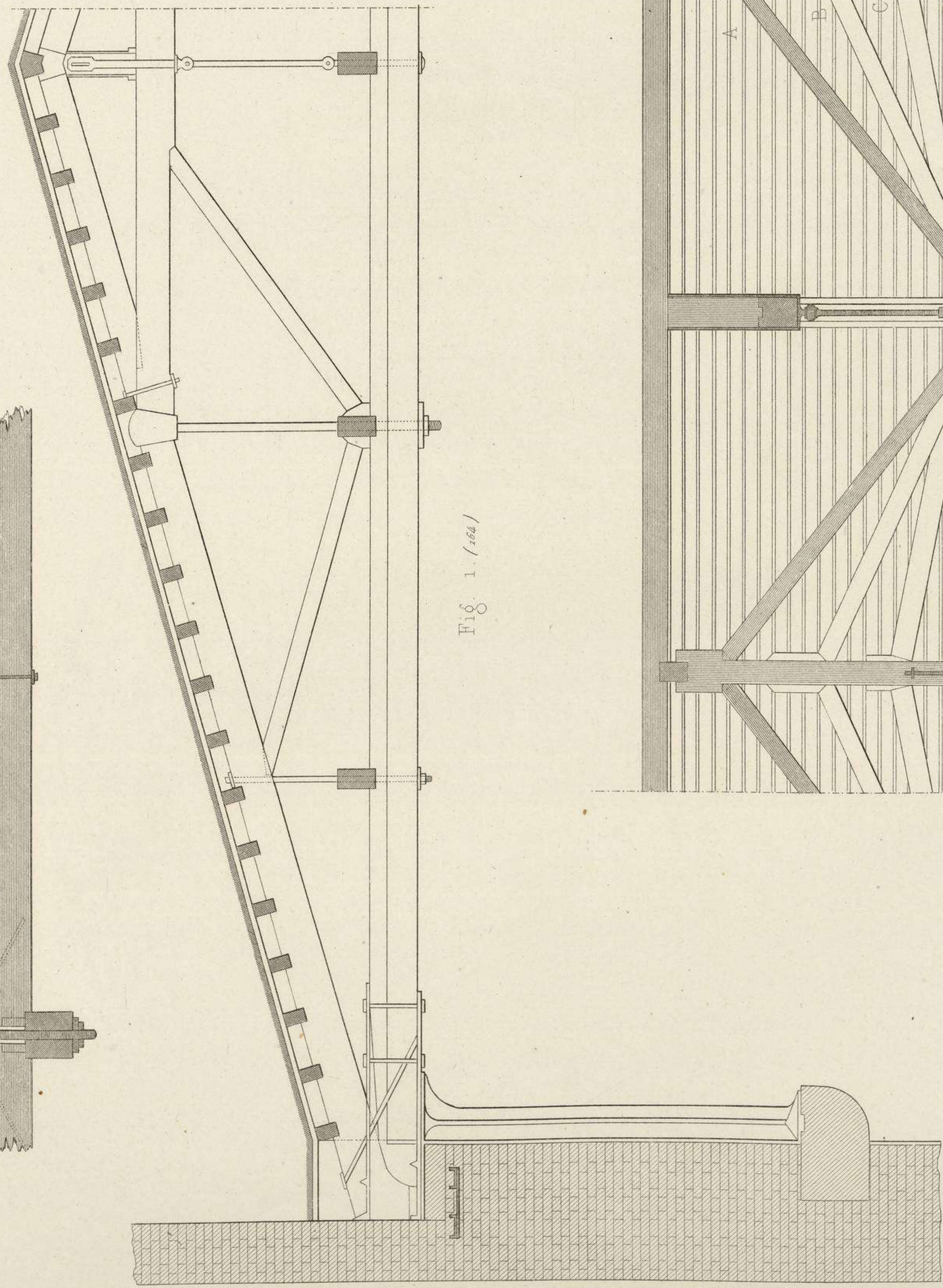
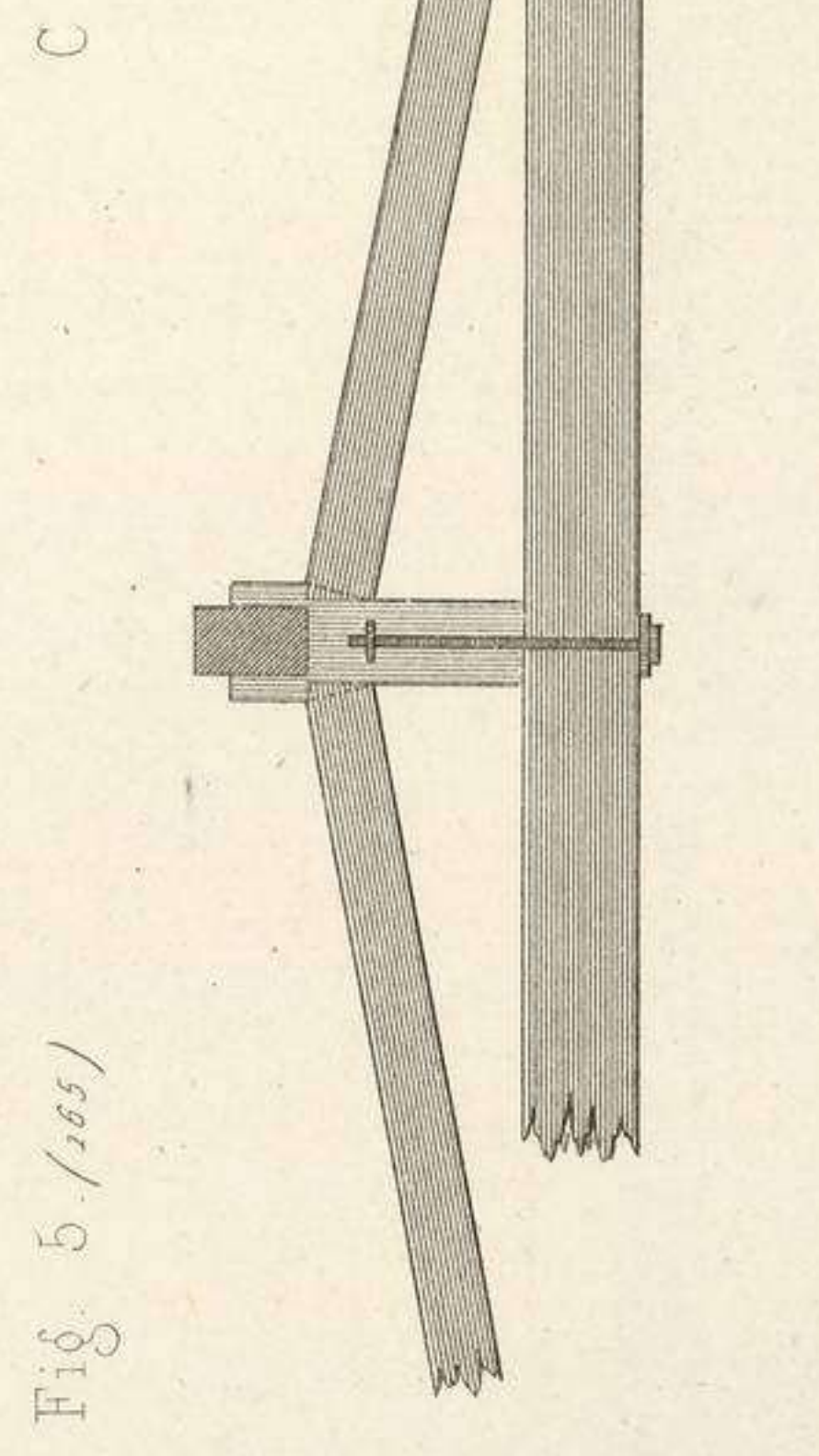
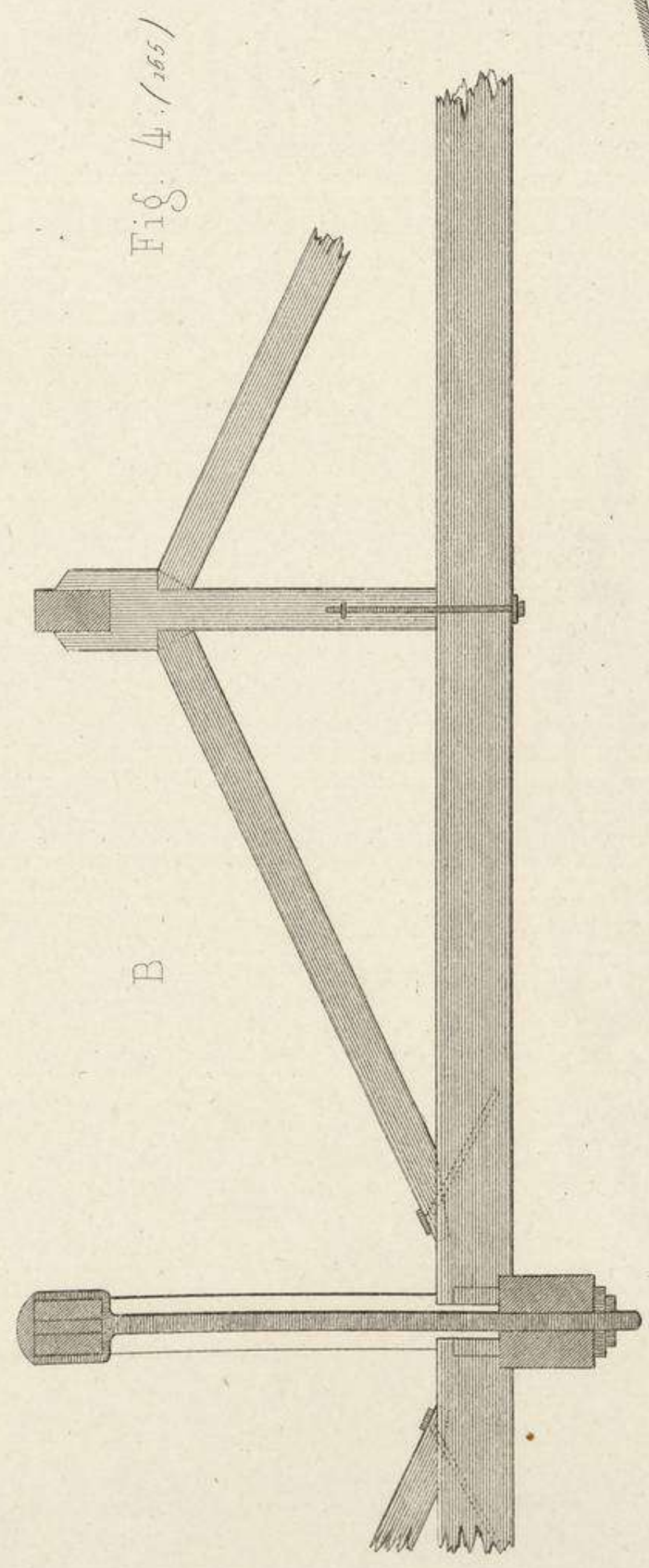

CHARPENTE,  
Combinaison du bois et du Fer.



Fig. 1.

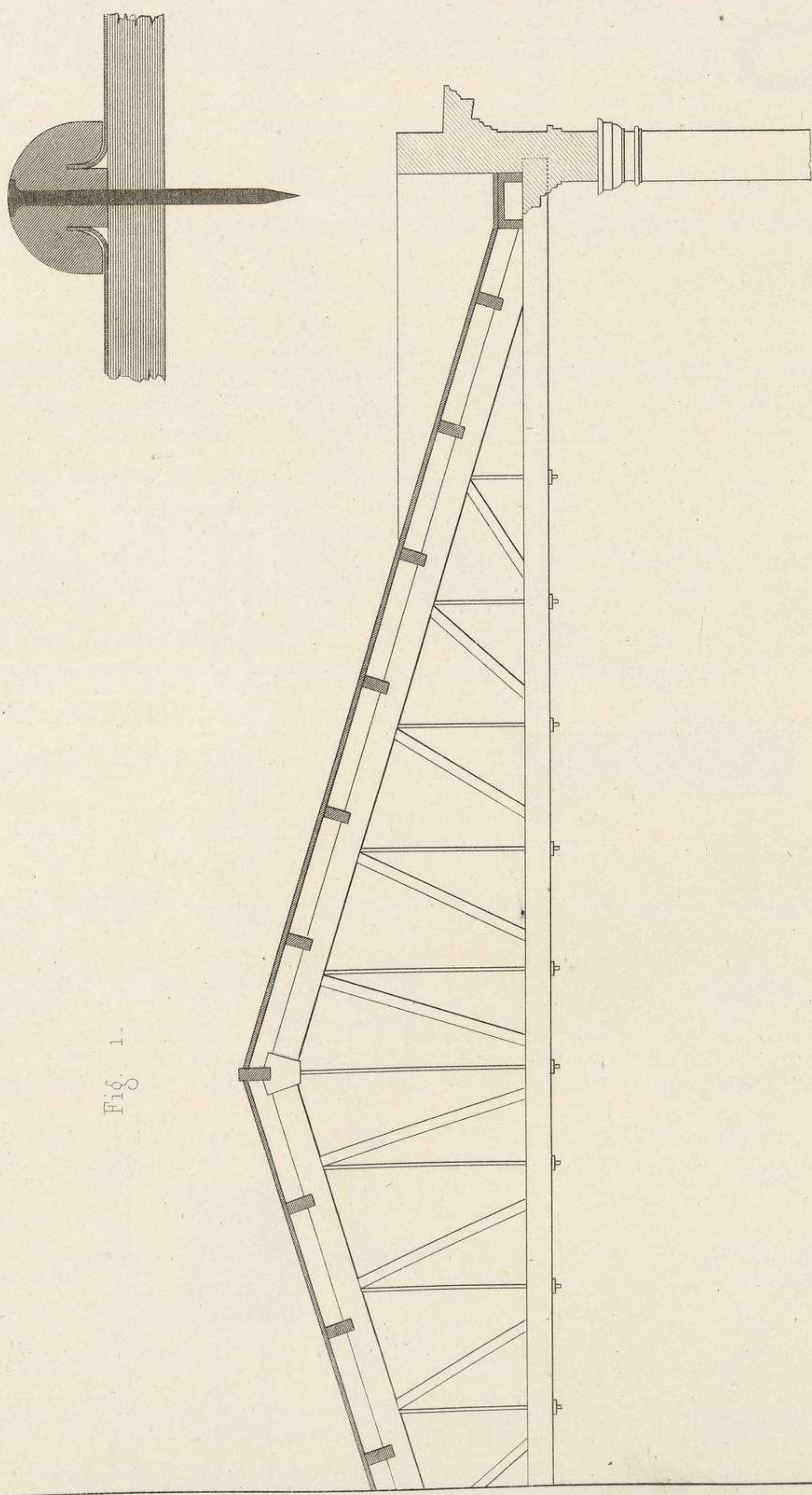

Fig. 2.

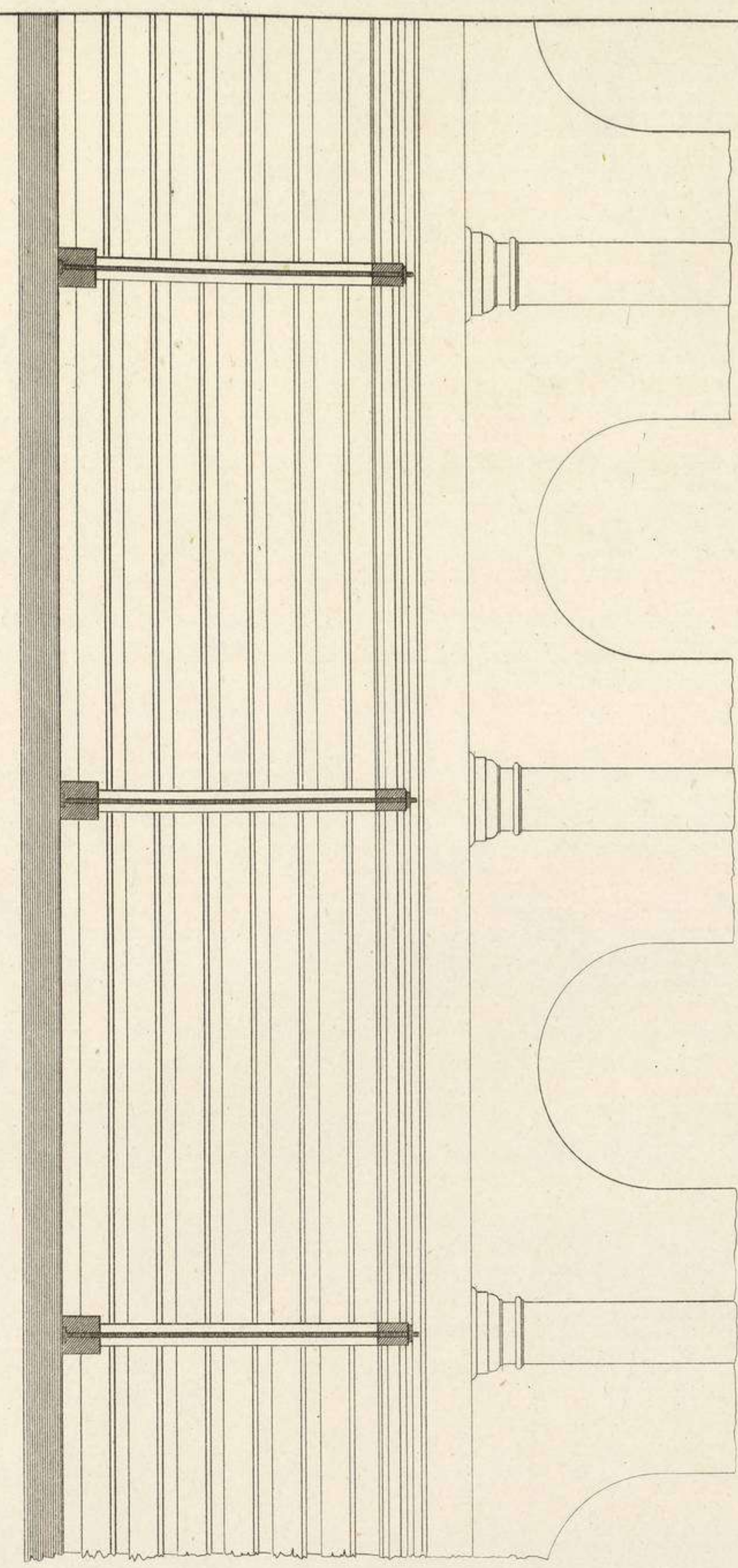

Fig. 3.

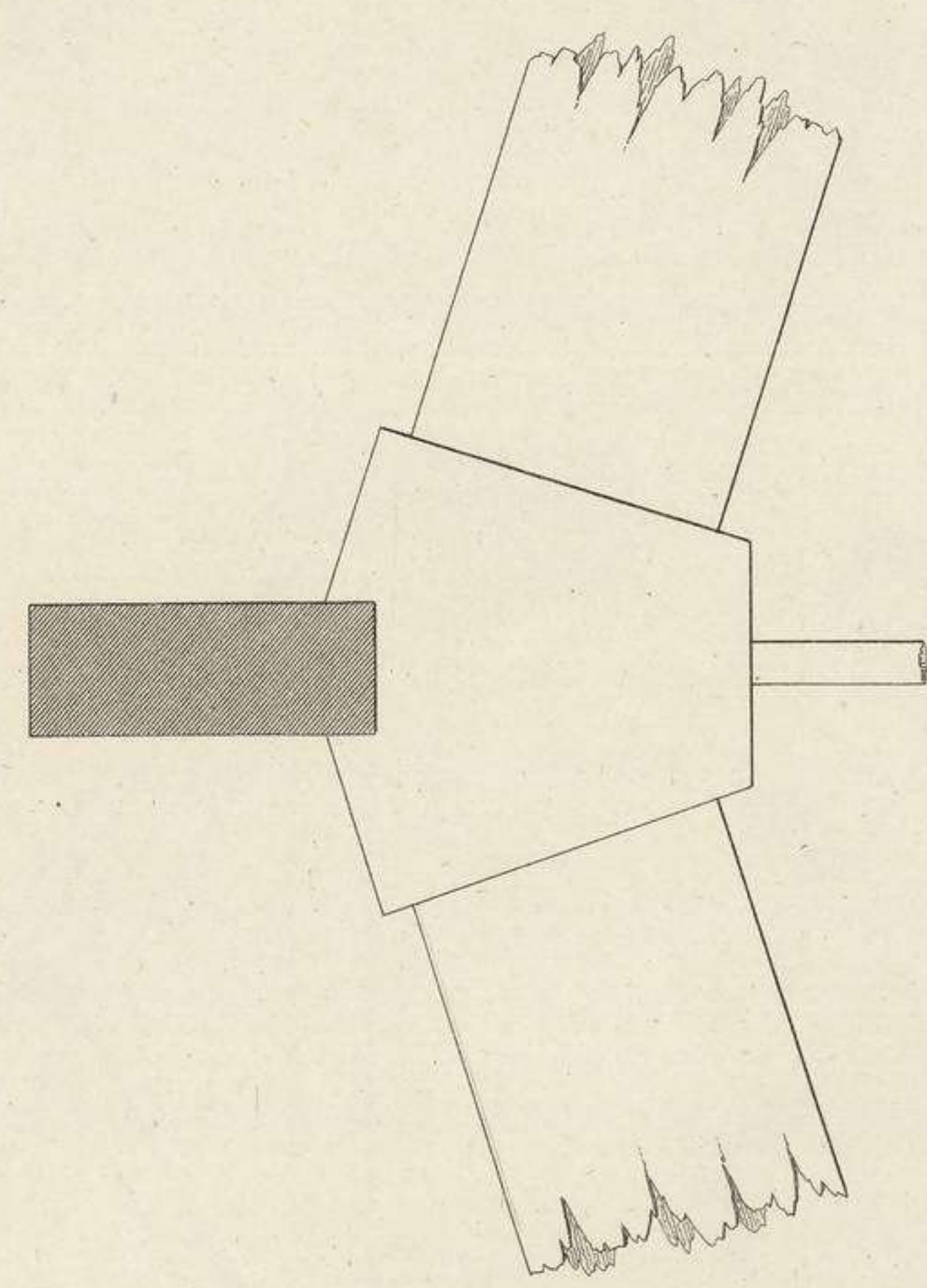

Fig. 4.

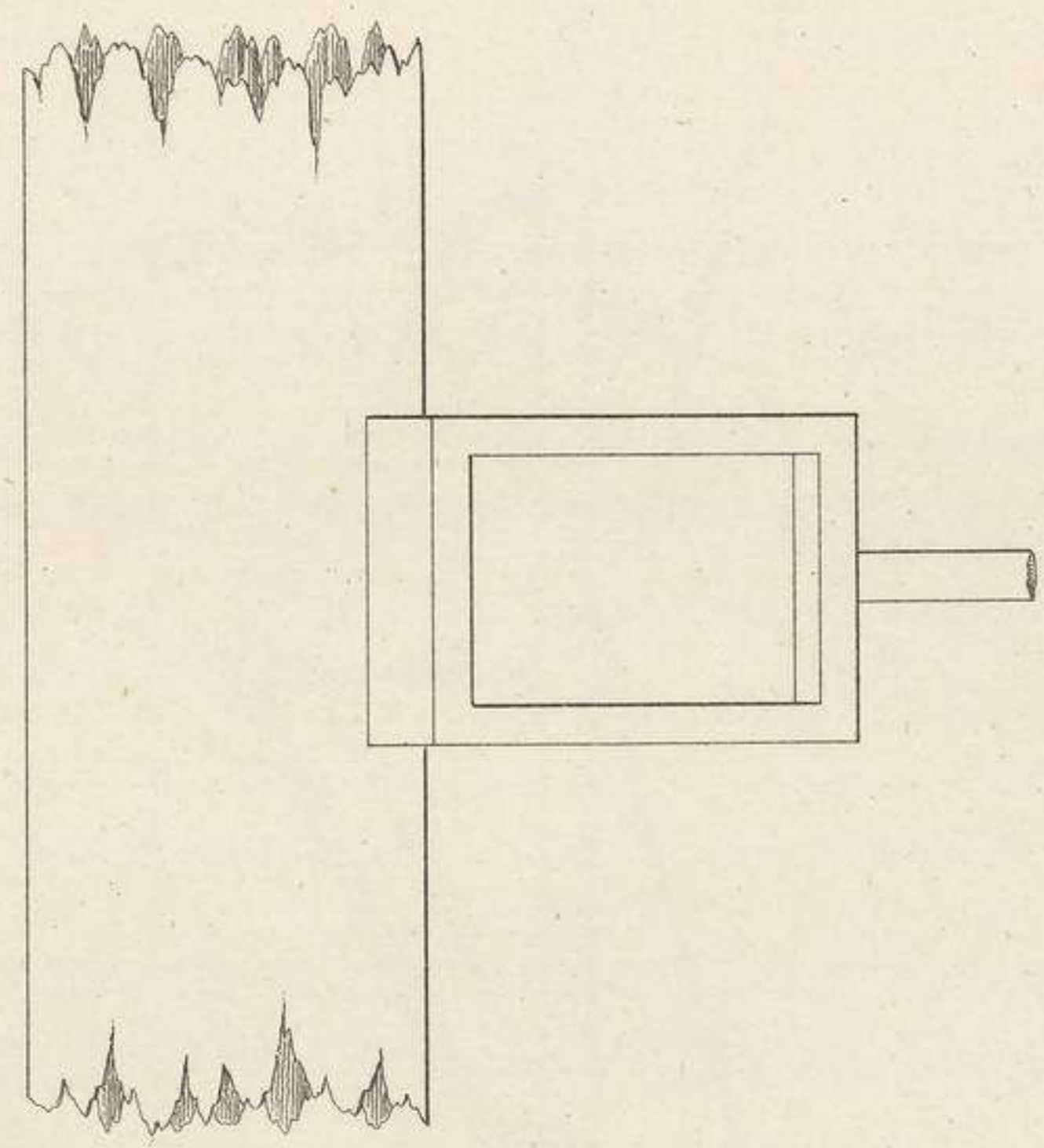
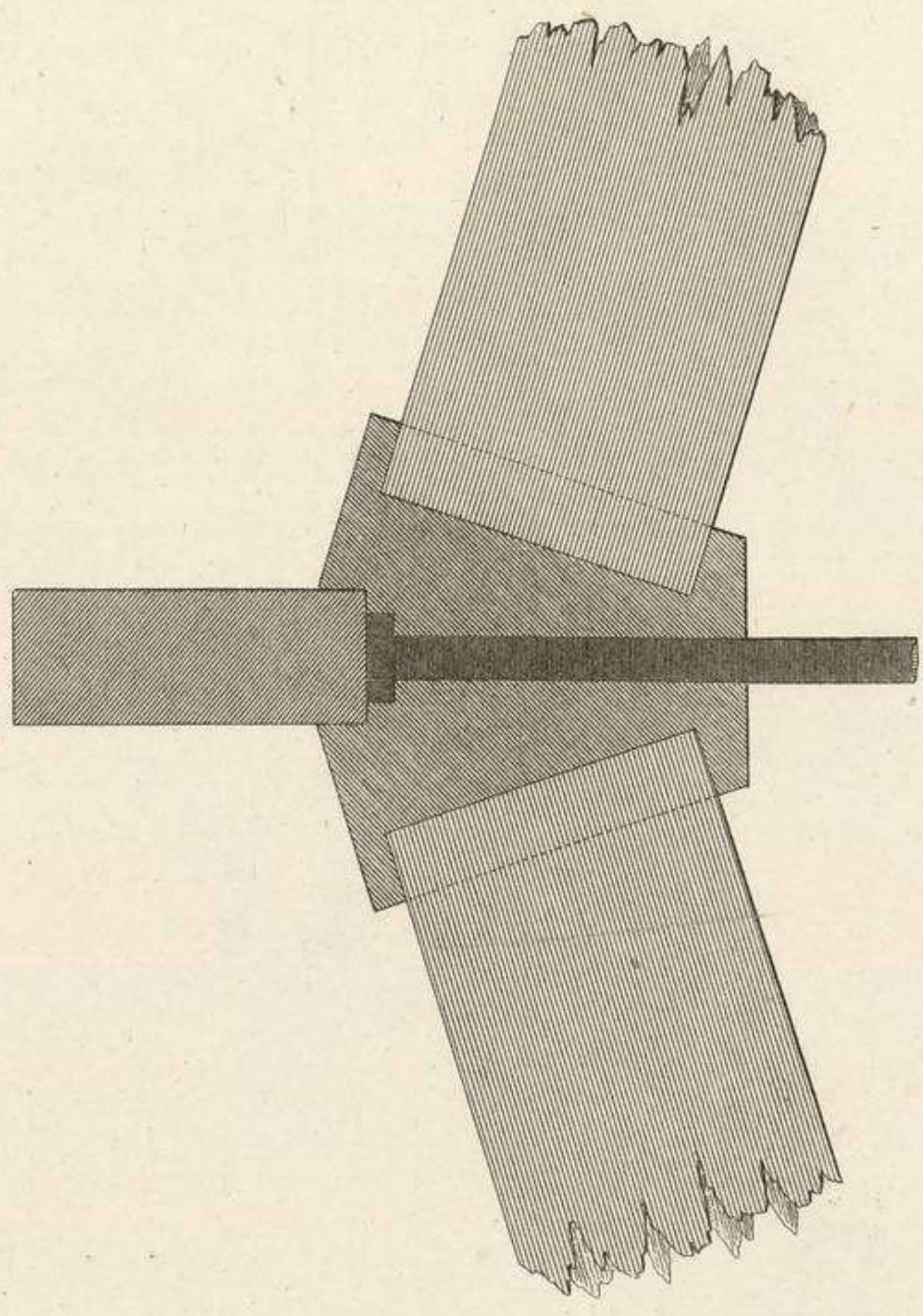
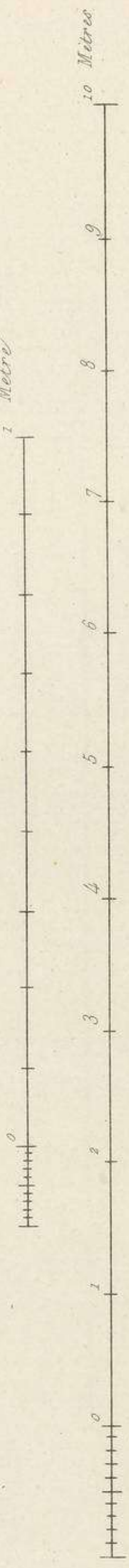

Fig. 5.



Echelle des décaimètres



B. et V. del.

H. R.

CHARPENTE,  
Combinaison du bois et du Fer.



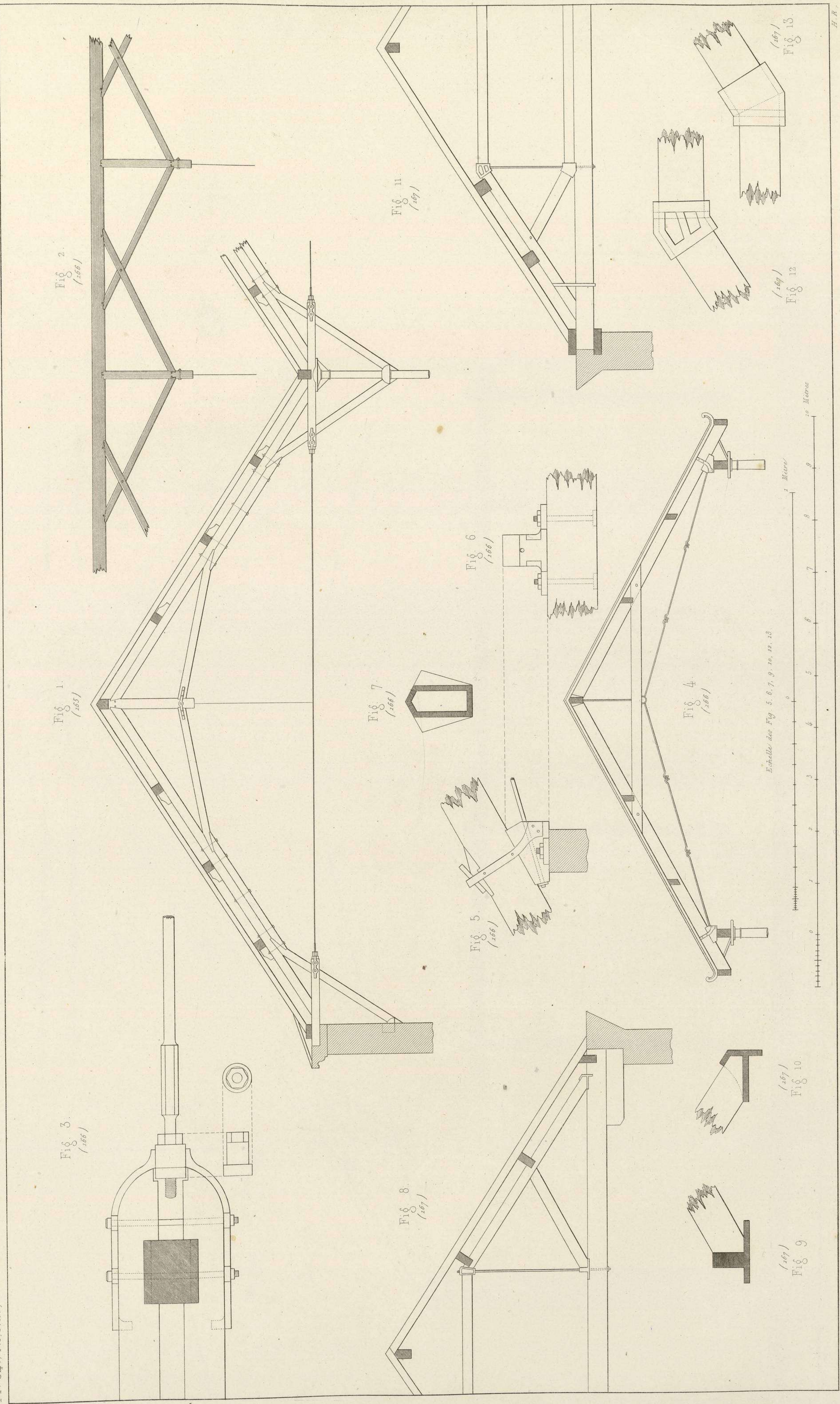

CHARPENTE,  
Combinaison du bois et du Fer.



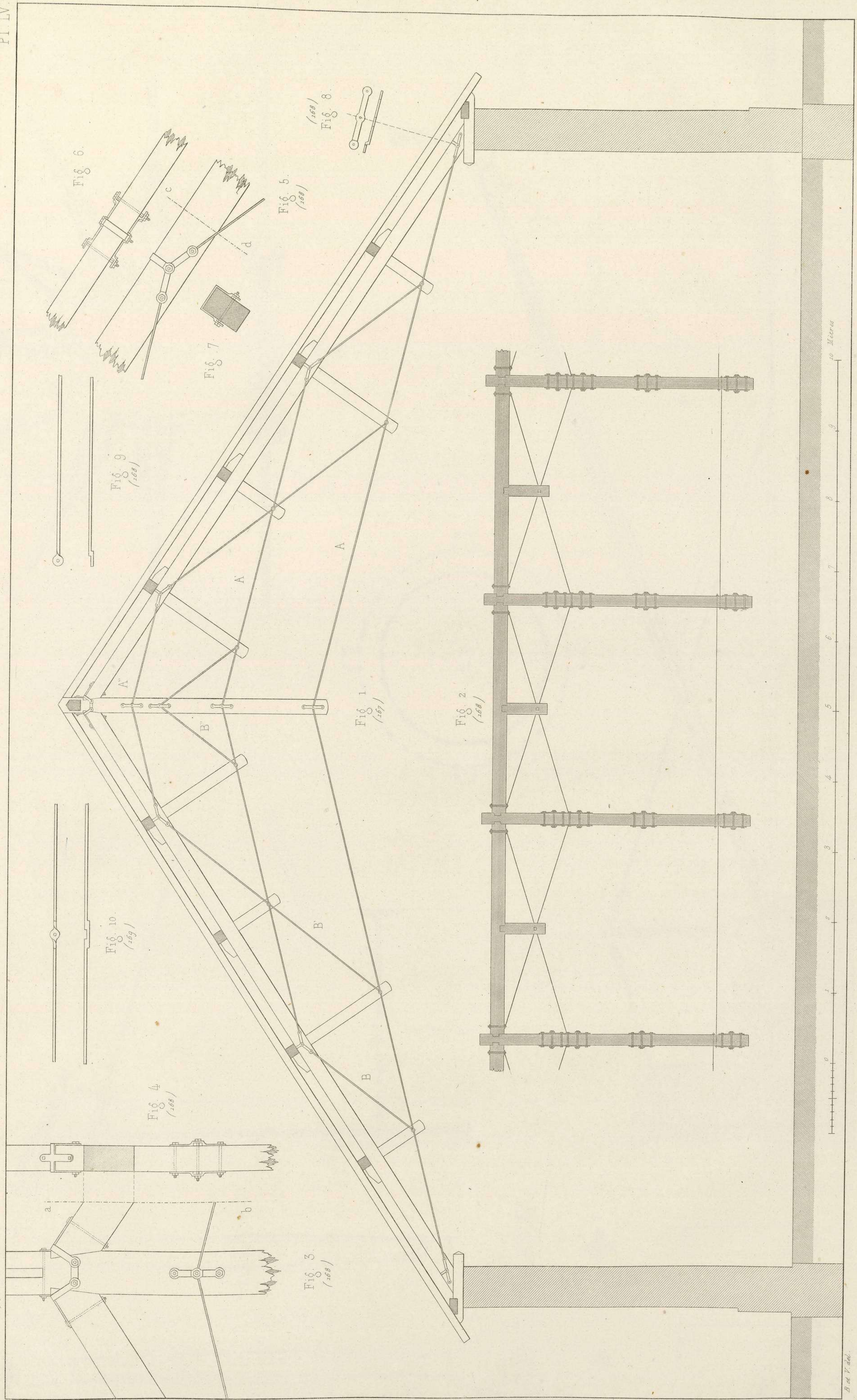

CHARPENTE,  
Combinaison du bois et du Fer.



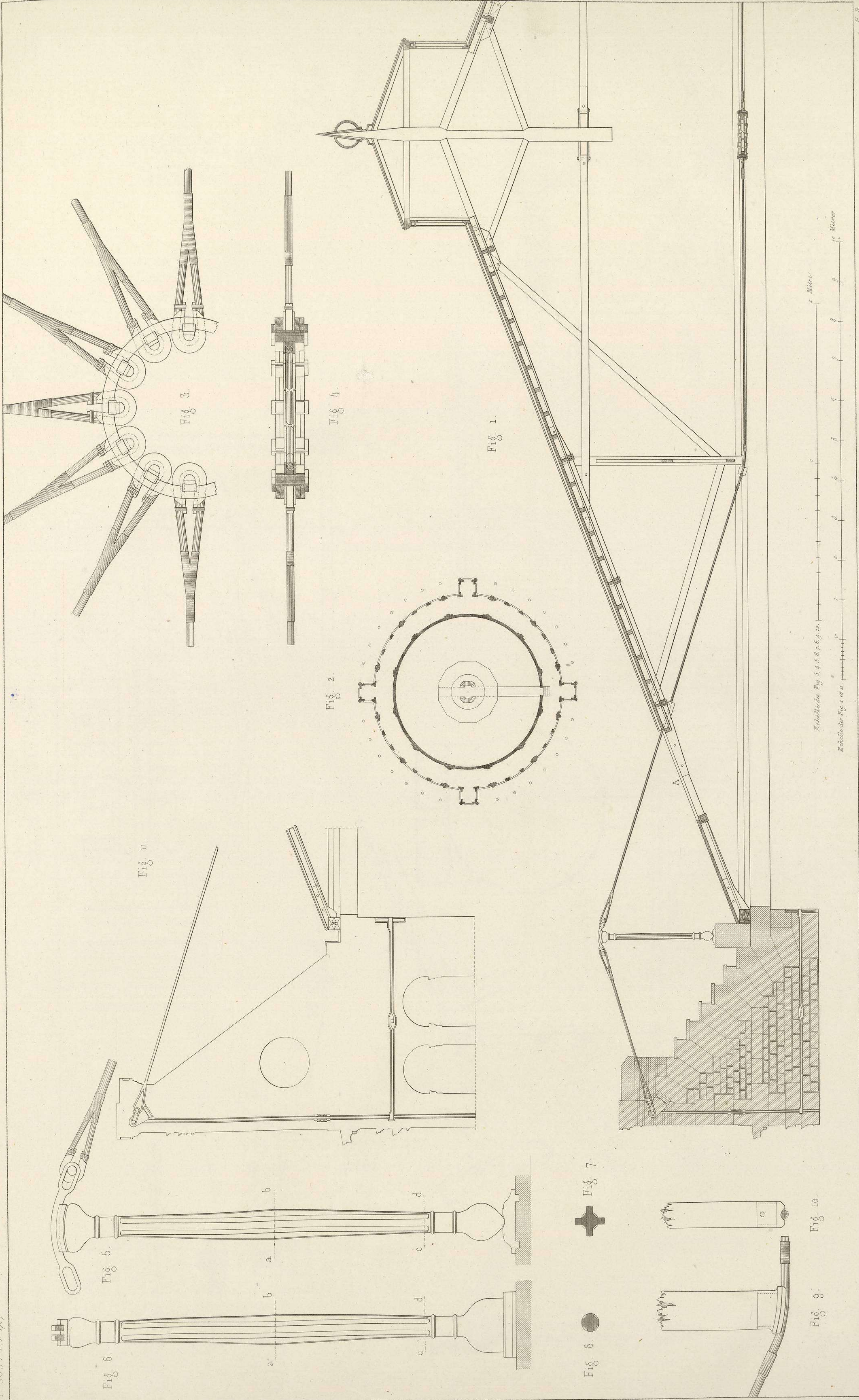

CHARPENTE, Comble suspendu.

B. de V. del.

H. R.



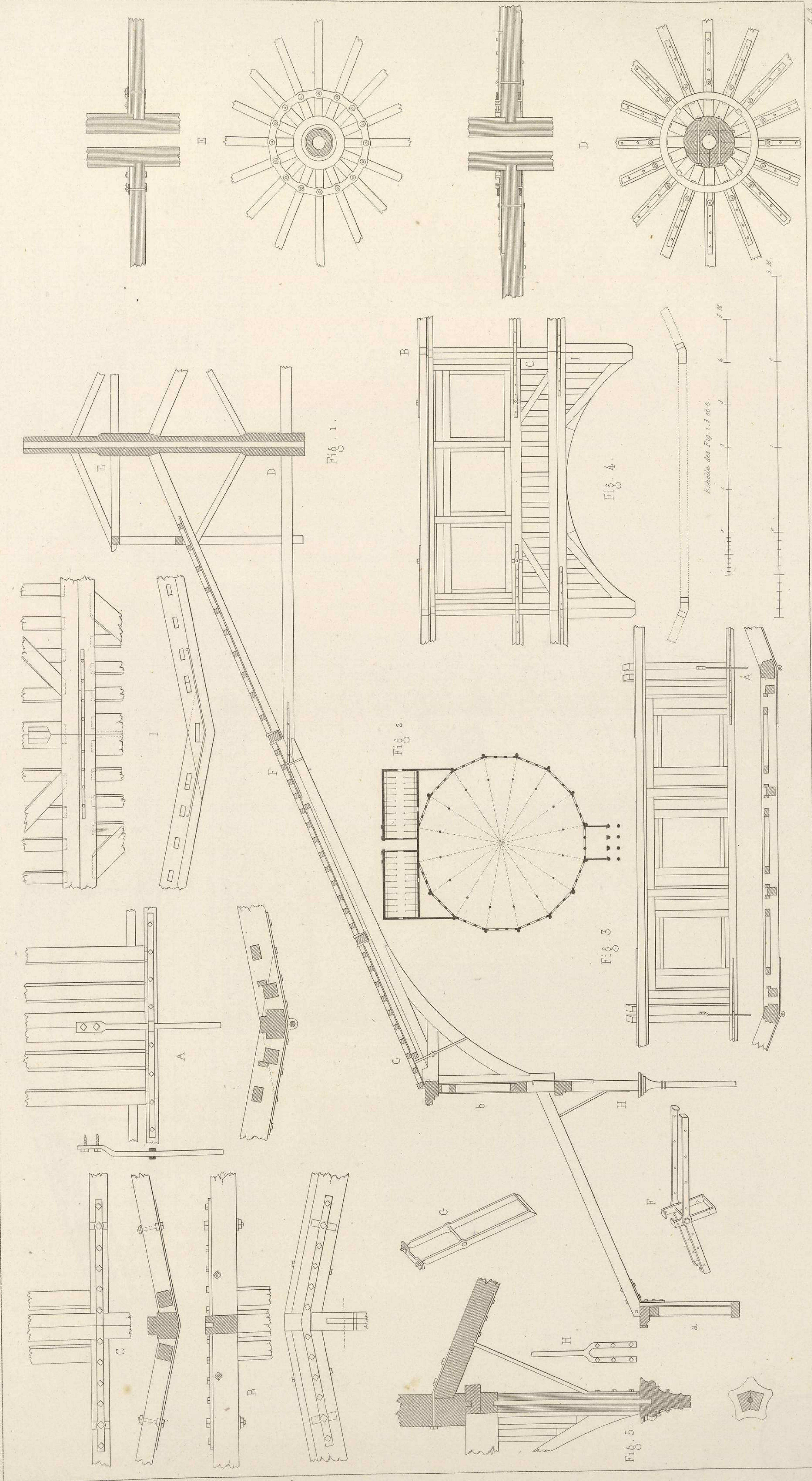

CHARPENTE.  
Bois apparents formant décoration.

3 de 17.262

H. R.



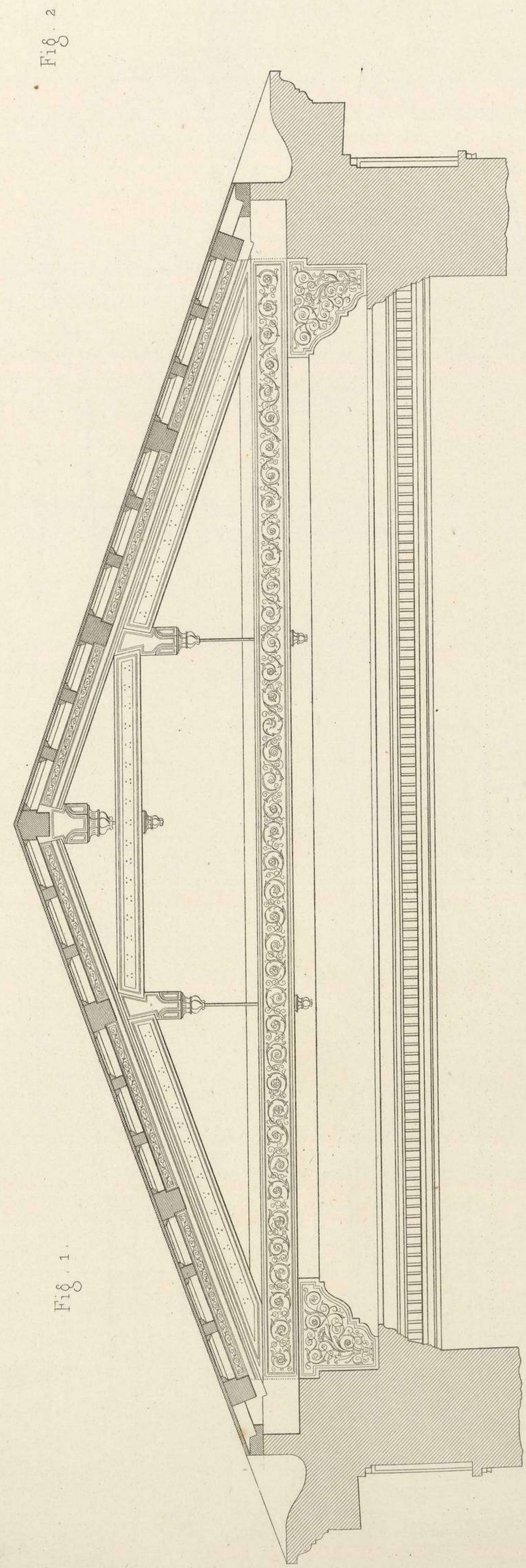

Fig. 1.

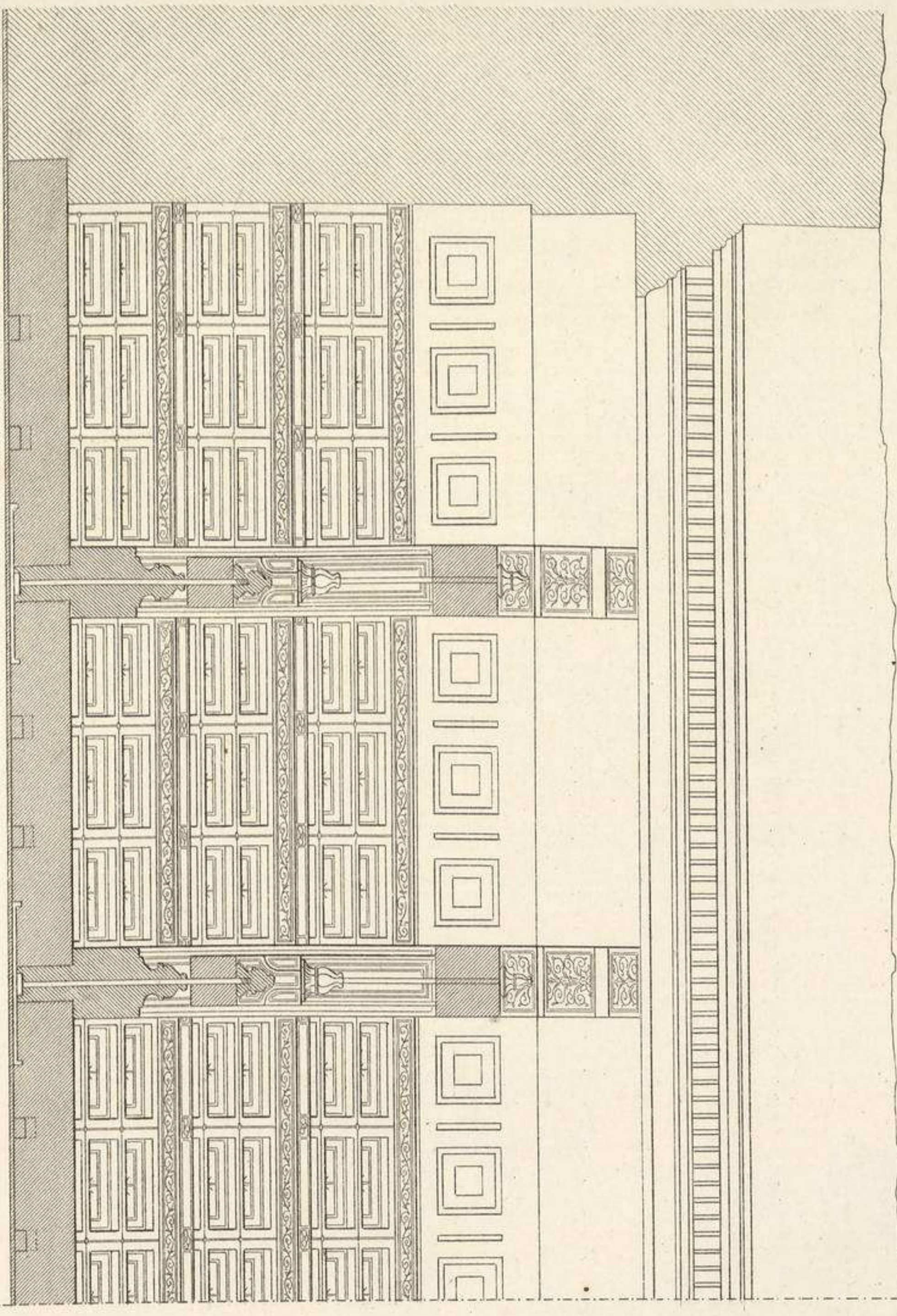

Fig. 2.

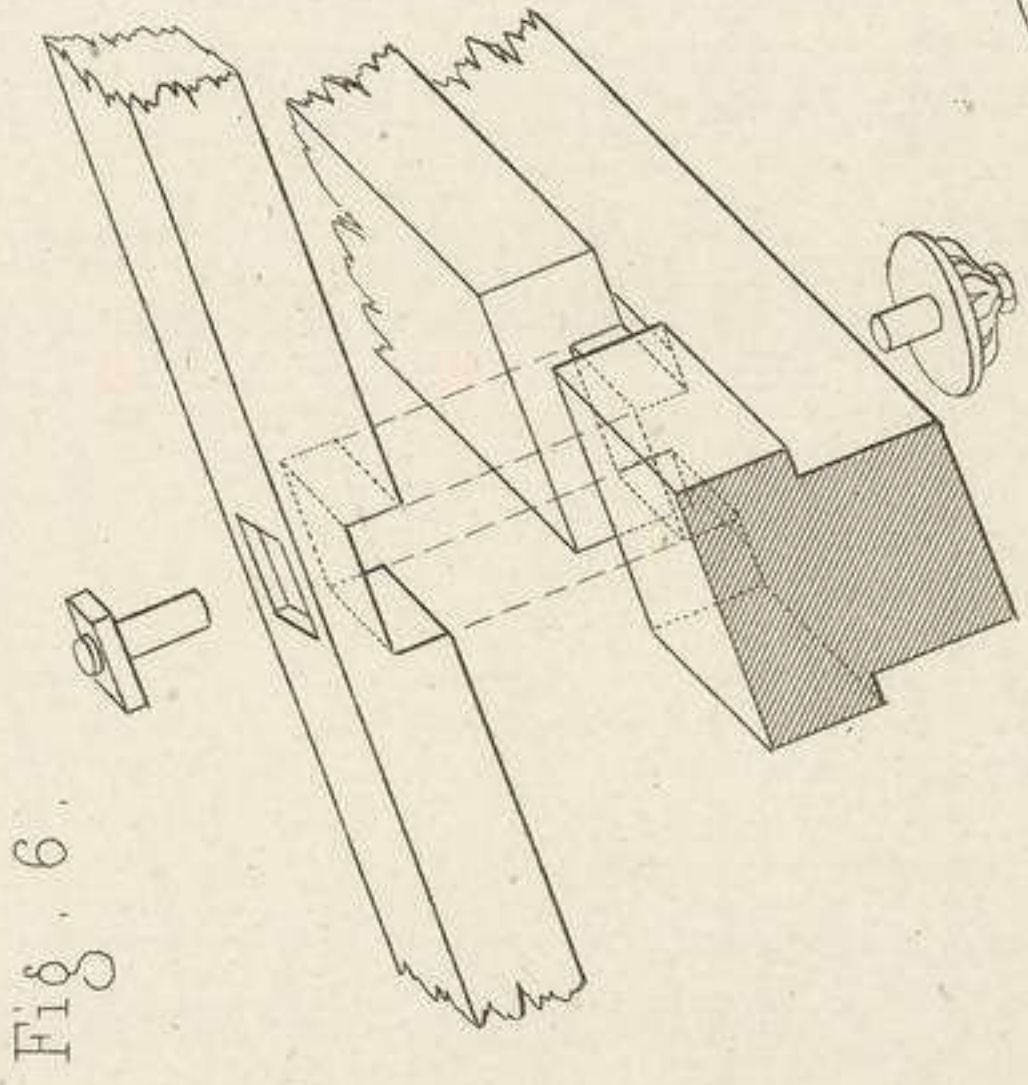

Fig. 6.

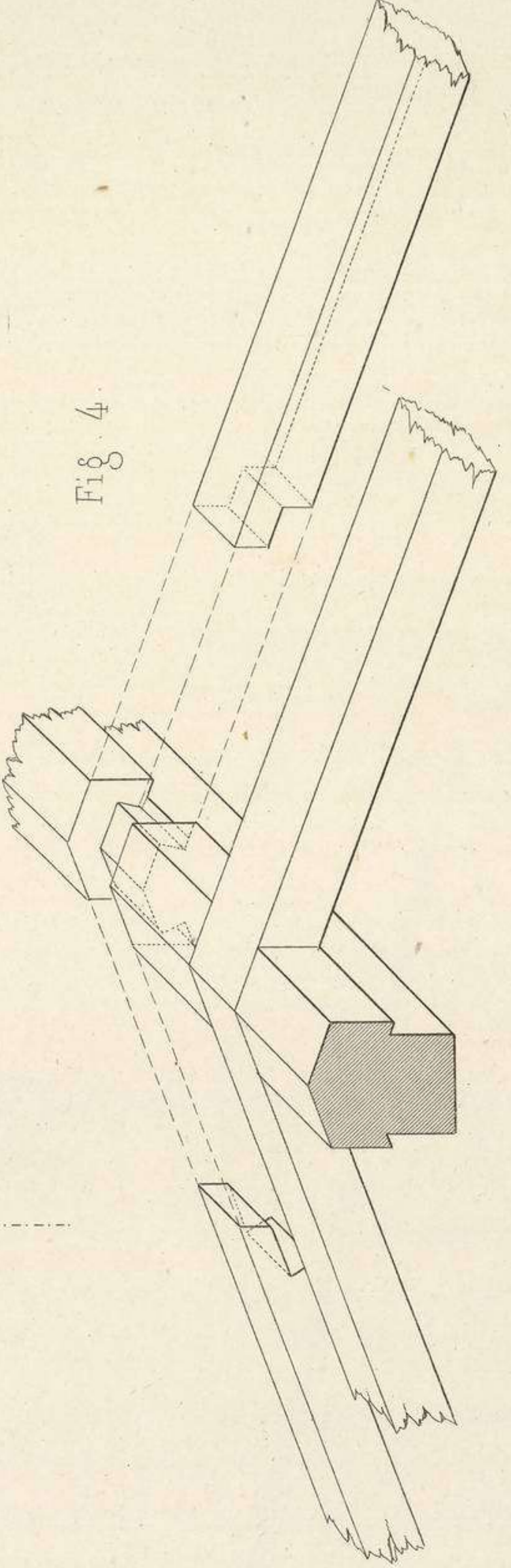

Fig. 4.

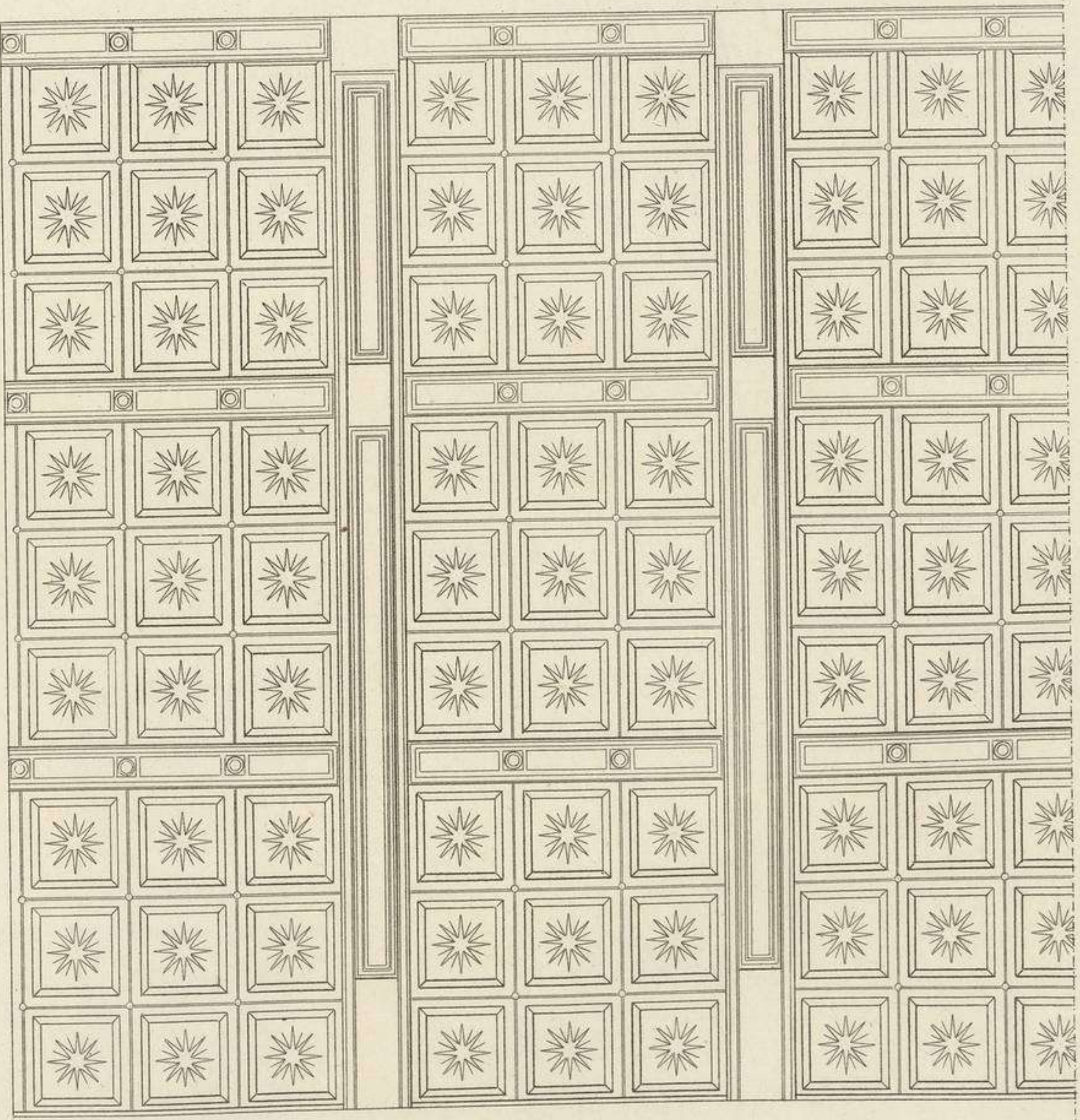

Fig. 3.

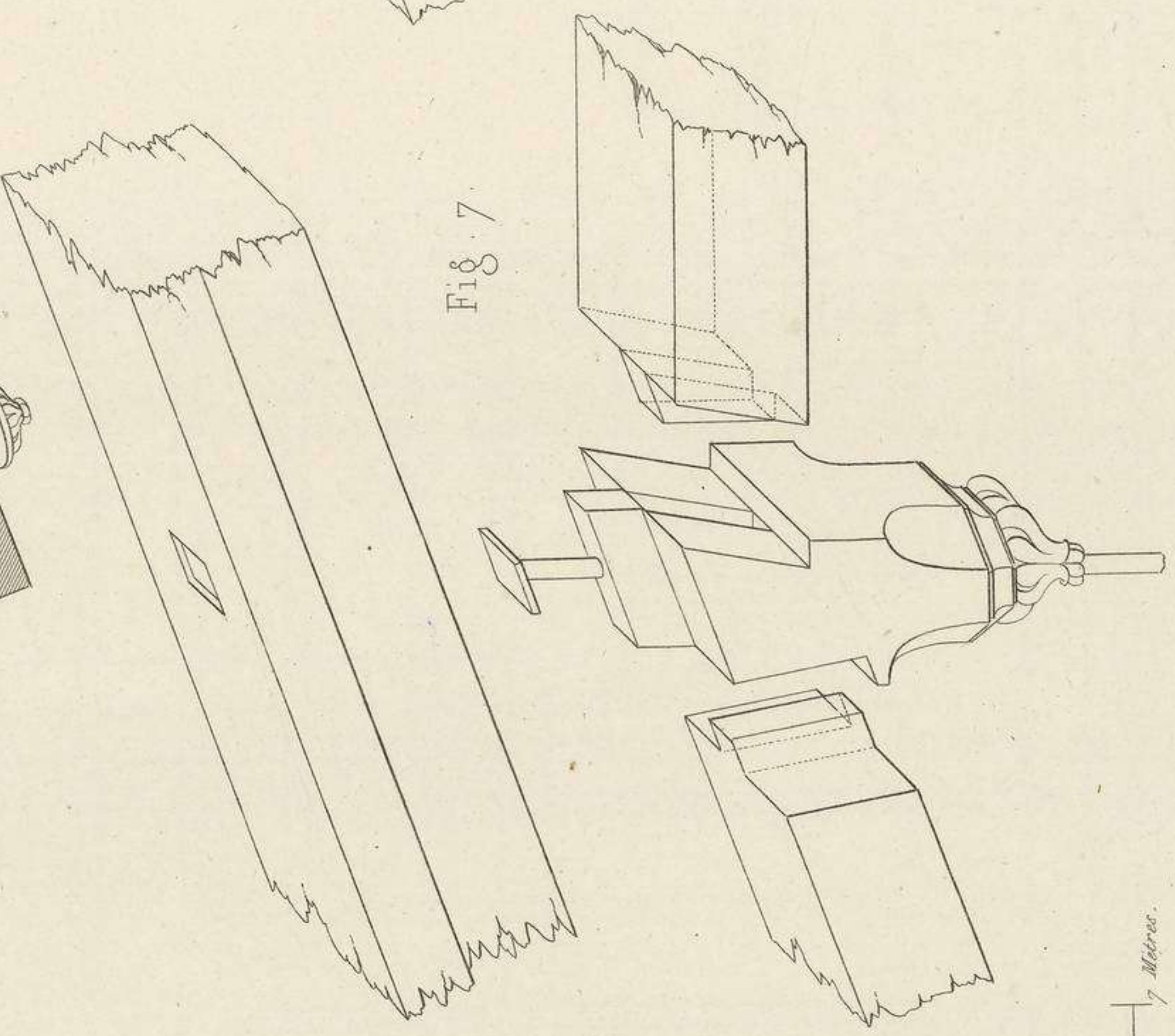

Fig. 7.

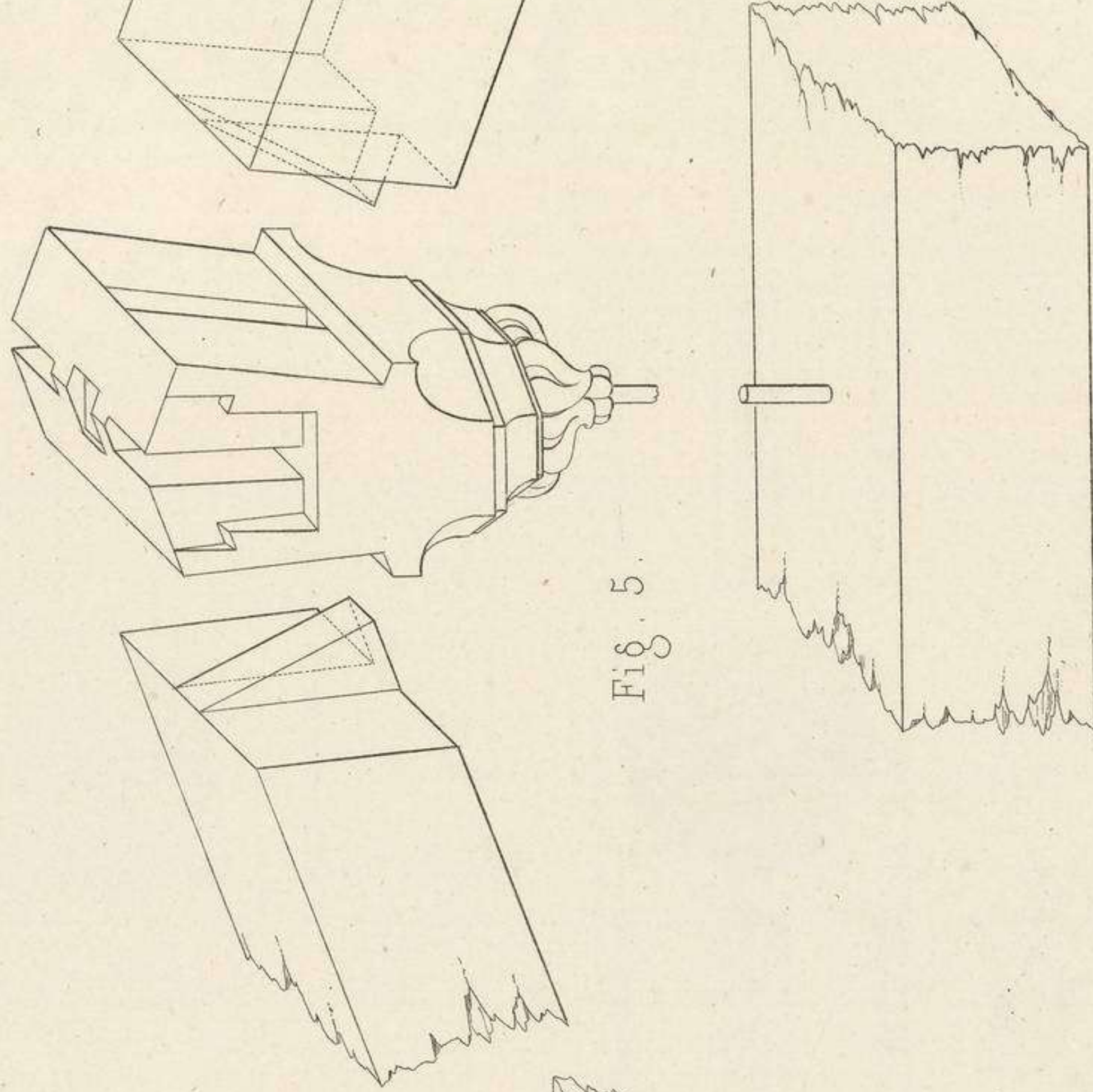

Fig. 5.

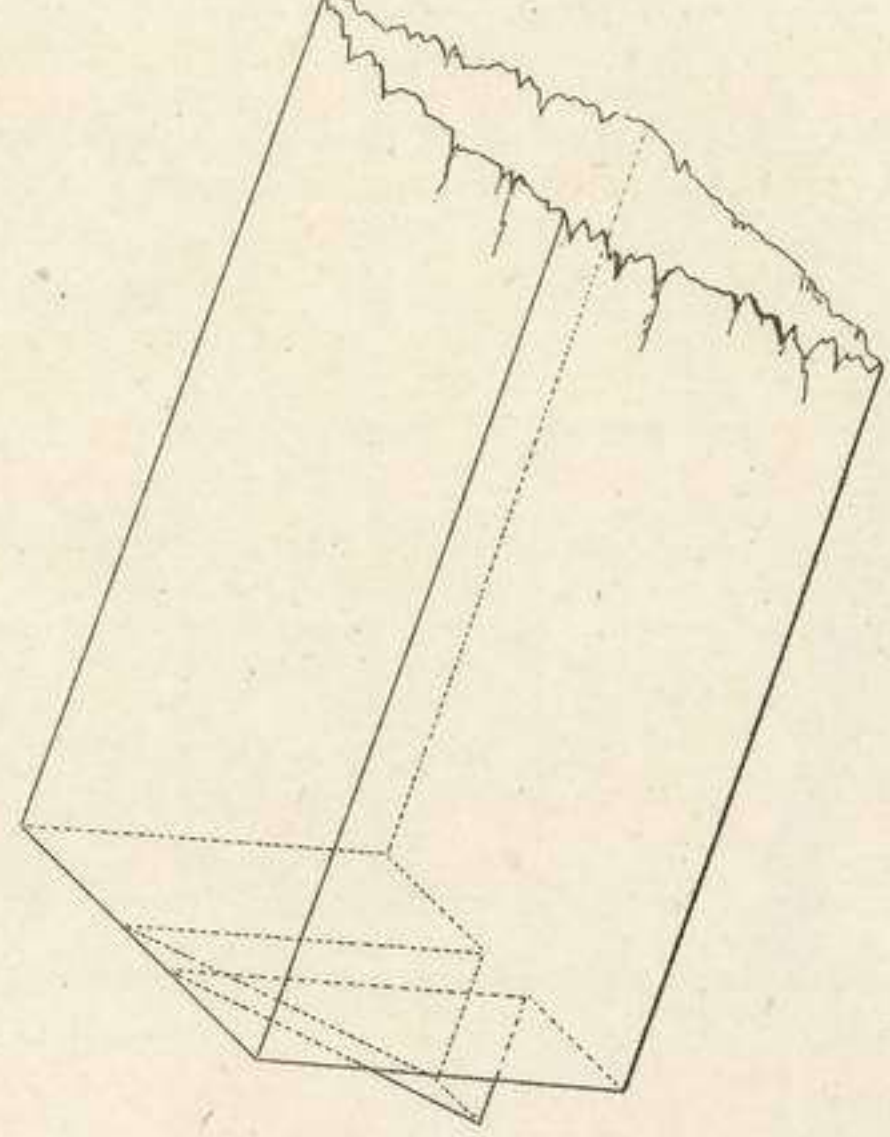
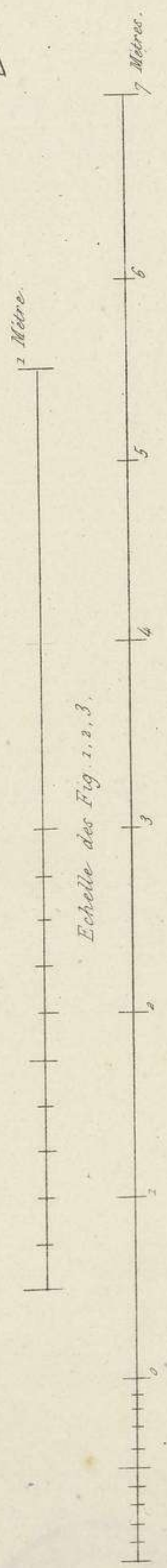

Fig. 8.



B. et P. del.

CHARPENTE.  
Bois apparents formant décoration.

H. R.



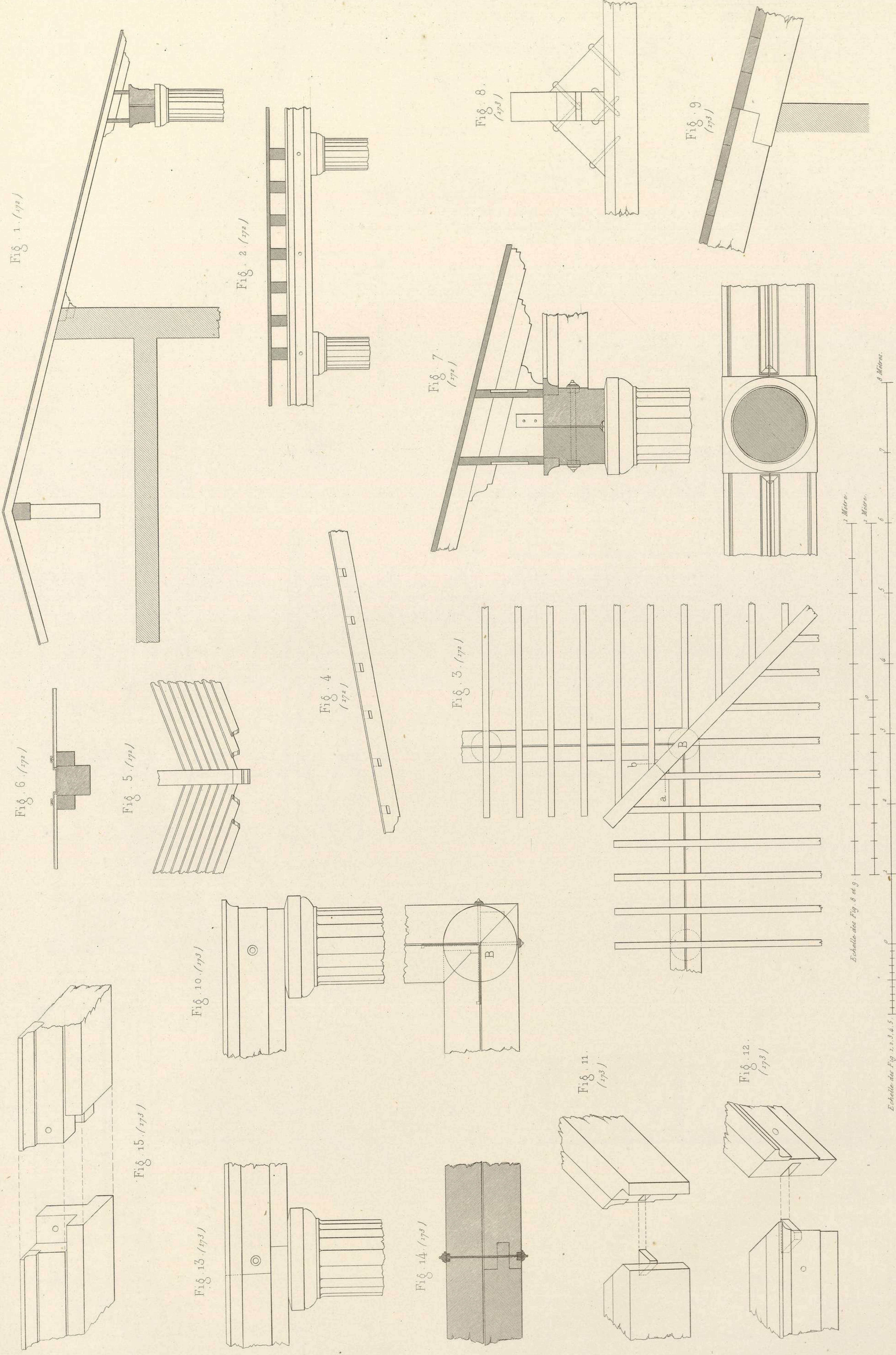

CHARPENTE.  
Bois apparents formant décoration.

B et V del.

H. B.



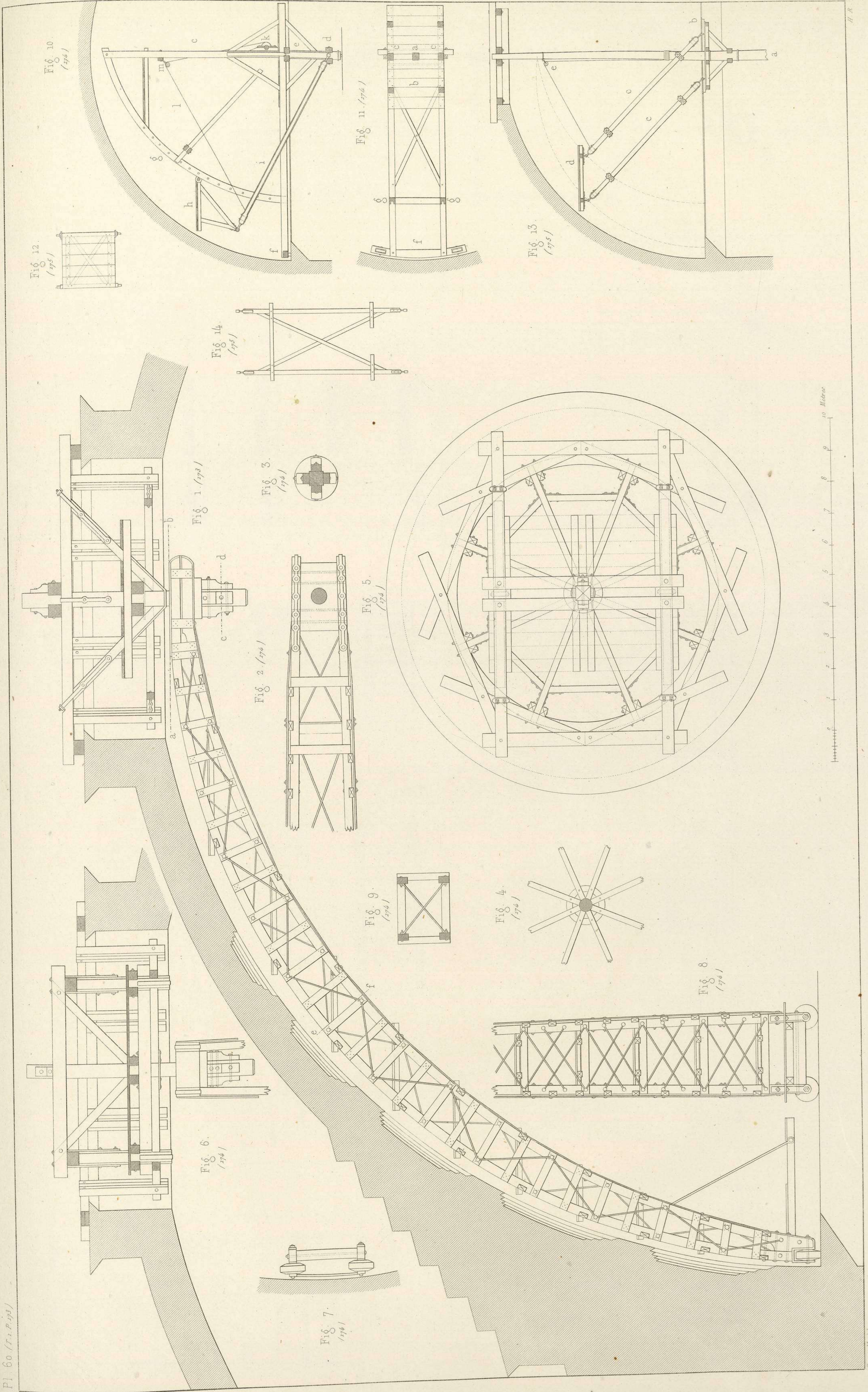

CHARPENTE,  
Echafauds mobiles.



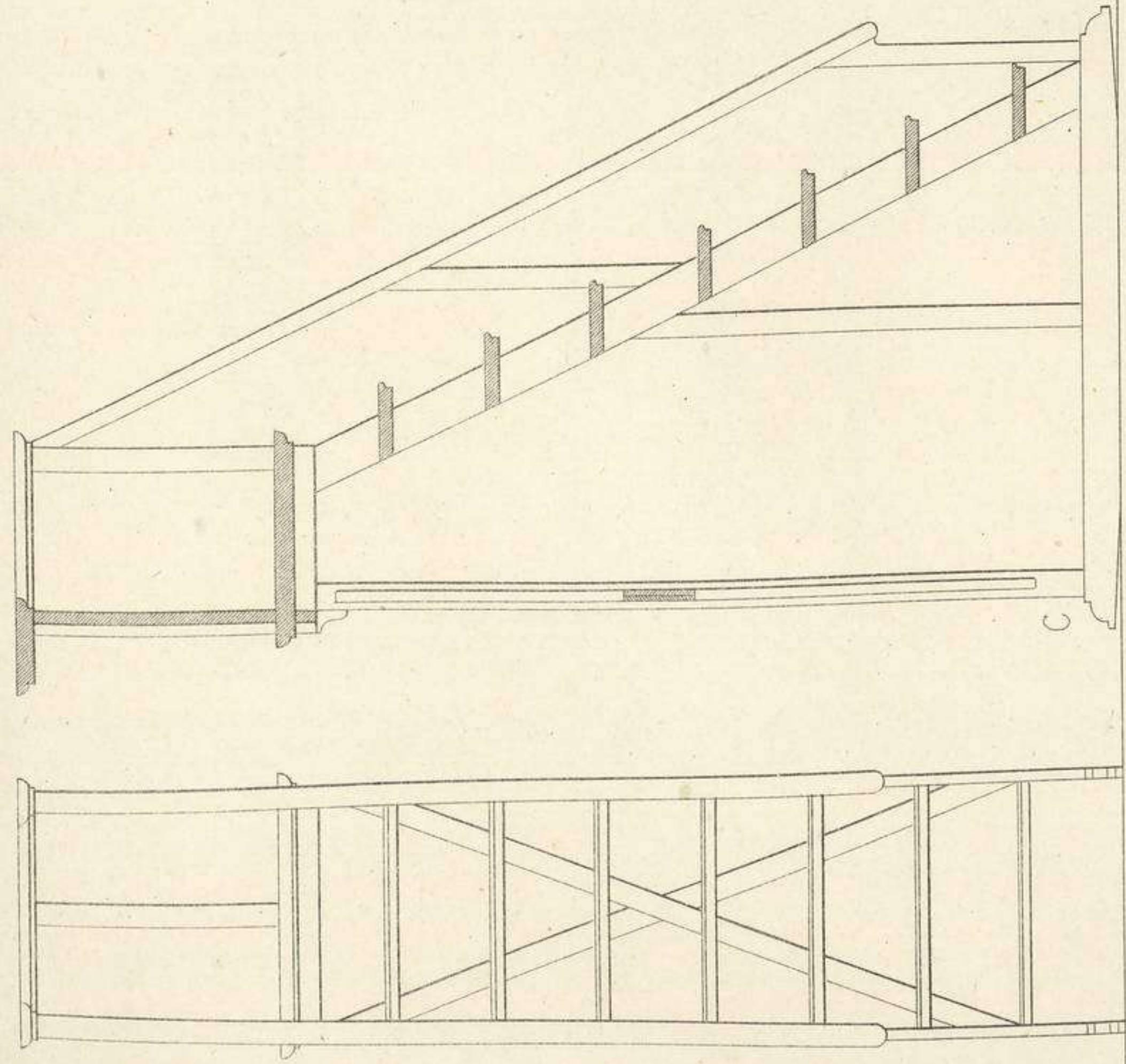

Fig. 1.

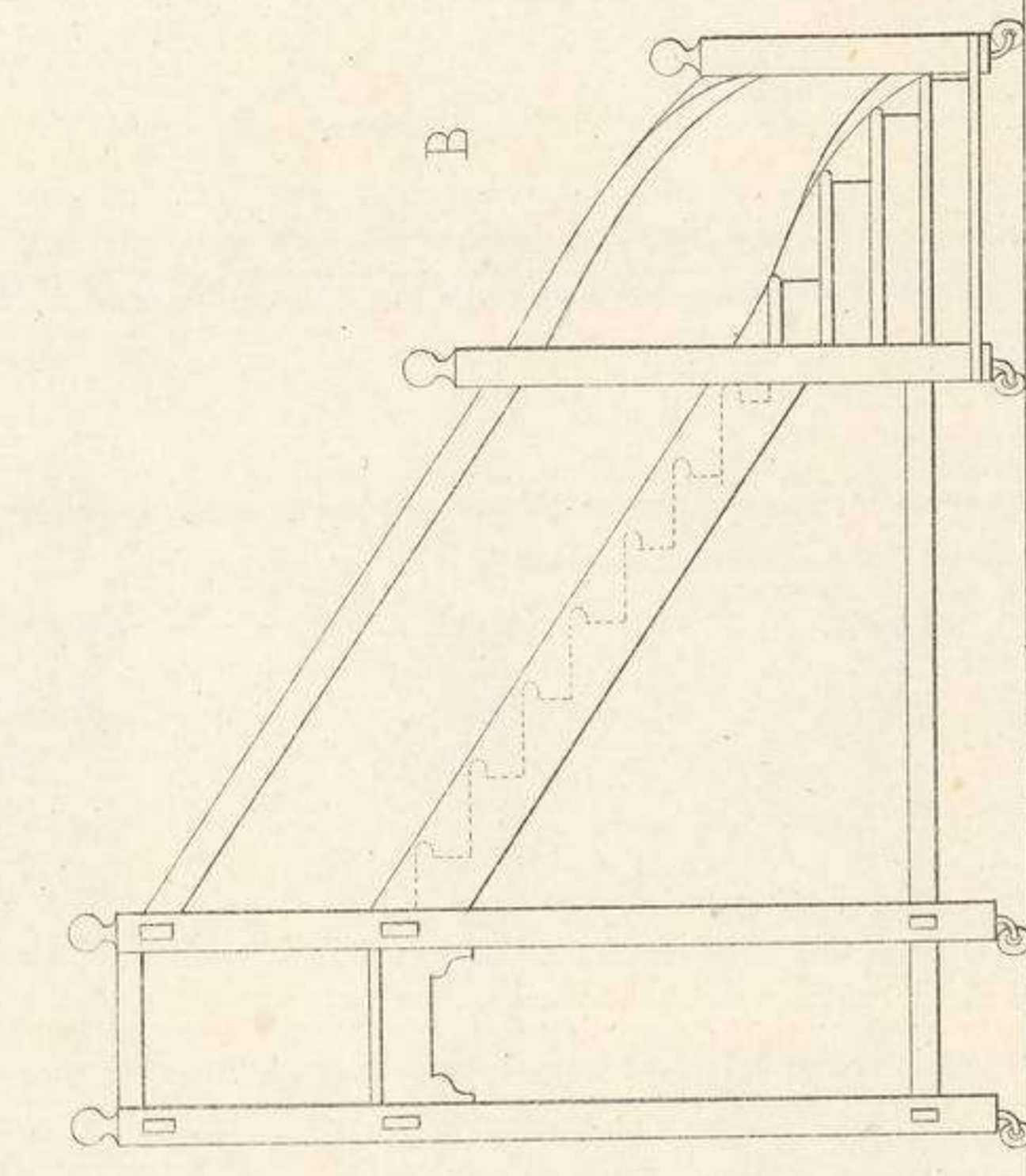
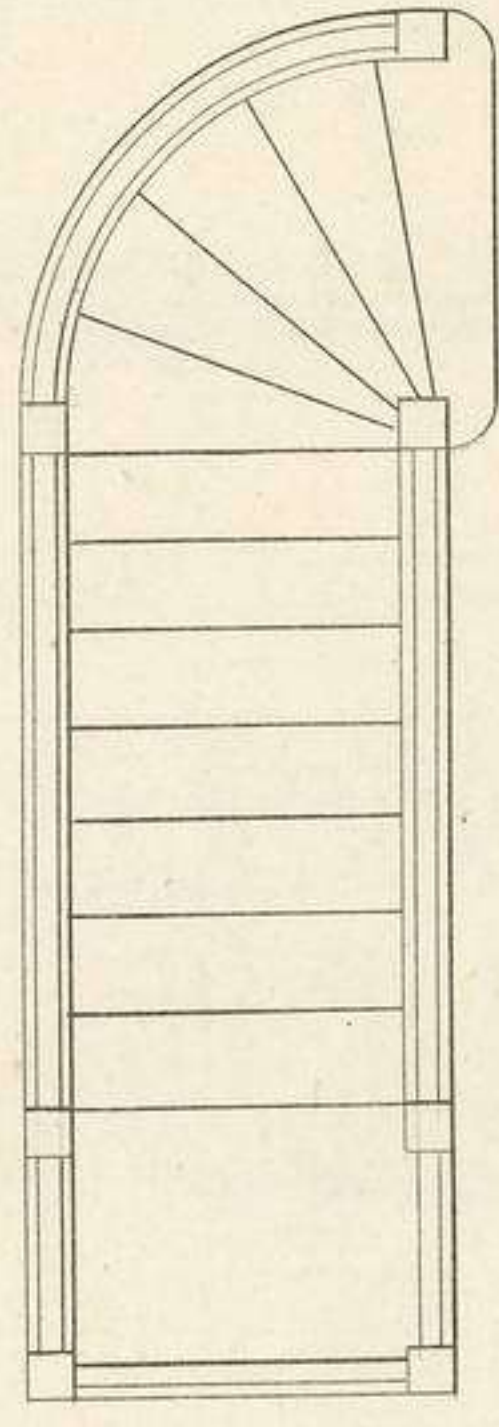

Fig. 2.



A

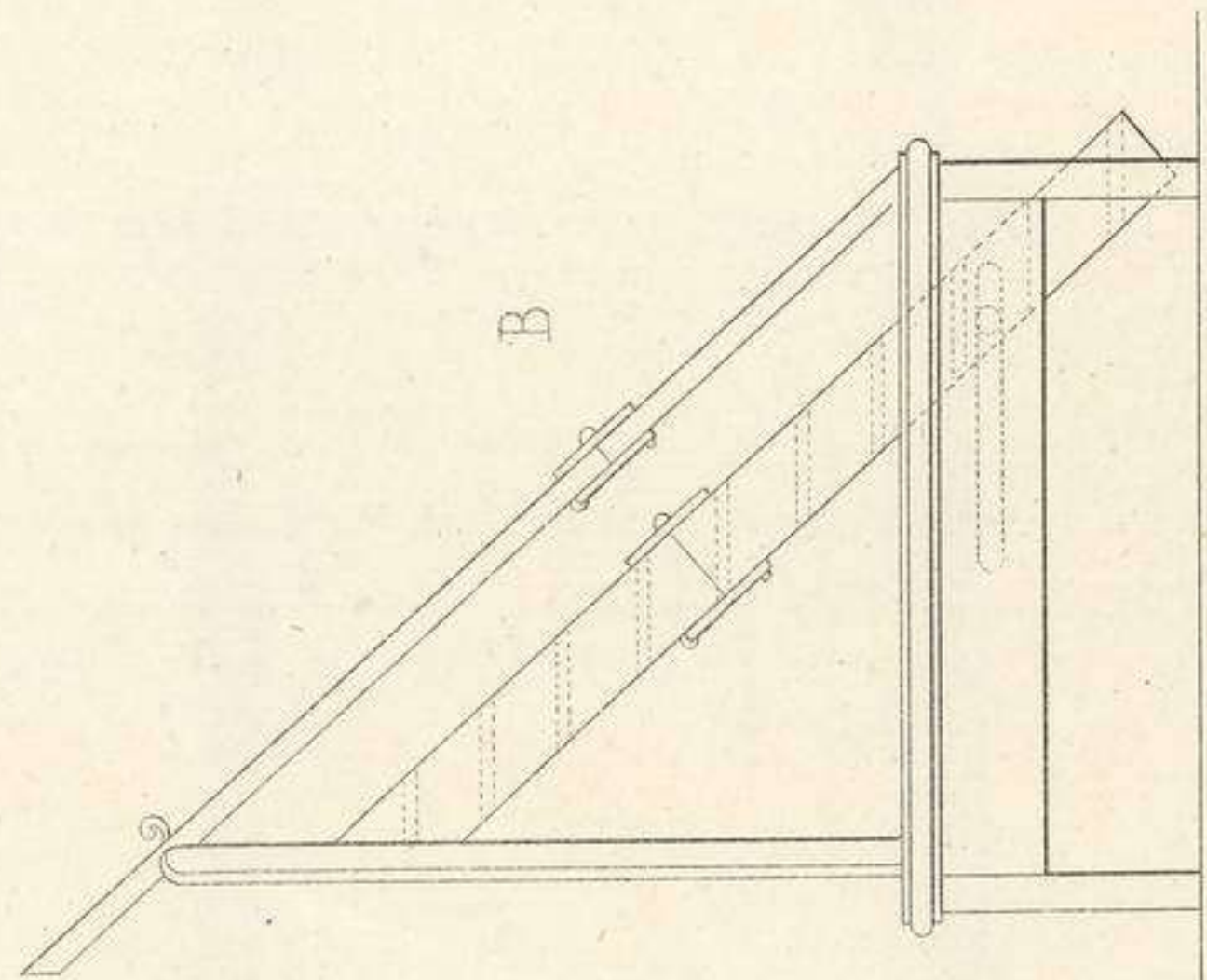
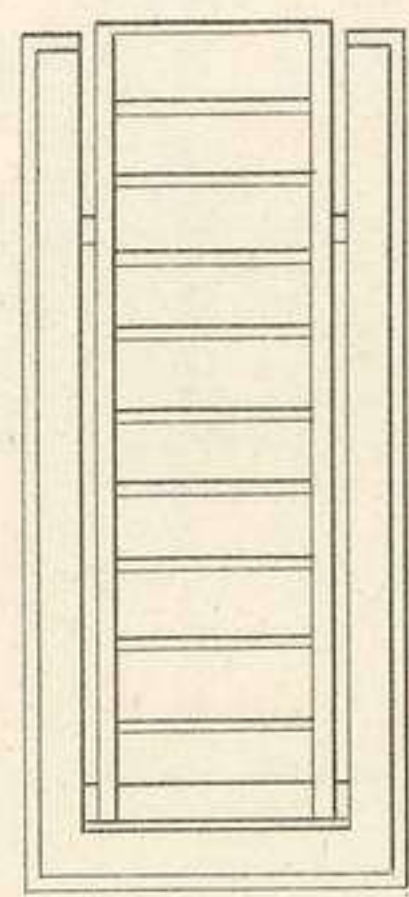

Fig. 3.



A

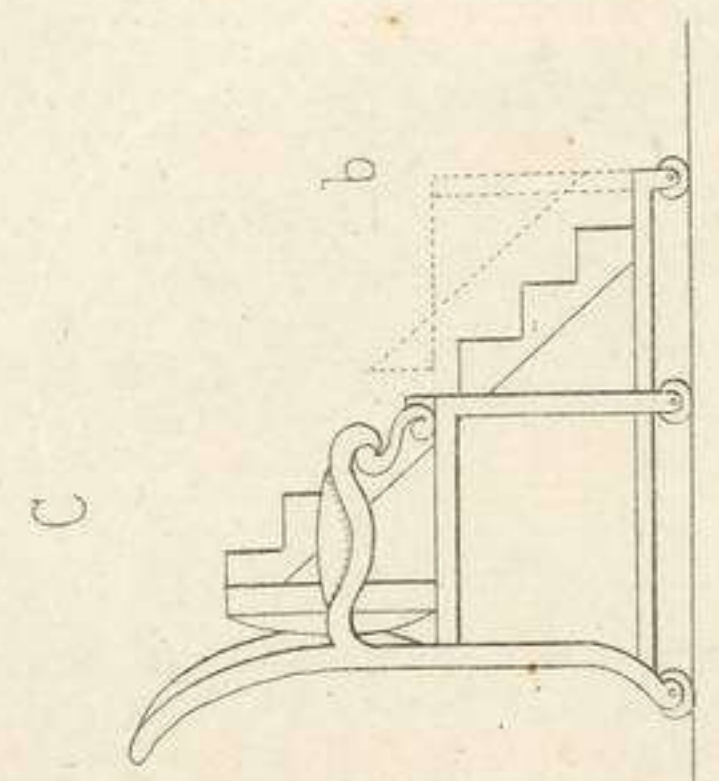
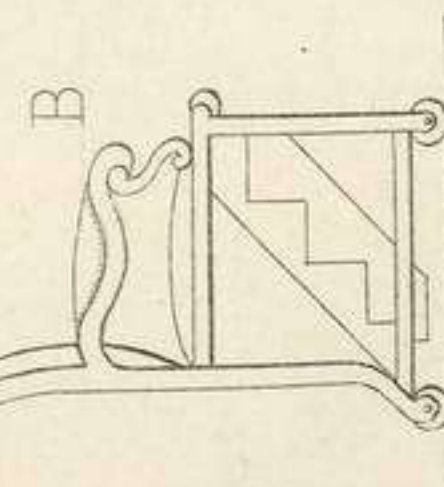

Fig. 4.



A

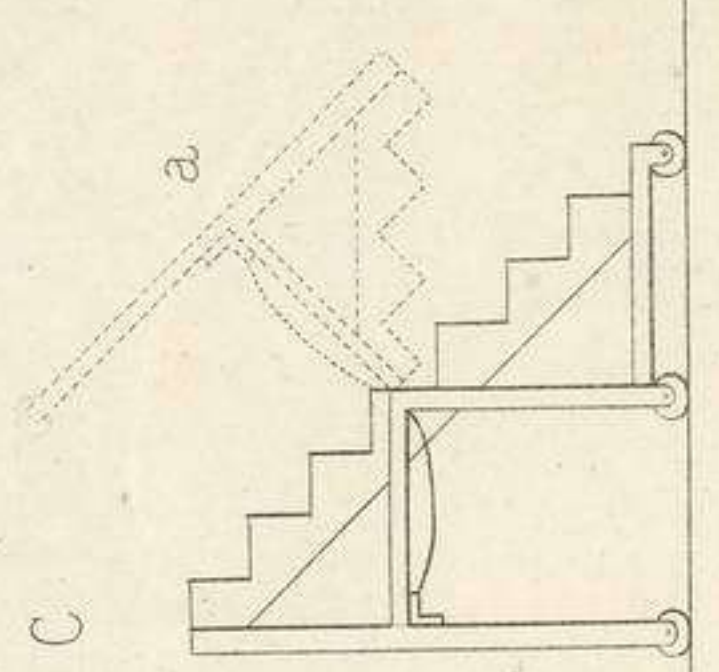
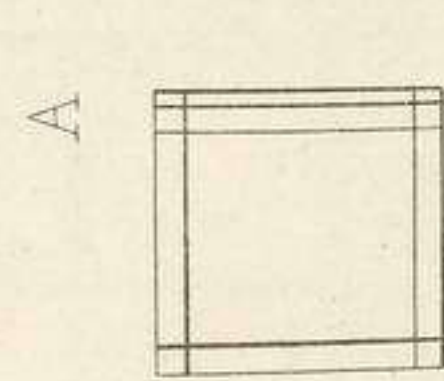

Fig. 5.



A

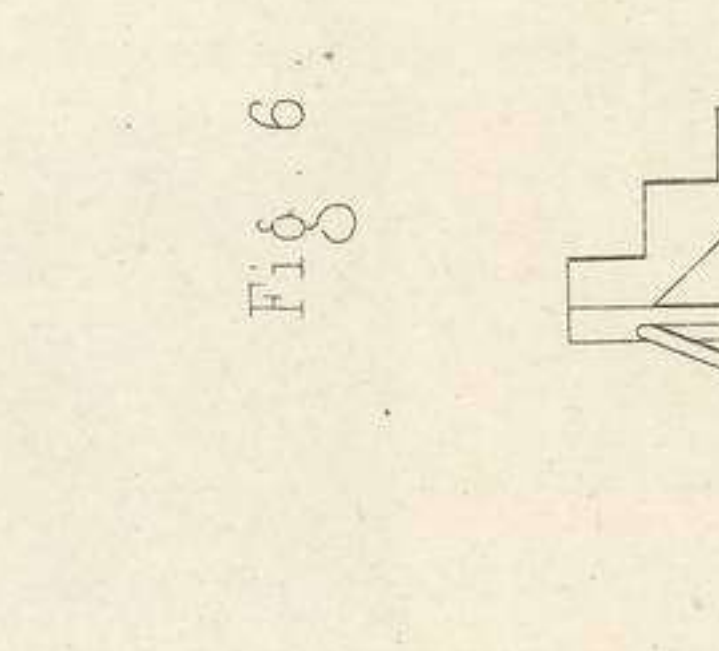

Fig. 6.

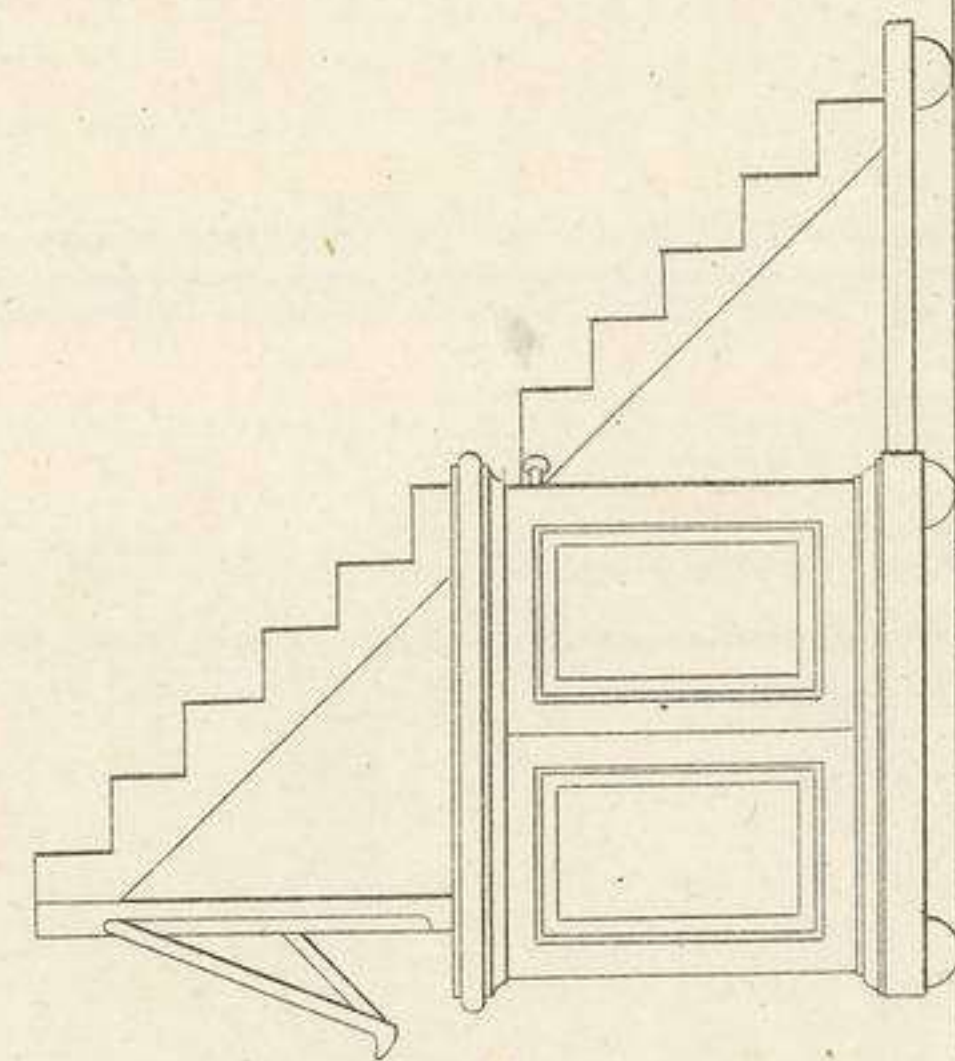

Fig. 7.

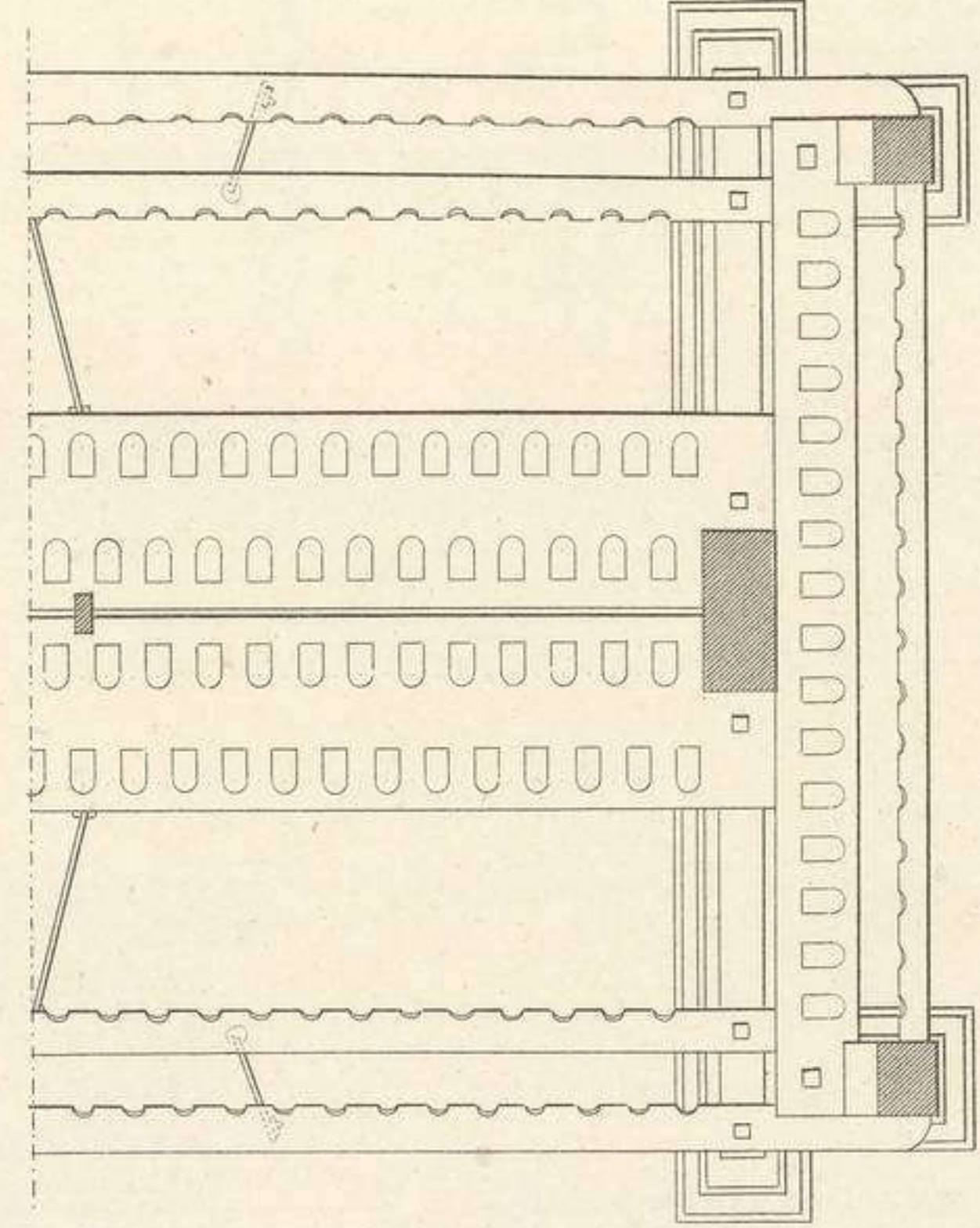
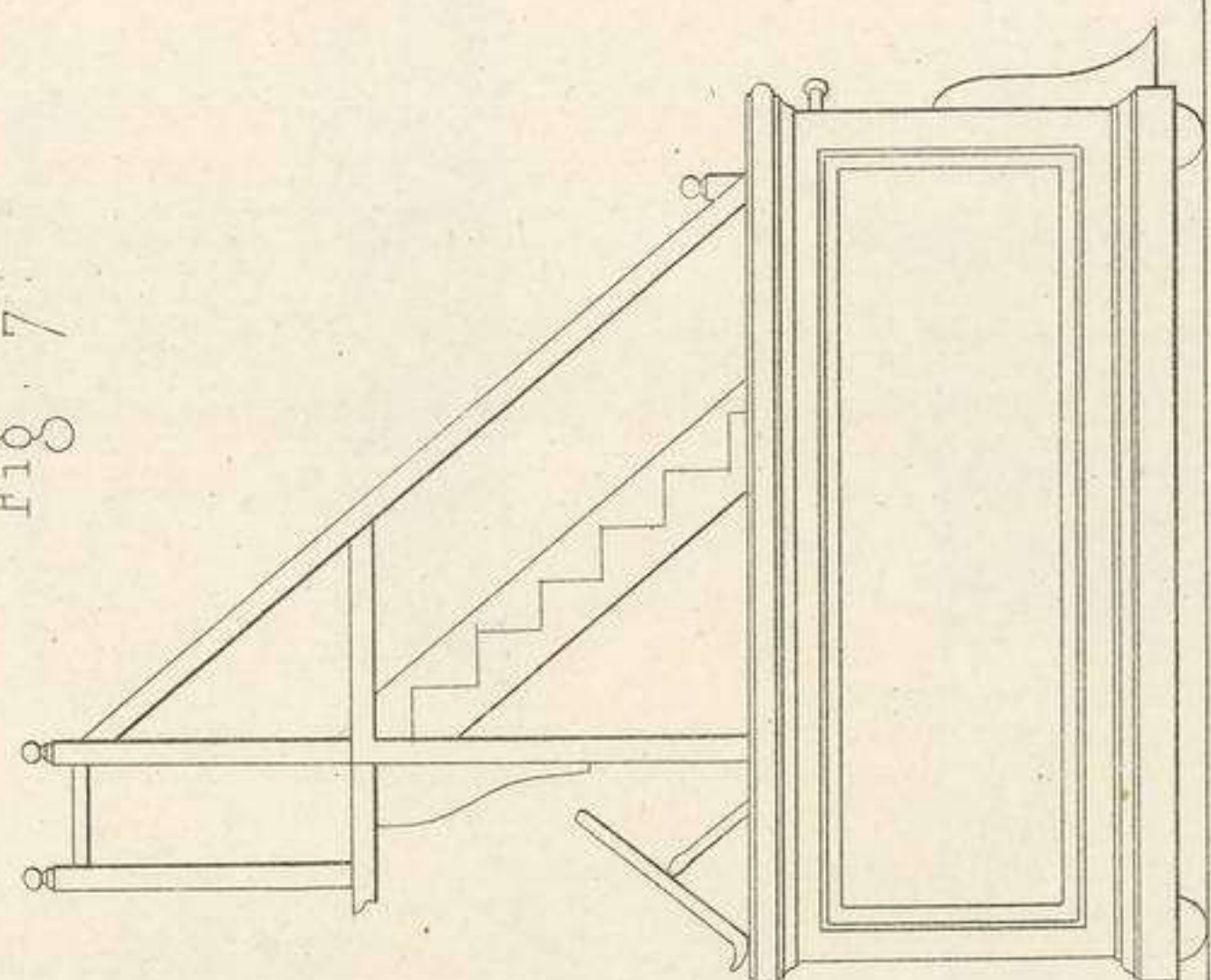

Fig. 8.

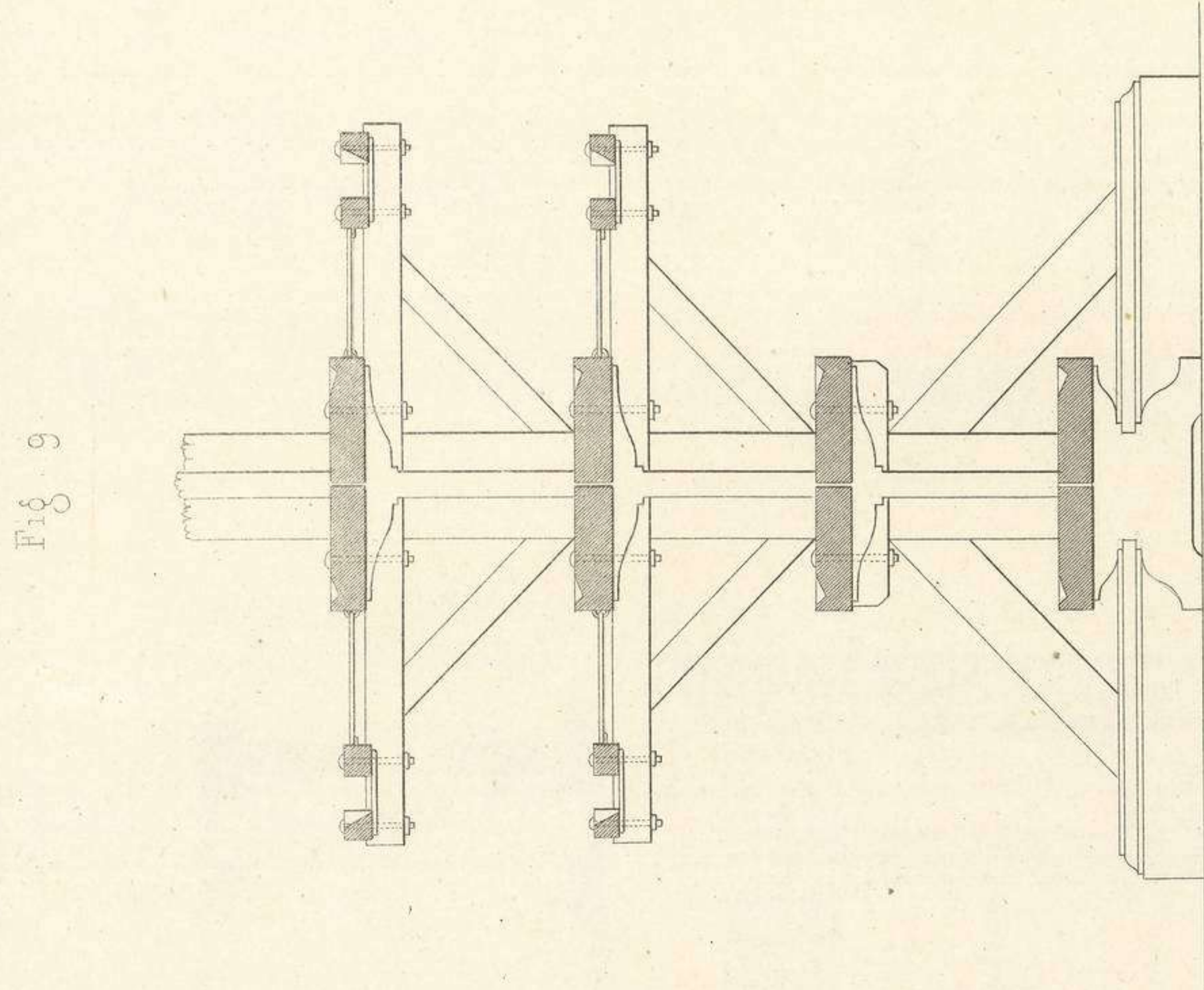

Fig. 9.

Fig. 10.

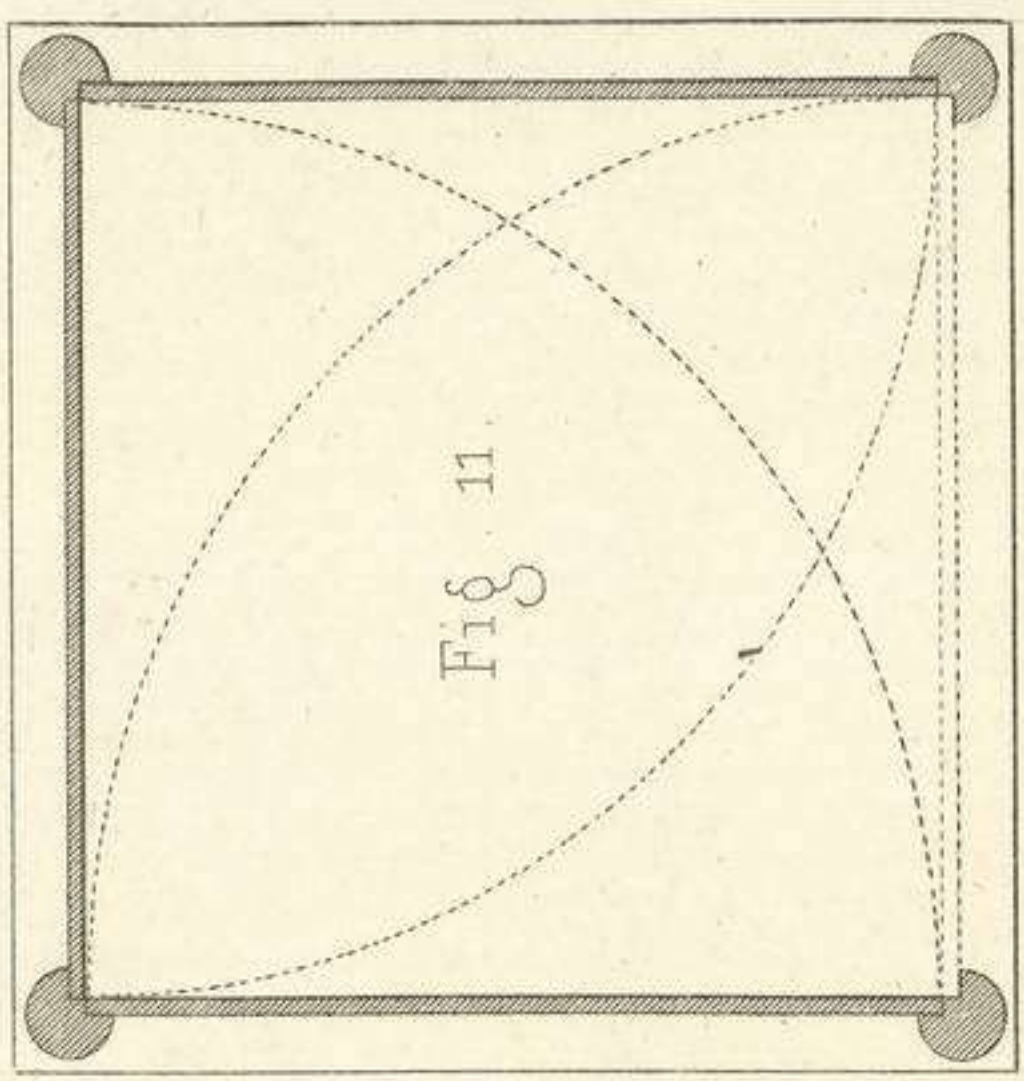
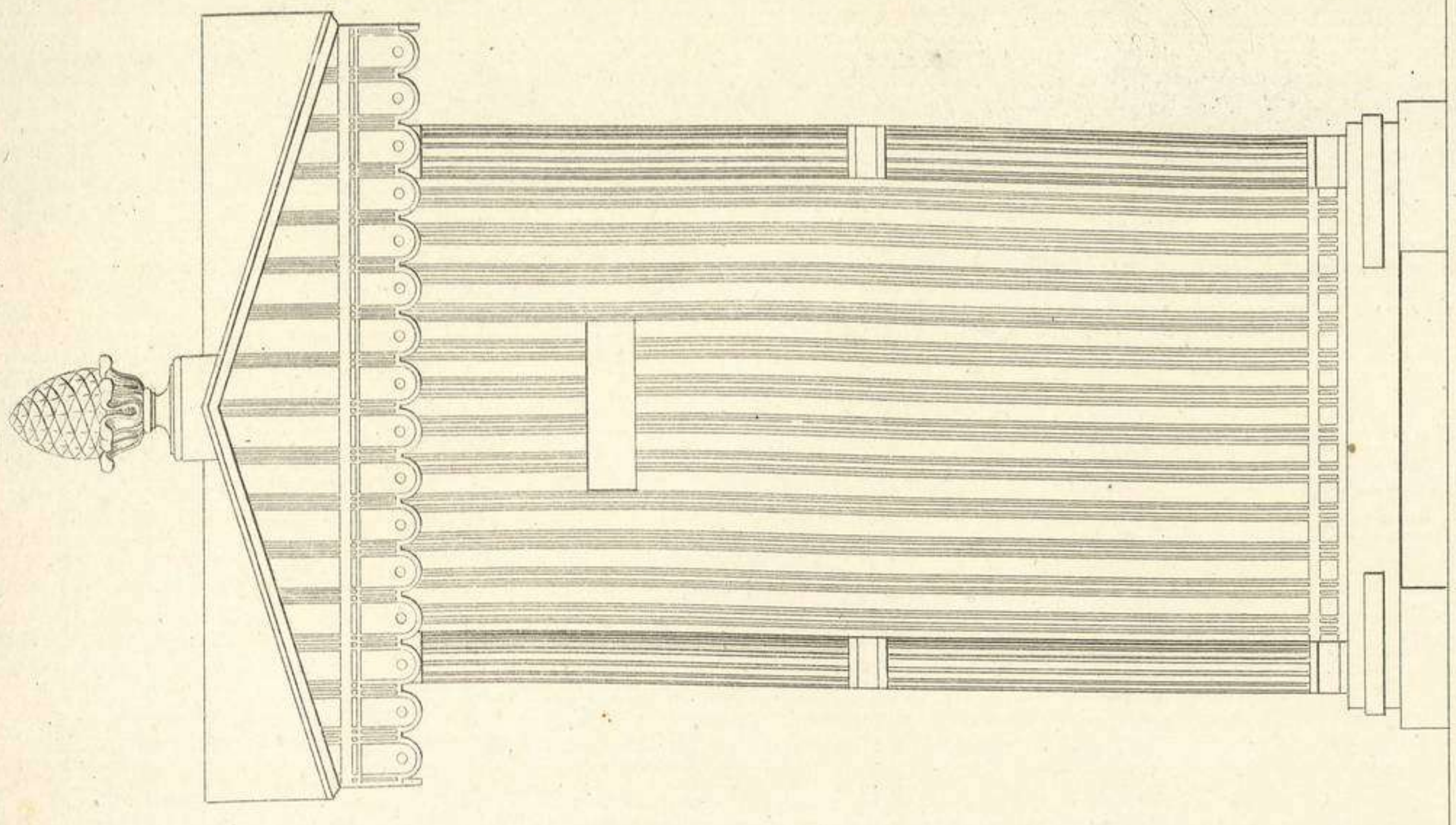

Fig. 11.

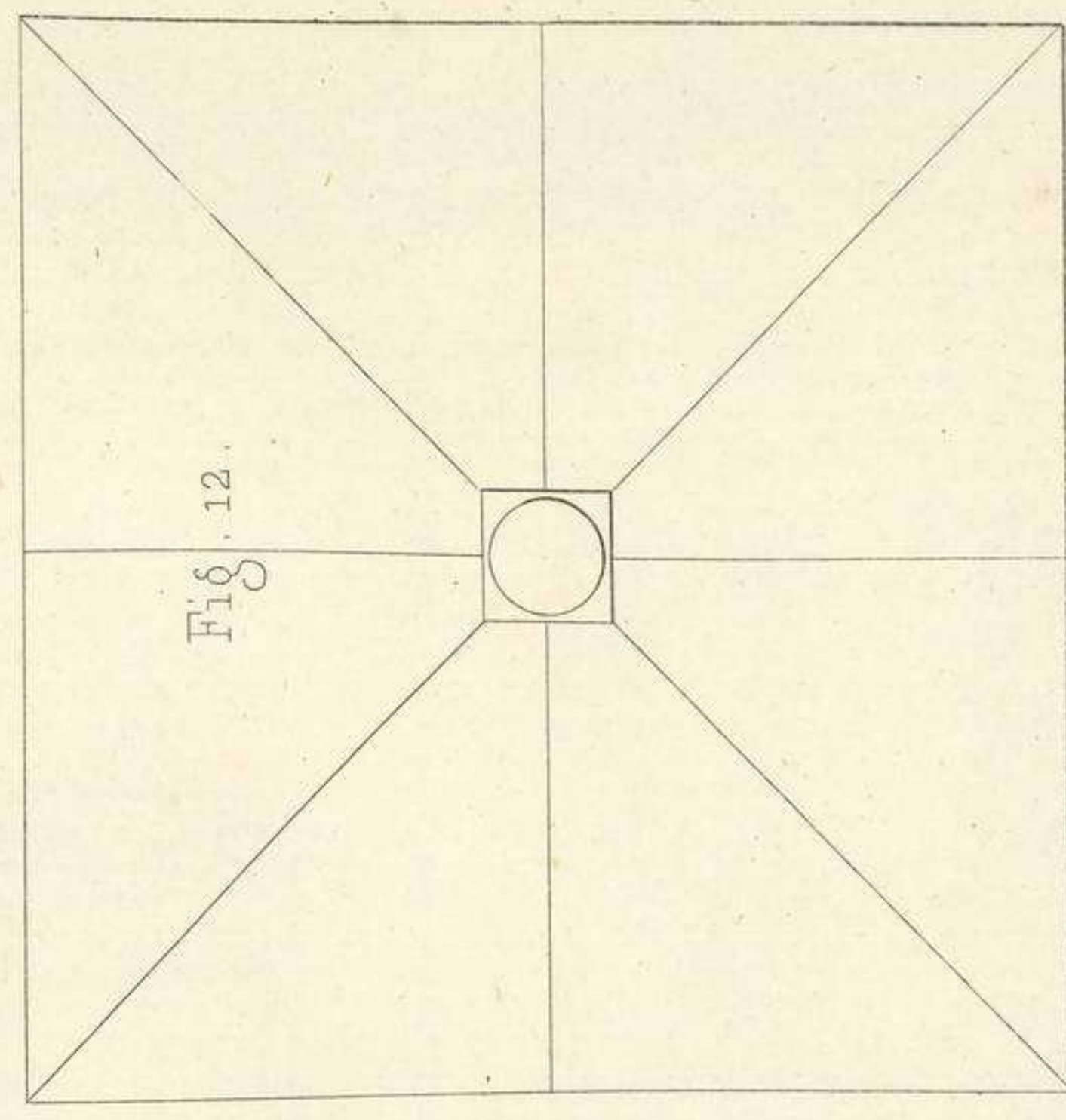
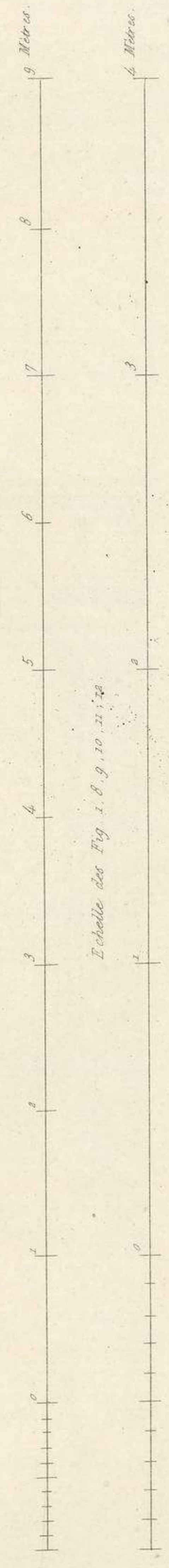

Fig. 12.



Echelle des Fig. 1, 2, 3, 4, 5, 6, 7, 8, 9, 10, 11, 12

Bonnet et Virel del.

H. Reus auct.

MENUISERIE  
Meubles.



Fig. 2.

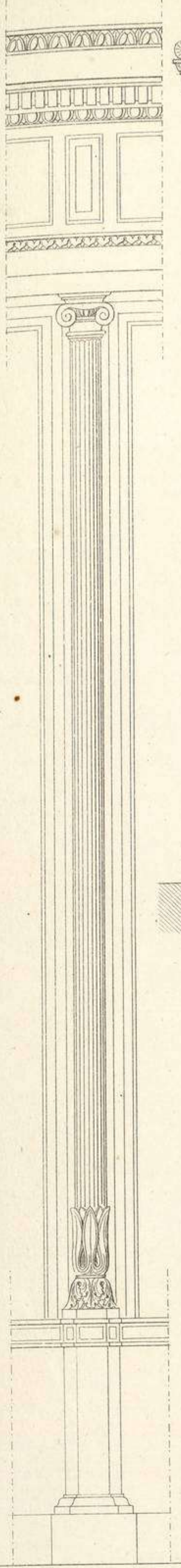

Fig. 1.

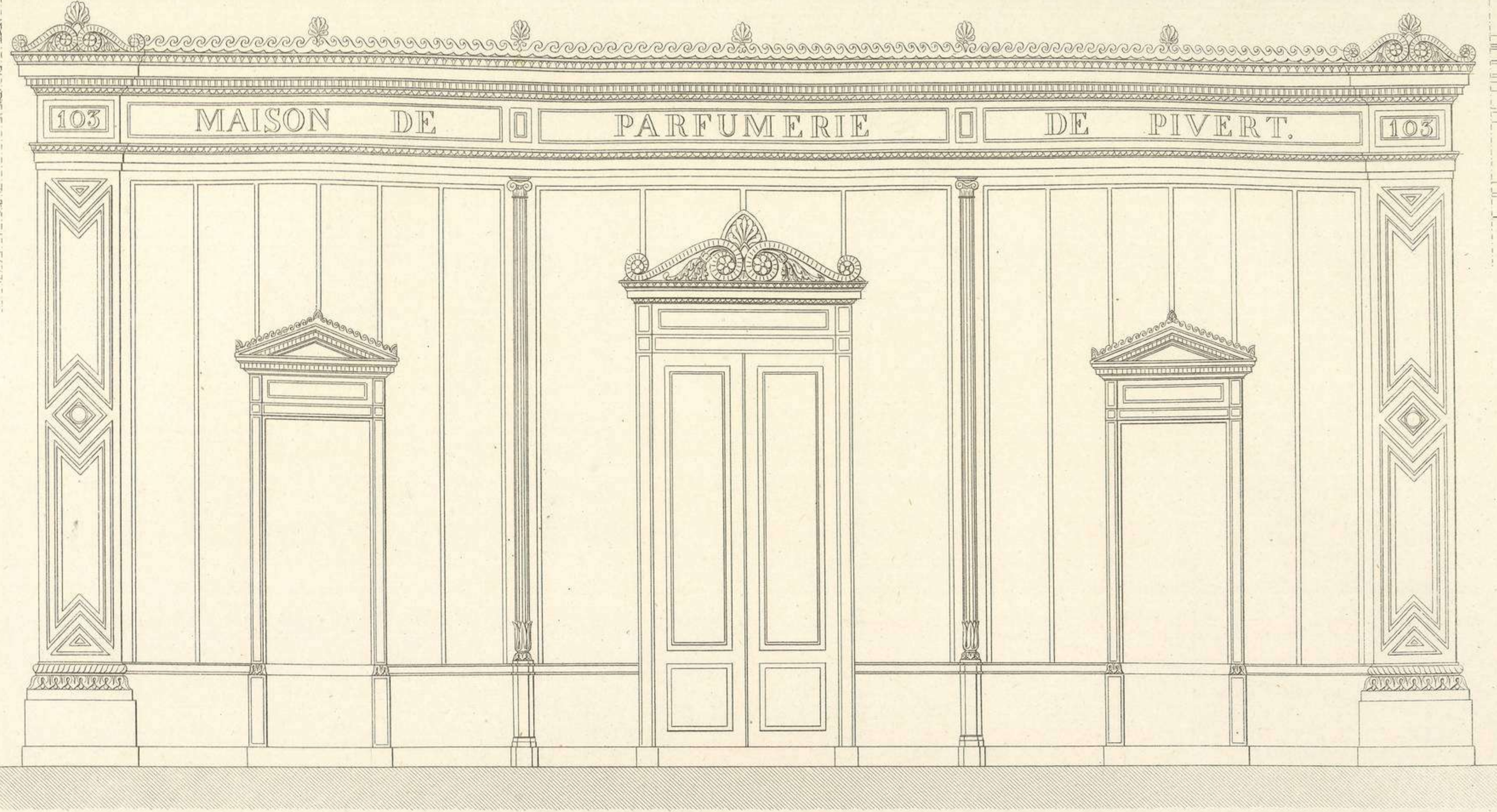

Fig. 3.

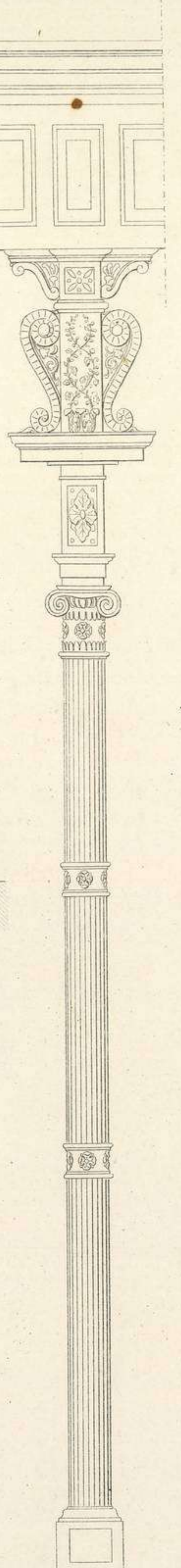

Fig. 4.

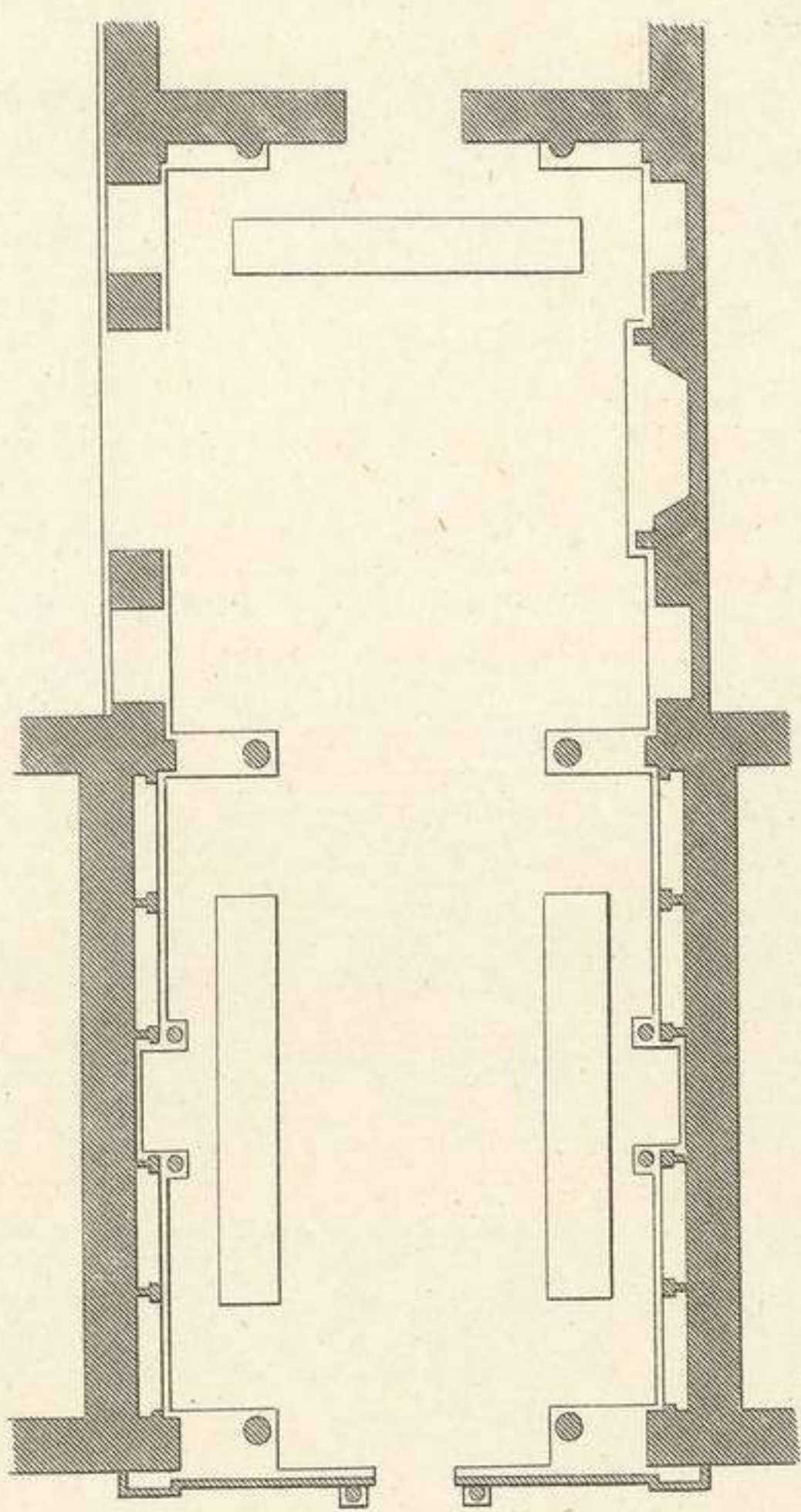

Fig. 5.

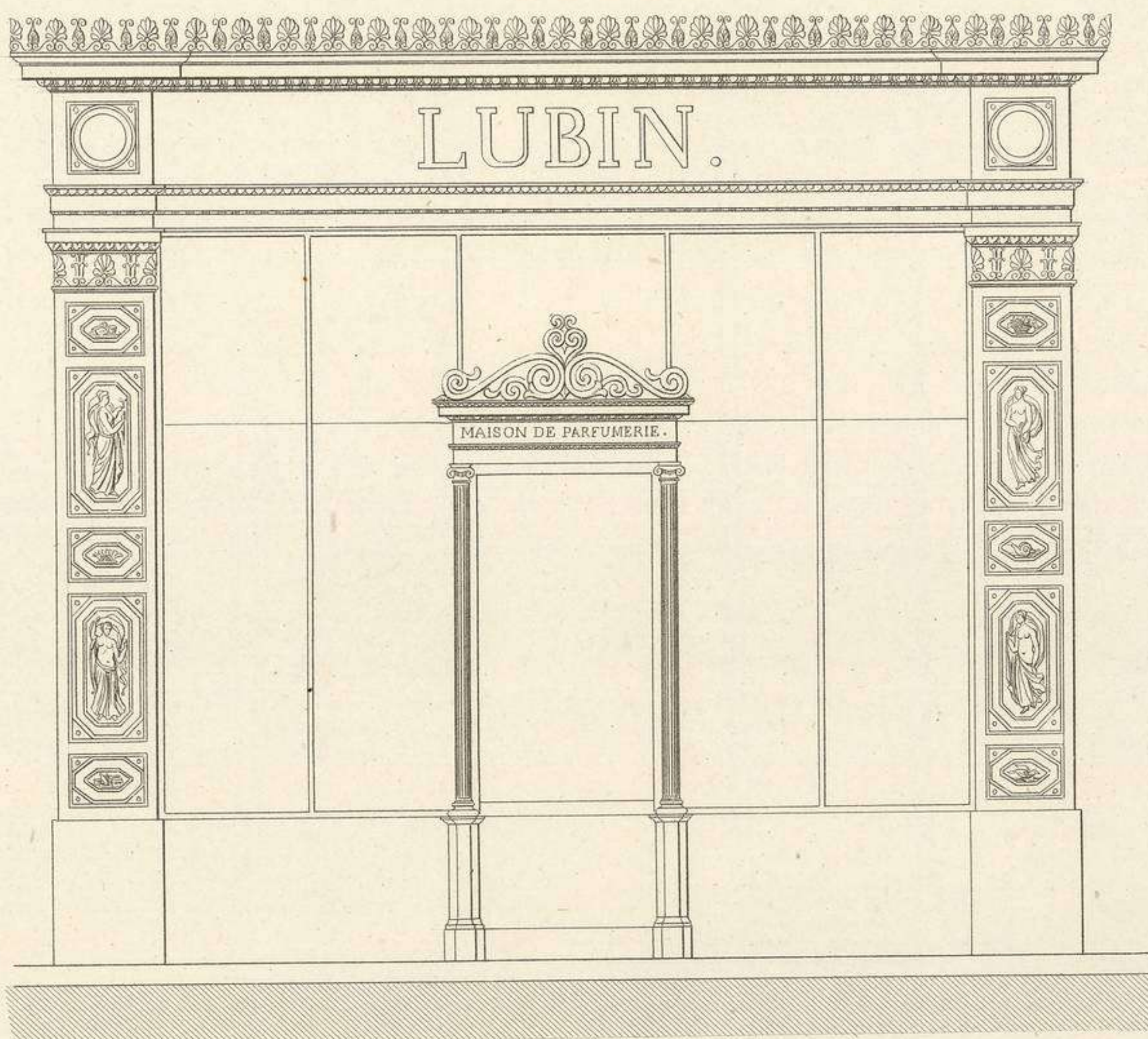

Fig. 6.

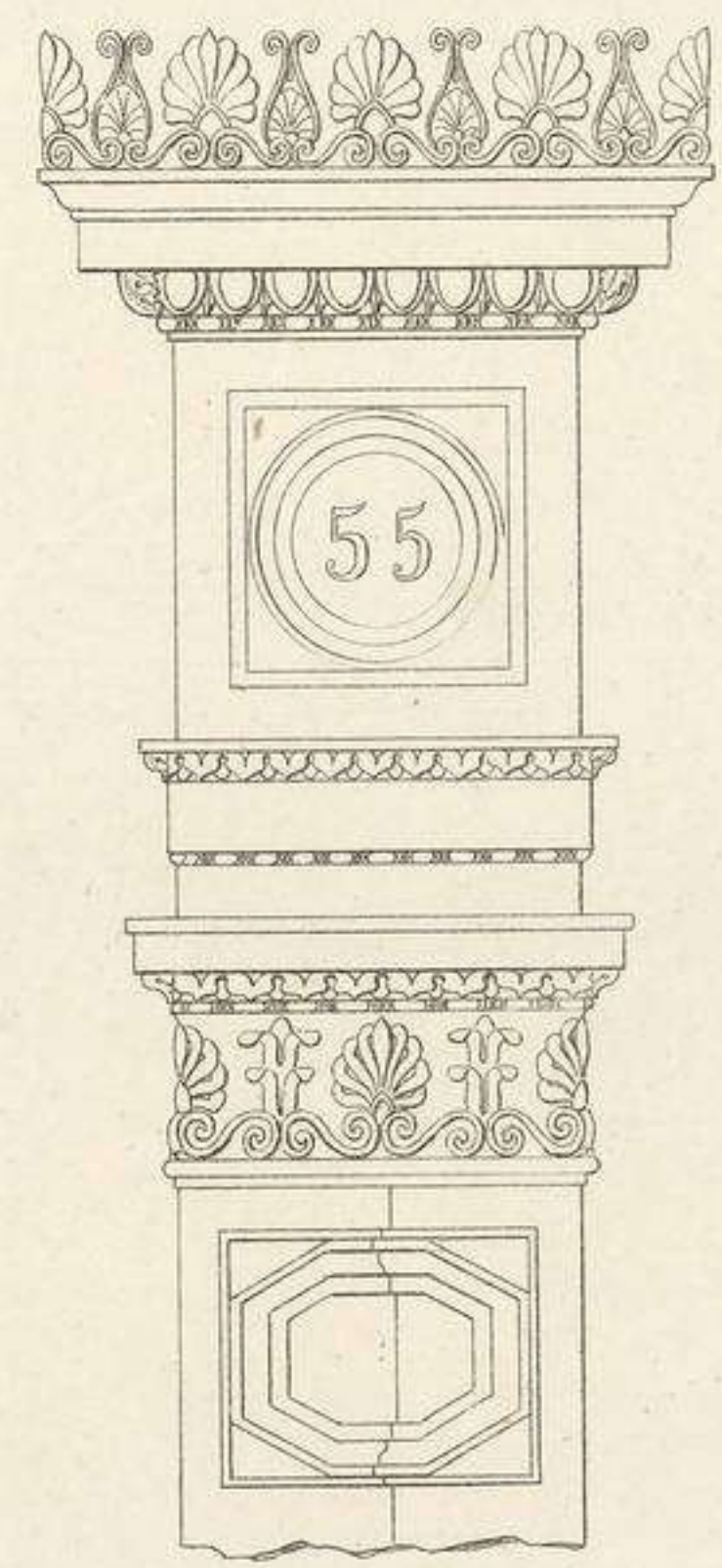
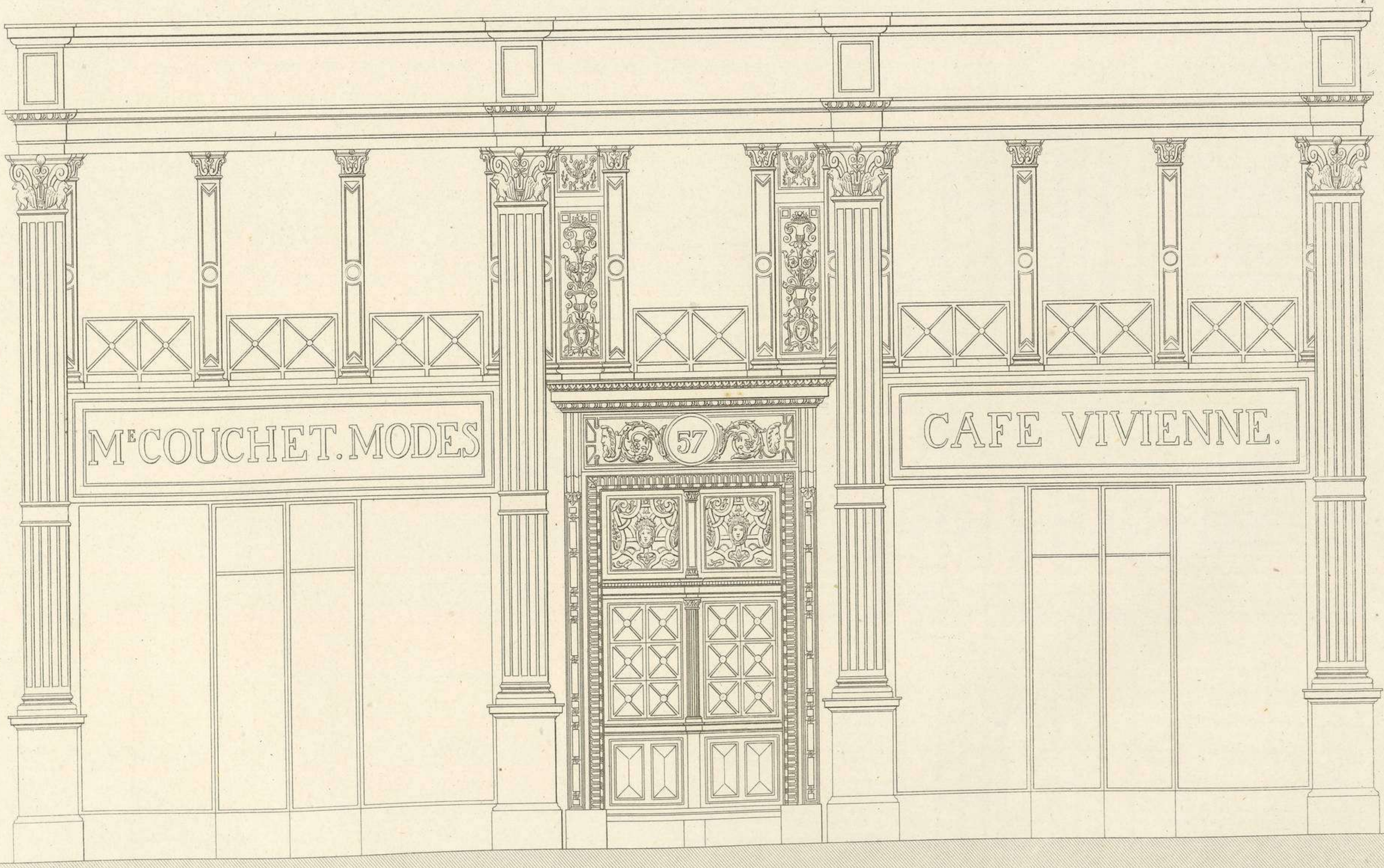

Fig. 7.



Echelle de la Fig. 4 0 1 2 3 4 5 6 7 8 9 Mètres.

Echelle des Fig. 1, 5, 7 0 1 2 3 4 5 6 7 8 9 Mètres.

0 1 2 3 4 5 6 7 8 9 Mètres.

B et V. del.

MENUISERIE.  
Devantures de Boutiques.

H. H.



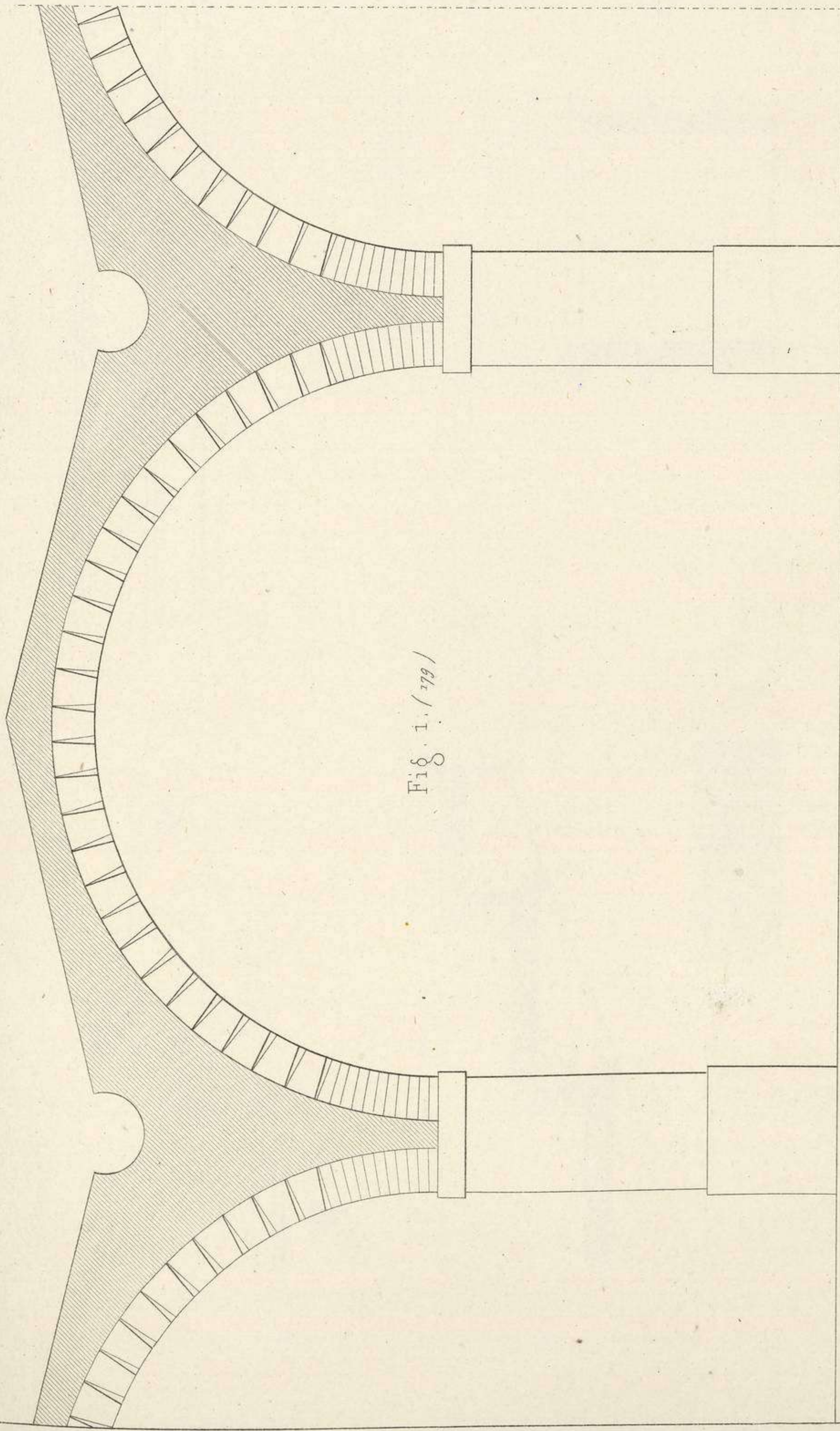

Fig. 1. (179)

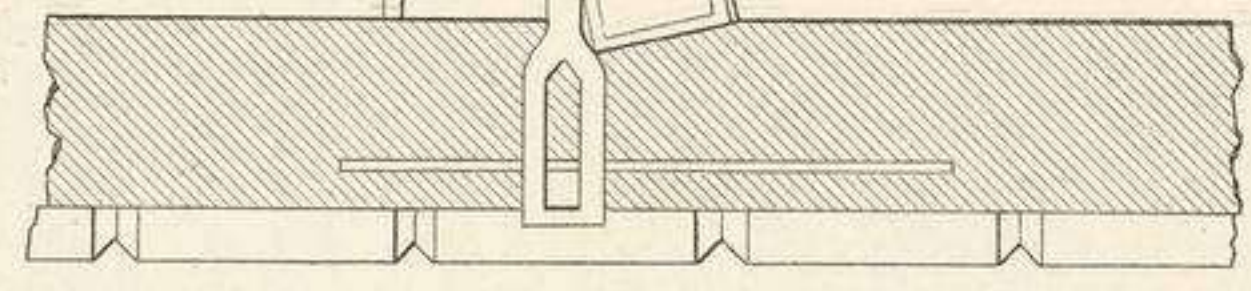

Fig. 4. (180)

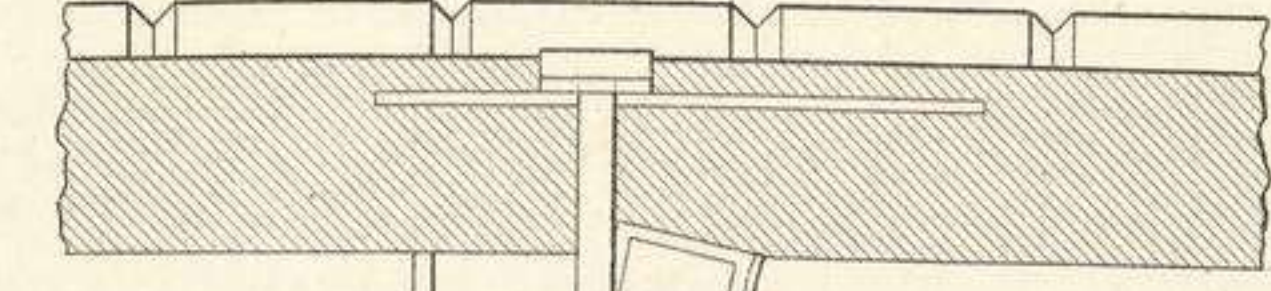

Fig. 5. (180)

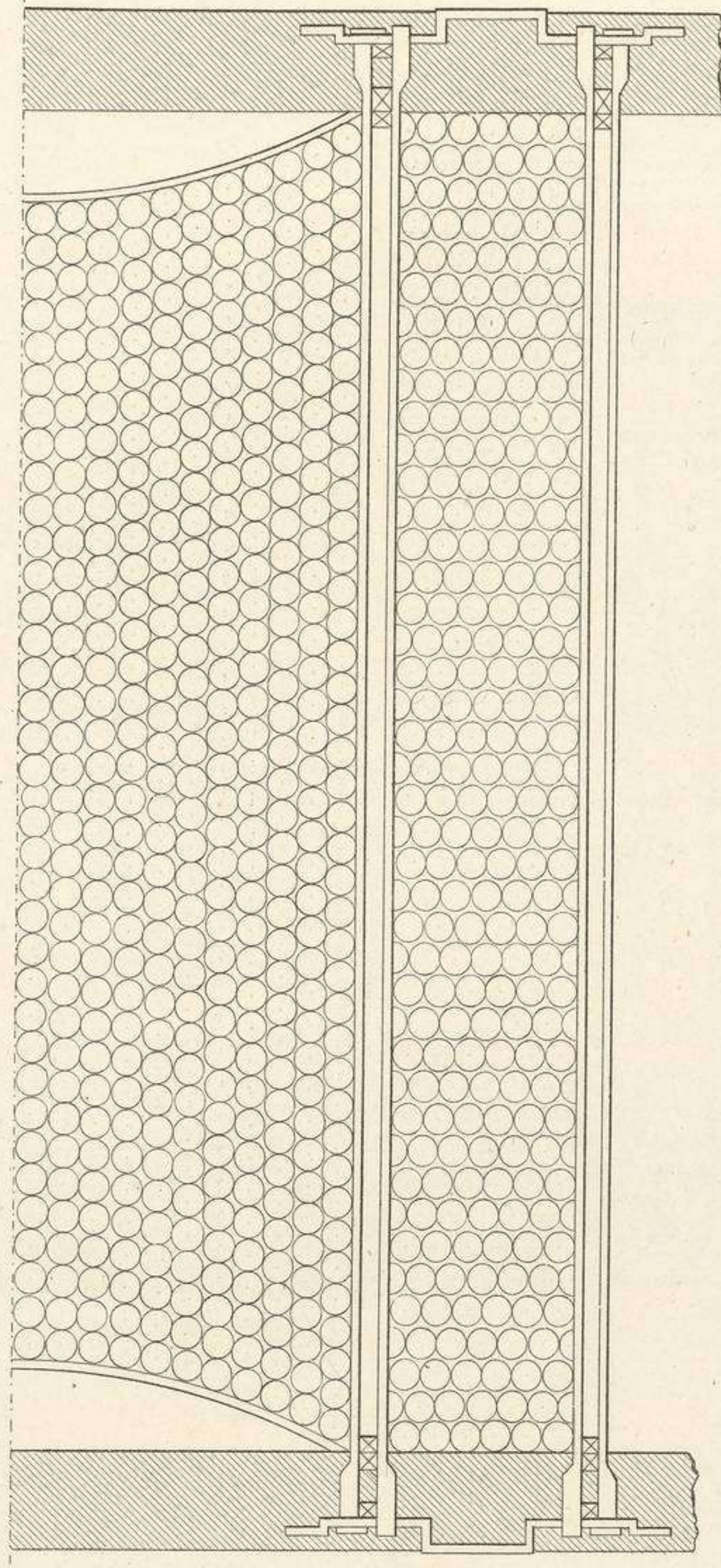

Fig. 3. (179)

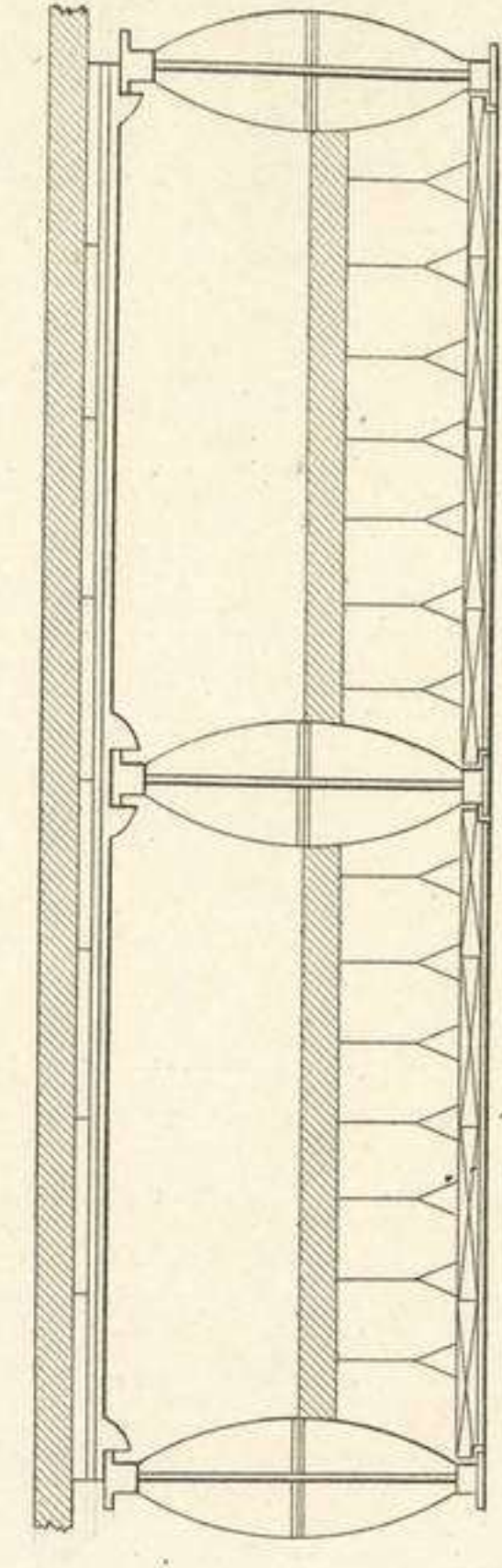

Fig. 6. (180)

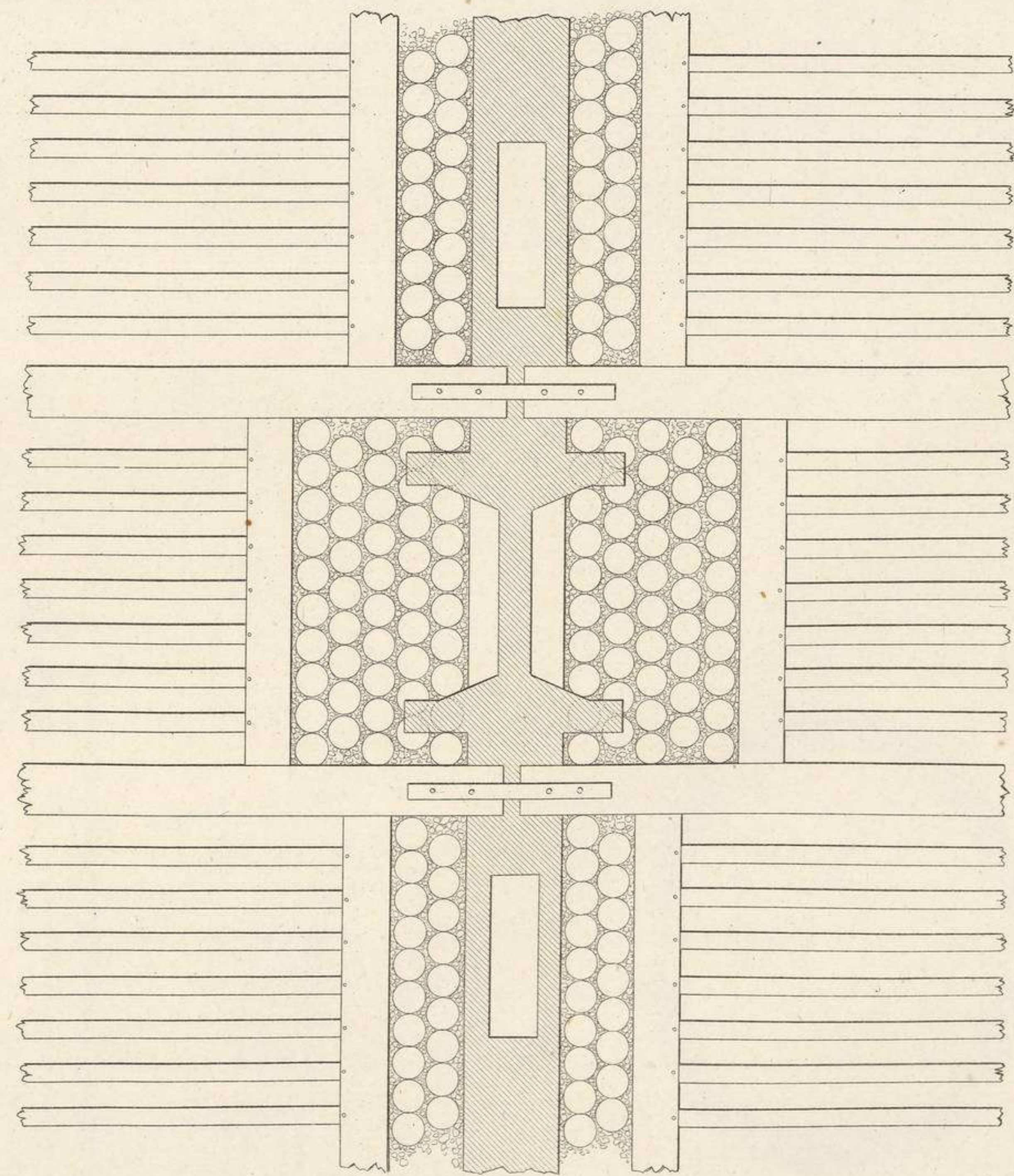

Fig. 2. (179)

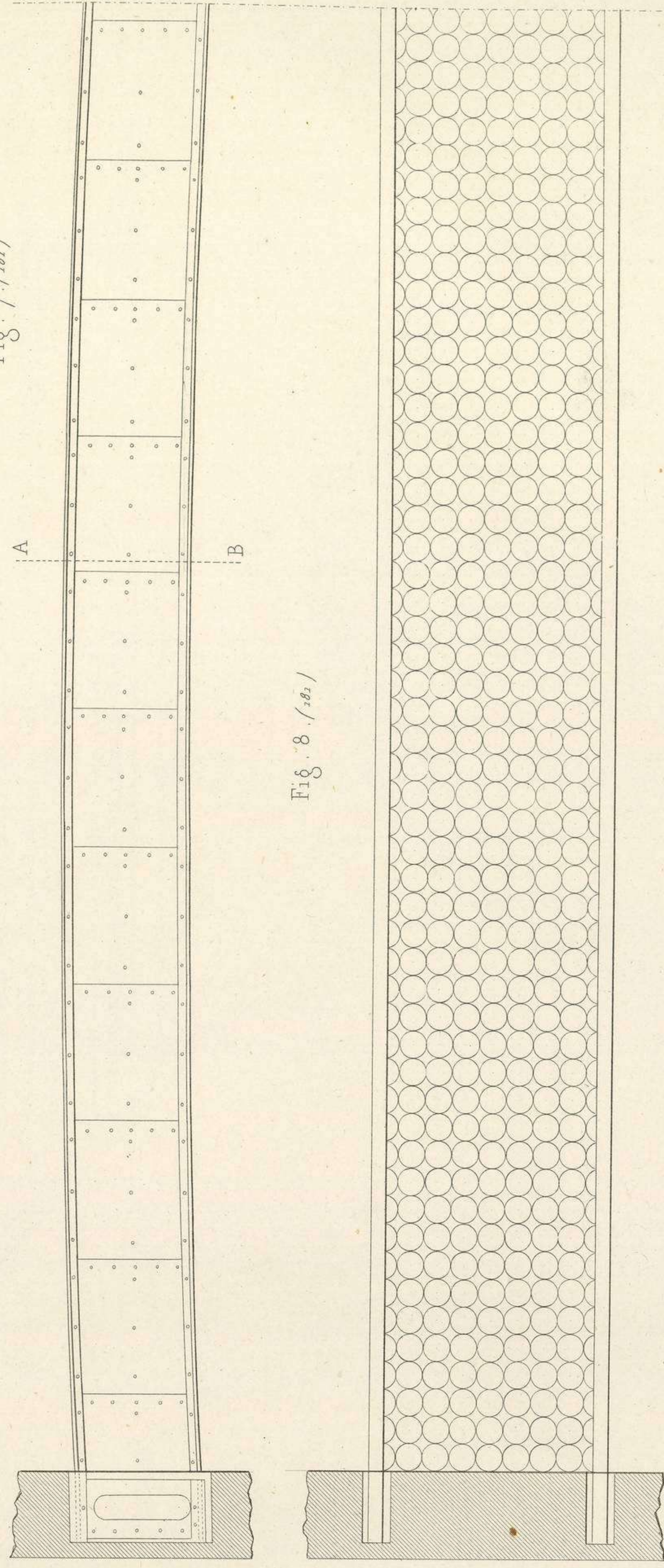

Fig. 7. (180)

Fig. 8. (180)

Echelle des Fig. 2, 3, 4, 5, 6, 7, 8.

Mètres

Blouet et Tardet del.

H. Beauvais sculp.

SERRURERIE  
Emploi des Poteries



Fig. 1.  
(182)

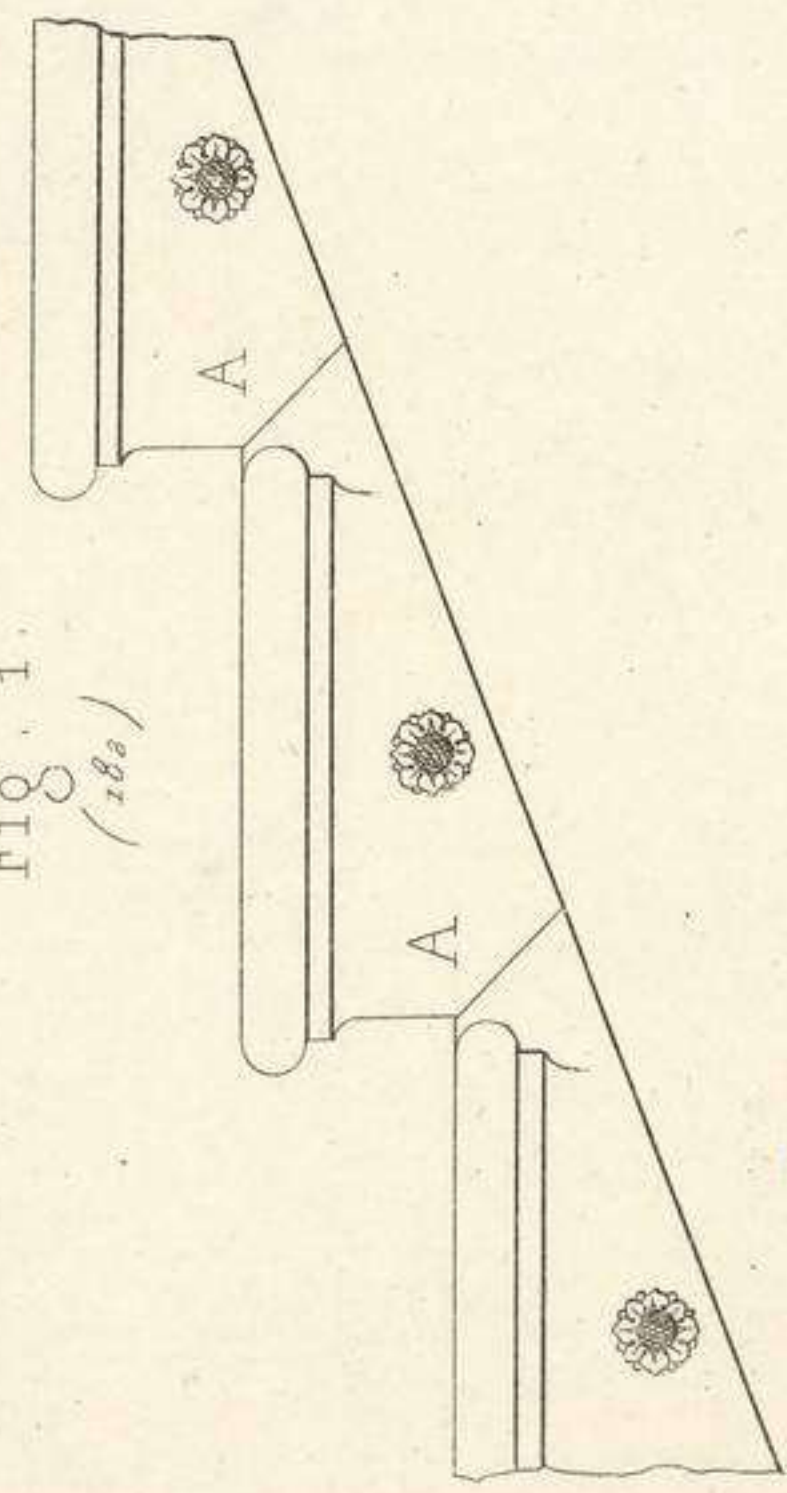

Fig. 2.  
(182)

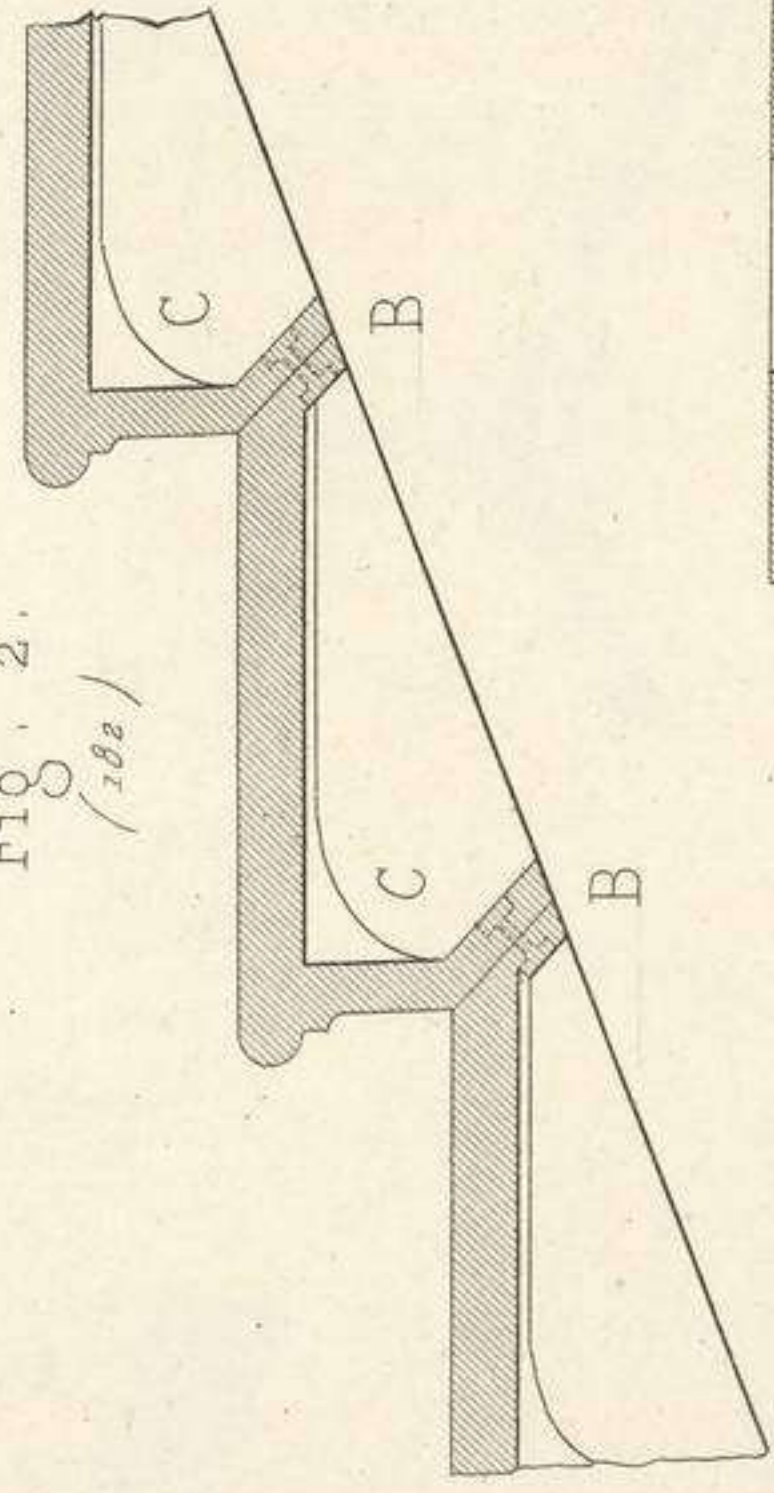

Fig. 3.  
(182)

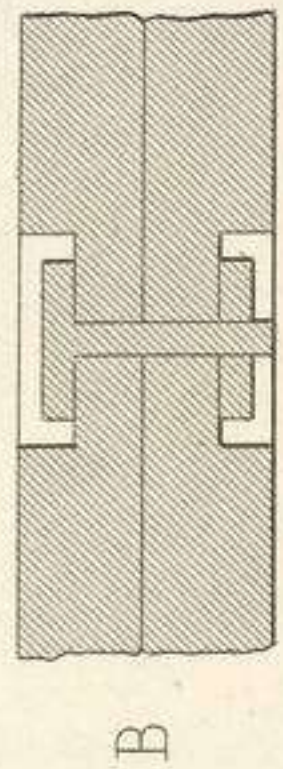

Fig. 4.  
(182)

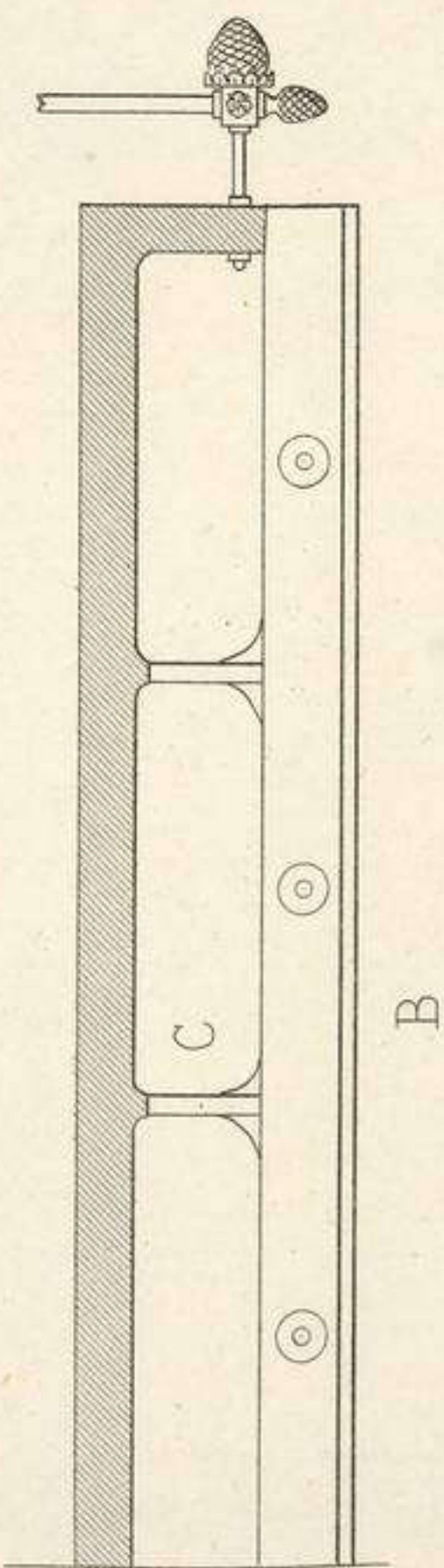

Fig. 5.  
(182)

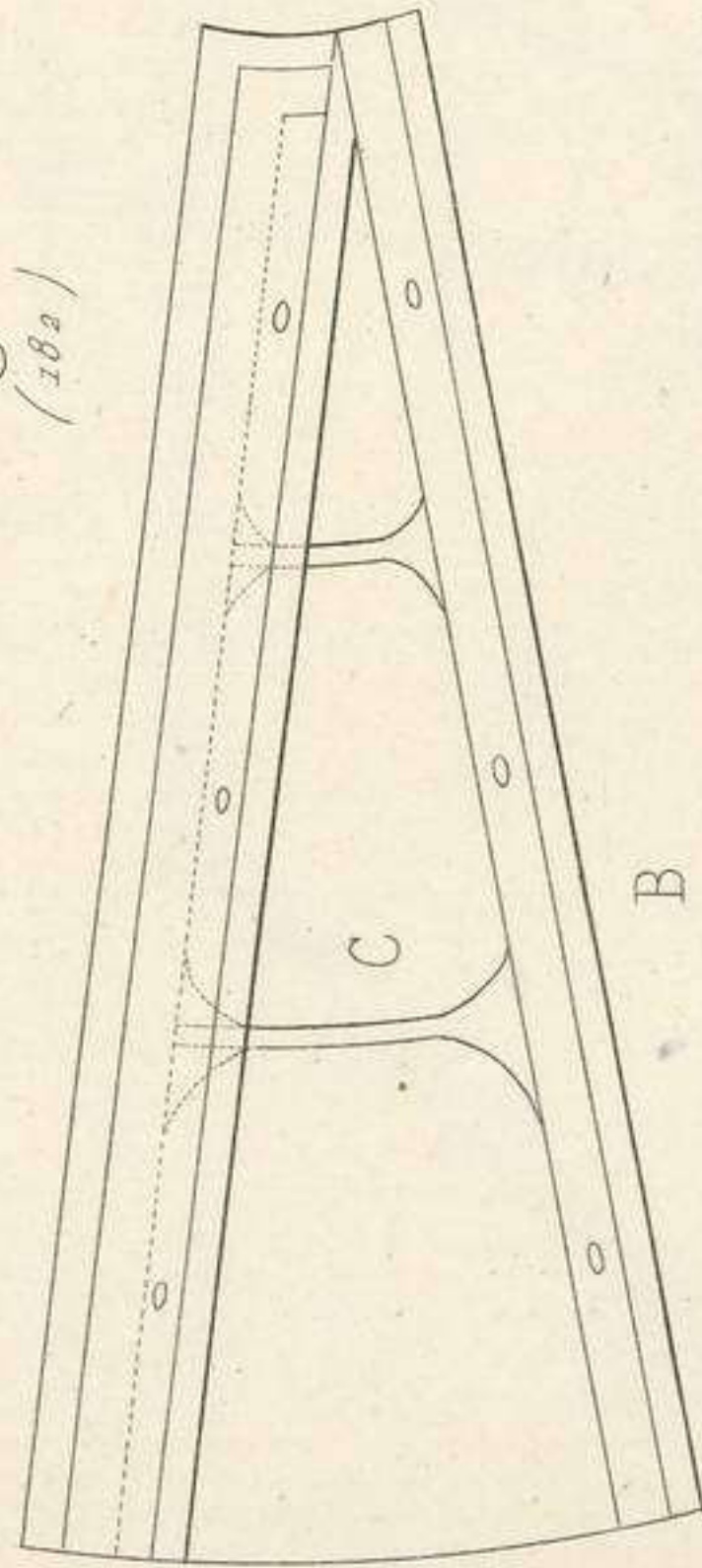

Fig. 6.  
(182)

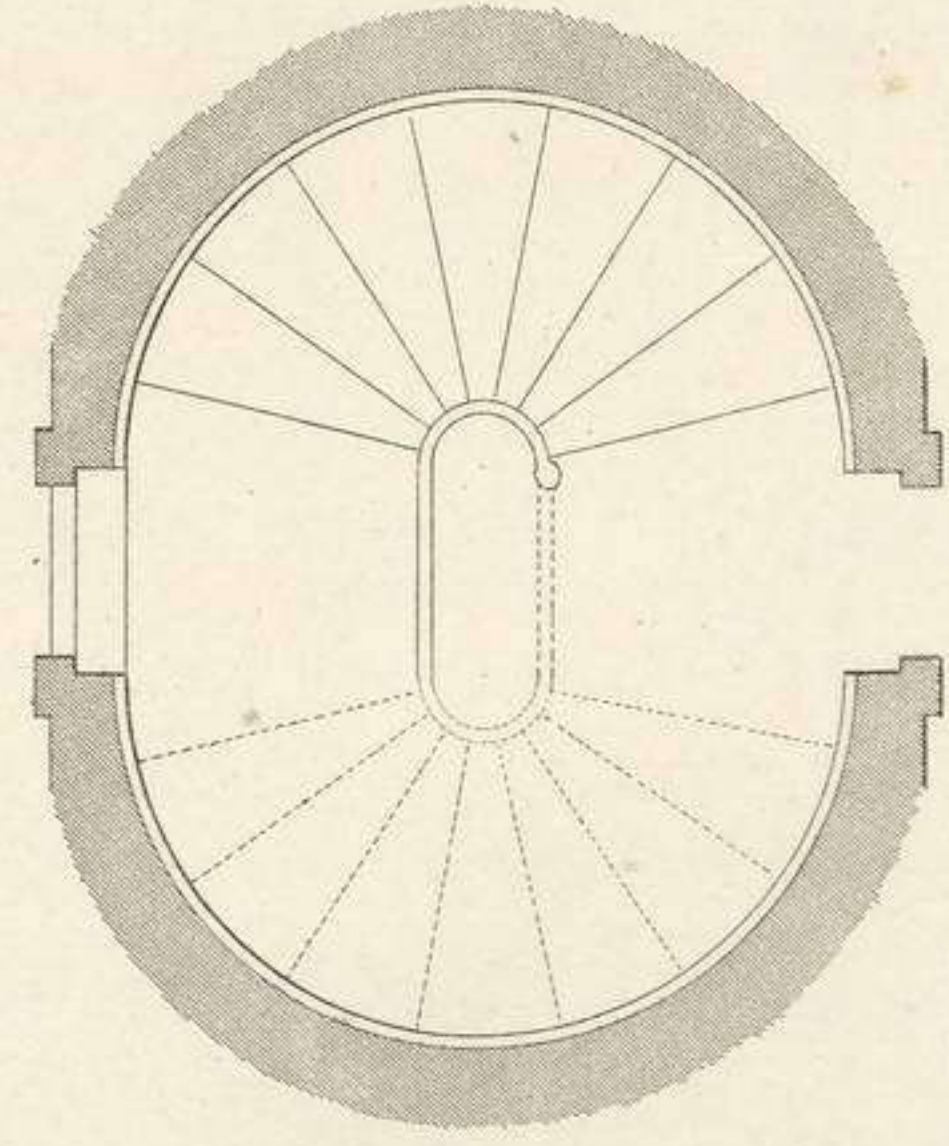

Fig. 11.  
(184)

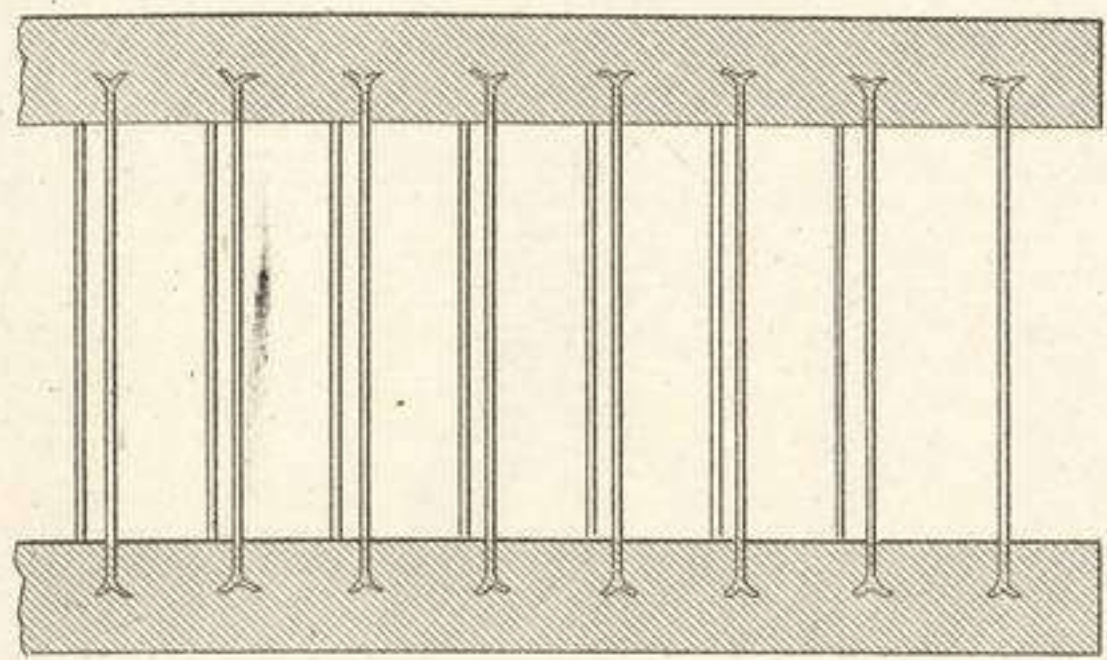

Fig. 12.  
(184)

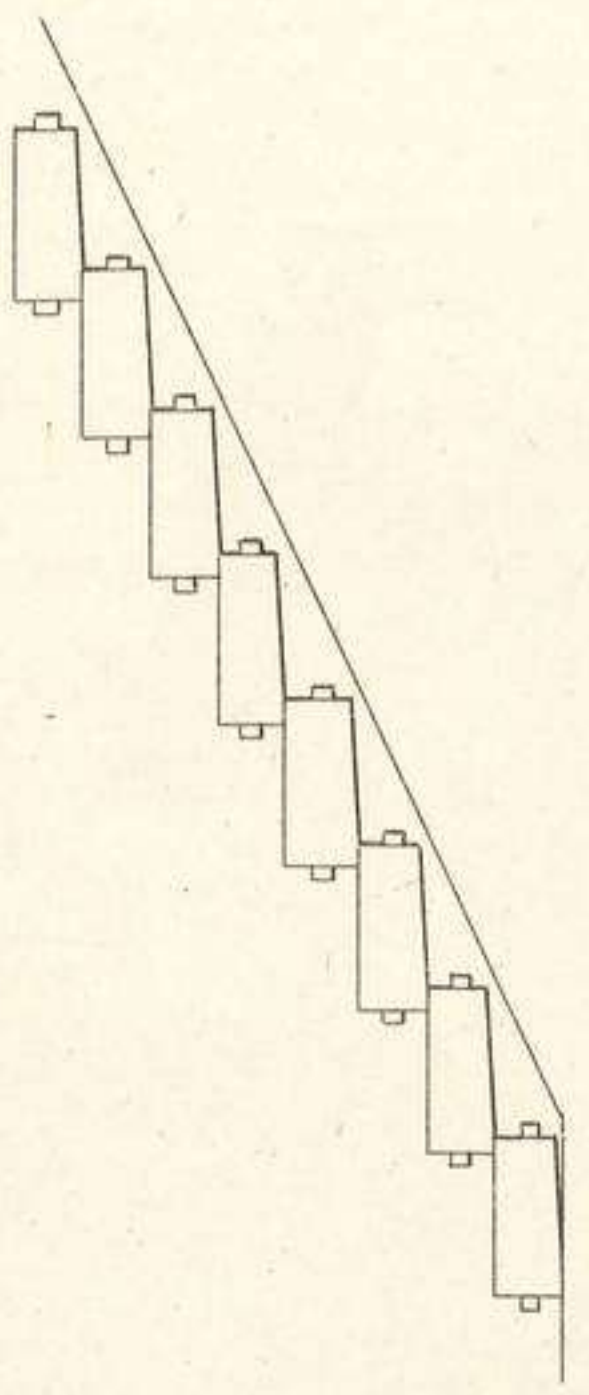

Fig. 13.  
(184)

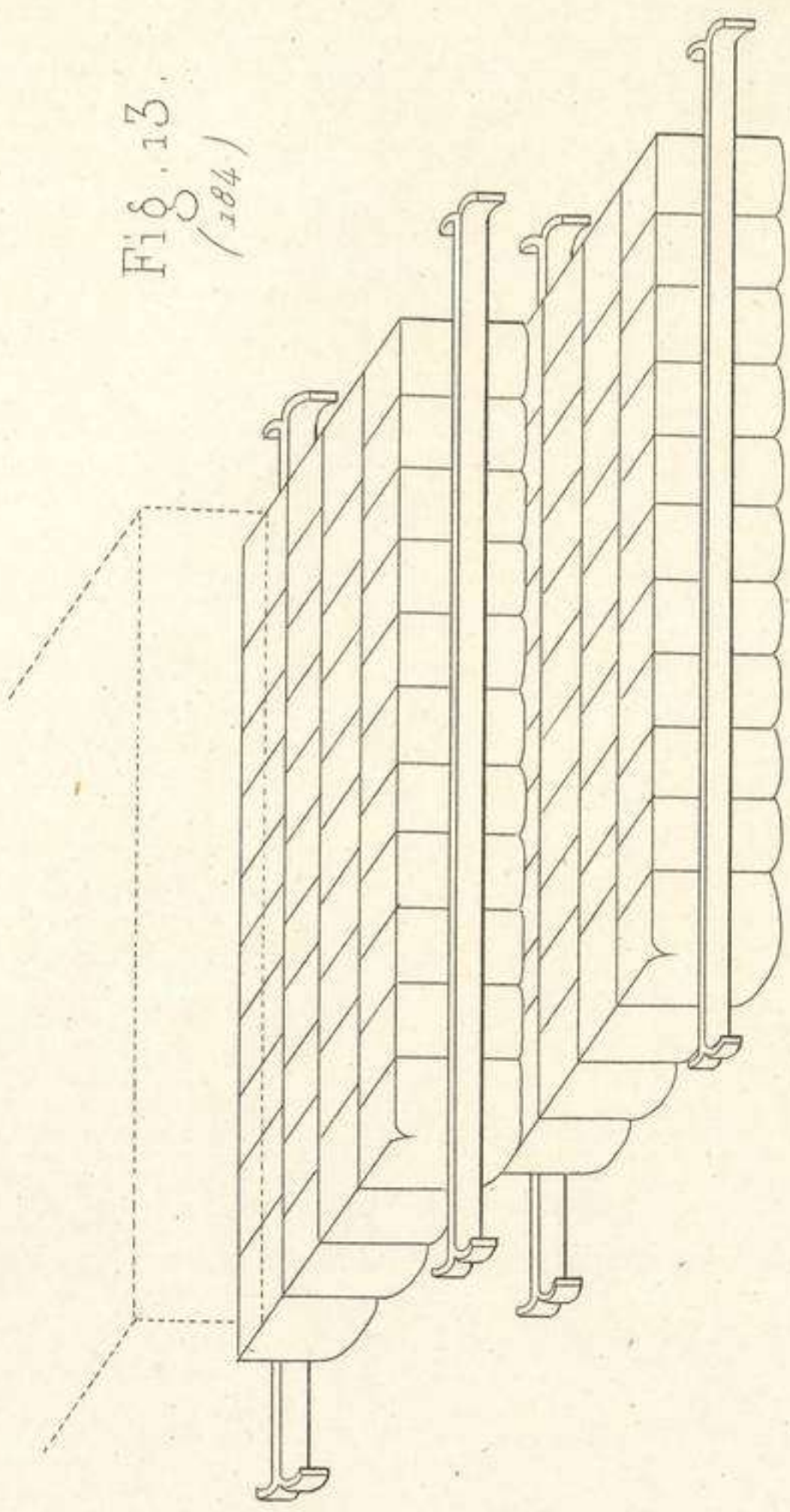

Fig. 4.  
(184)

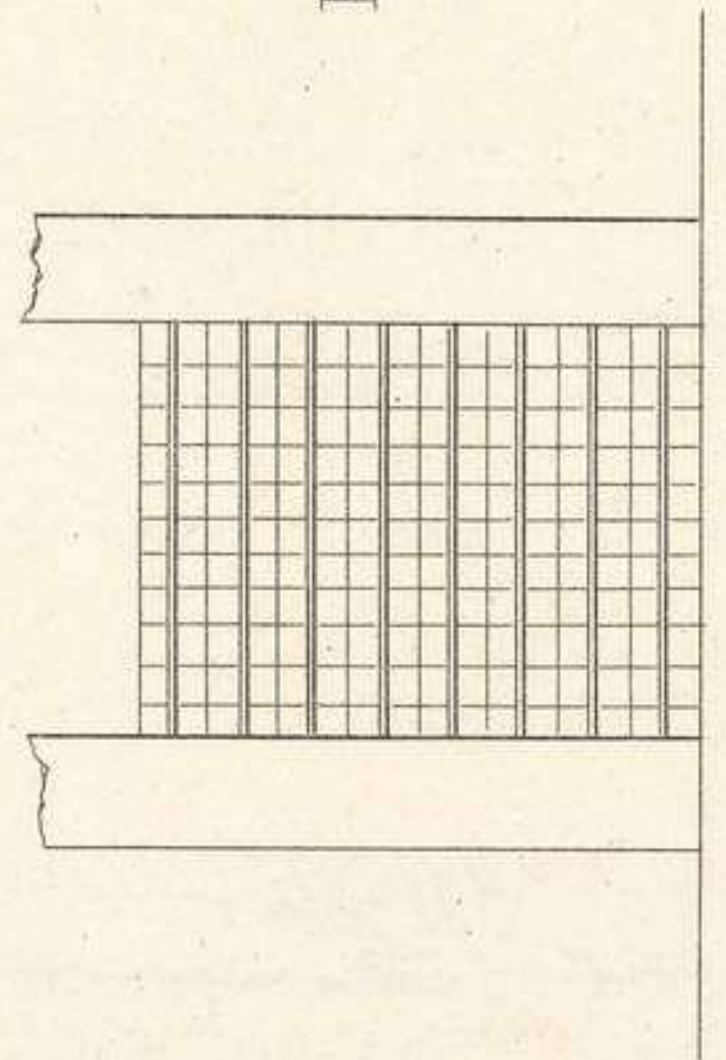

Fig. 15.  
(185)

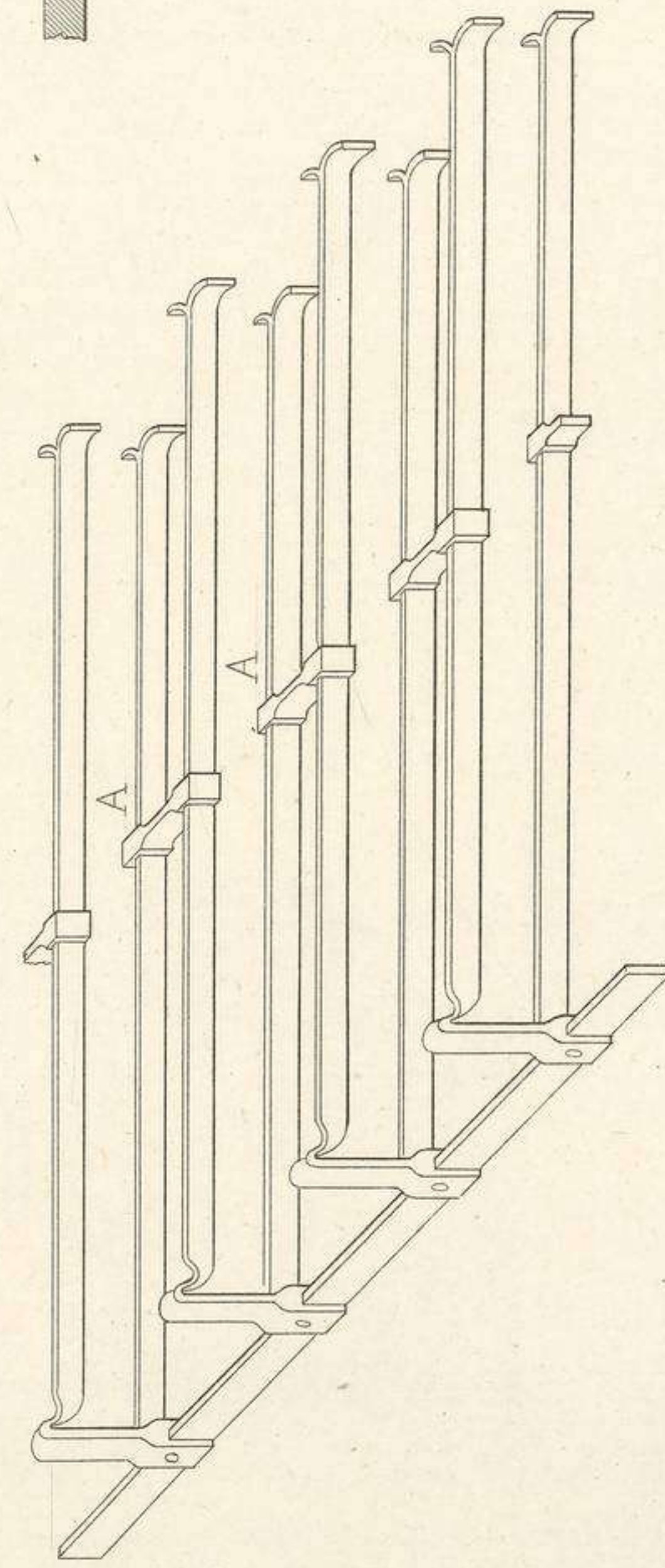

Fig. 16.  
(185)

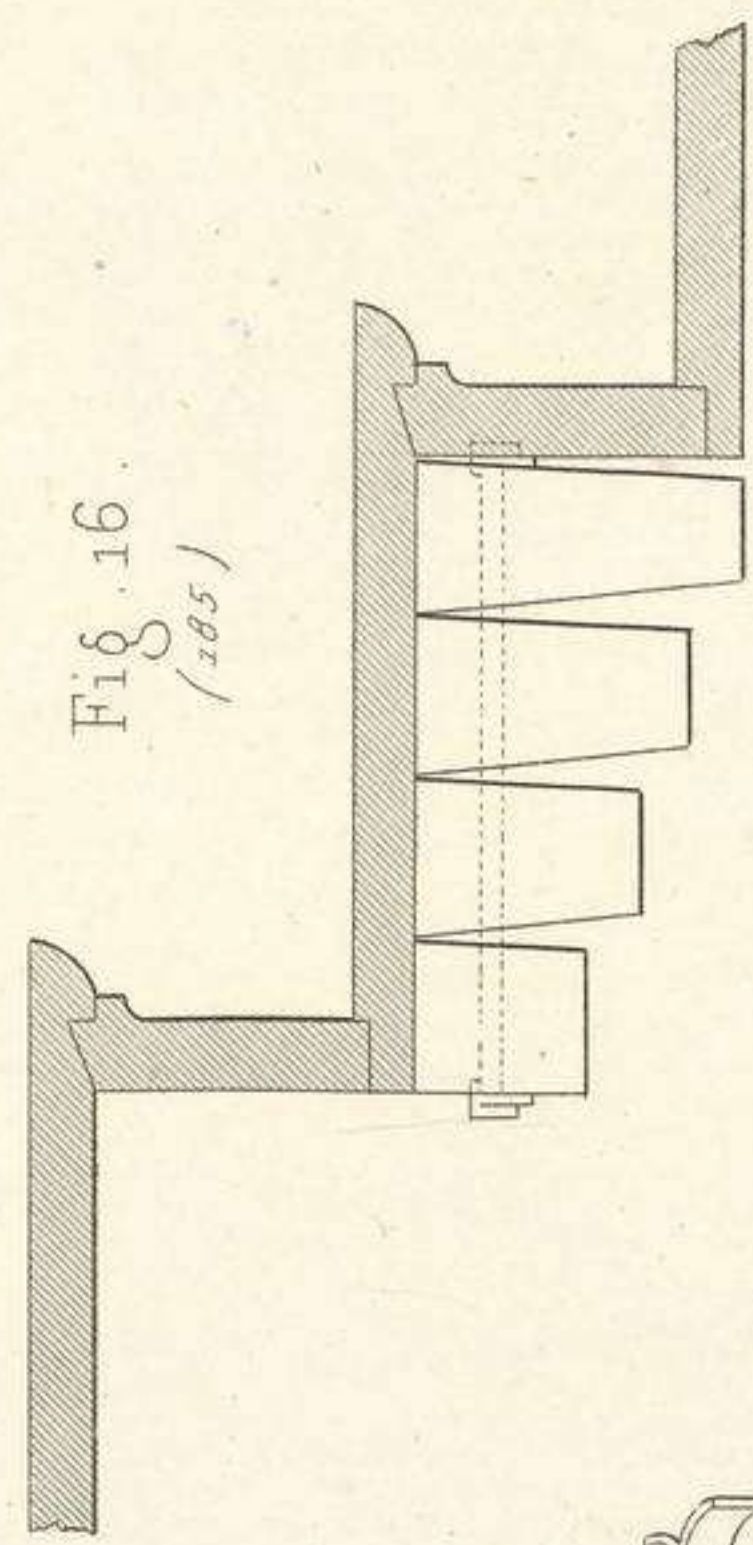
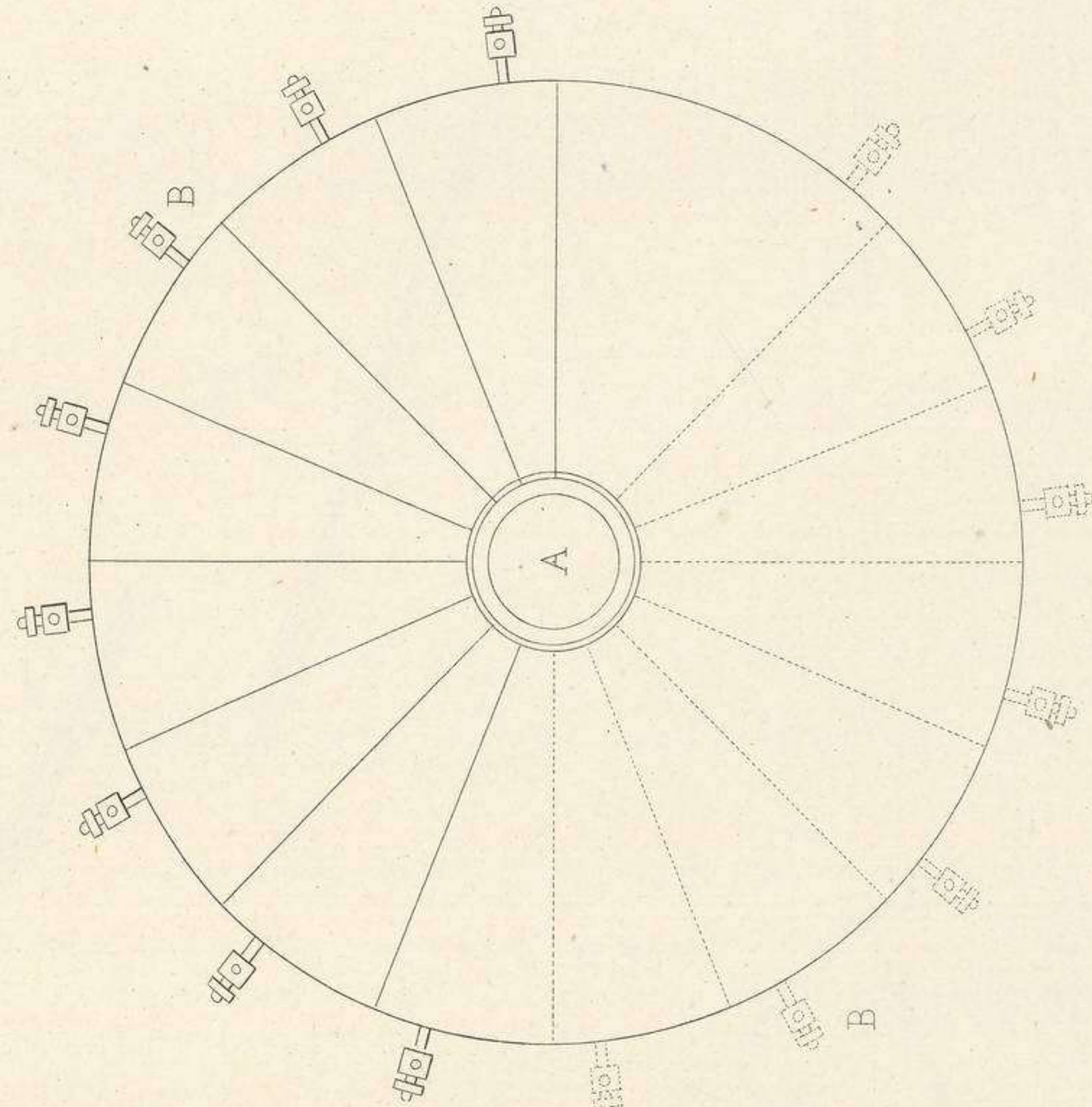

Fig. 7.  
(183)



Échelle des Fig. 9, 11, 12, 14, 17, 18.

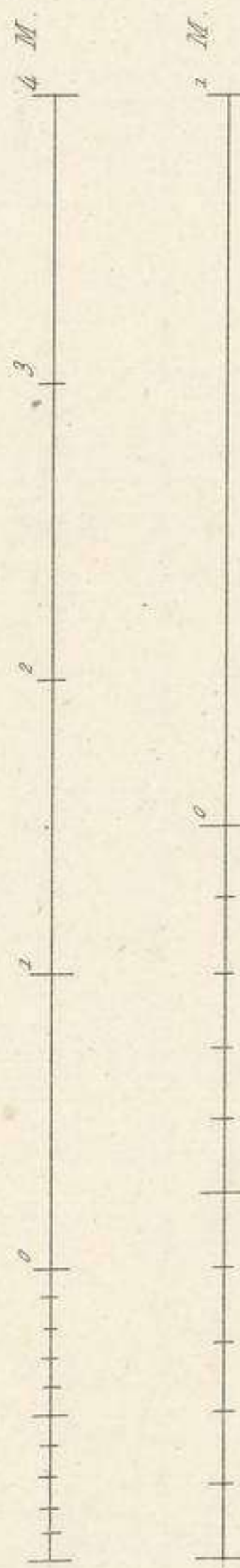

Fig. 17.  
(185)

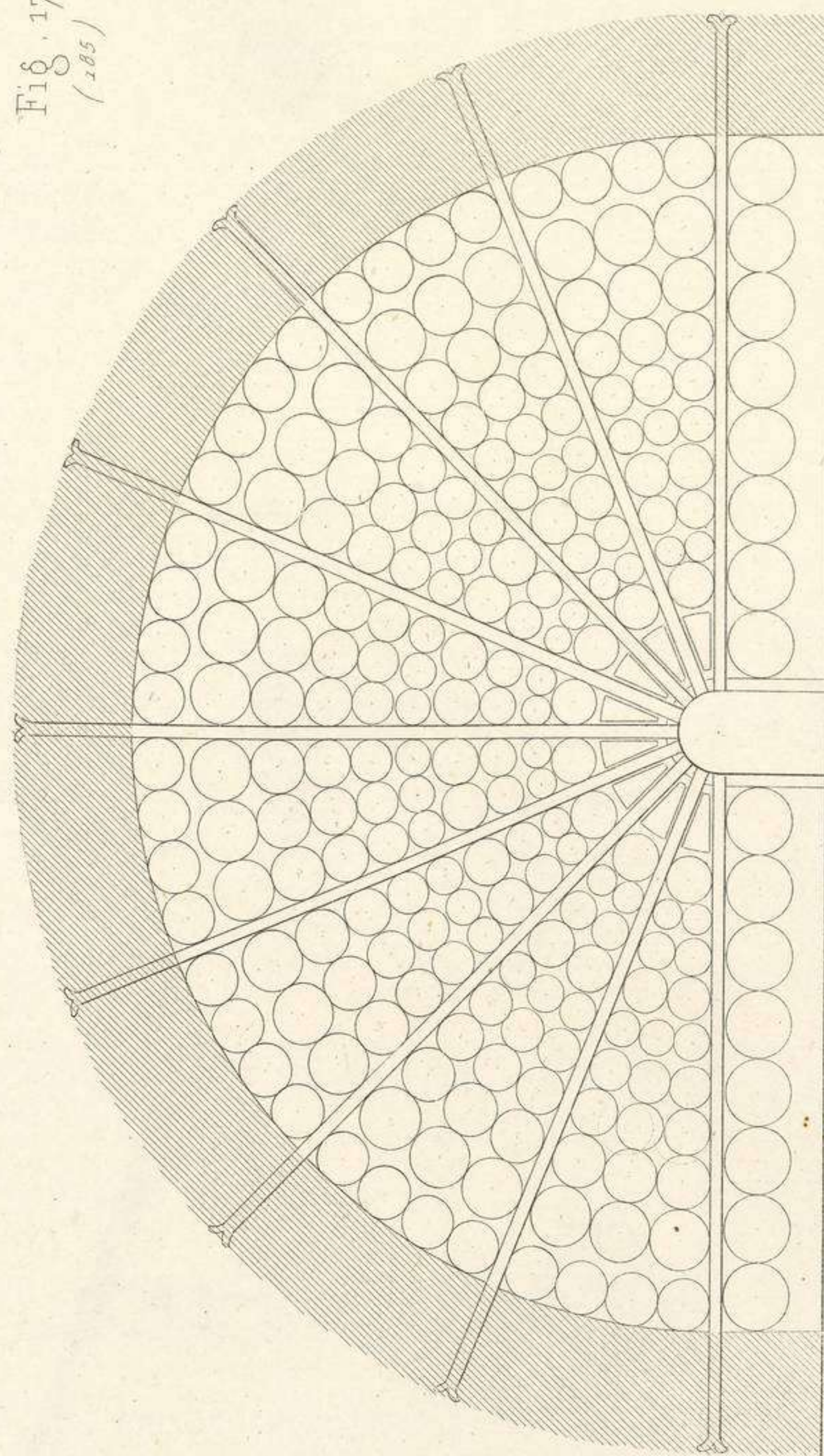
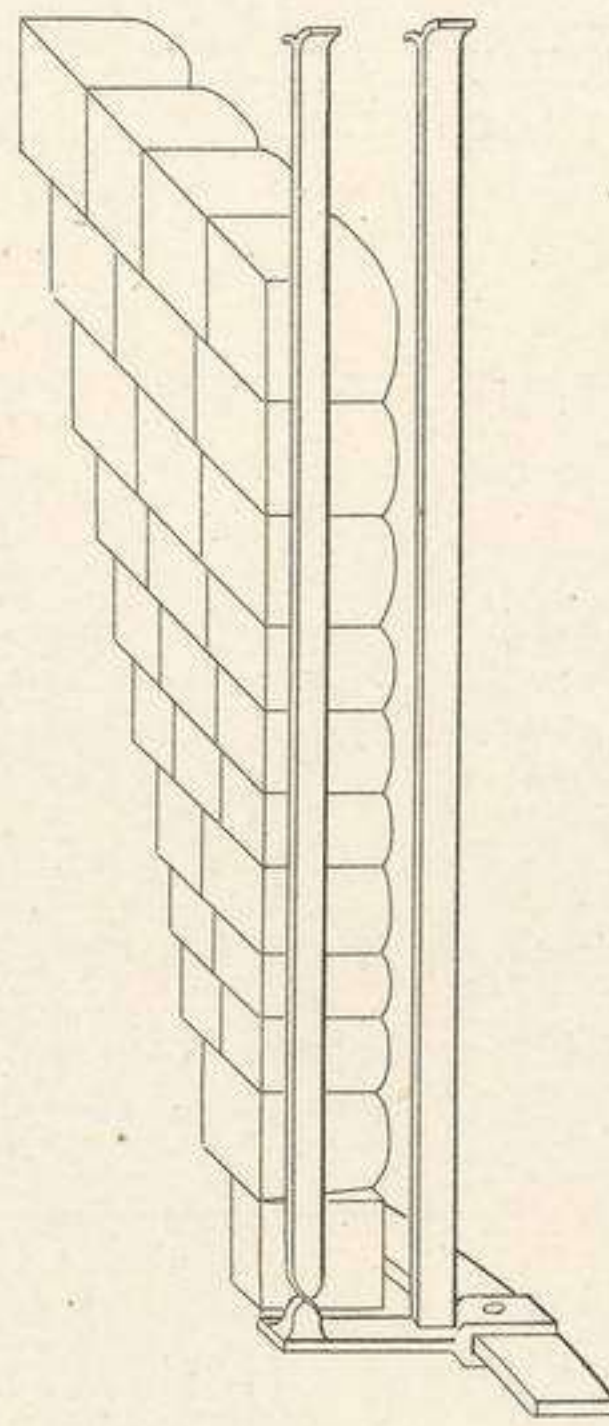
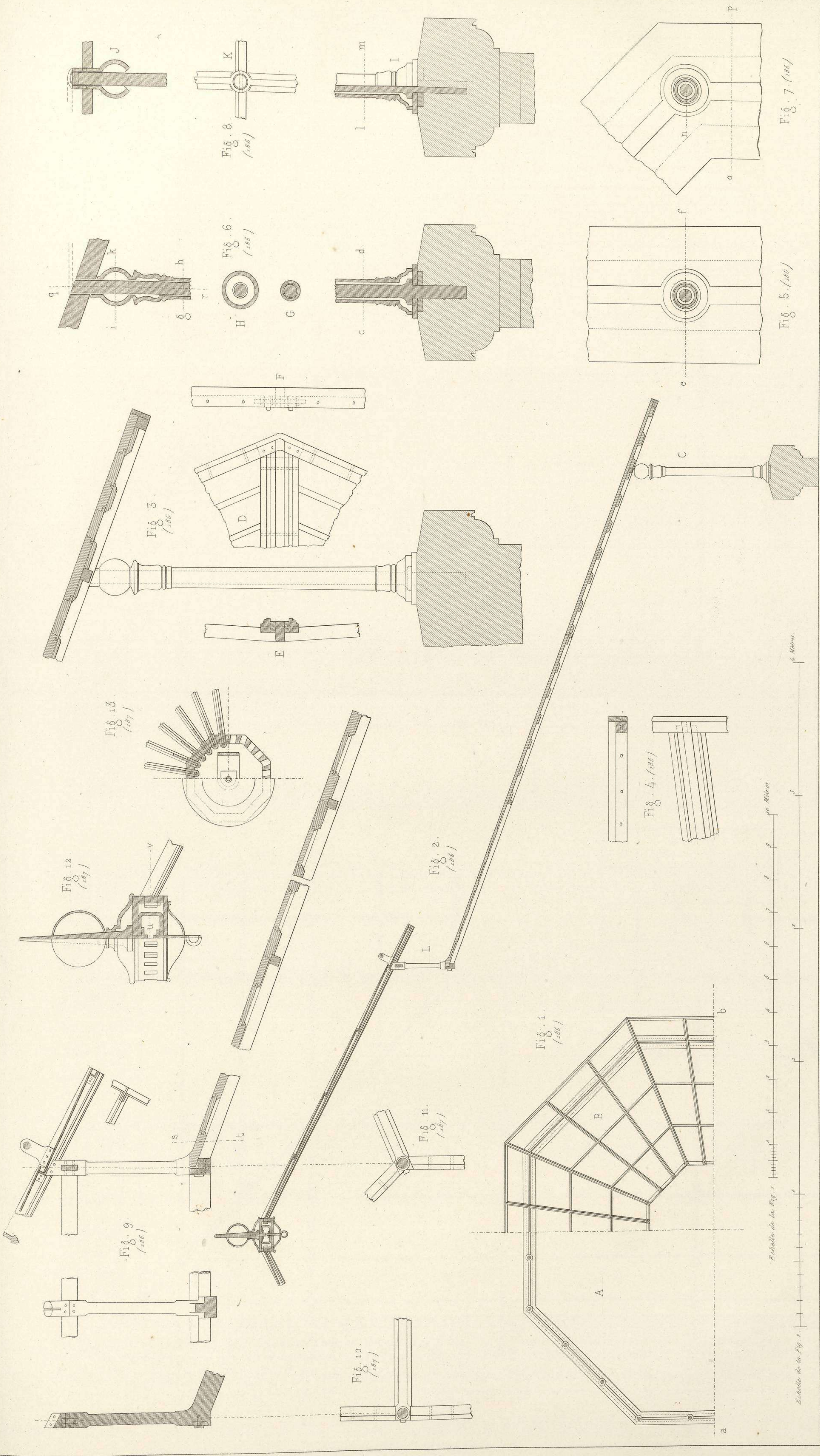

Fig. 18.  
(185)







B et V del.

2 Millim.

10 Millim.

H. R.

H. R.



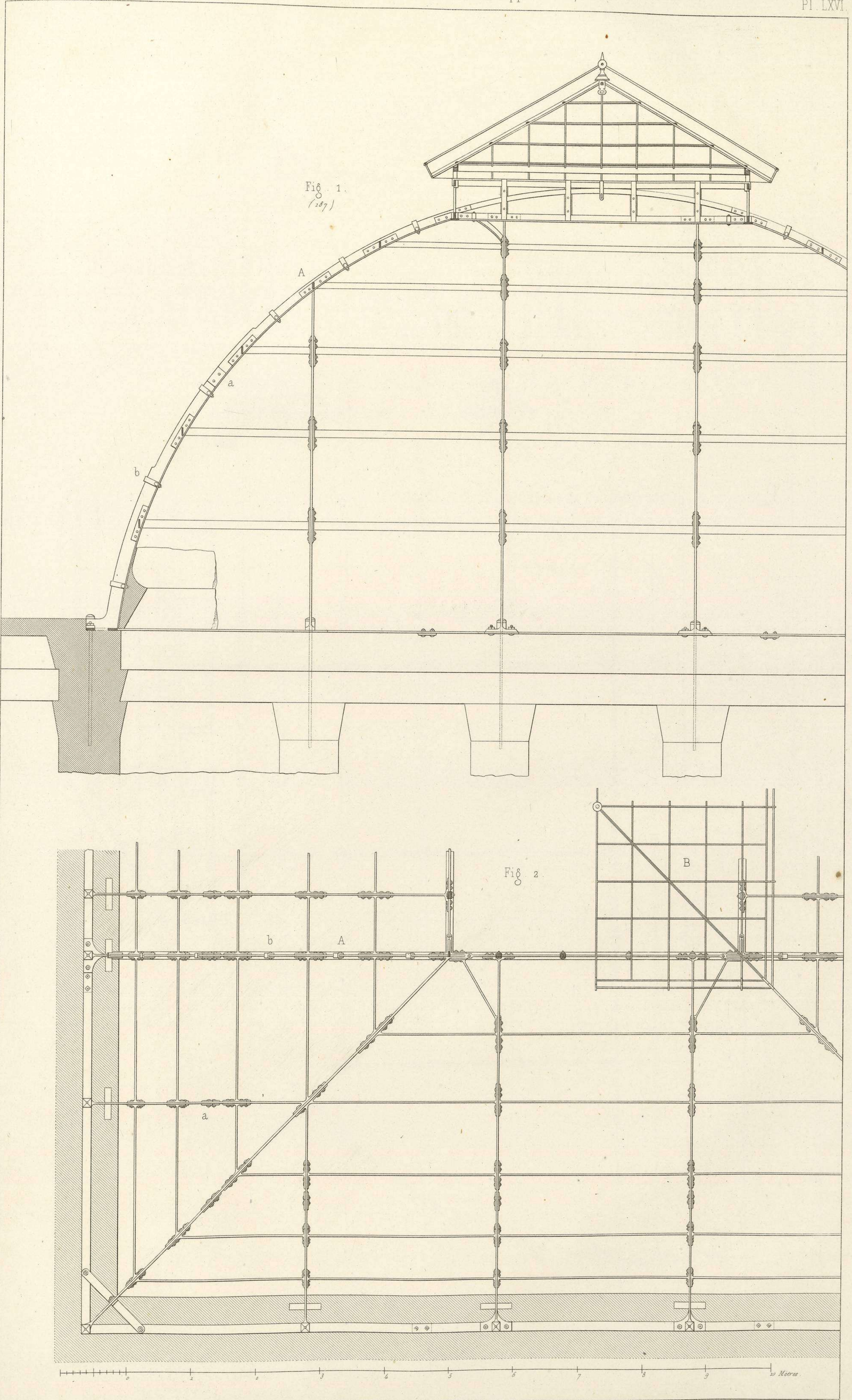

B. et V. del.

H. R.

SERRURERIE.  
Combles.



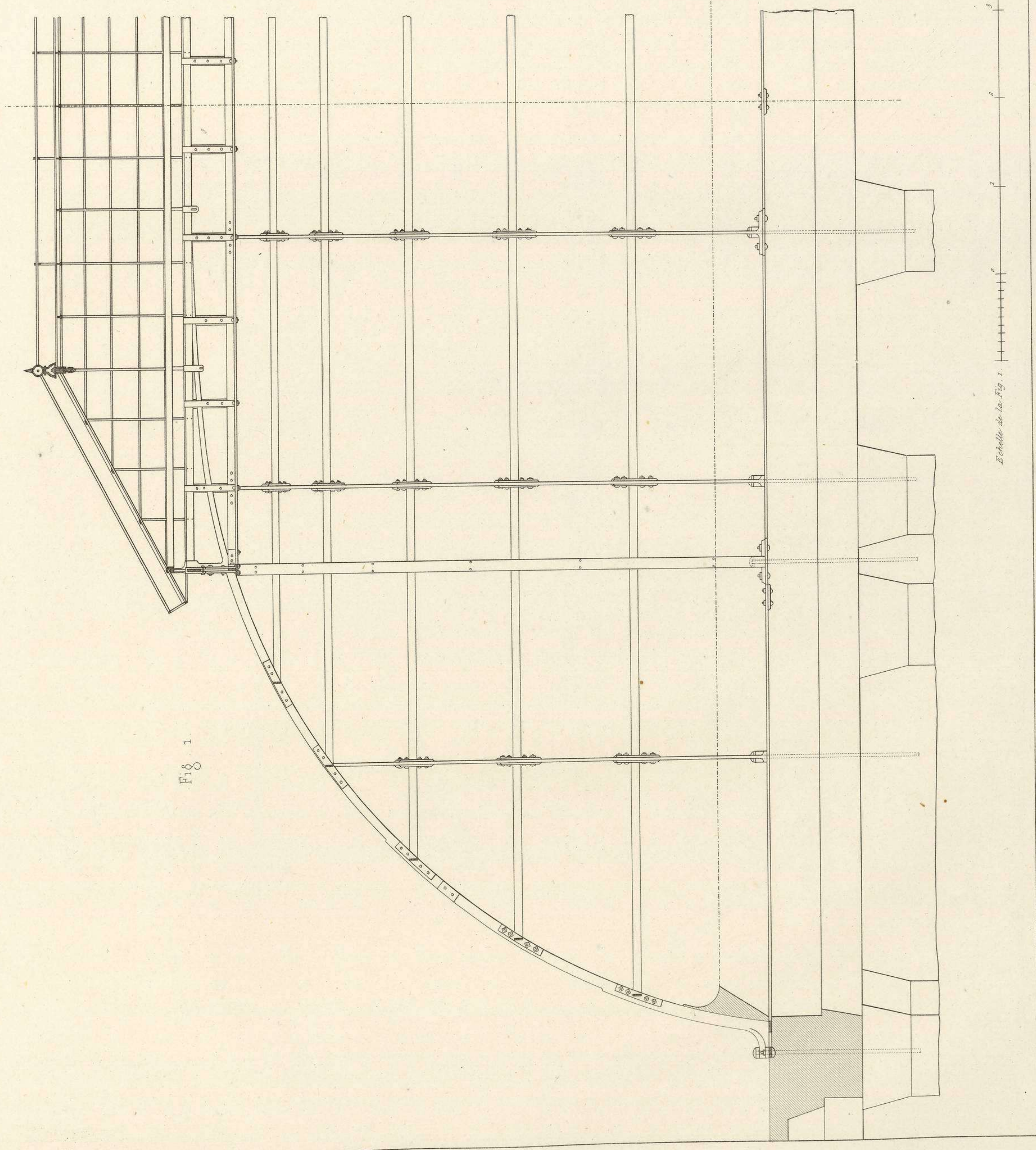

Fig. 1.

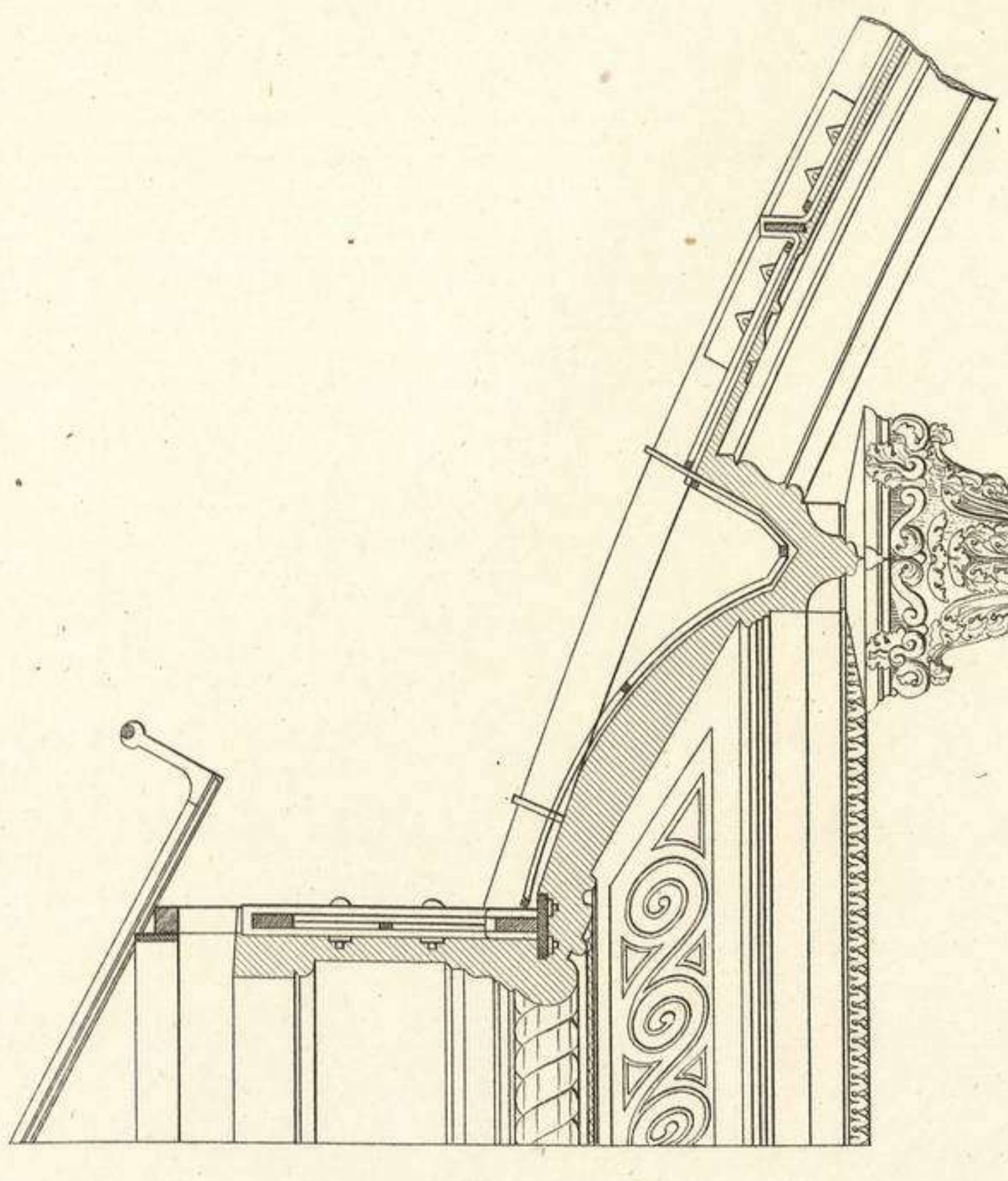

Fig. 2.

Fig. 3.

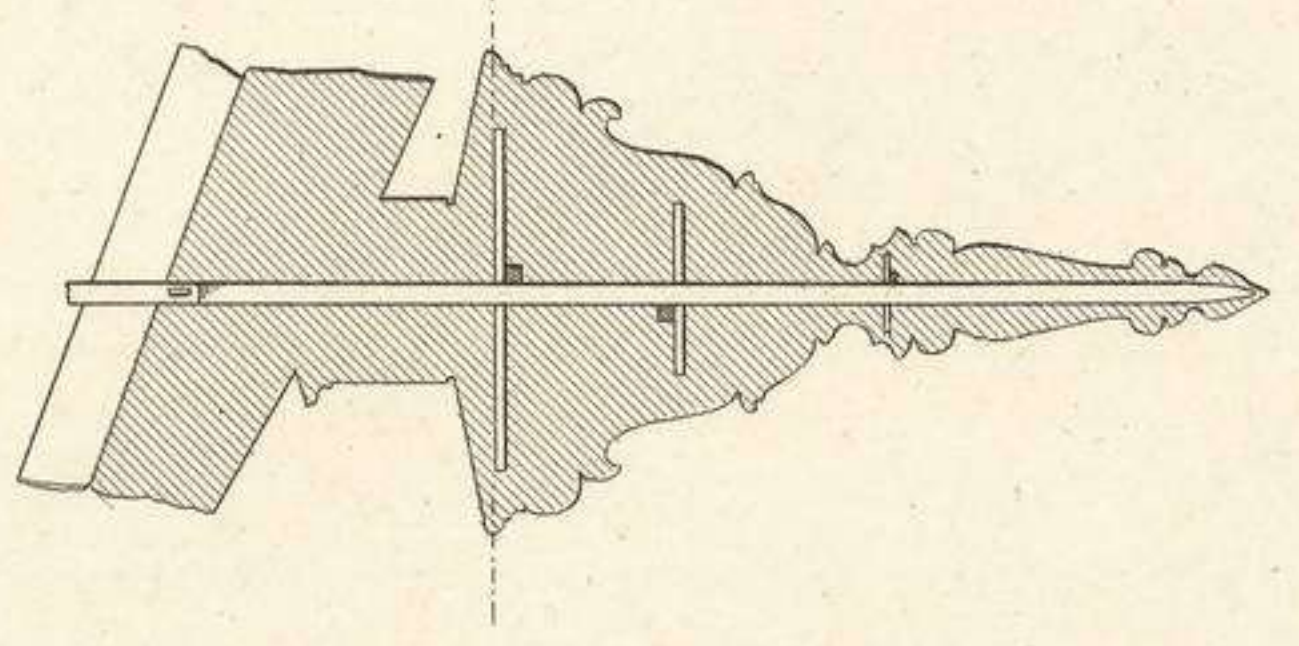
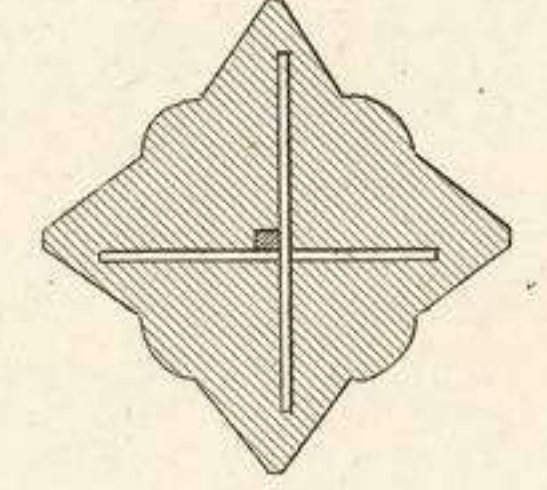

Fig. 4.



Echelle de la Fig. 1. 1 2 3 4 5 Mètres

SERRURERIE.  
Combles.

B. et V. del.

H. B.



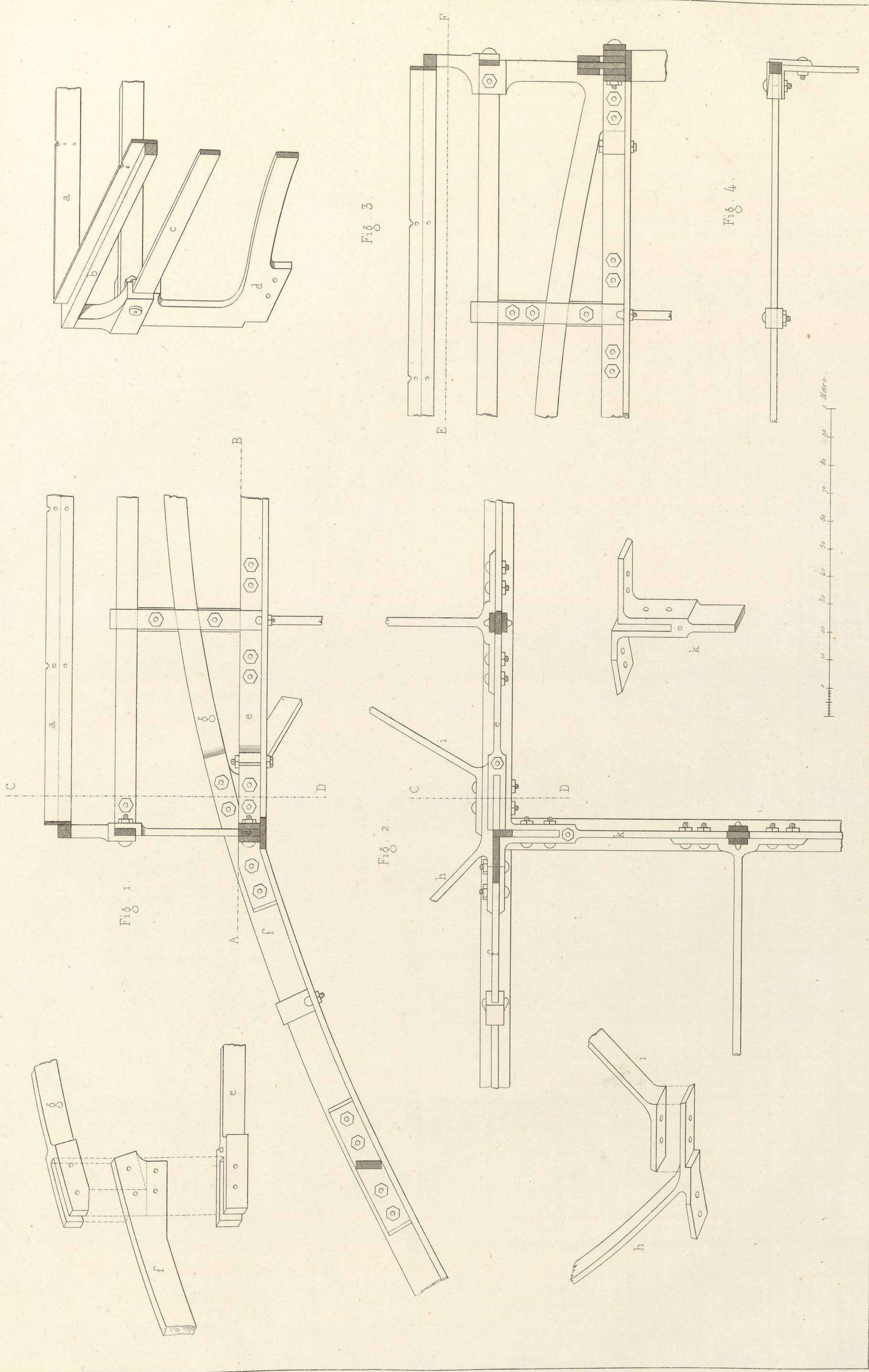

SERRURERIE.  
Combles.

H. R.



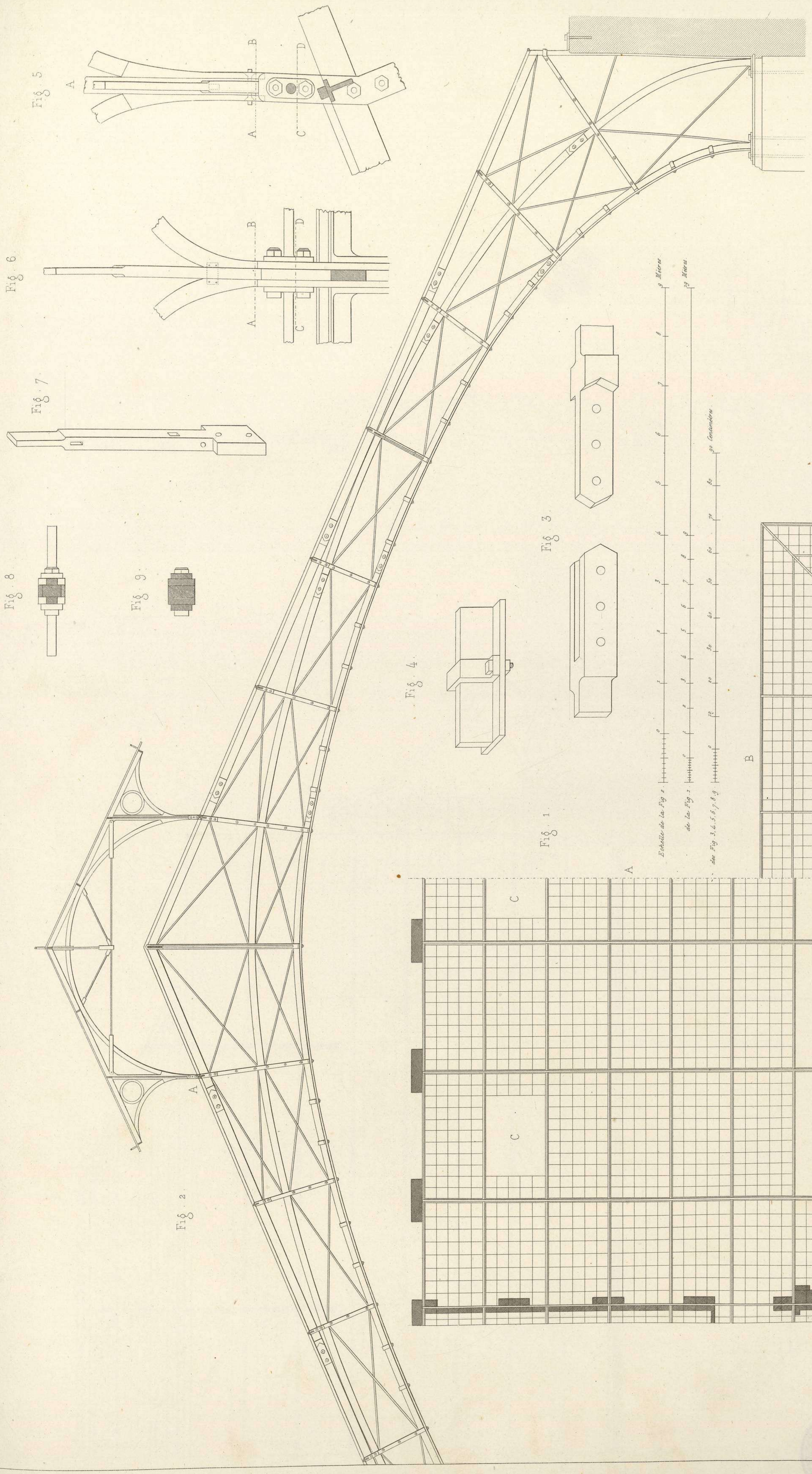

Fig. 1.

Fig. 8.

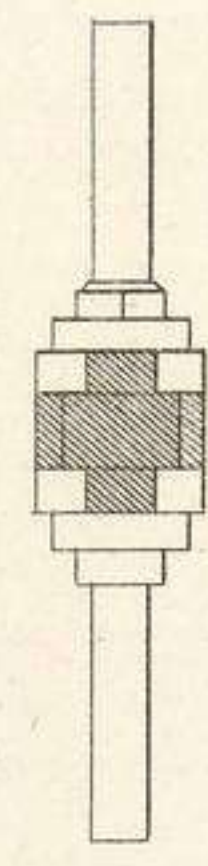

Fig. 9.

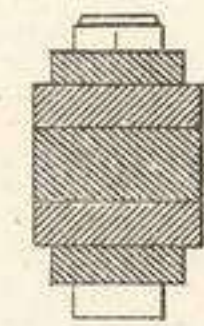

Fig. 7.

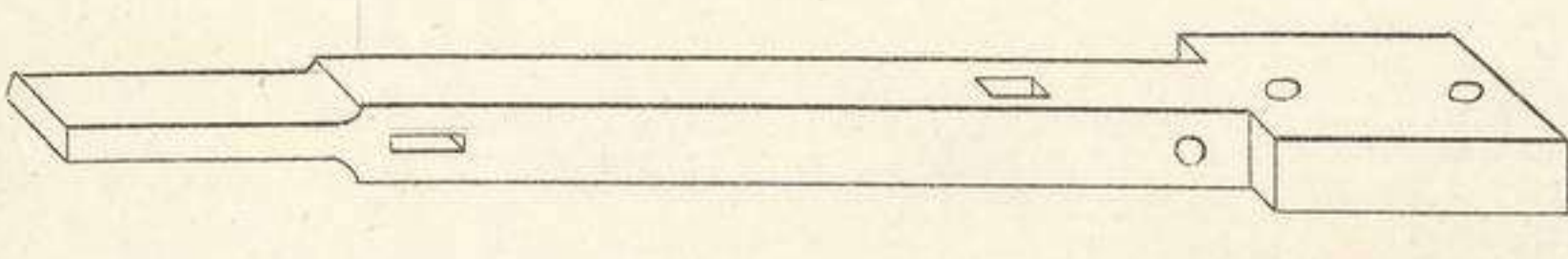

Fig. 6.

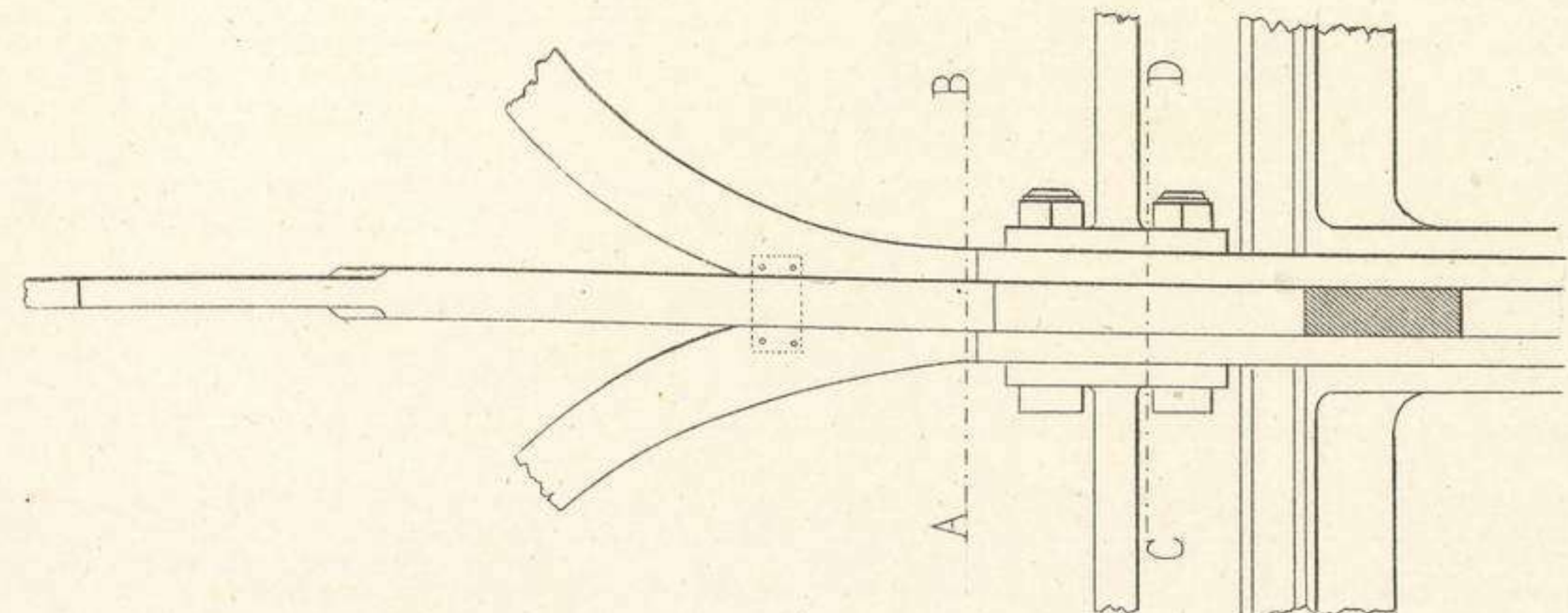

Fig. 5.

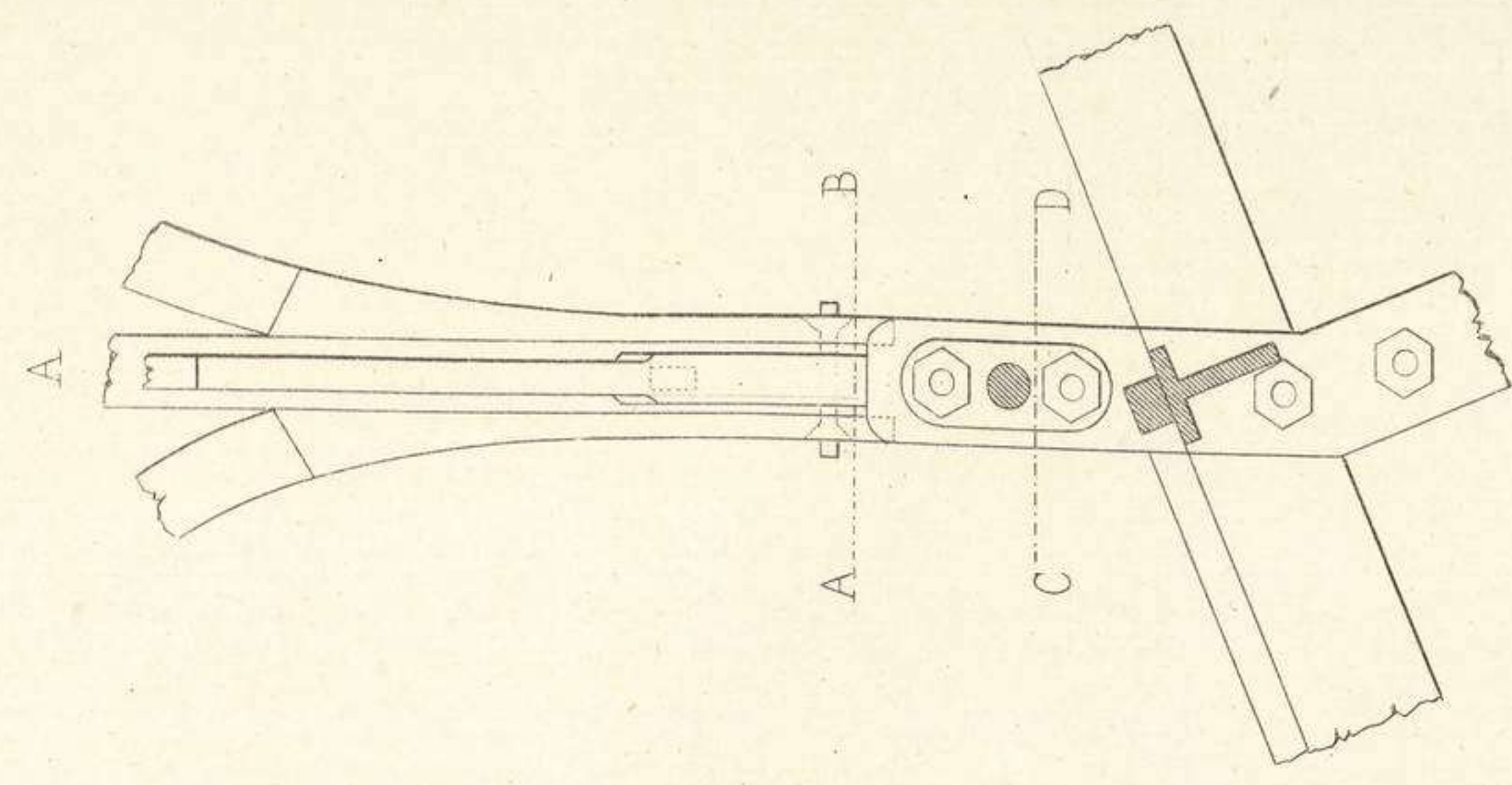

Fig. 4.

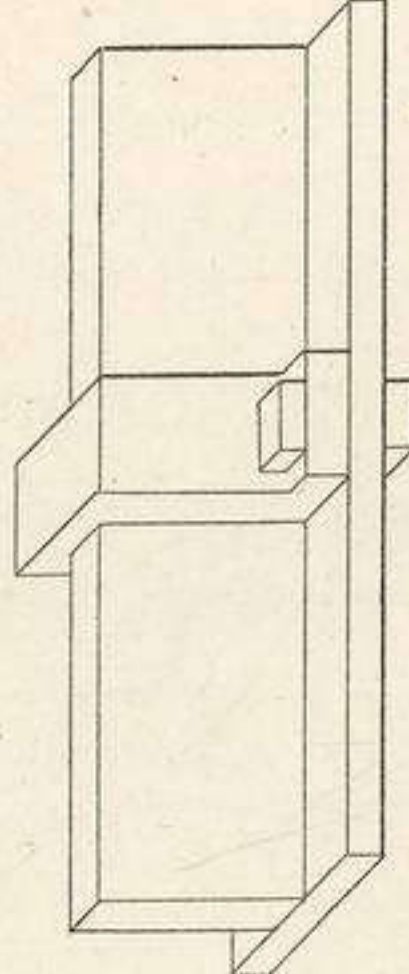

Fig. 3.

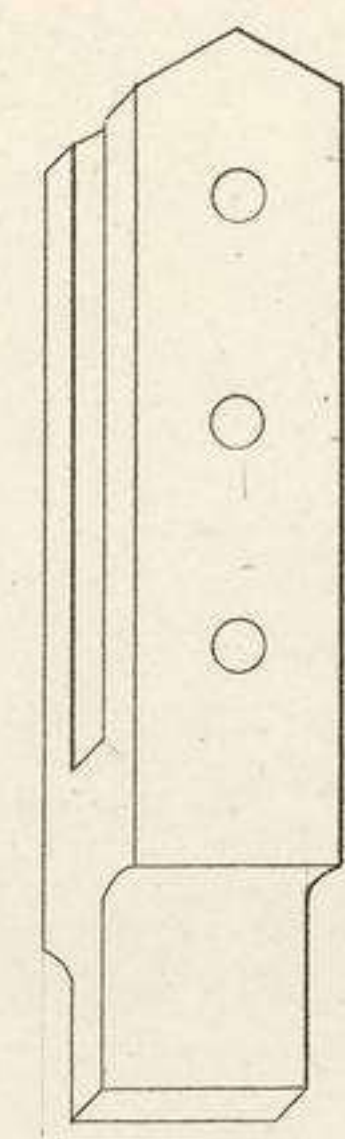
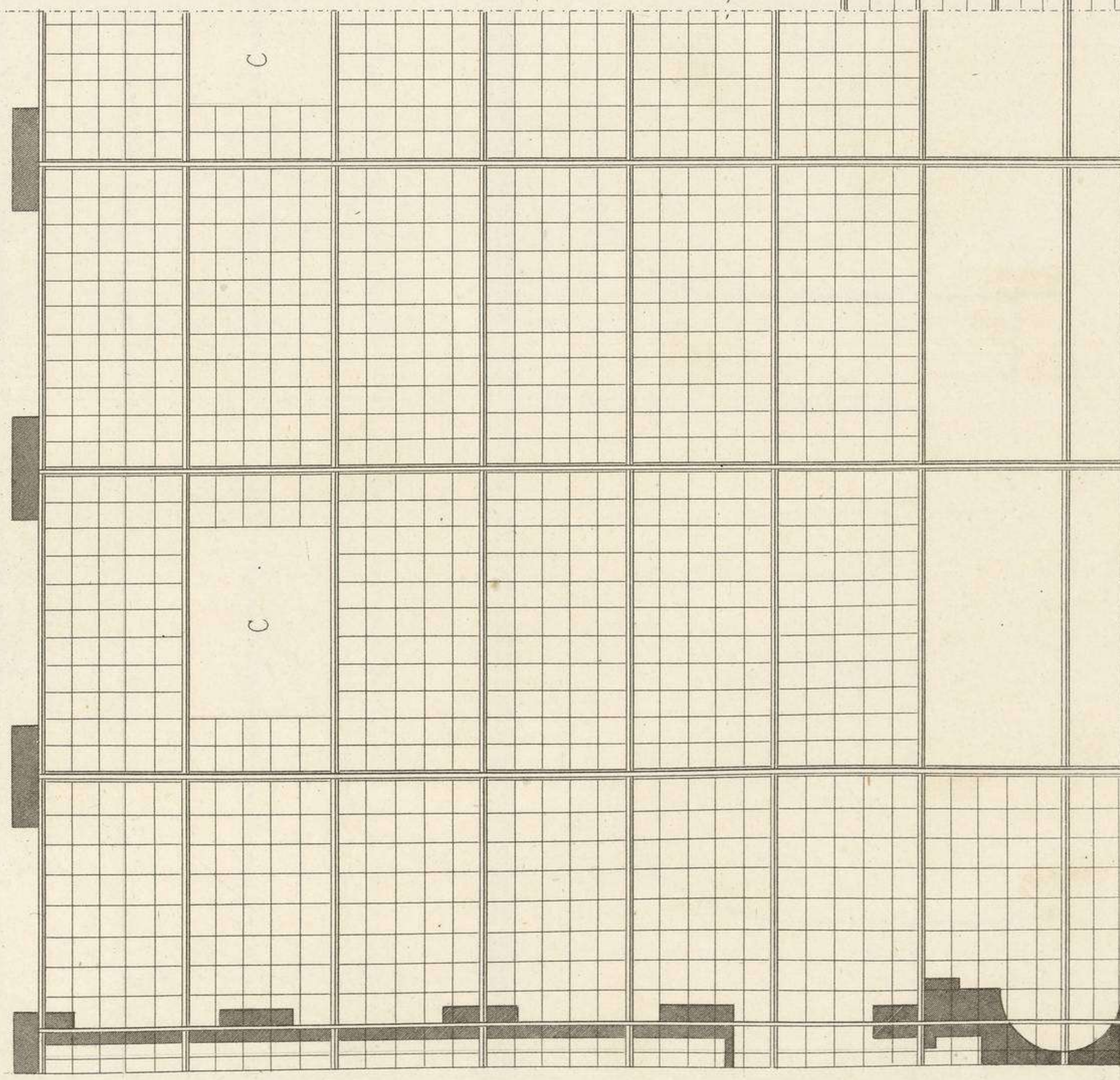
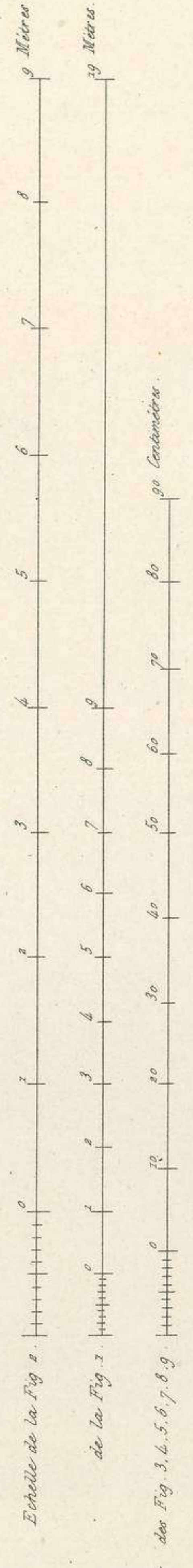
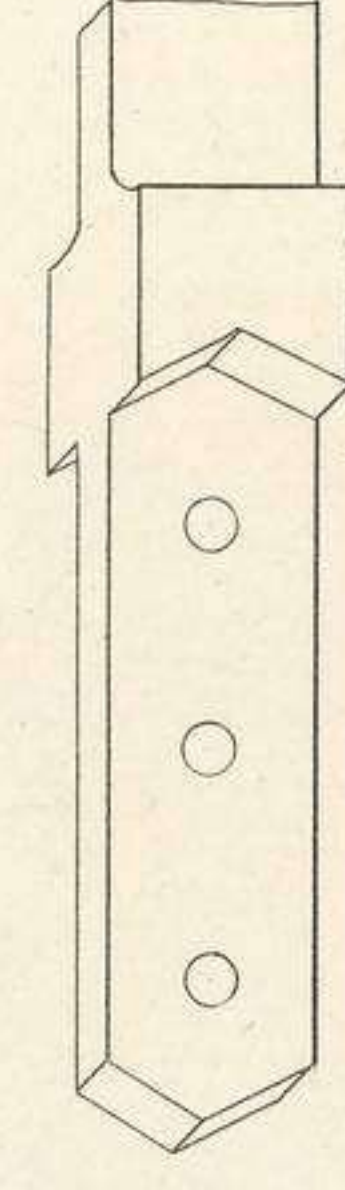

Fig. 3.



SERRURERIE.  
Combles.



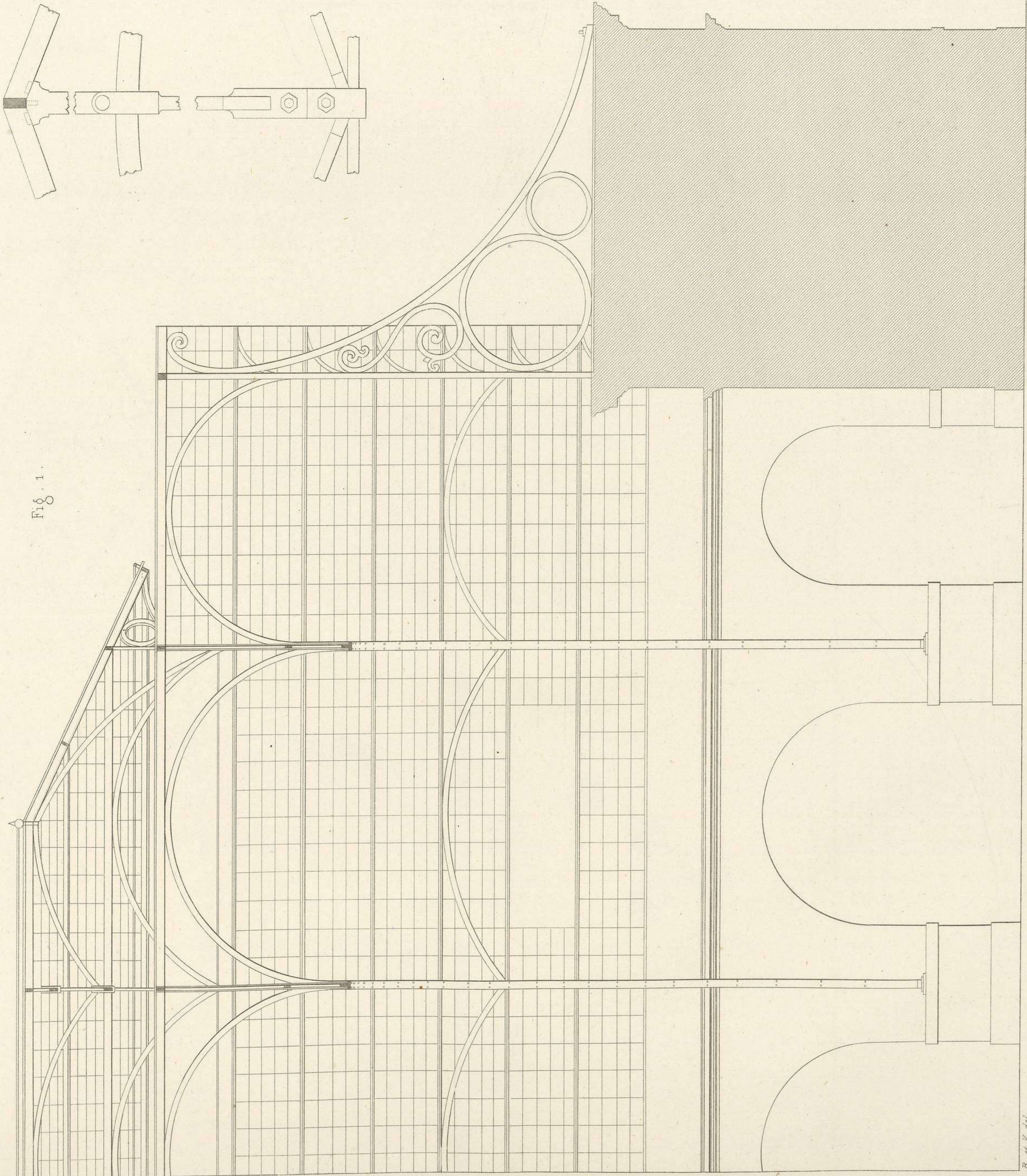

Fig. 3.

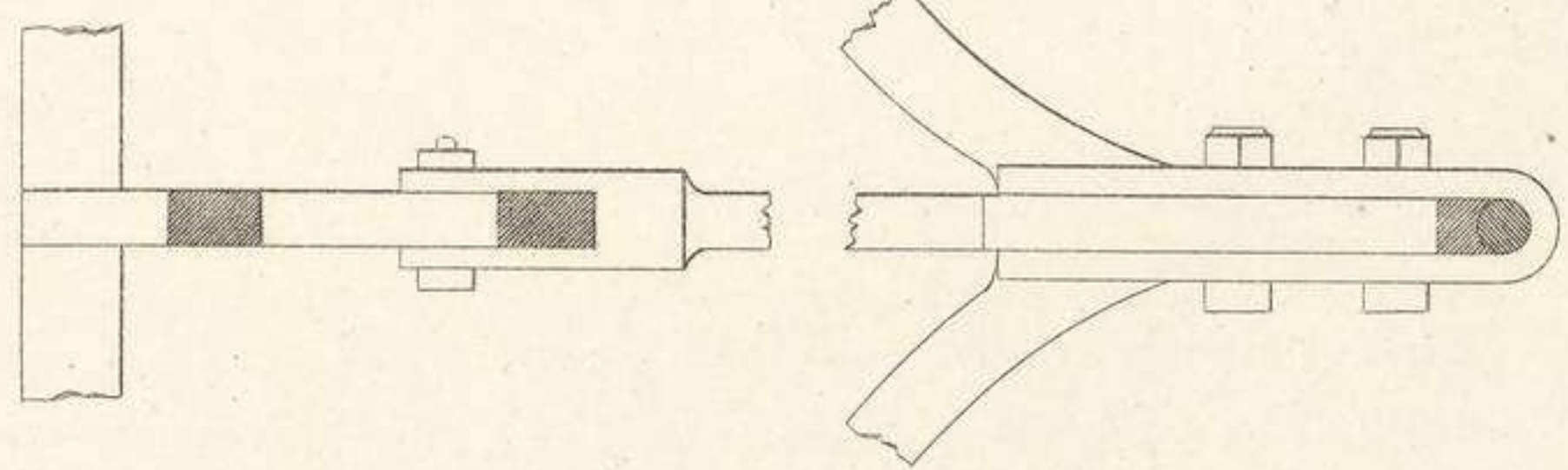

Fig. 2.

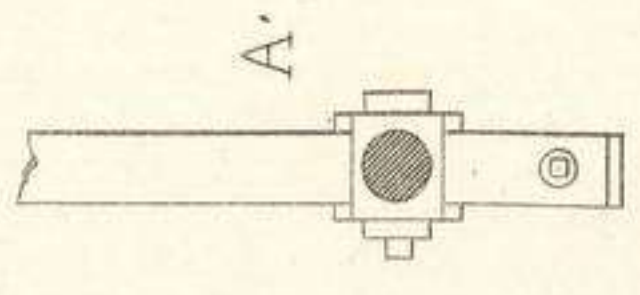
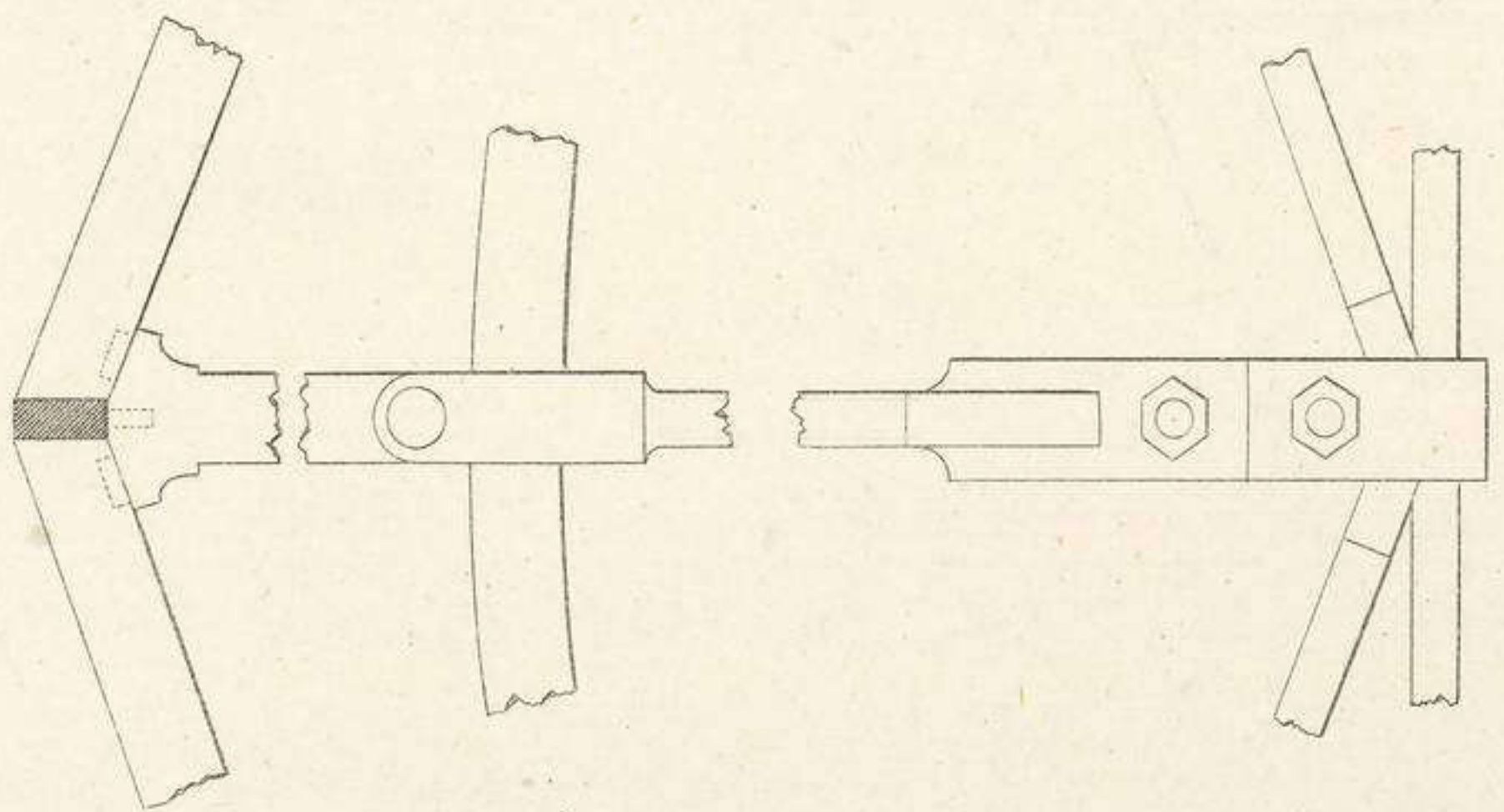

Fig. 4.

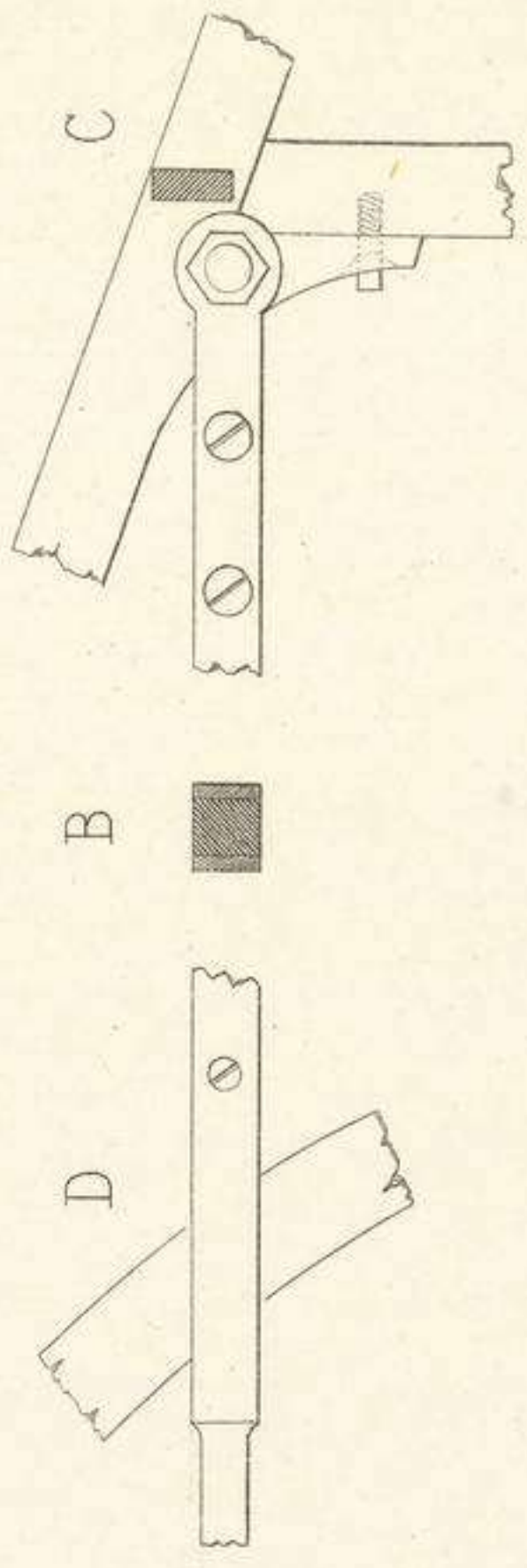

Fig. 5.

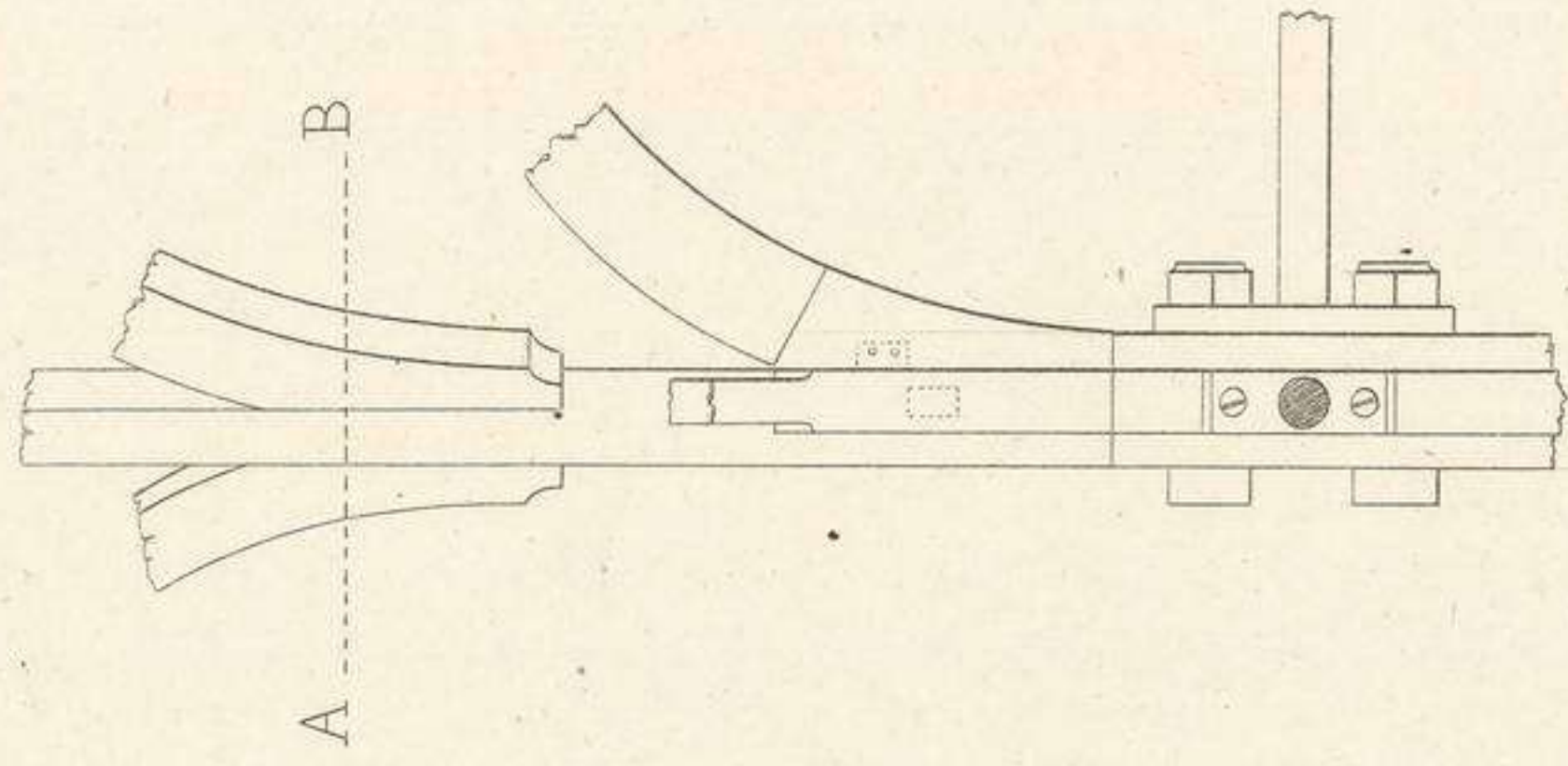

Fig. 7.

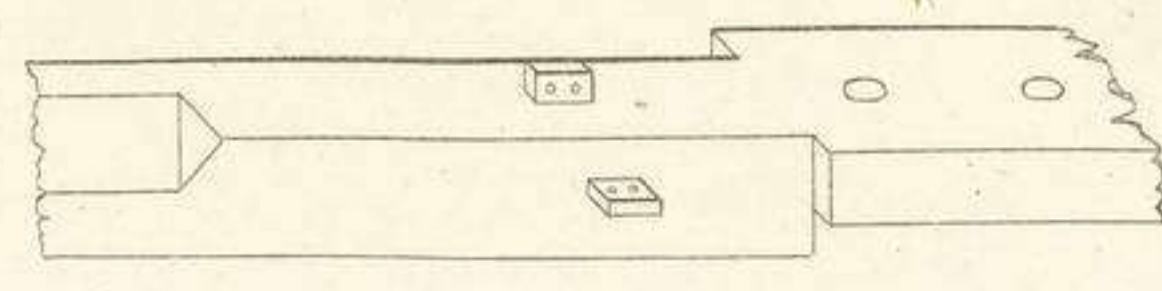
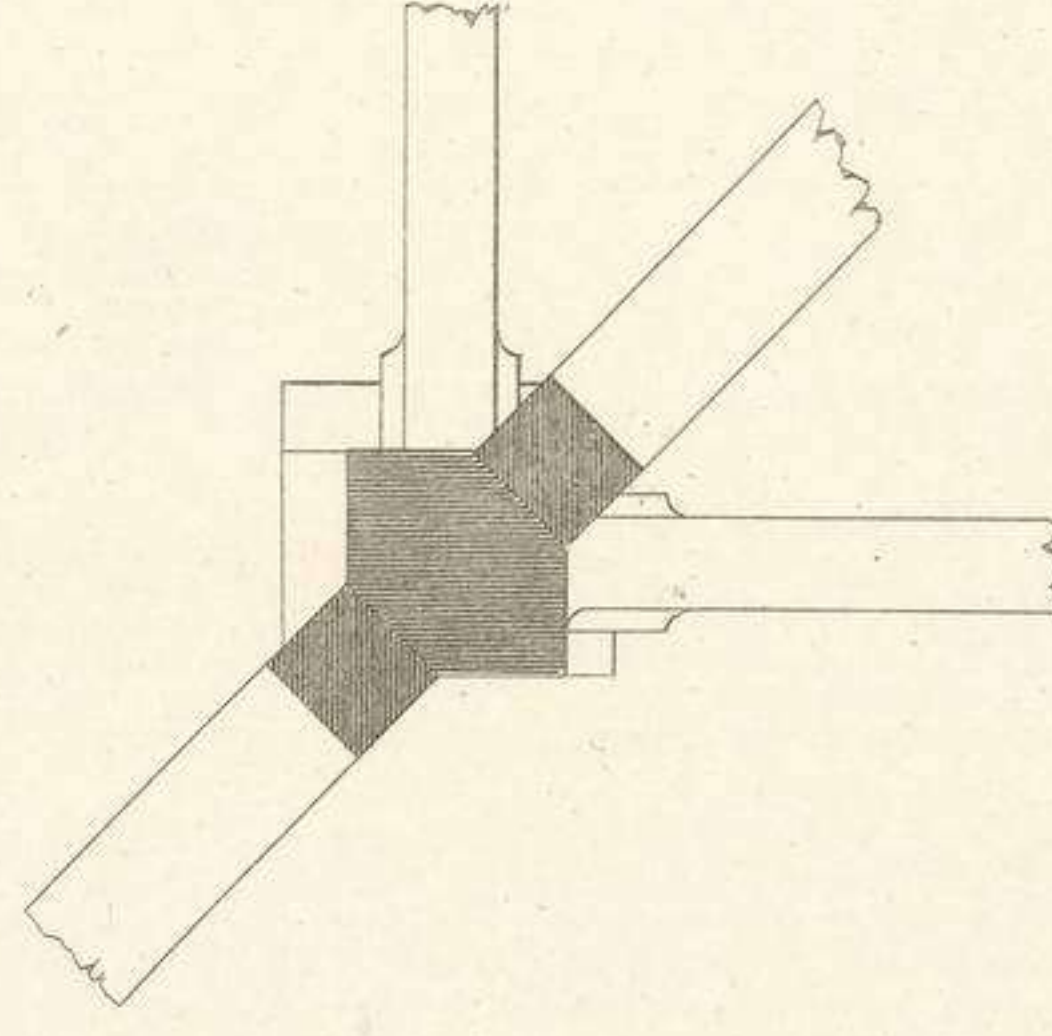
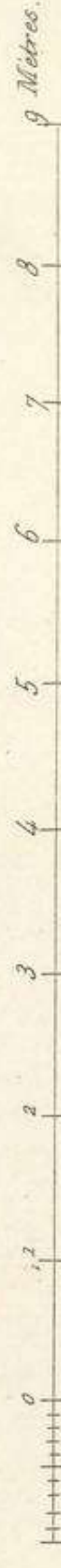

Fig. 6.



Echelle des Fig. 2, 3, 4, 5.



Echelle de la Fig. 1.



B. et P. del.

H. R.

SERRURERIE.  
Combles.



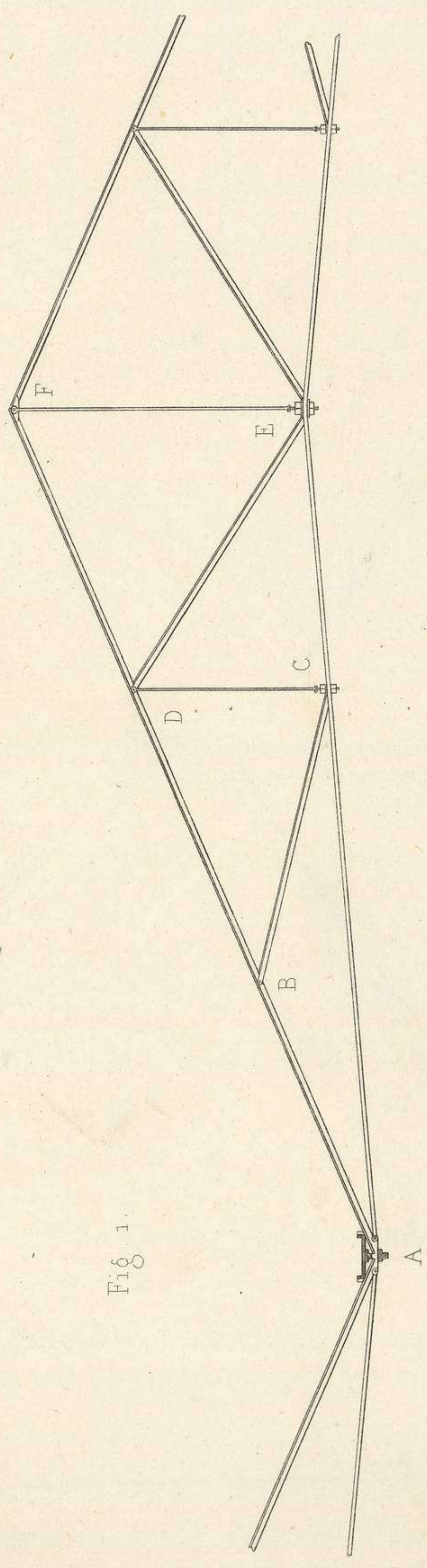

Fig. 4

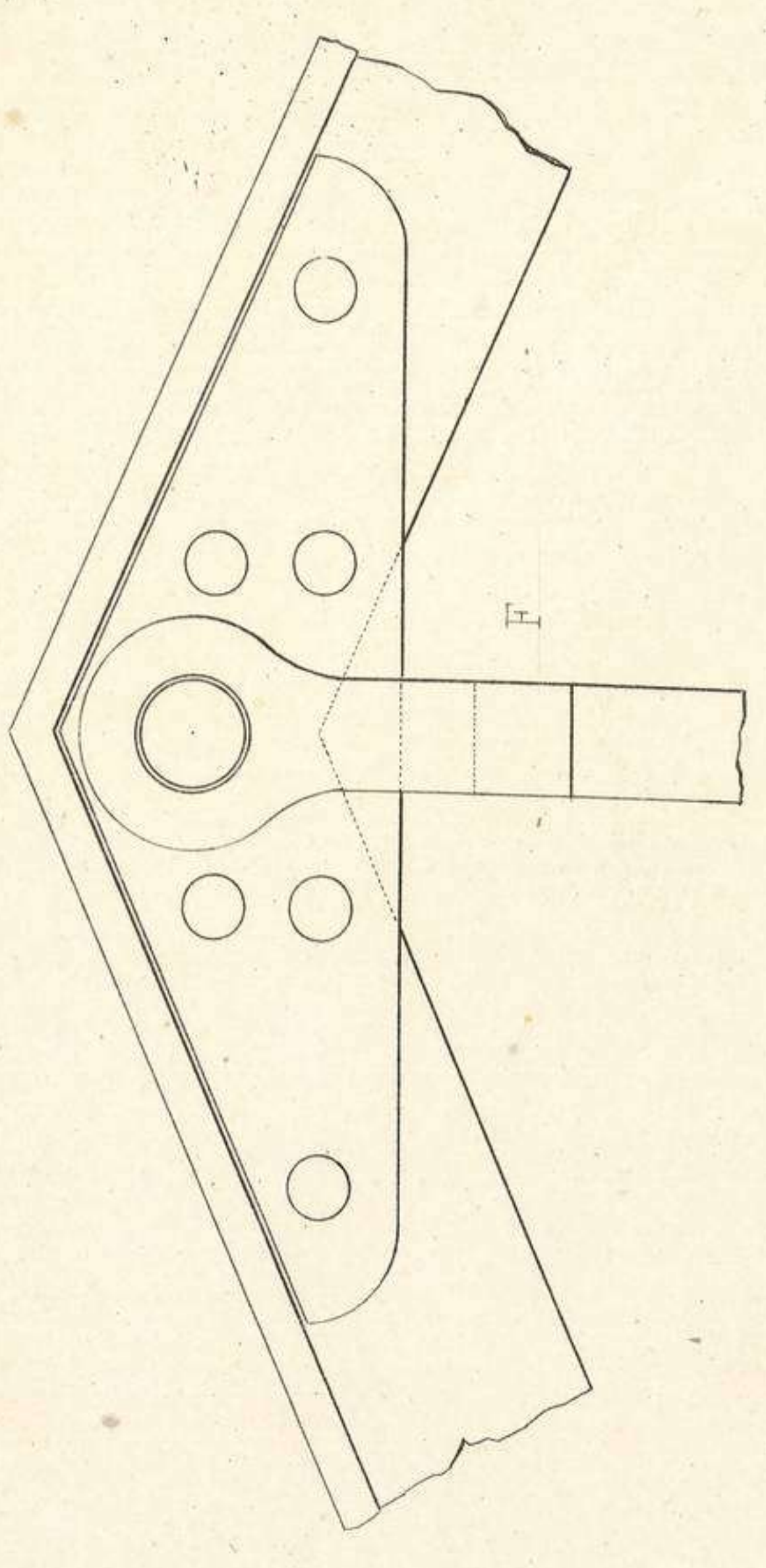
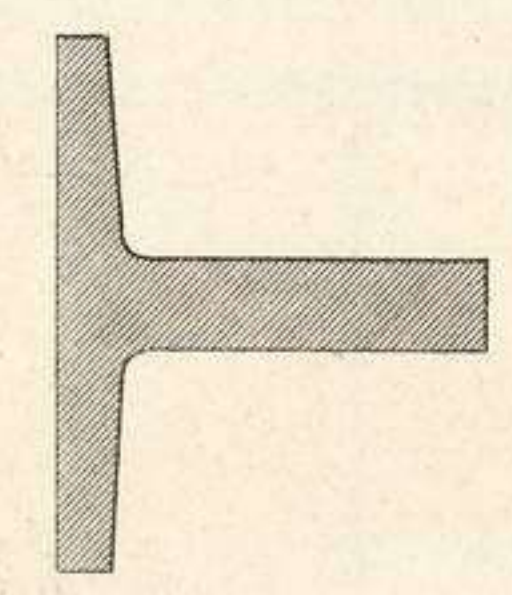

Fig. 6

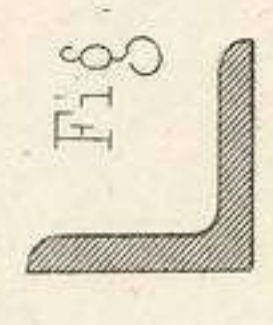

Fig. 5

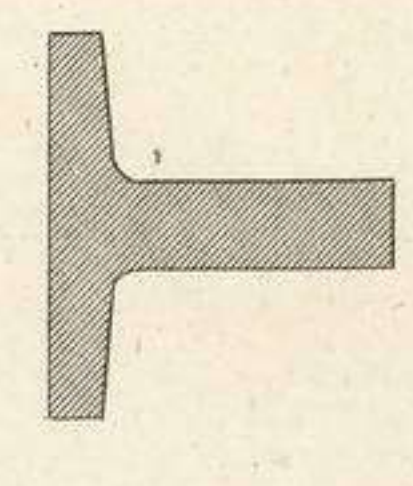

Fig. 3

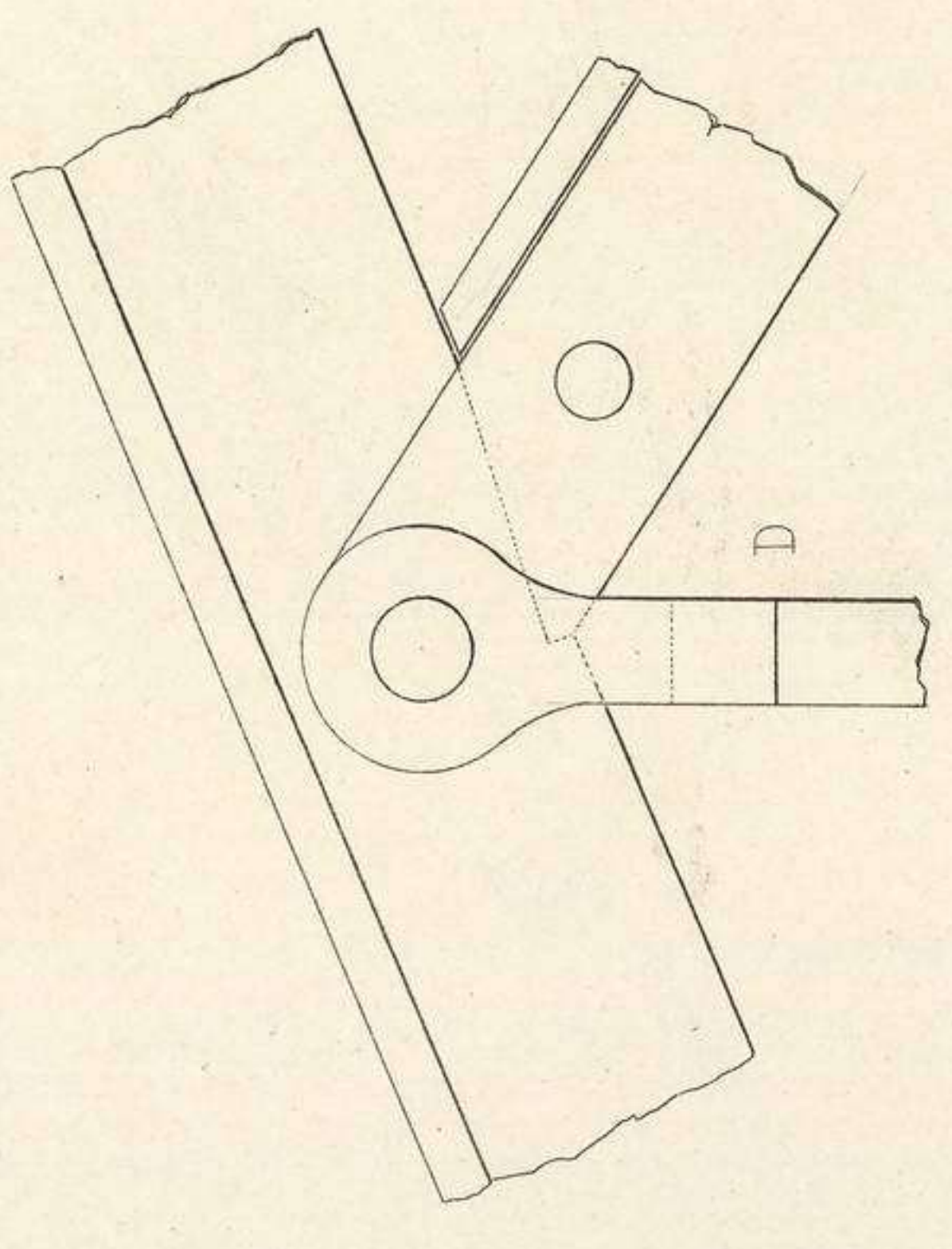
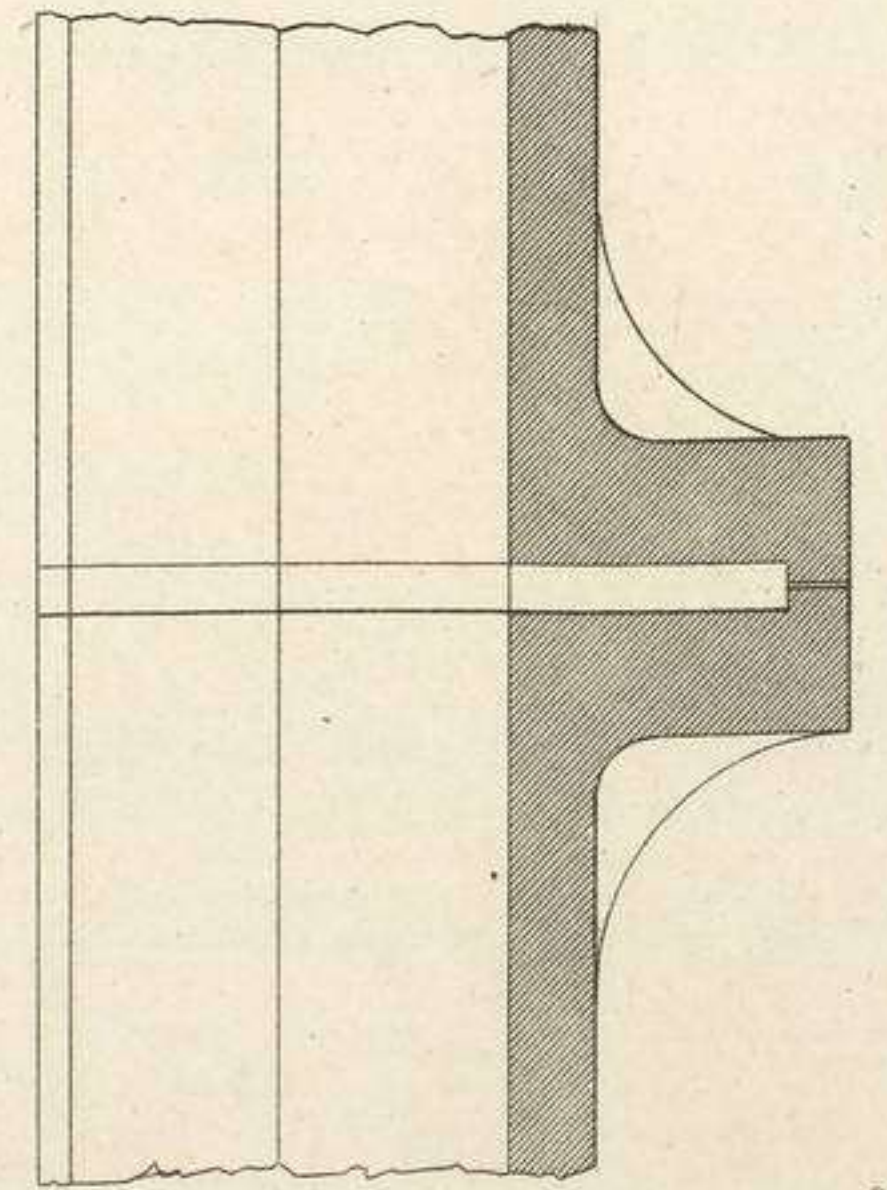

Fig. 2

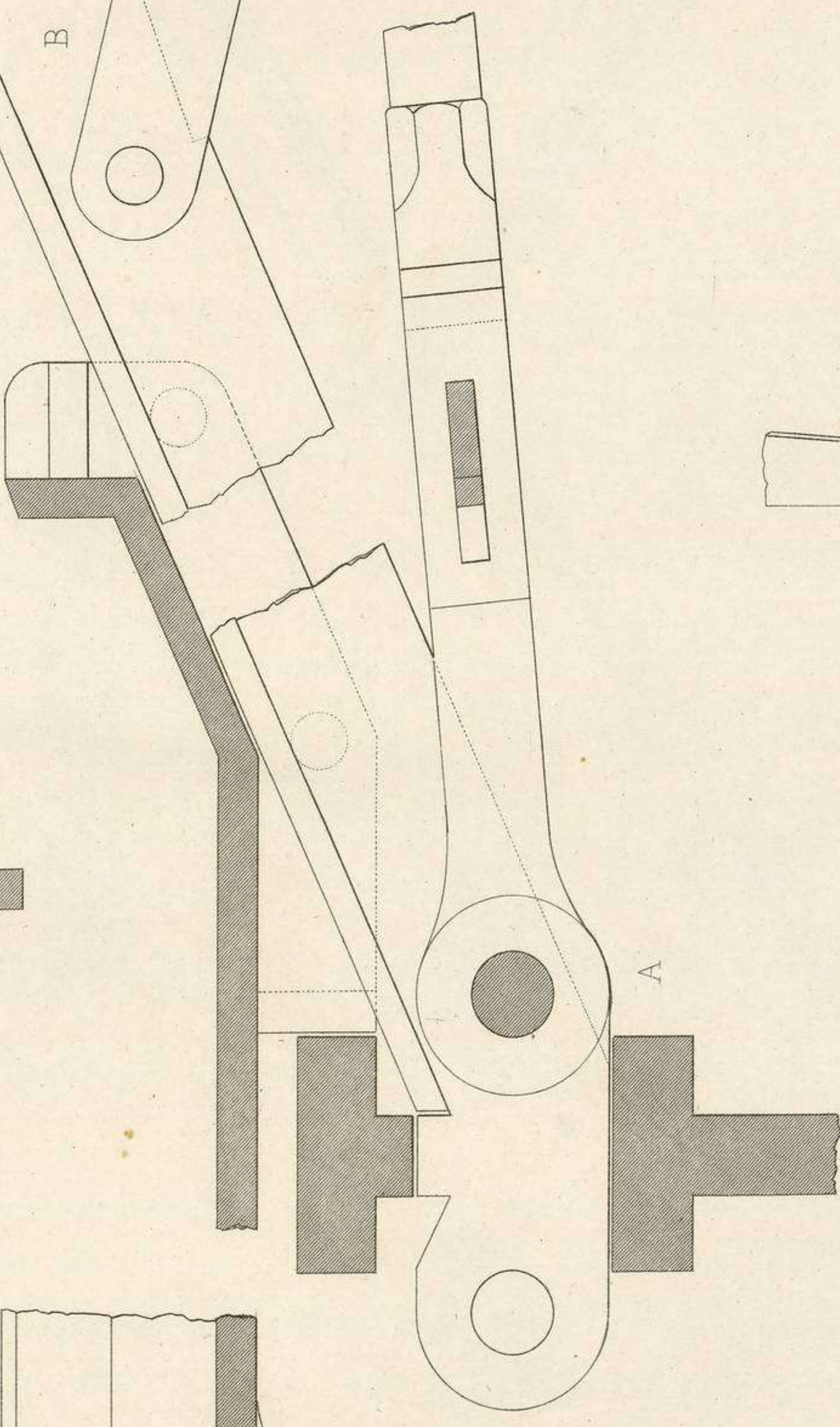
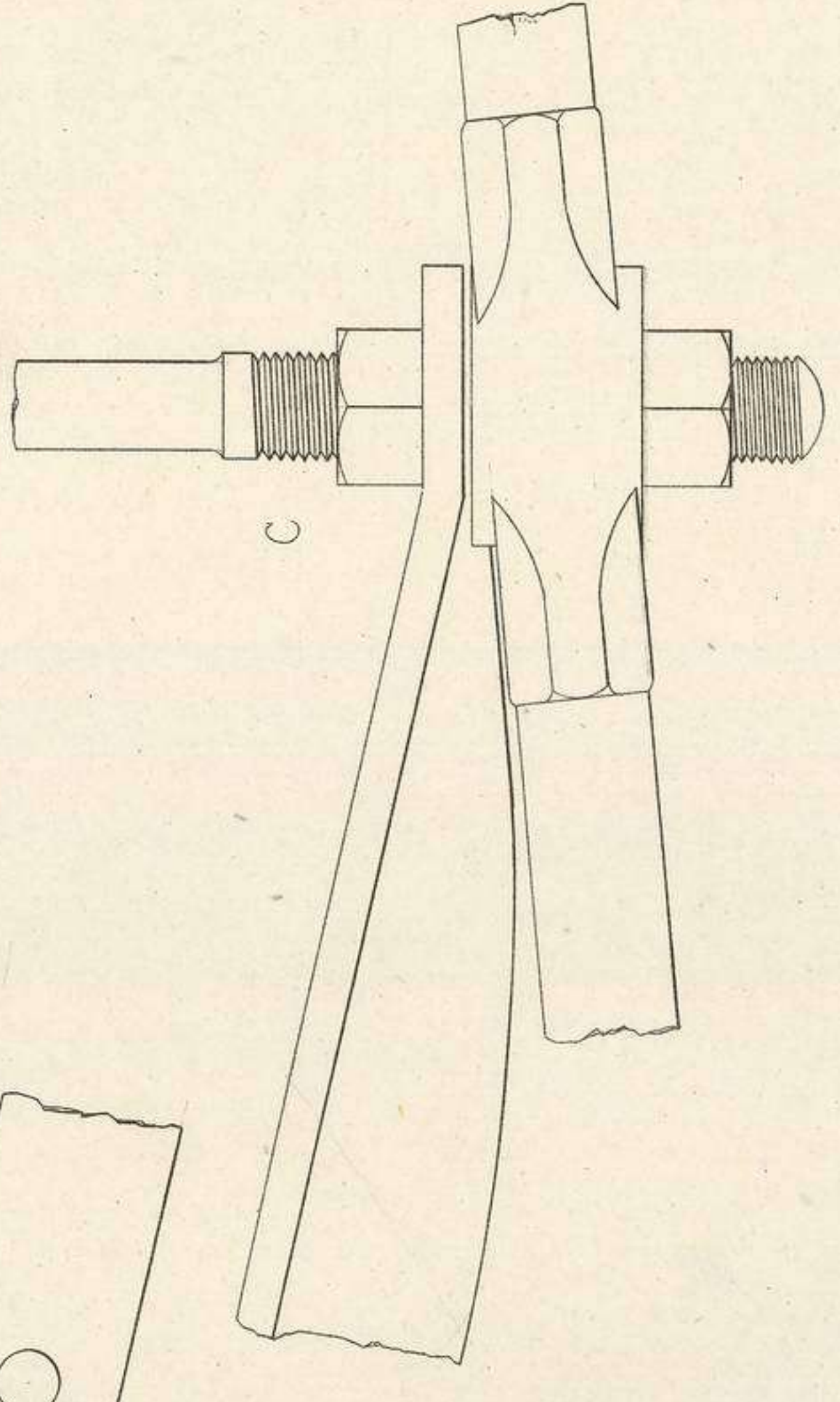
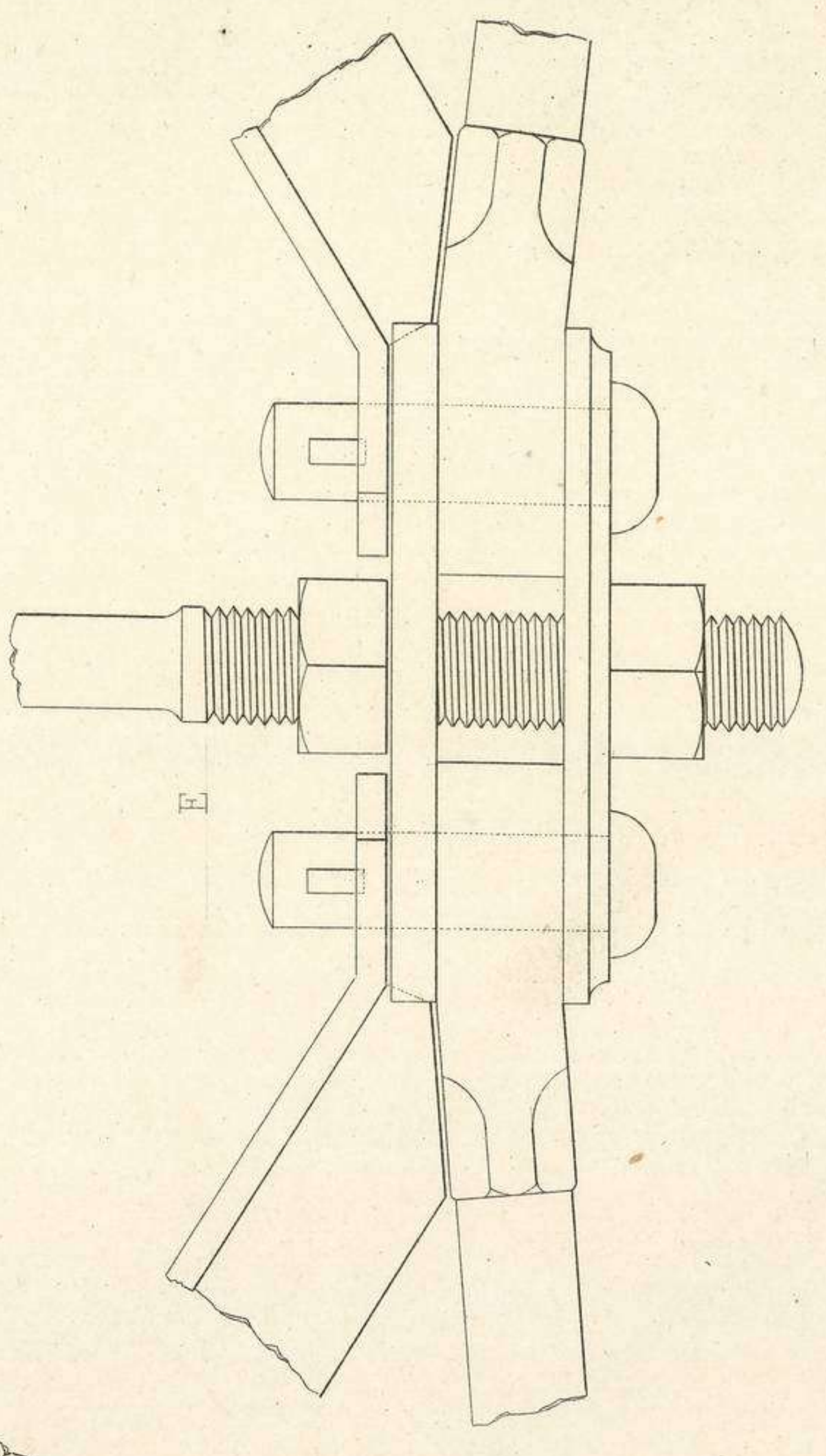

Fig. 7

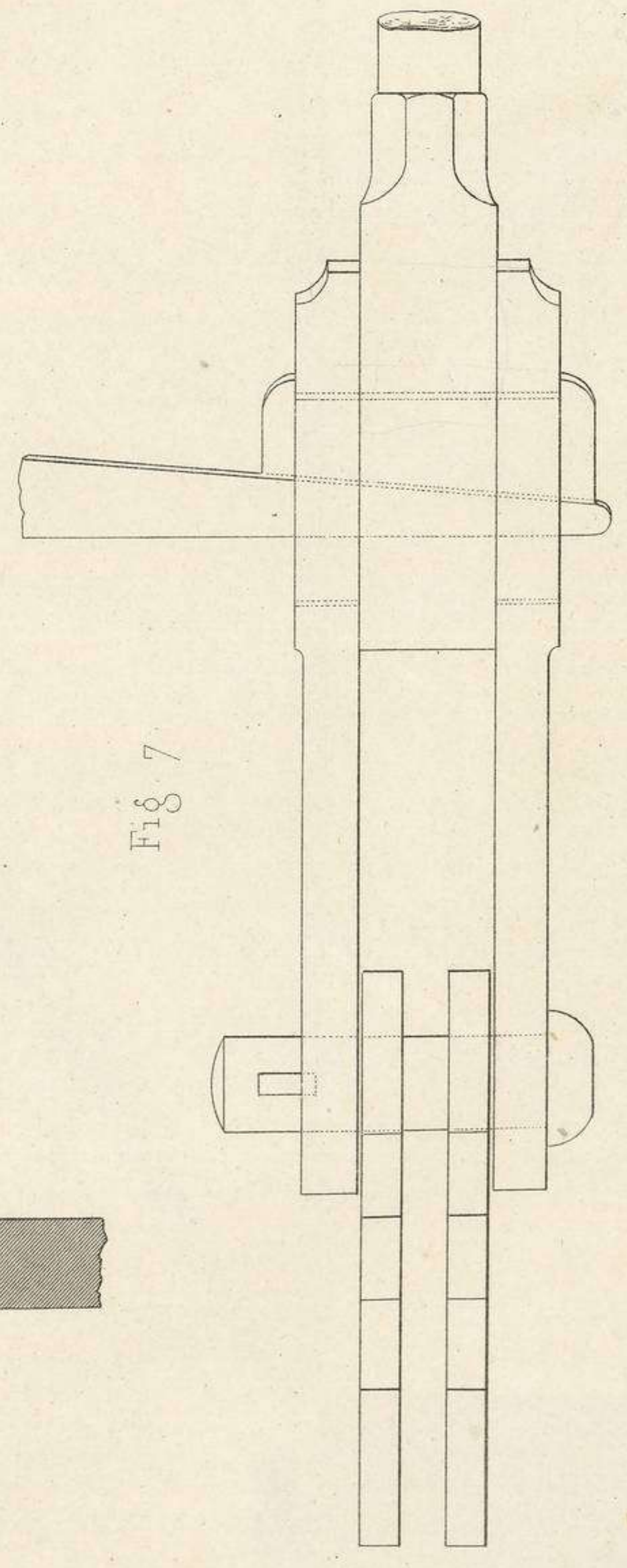

Fig. 8

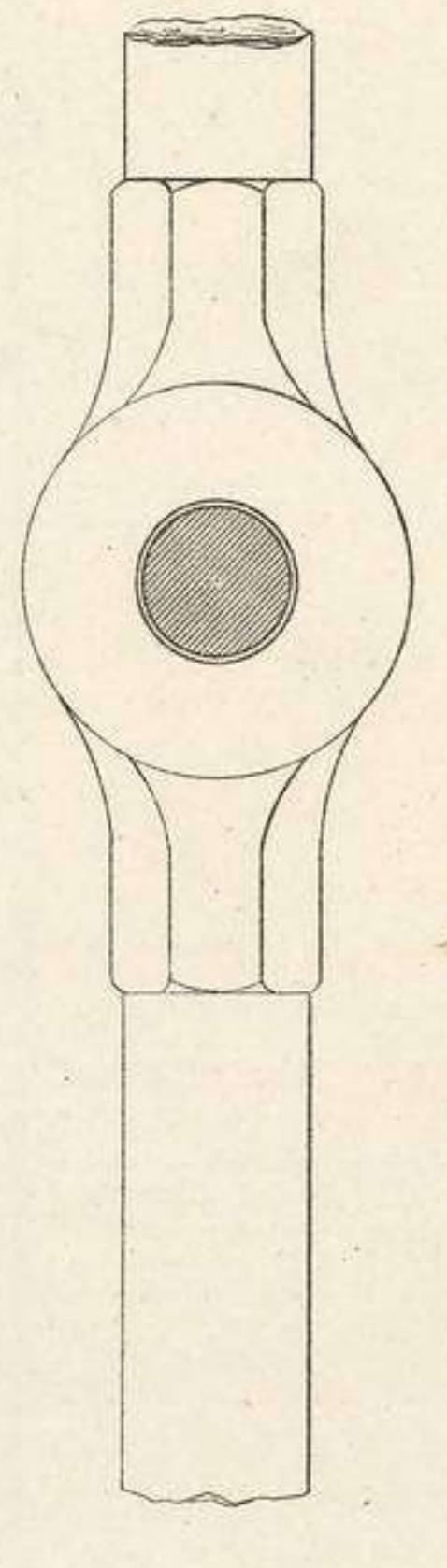
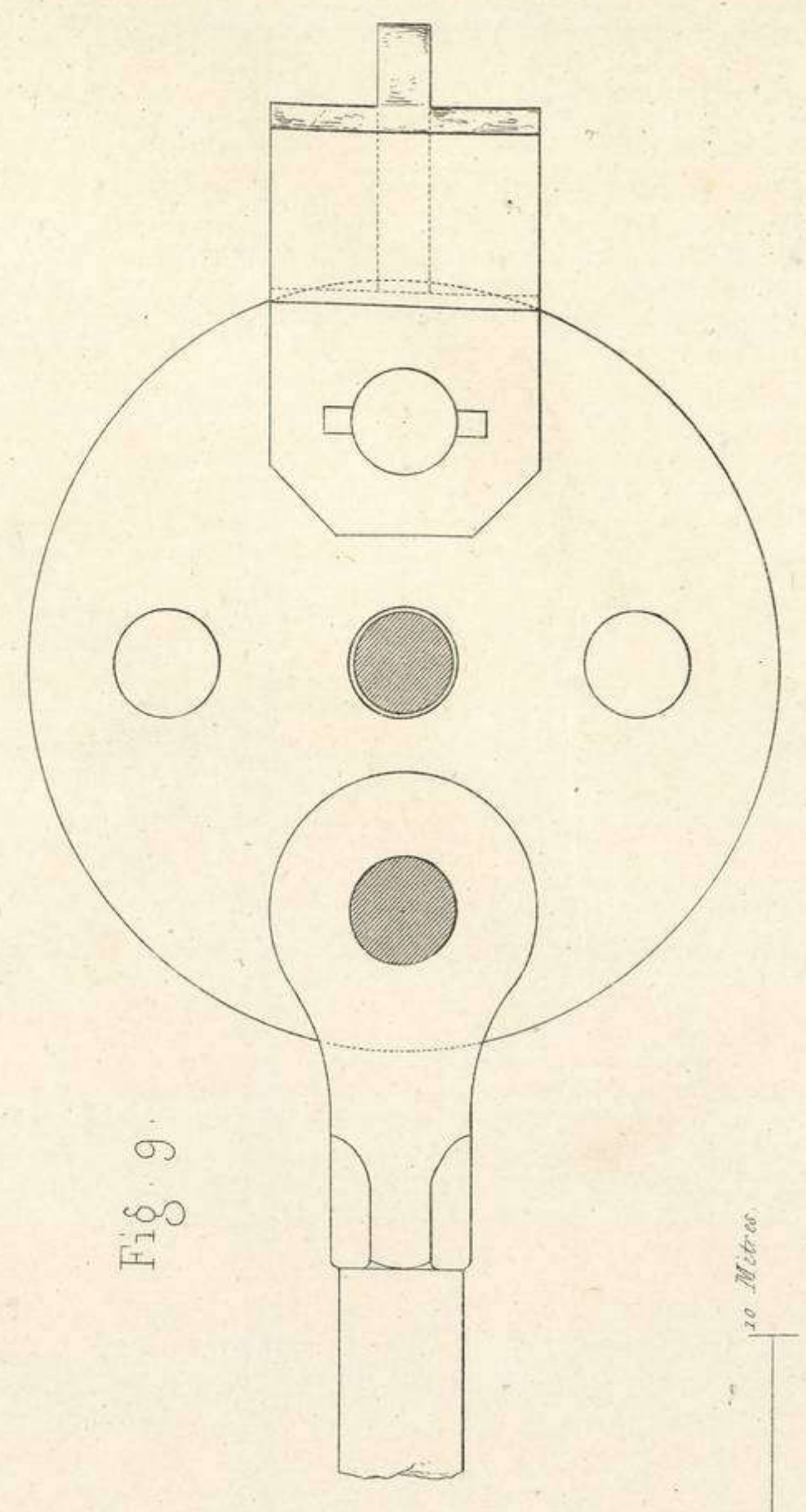

Fig. 9



Echelle de la Fig. 1. ++++++ 10 Mètres

B. et P. del.

SERRURERIE.  
Combles.

H. R.











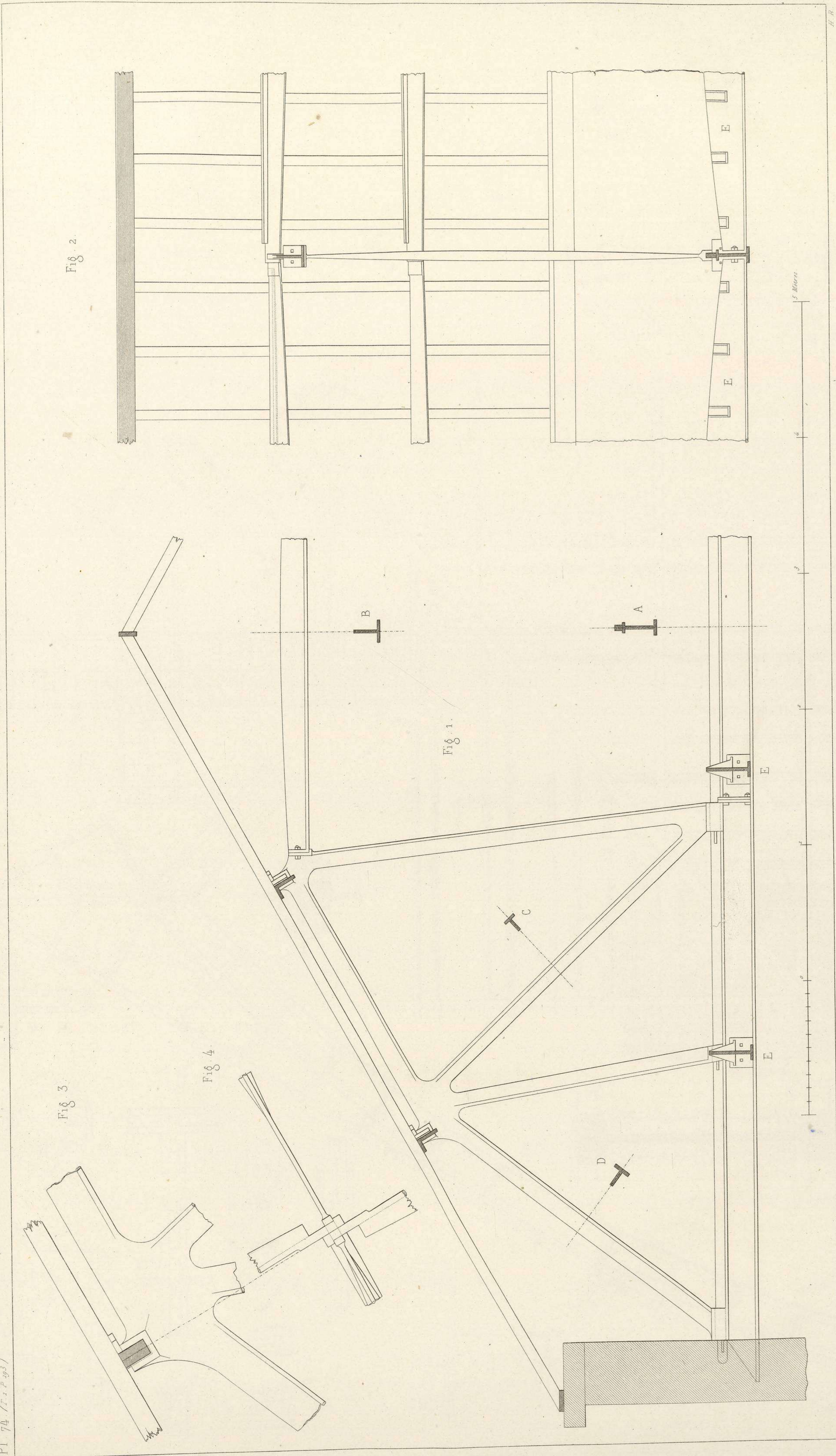

SERRURERIE.  
Combles.

B. de P. de L.



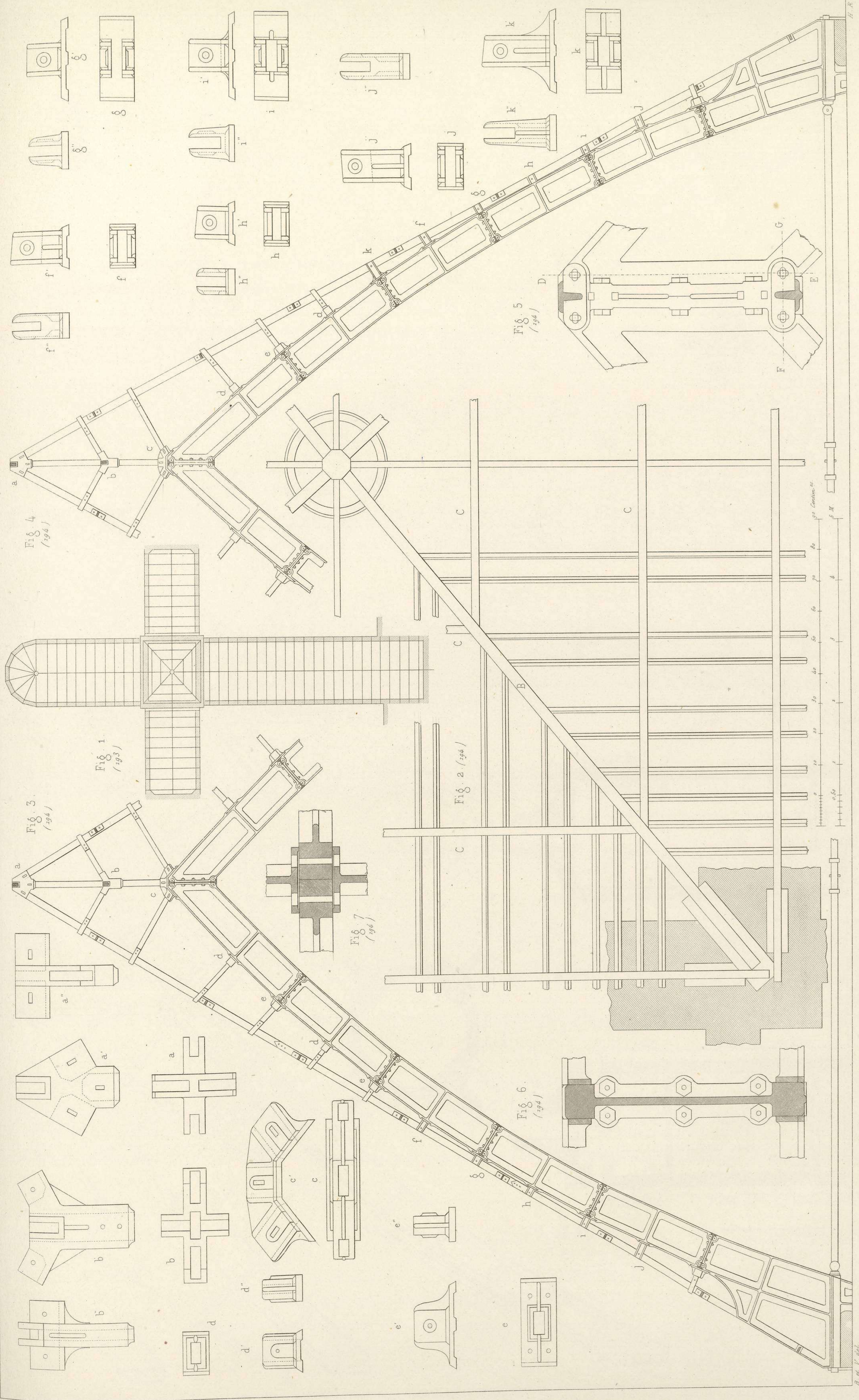



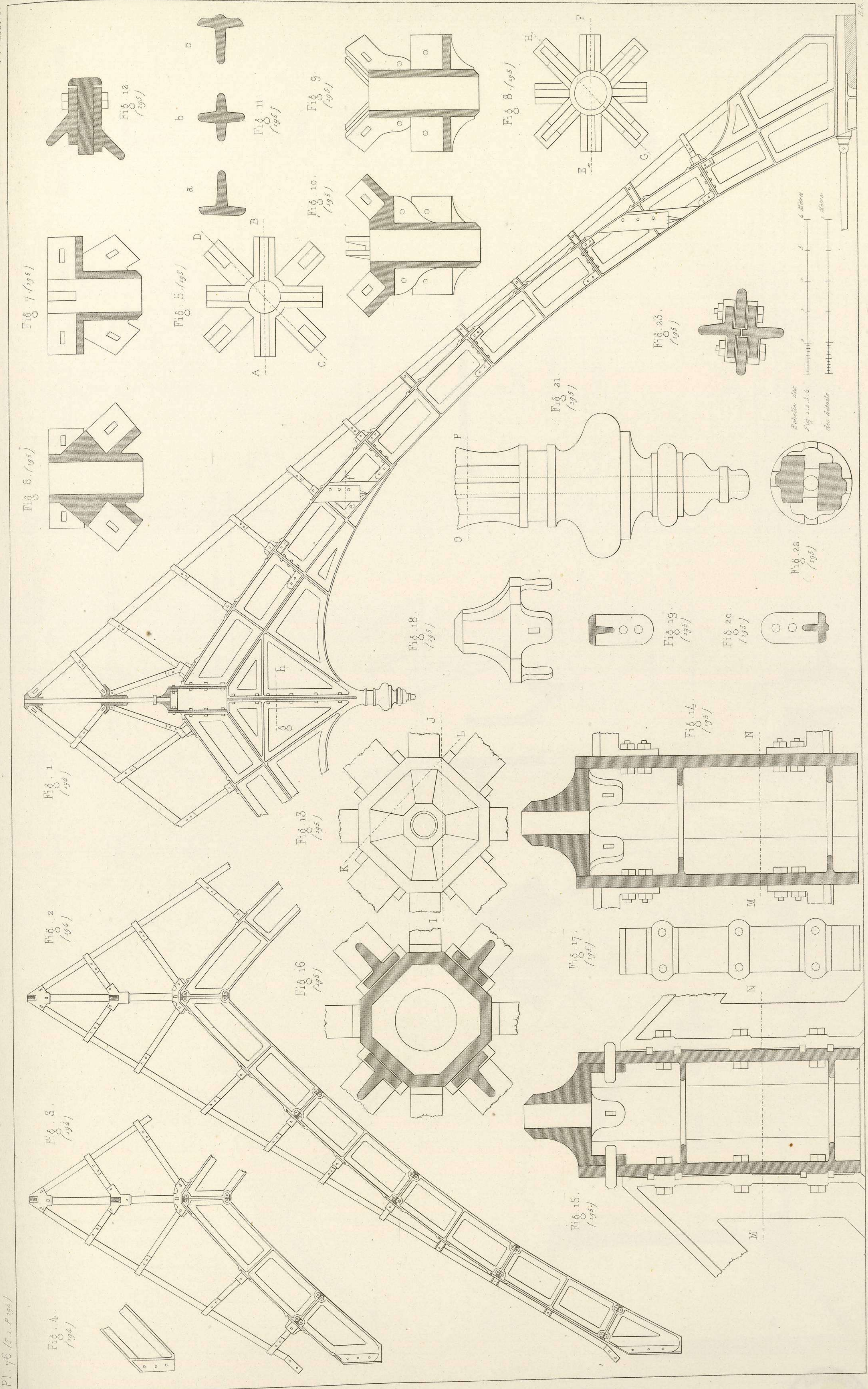



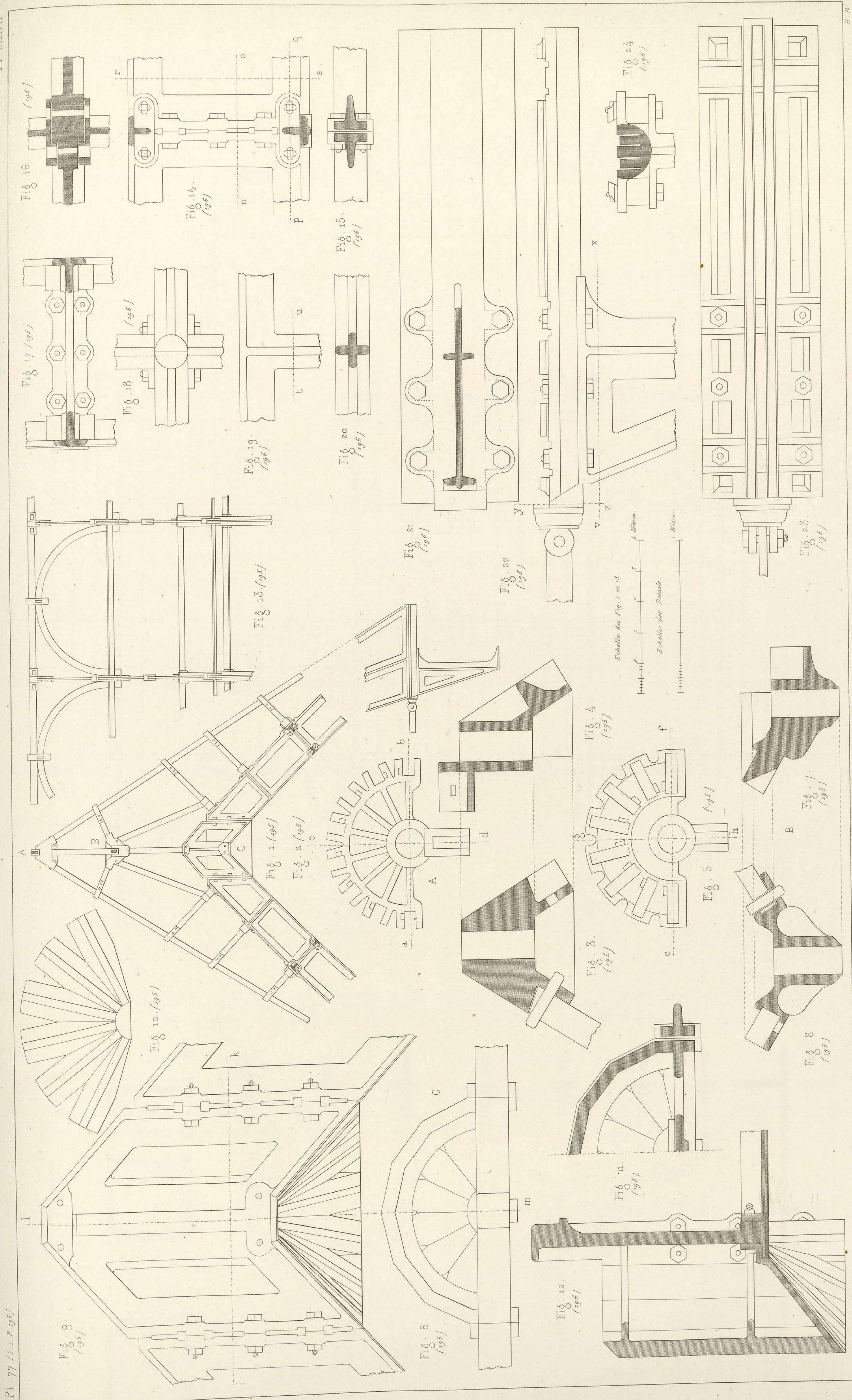

SERRURERIE  
Combles

B. et V. del.

H. B.



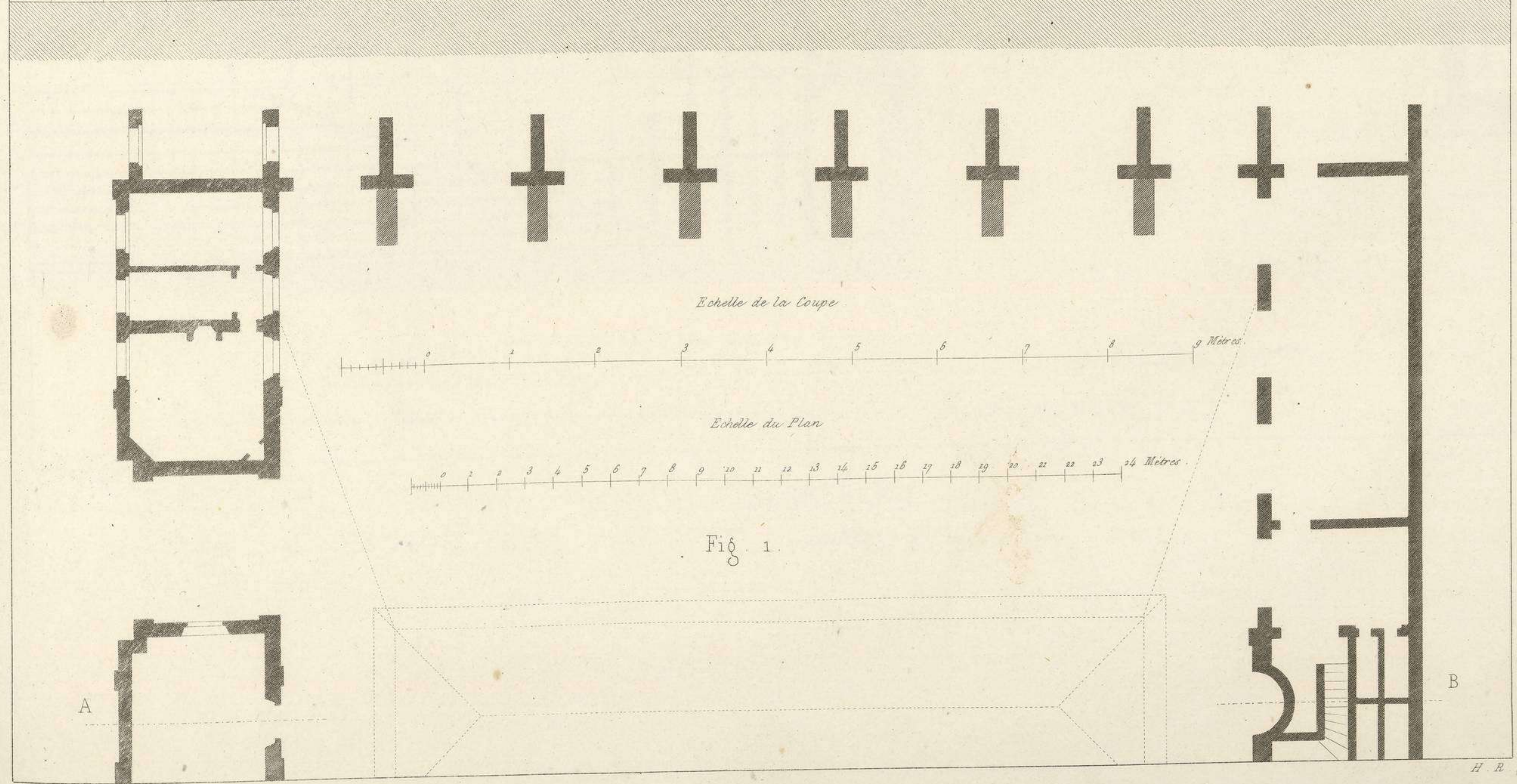
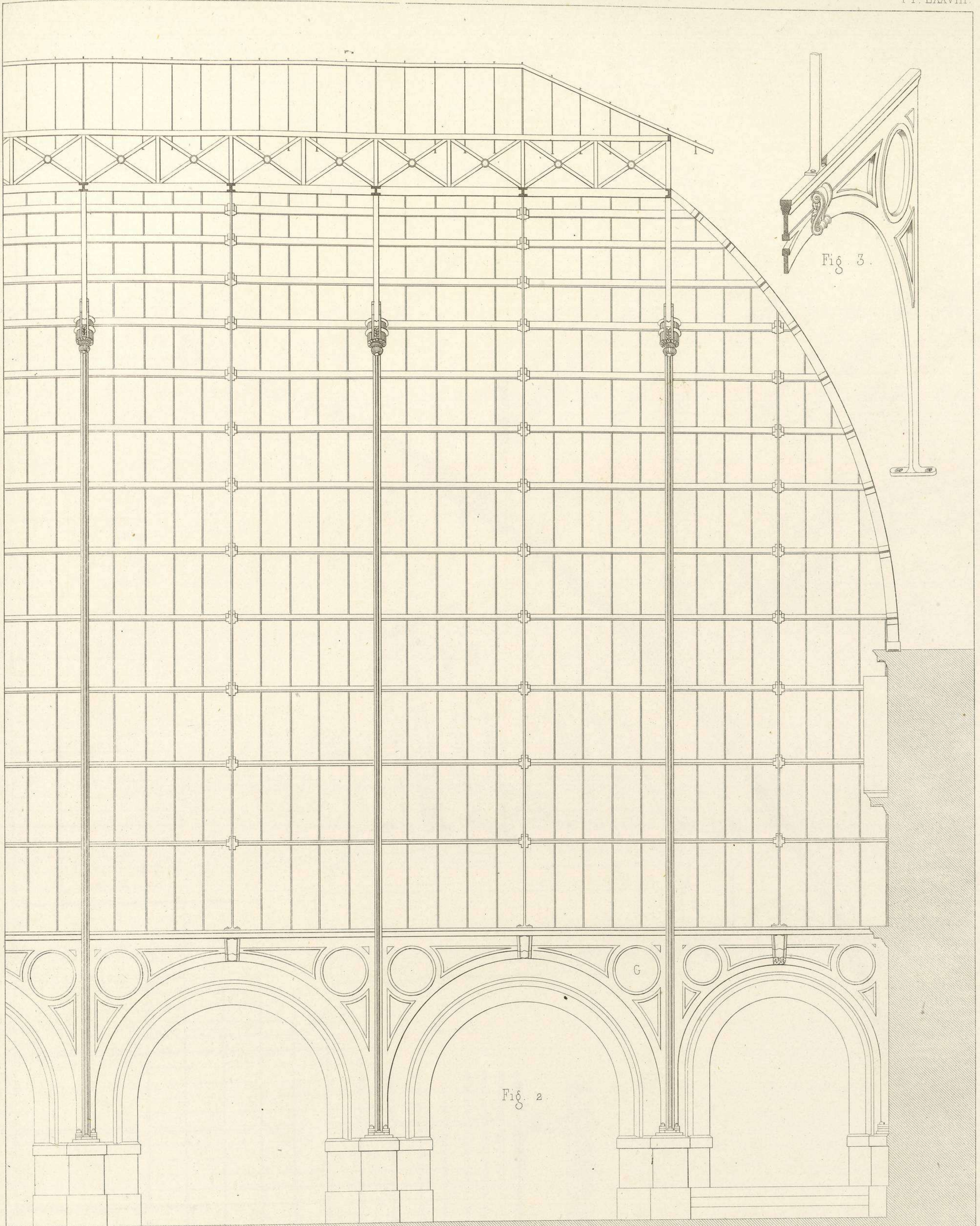

SERRURERIE.  
Combles.

B. de V. del.

H. R.



Pl. 79. (T. 1. P. 296)

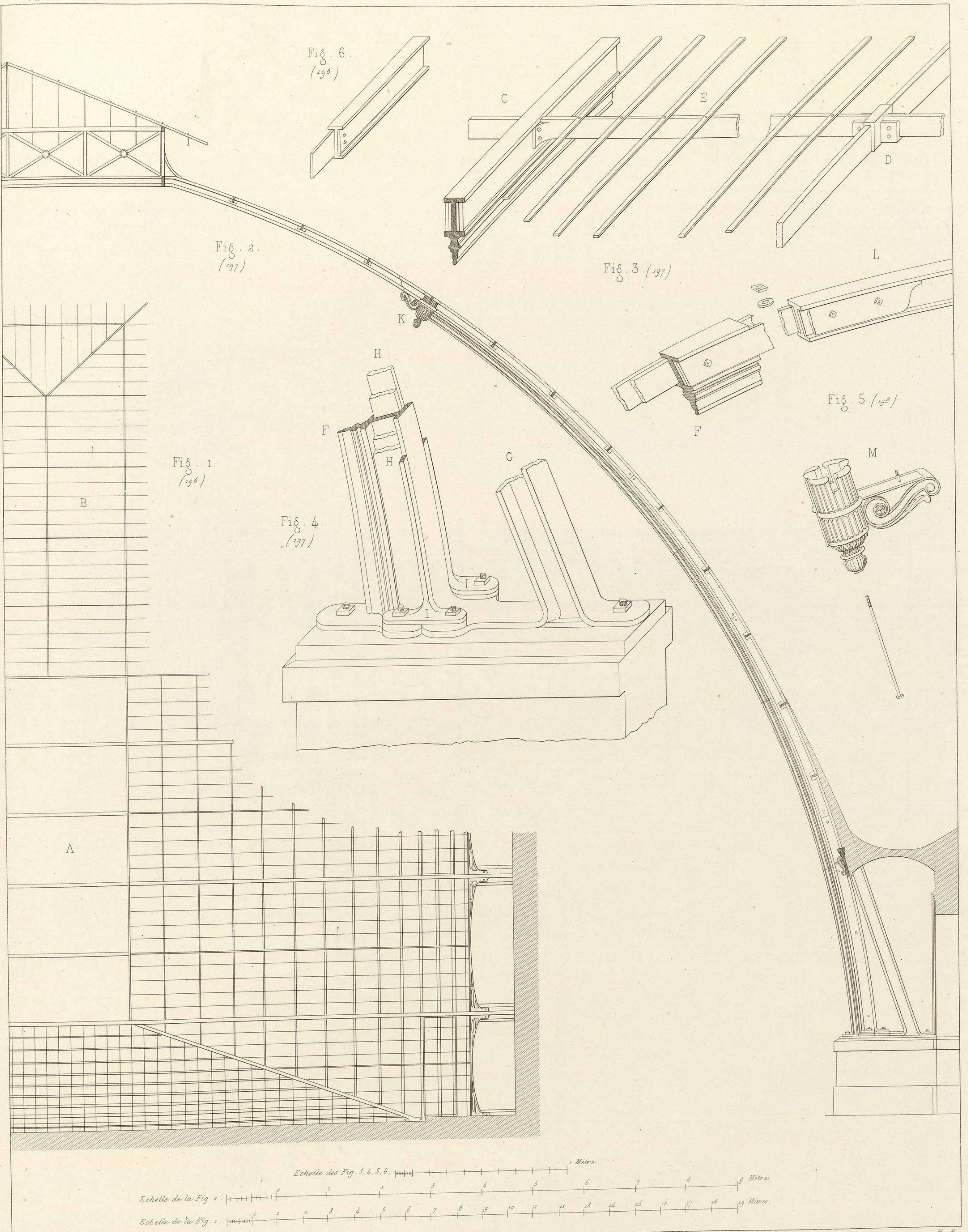

SERRURERIE  
Combles.



Fig. 6 (1000)

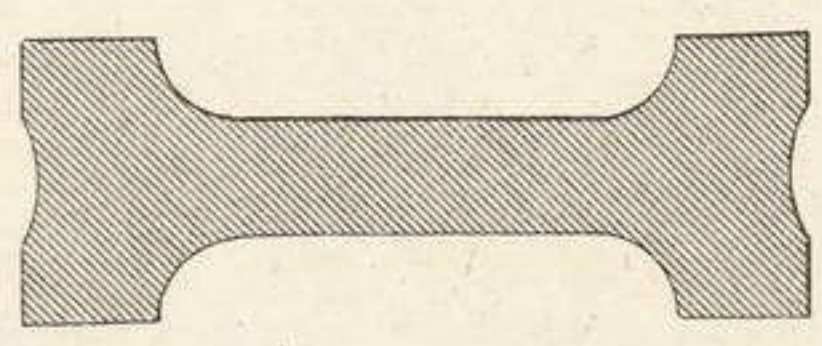

Fig. 2 (199)

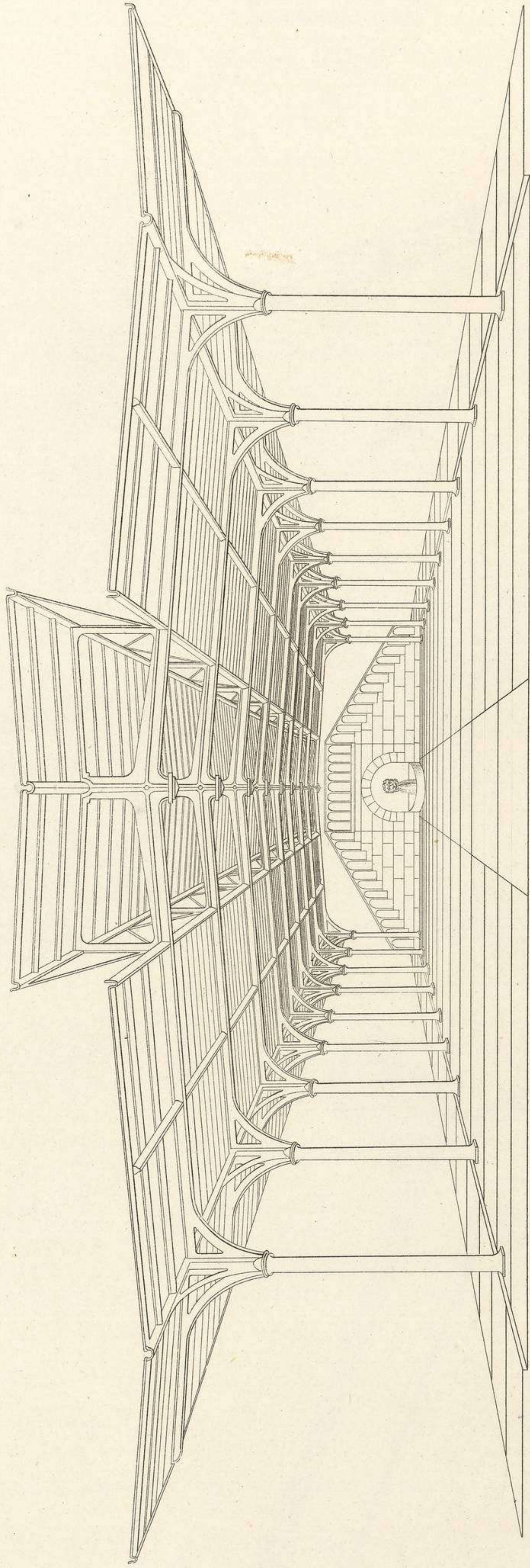

Fig. 4 (1000)

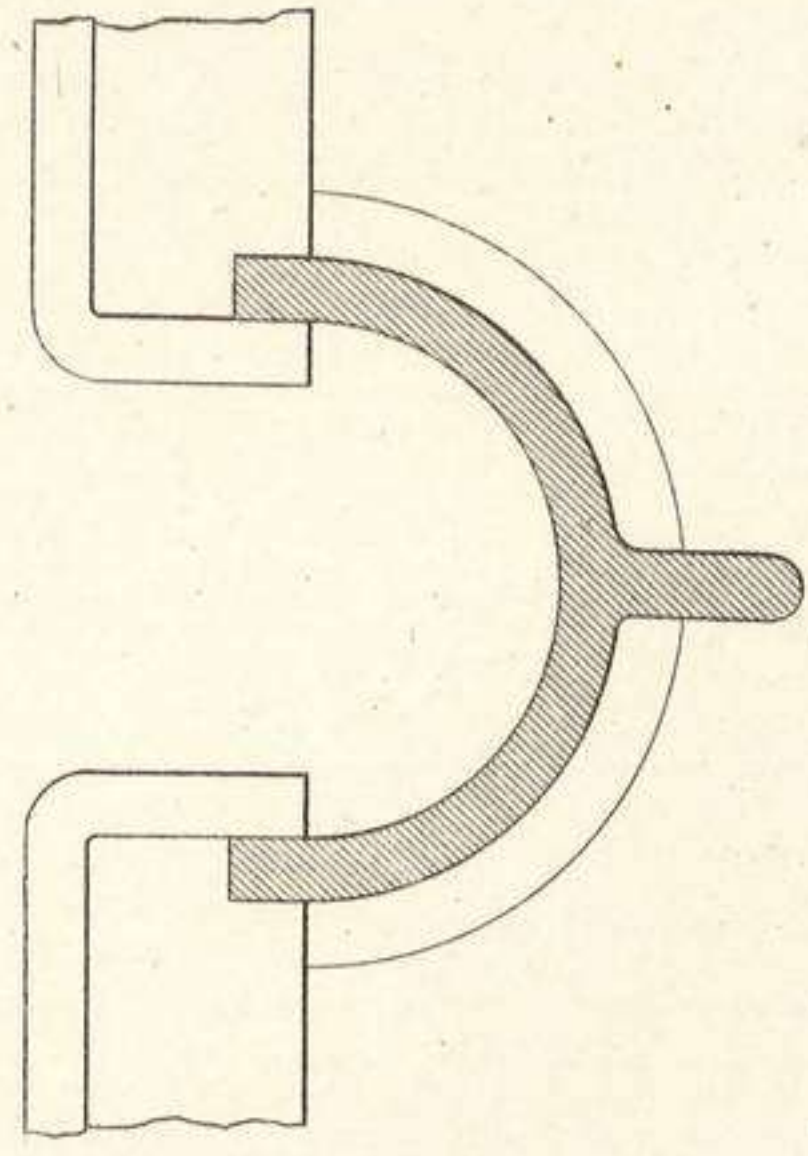

Fig. 3 (199)

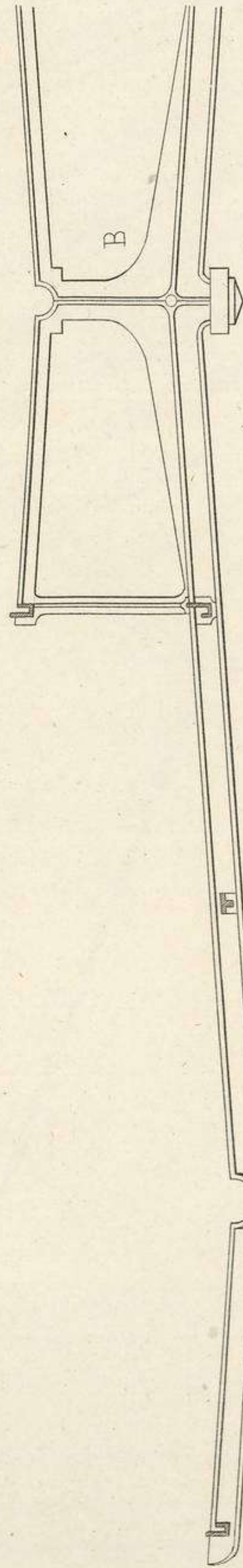

Fig. 1 (199)

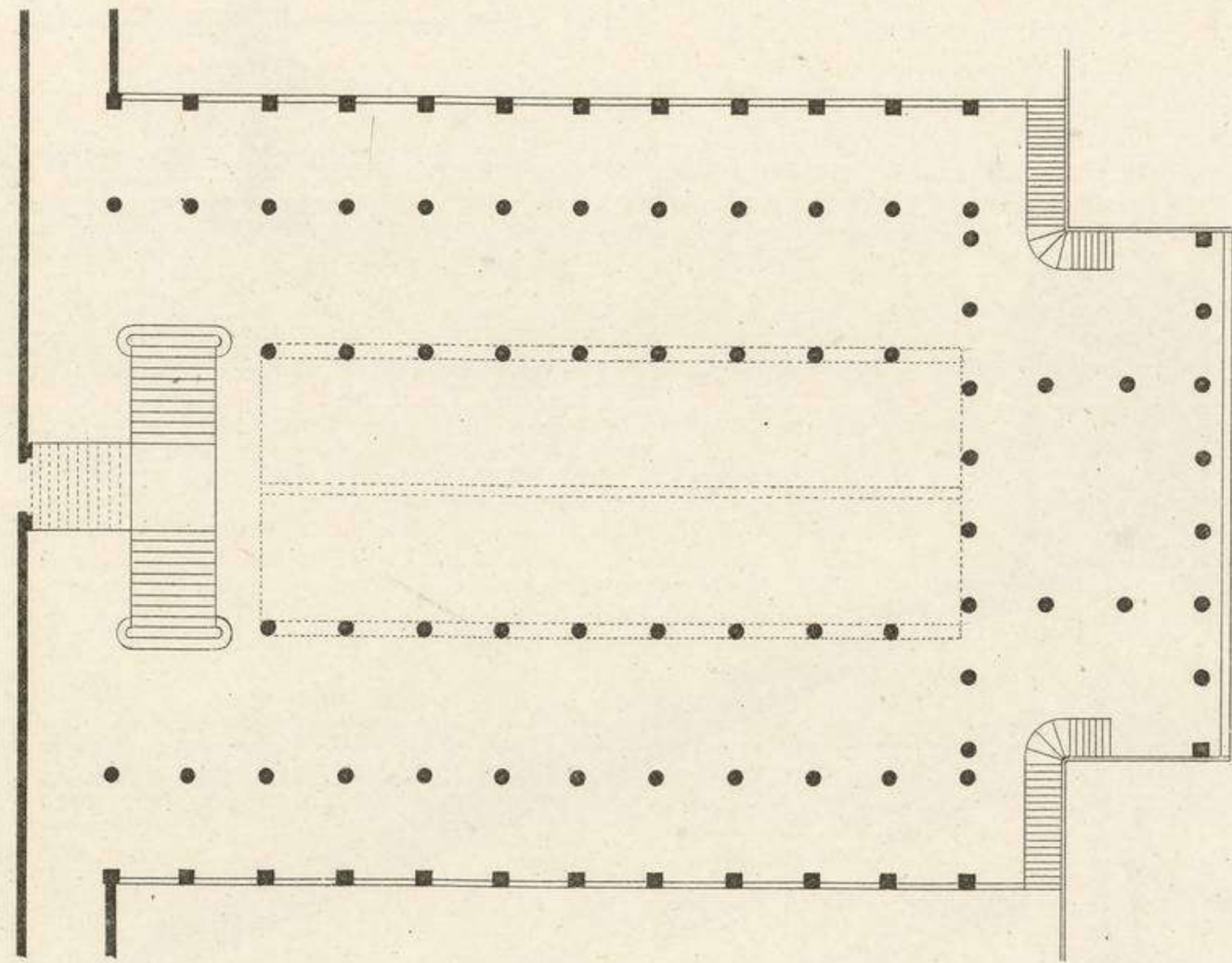
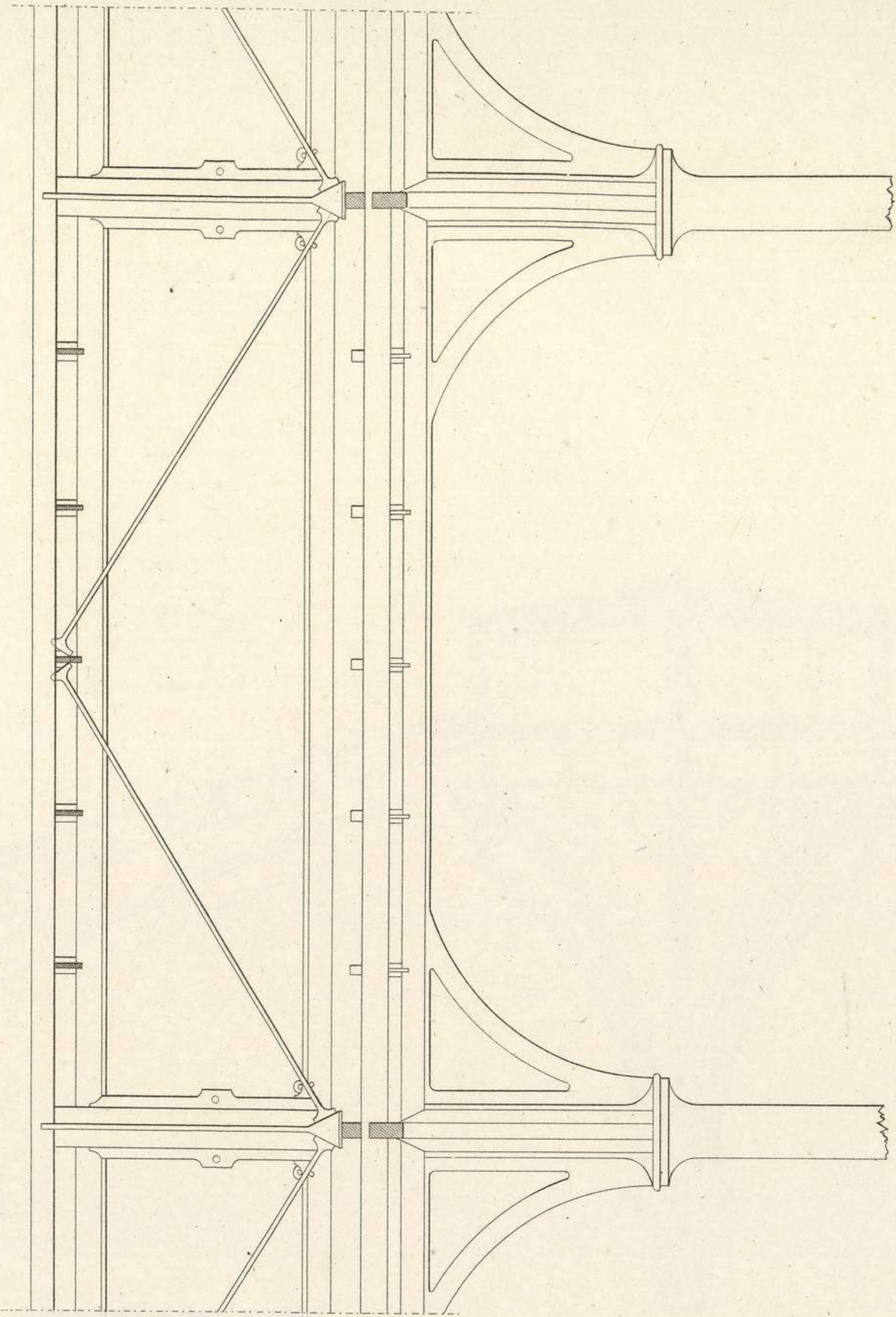

Fig. 5 (1000)



Echelle des Fig. 4 et 6



Echelle de la Fig. 3

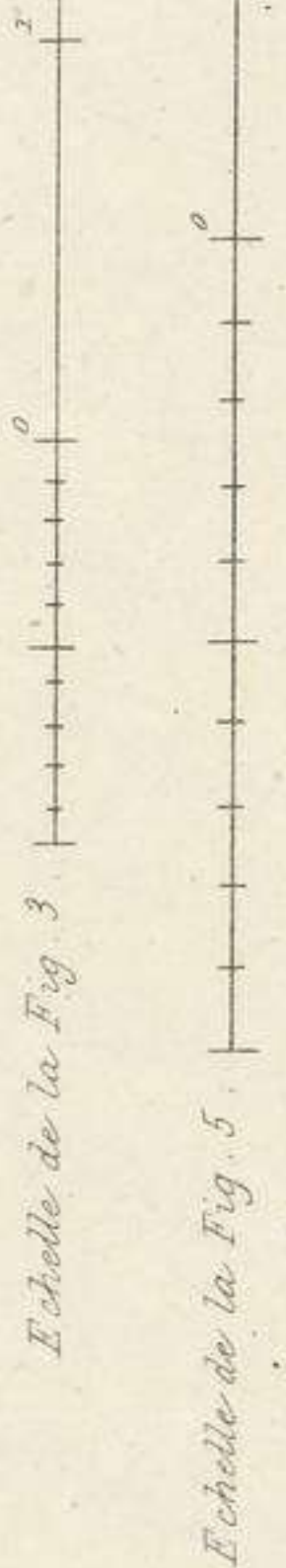

Echelle de la Fig. 5

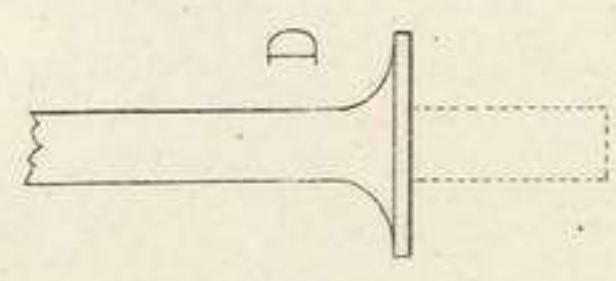
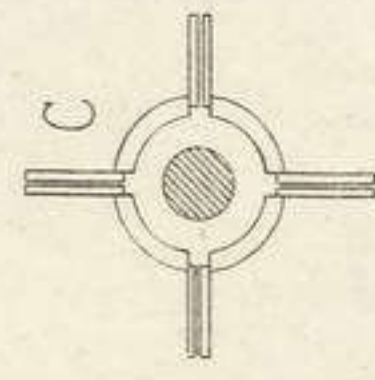

B et V del.

H. B.



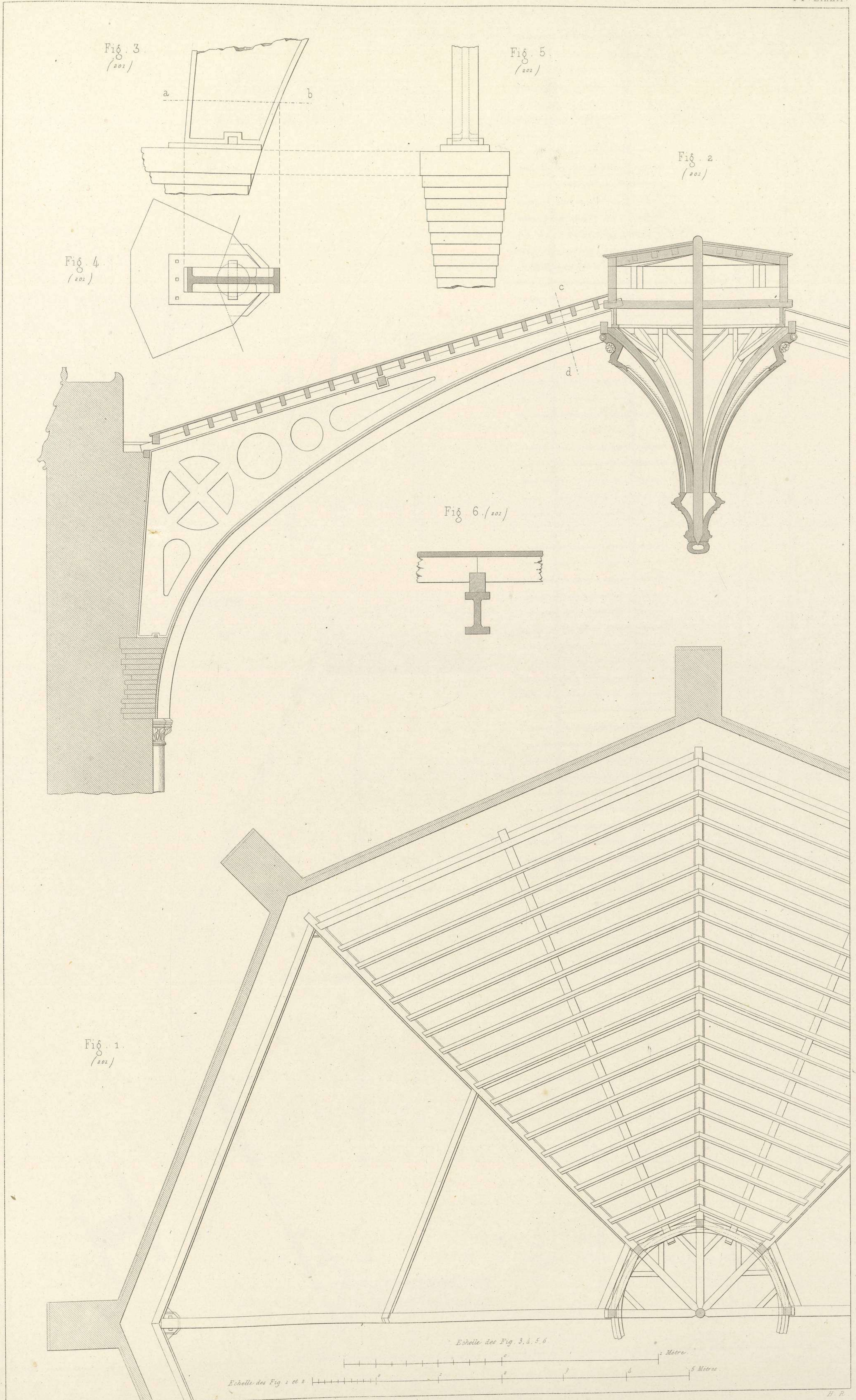

B. et V. del.

SERRURERIE.  
Combles.

H. P.



Pl. 82. (T. 1. P. 207.)

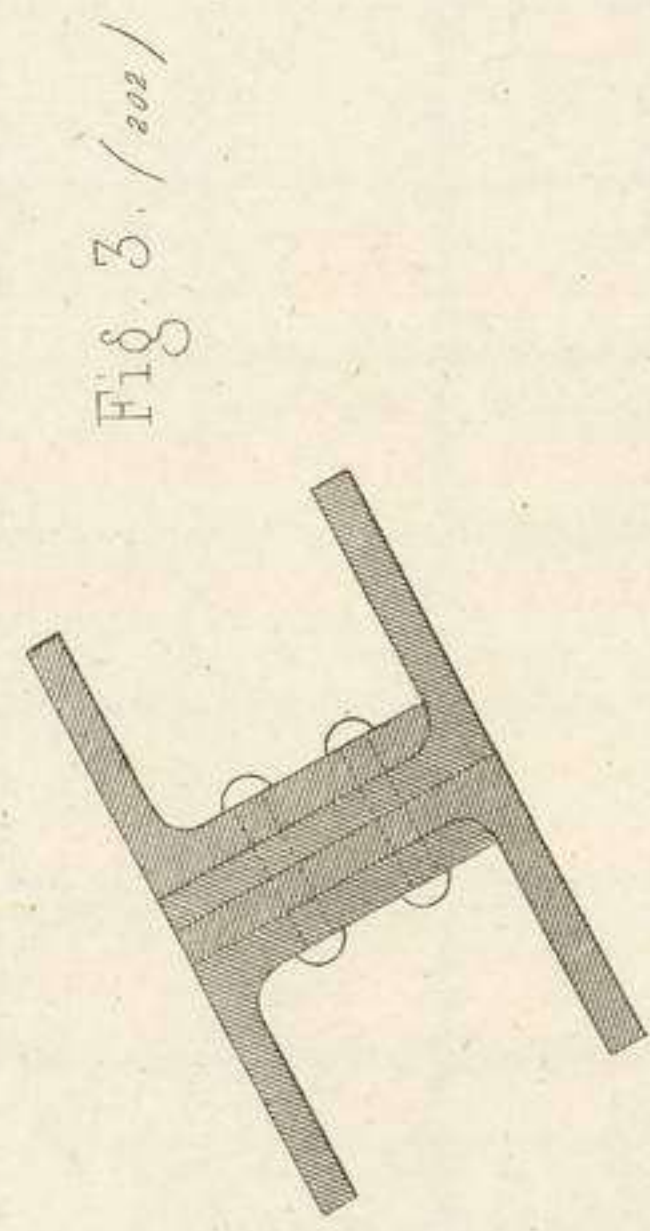

Fig. 3. (1803)

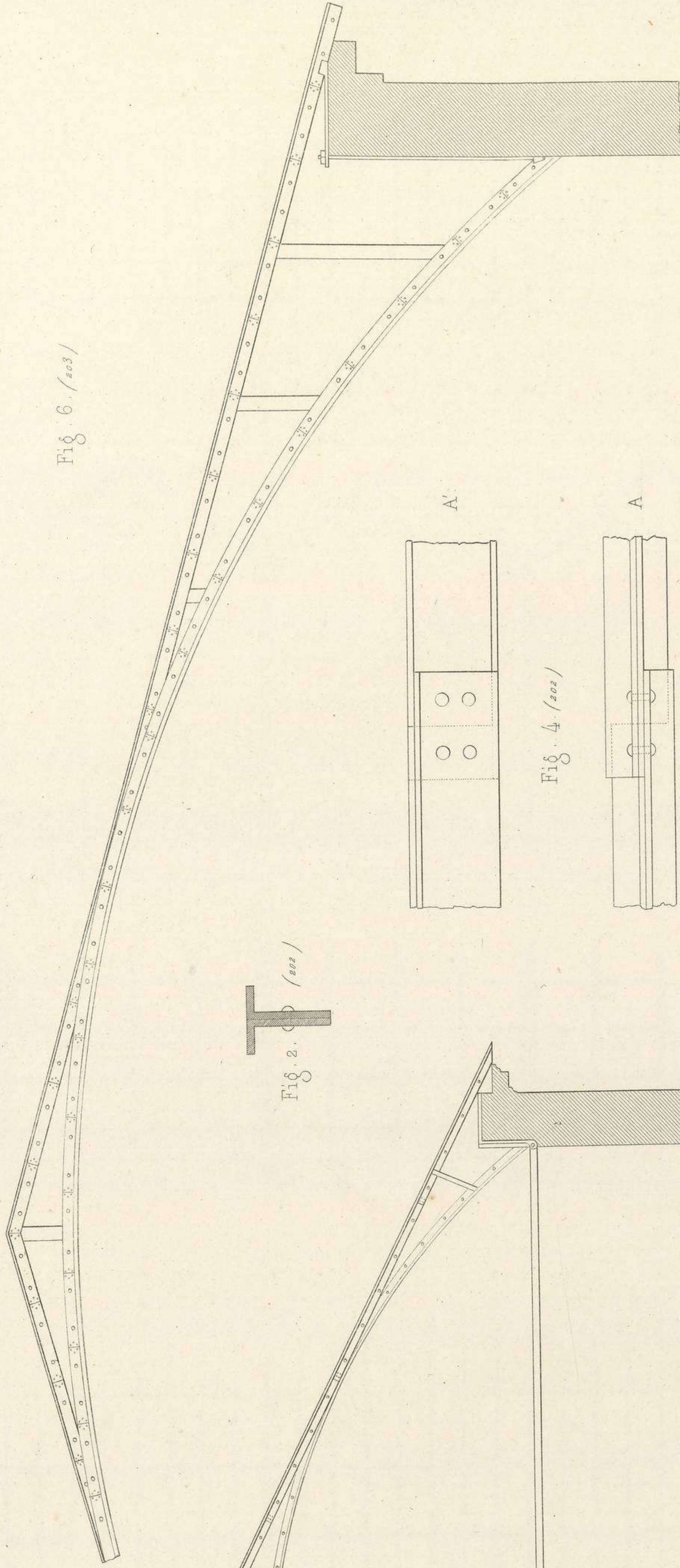

Fig. 6. (1803)

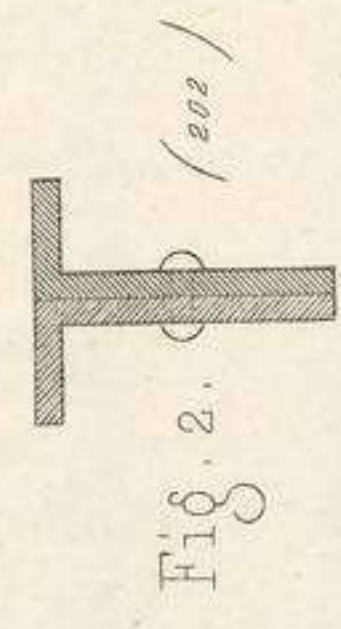

Fig. 2. (1803)

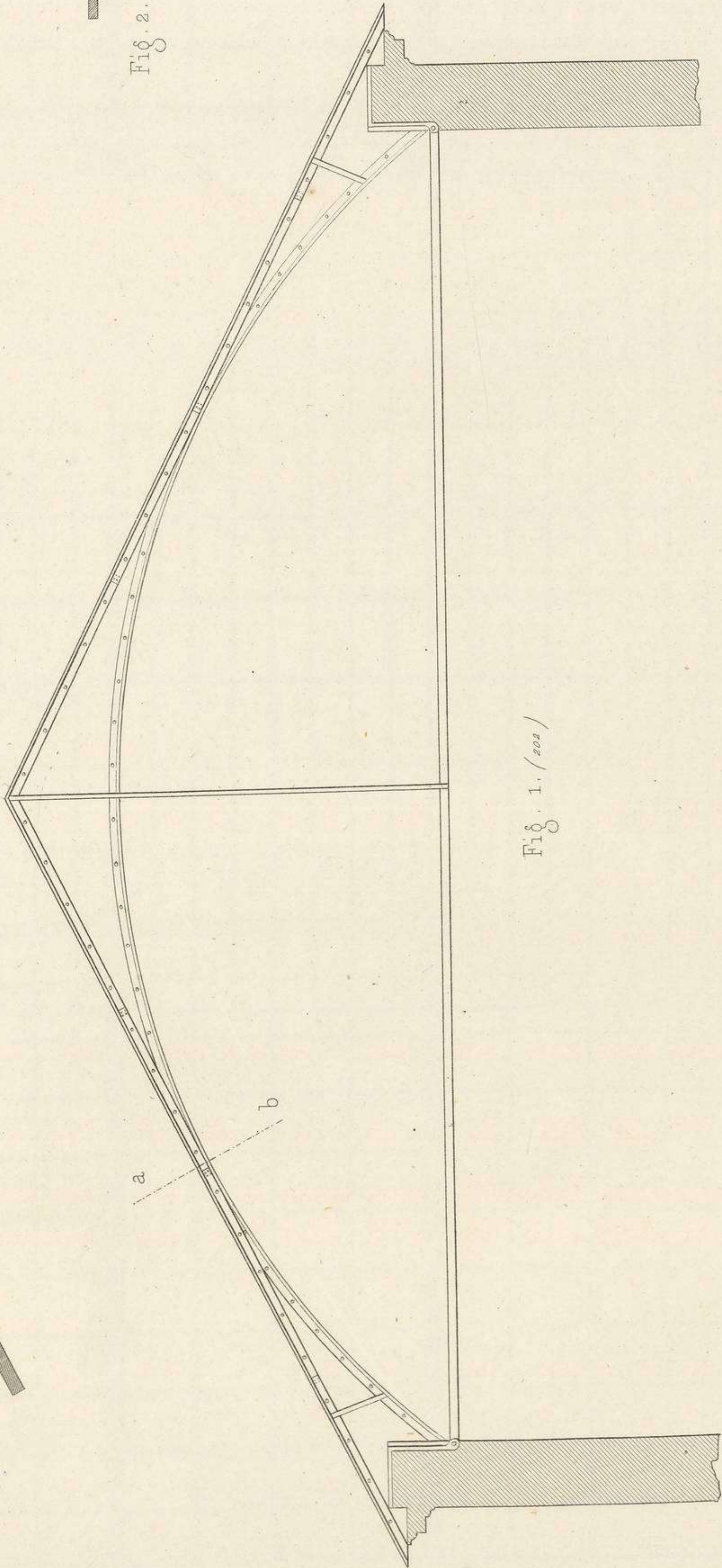

Fig. 1. (1803)

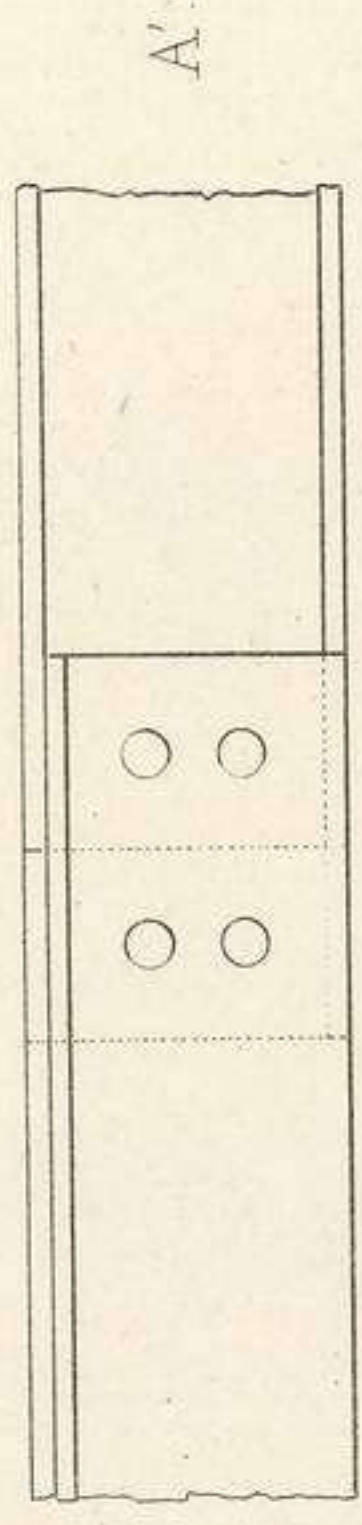

Fig. 4. (1803)

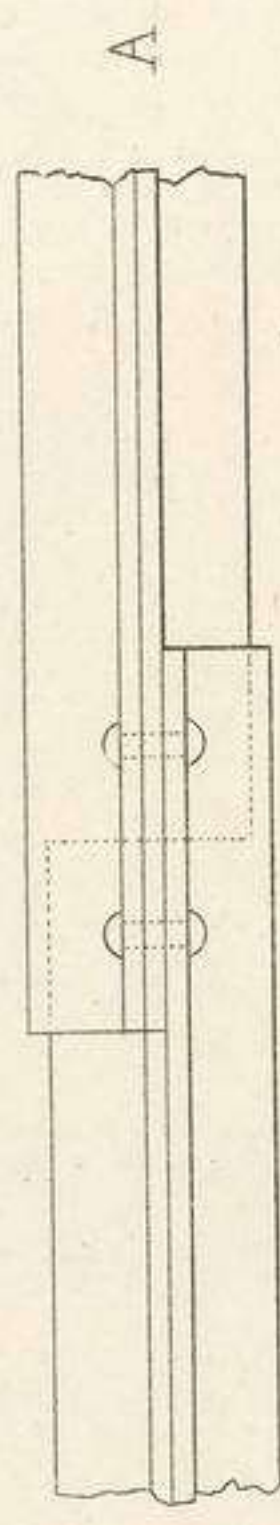

Fig. 5. (1803)

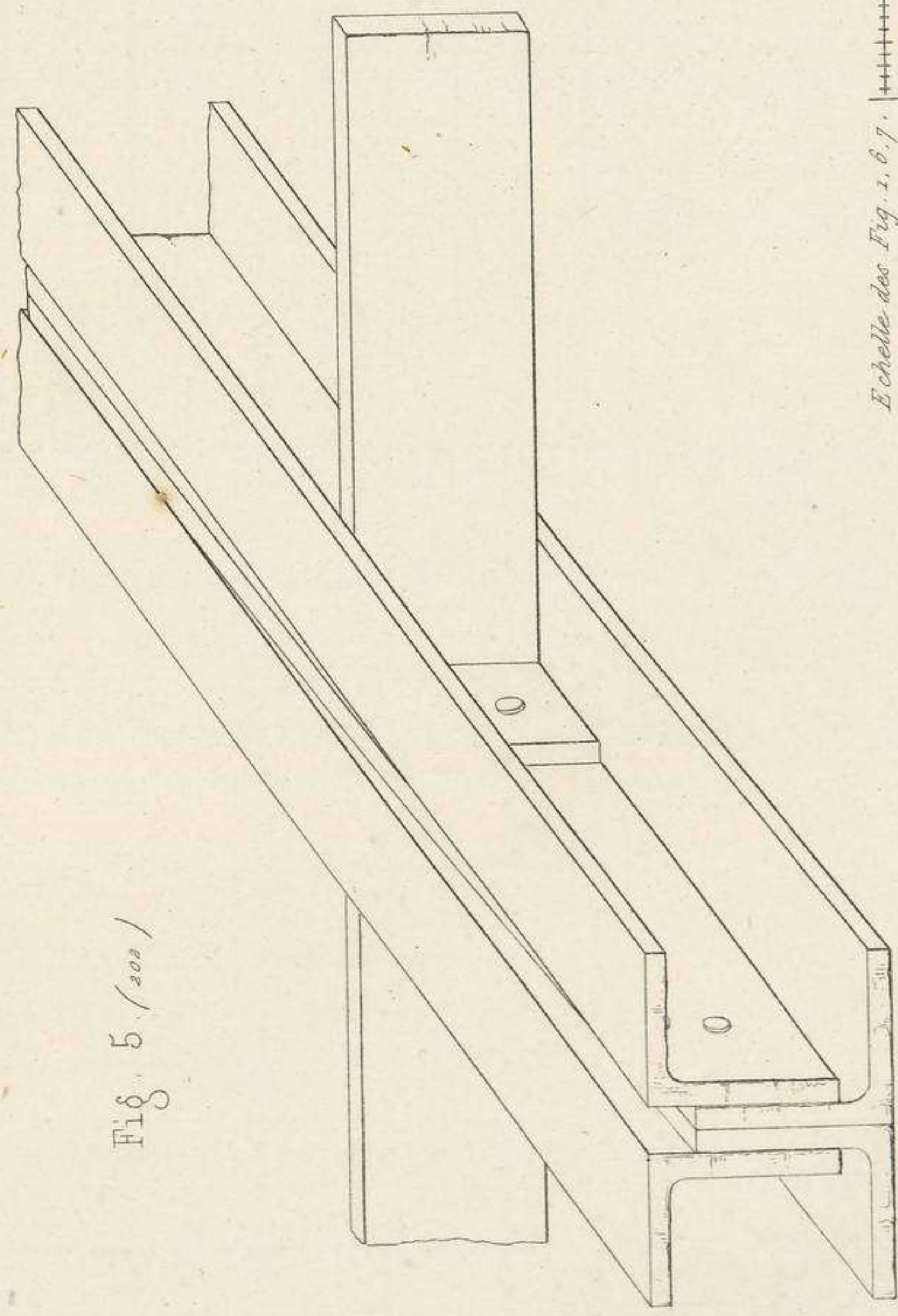
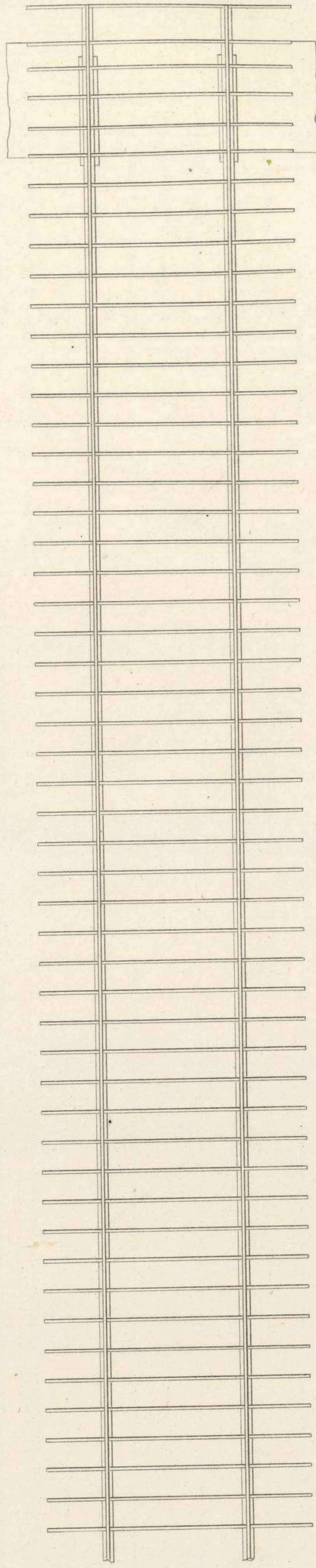

Fig. 7. (1803)



Echelle des Fig. 1, 6, 7. 10 Mètres

H. B.

B. et V. del.

SERRURERIE.  
Combles en tôle.



Fig. 1.

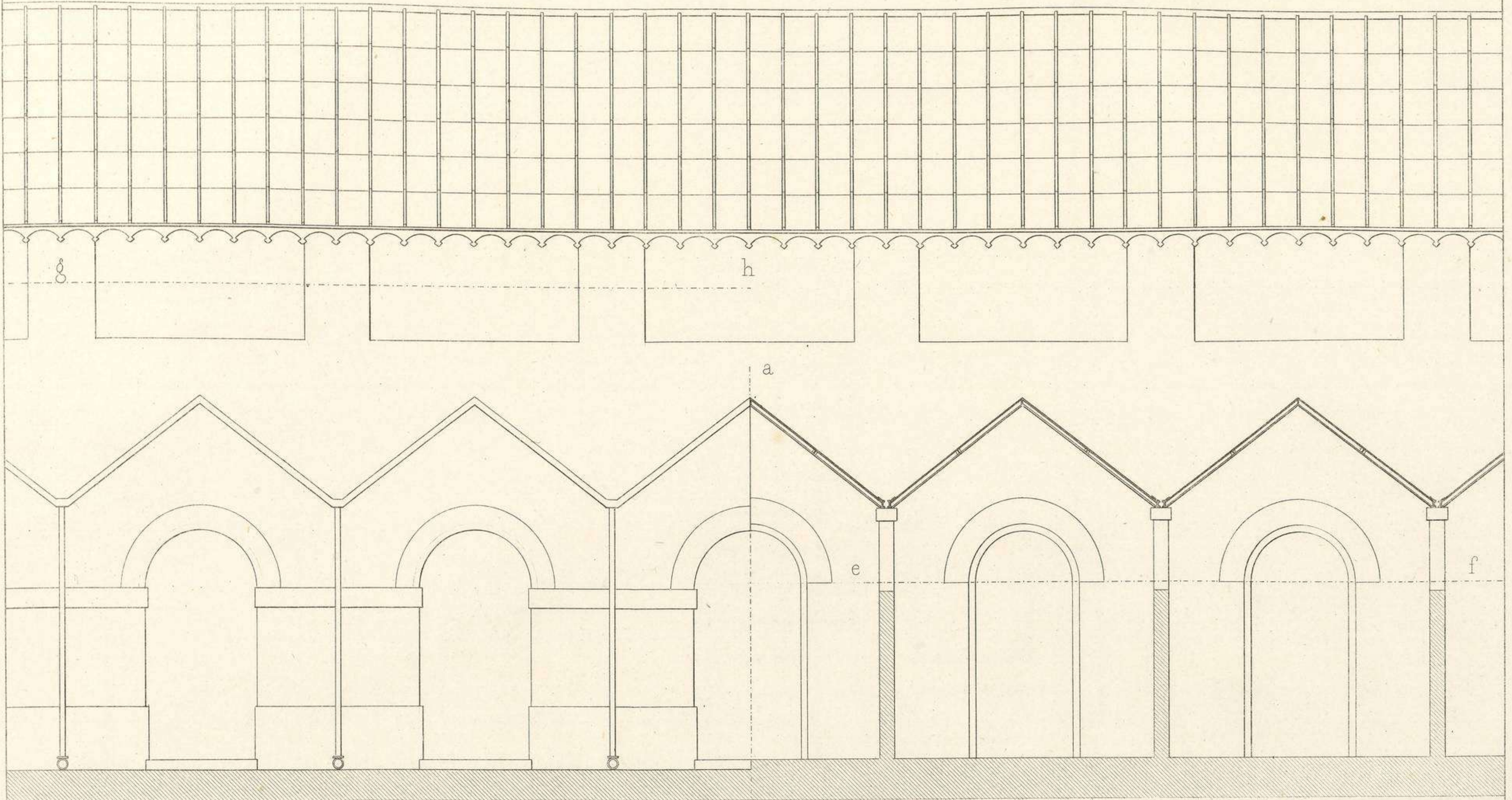
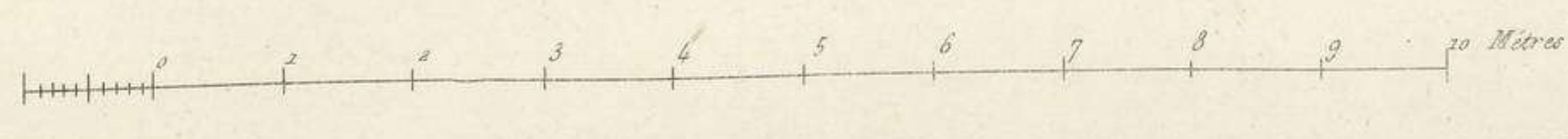
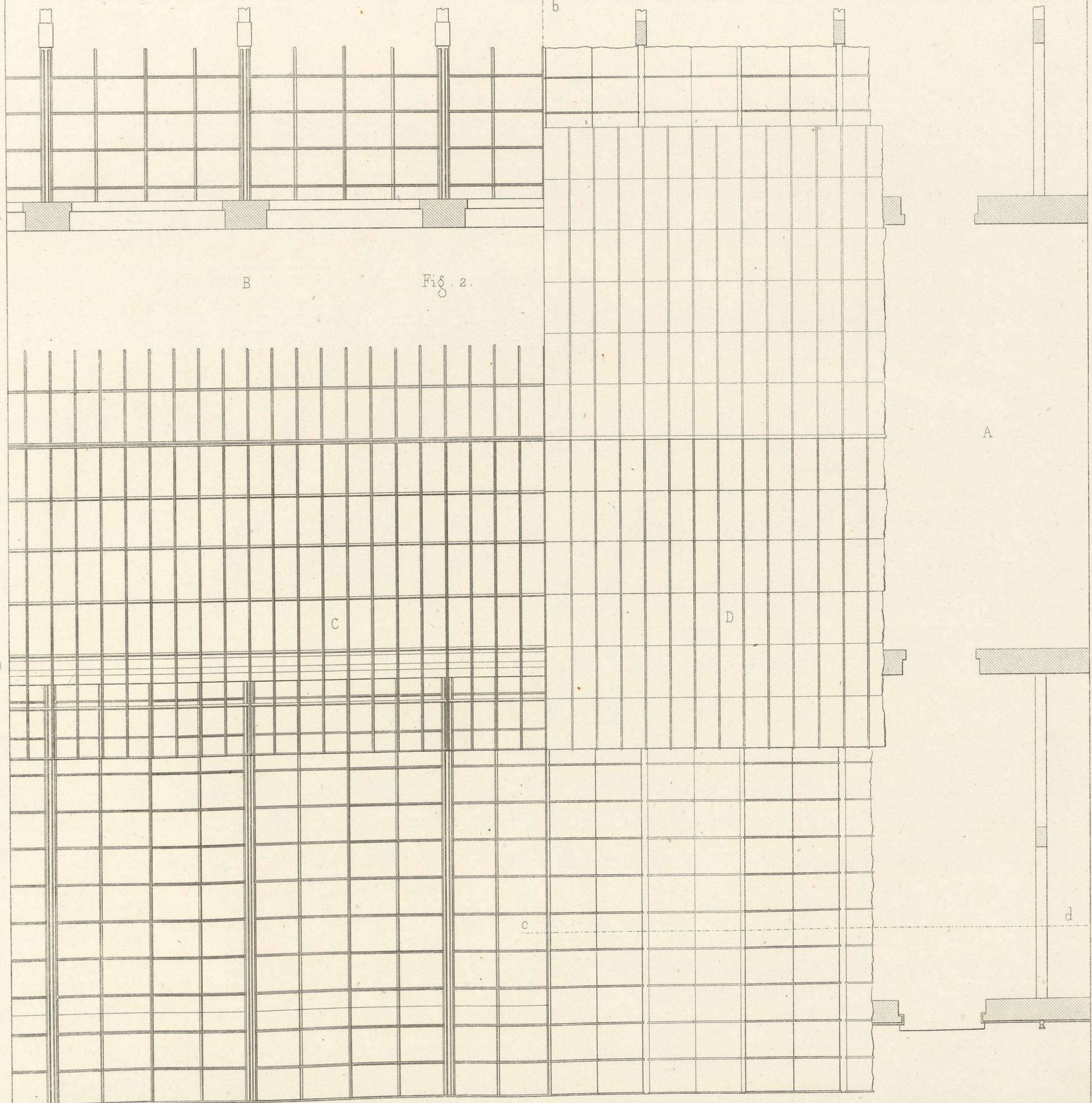

Fig. 2.



B. de V. del.

H. R.

SERRURERIE.  
Combles en tôle.



Fig. 6. (203)

Fig. 7. (203)

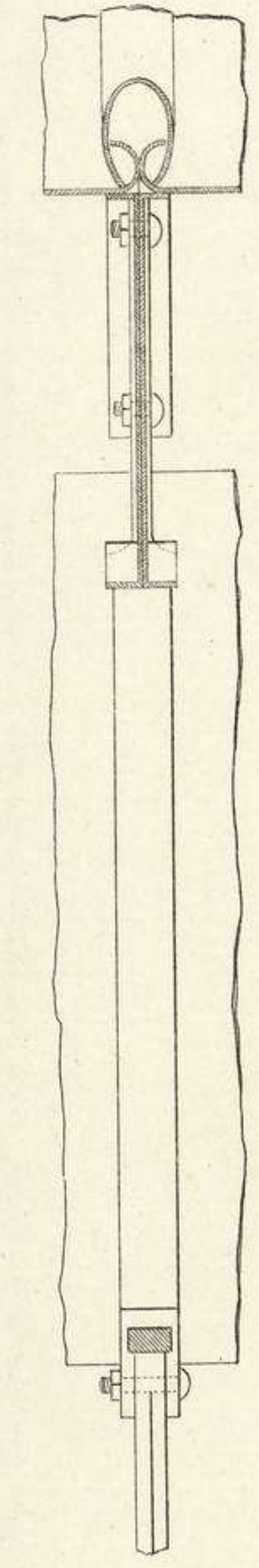

Fig. 9. (203)

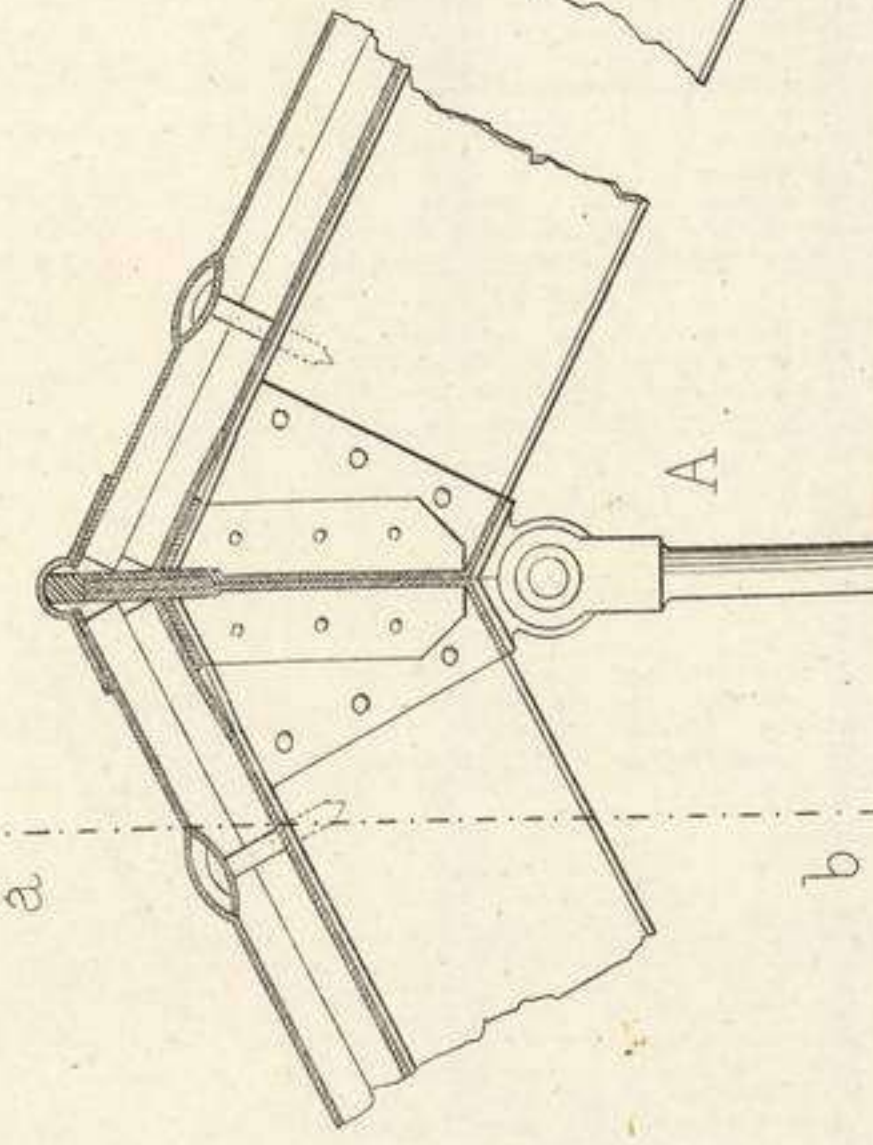
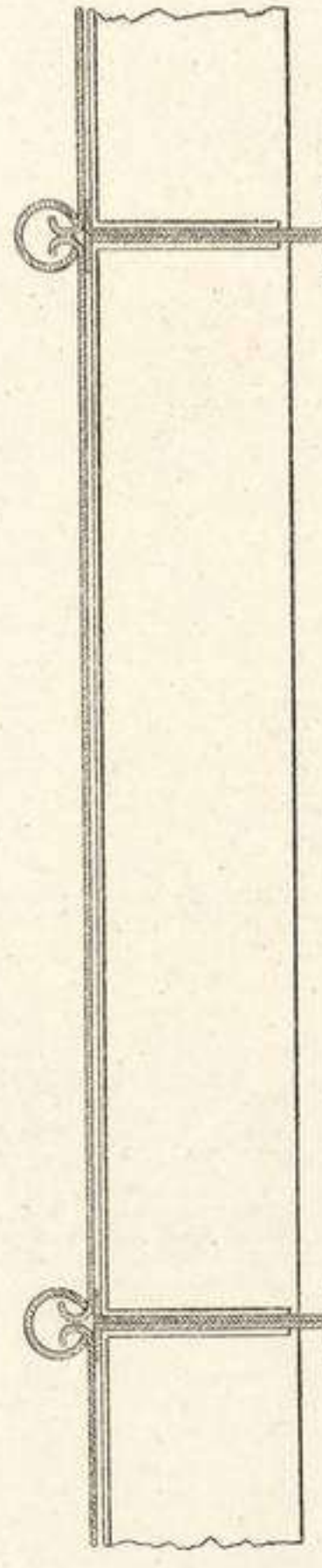

Fig. 3. (203)

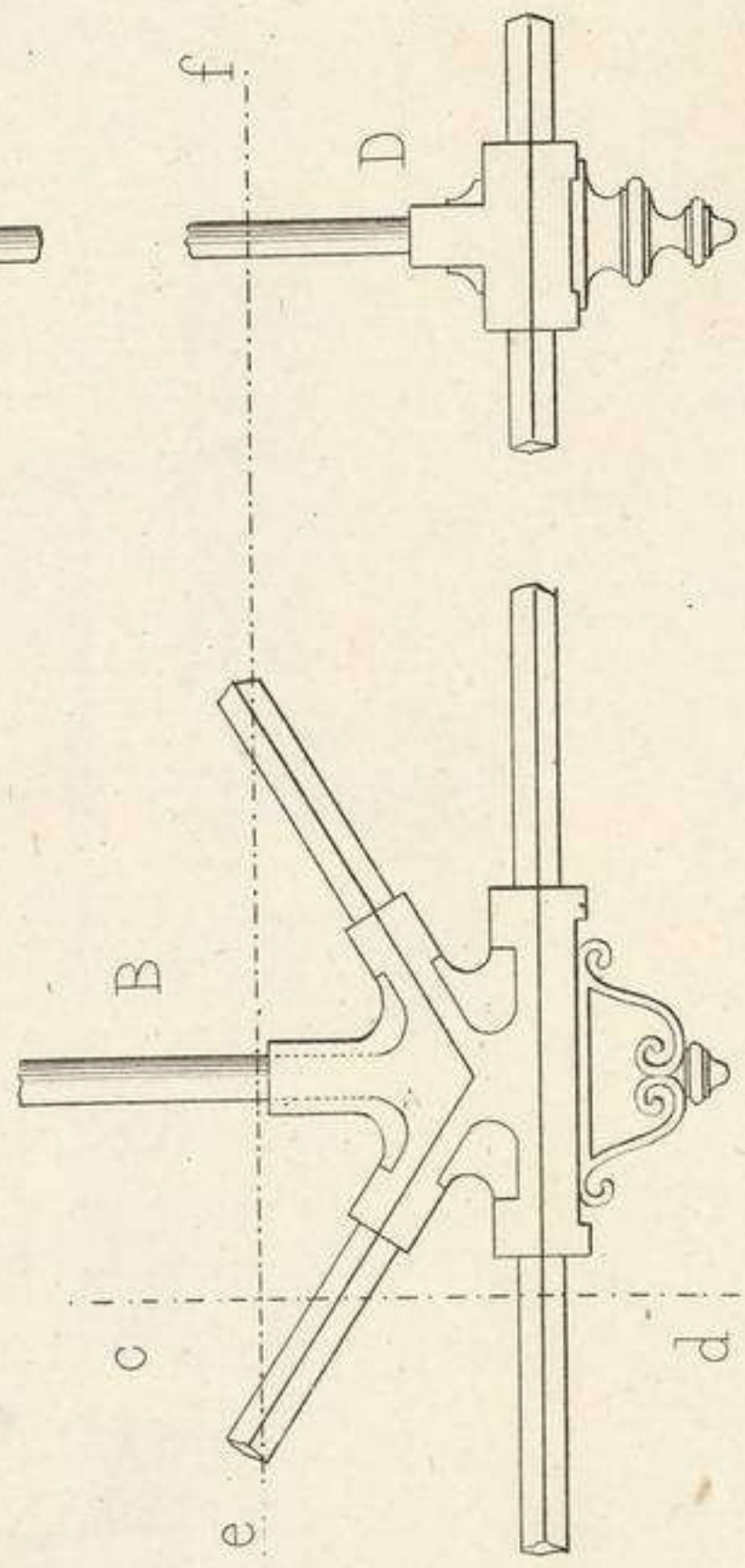

Fig. 4. (203)

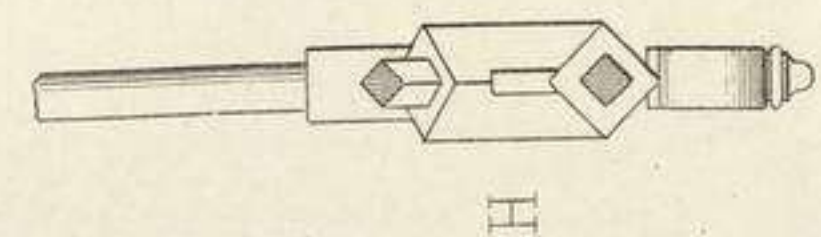

Fig. 5. (203)

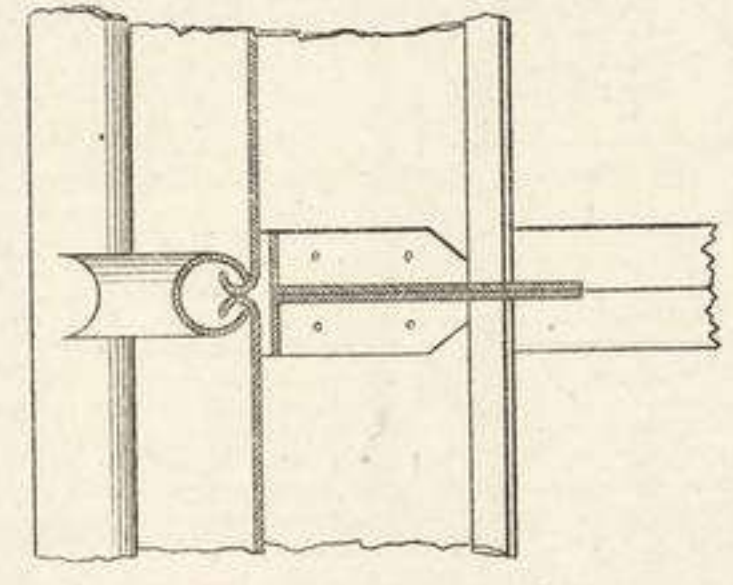

Fig. 8. (203)

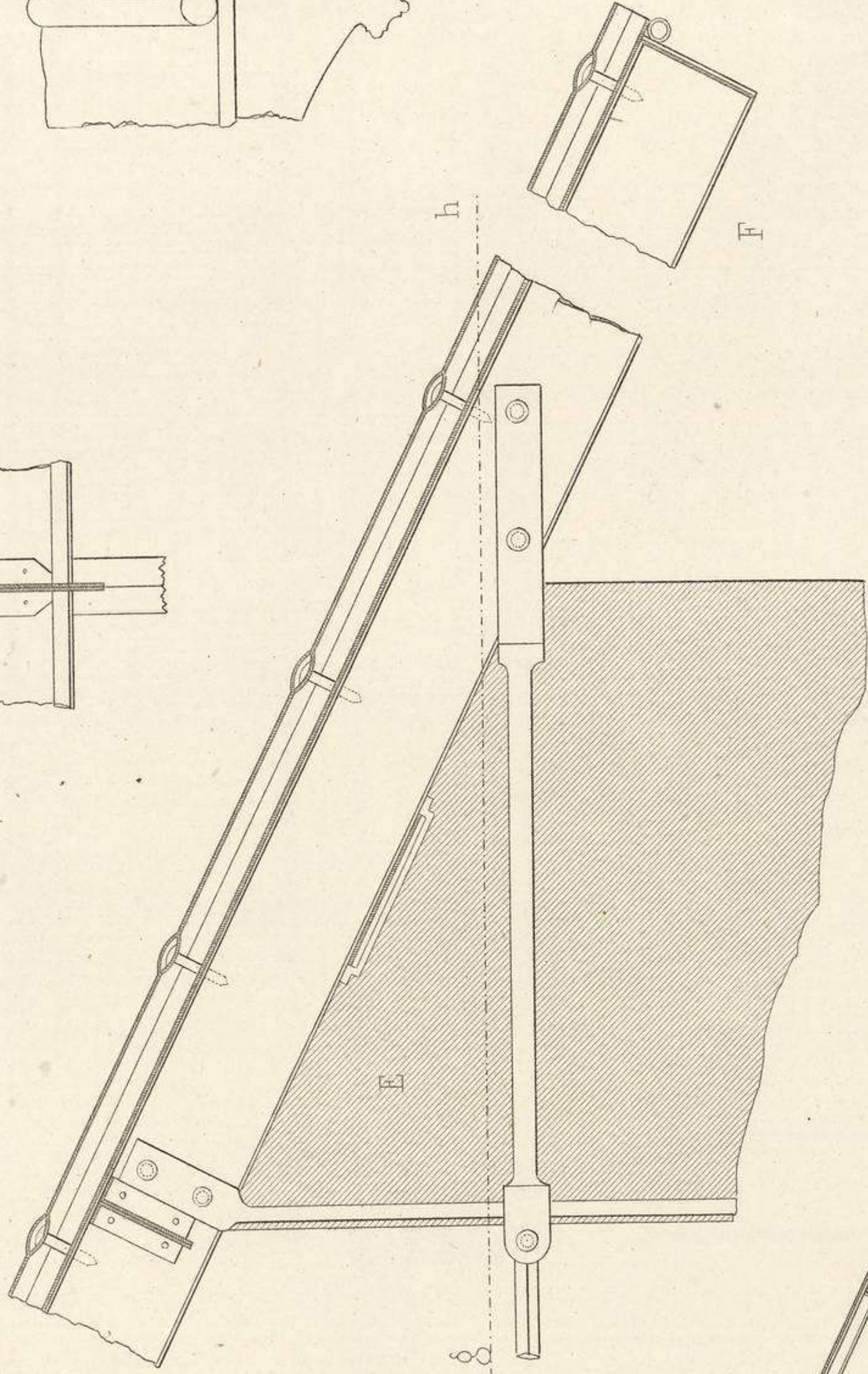

Fig. 10. (203)

Fig. 2. (203)

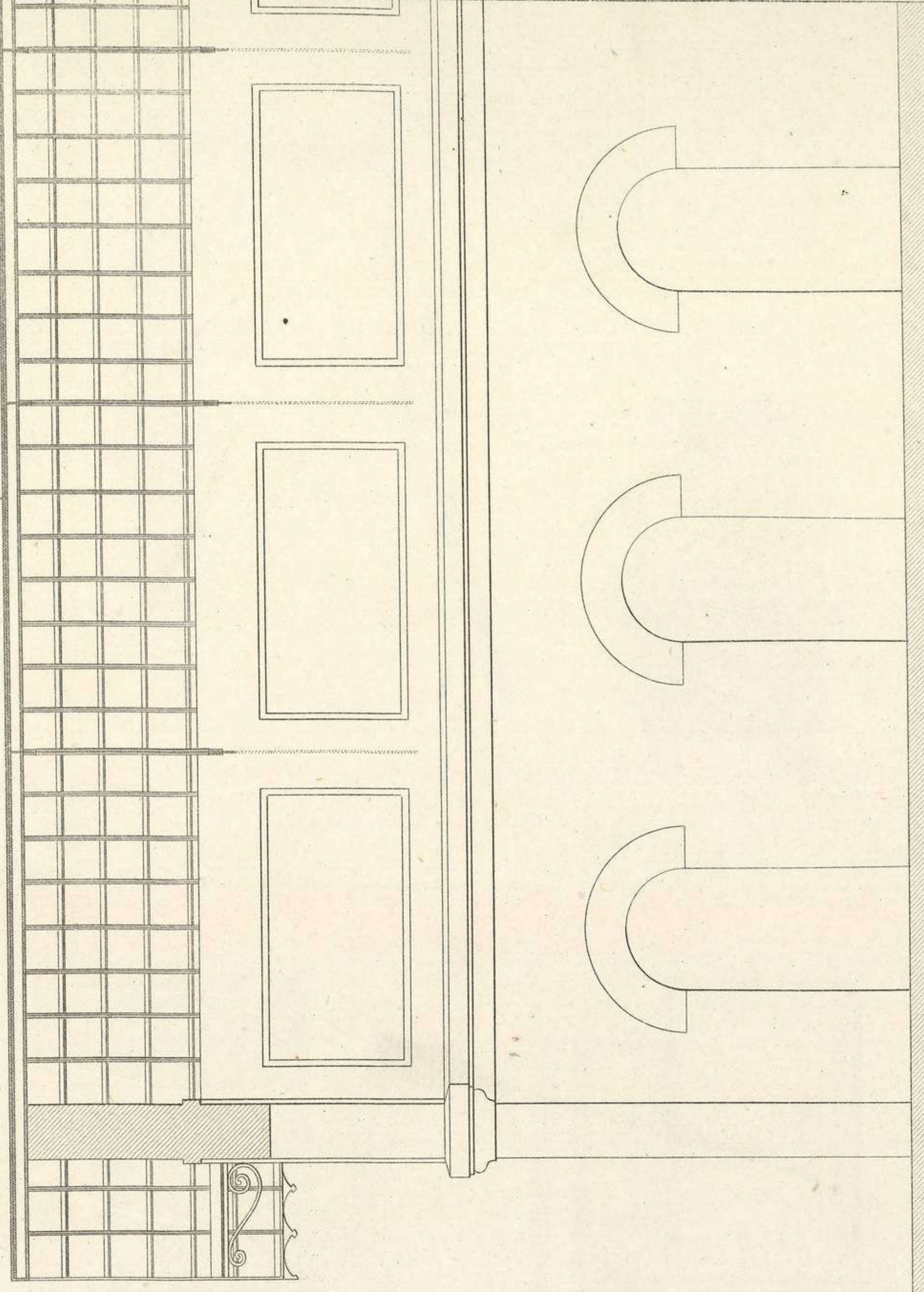
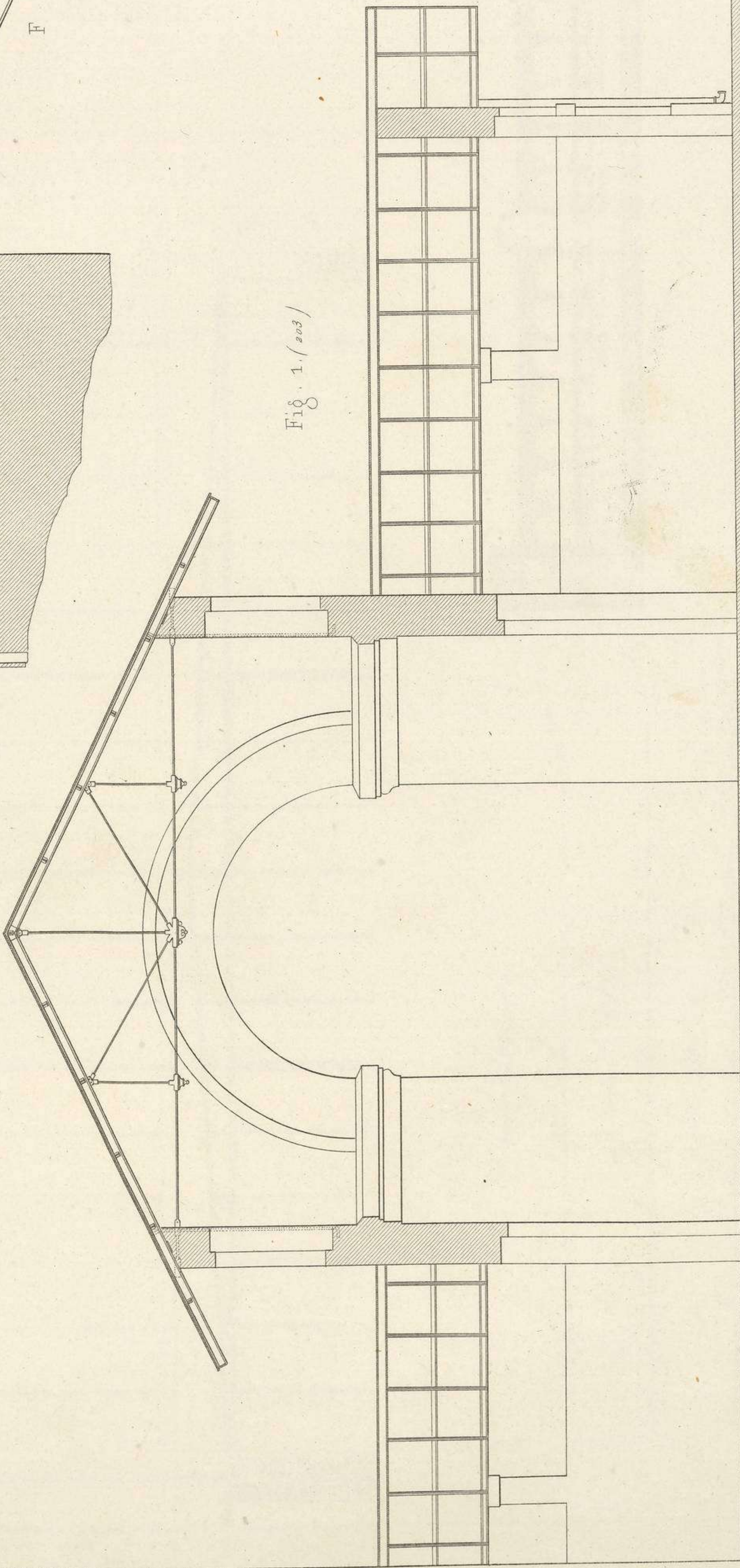

Fig. 11. (203)

Fig. 1. (203)



Echelle des Fig. 1 et 2. 1/10 Mètre

SERRURERIE.  
Combles en tôle.

B. et V. del.

H. B.



Fig. 3. (205)

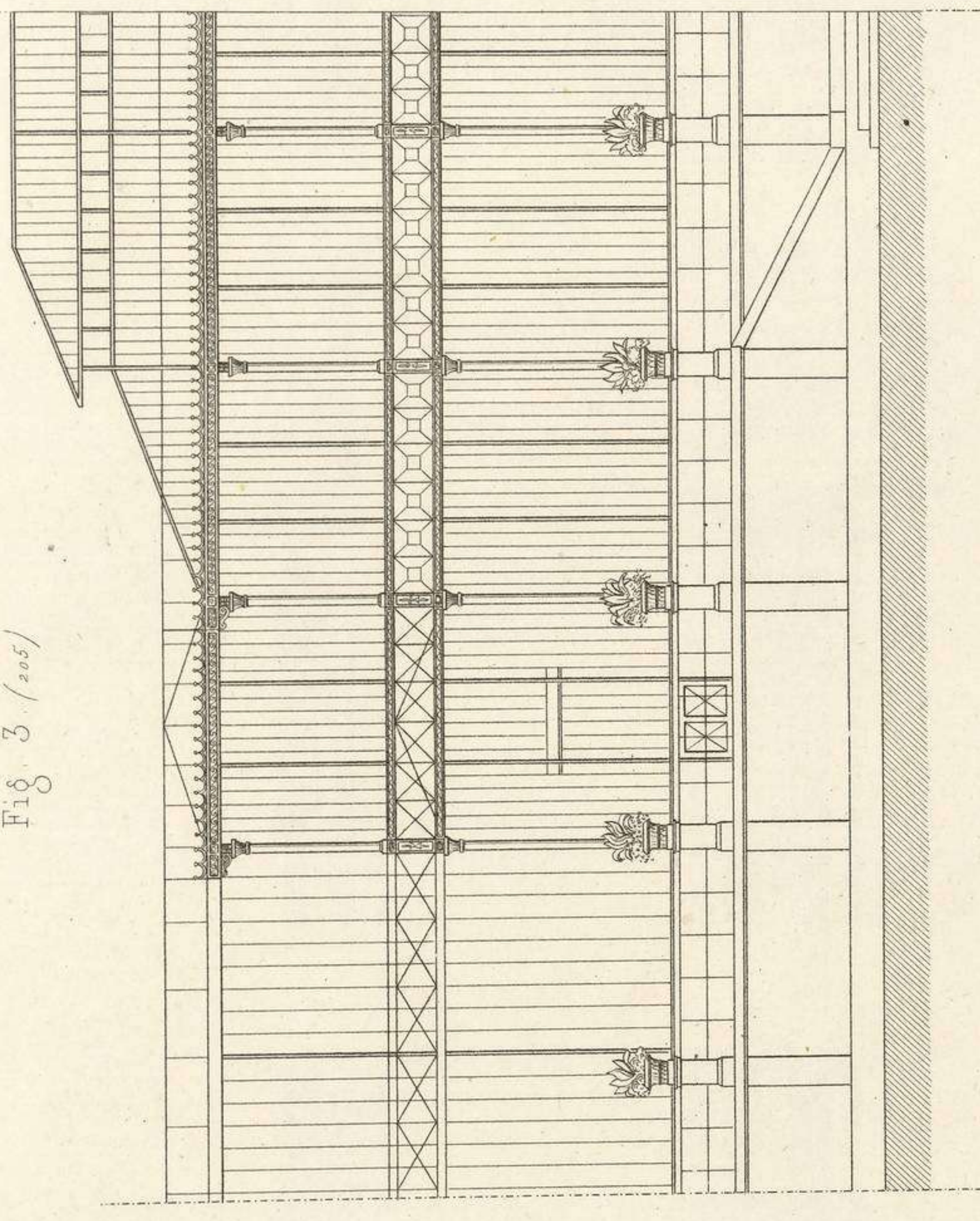

Fig. 9. (205)

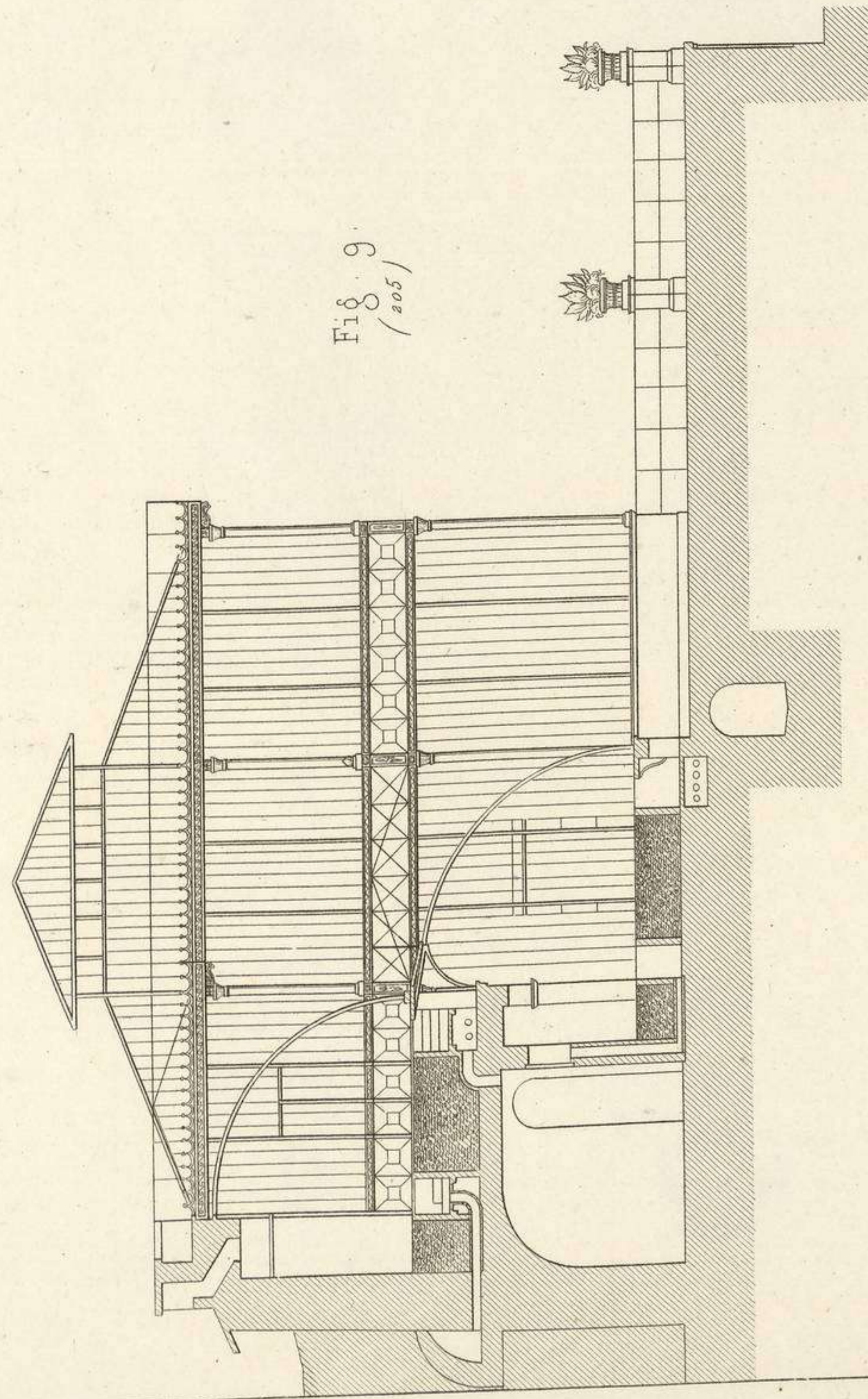

Fig. 8. (205)

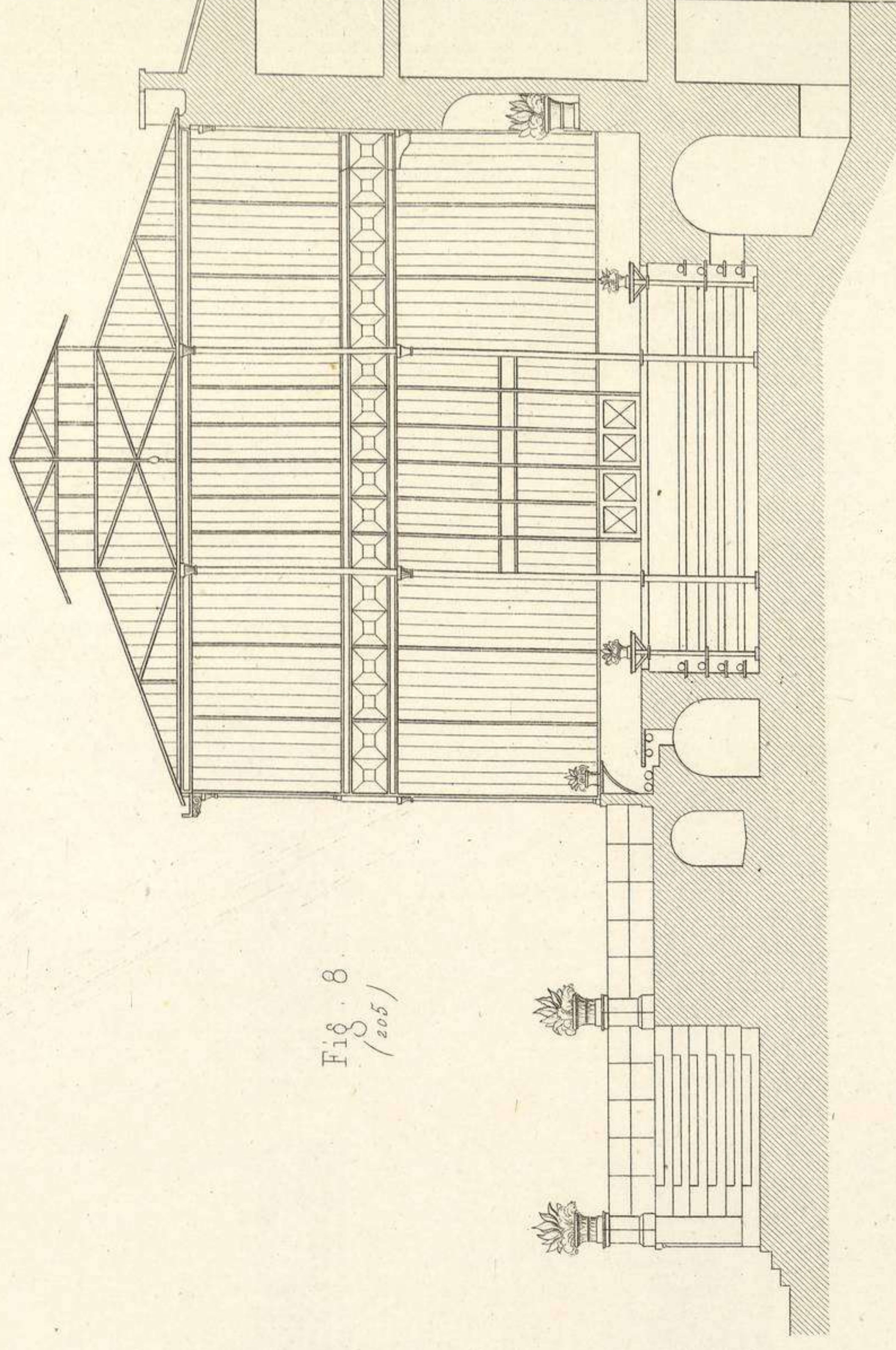

Fig. 7. (205)

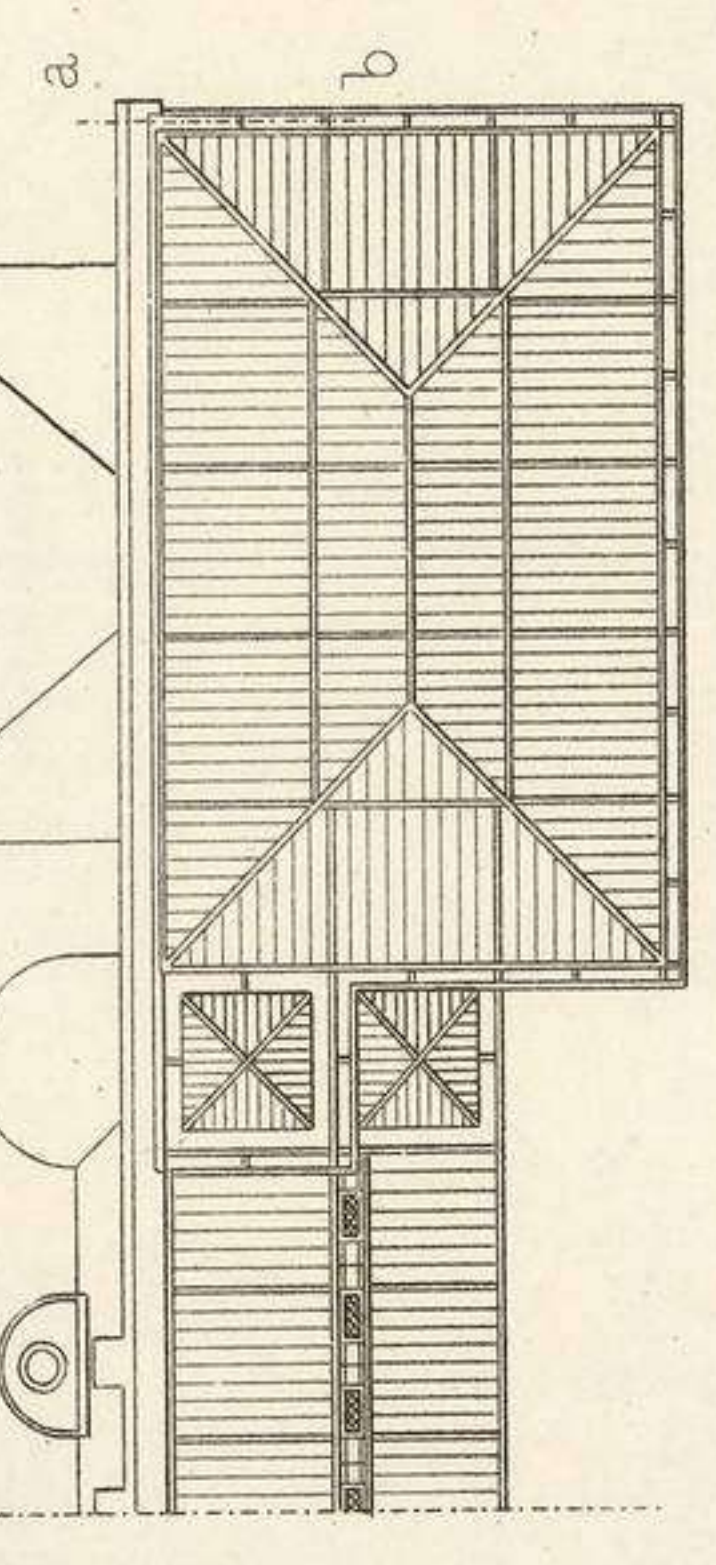
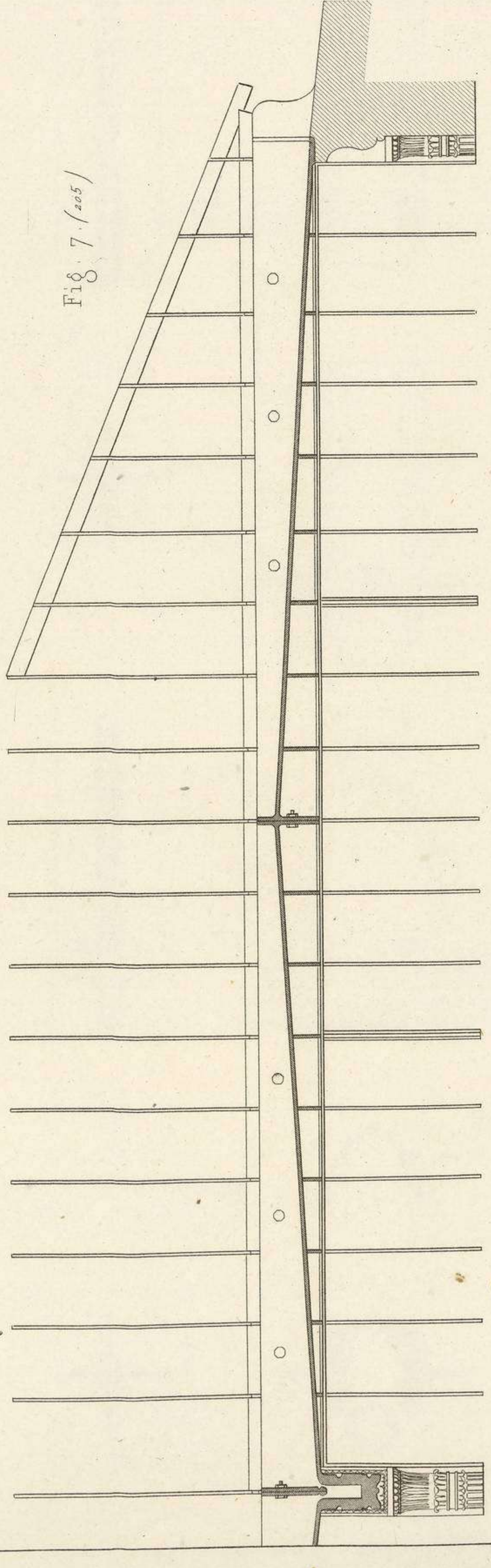

Fig. 2. (205)

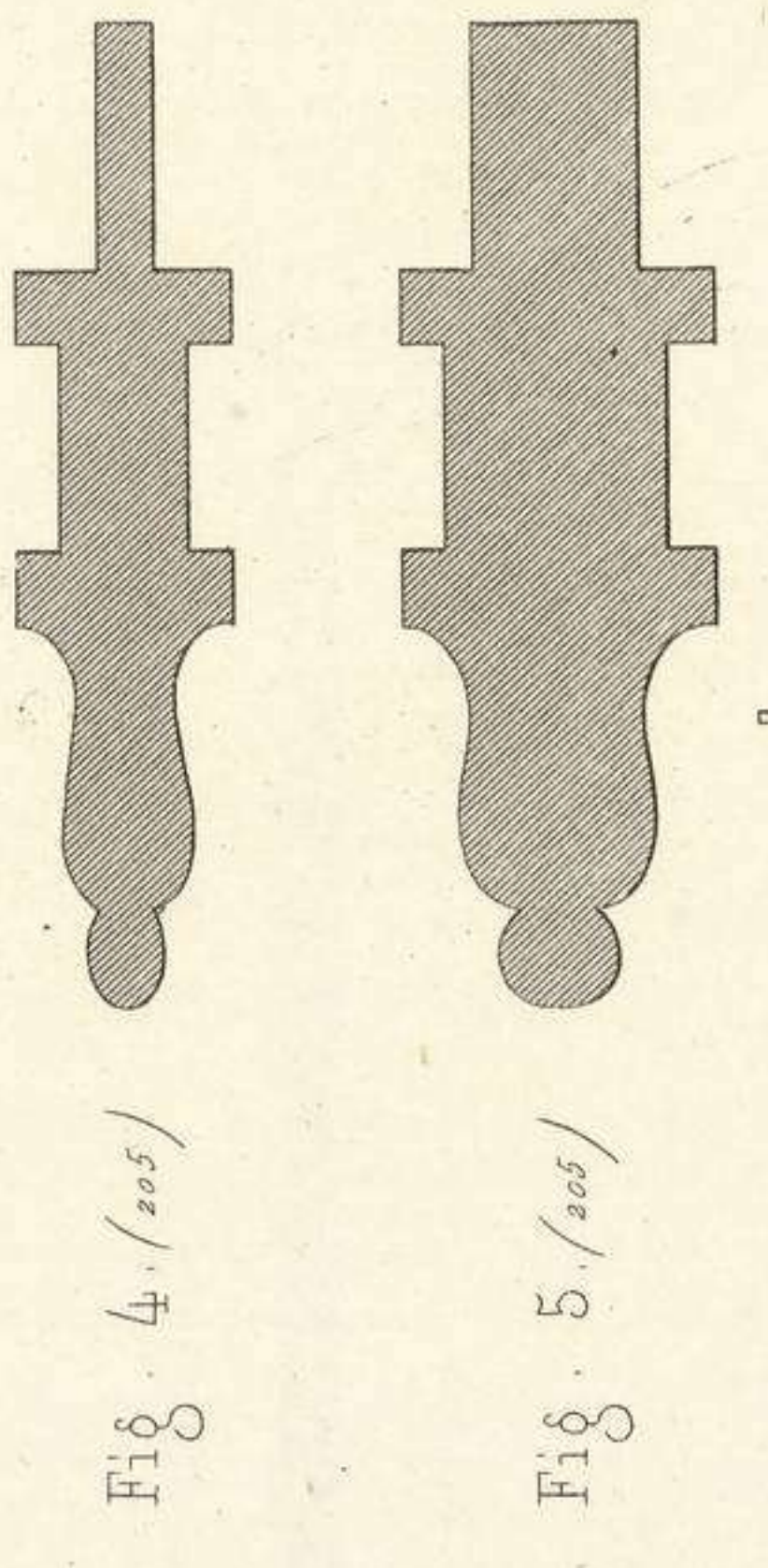
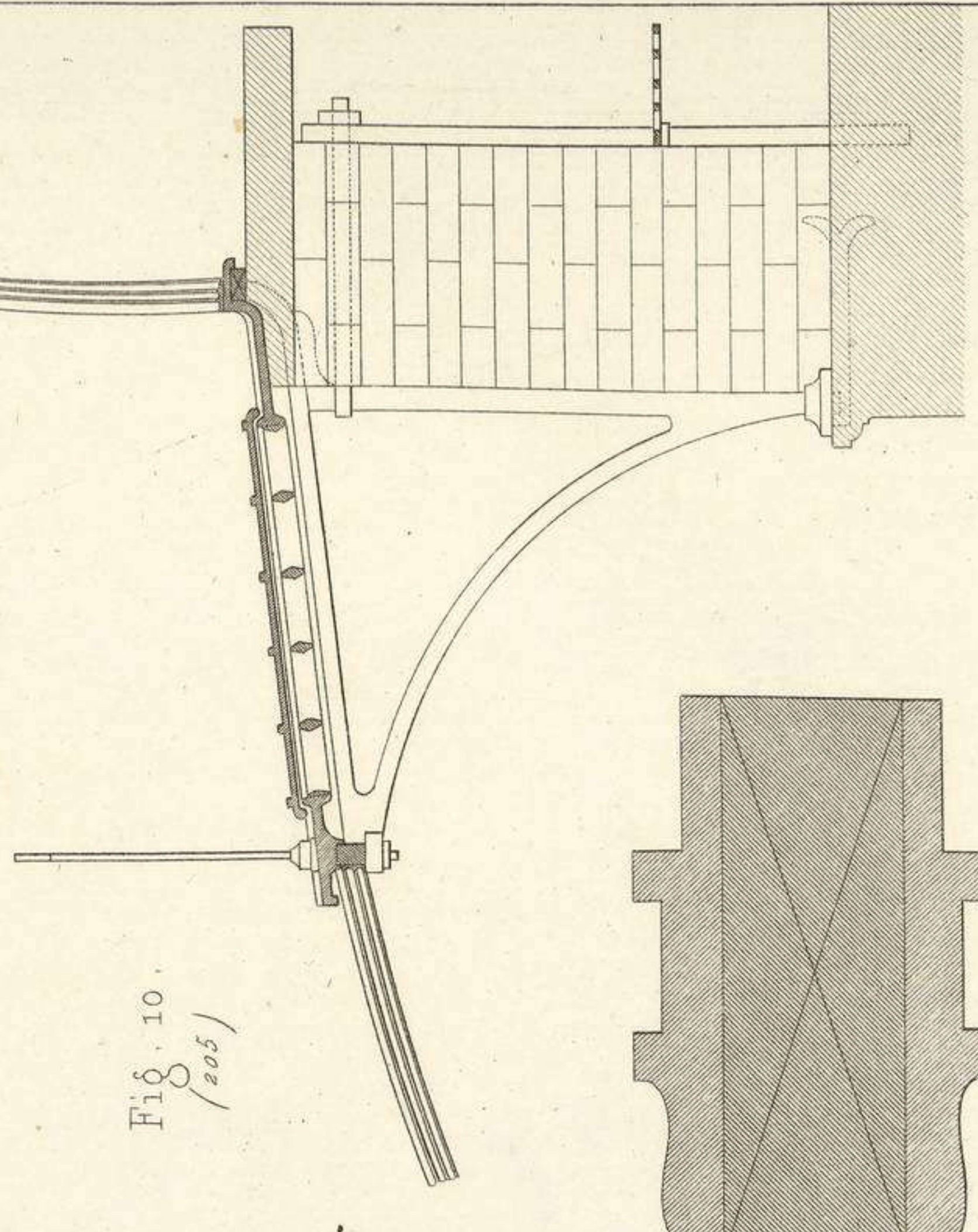

Fig. 4. (205)

Fig. 5. (205)

Fig. 10. (205)



Echelle des Fig. 7 et 10

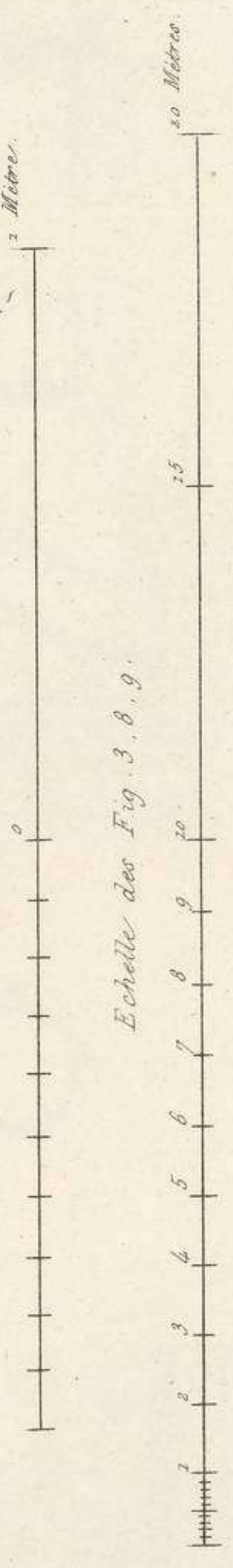

Echelle des Fig. 3, 8, 9.



Echelle des Fig. 1 et 2.

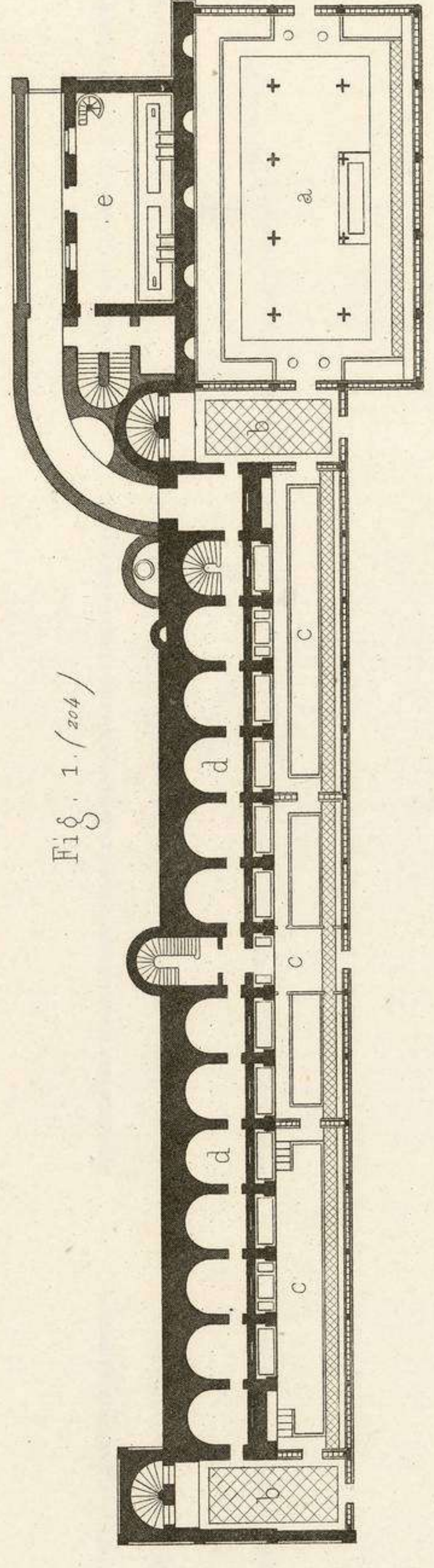

Fig. 1. (204)

Echelle des Fig. 1 et 2.





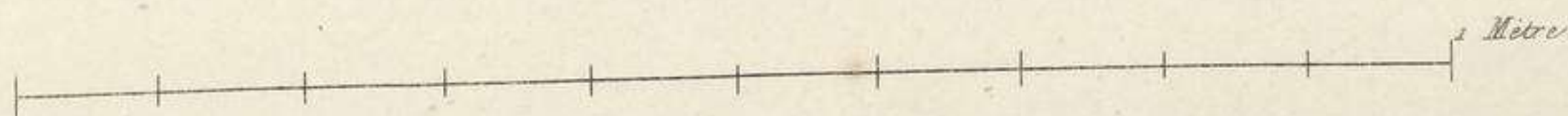
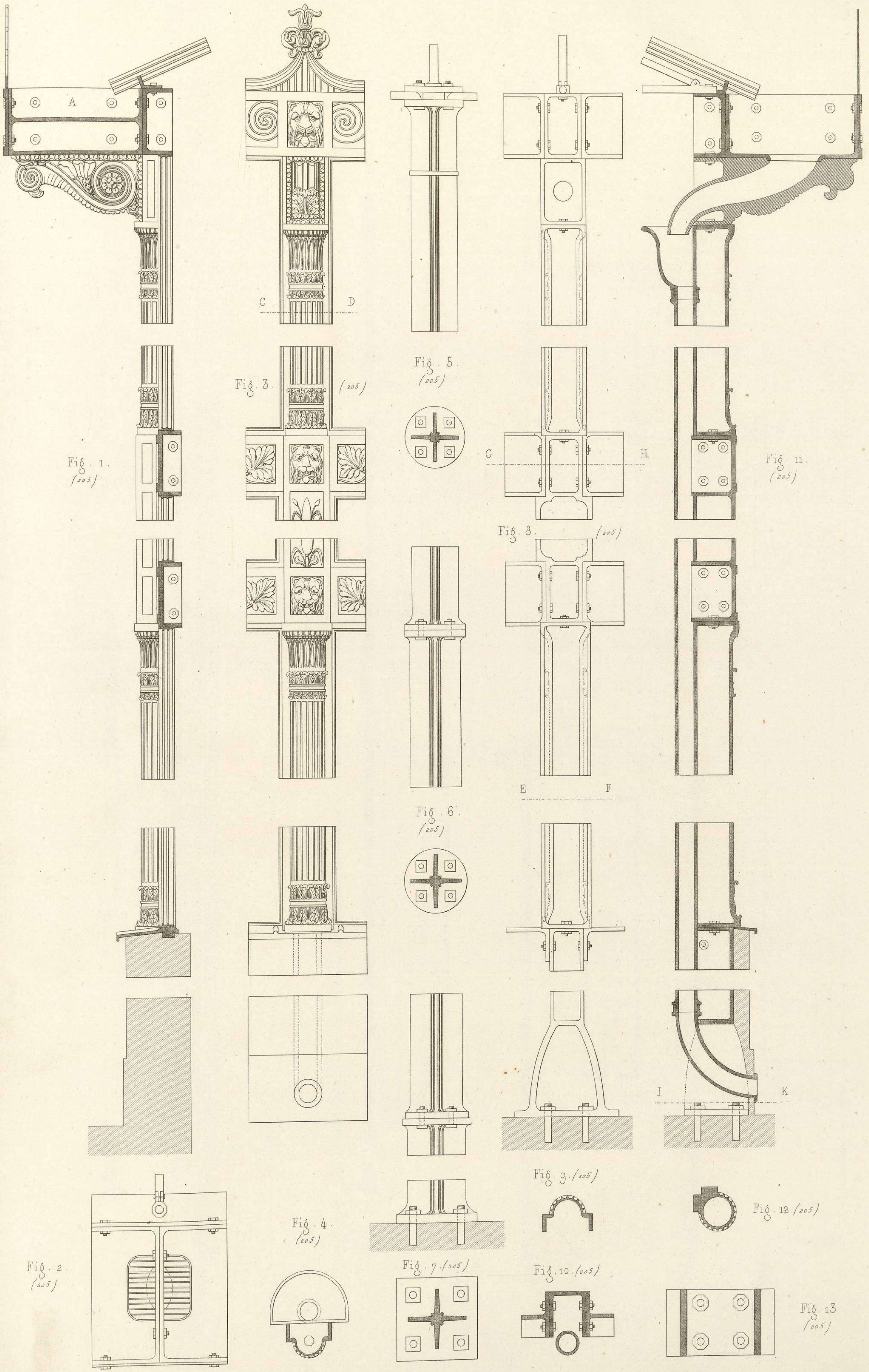



Fig. 1.

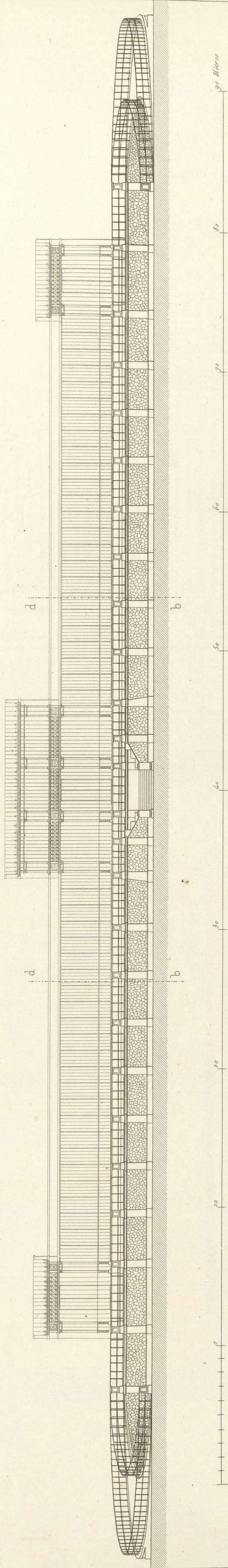
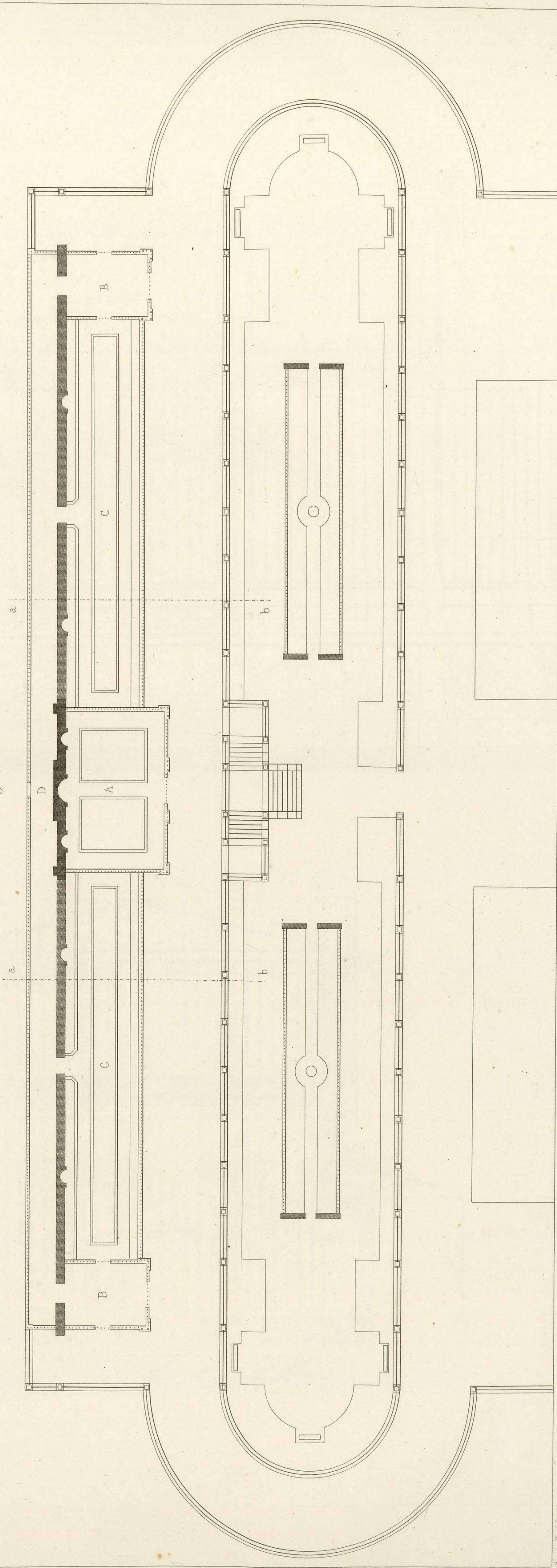

Fig. 2.



SERRURERIE.  
Serres.

B. et Y. del.

H. P.



Fig. 1.

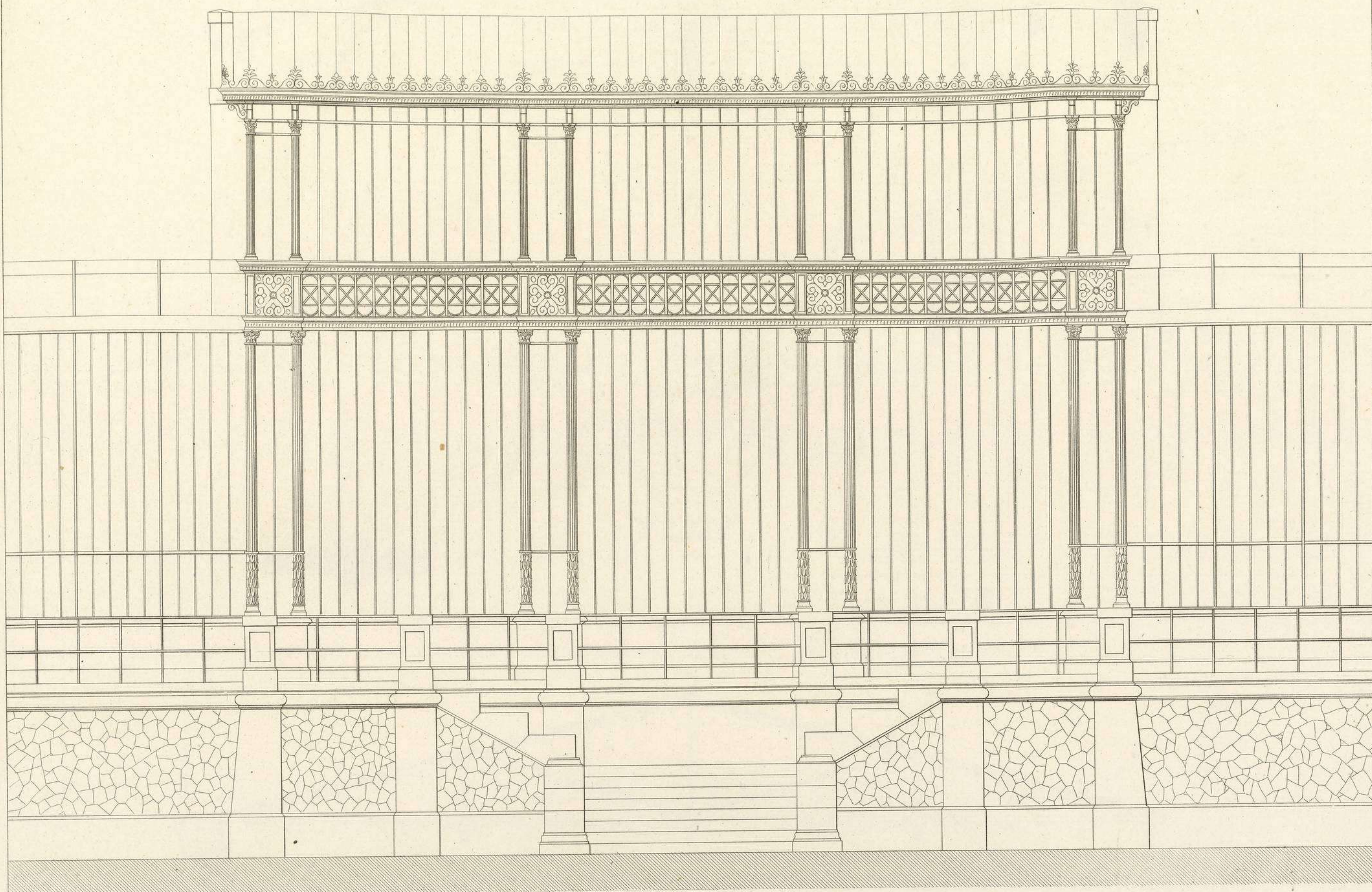
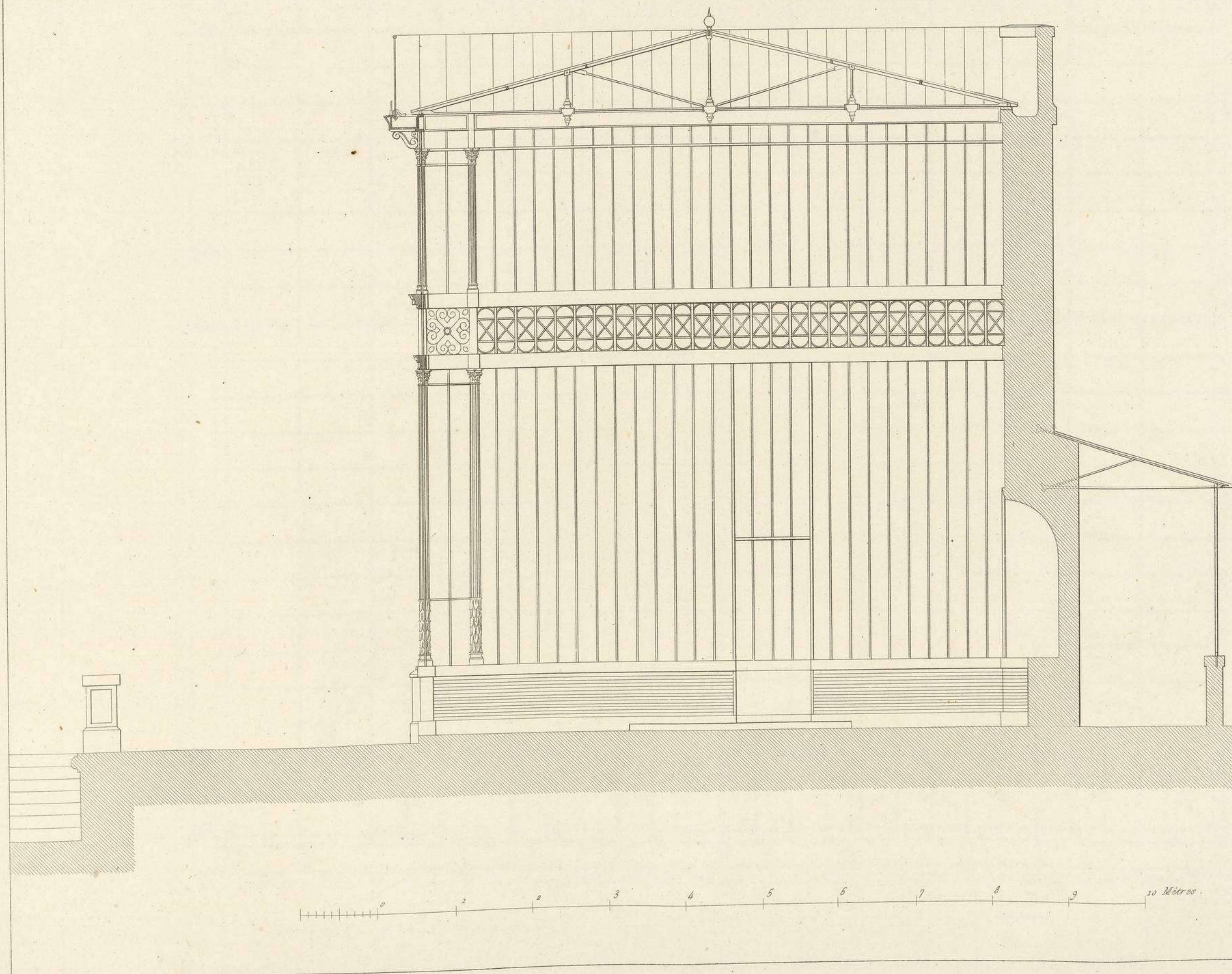

Fig. 2.



B. et V. del.

SERRURERIE.  
Serres

H. R.



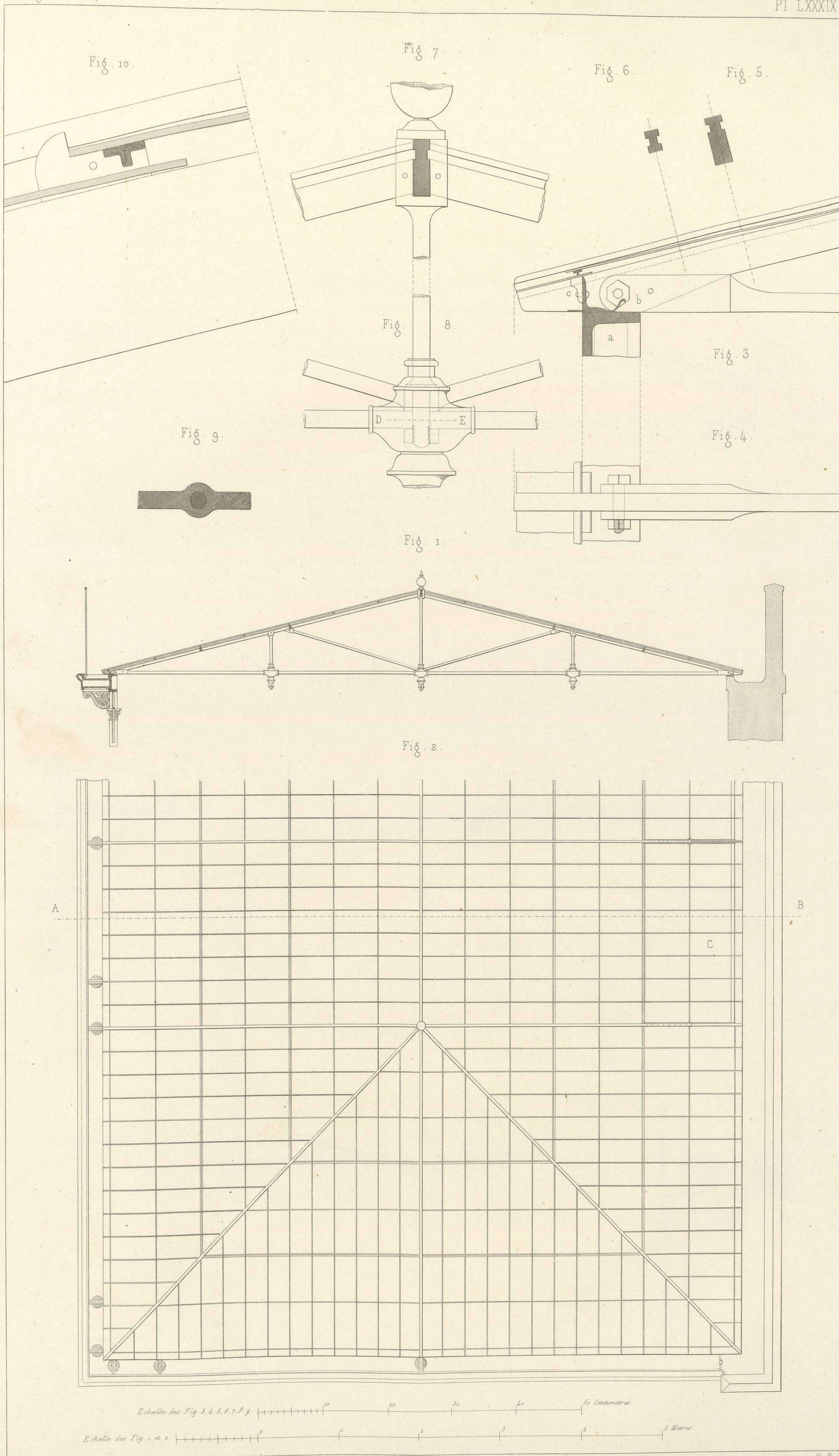

SERRURERIE

Serres



Fig. 3.

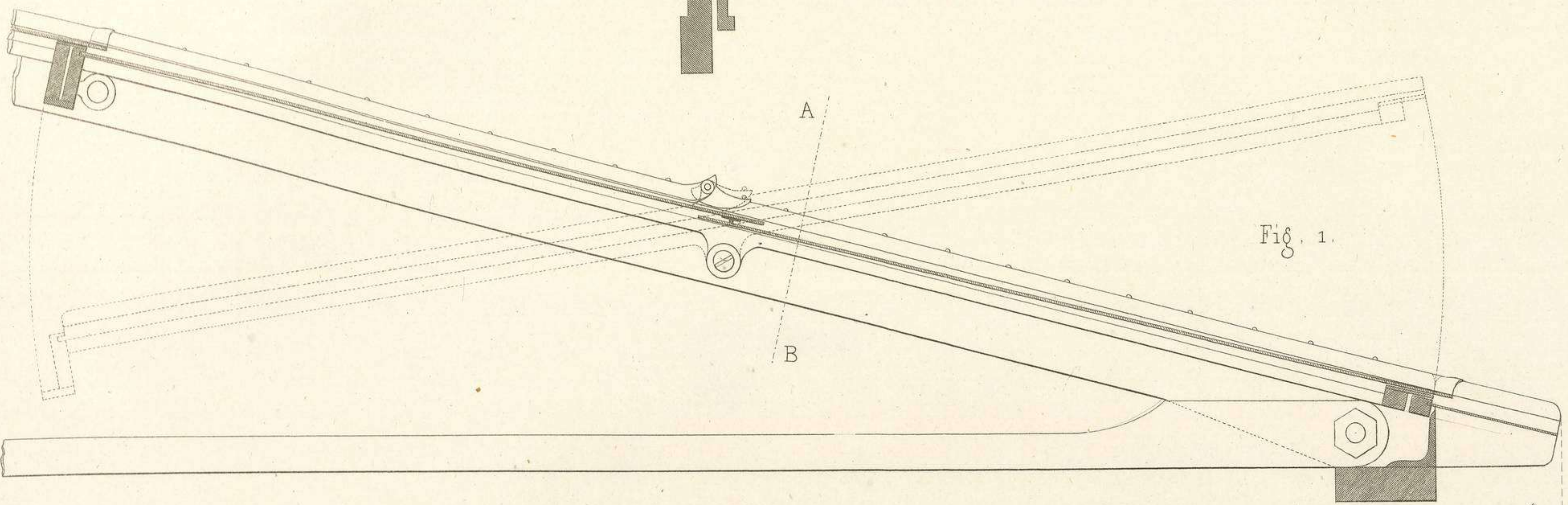
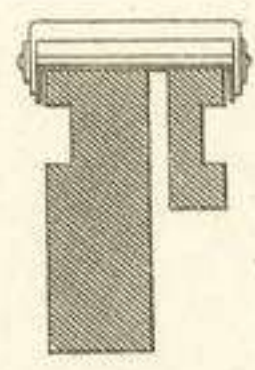

Fig. 1.

A

B

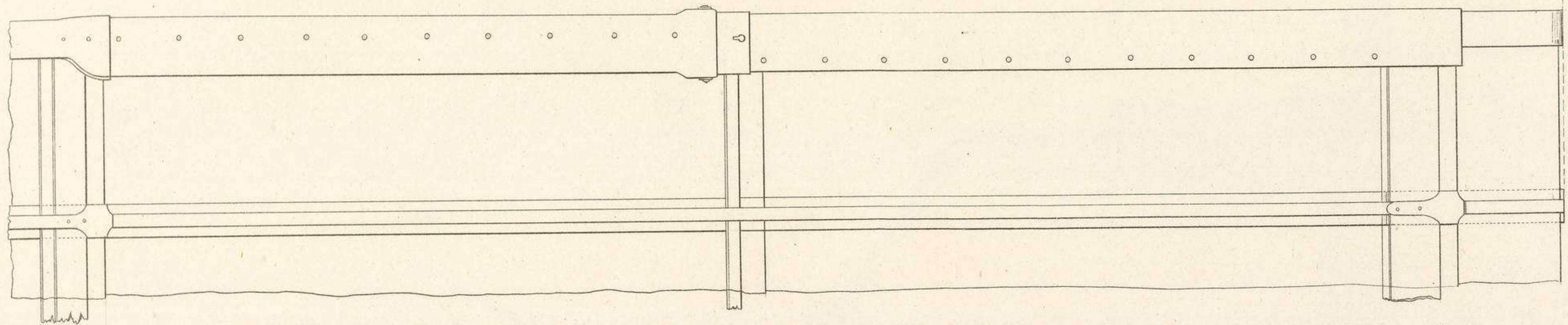

Fig. 2.

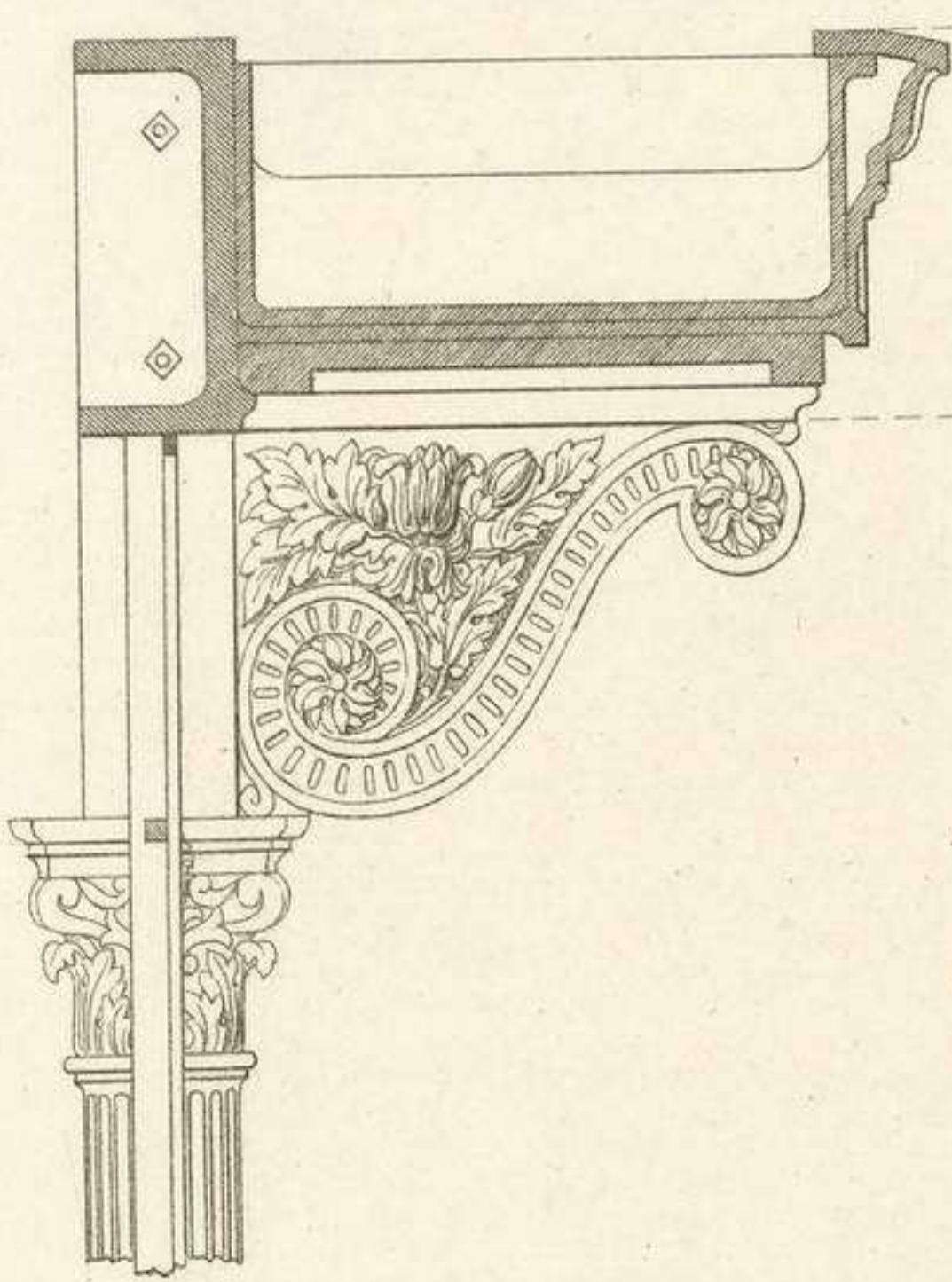

Fig. 4.

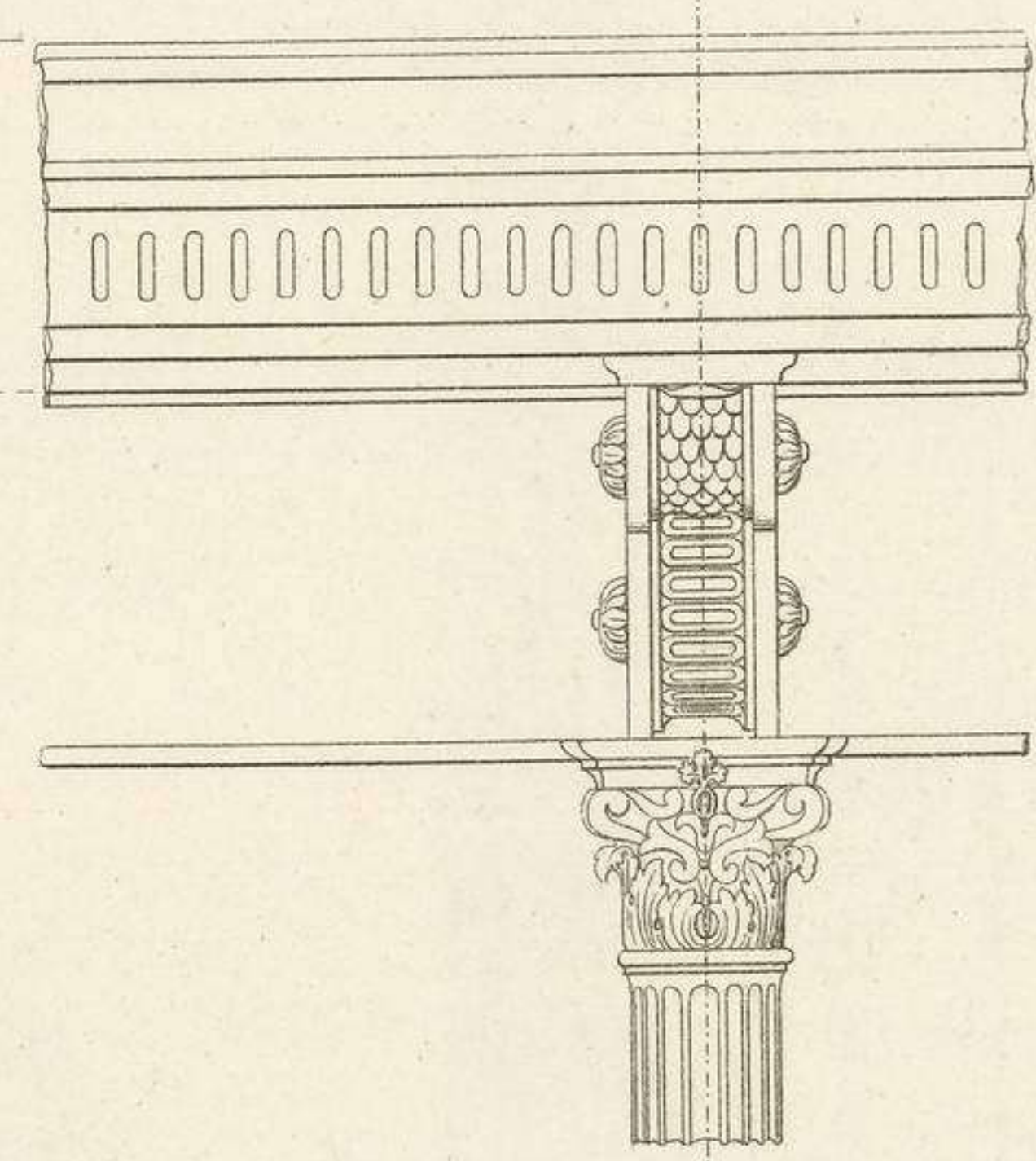
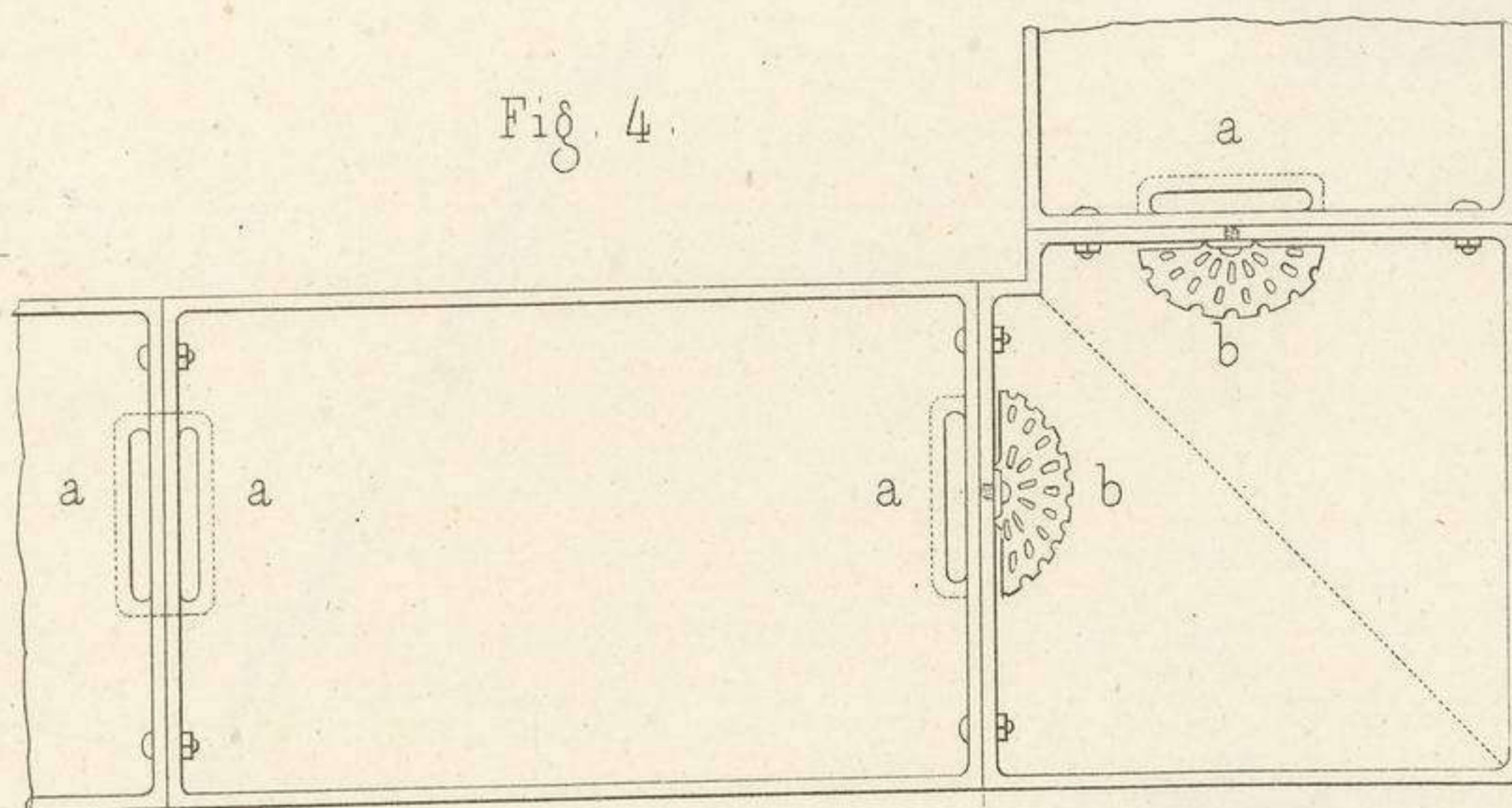

Fig. 6.

Fig. 5.

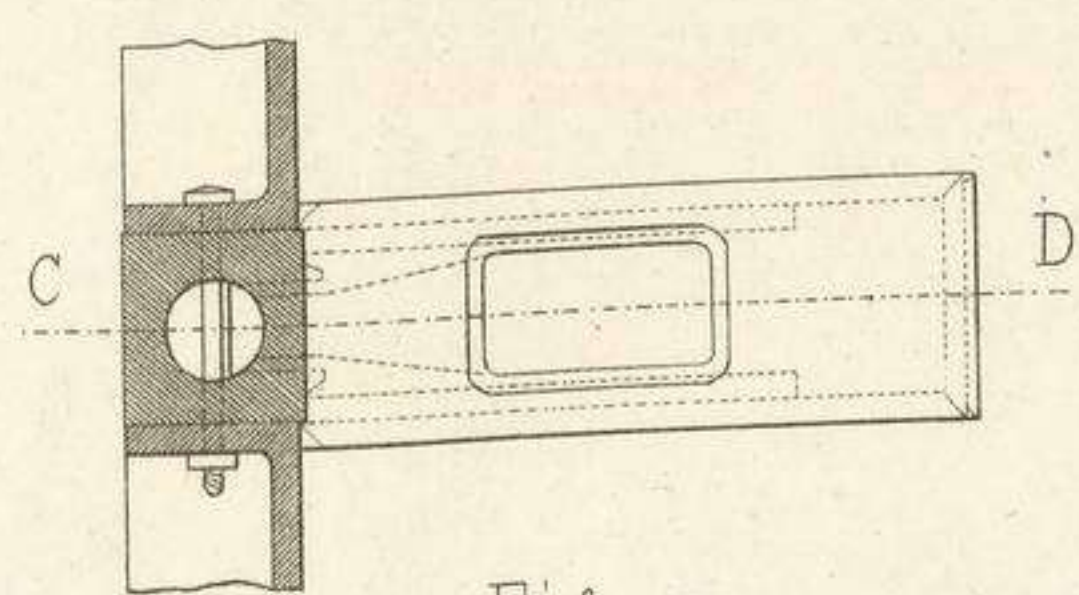
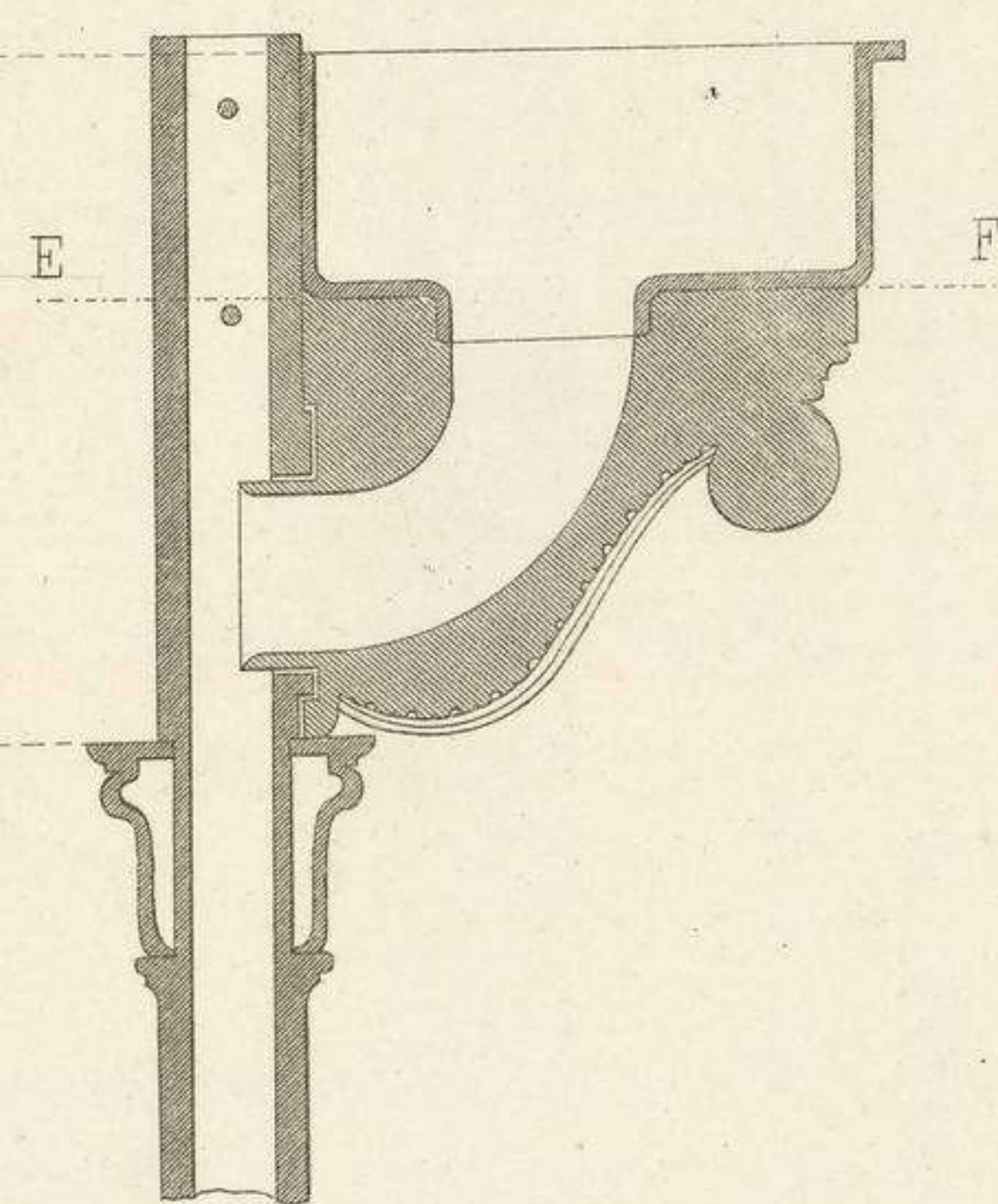
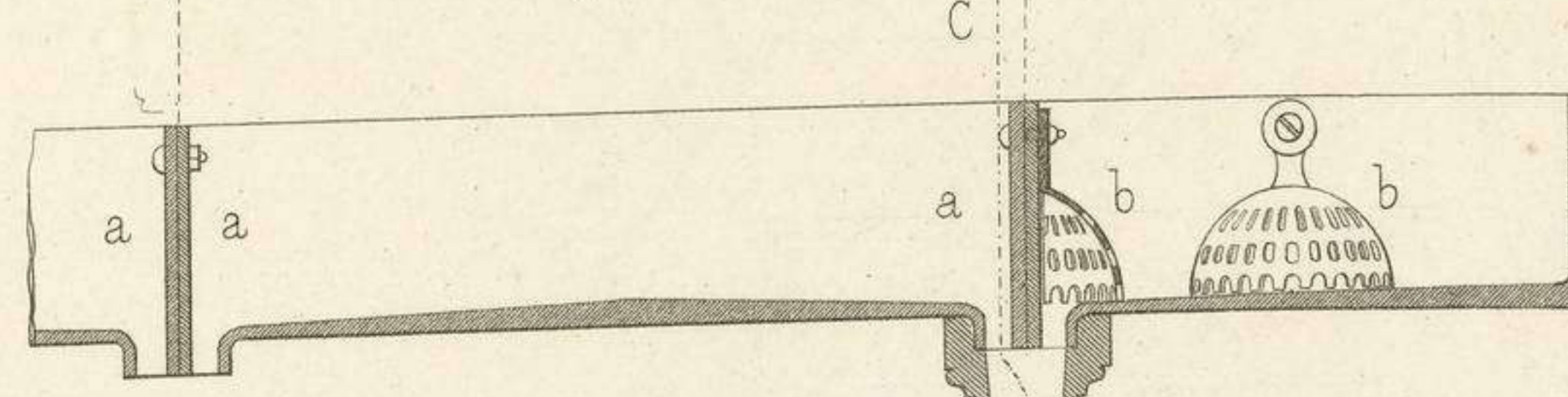
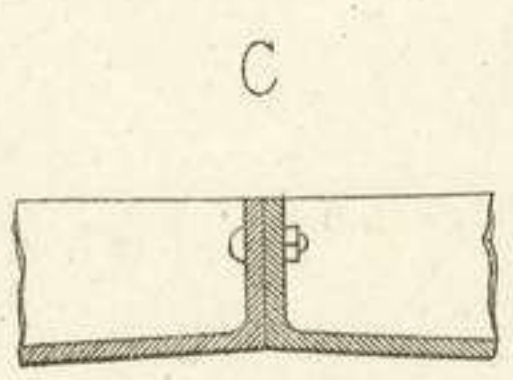

Fig. 7.



B. et V. del.

H. R.

SERRURERIE.

Serres.



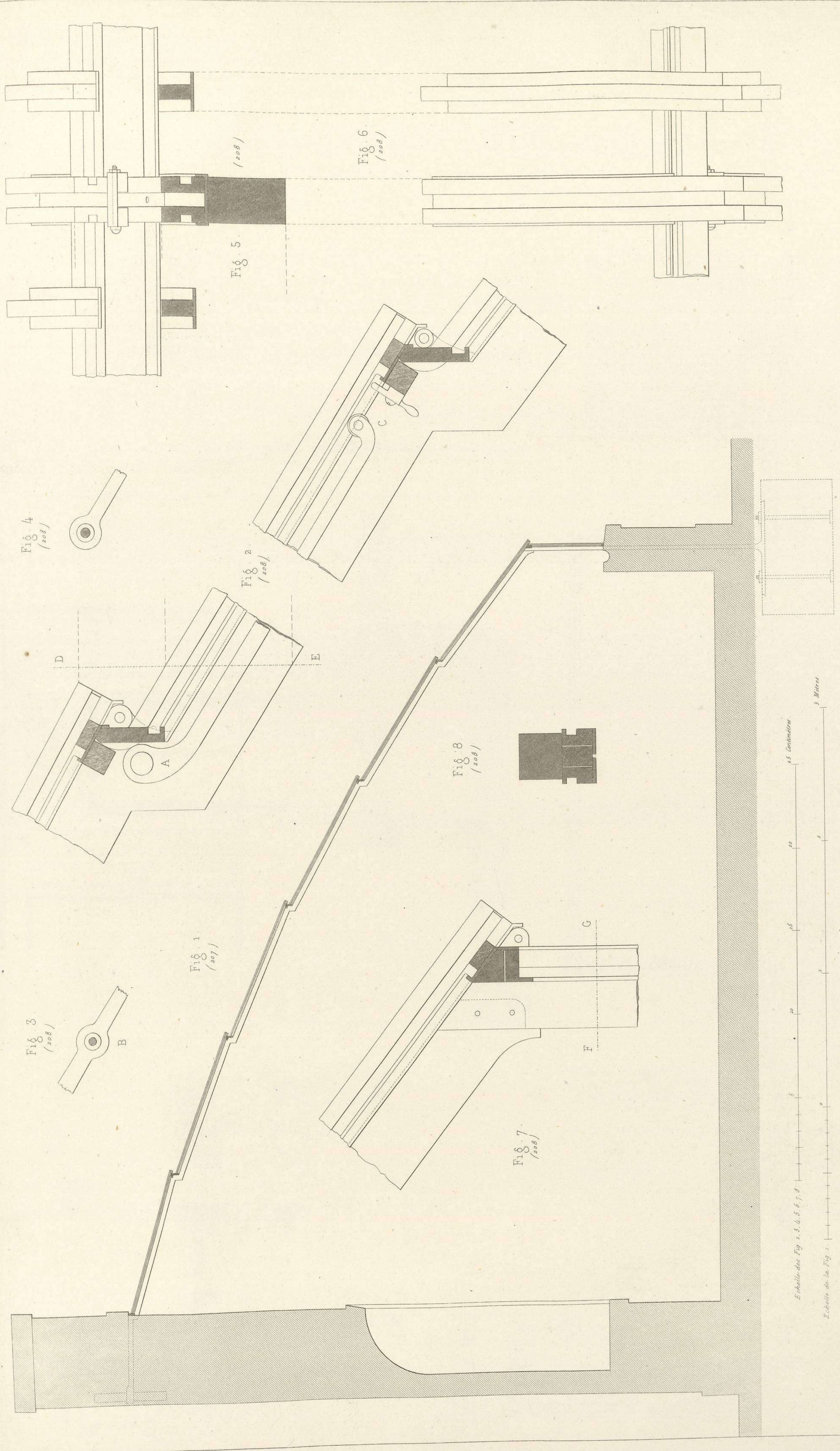

Echelle des Fig. 2, 3, 4, 5, 6, 7, 8.

Echelle de la Fig. 1. 3 Mètres



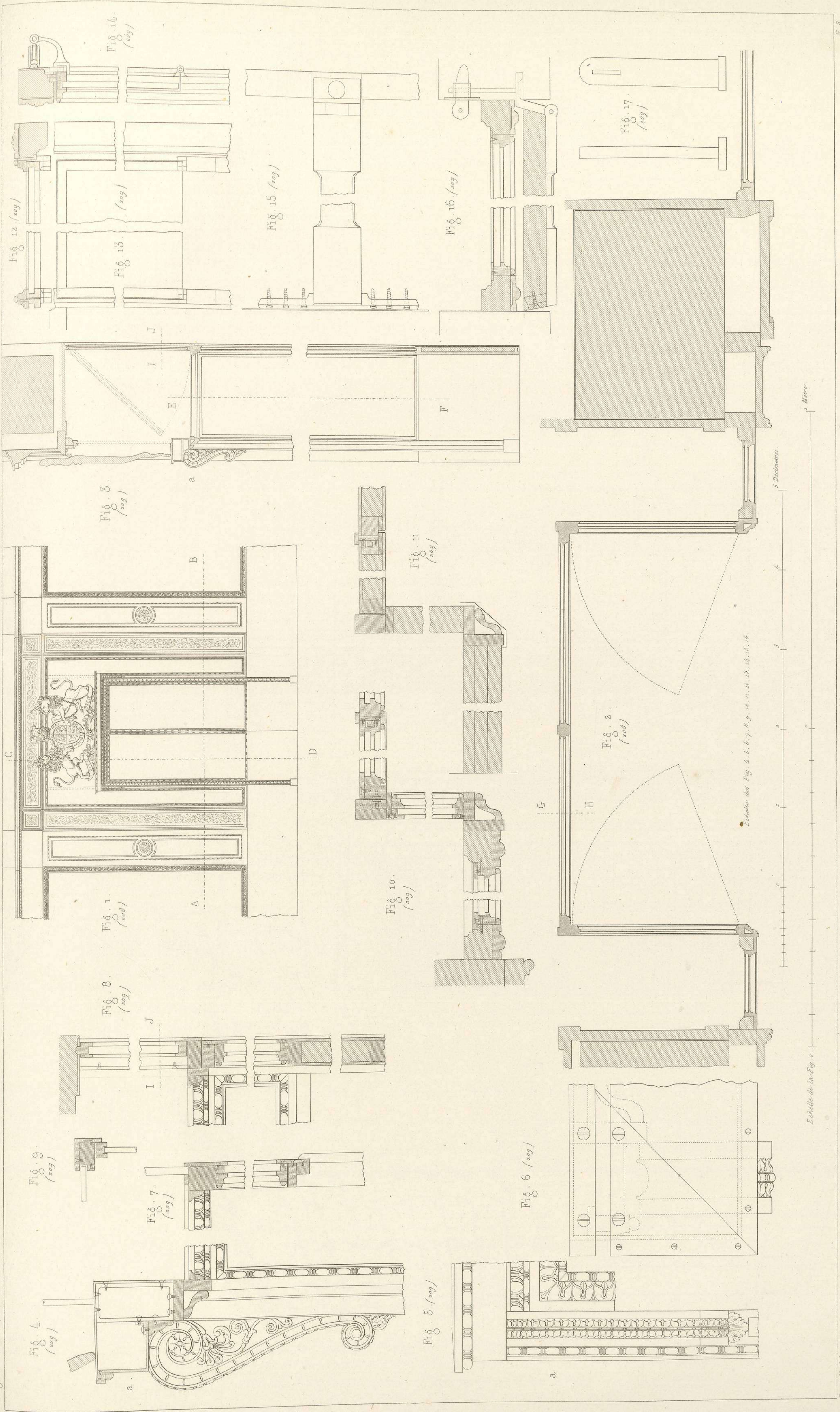

SERRURERIE.  
Devanture de Boutique.

H. R.







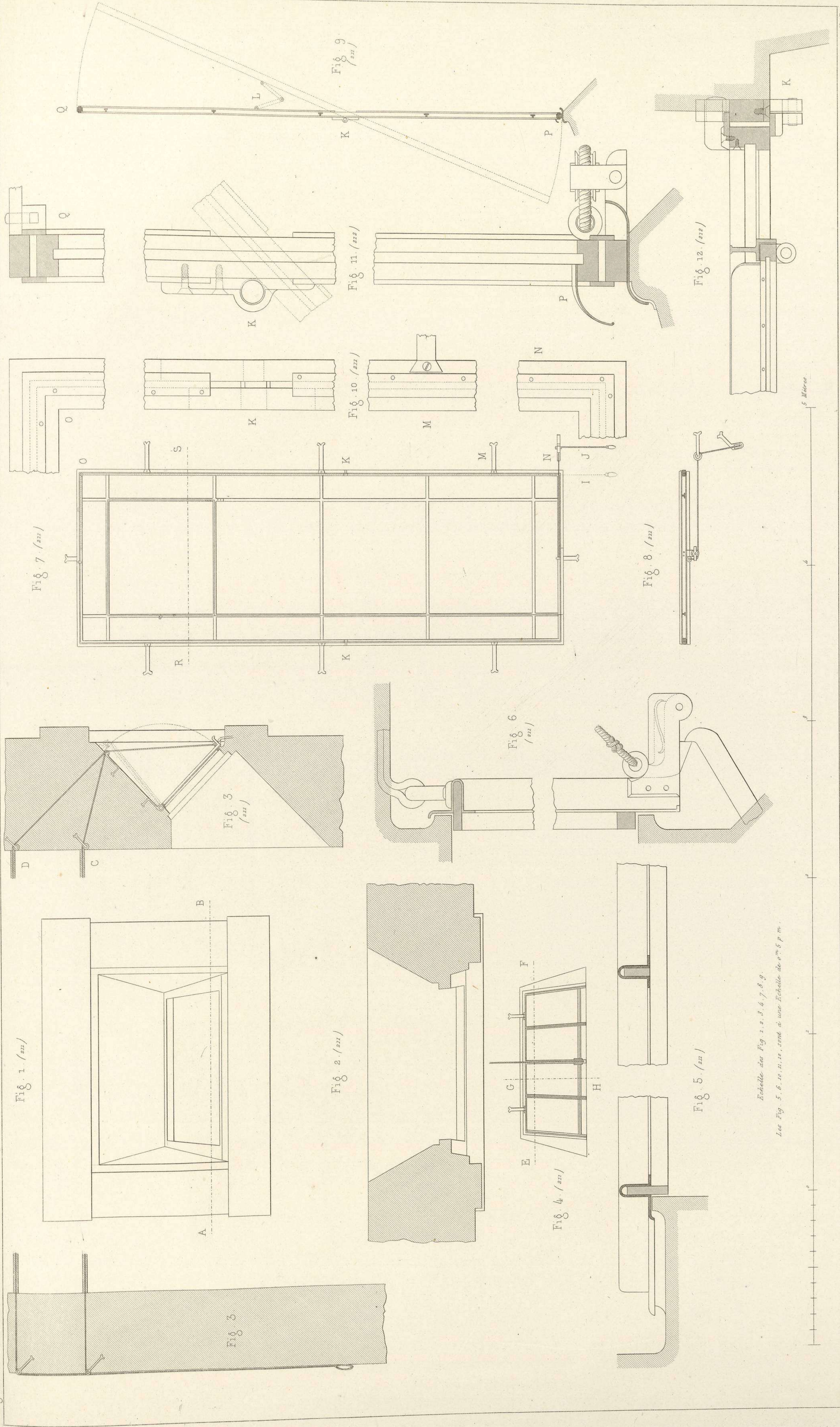

Echelle des Fig. 1, 2, 3, 4, 7, 8, 9.  
 Les Fig. 5, 6, 10, 11, 12, sont à une Echelle de 8<sup>m</sup> 5 p. m.

SERRURERIE.  
 Fermetures.

B. de V. del.



Fig. 1.

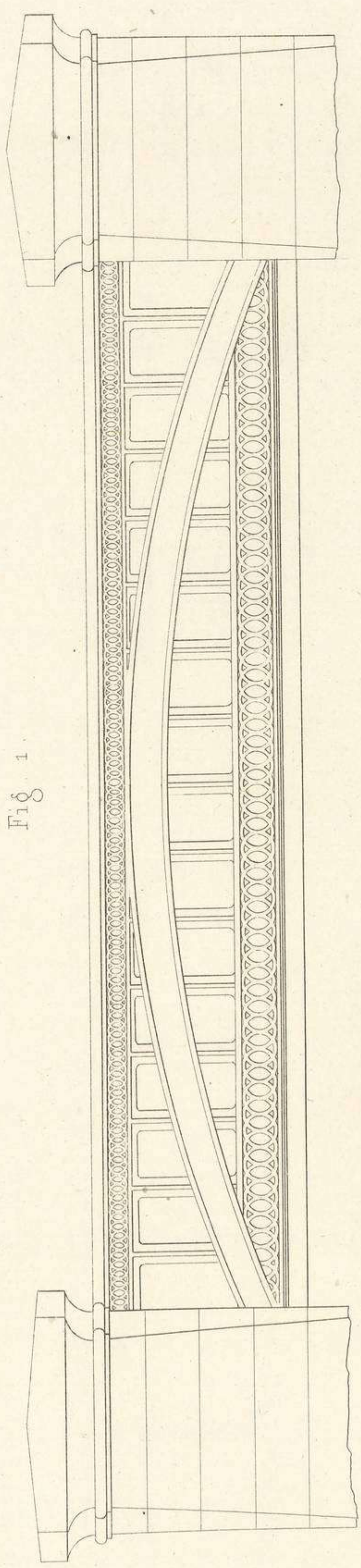

Fig. 2.

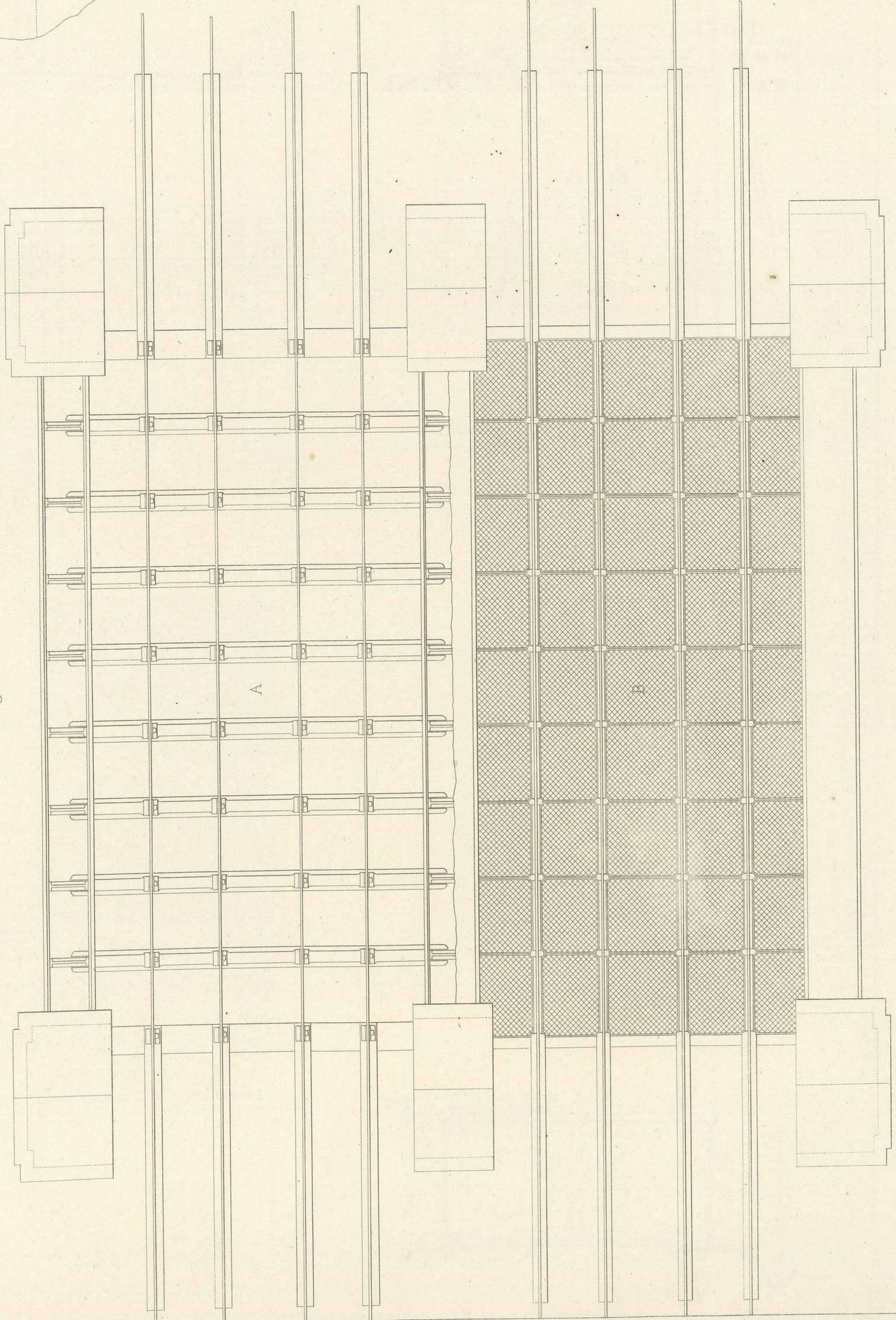

Fig. 3.

N<sup>o</sup> 2 Cette coupe du chemin a été faite sur le terre plein des culées.

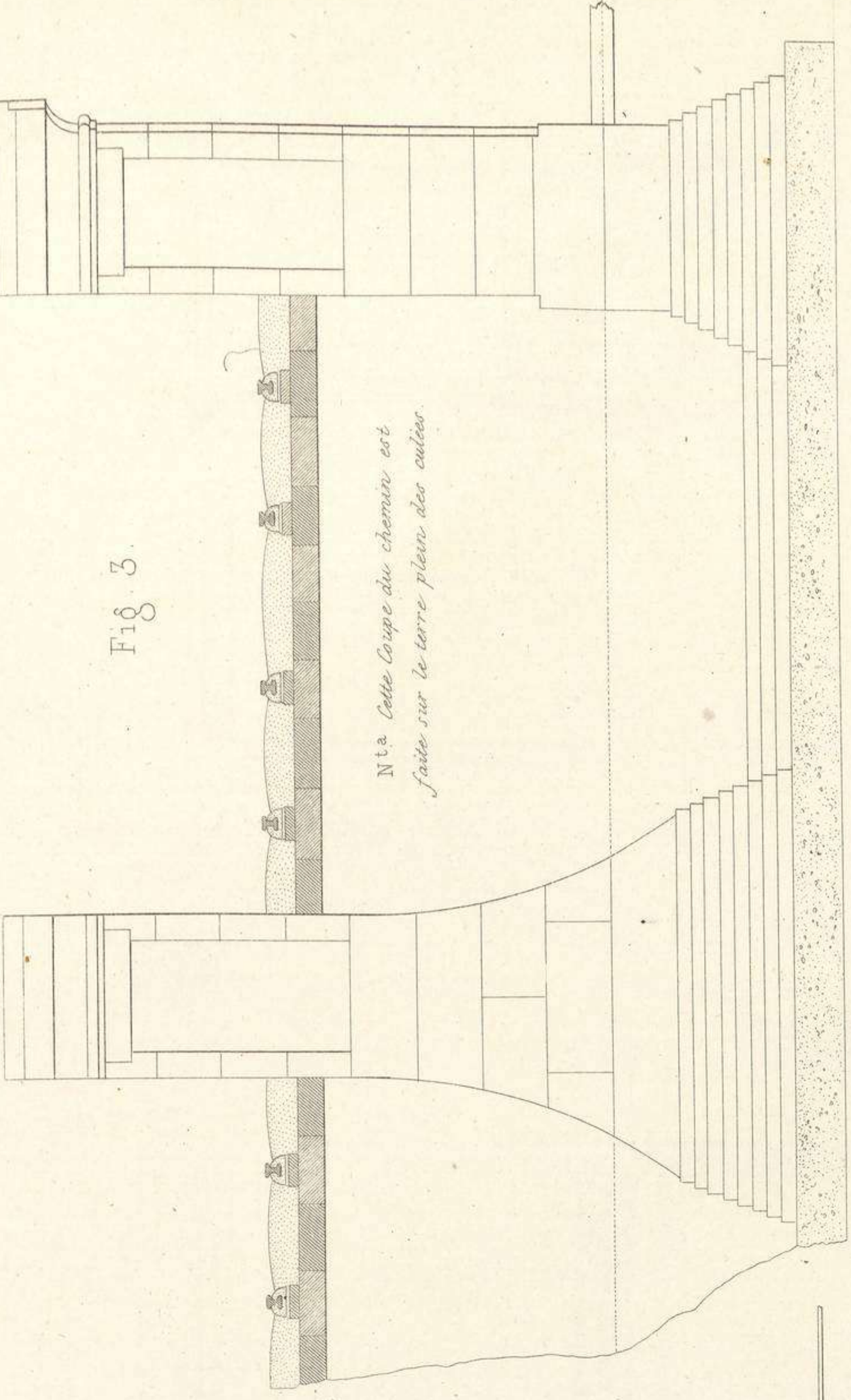
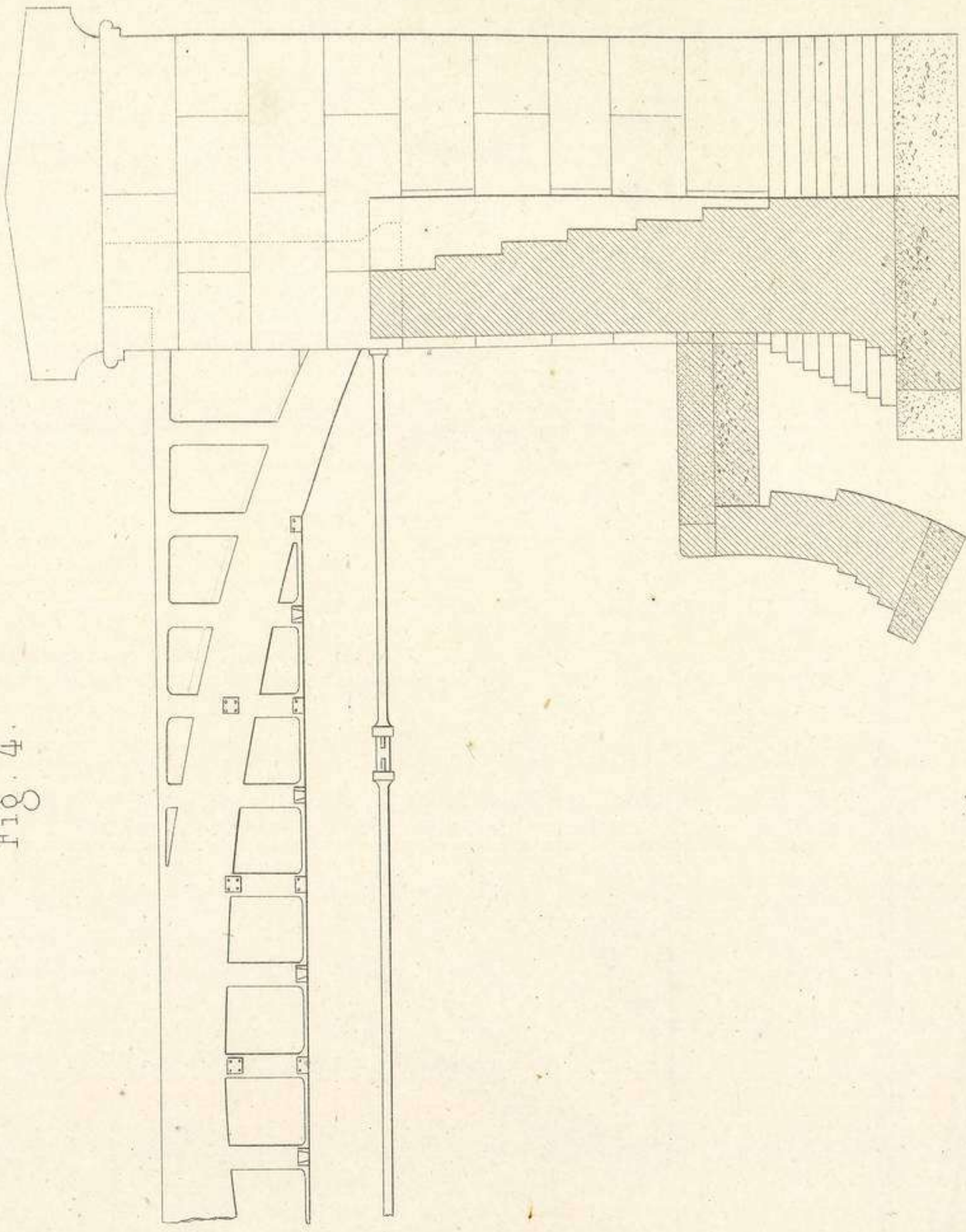

Fig. 4.



SERRURERIE.  
Ponts en fonte.

P. de F. del.



Fig. 3 (228)

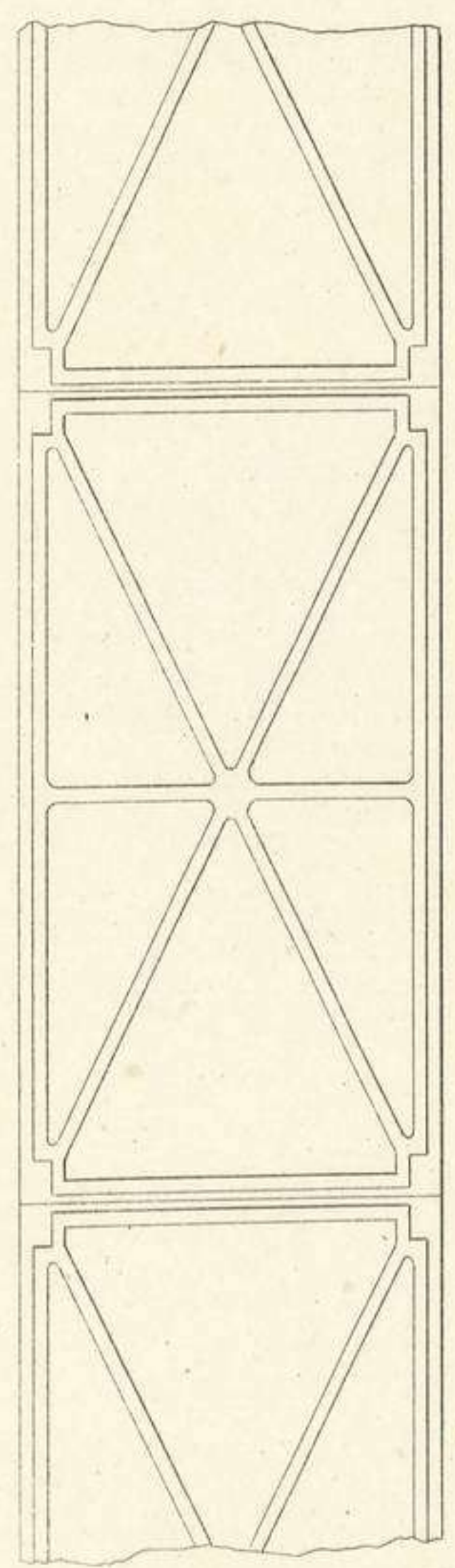

Fig. 4 (228)

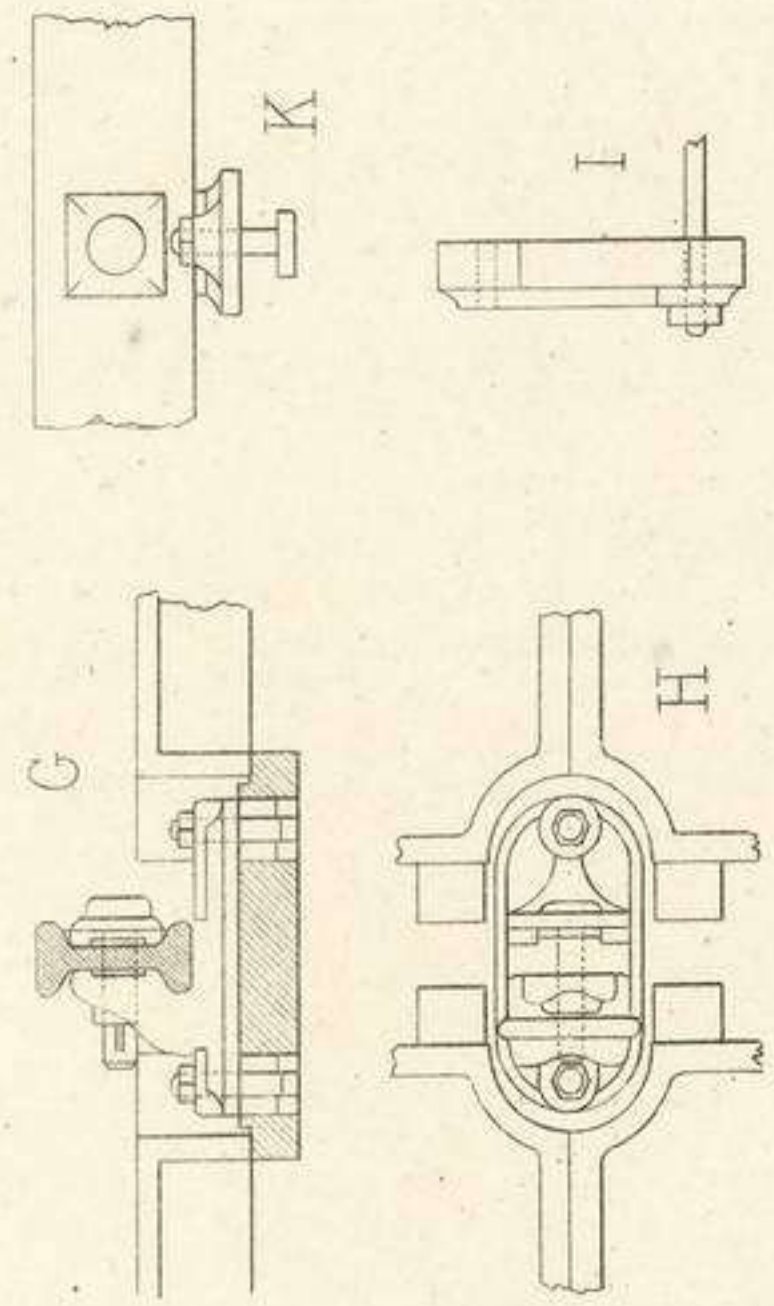

Fig. 5 (228)

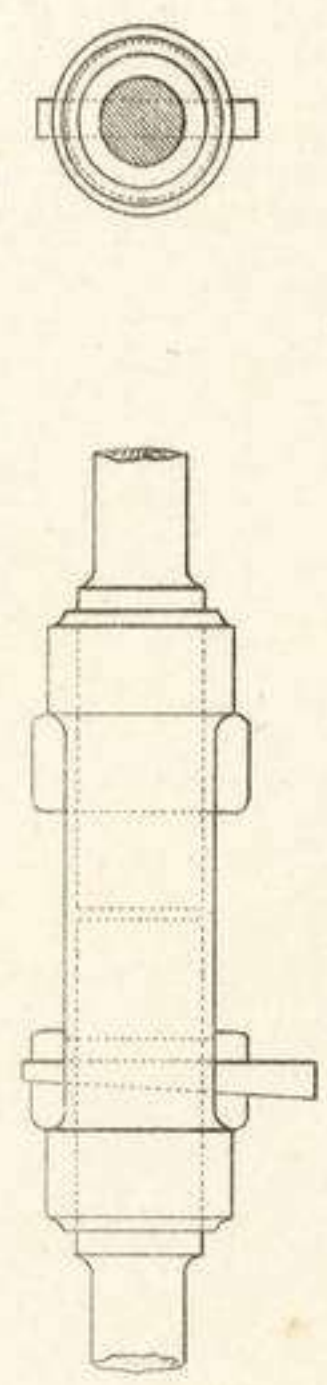

Fig. 6 (228)

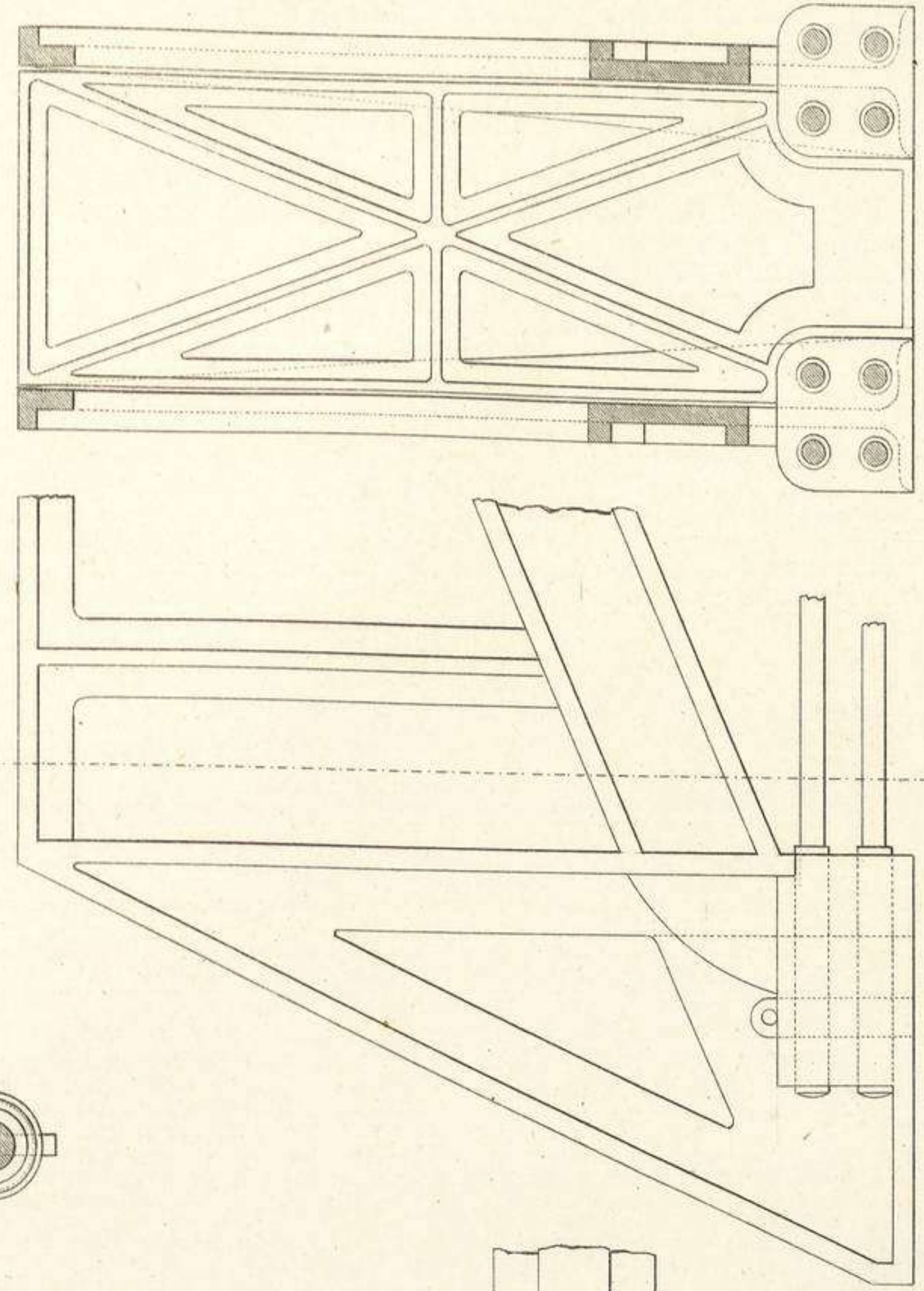

Fig. 7 (228)

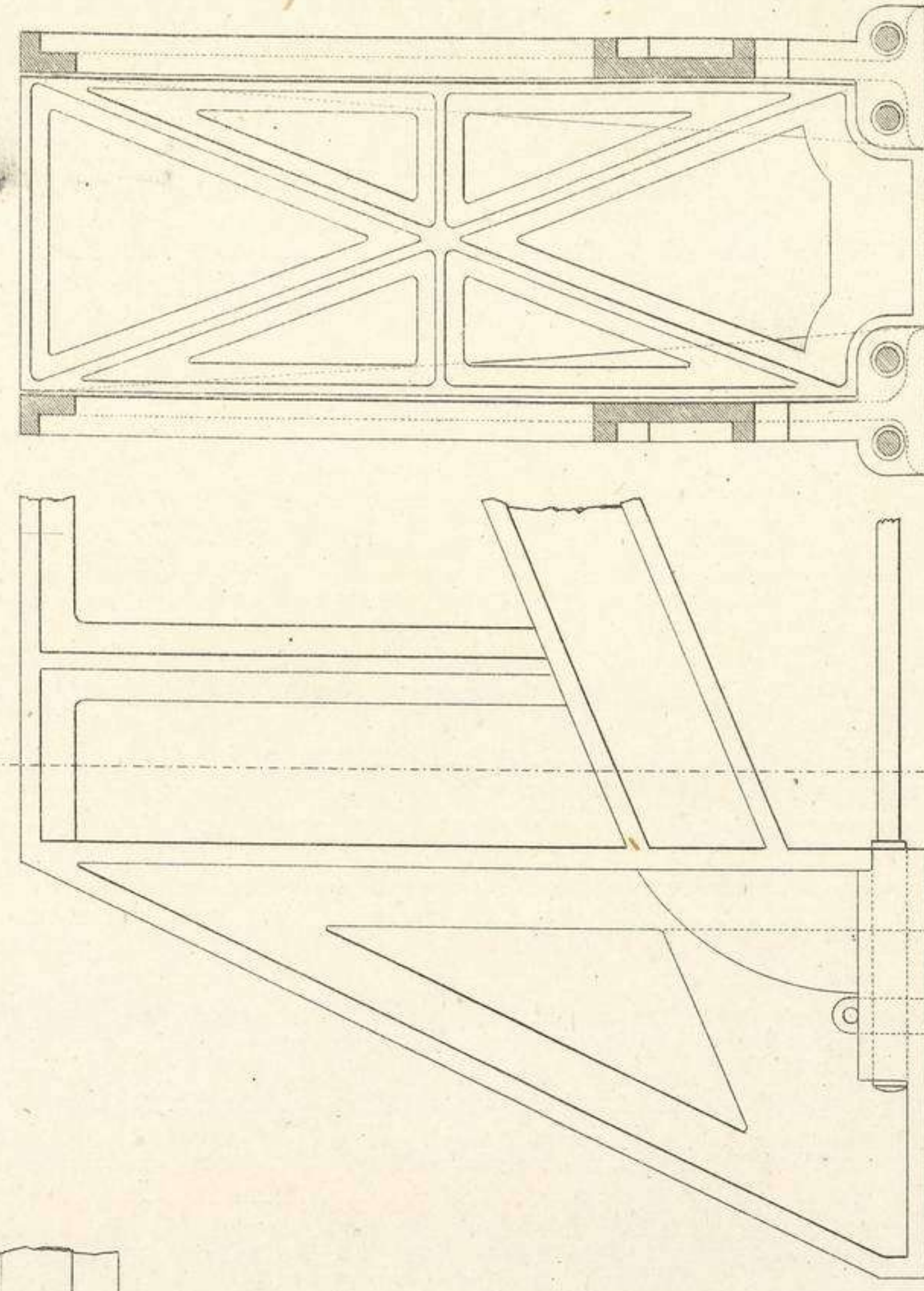
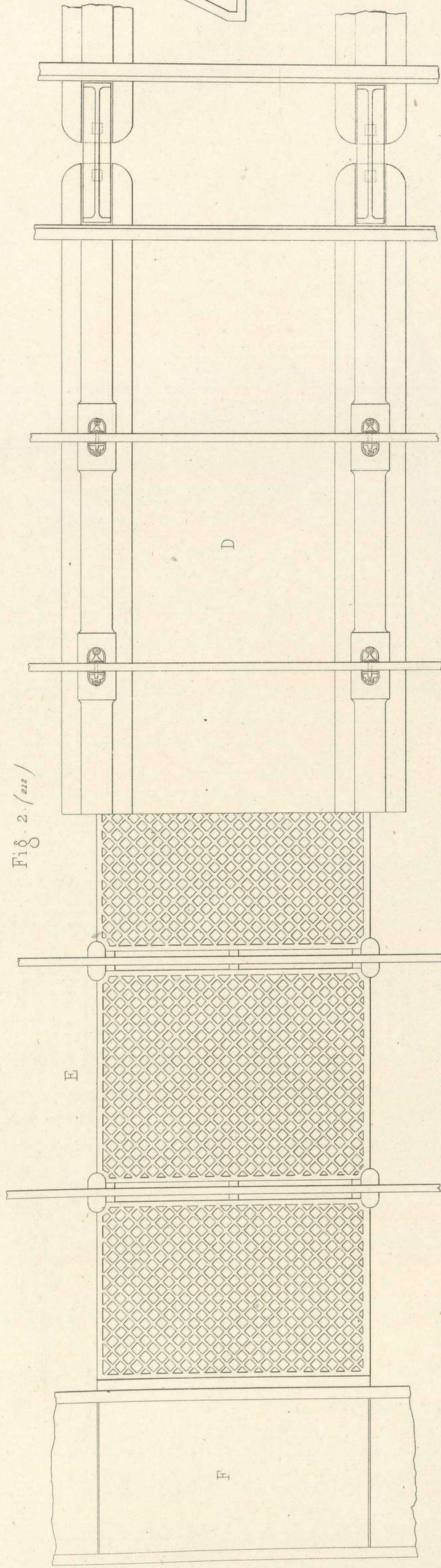
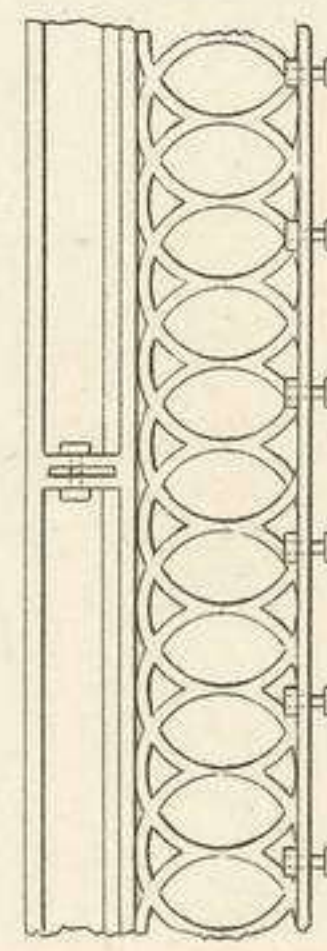

Fig. 2 (228)



A



B

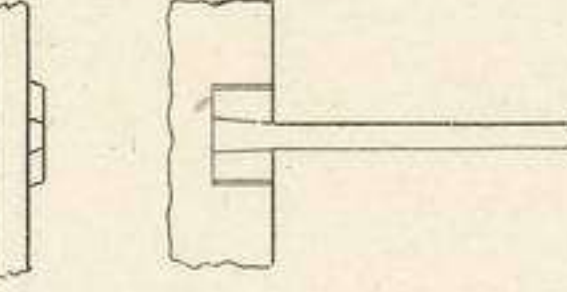

C

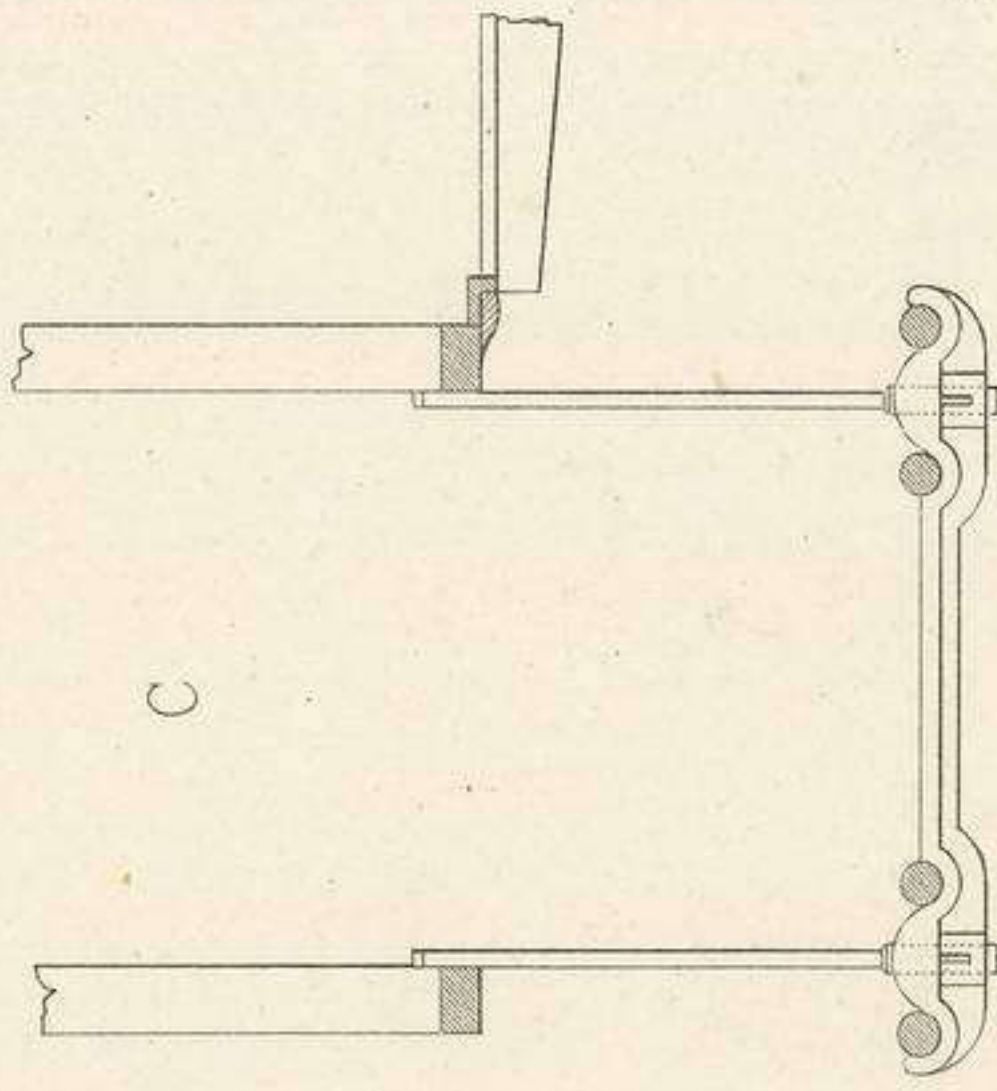
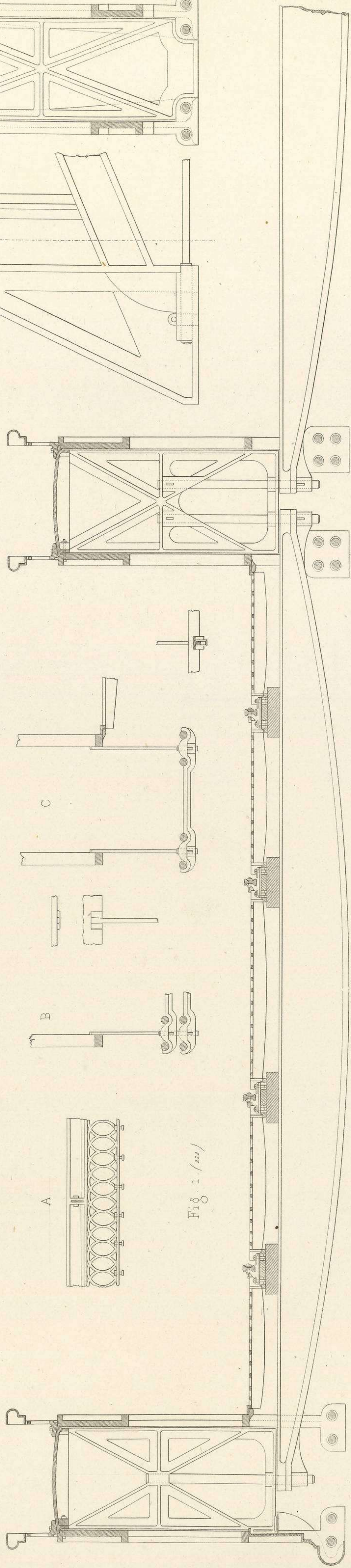

Fig. 1 (228)



Exécution des Fig. 1, 2, 3, 6, 7.  
Les Fig. 4 et 5 sont au double.

5 Mètres

B. de V. del.

H. P.

SERRURERIE.  
Ponts en fonte.



Fig. 1.

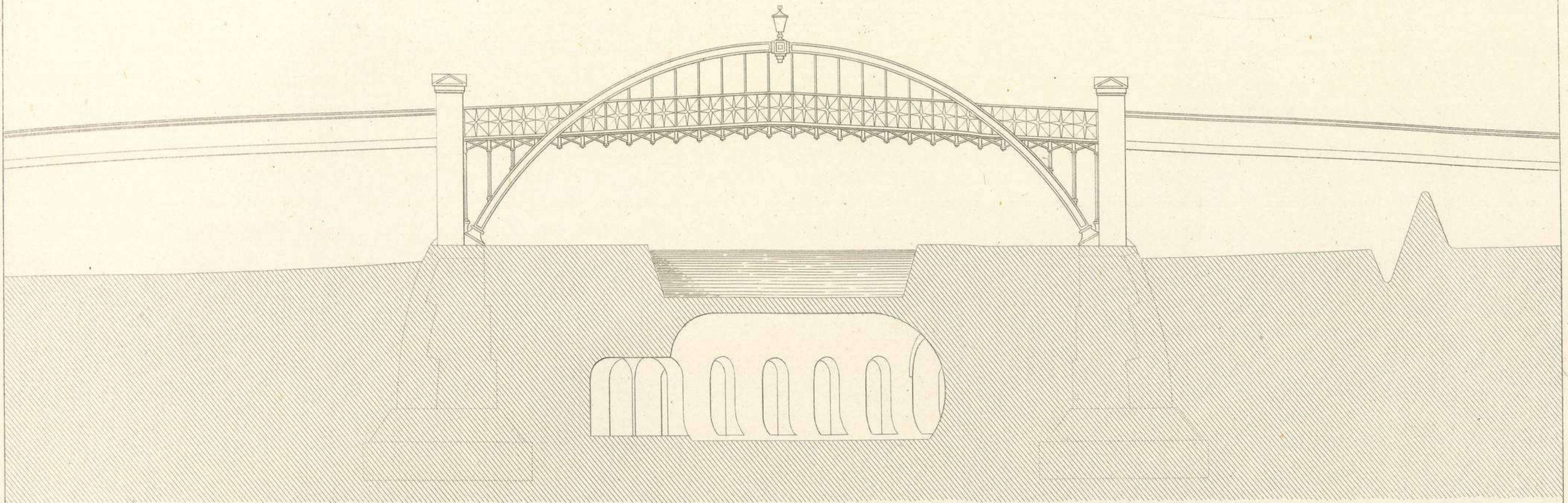

Fig. 3.

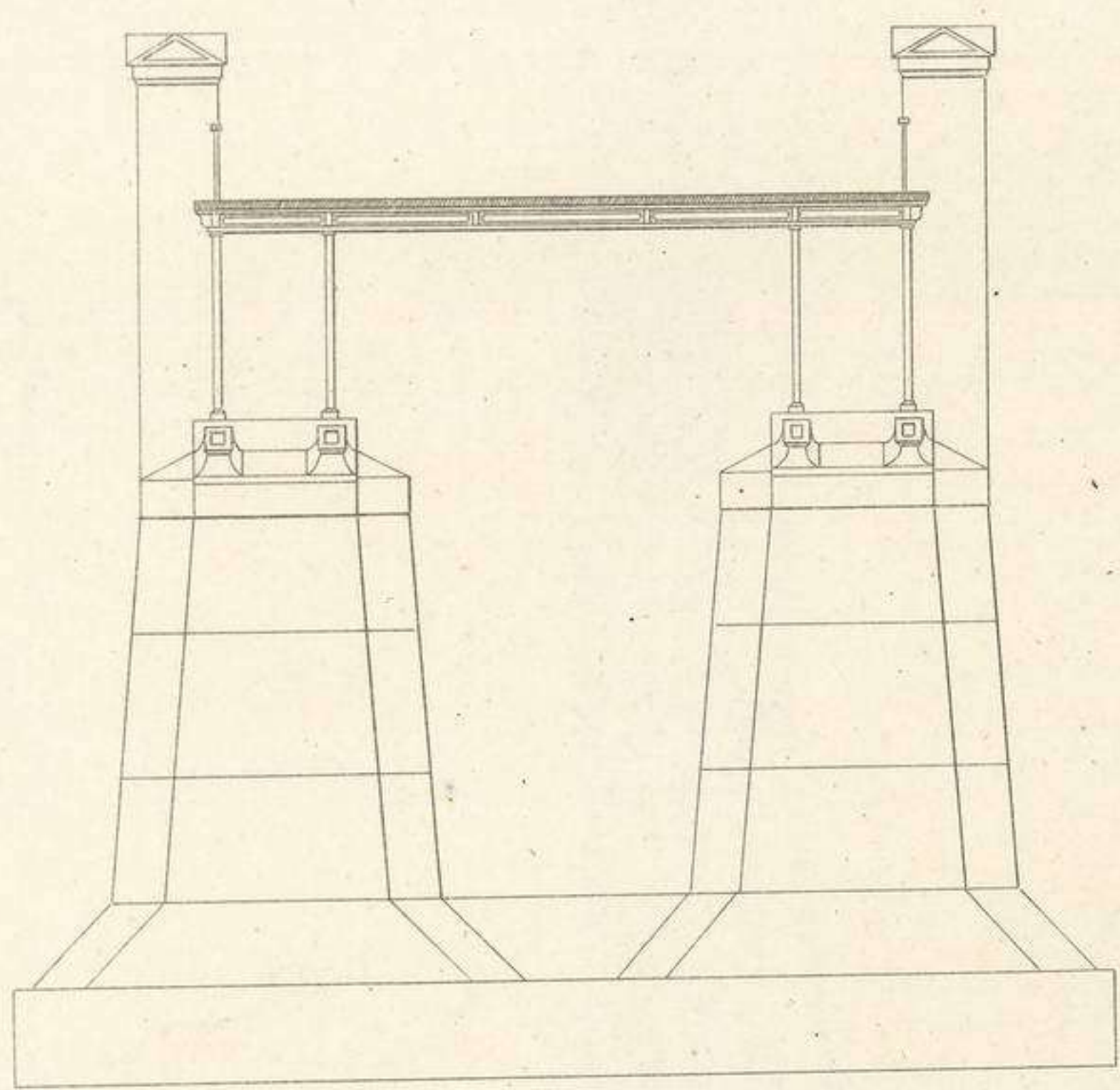

Fig. 4.

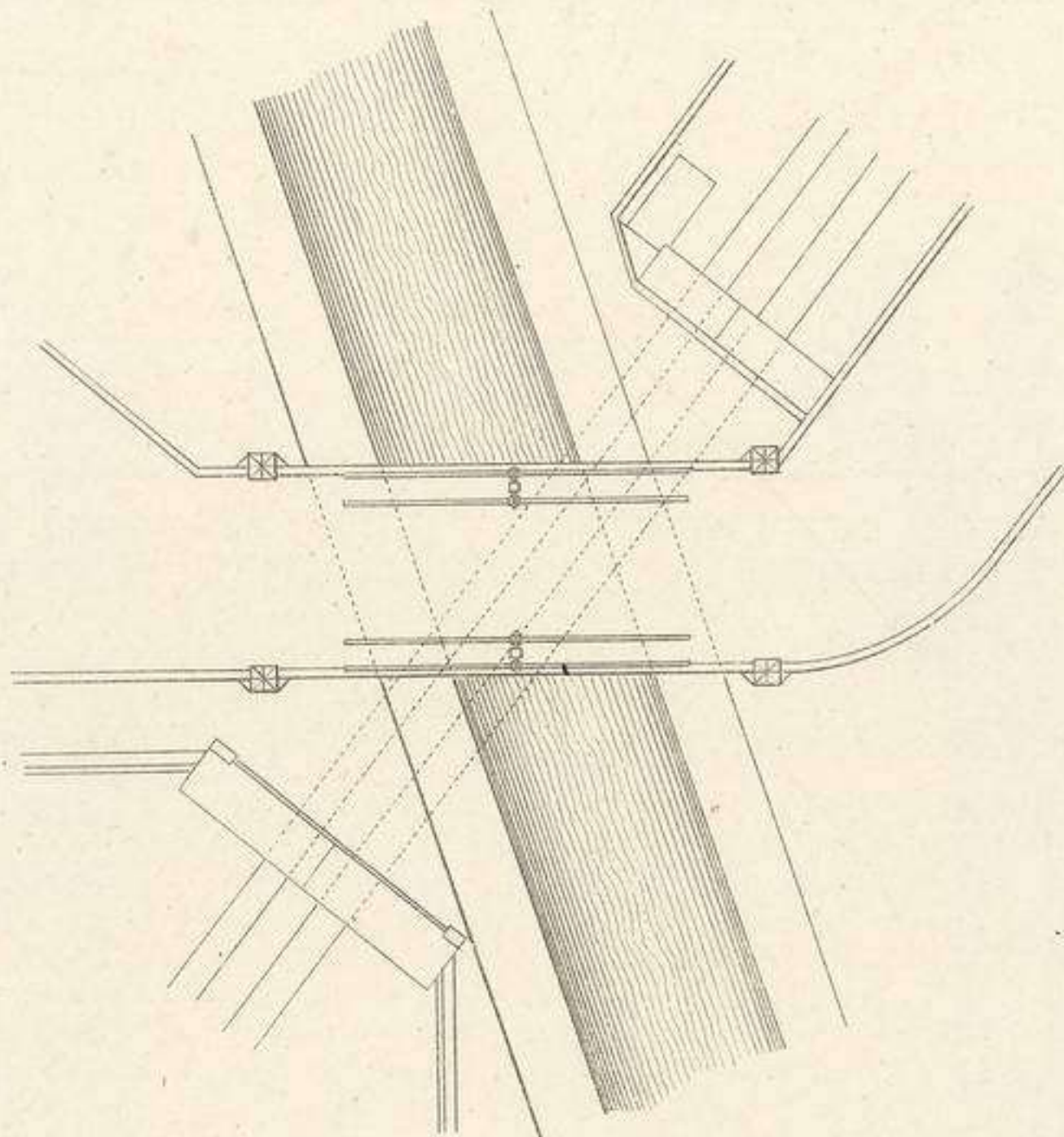
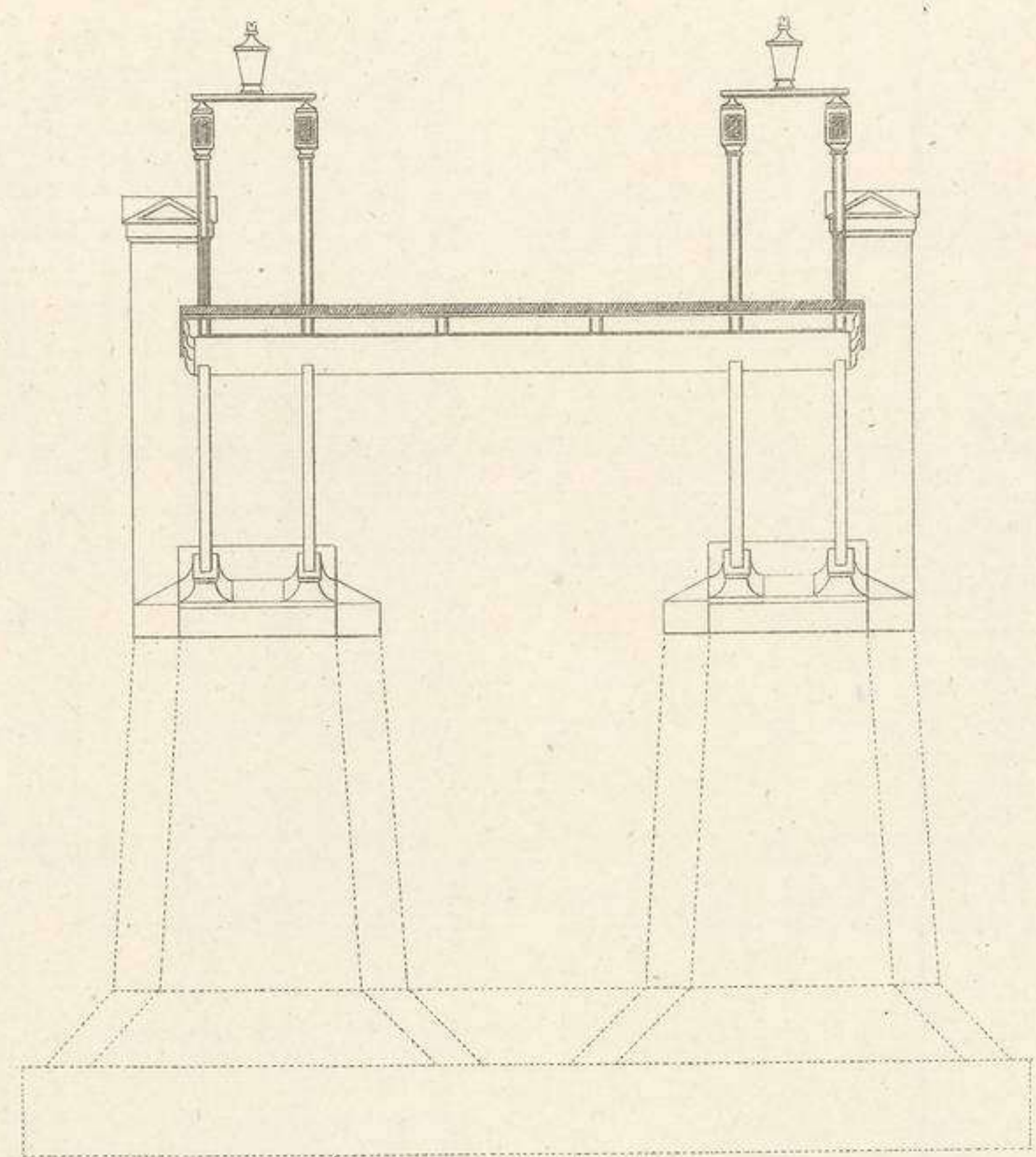

Fig. 2.



Echelle de la Fig. 4.



Echelle des Fig. 1, 2, 3.

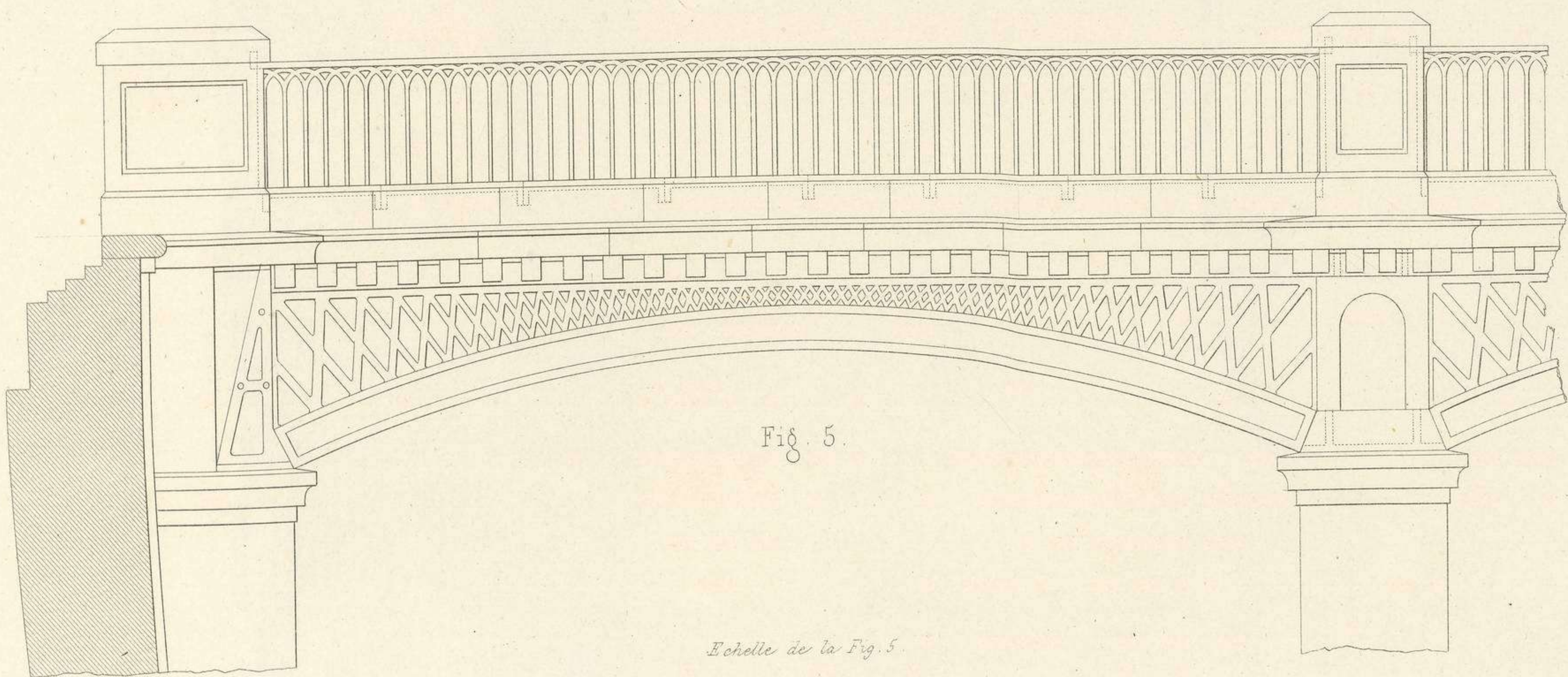

Fig. 5.

Echelle de la Fig. 5.



H. B.

SERRURERIE

Ponts en fonte

B. et V. del.



Fig. 1

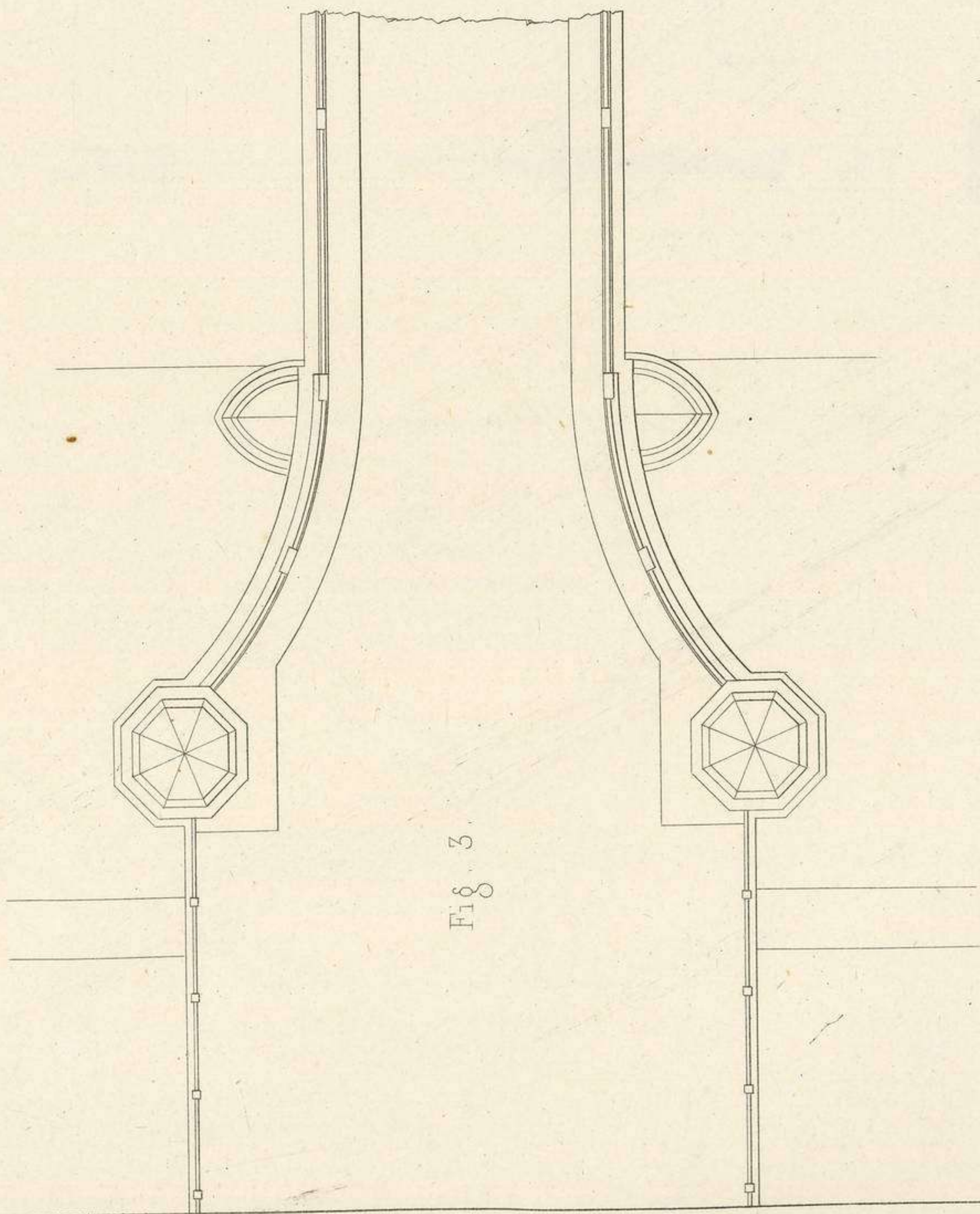
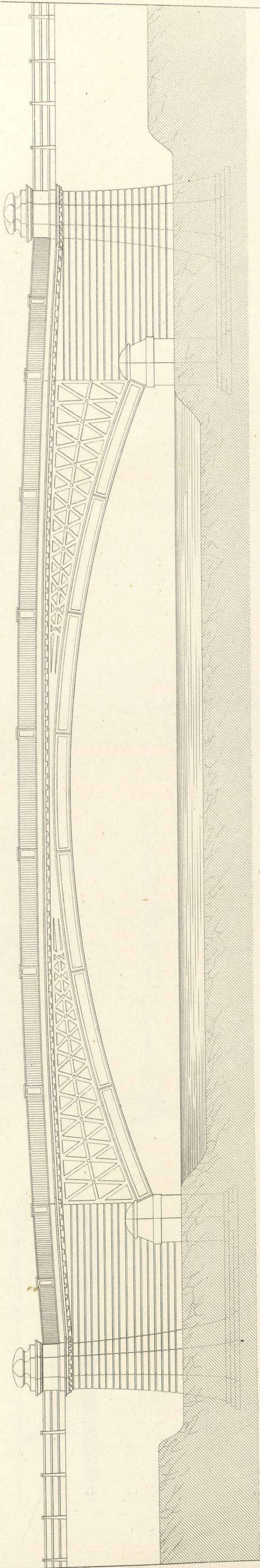

Fig. 3

Fig. 2

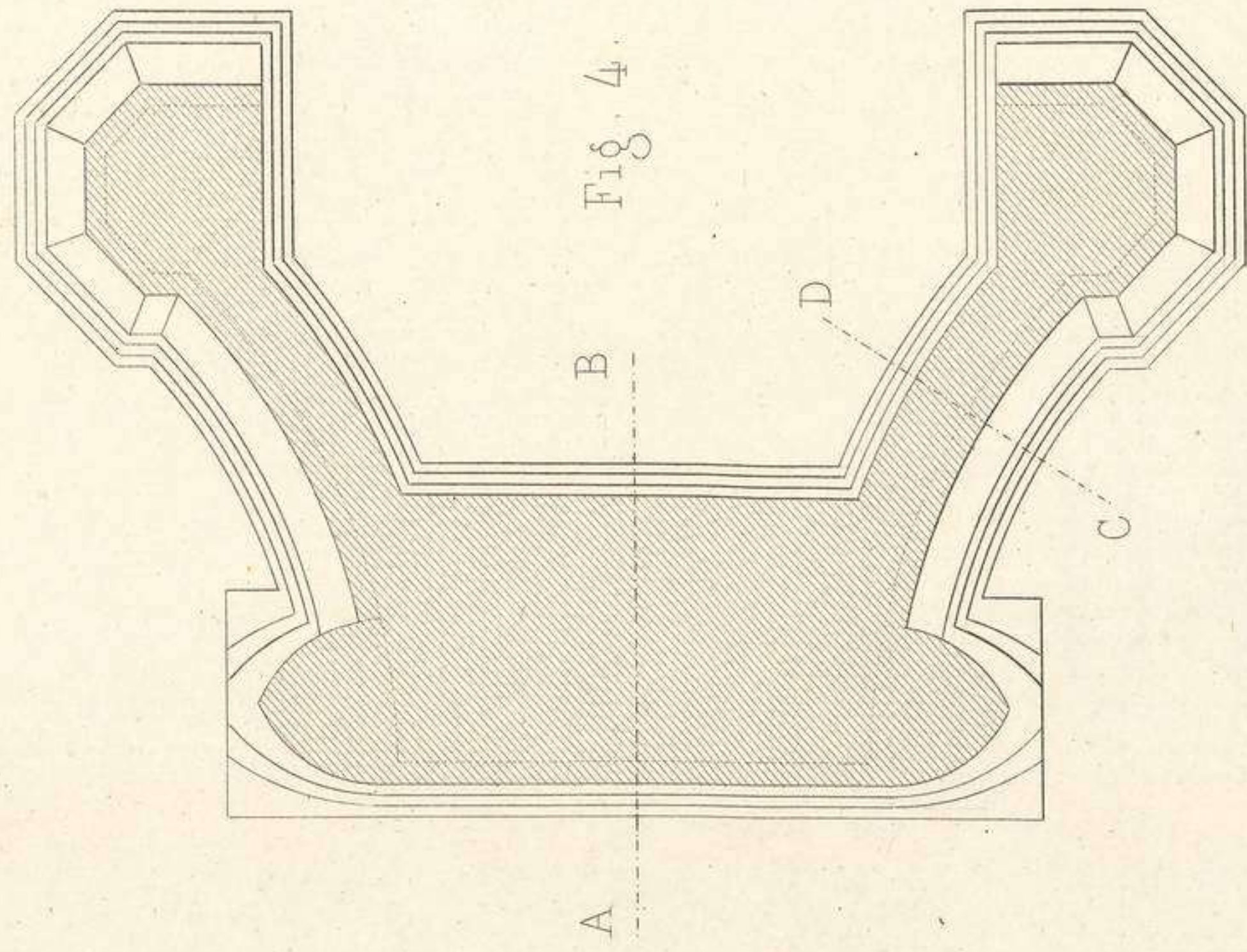
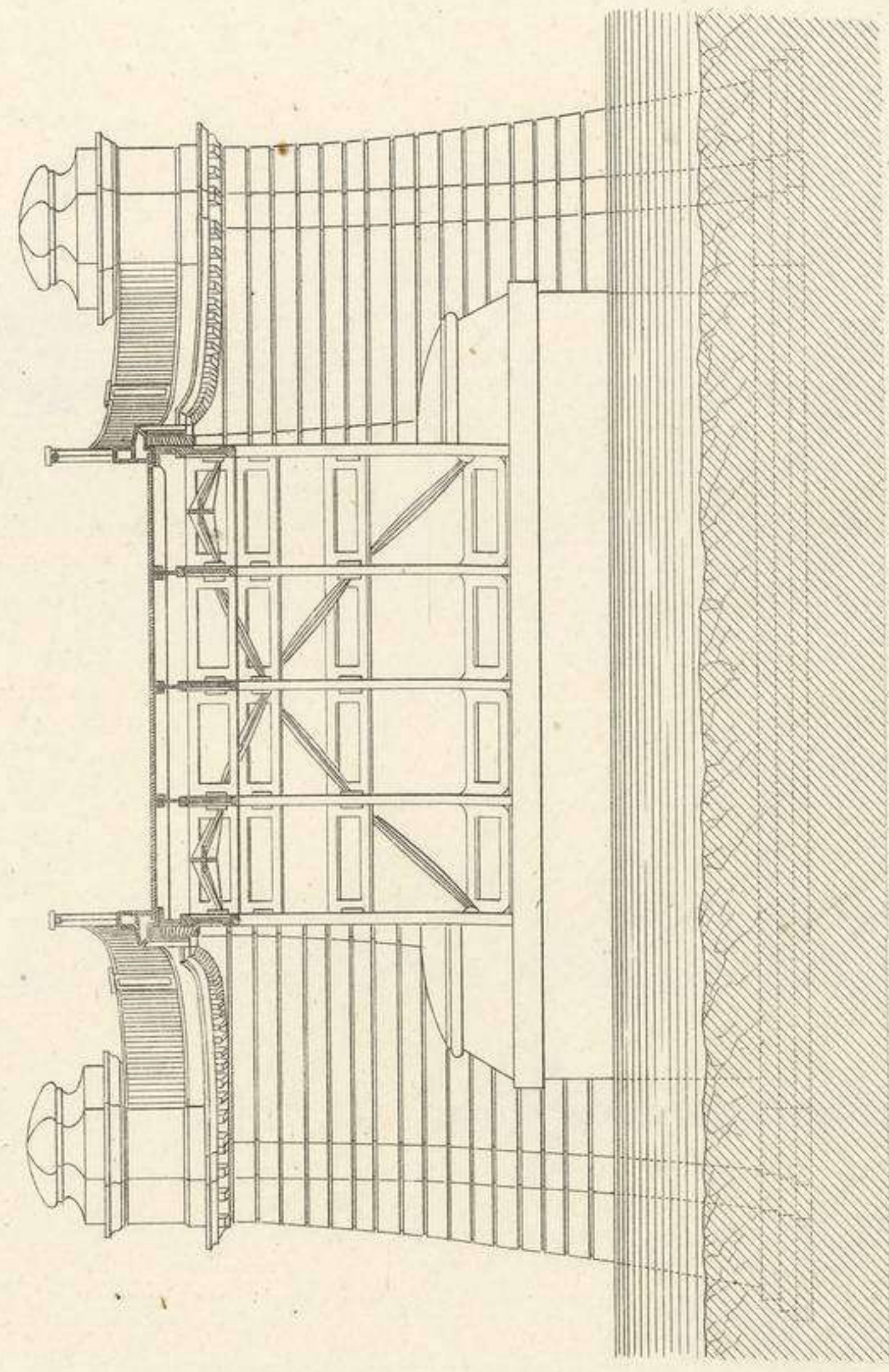

Fig. 4

Fig. 6

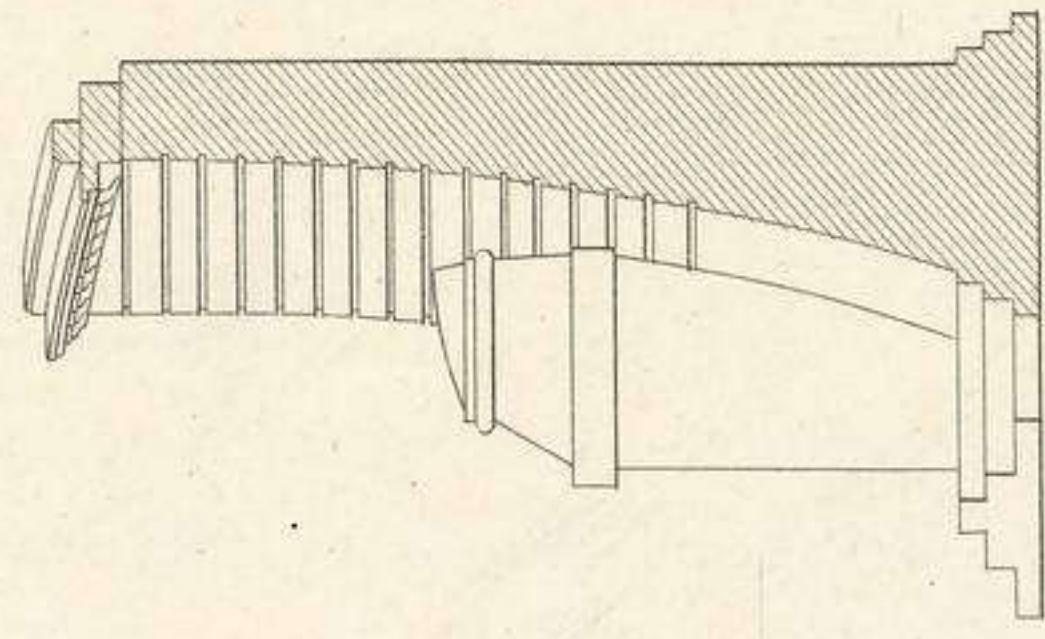
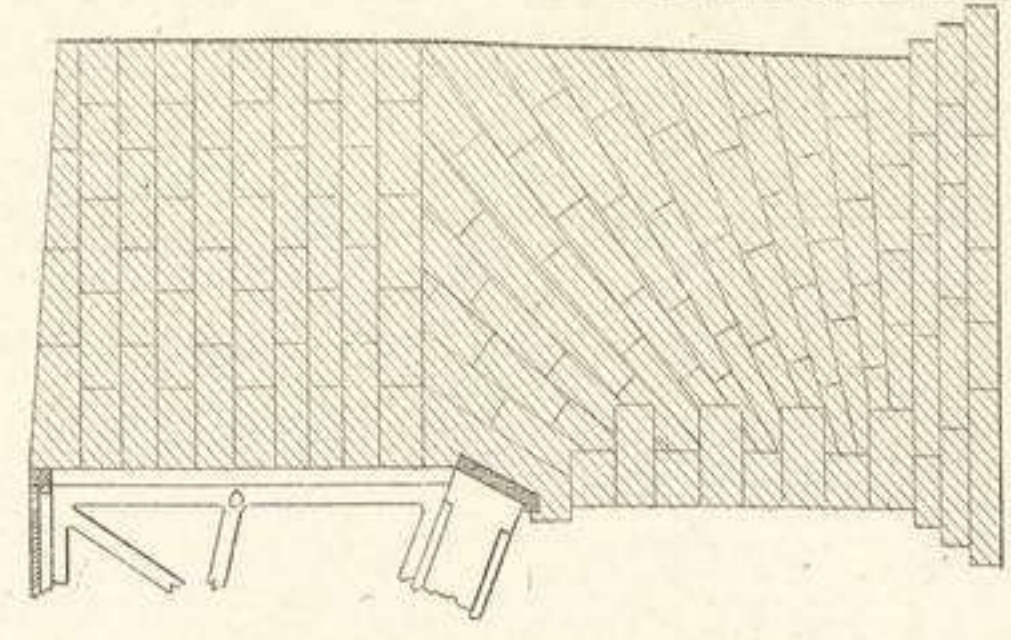

Fig. 5



SERRURERIE.  
Ponts en fonte.

B. de V. del.

H. R.



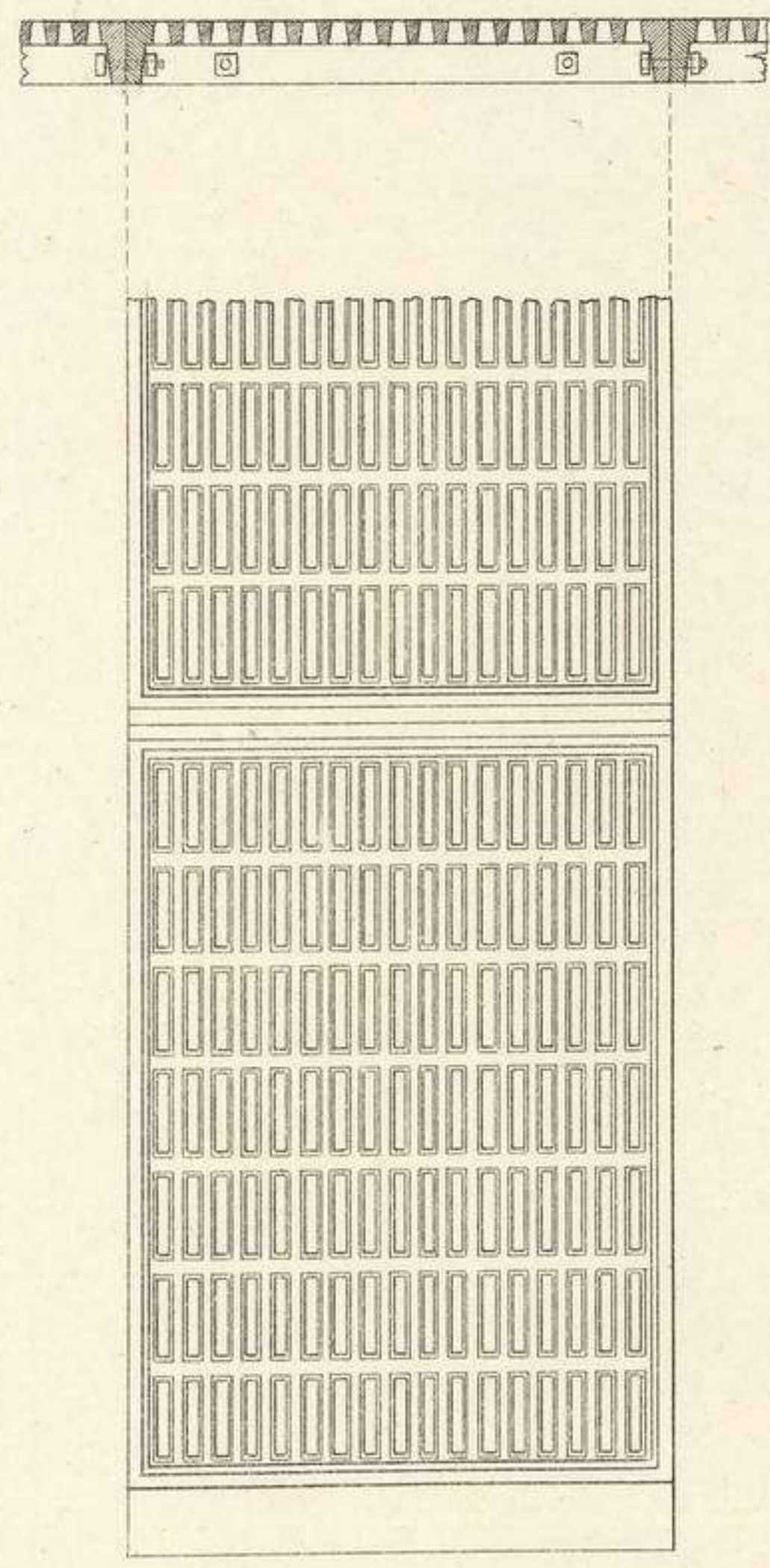
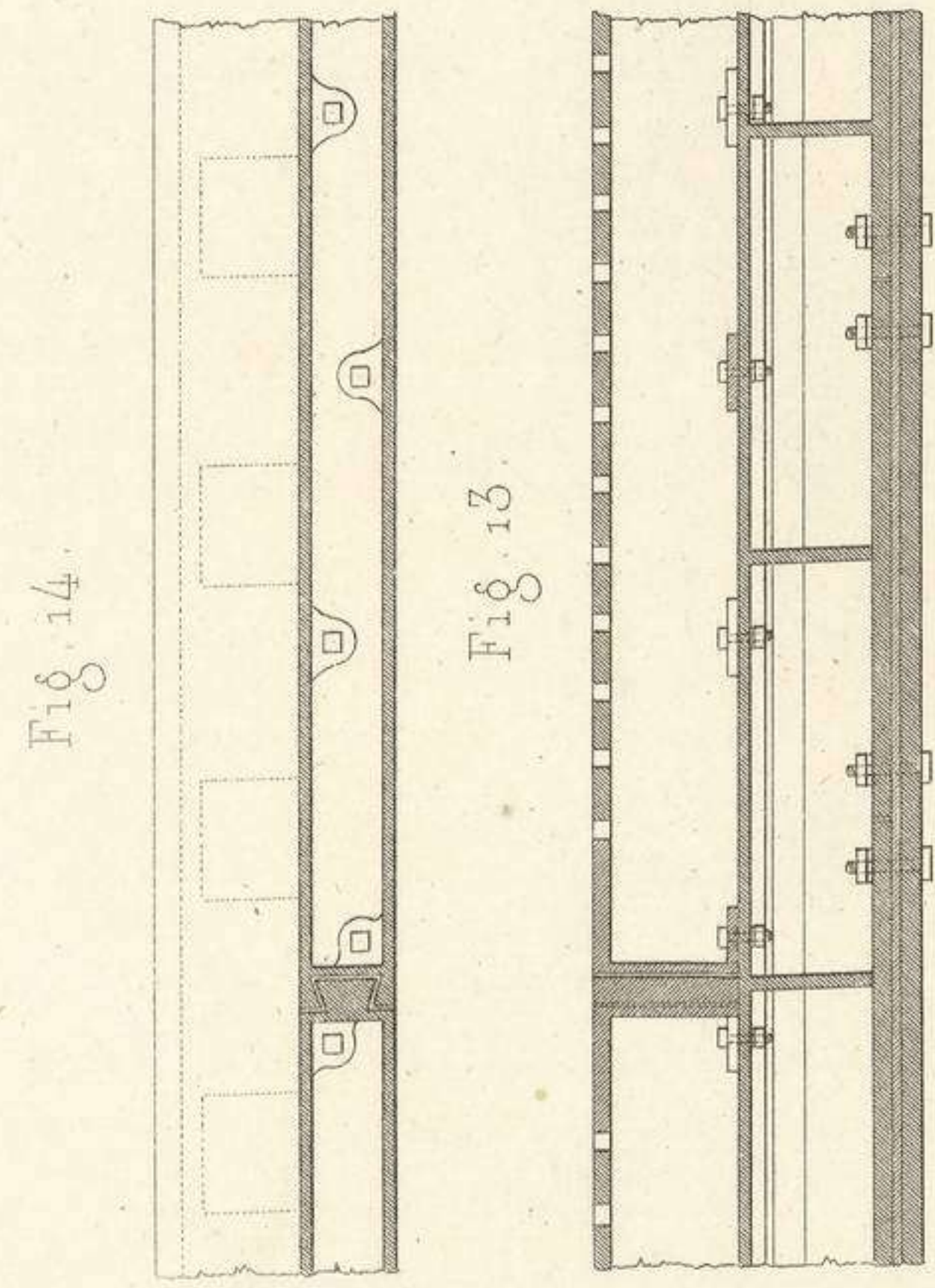
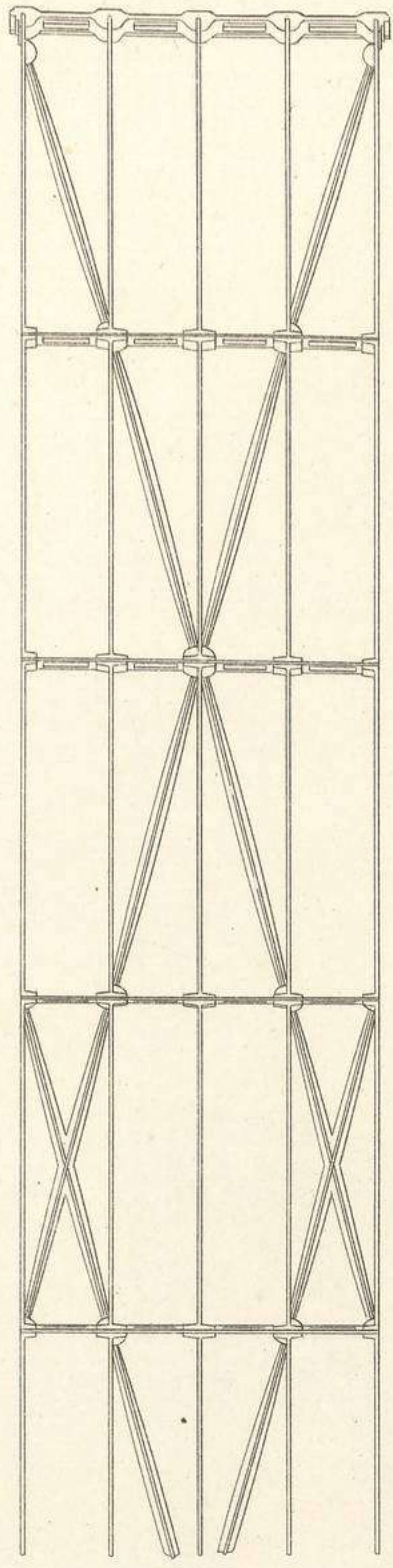

Fig. 1.



Echelle de la Fig. 1.

5 Mètres

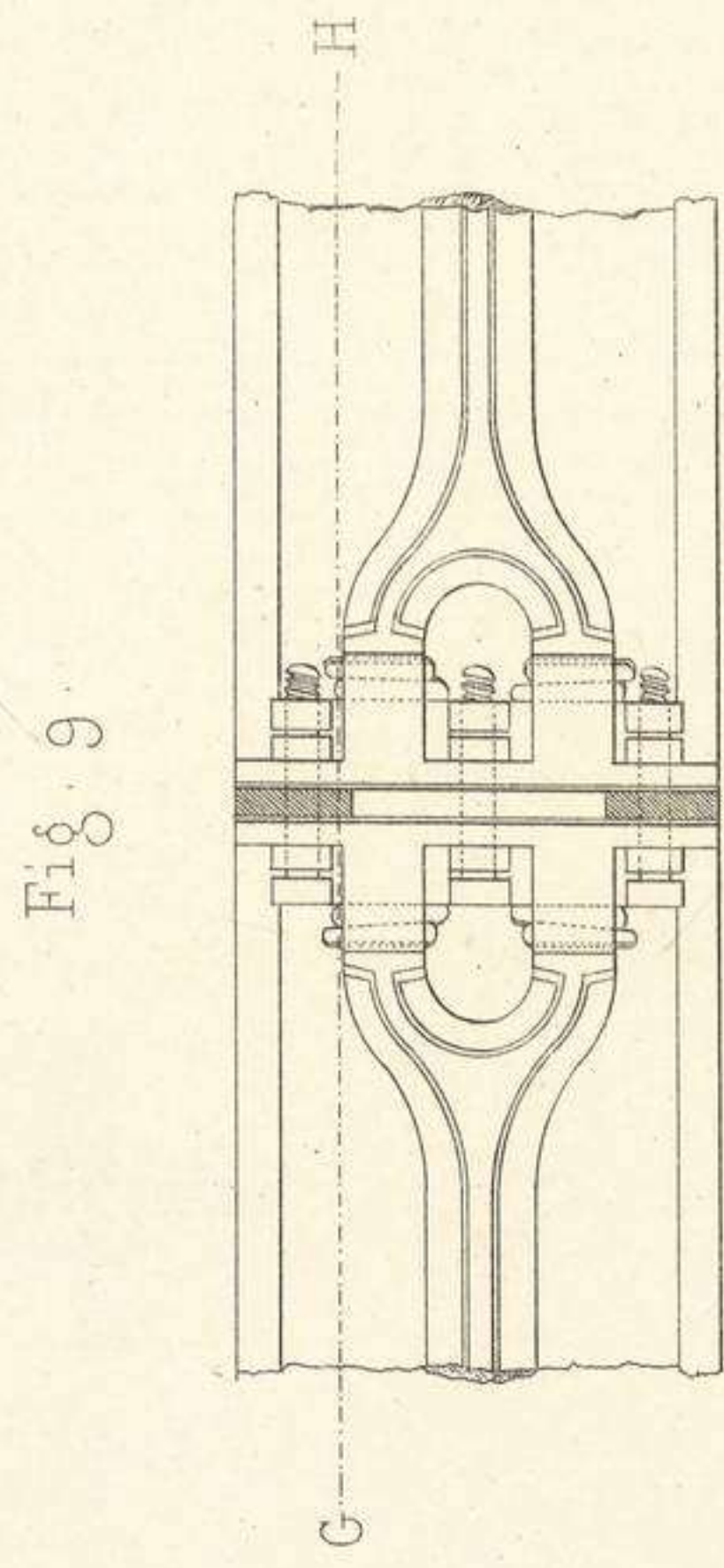
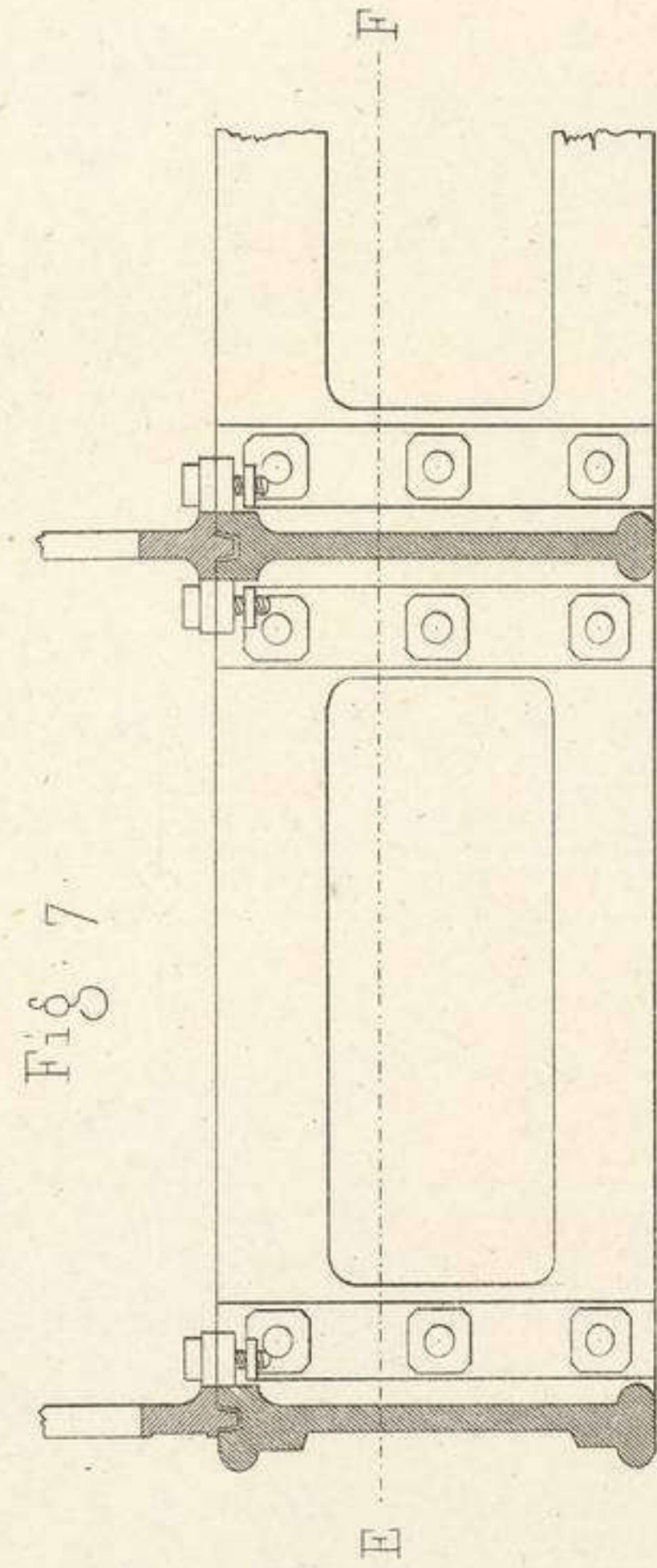
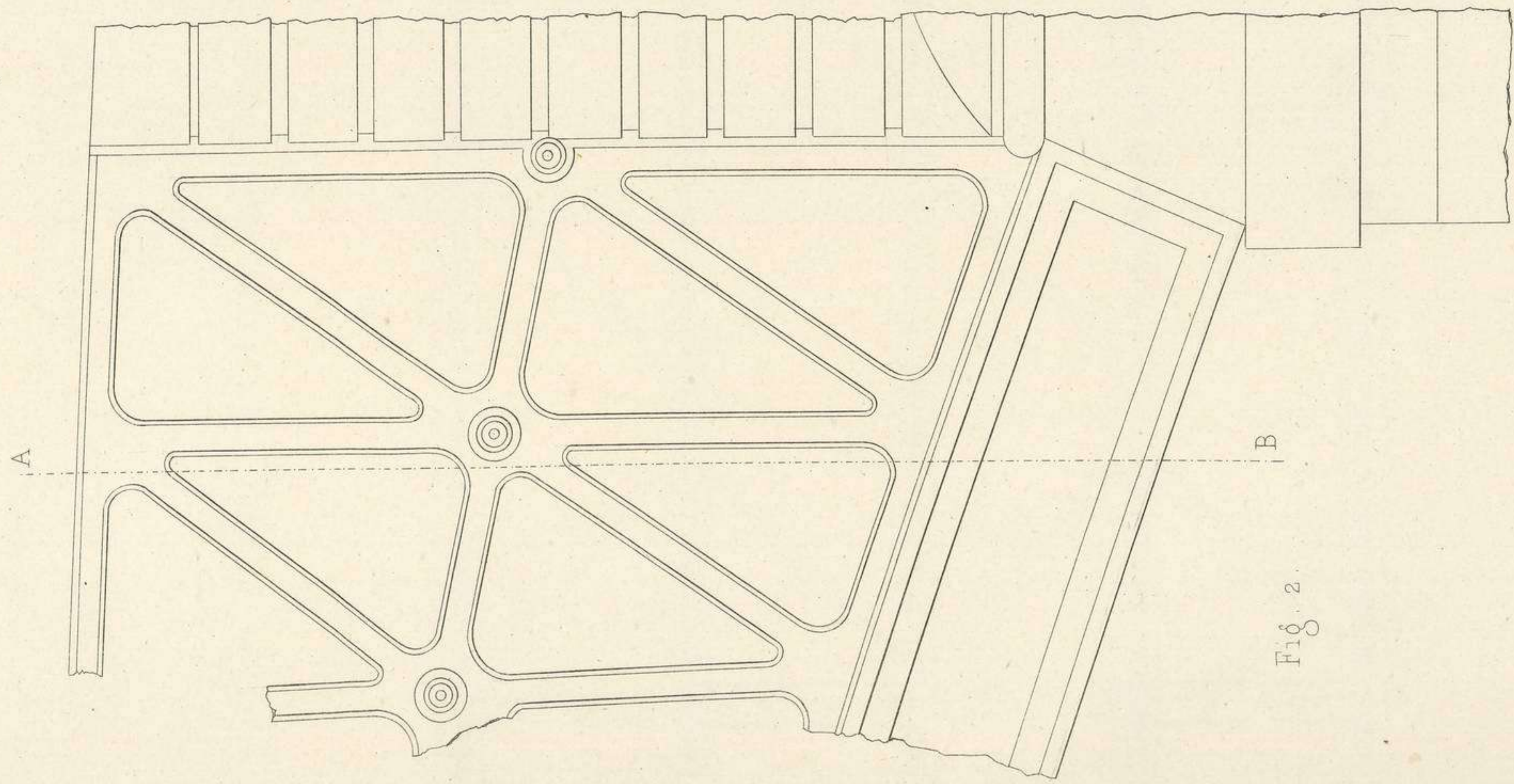

Fig. 10.

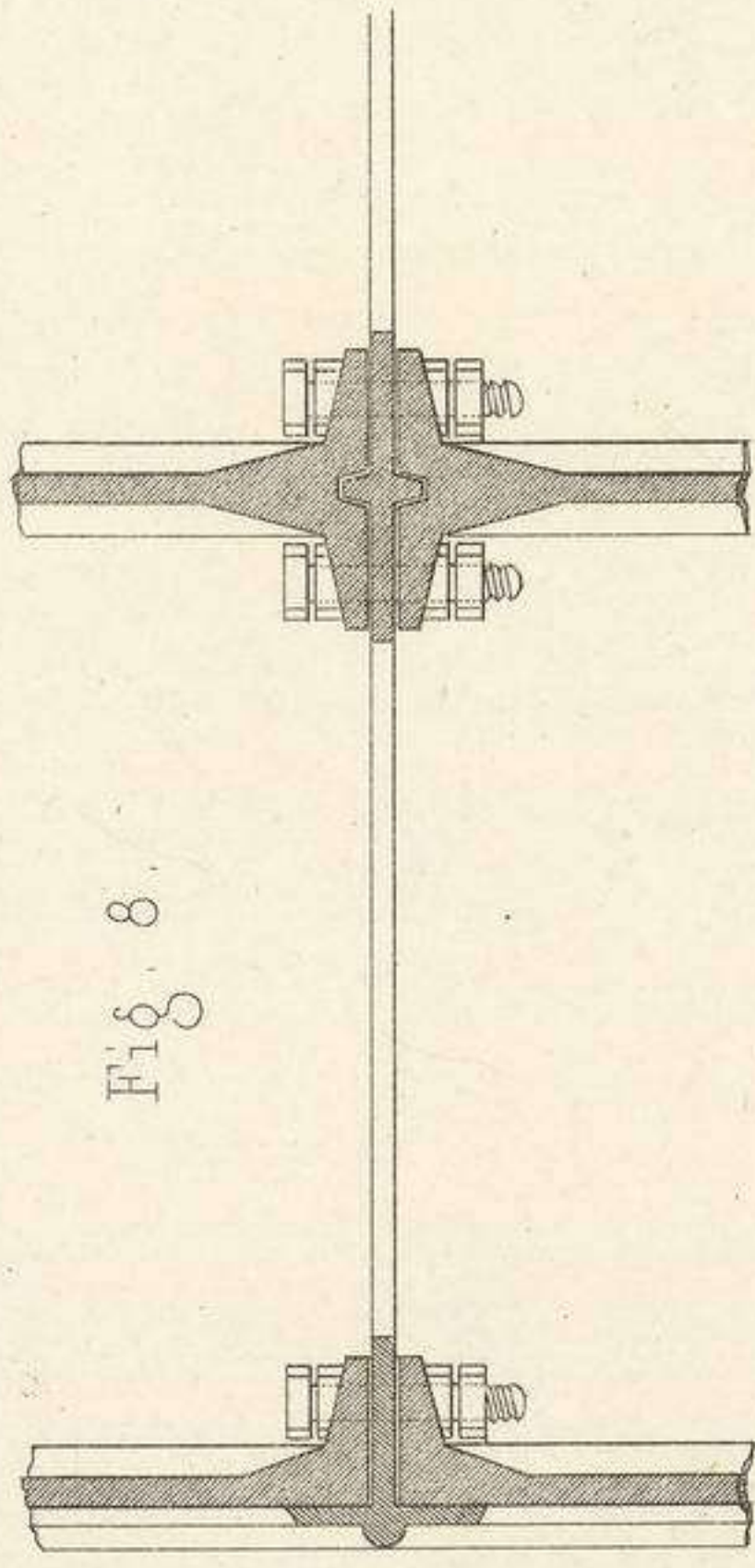

Fig. 8.

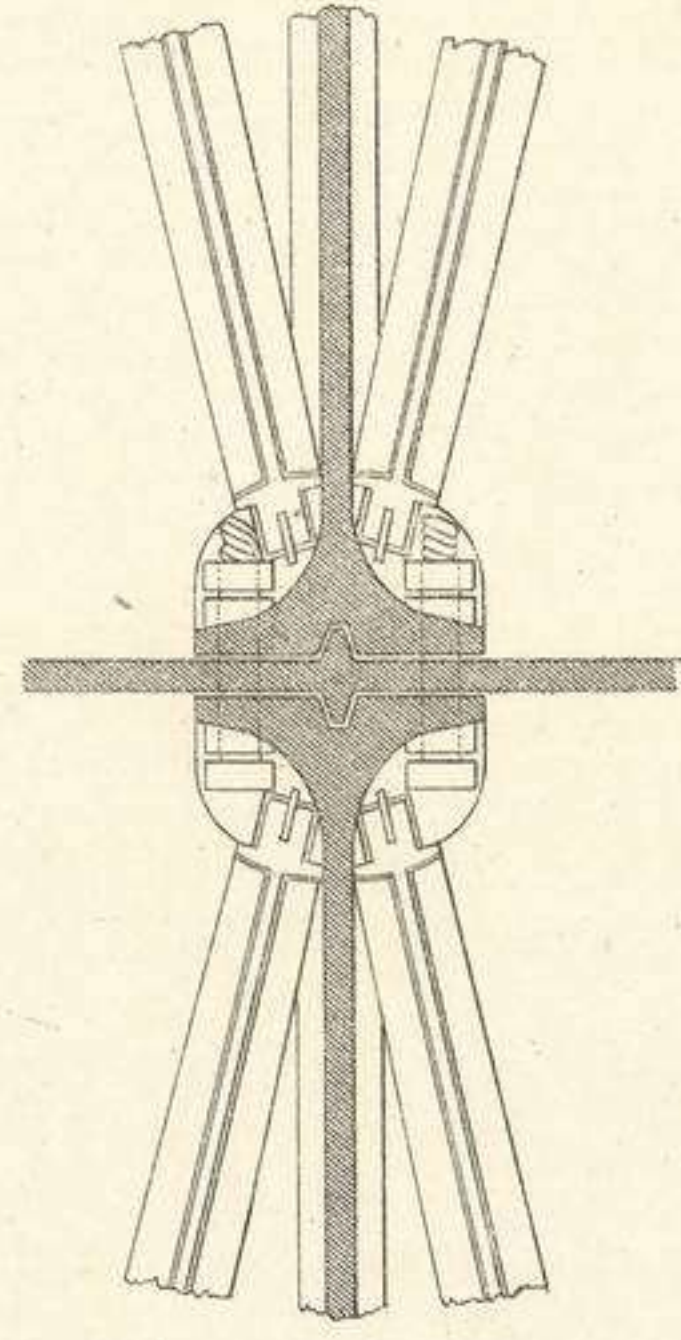

Fig. 5.

Fig. 11.

Fig. 12.

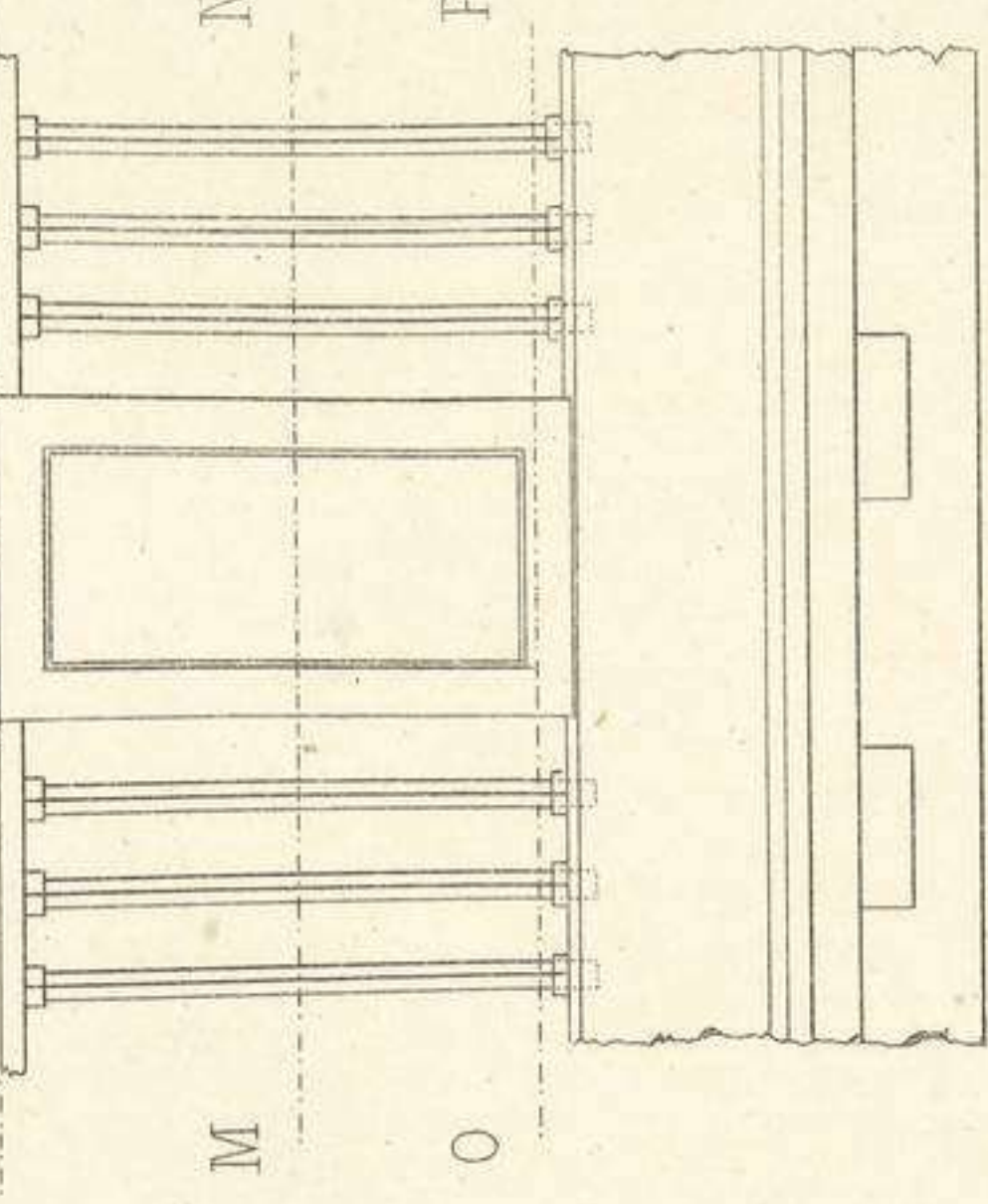
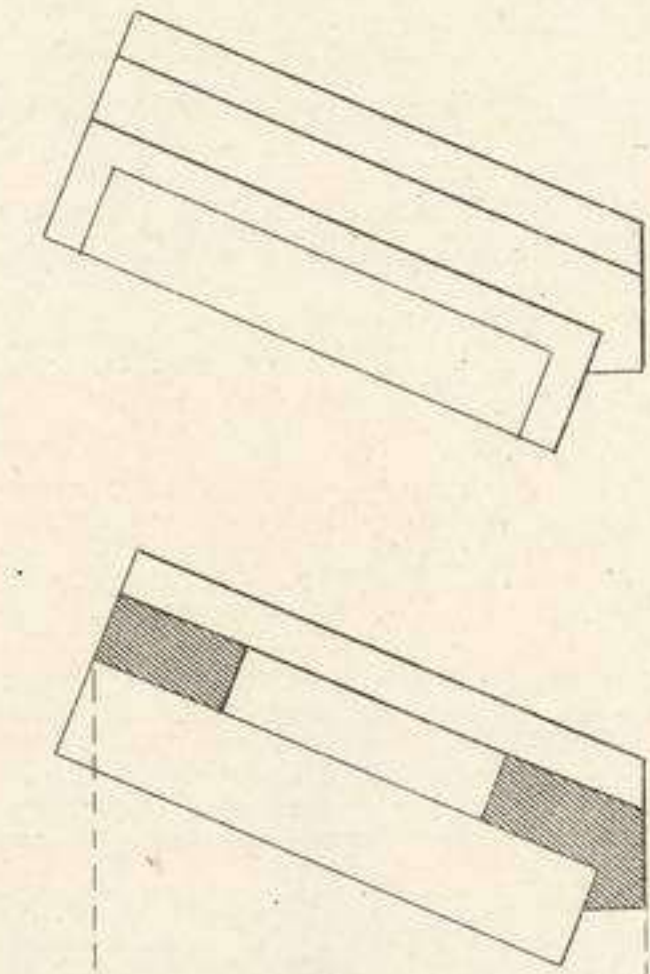
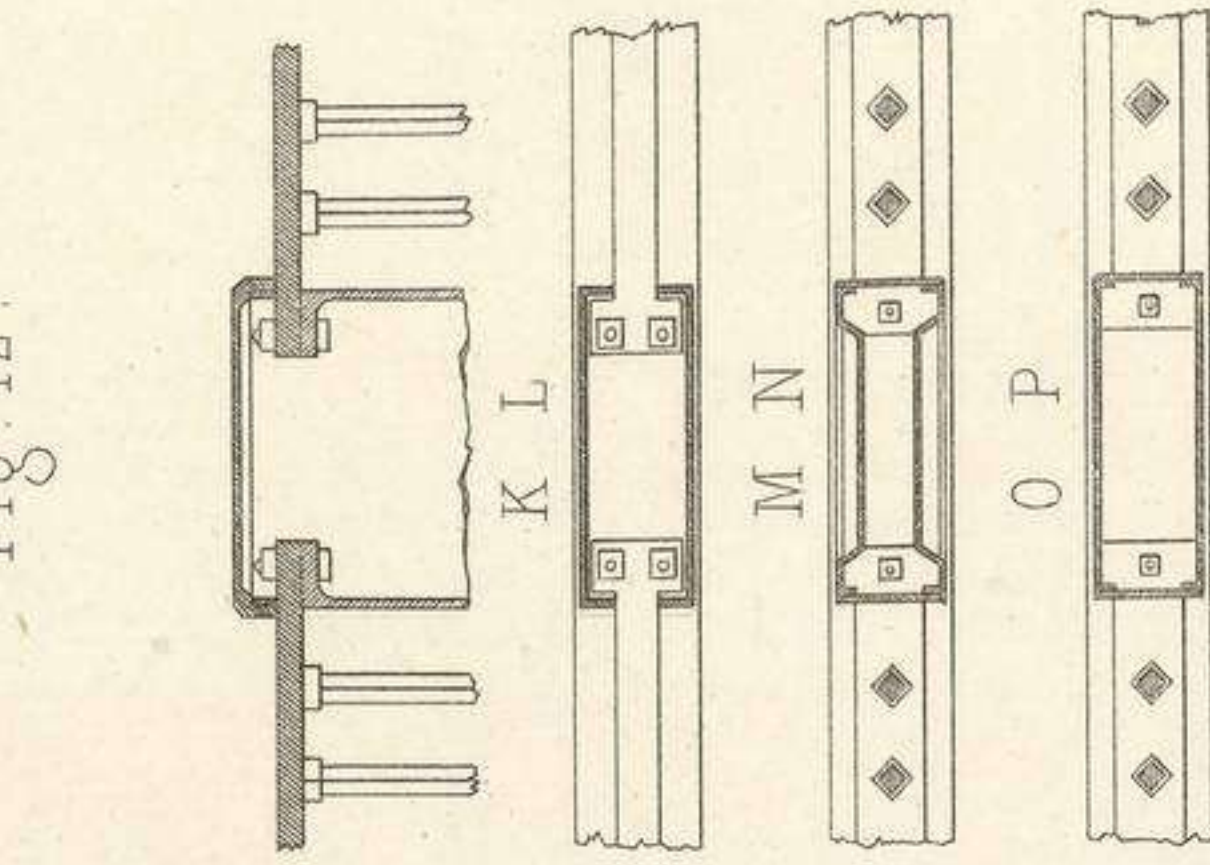
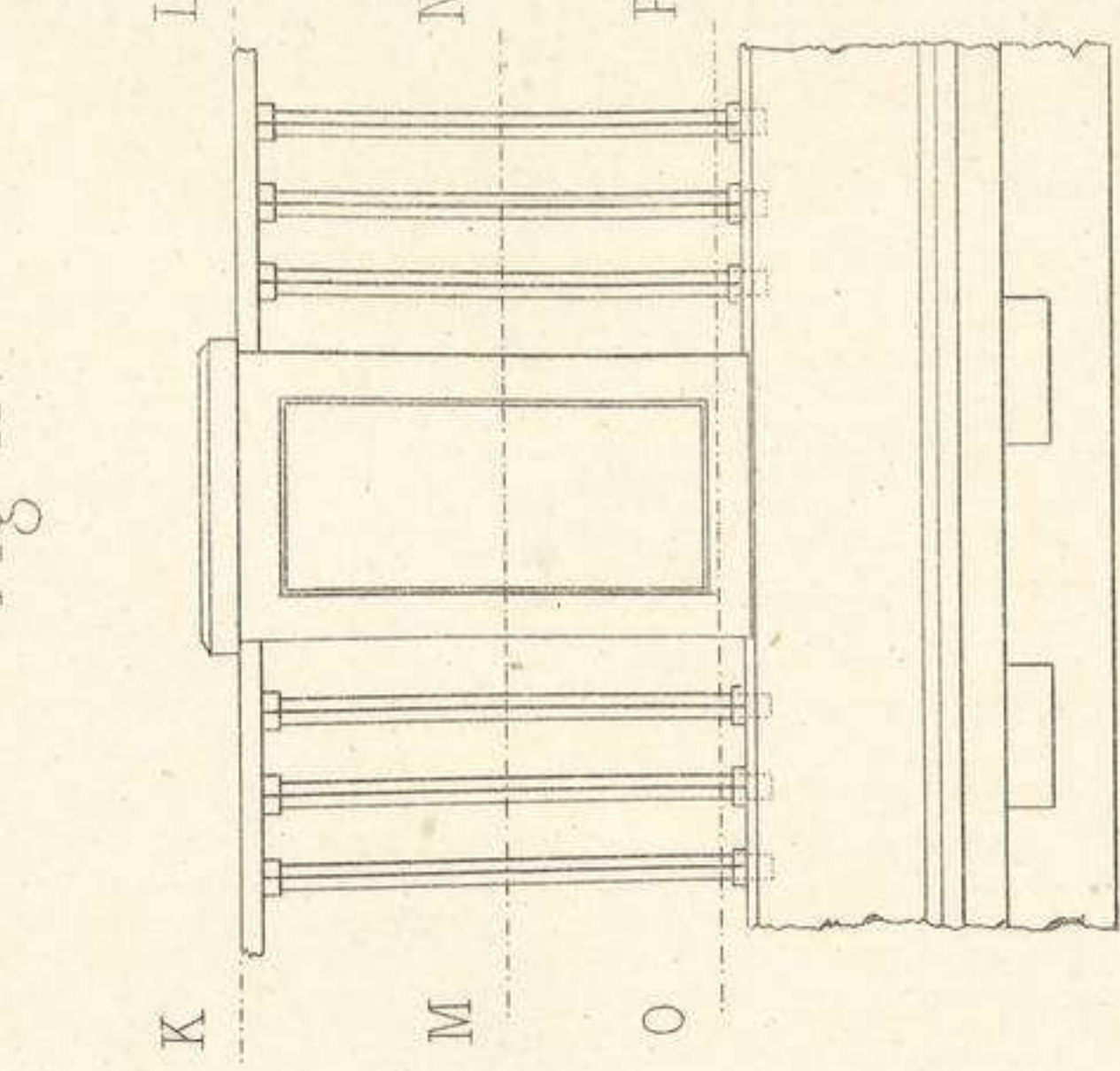
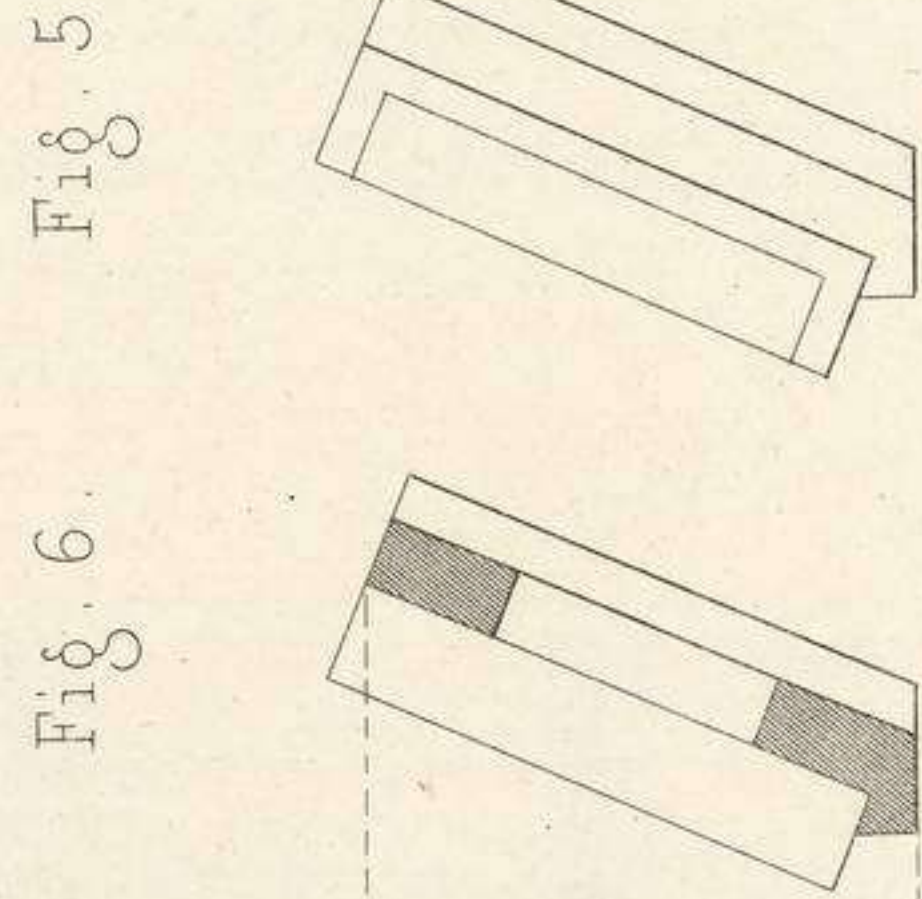
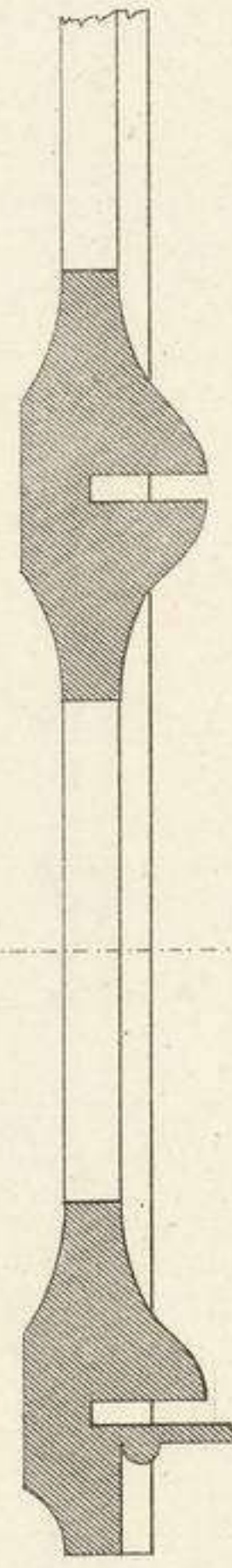

Fig. 2.

Fig. 4.



5 Mètres

Echelle de la Fig. 1.

5 Mètres

Echelle de la Fig. 1.

5 Mètres

Echelle de la Fig. 1.

H. R.

B. et P. del.

SERRURERIE.  
Ponts en fonte.



Fig. 1. (226.)

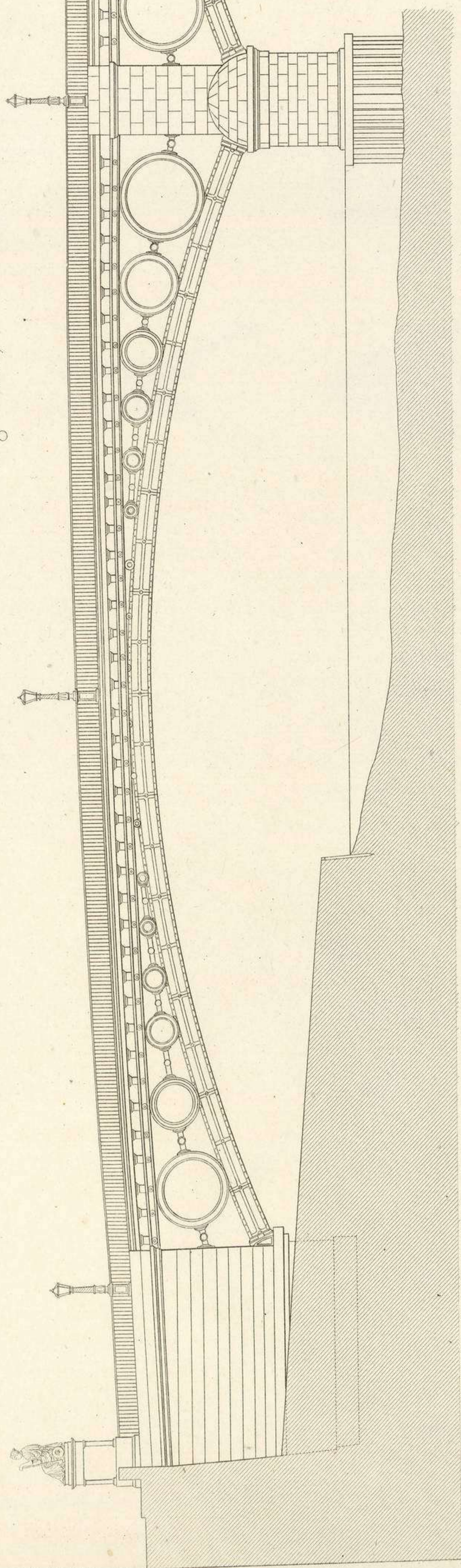
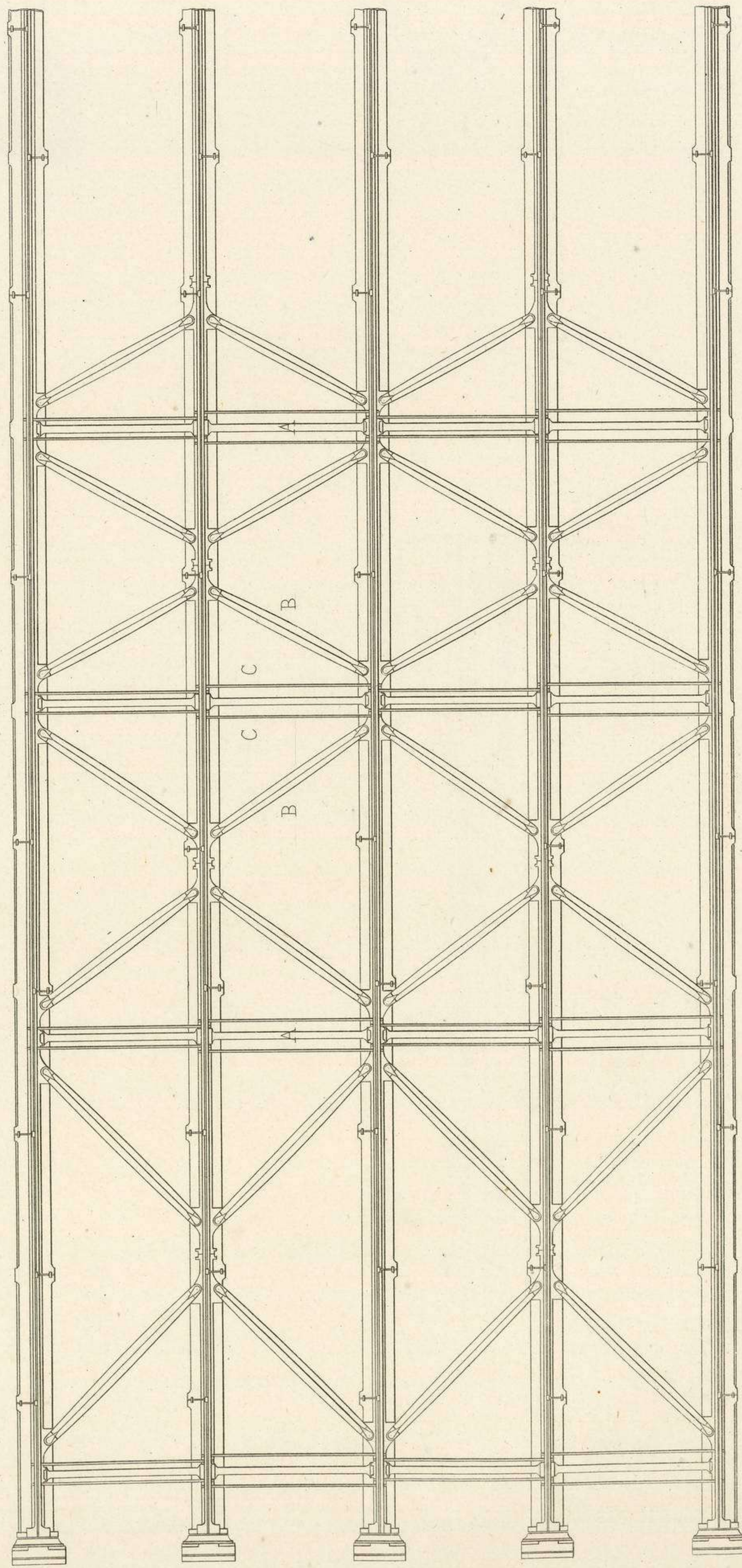

Fig. 2. (226.)



B. et V. del.

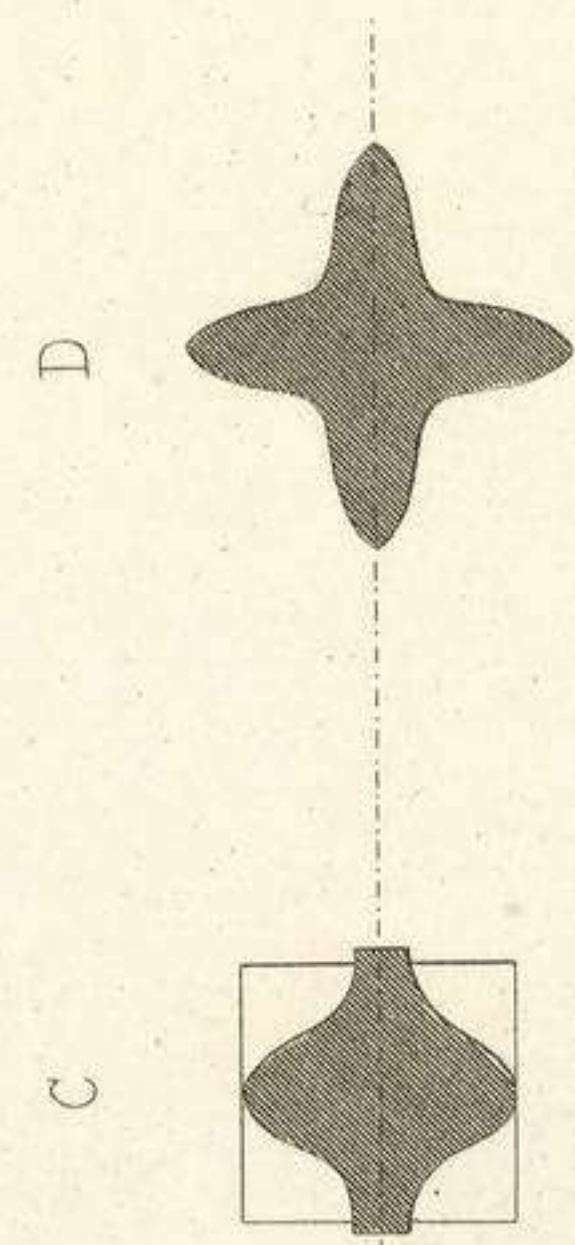

Fig. 4. (229.)

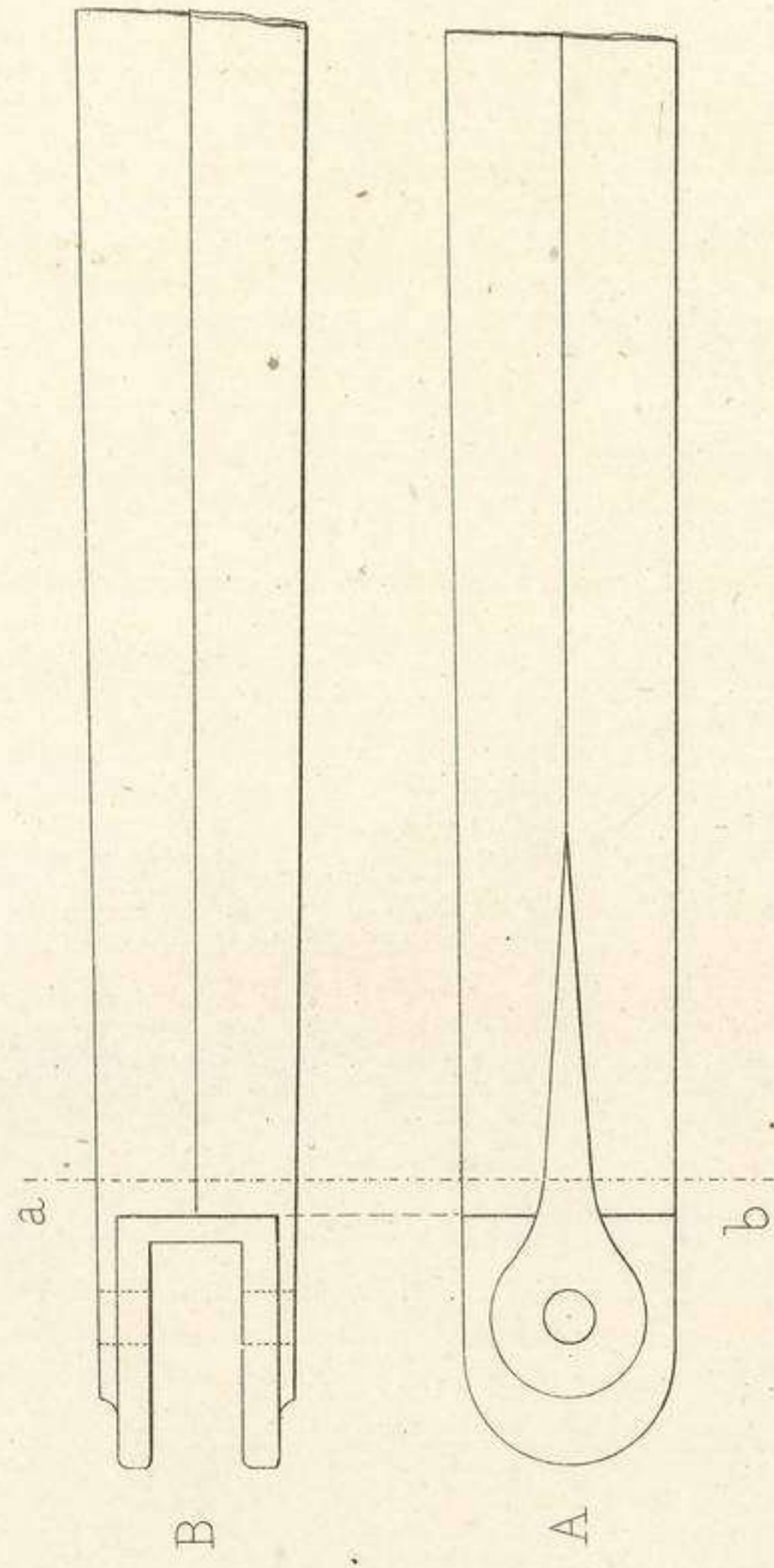
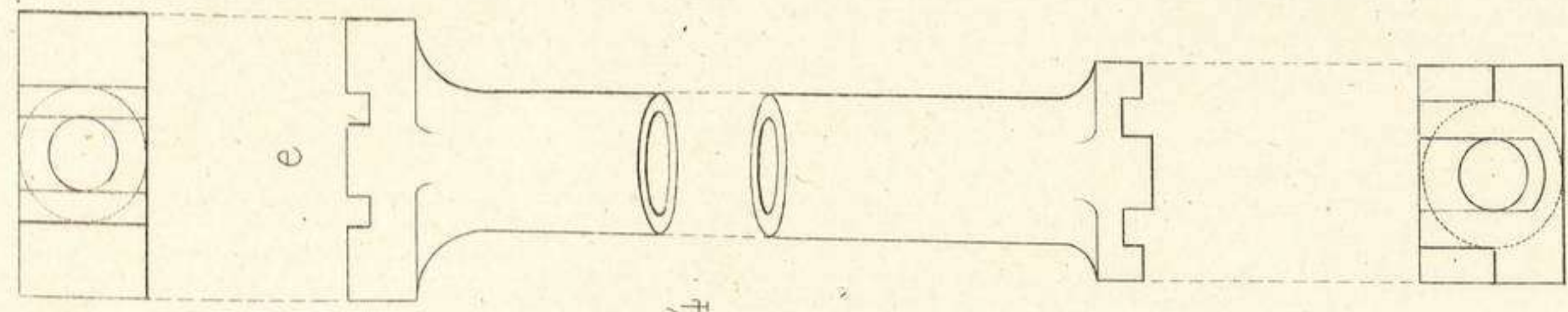
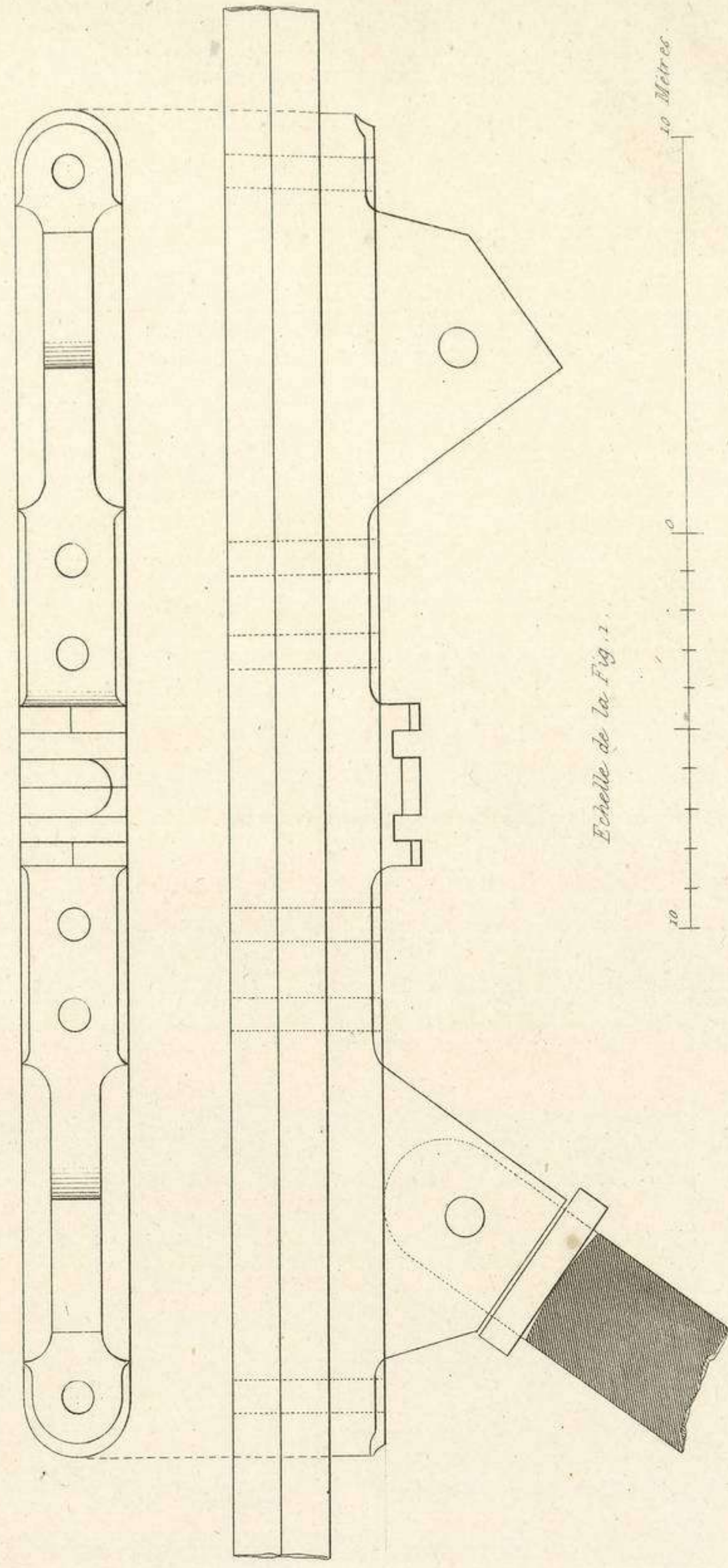

Fig. 3. (229.)



Echelle de la Fig. 1.



Echelle de la Fig. 2. 10 Mètres

SERRURERIE  
Ponts en fonte

H. B.



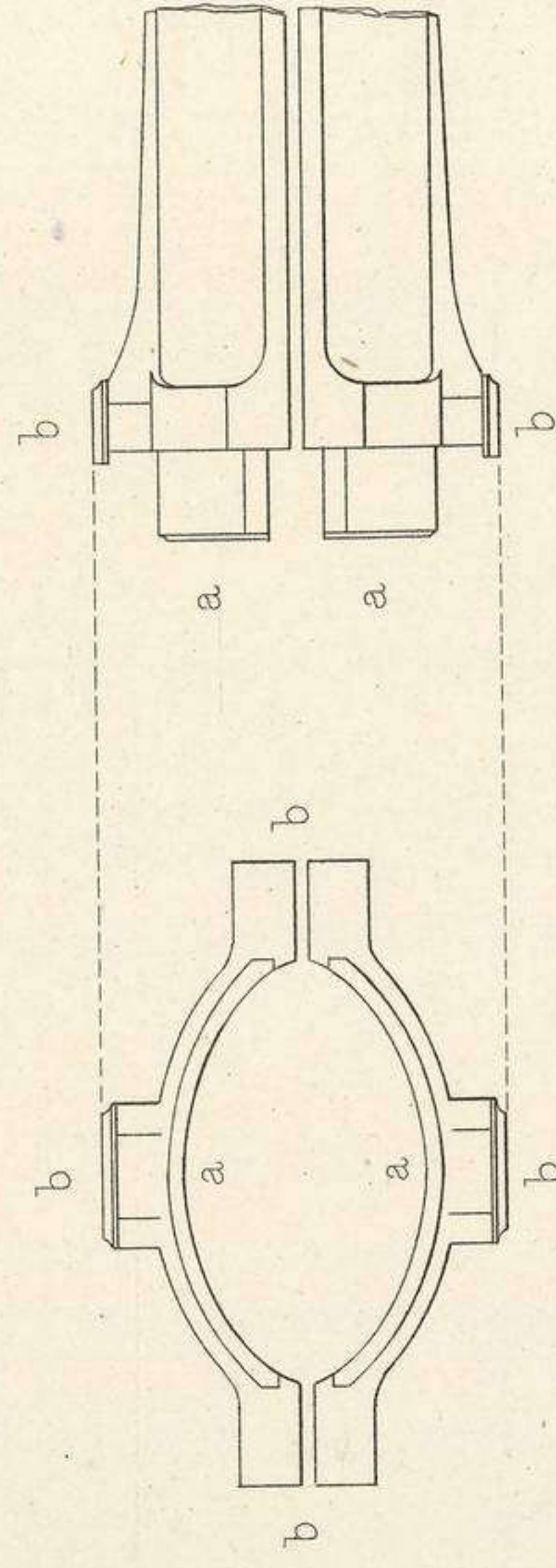
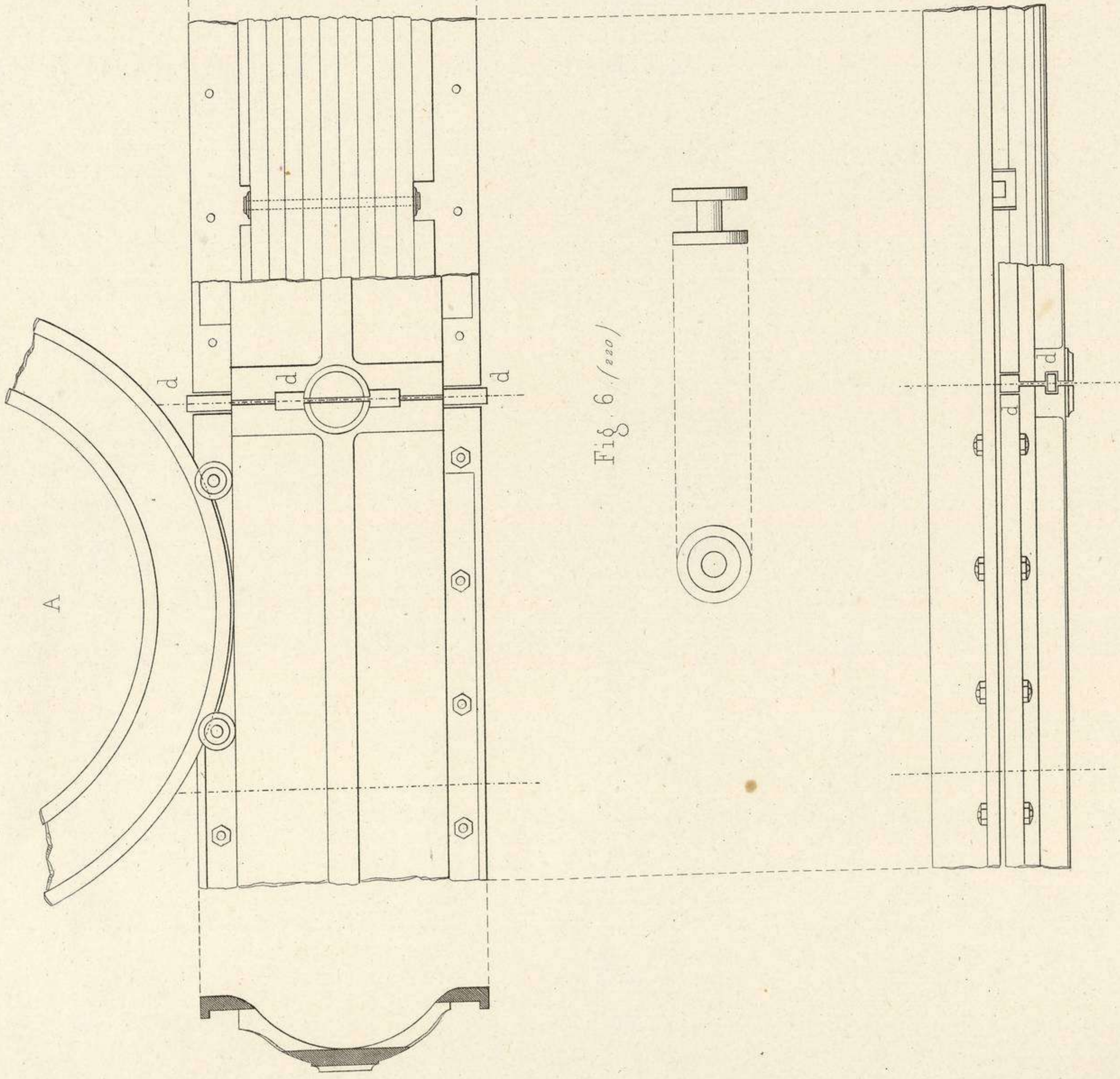
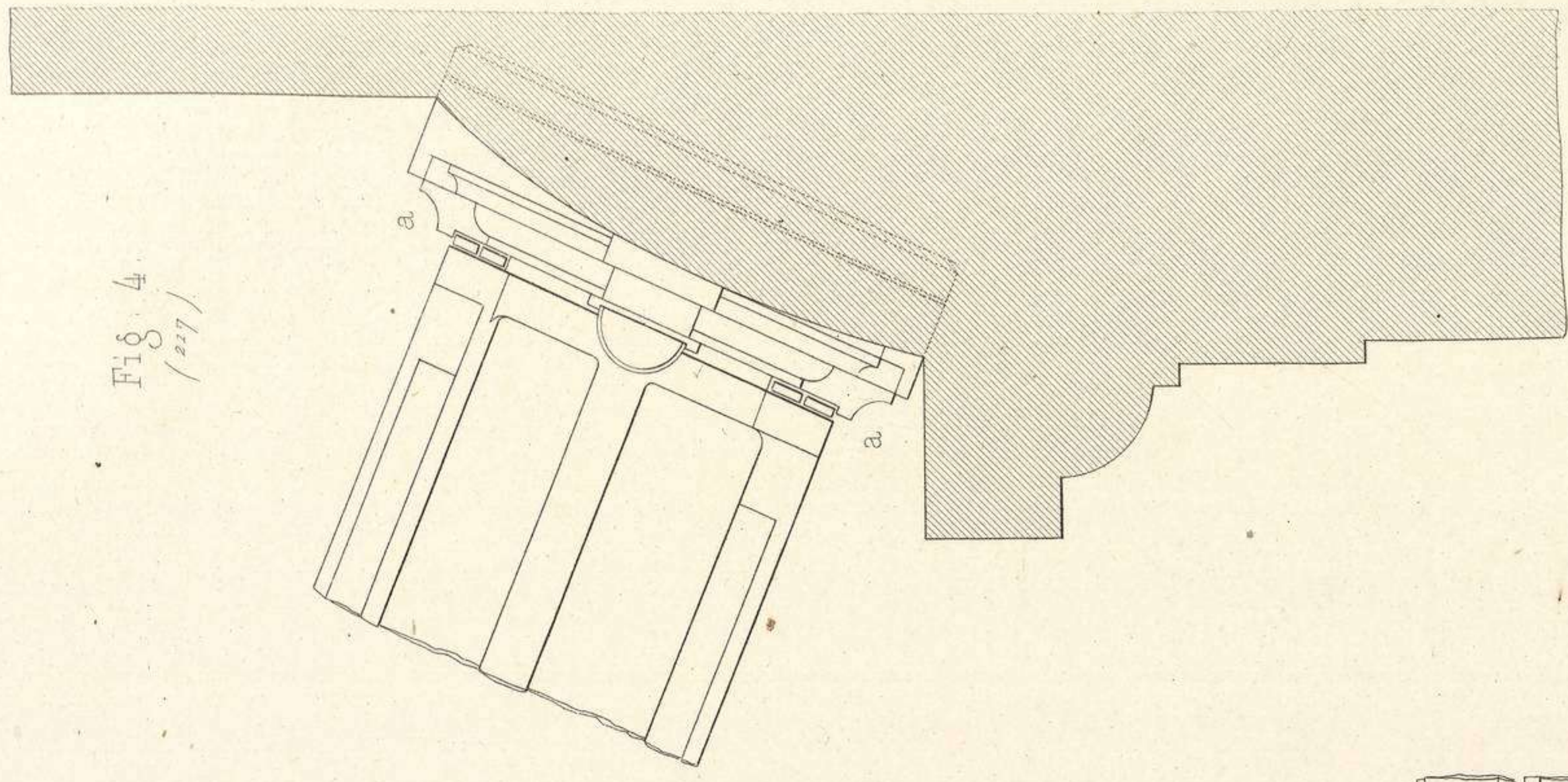
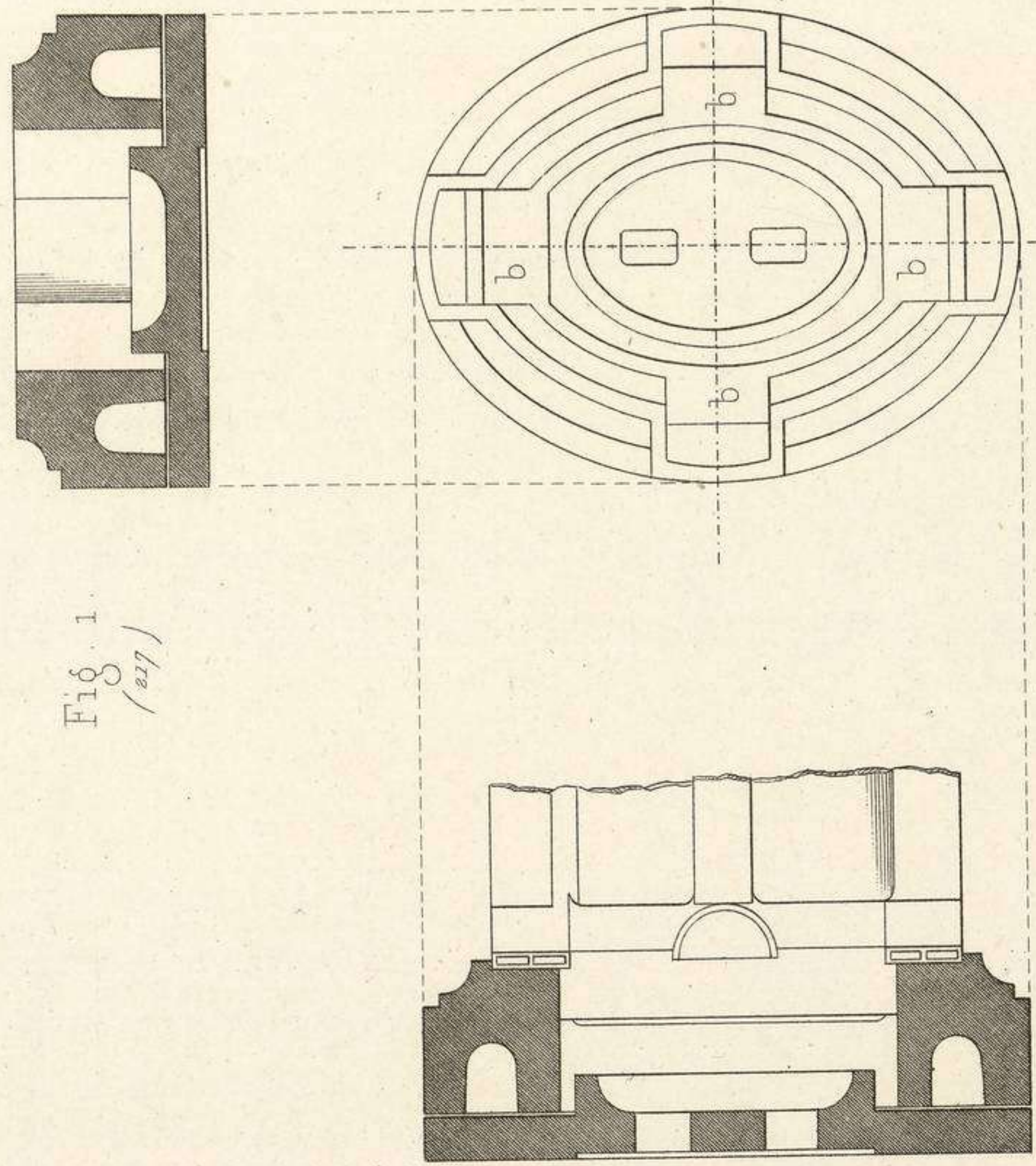
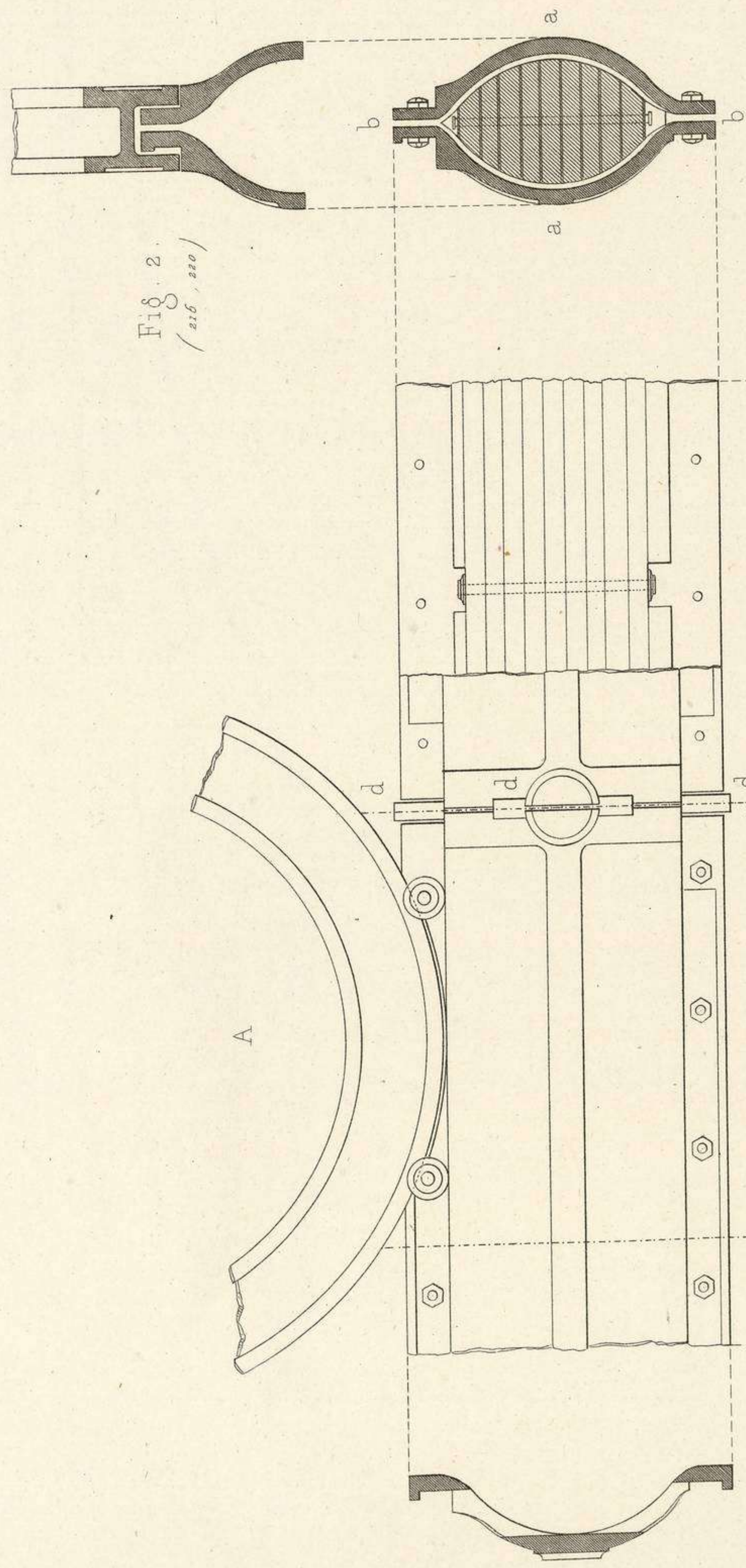

SERRURERIE.  
Ponts en fonte.



Fig. 1.

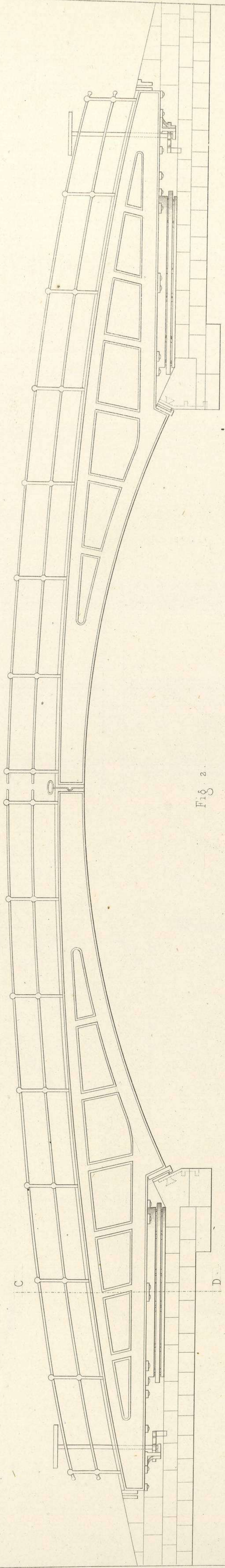

Fig. 2.

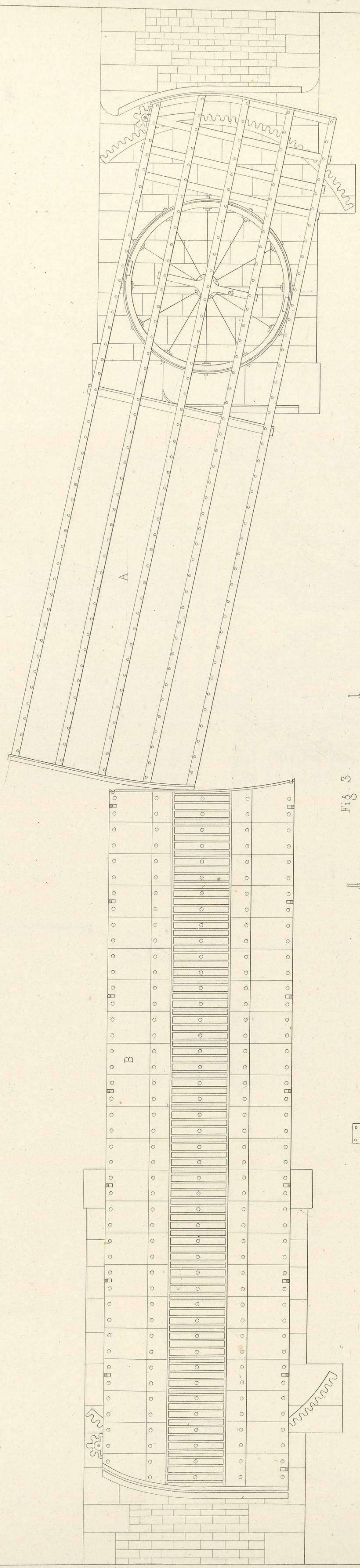

Fig. 3.

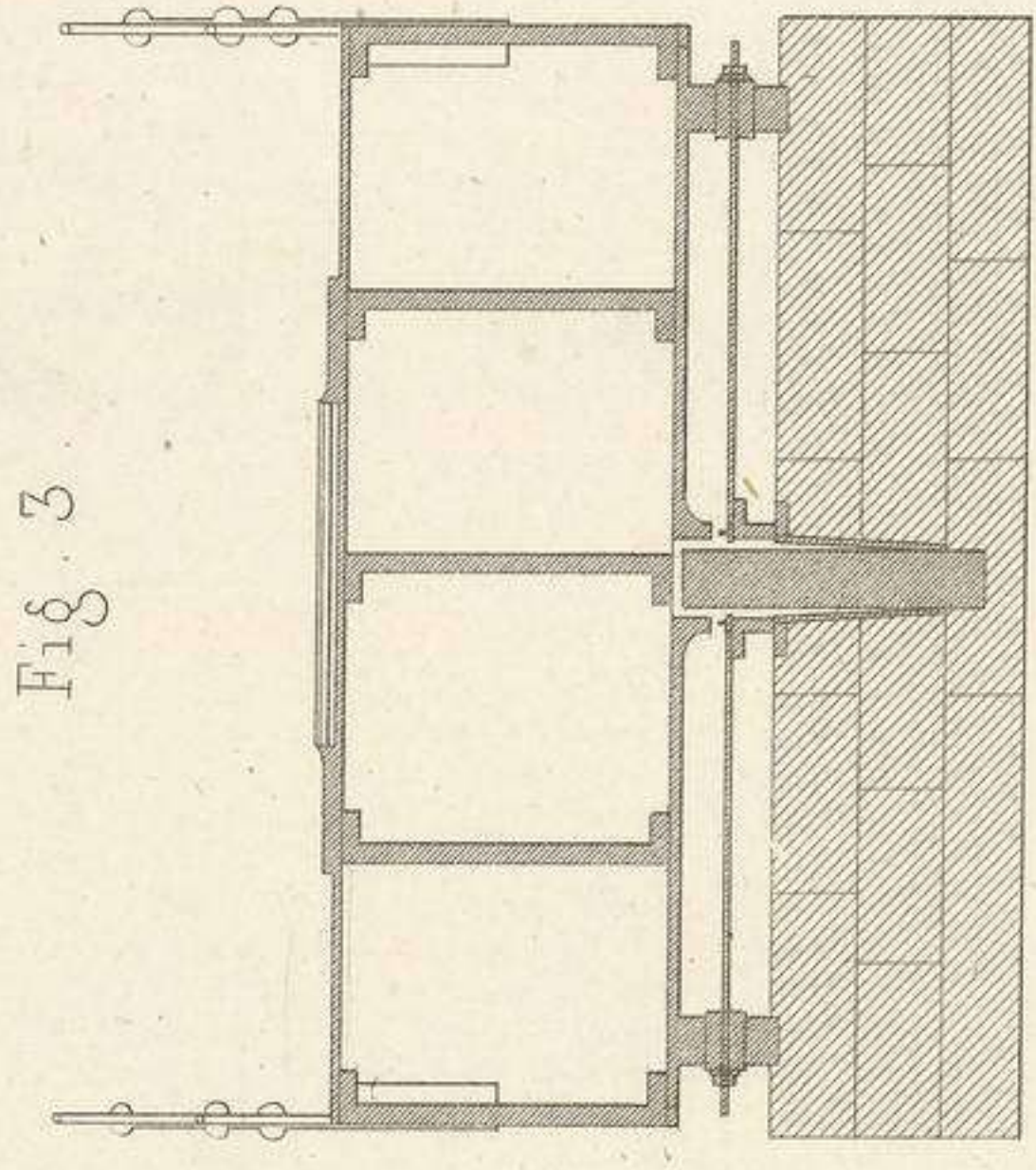

Fig. 5.

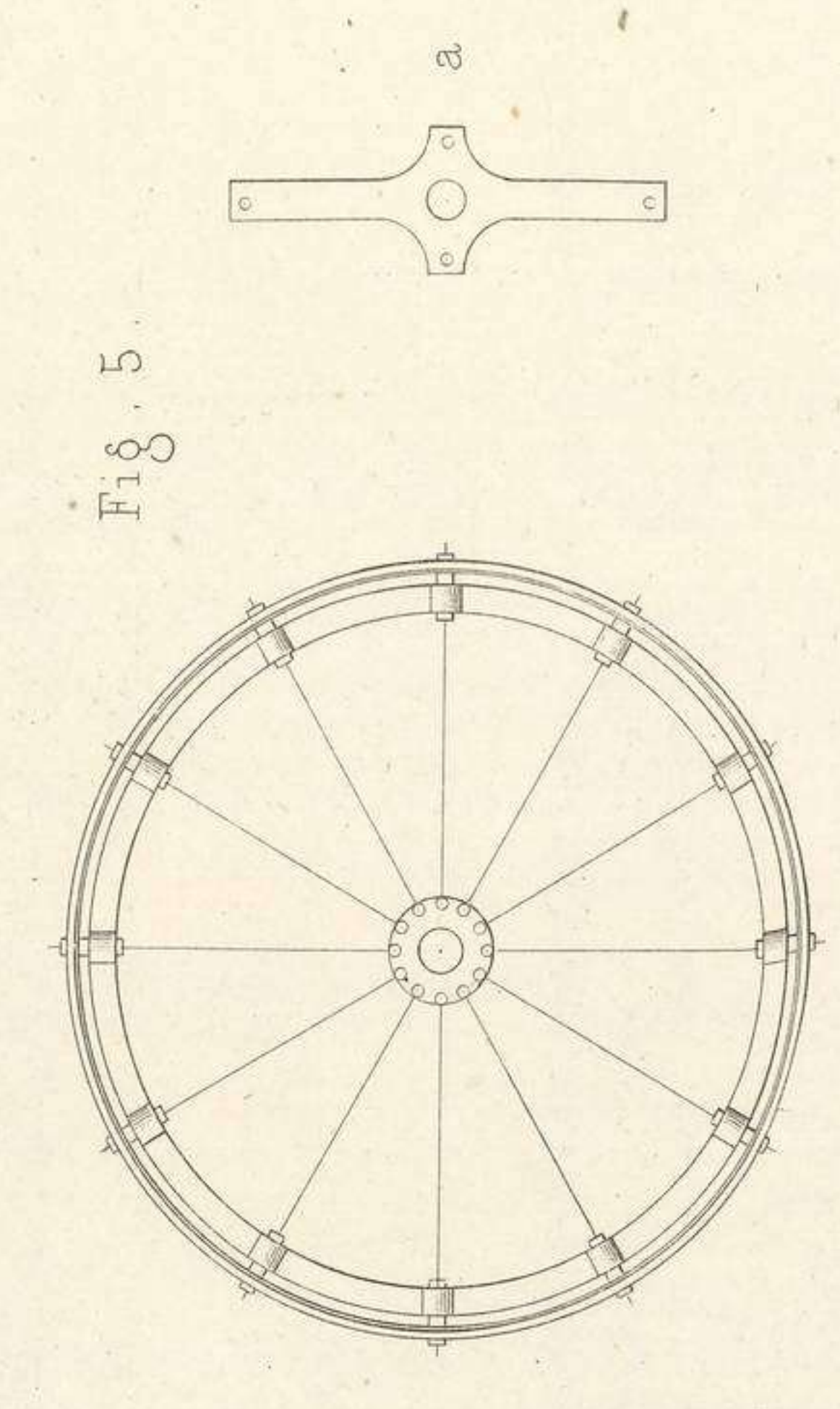
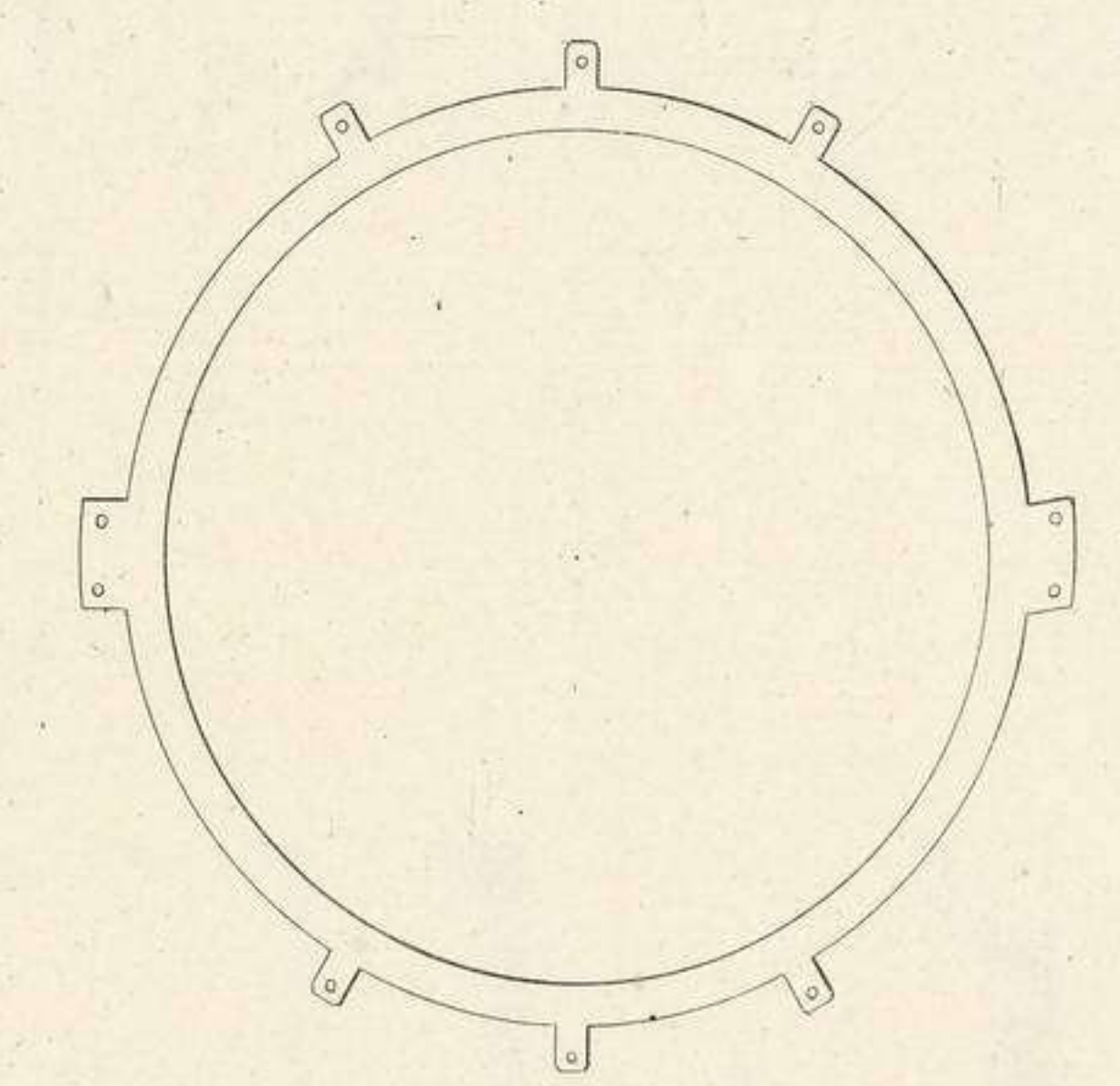

Fig. 4.



SERRURERIE.  
Ponts en fonte

B. M. V. del.

H. R.



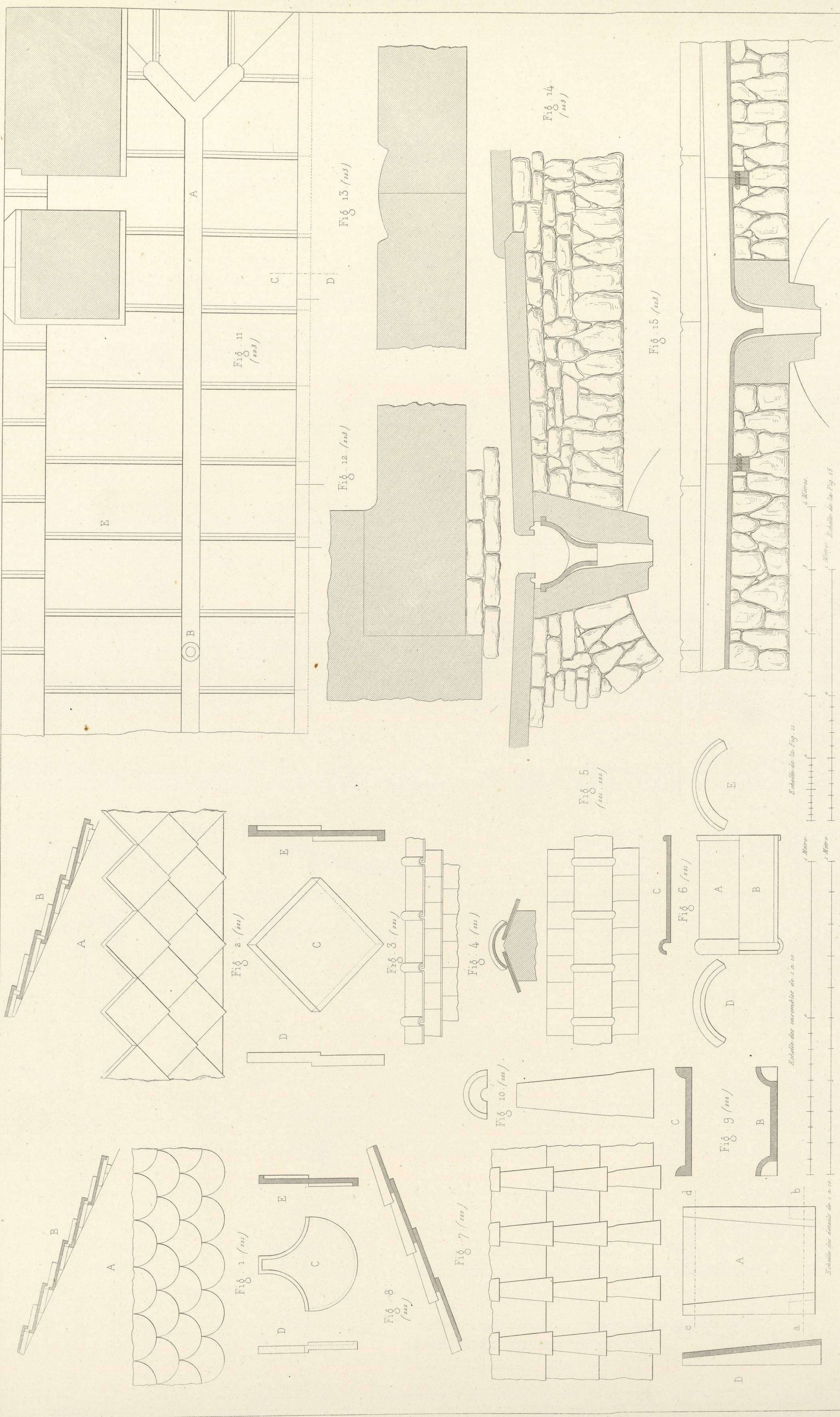

COUVERTURE.

Tuiles en terre cuite, dalles en pierre.



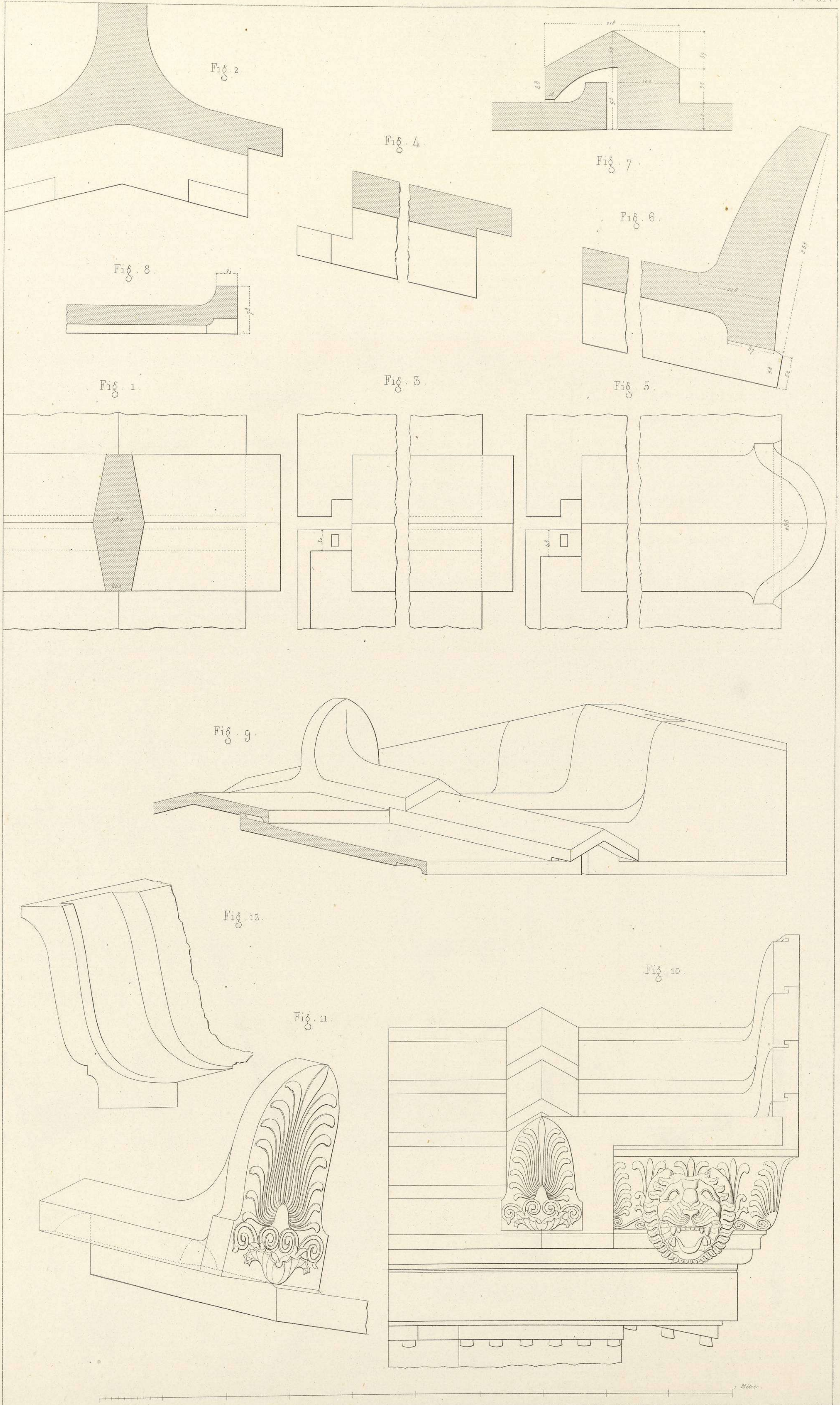

COUVERTURE.  
Tuiles en marbre.



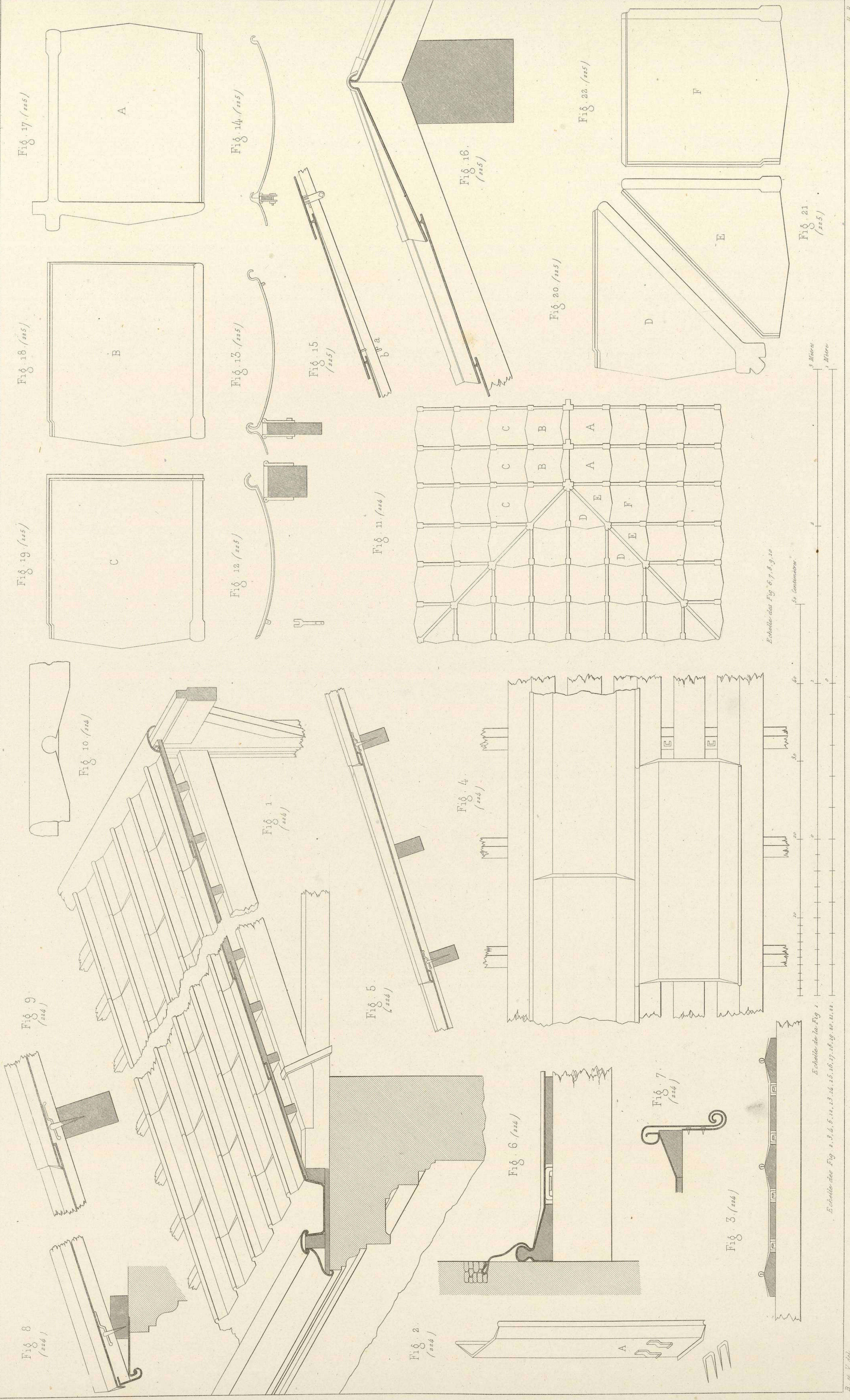

Echelle des Fig. 6, 7, 8, 9, 10

Echelle des Fig. 1, 2, 3, 4, 5, 11, 12, 13, 14, 15, 16, 17, 18, 19, 20, 21, 22

3 Mètres

1 Mètre

En Centimètres

B. de V. del. H. R.

COUVERTURES. Tuiles en métal.







FONDEMENT  
DE LA  
DE LA  
SUPPLEMENT

11