

TOPOGRAFIA



ATLAS

3ª EDICION.





PLANO TOPOGRAFICO
 del Camino de Hierro
 de
MADRID A ARANJUEZ.

JOSE PARRA
 GUILLERMO
 ARQUITECTO
 PL. SANCIA

Lit. de J. Bonon. Victoria. 1. Madrid

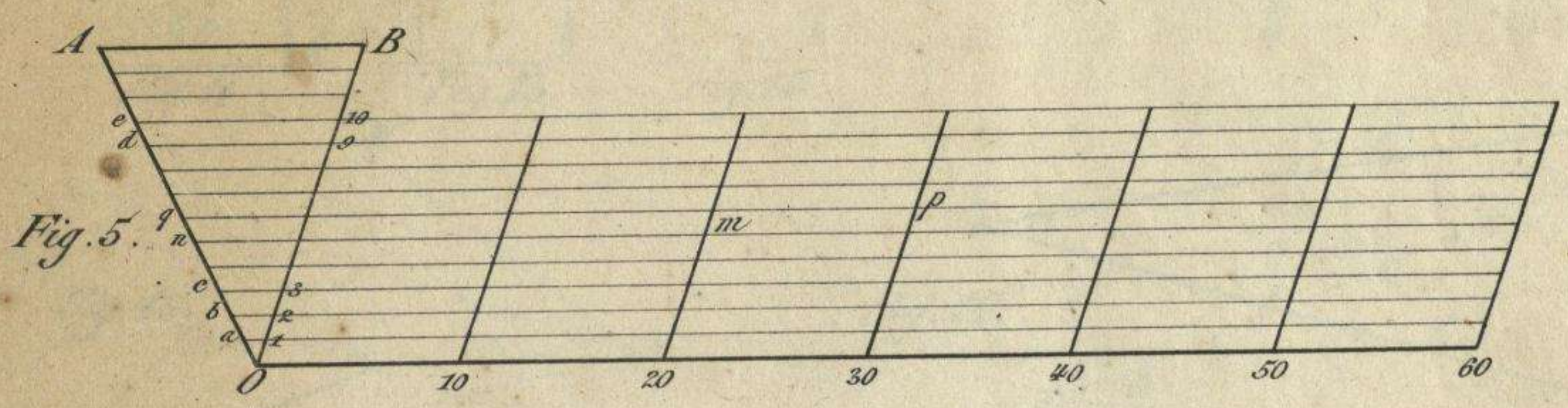
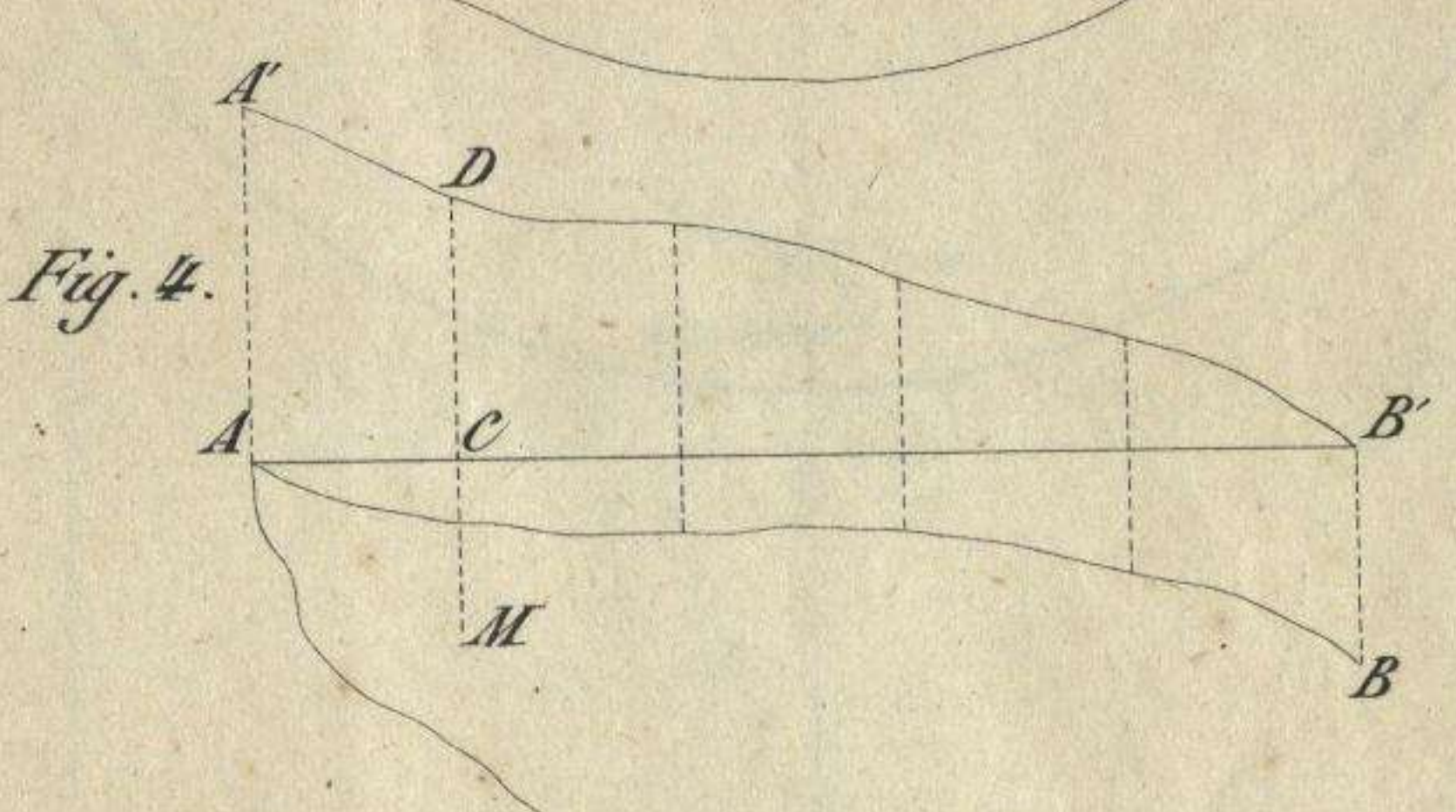
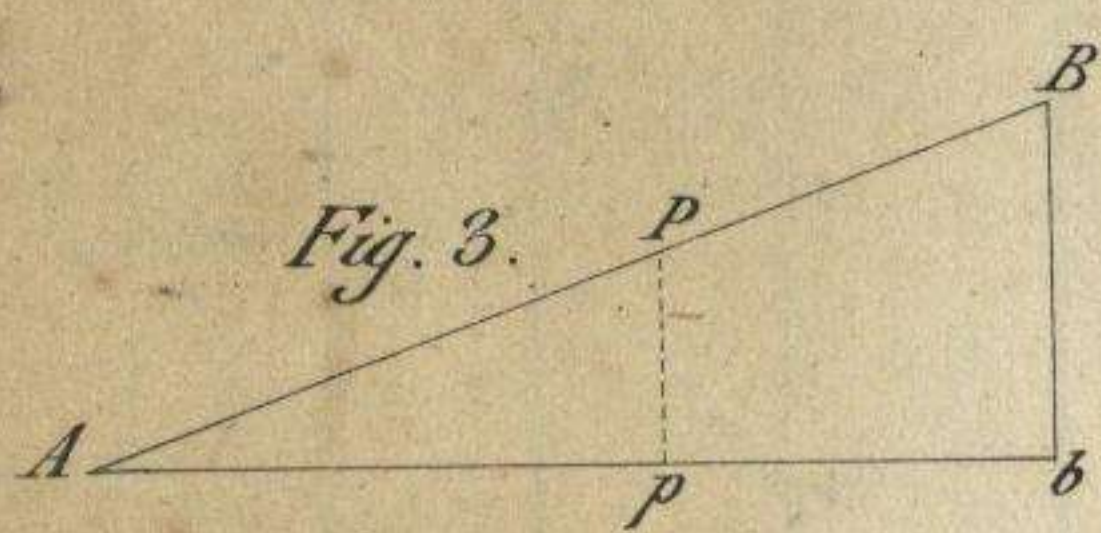
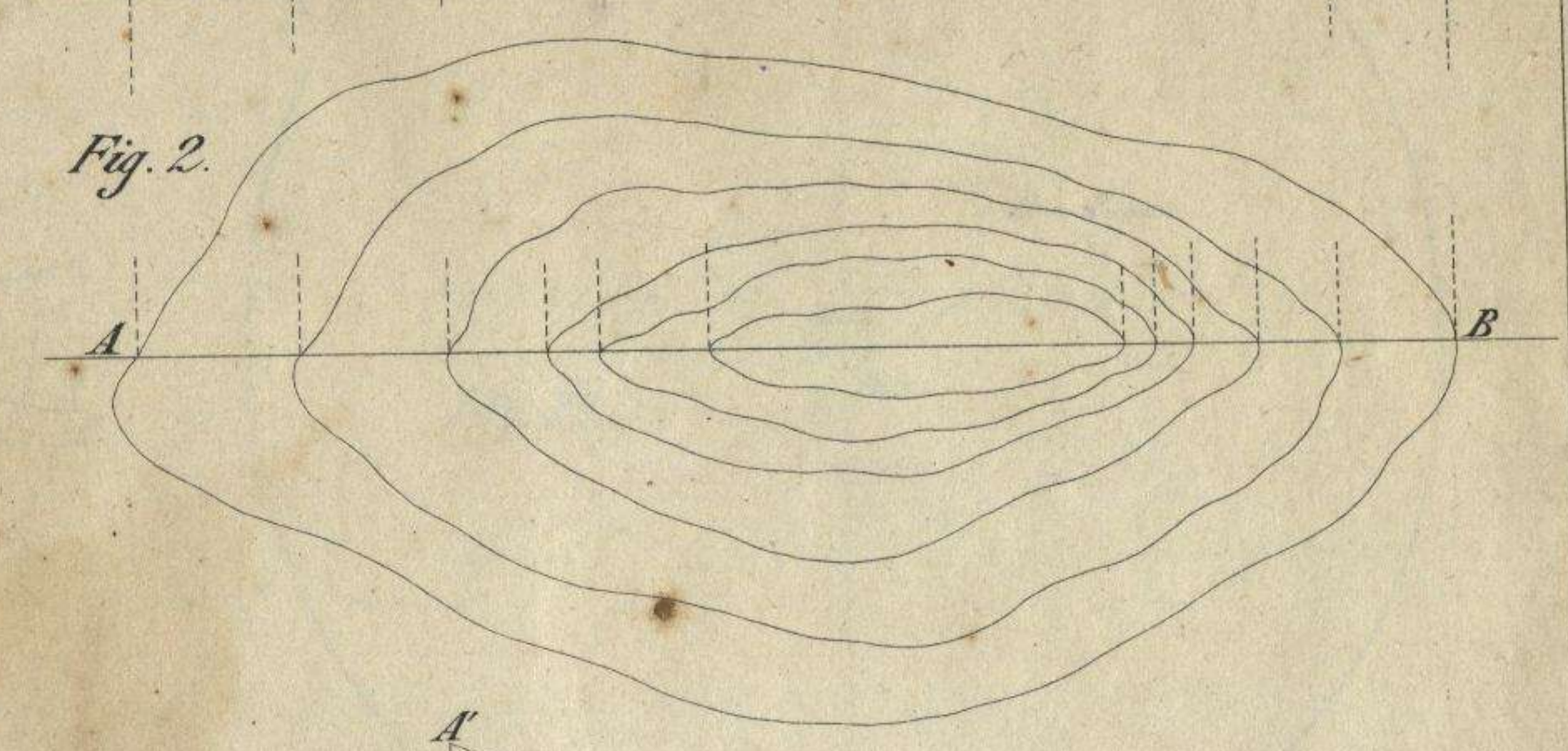
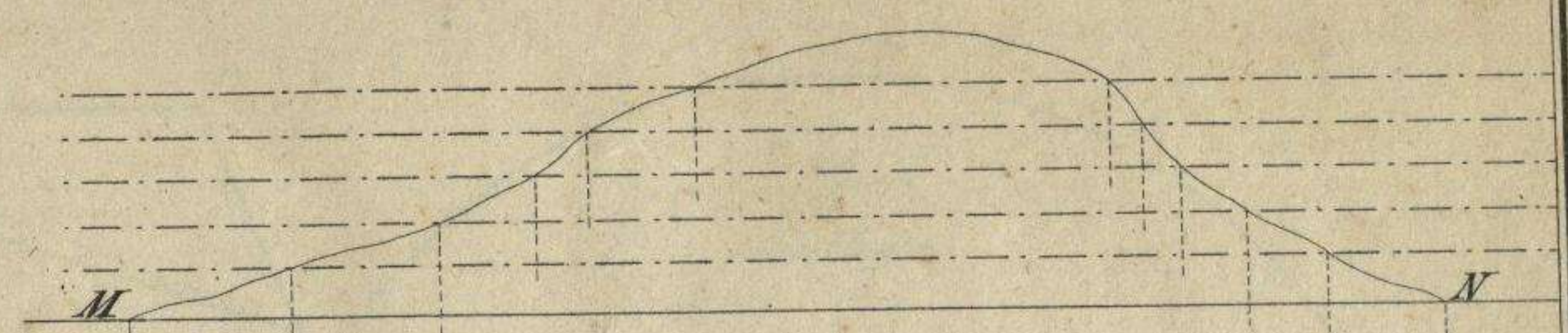
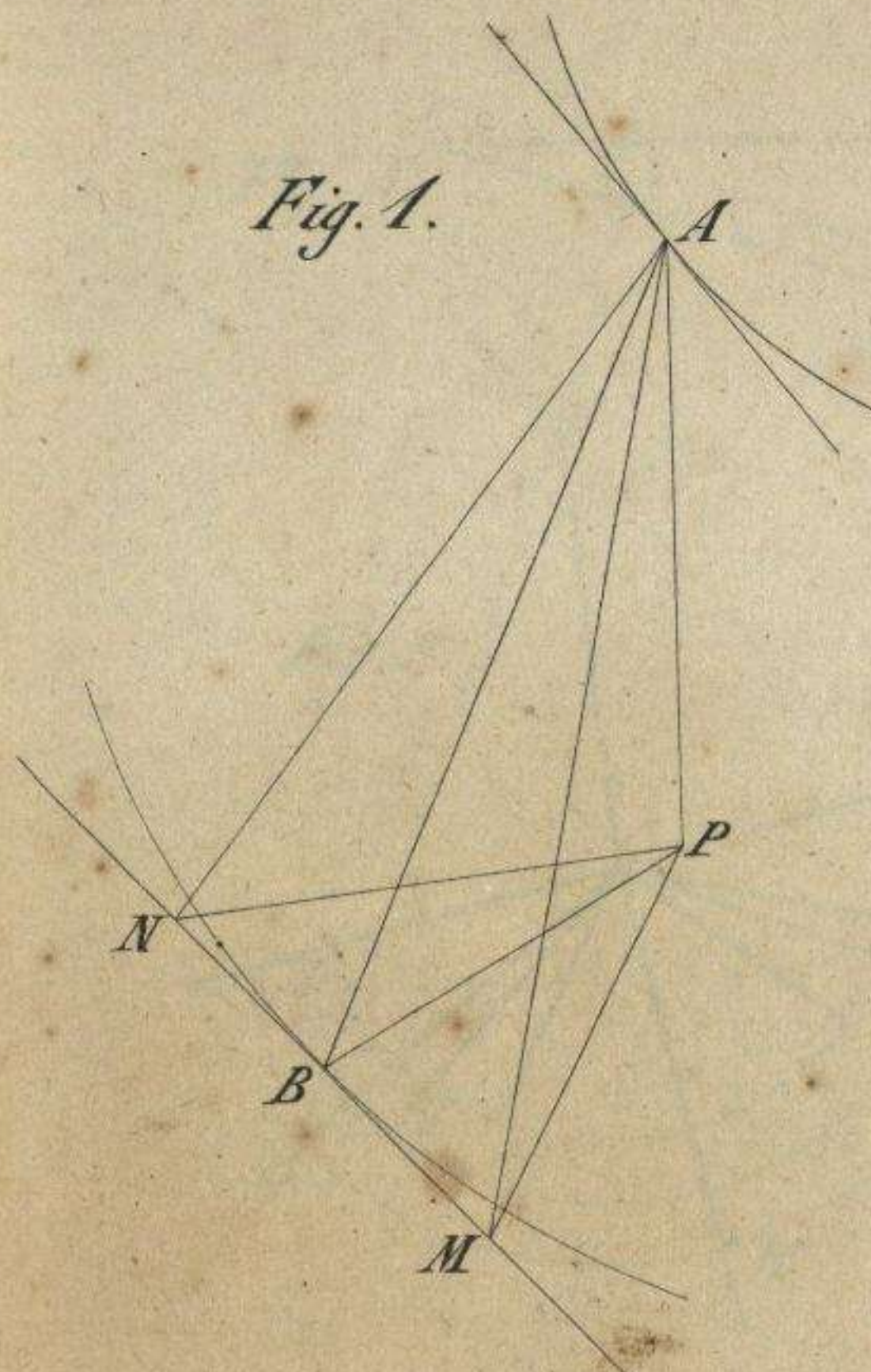

$\frac{1}{13}$ de pulg.^a

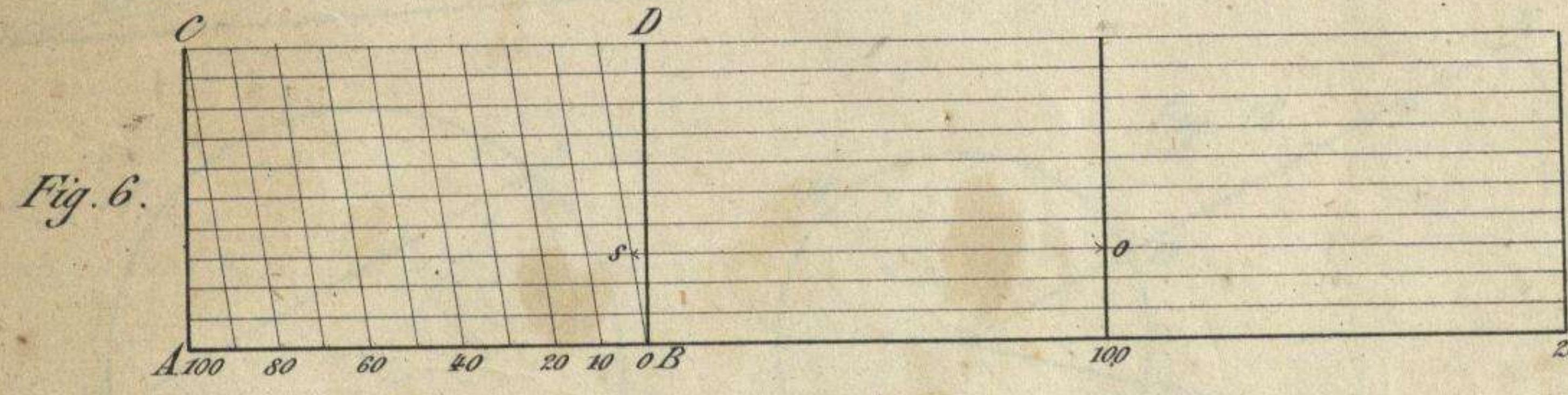

$\frac{1}{2.500}$

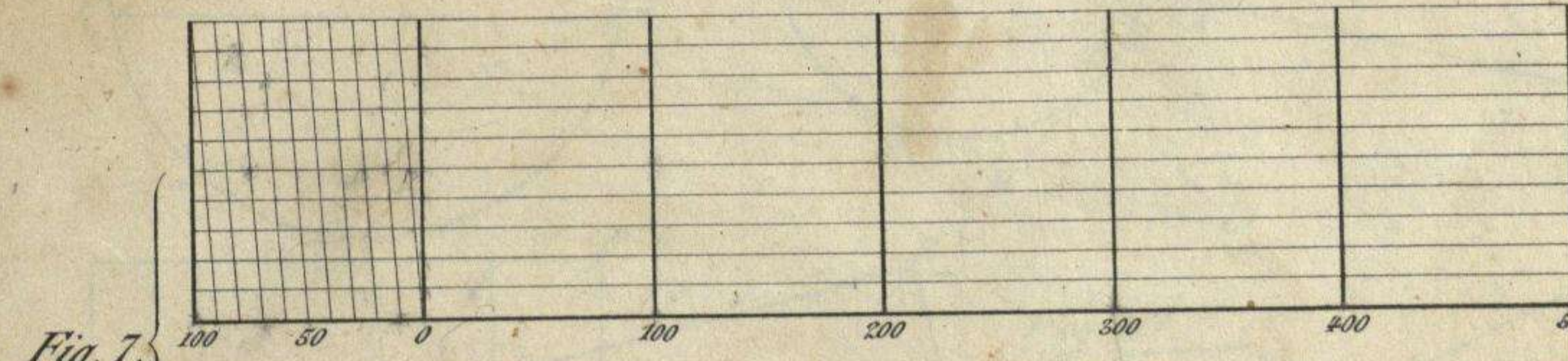

$\frac{1}{5.000}$

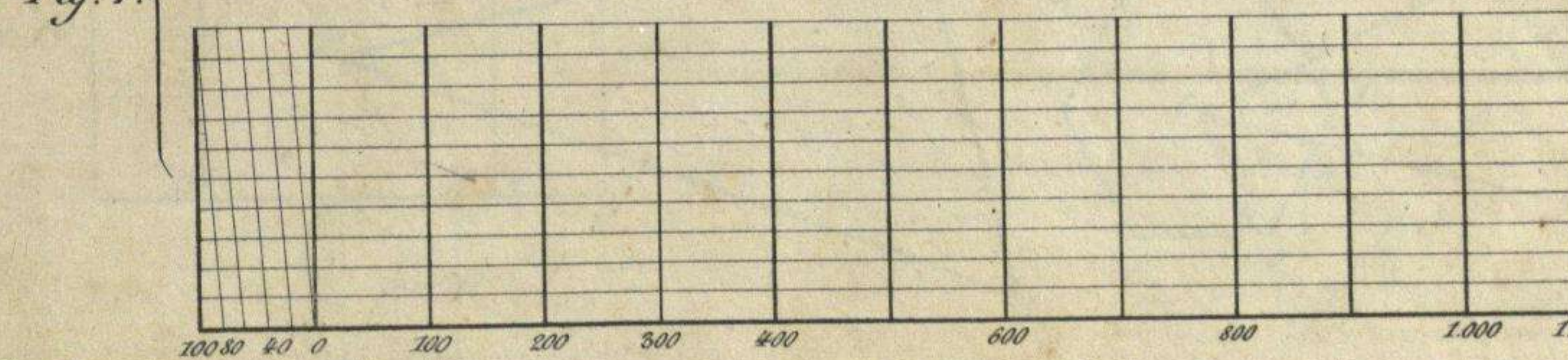

$\frac{1}{10.000}$

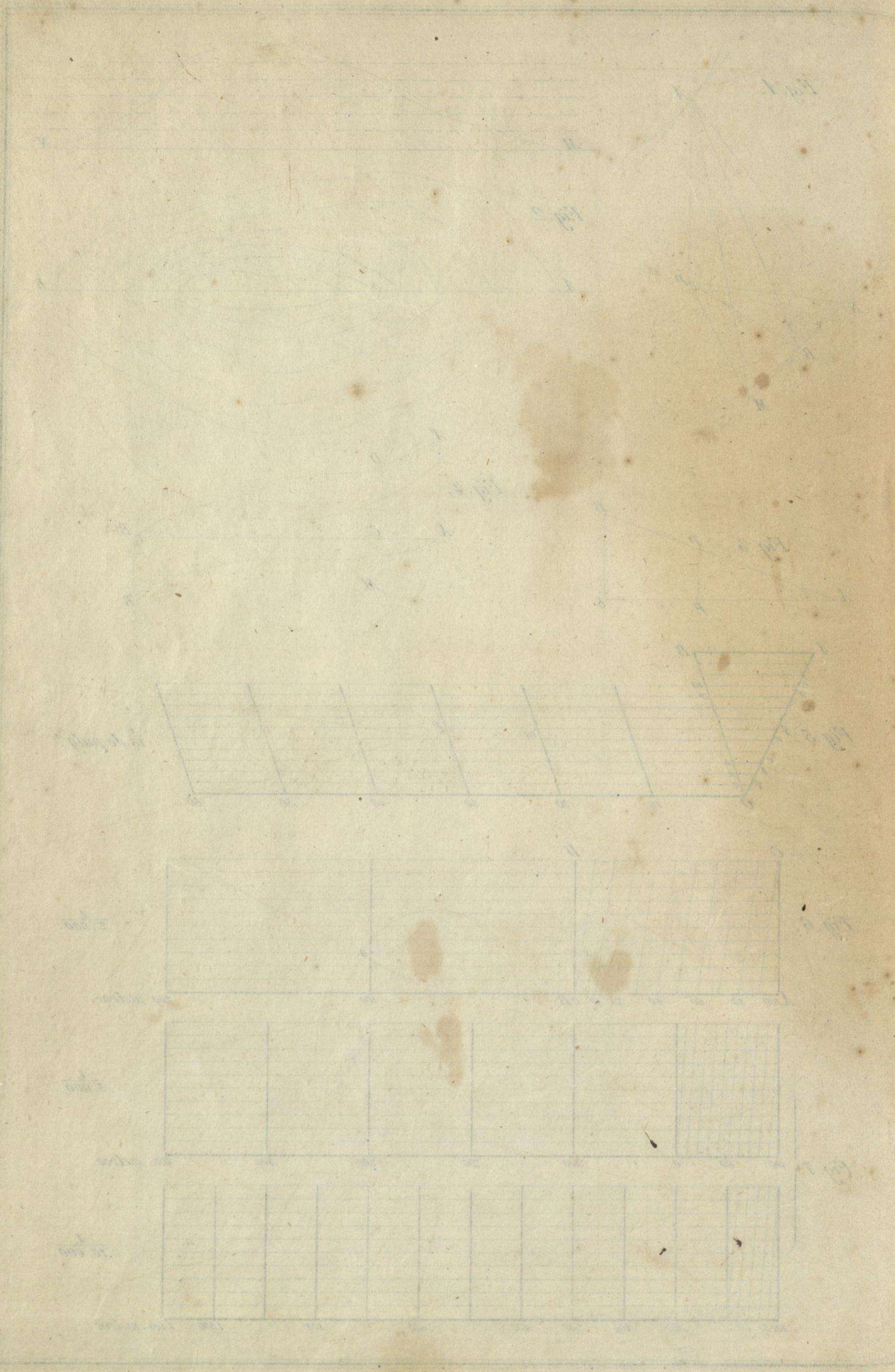

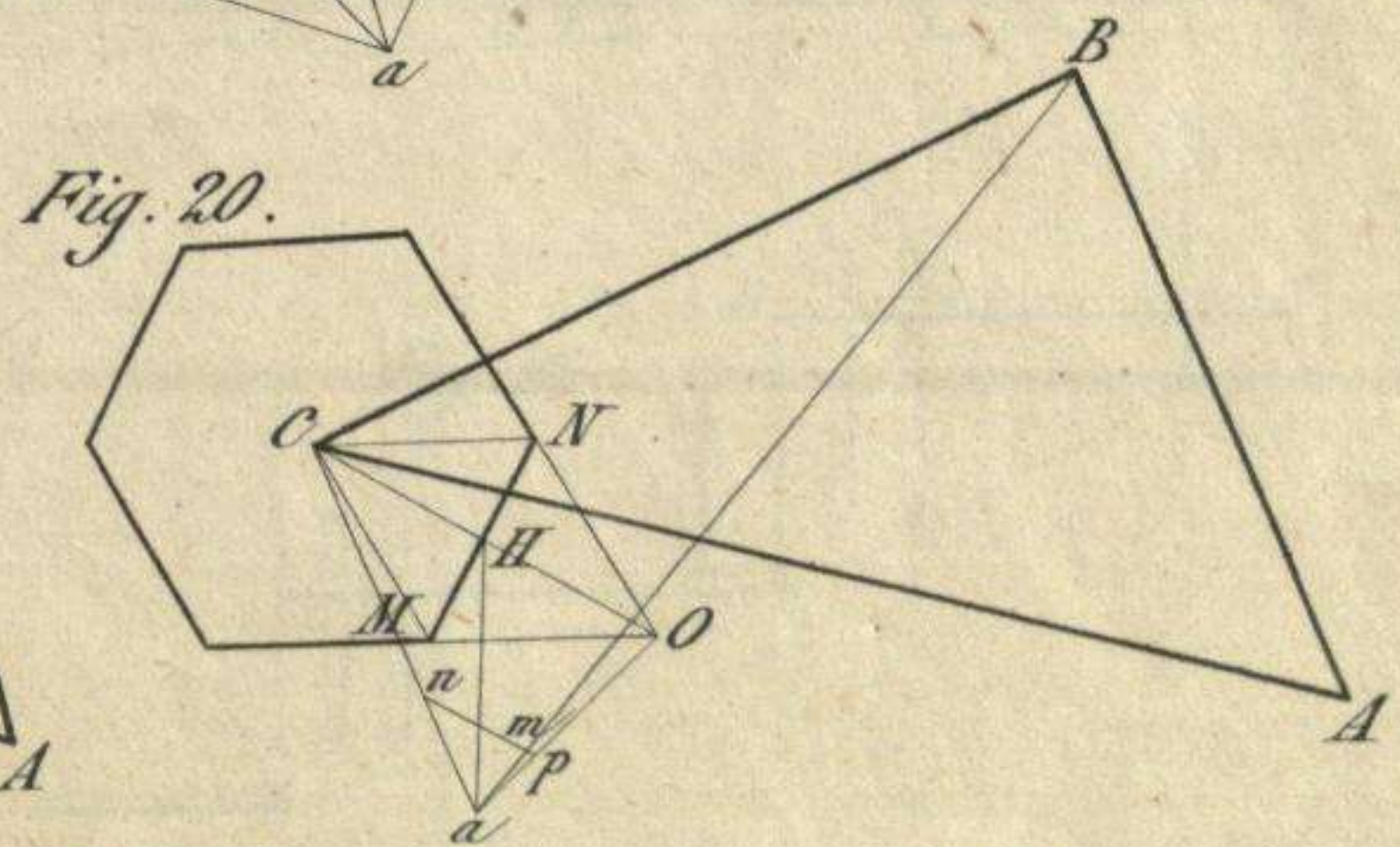
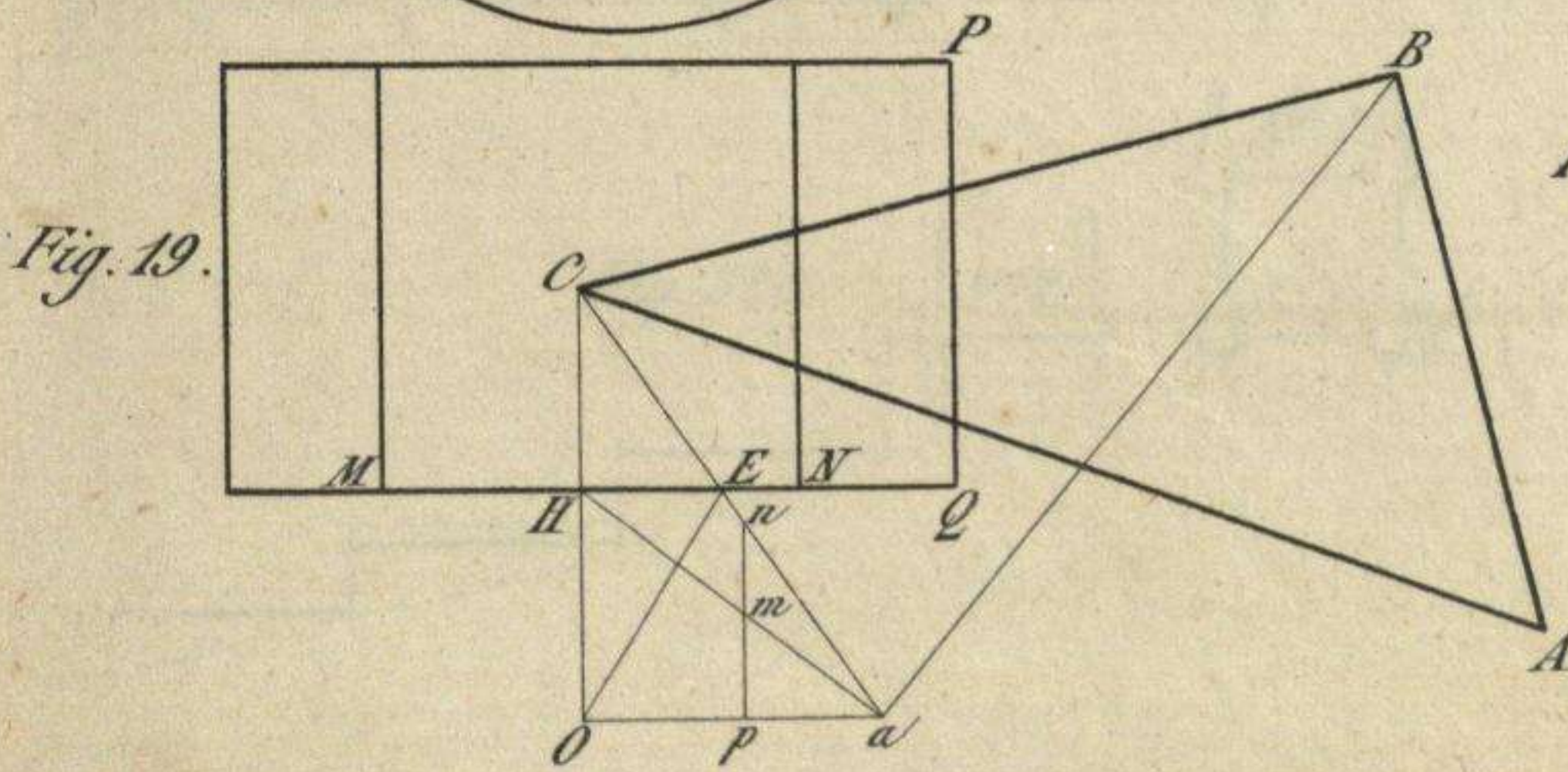
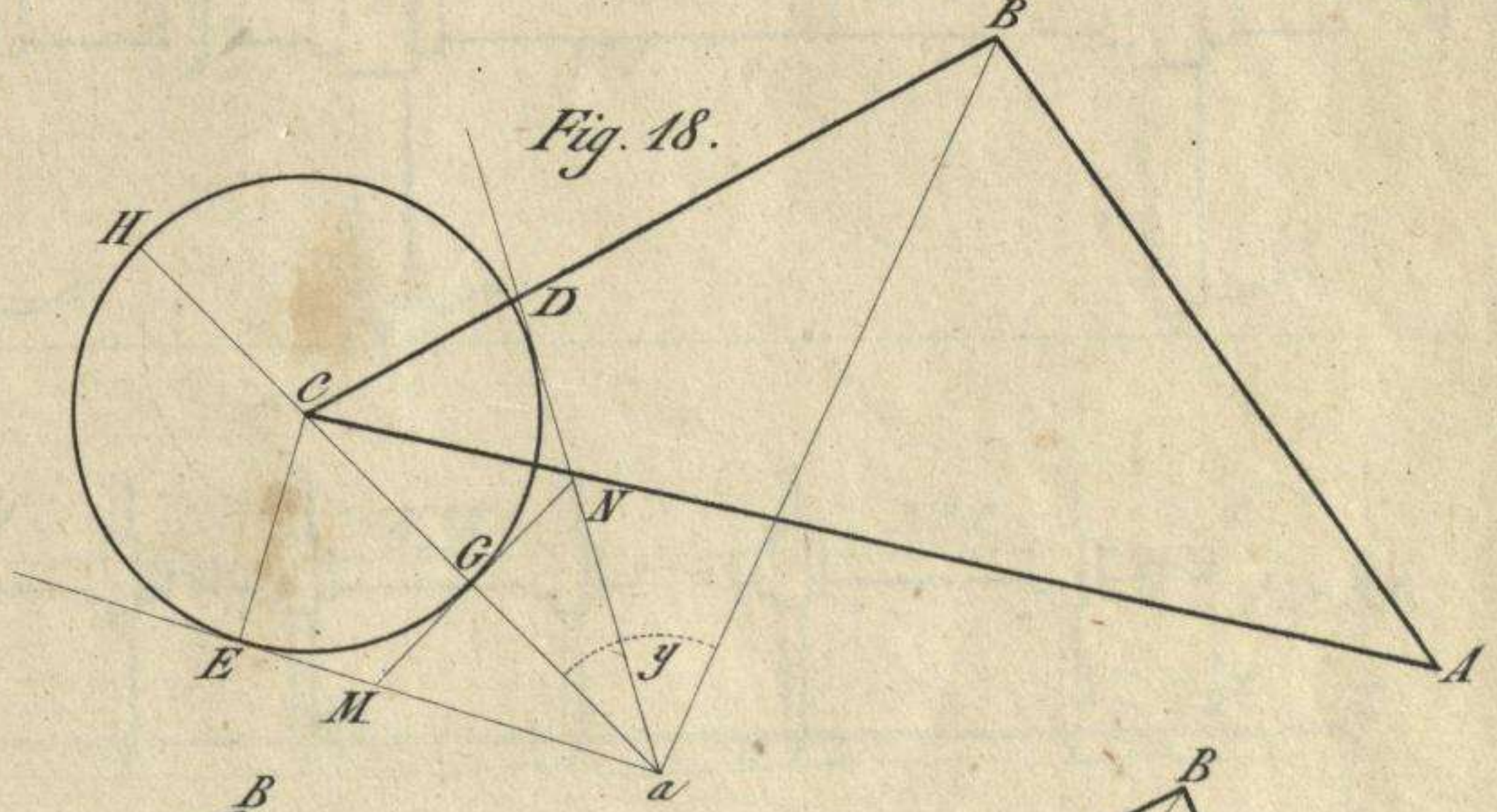
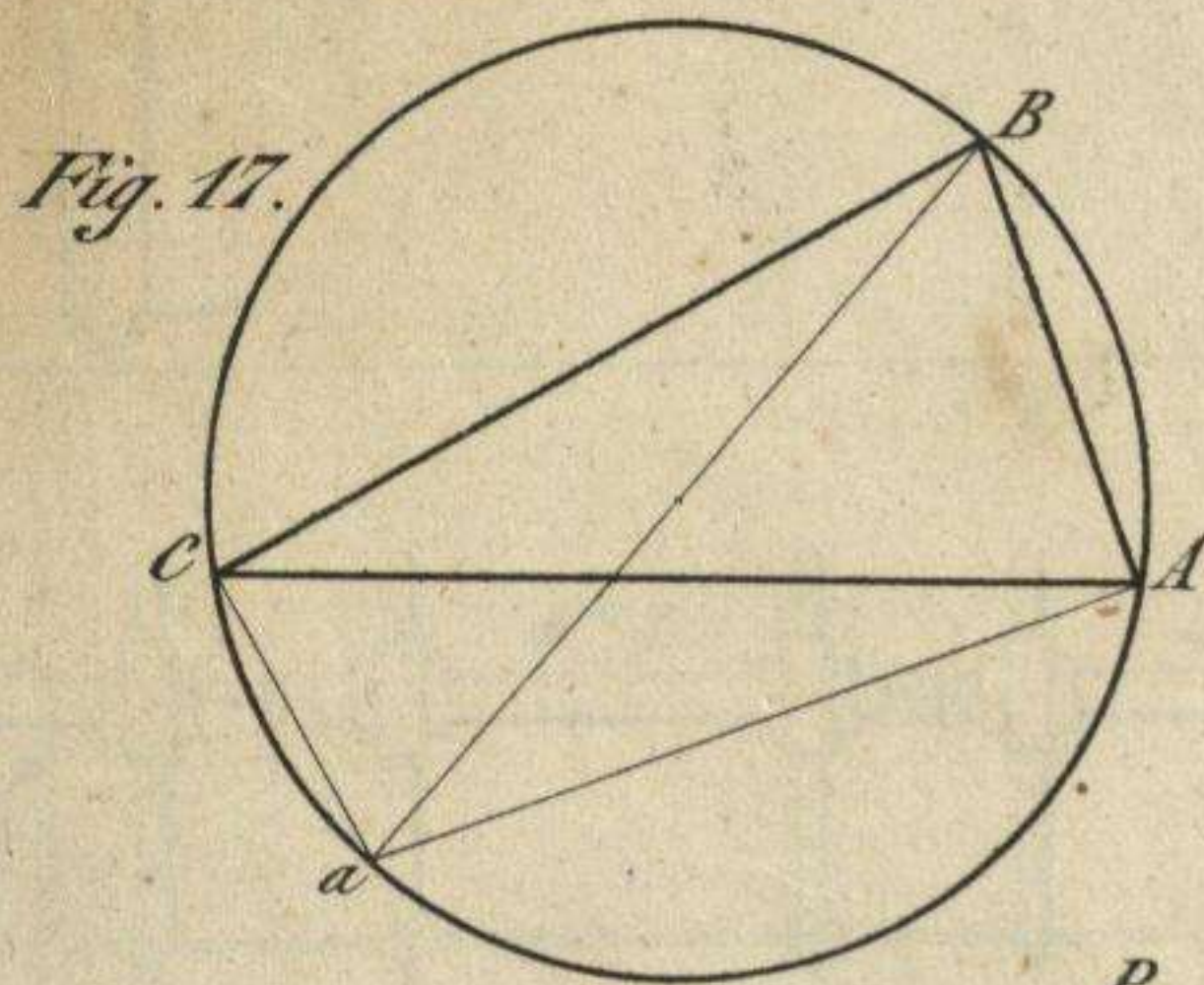
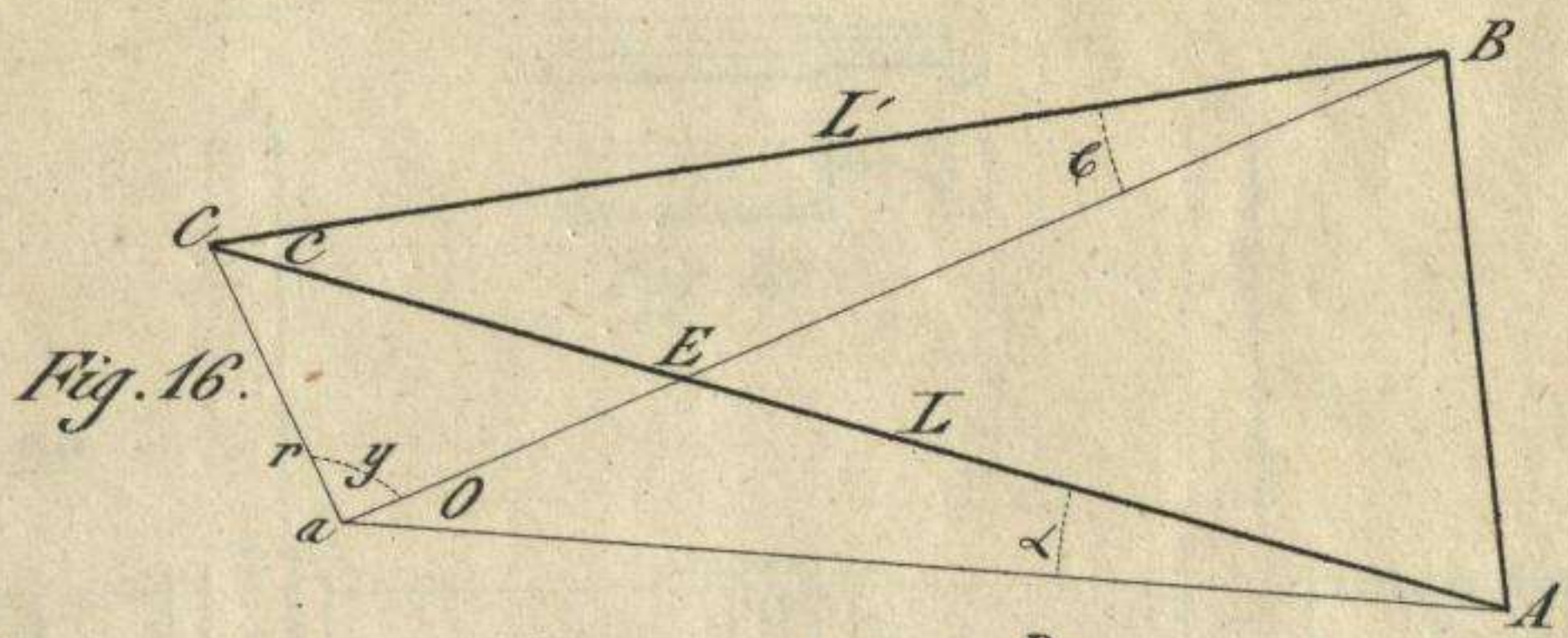
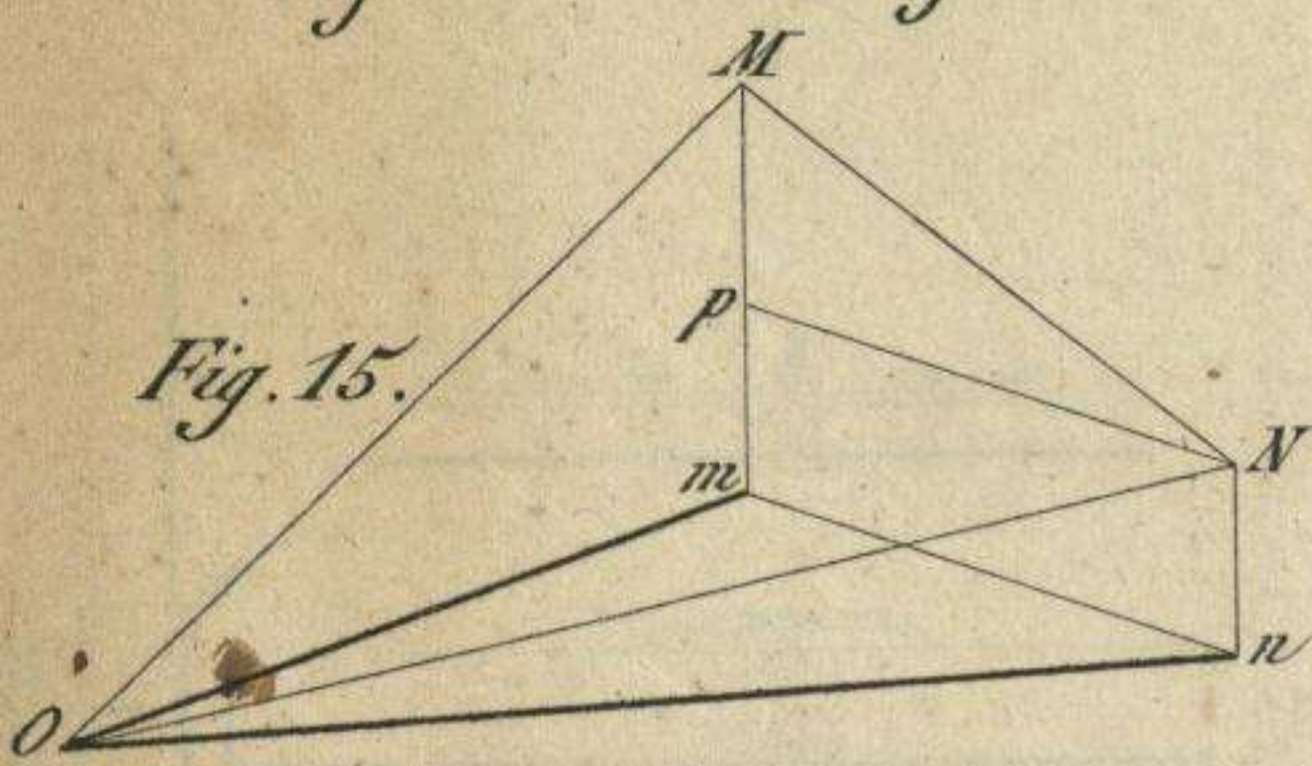
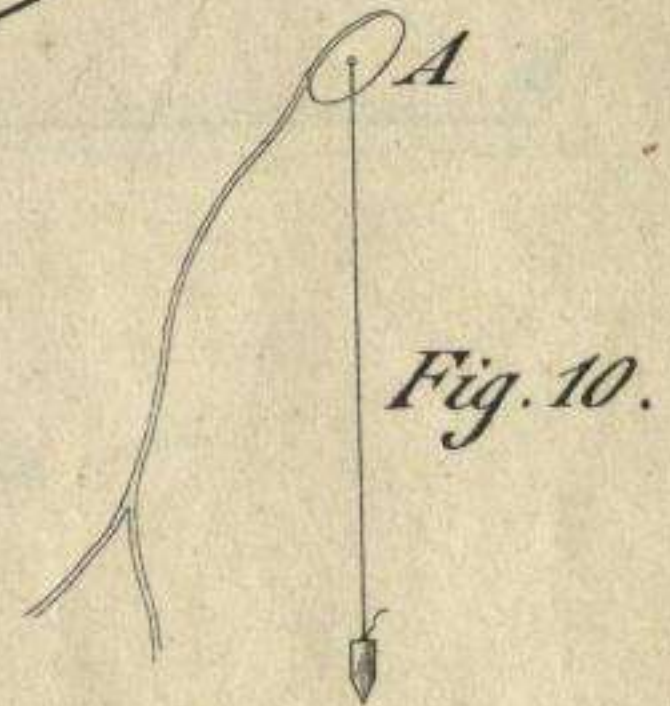
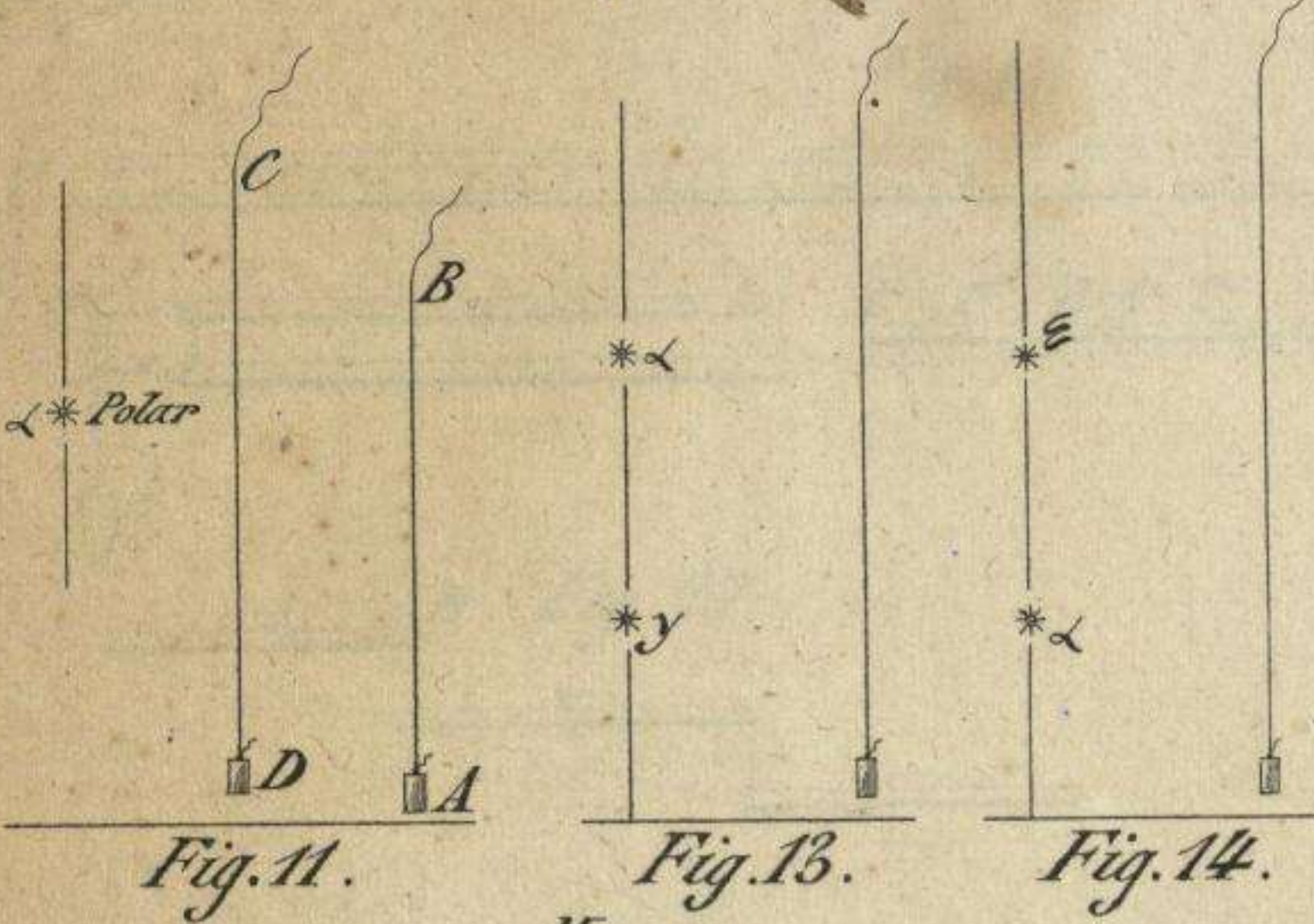
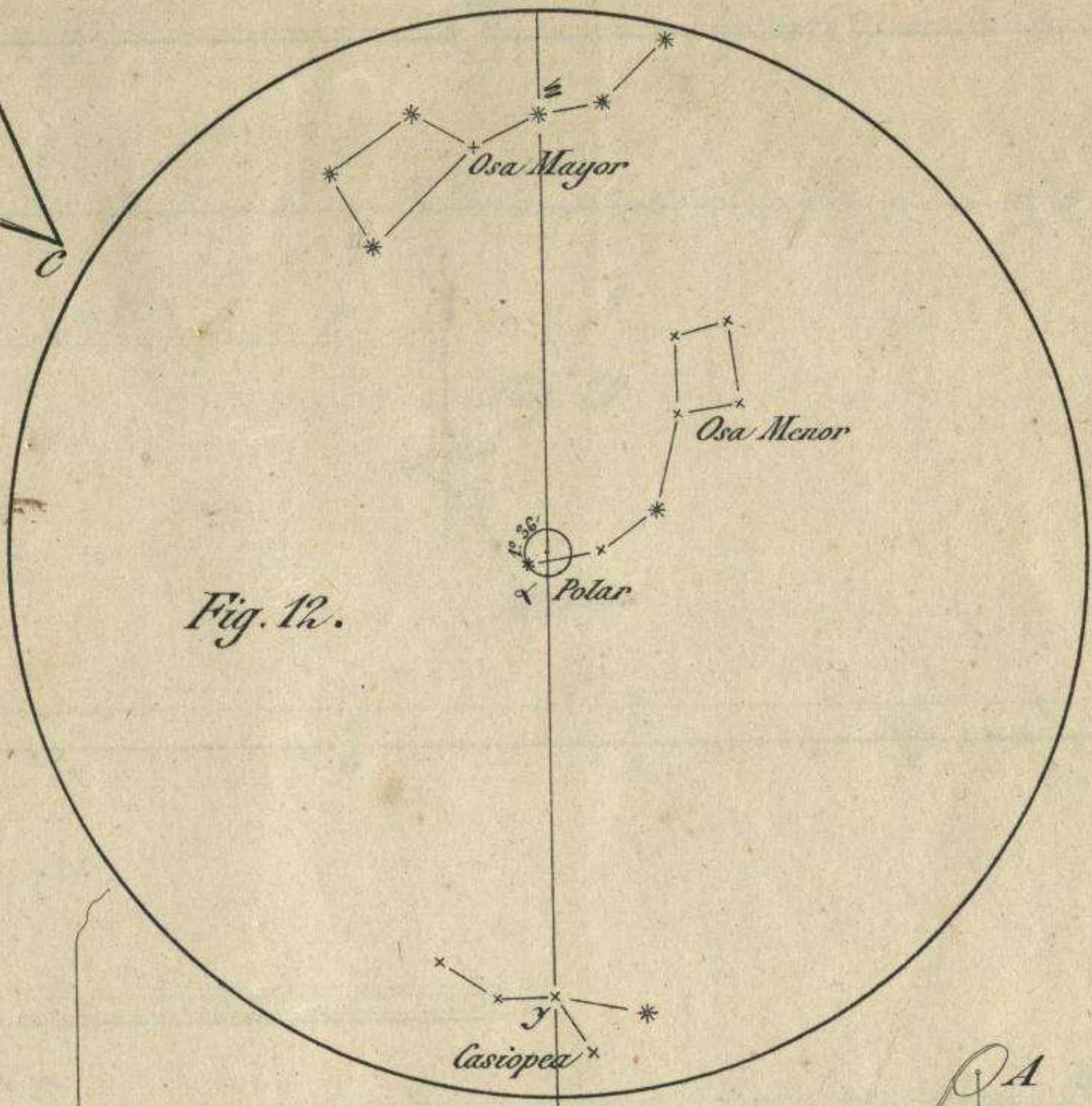
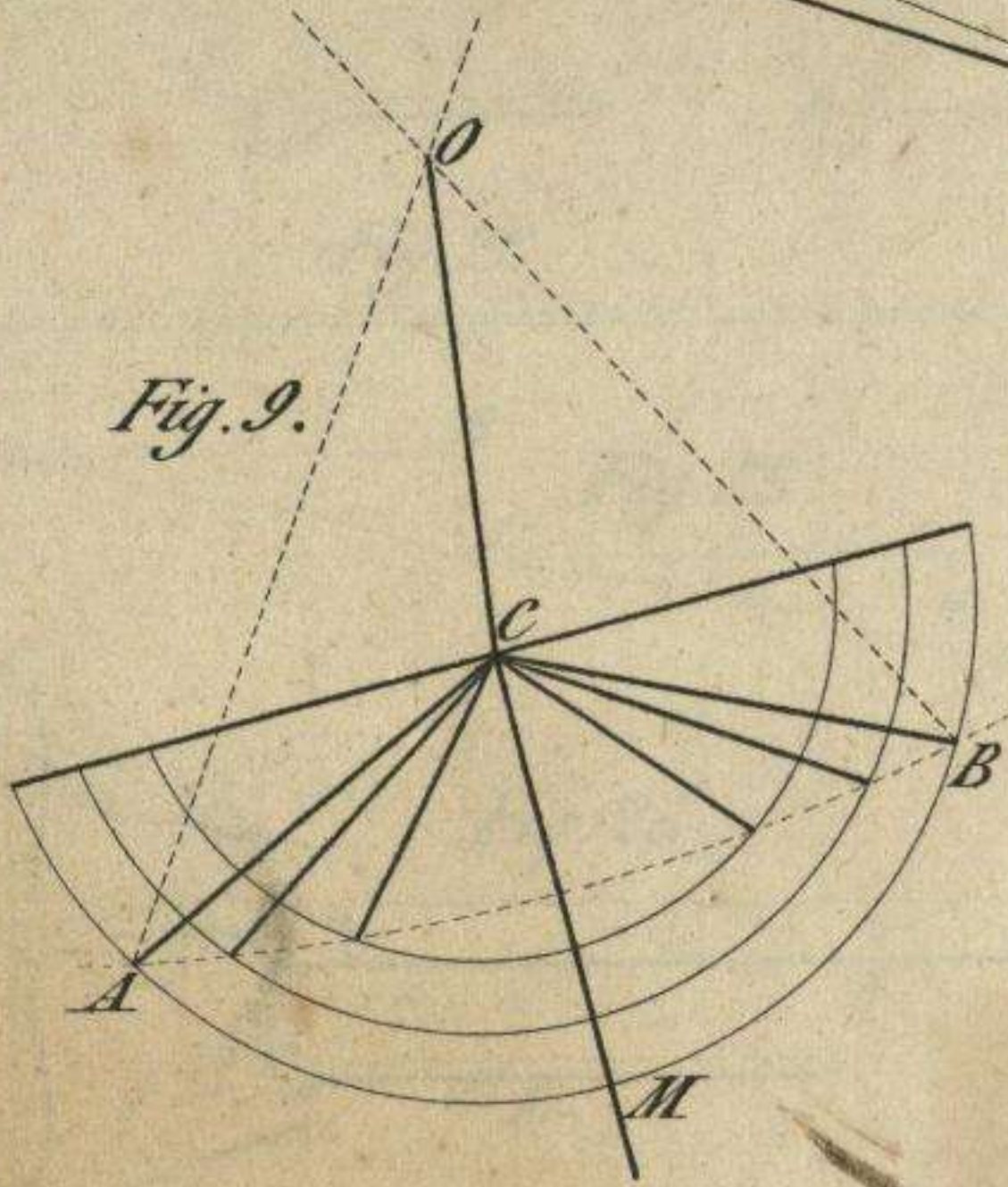
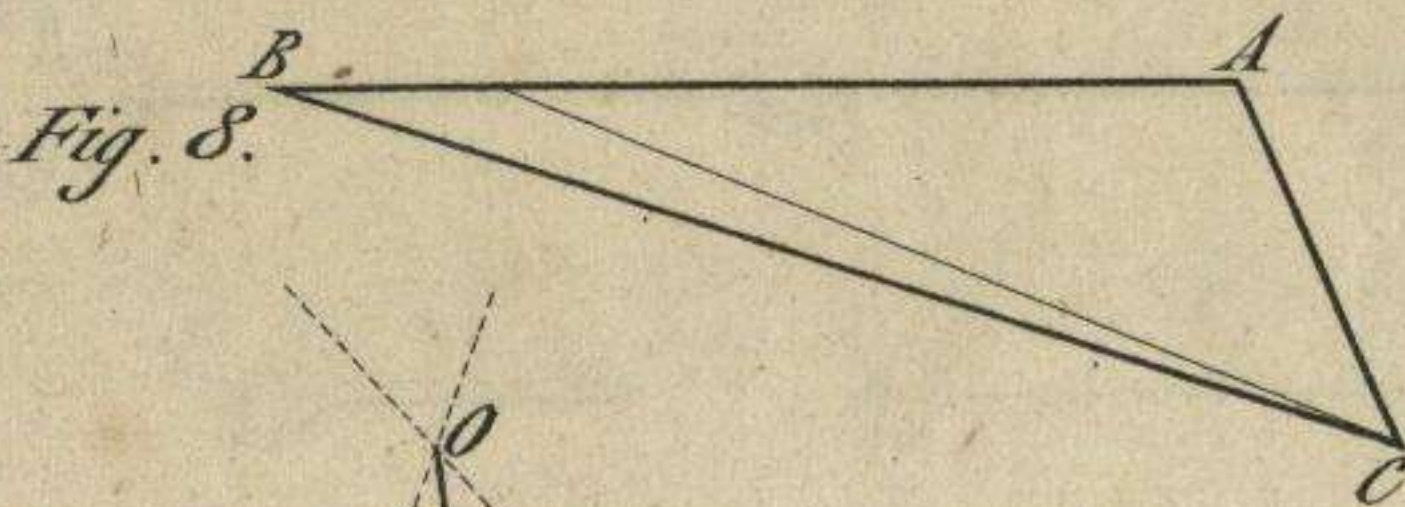

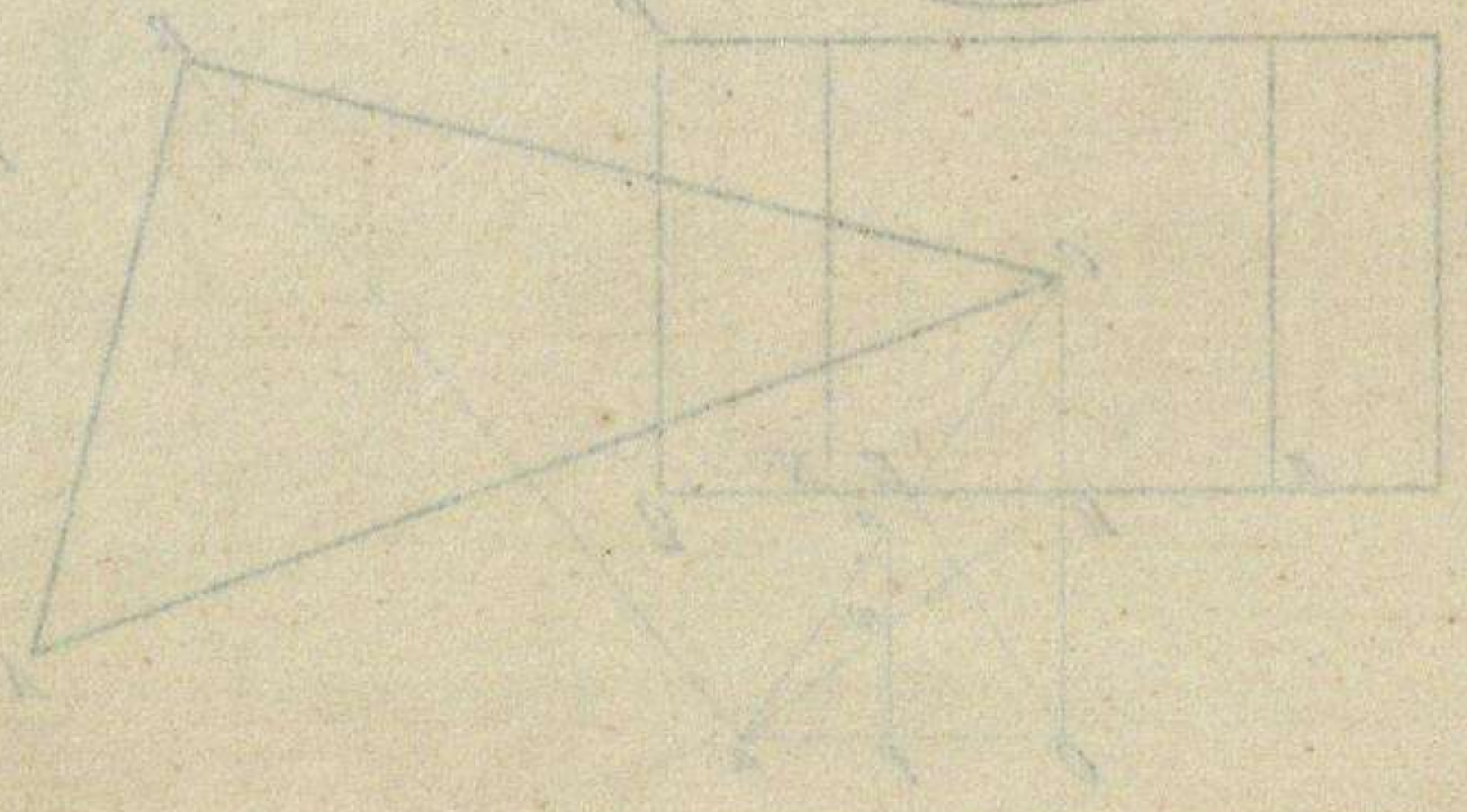
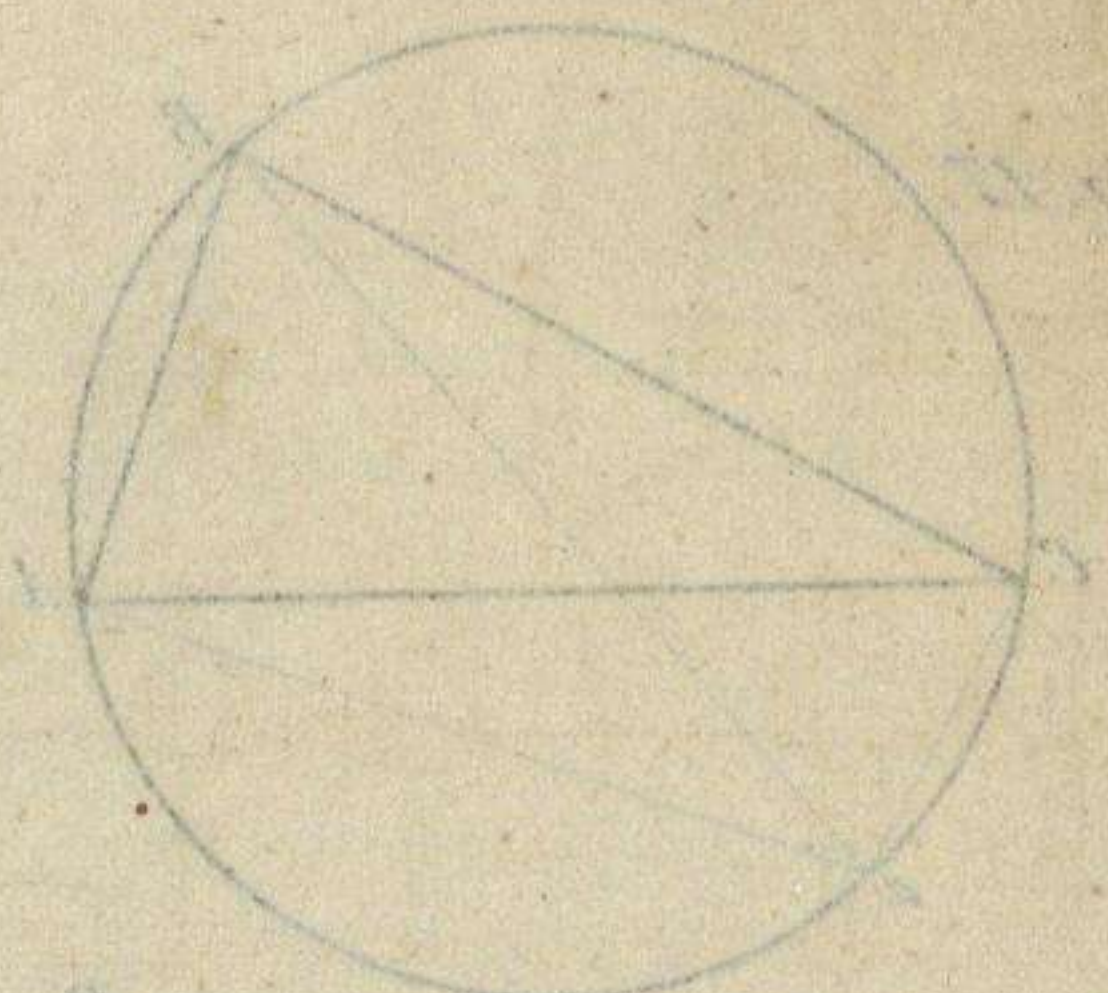
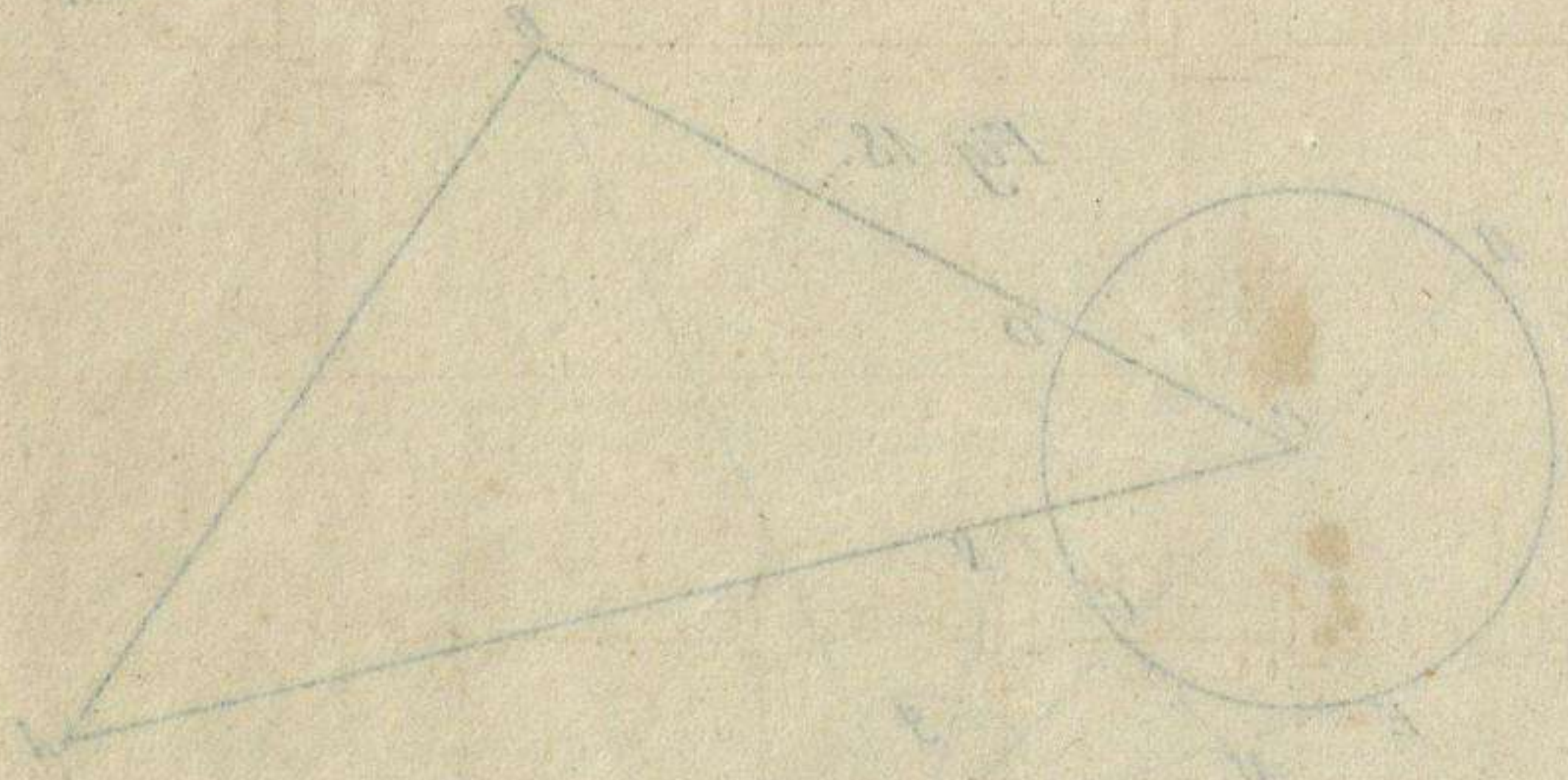
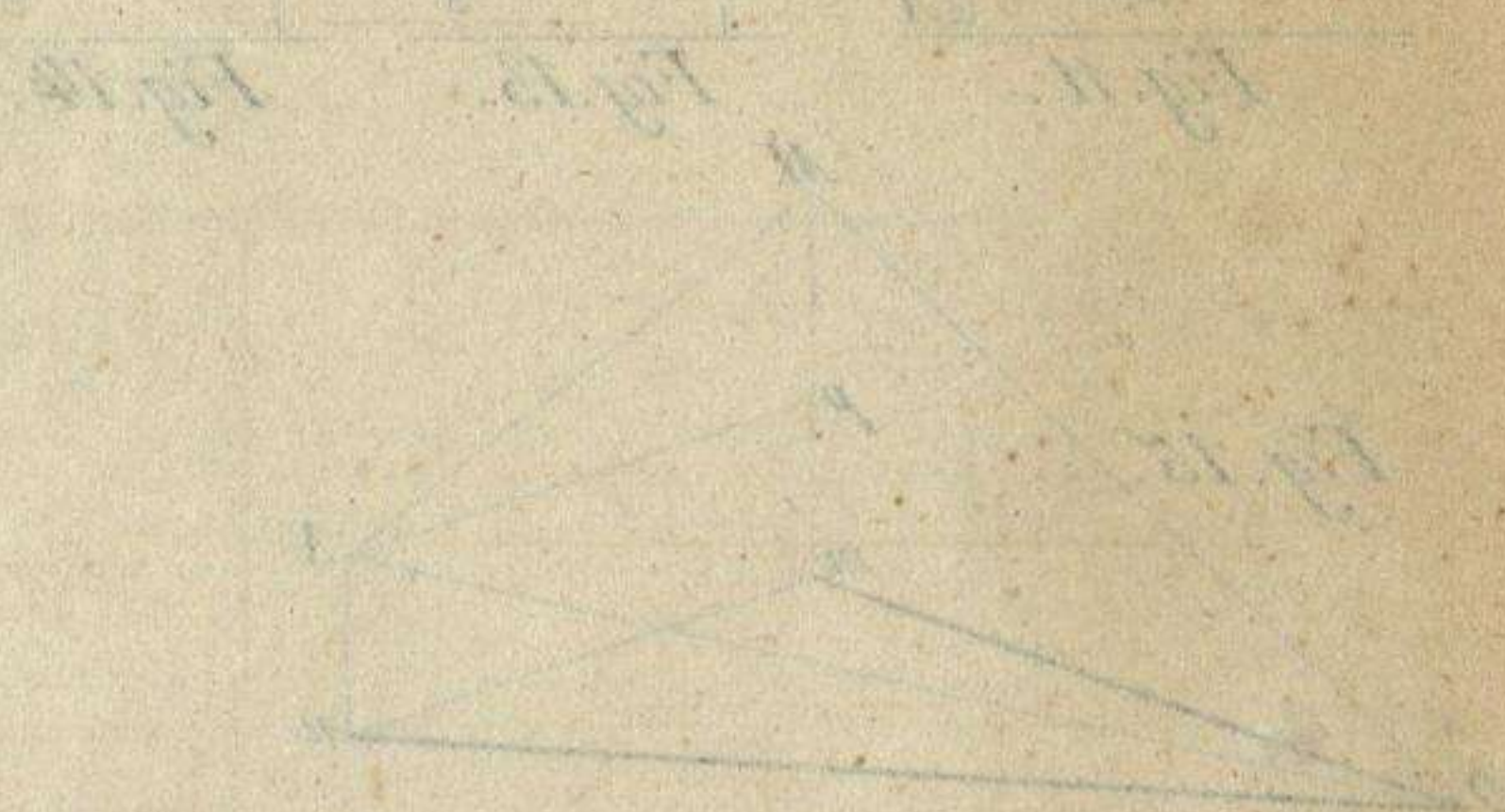
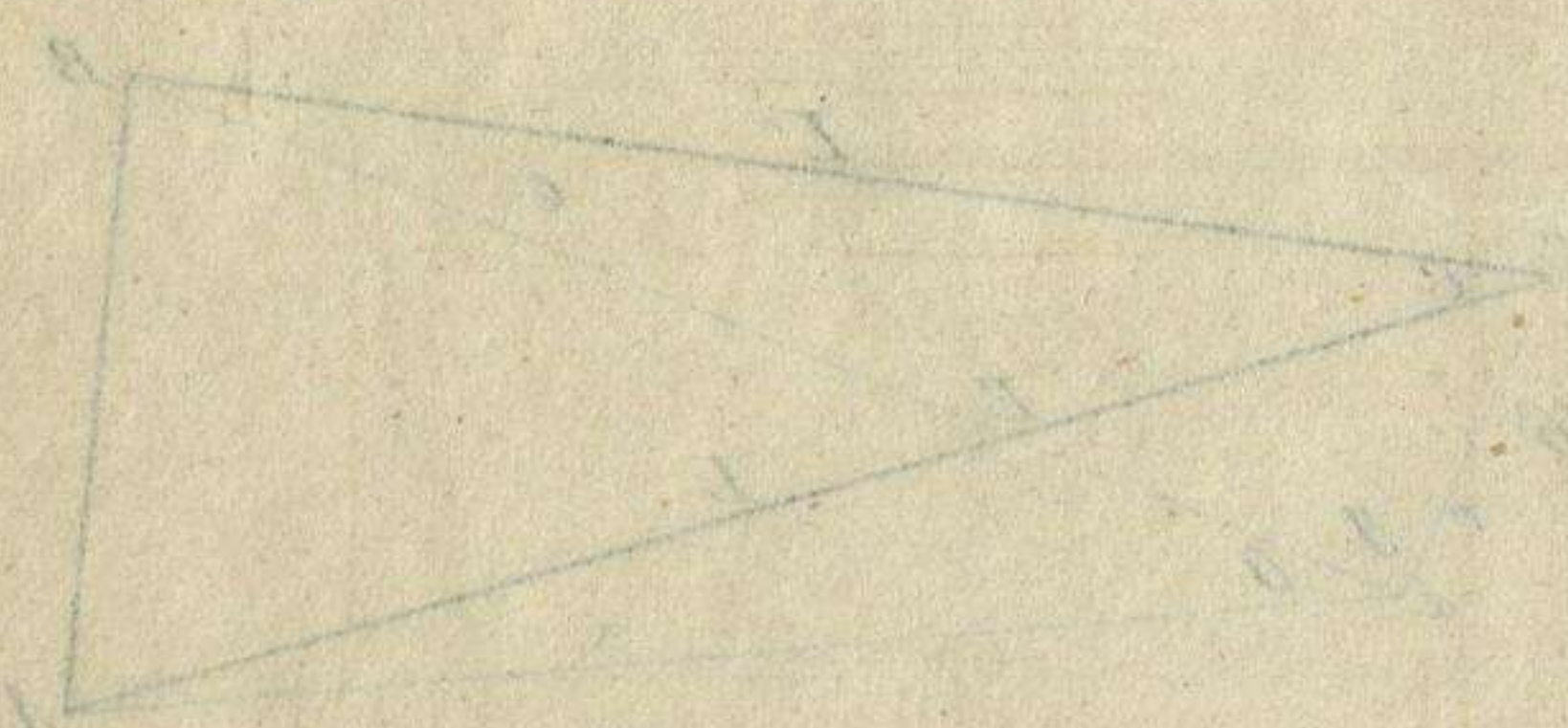
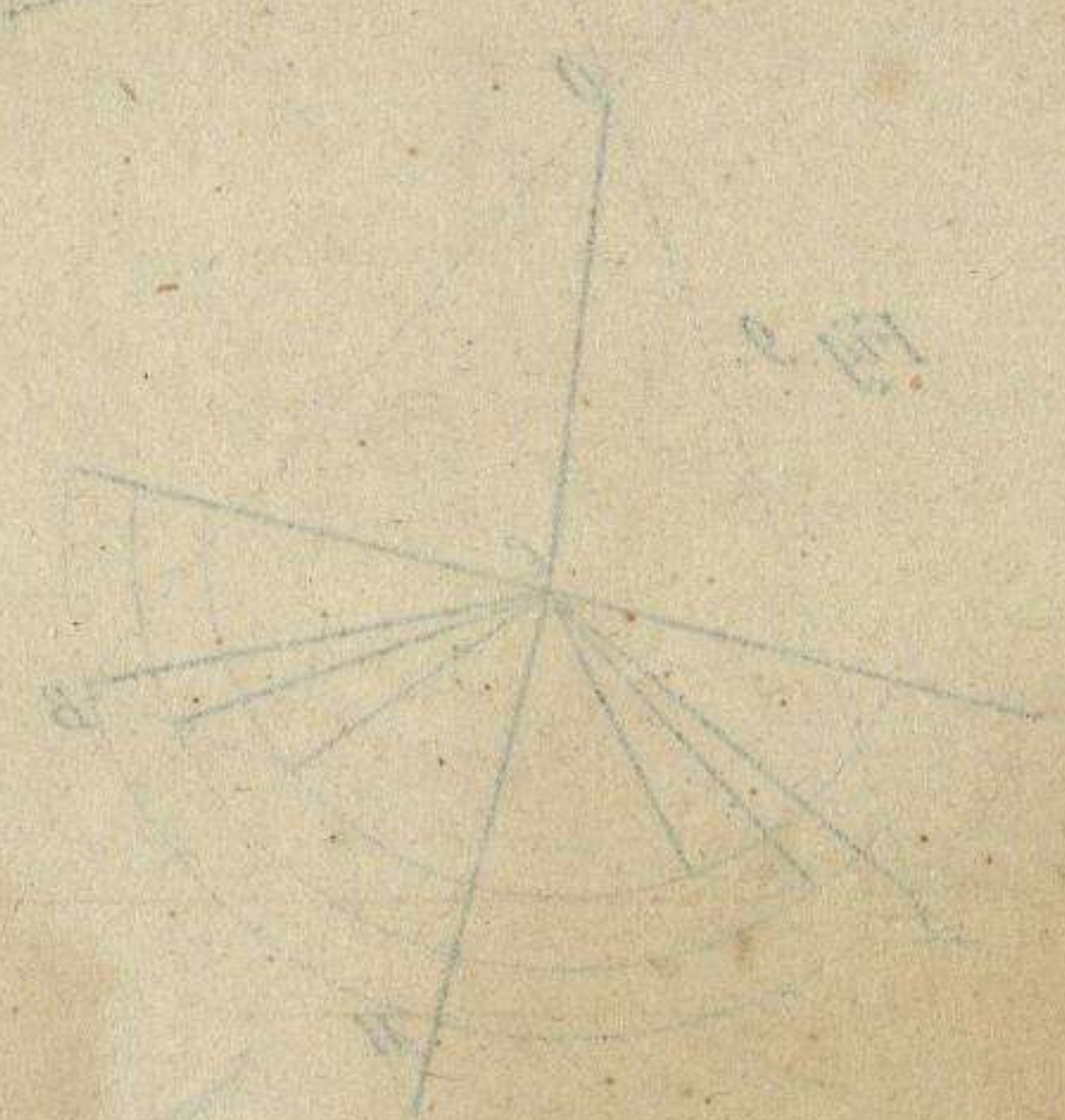
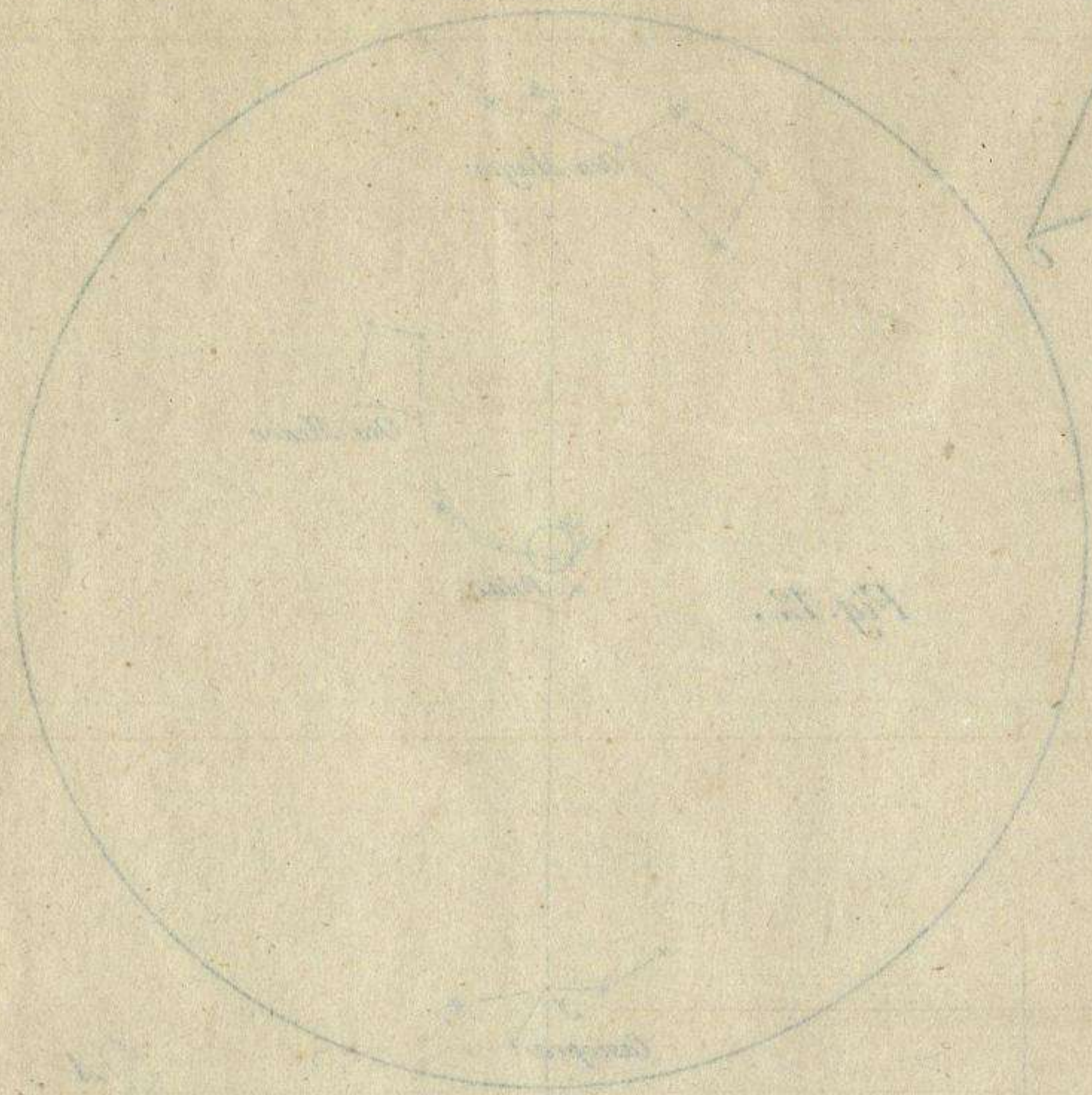

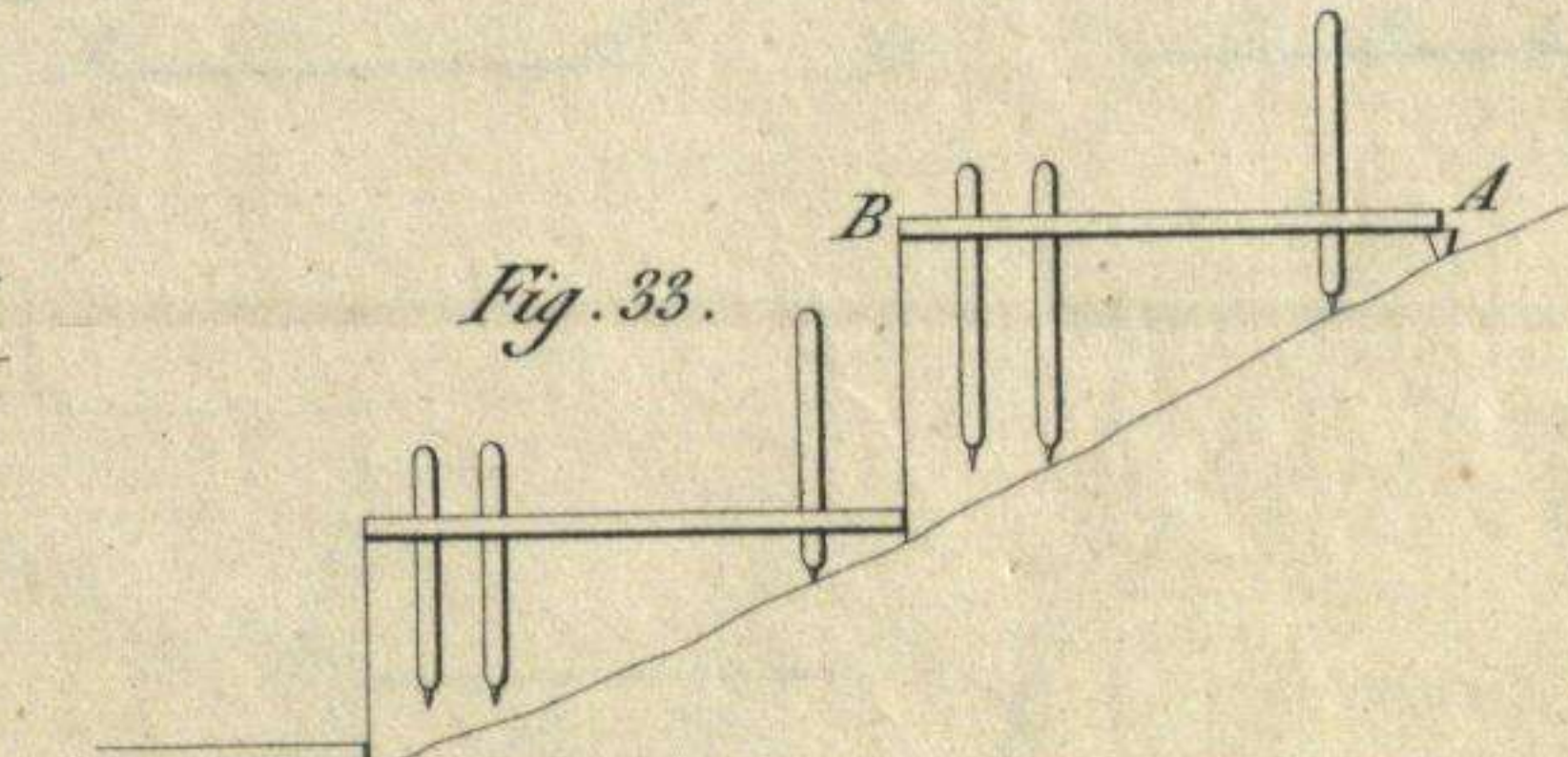
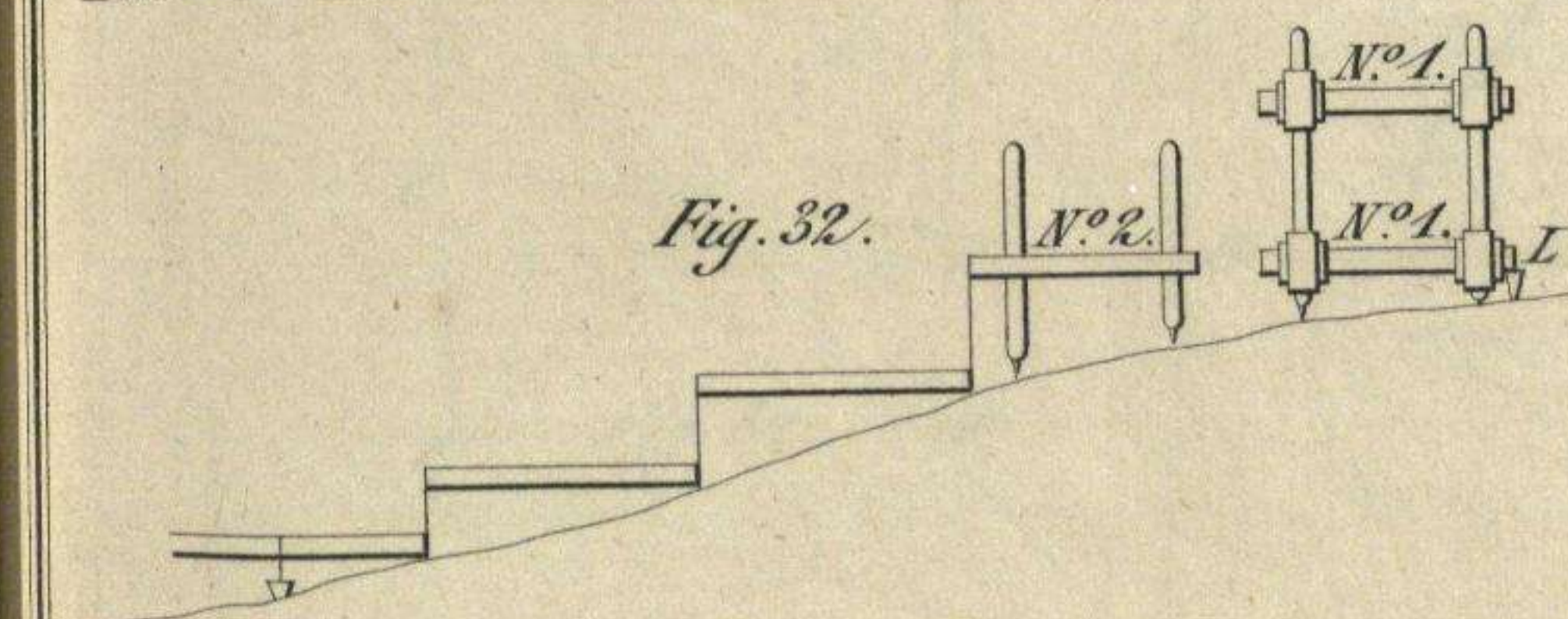
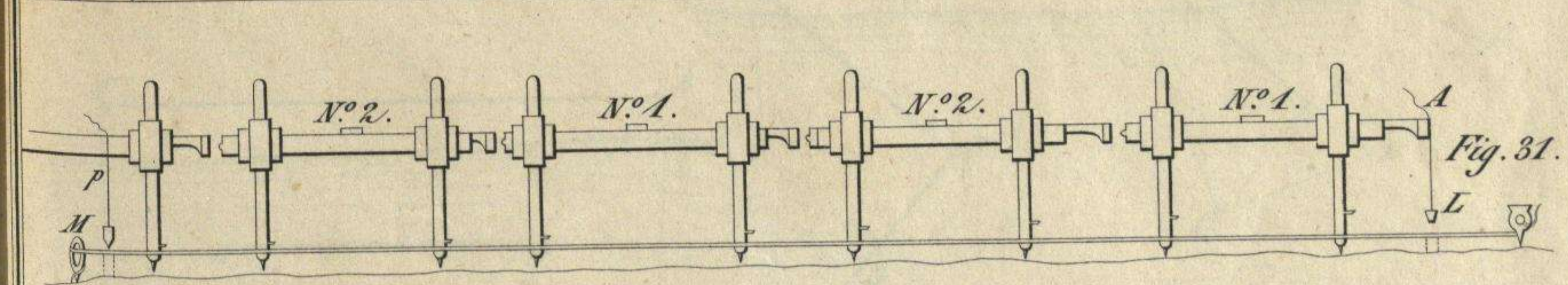
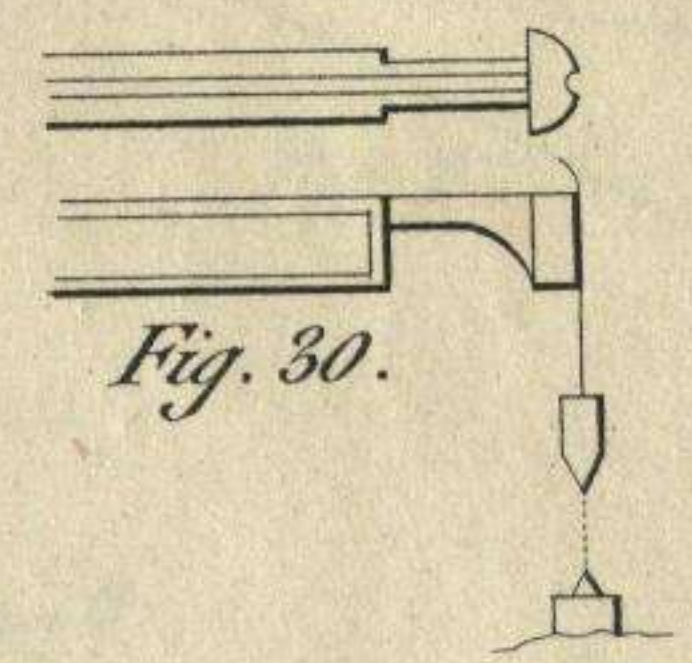
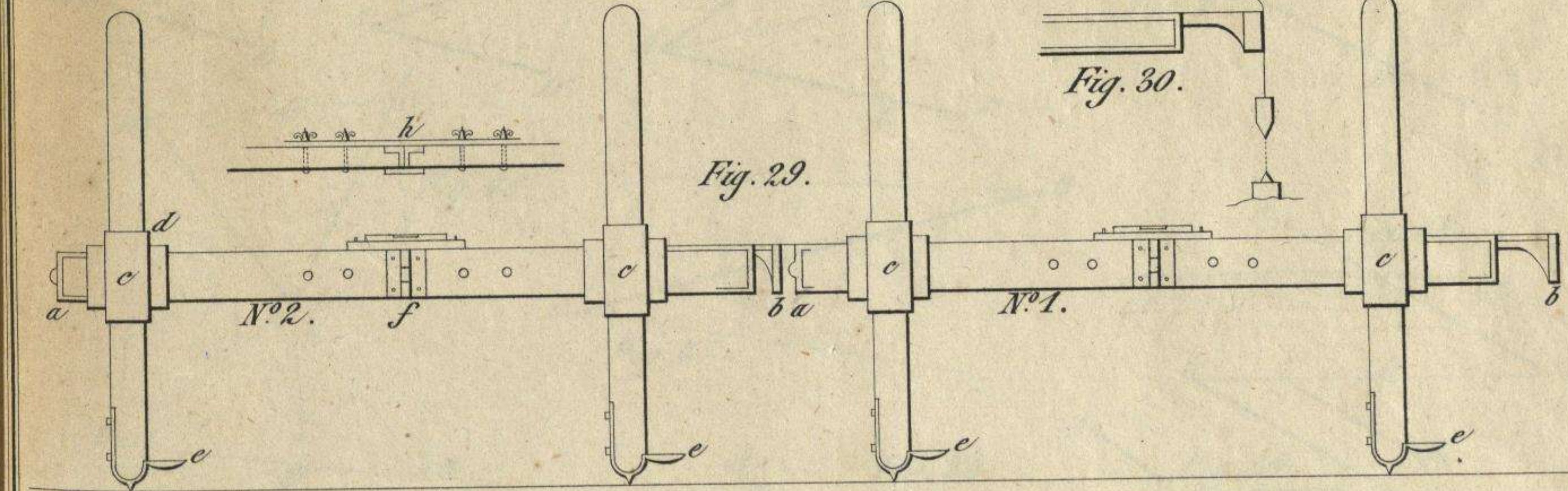
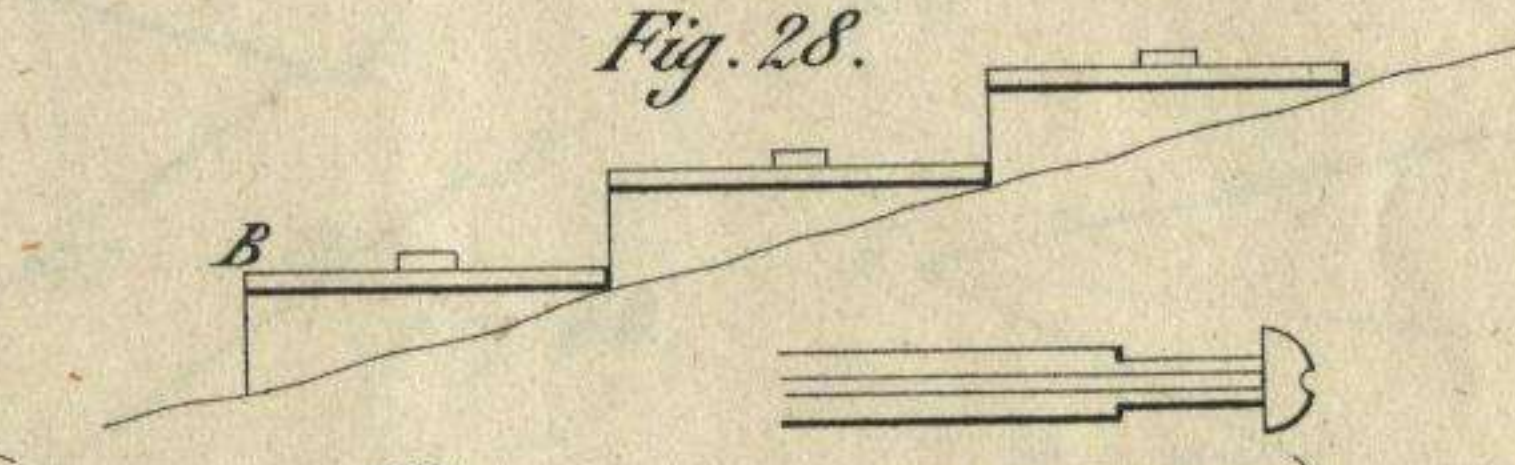
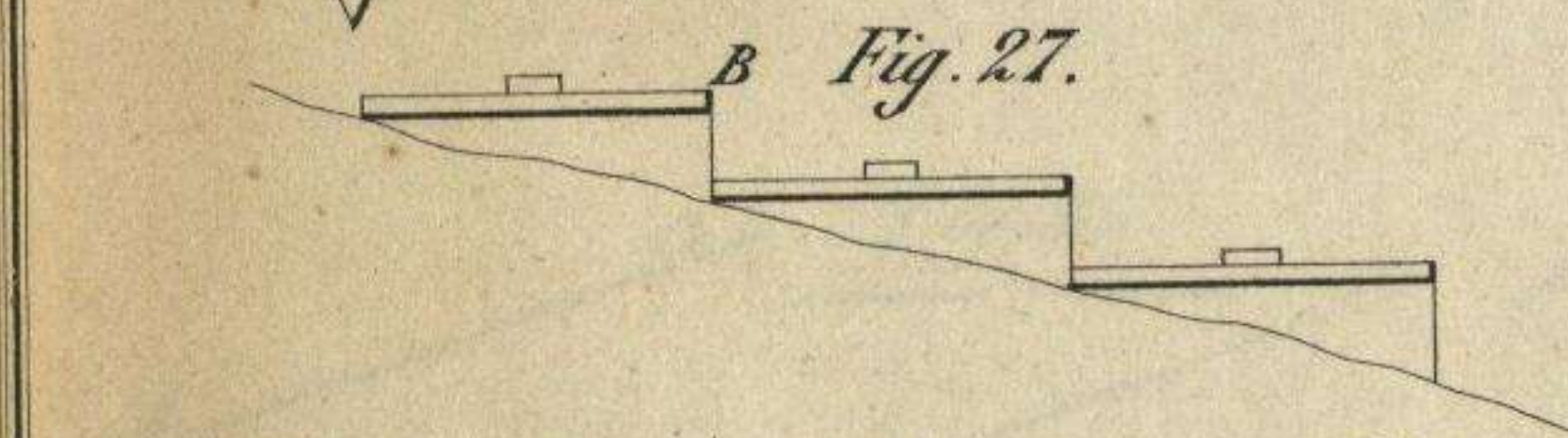
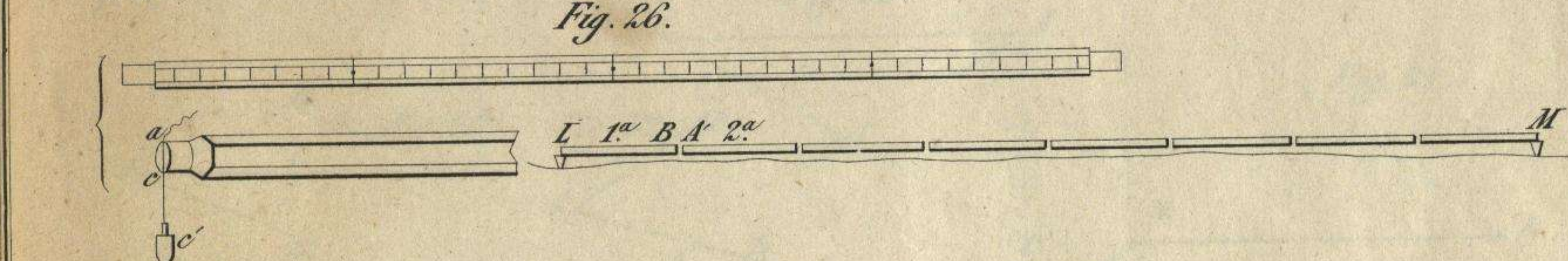
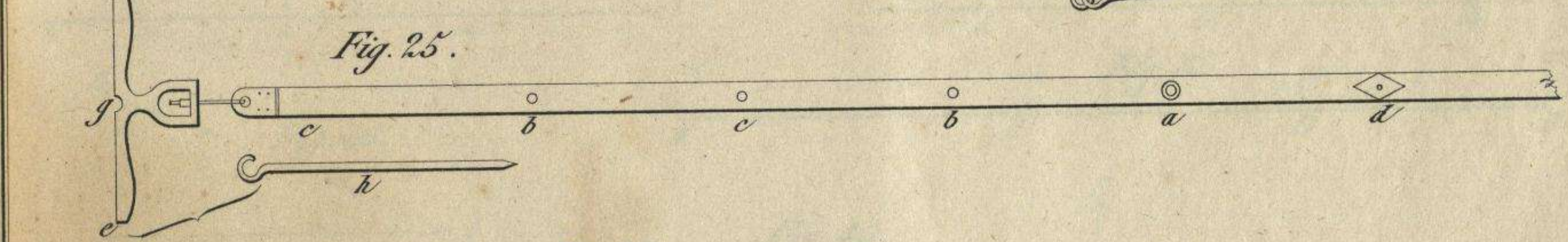
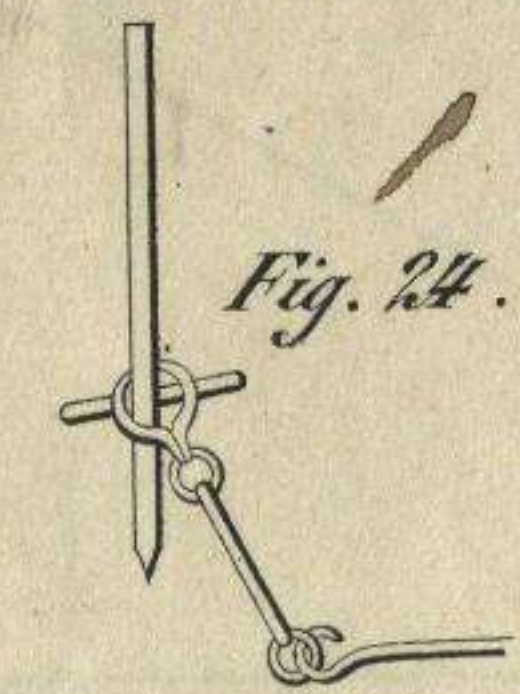
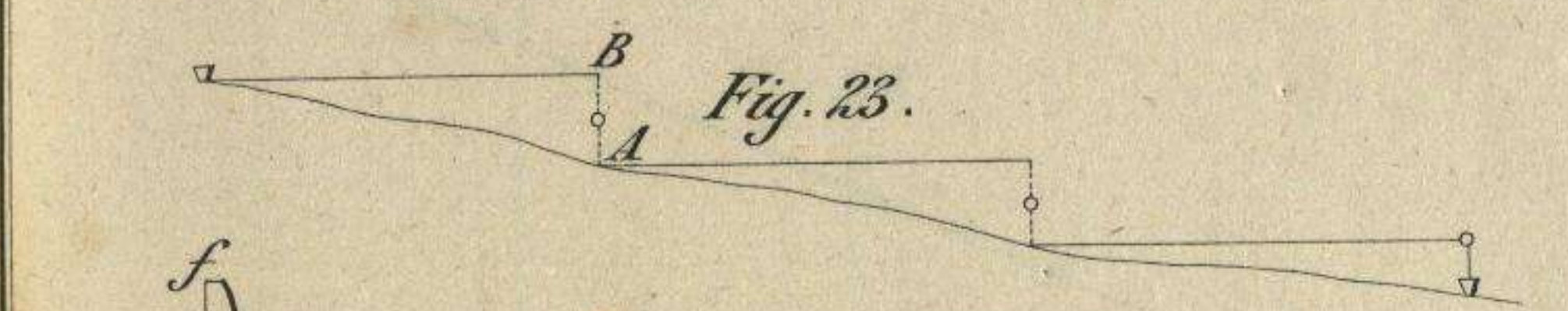
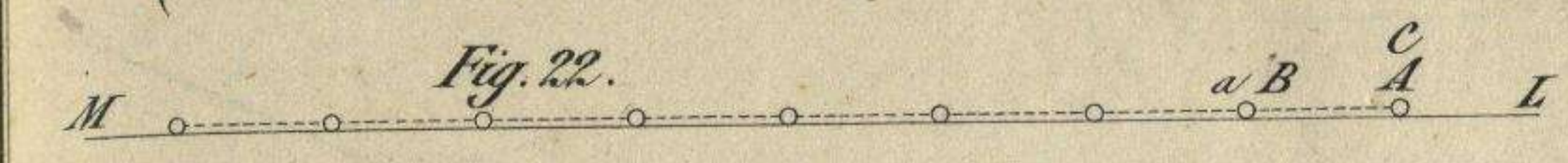
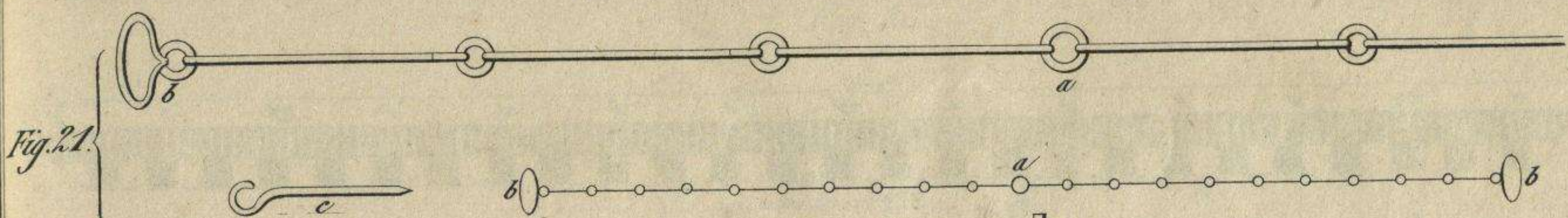

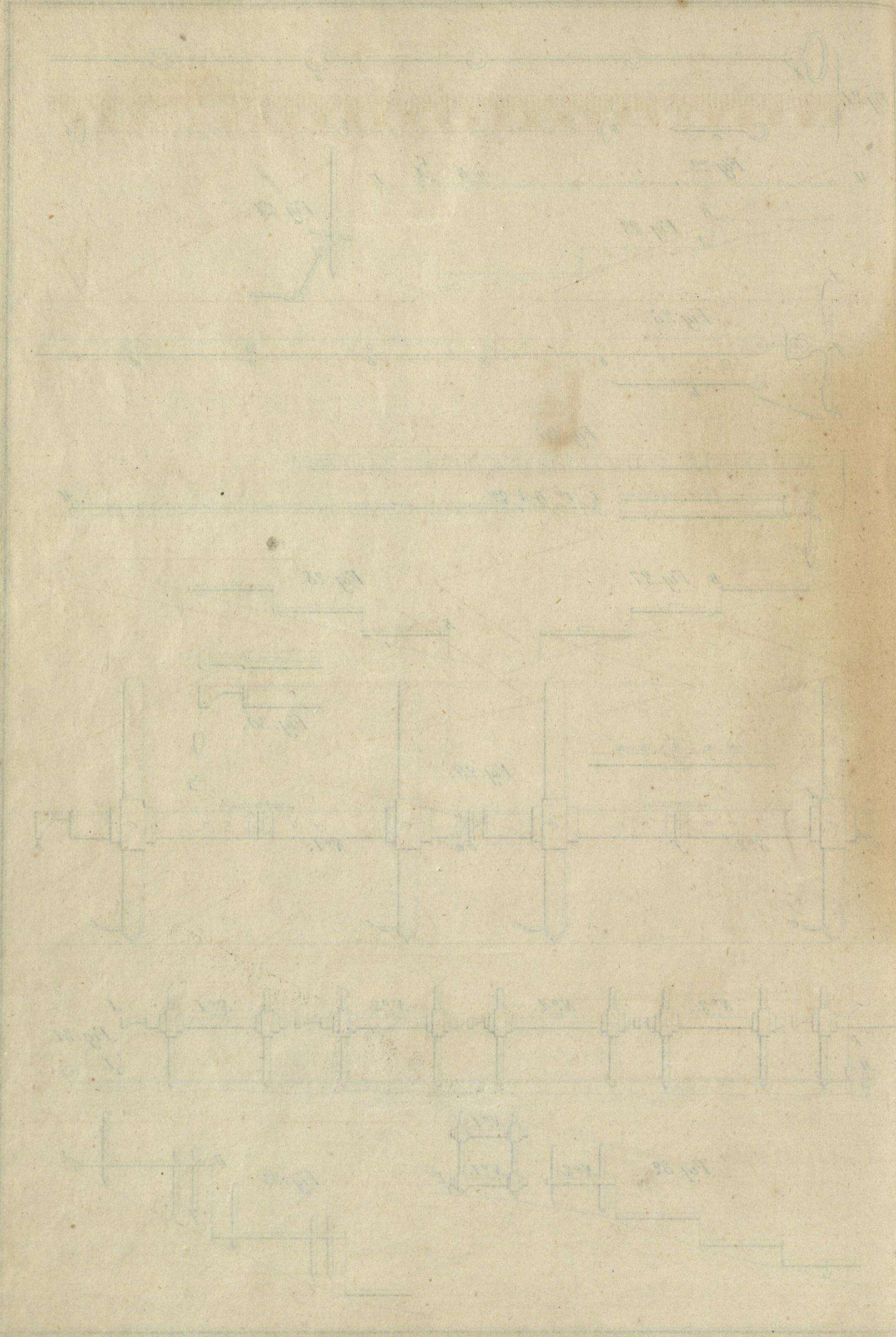

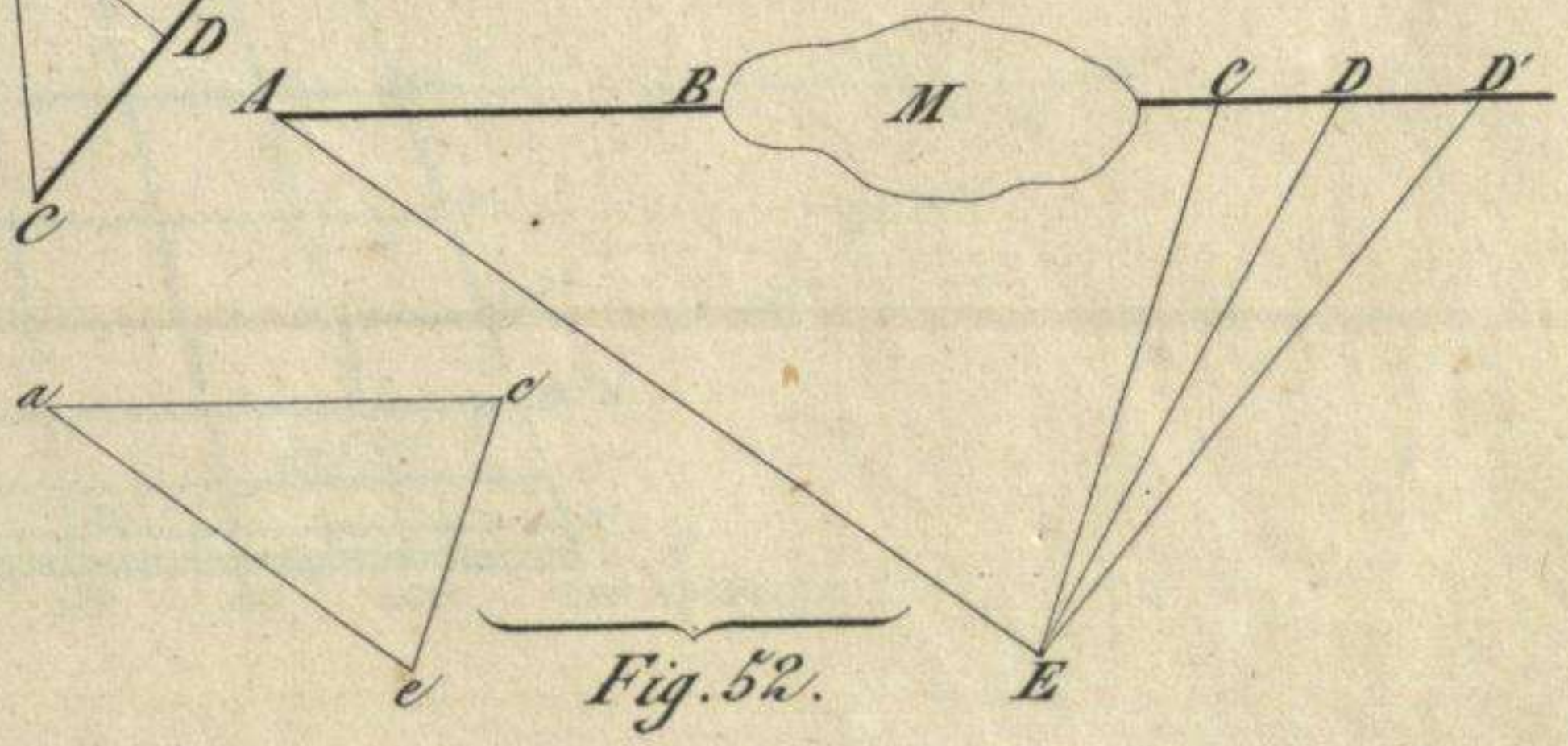
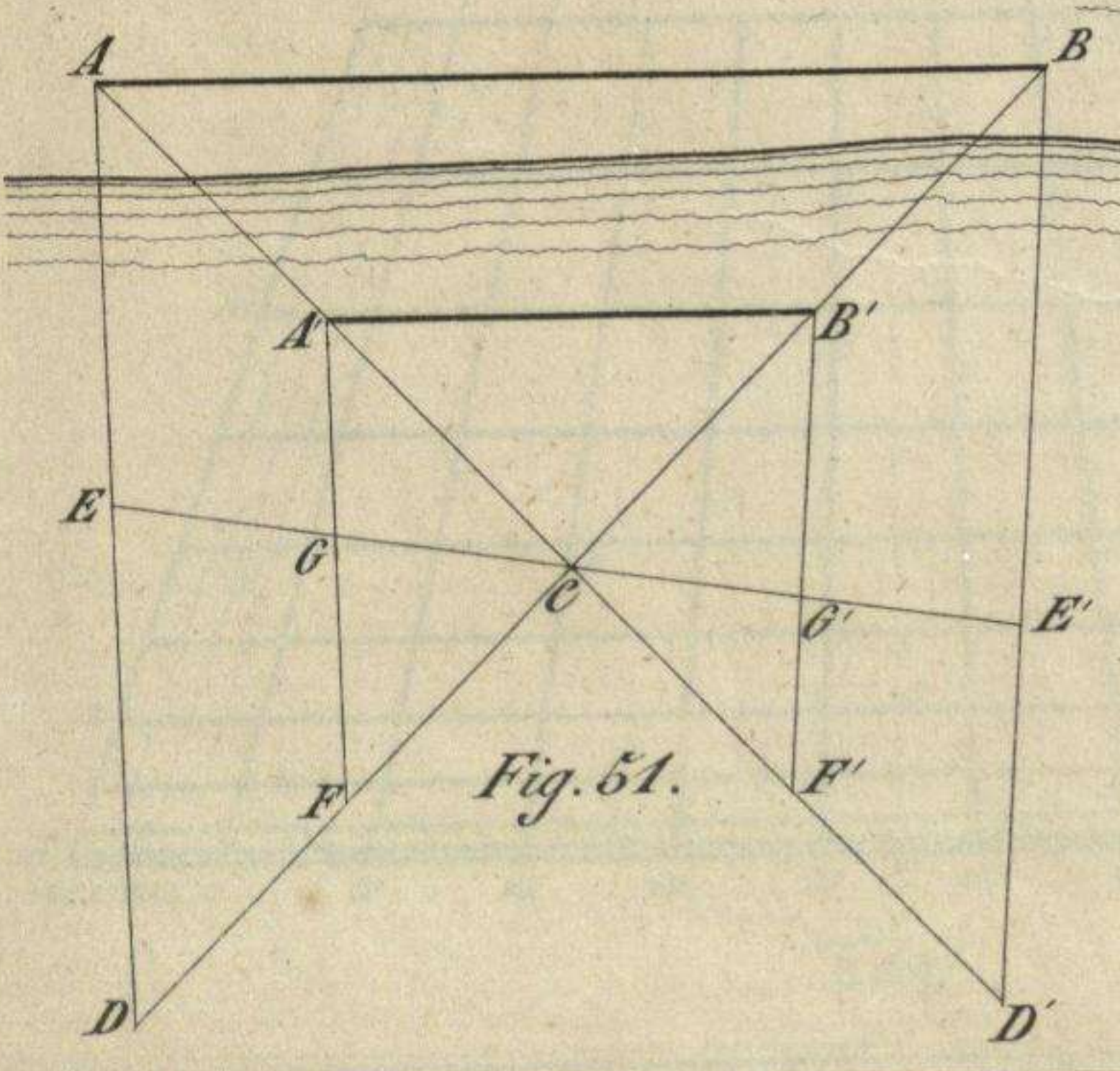
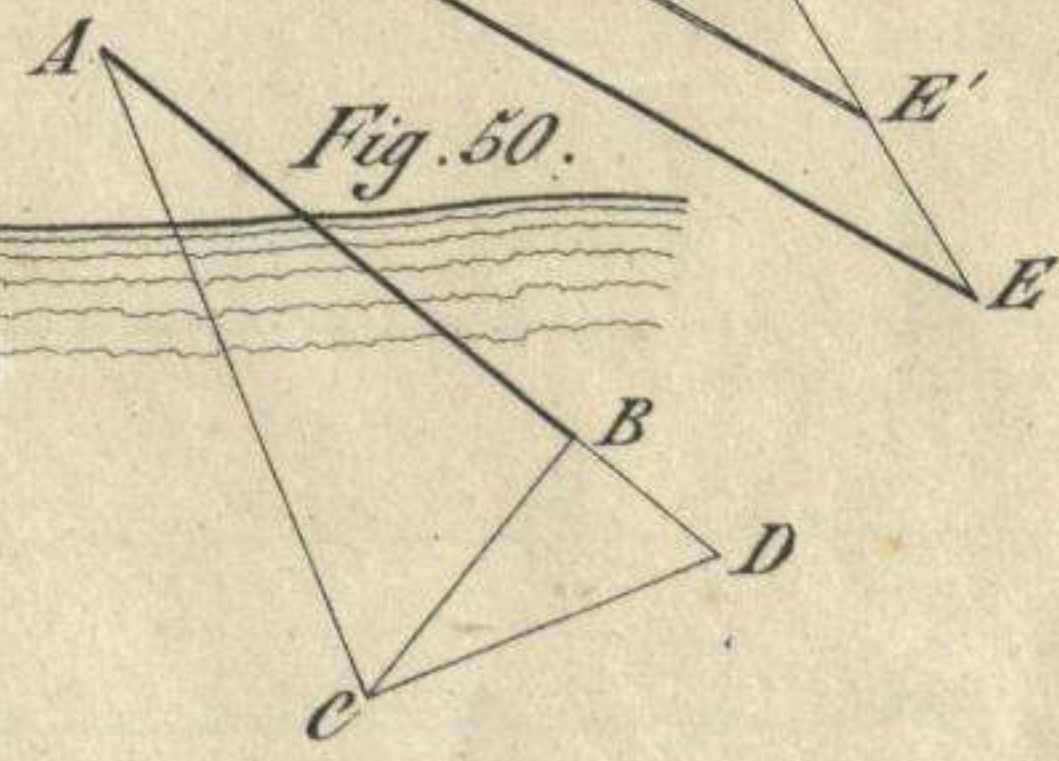
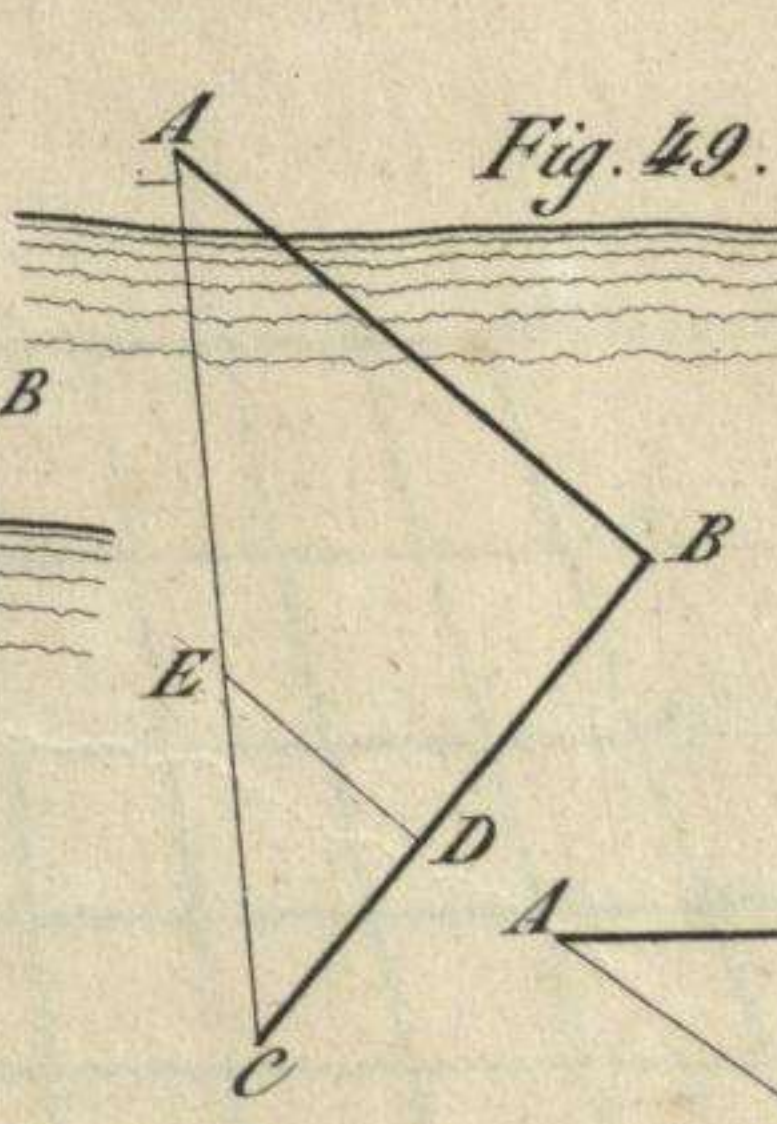
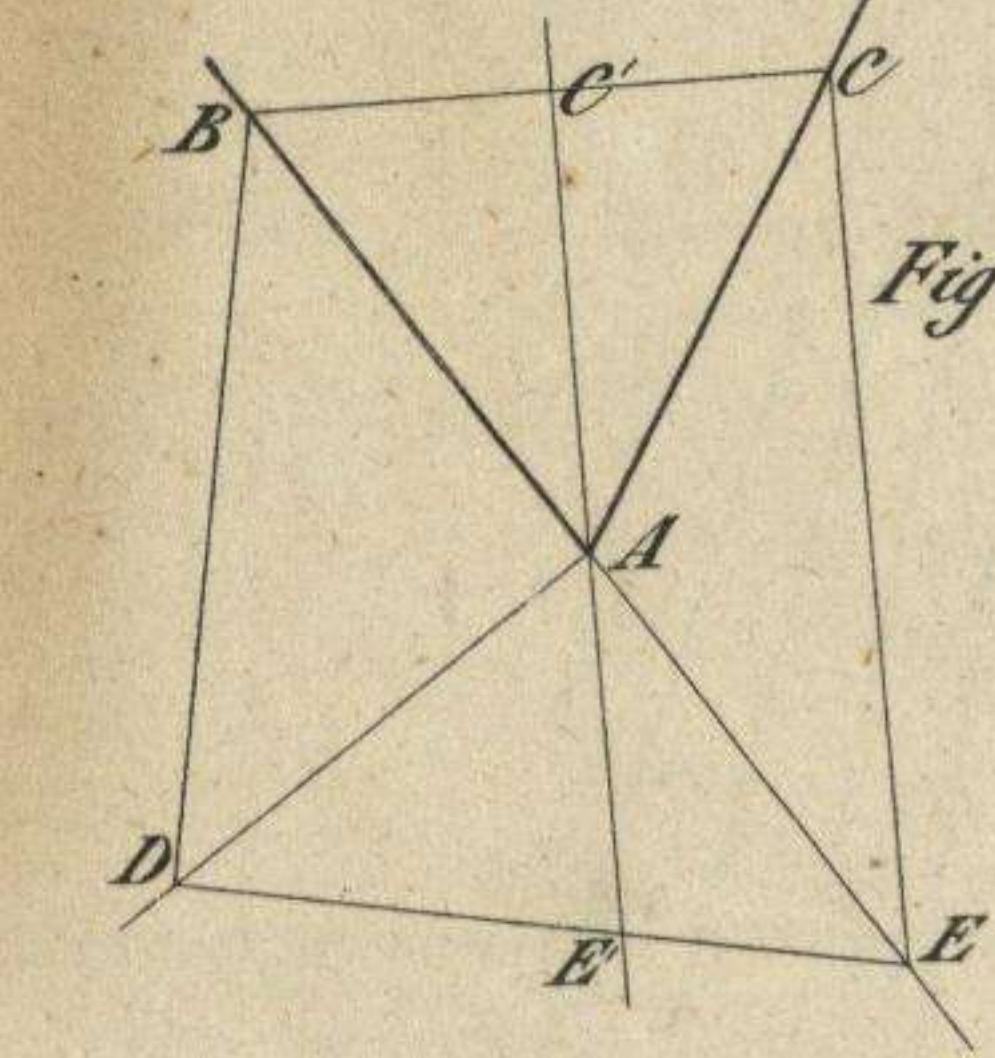
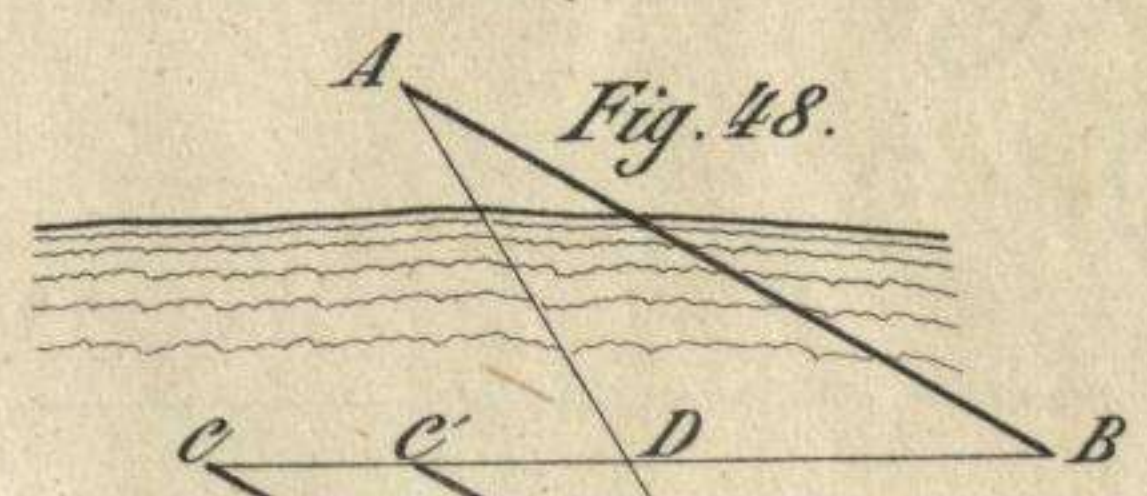
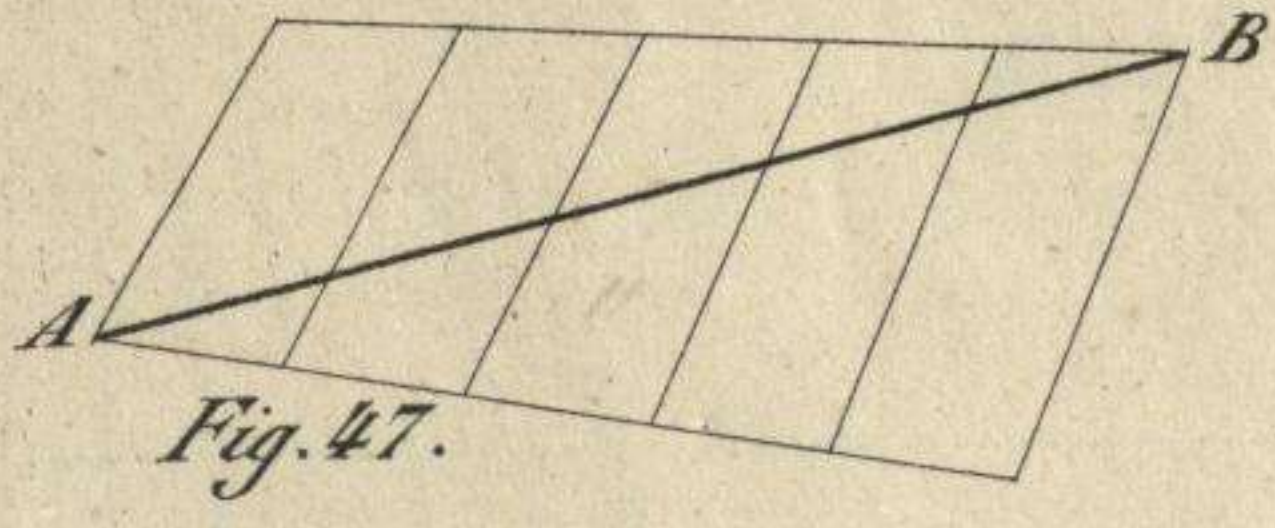
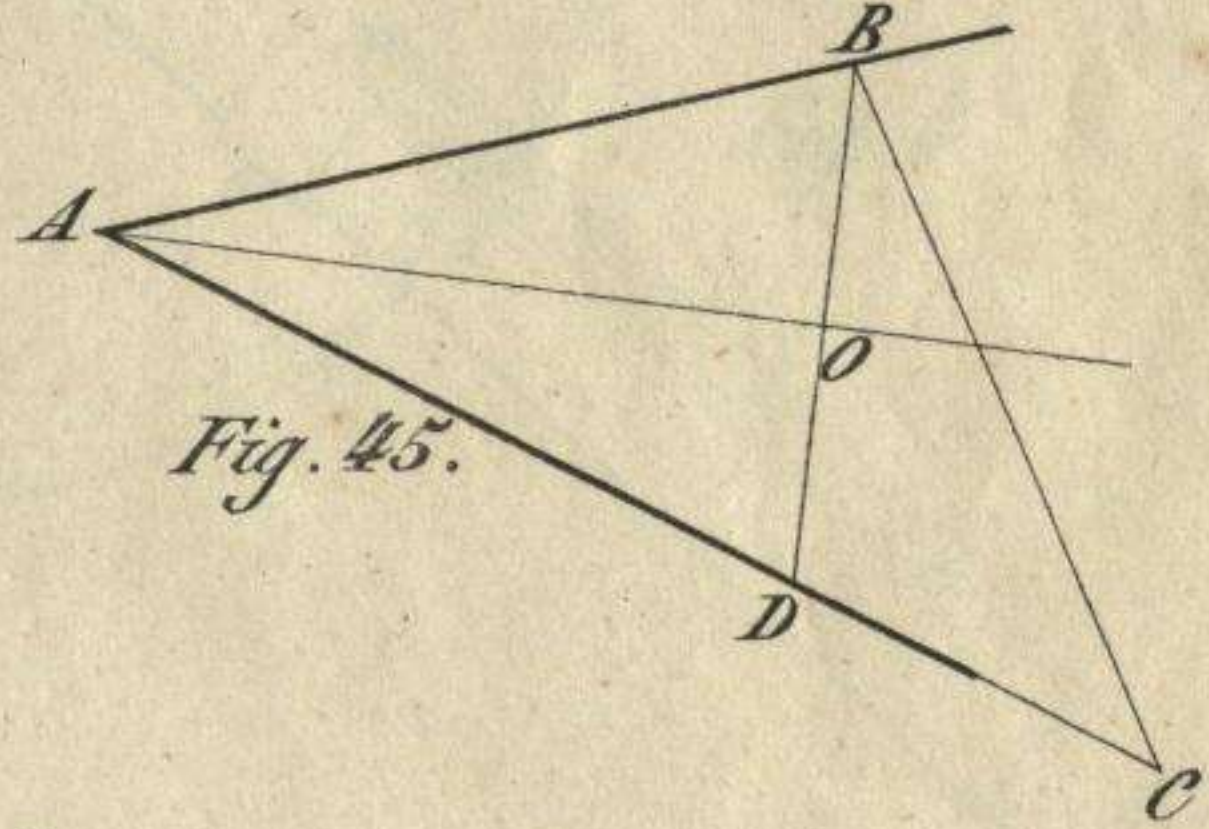
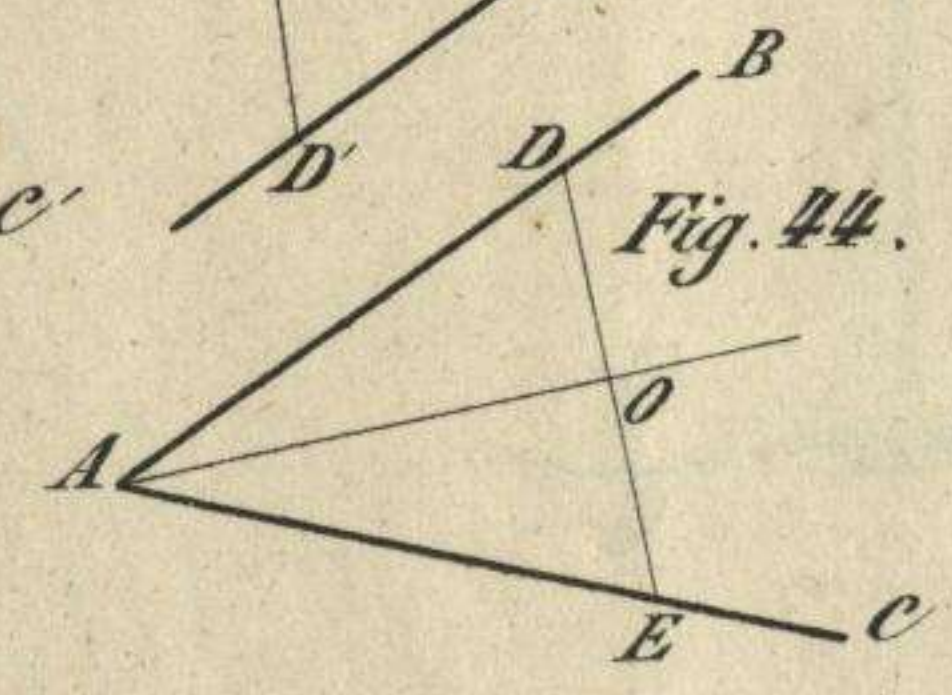
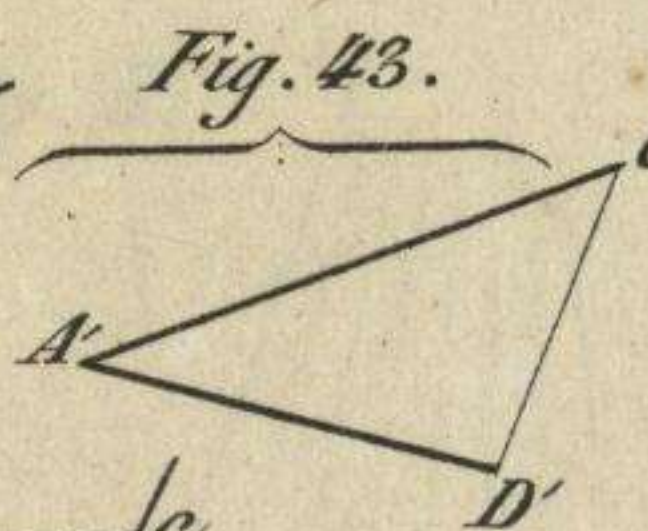
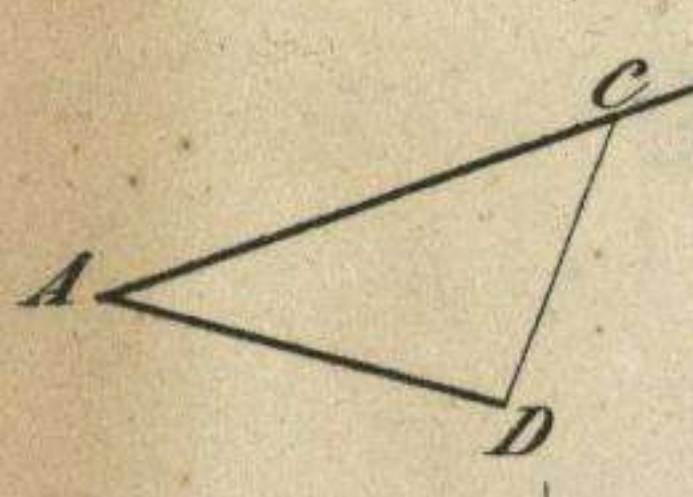
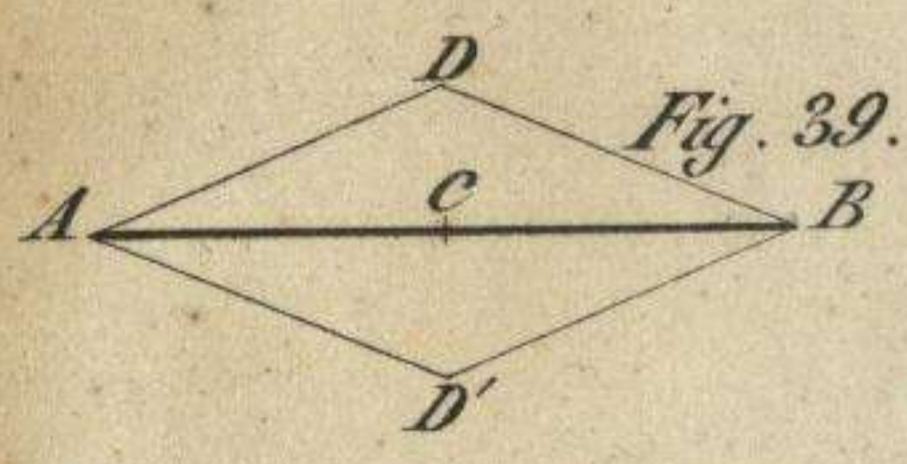
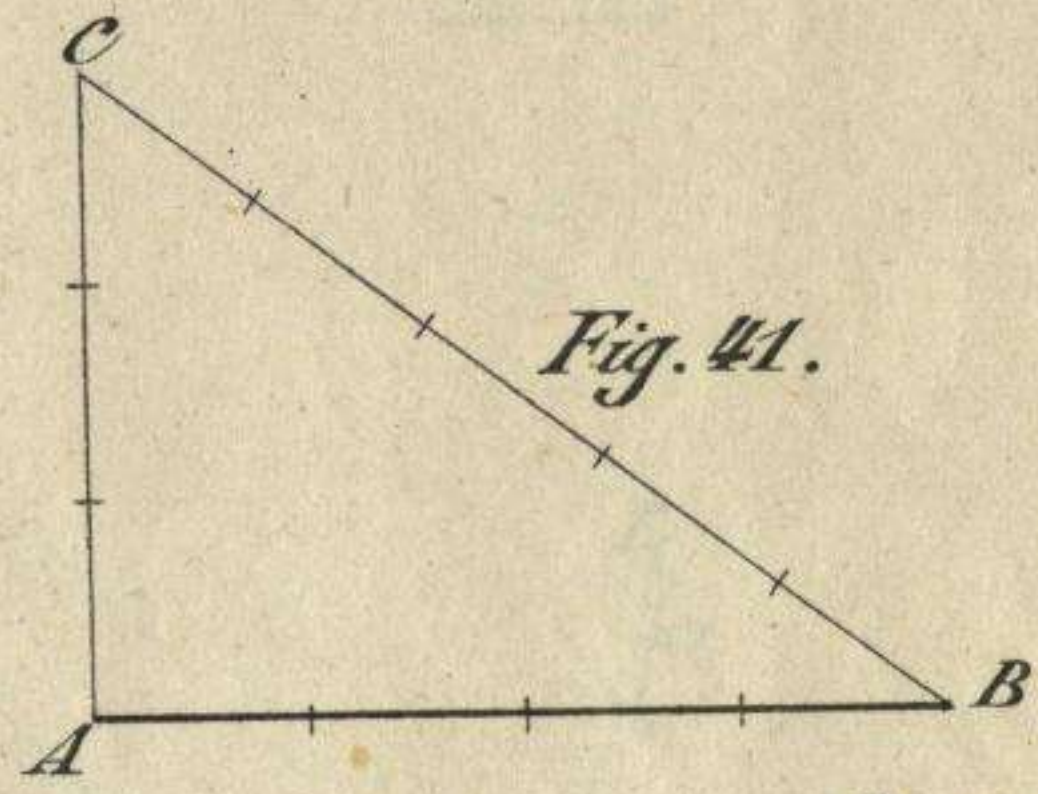
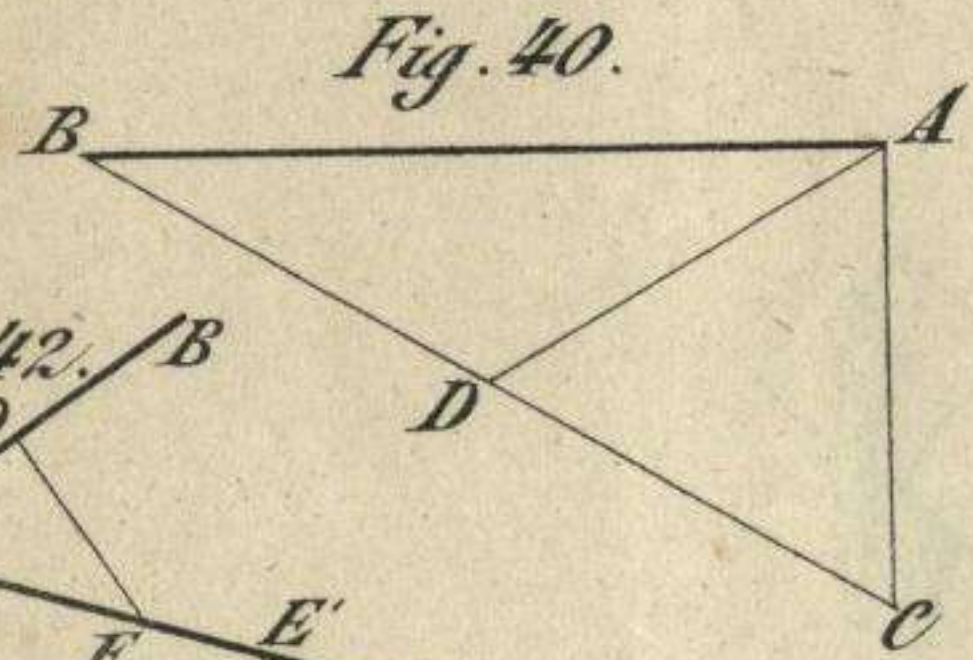
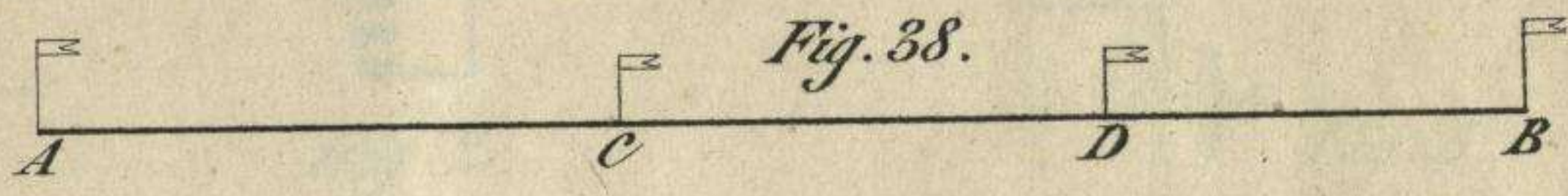
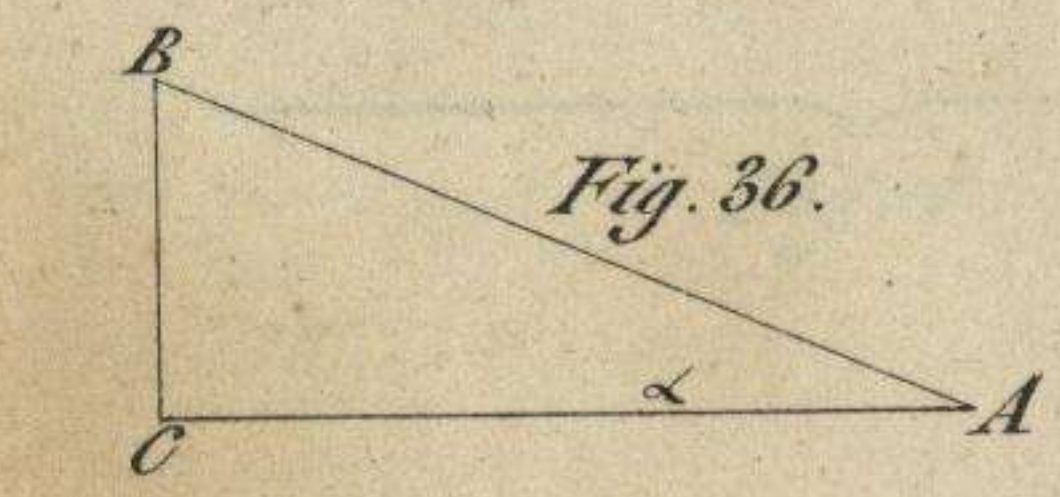
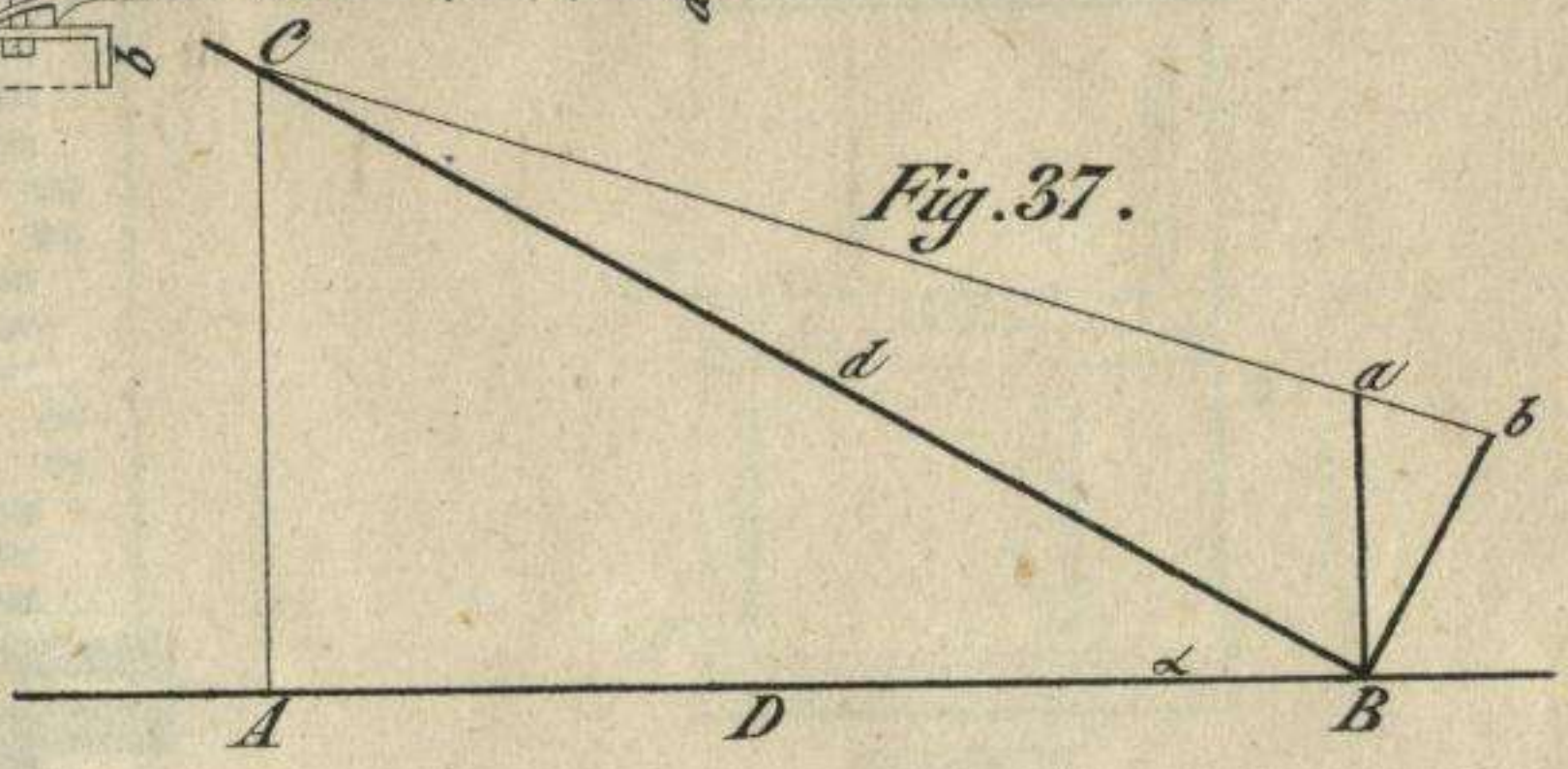
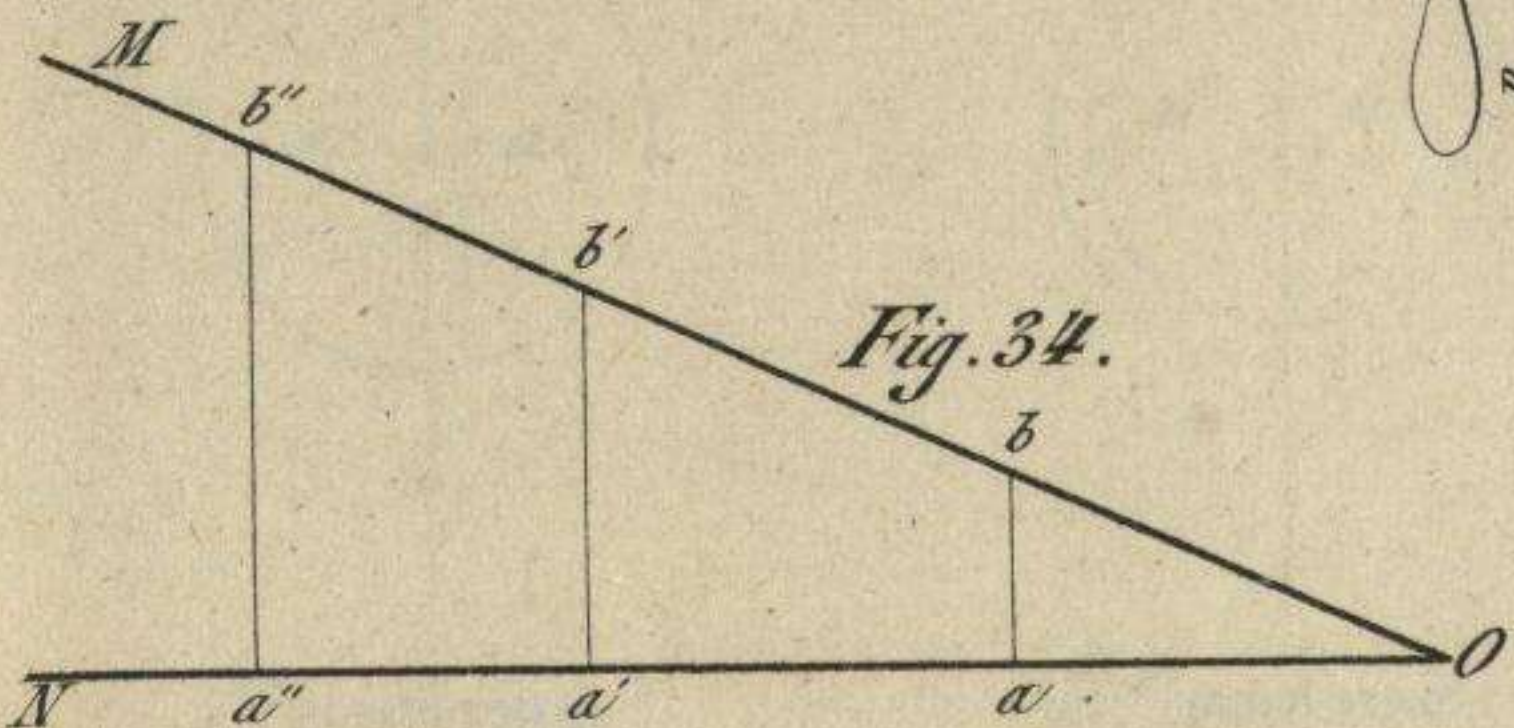
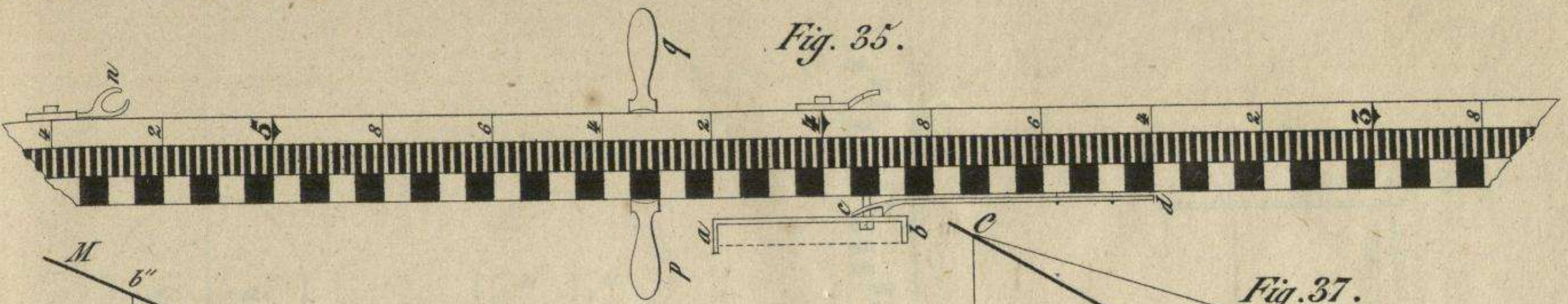
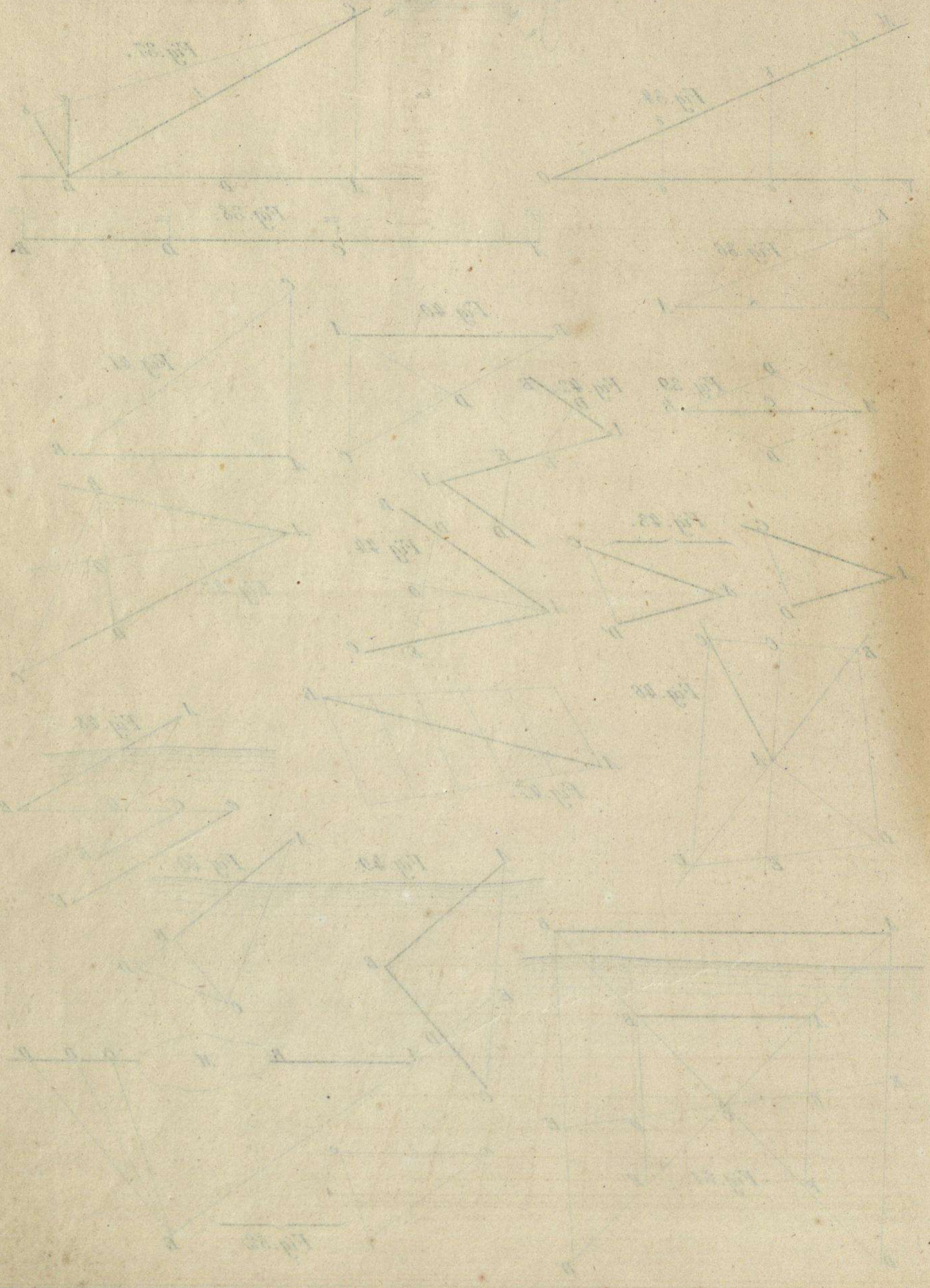
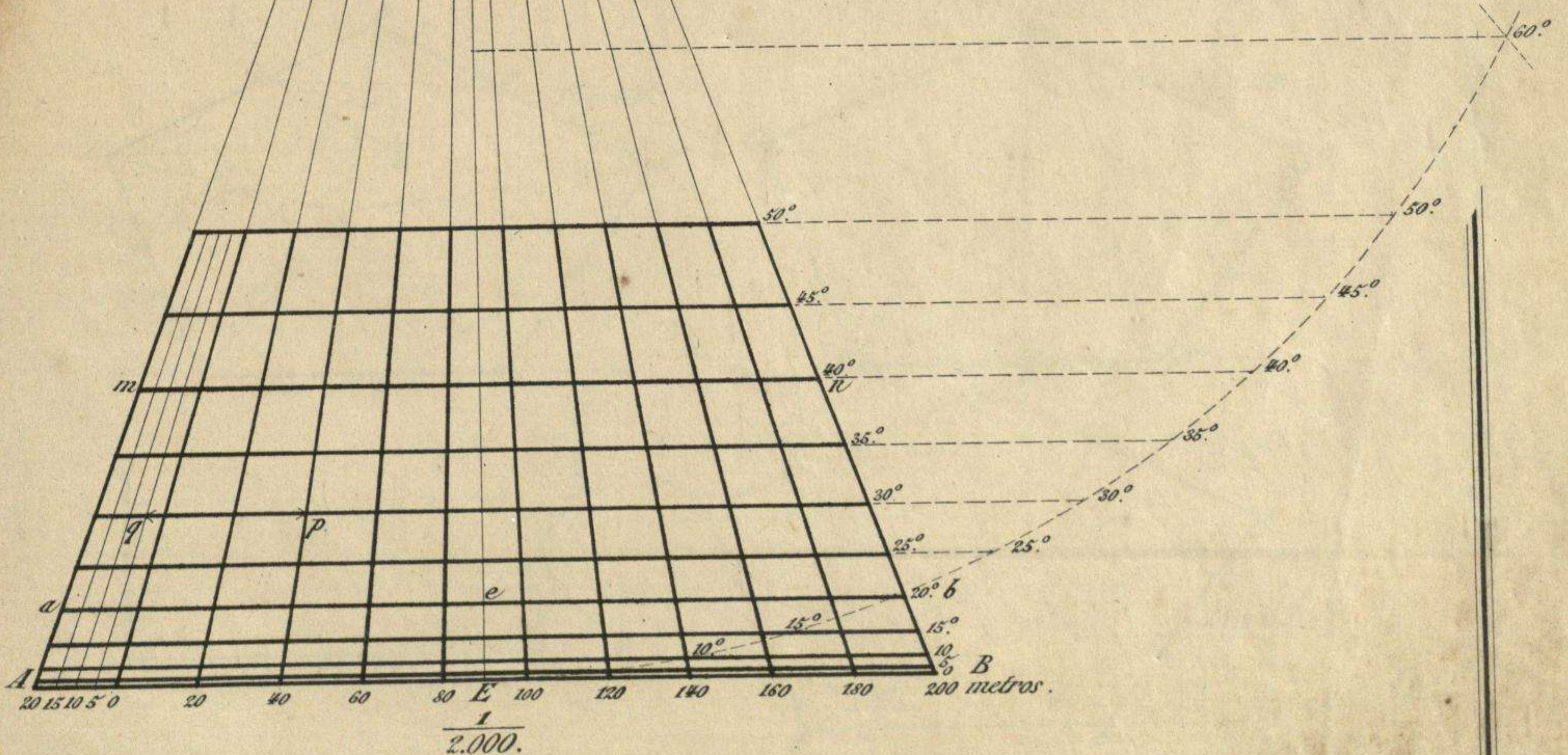
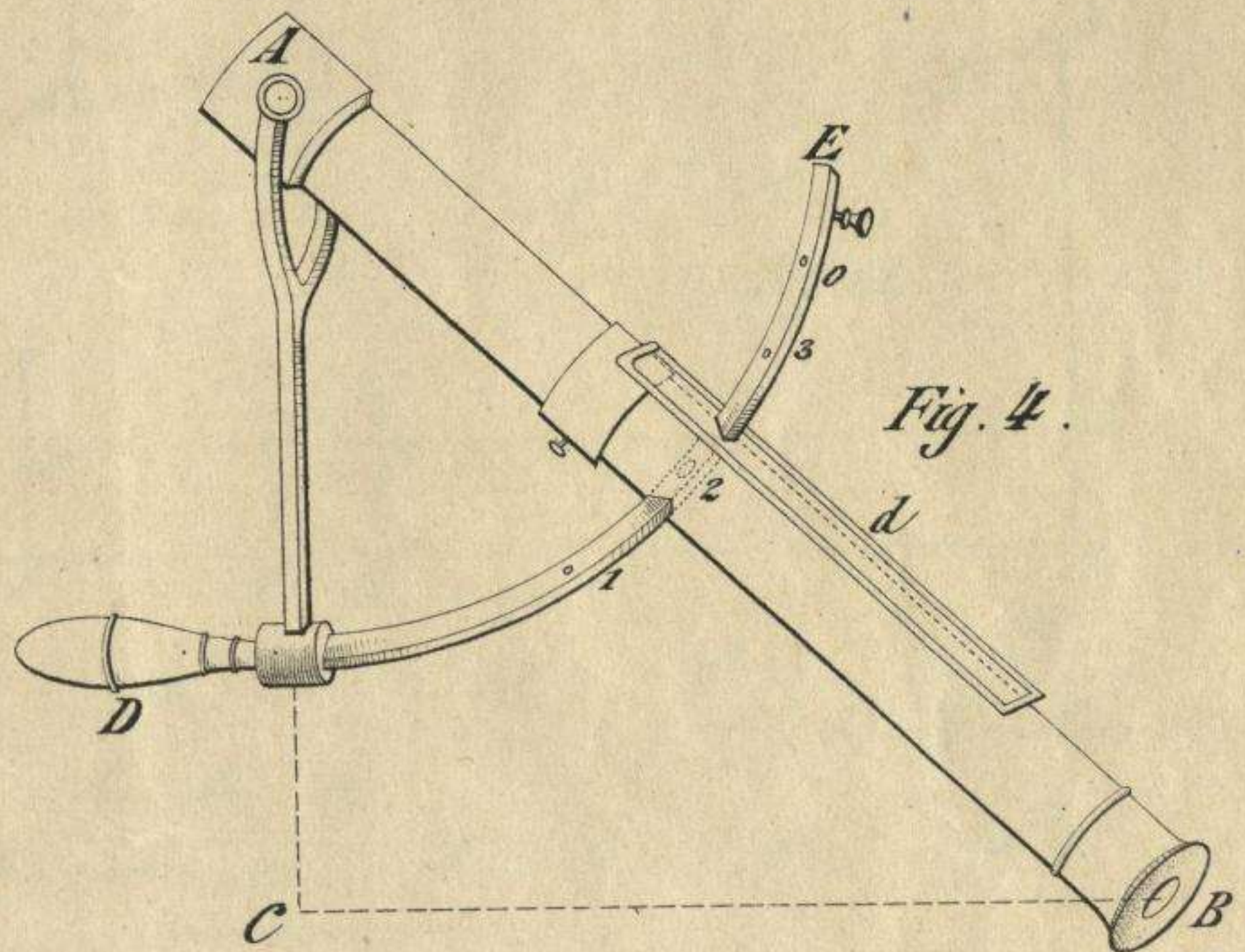
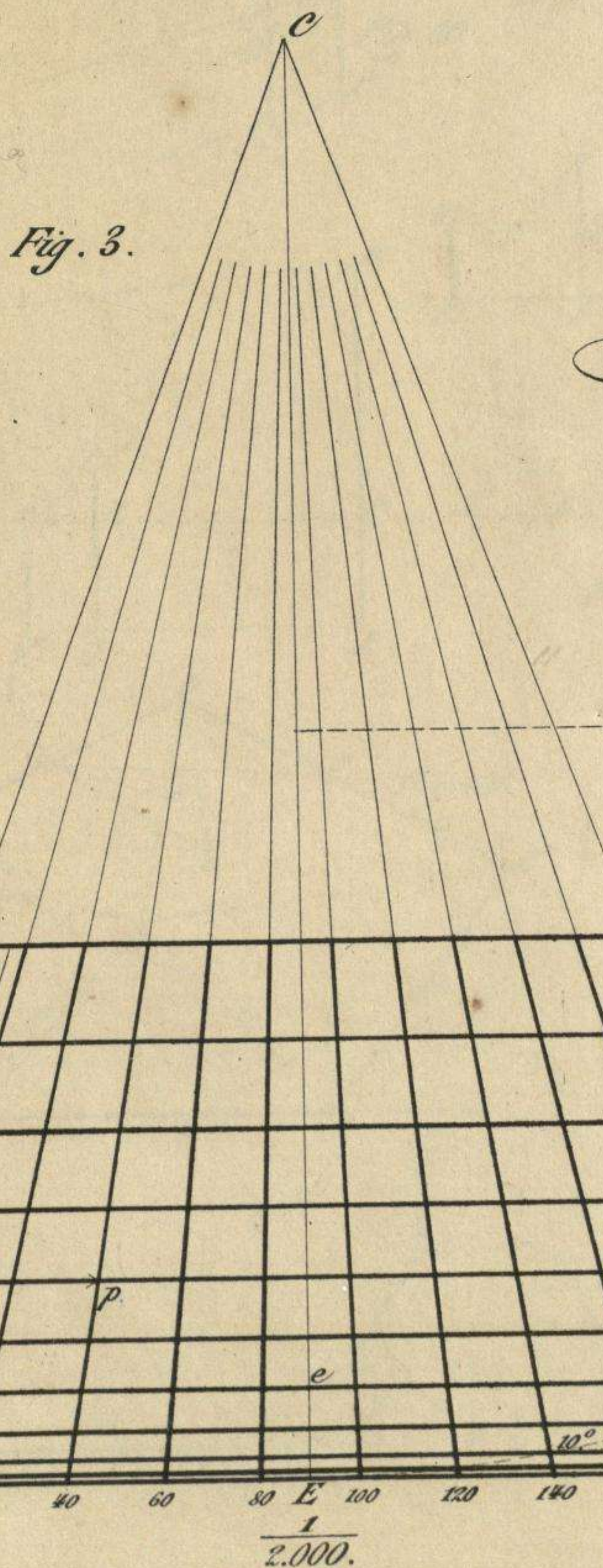
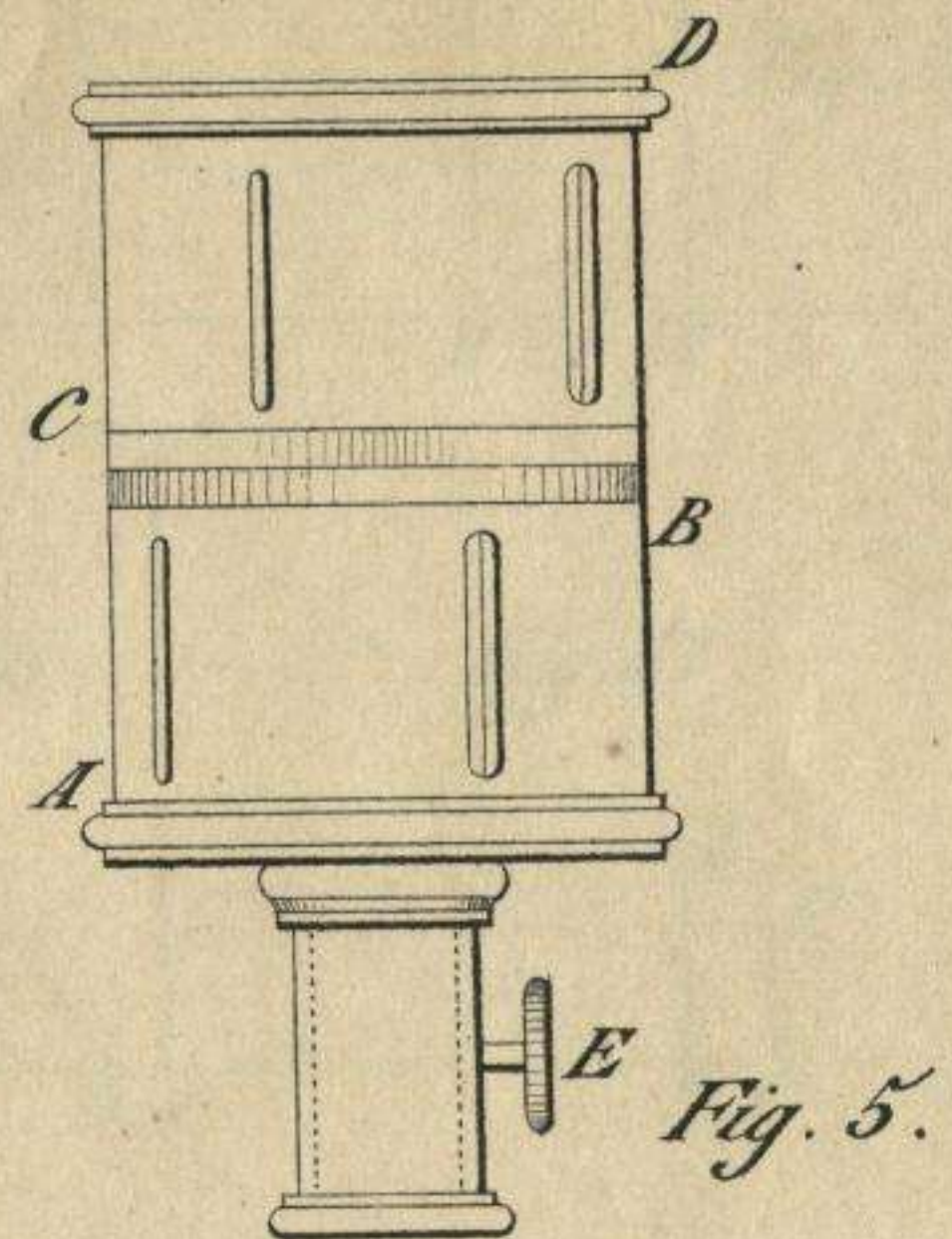
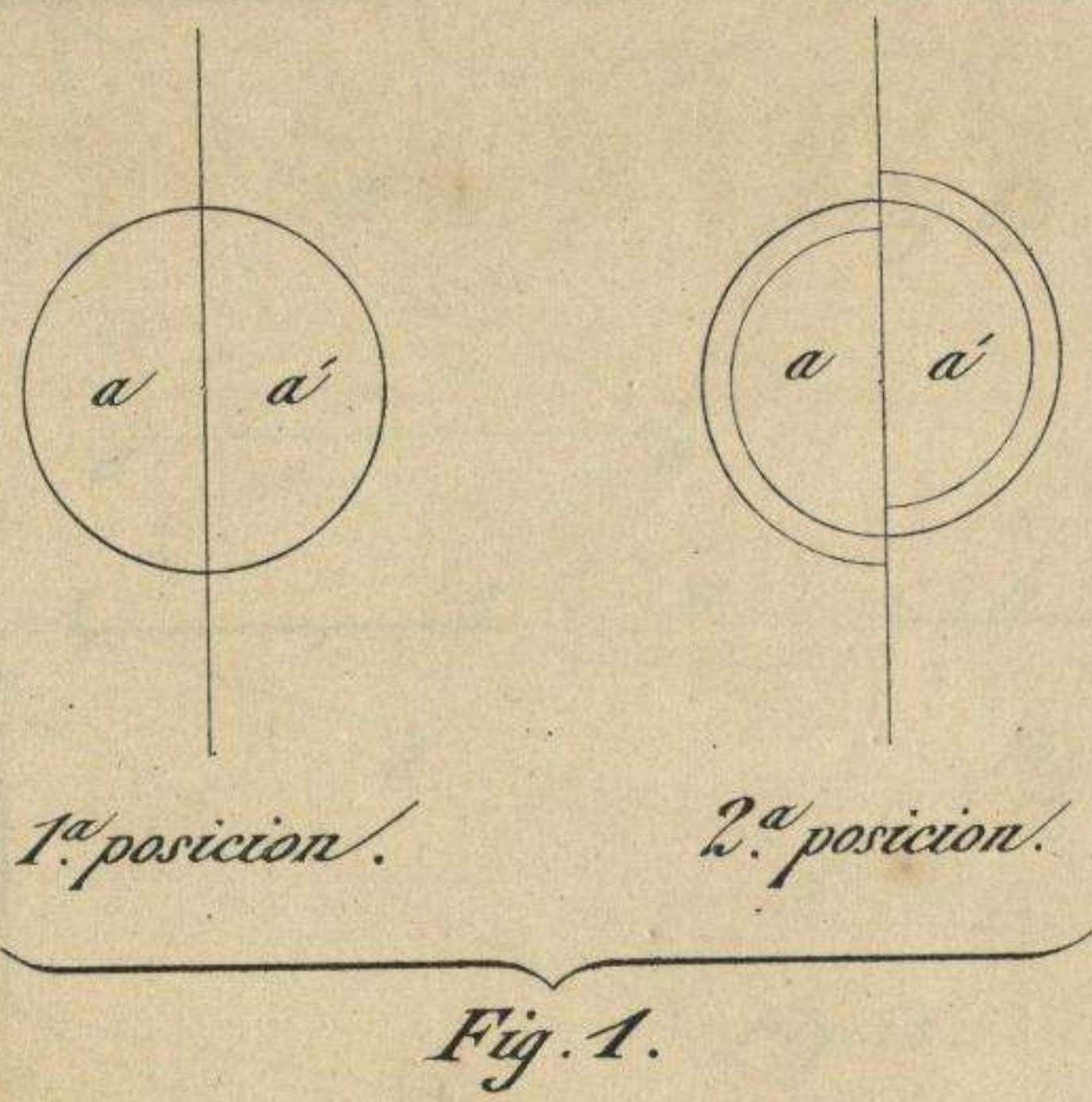
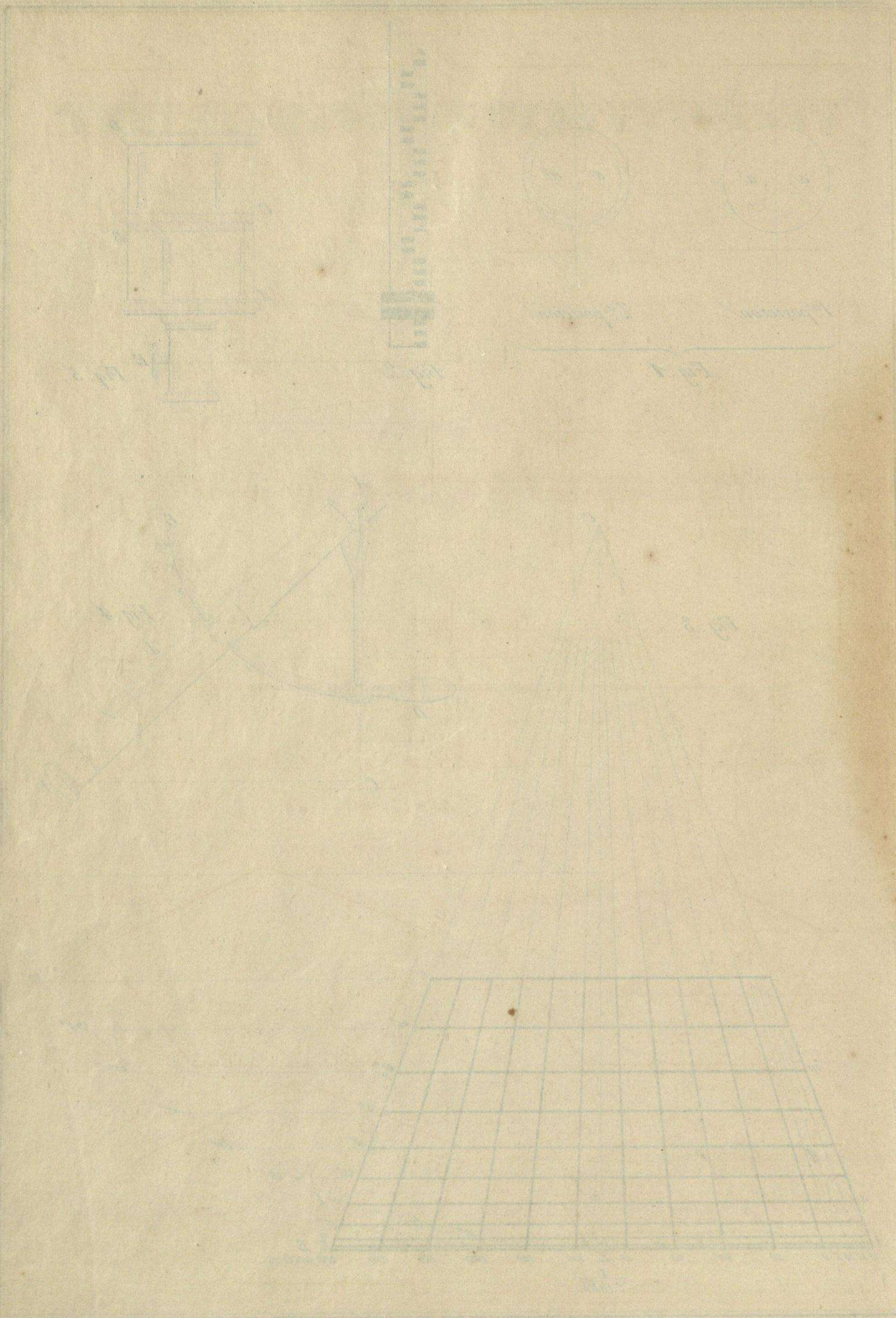

Fig 31







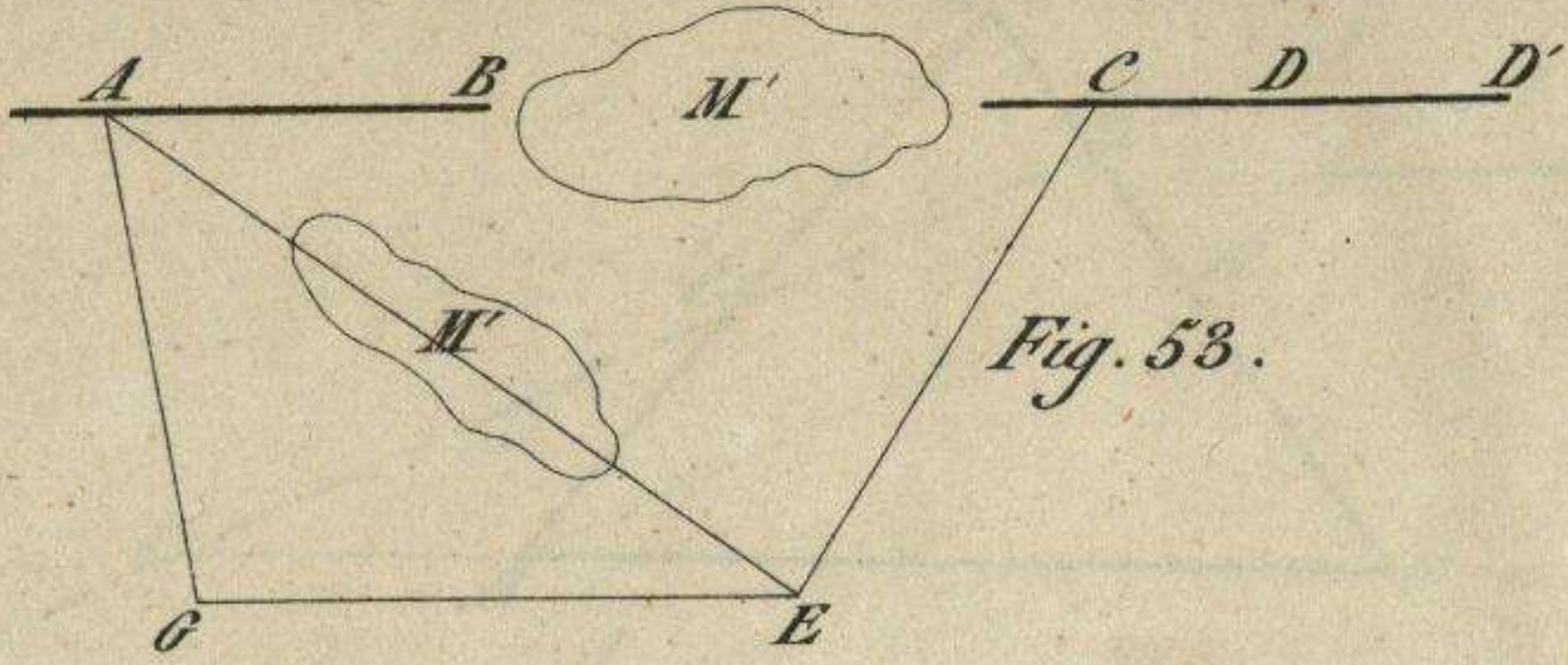

Fig. 53.

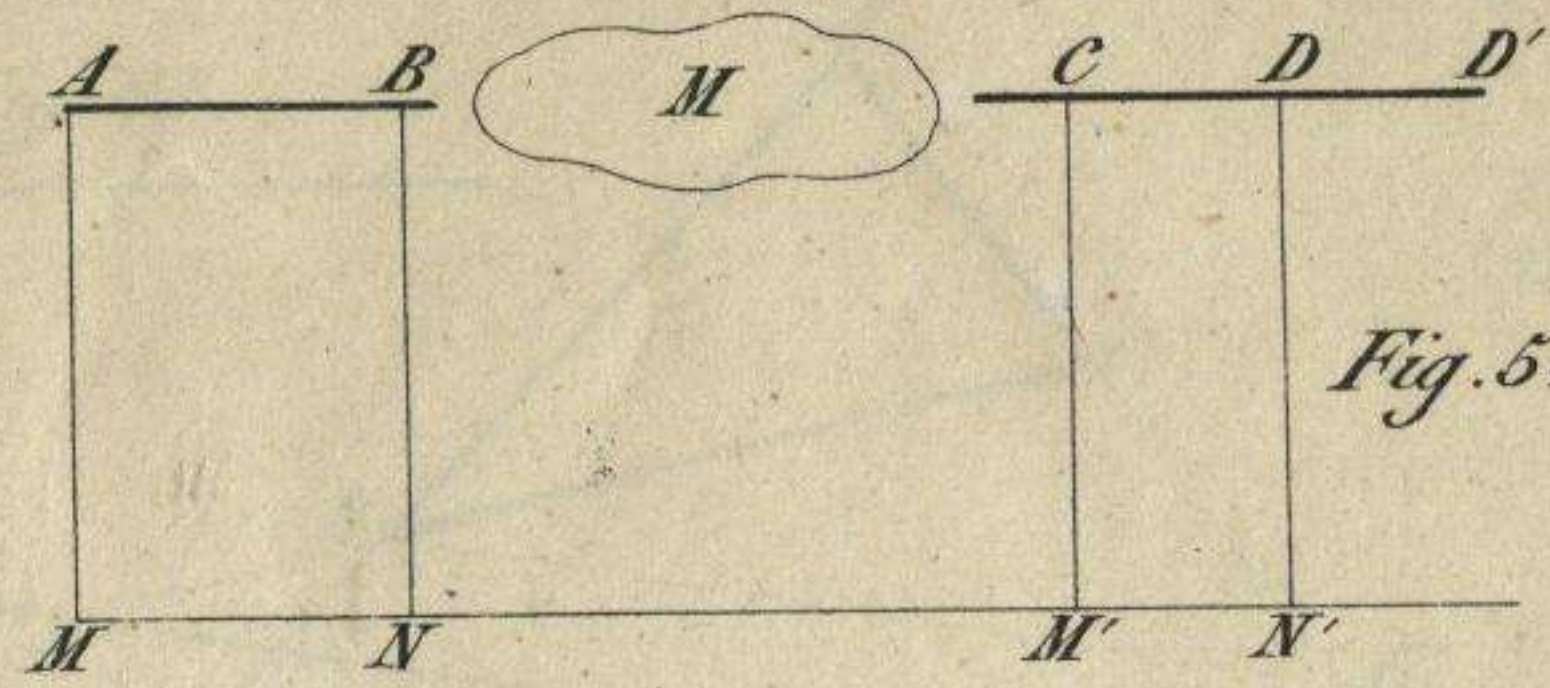

Fig. 54.

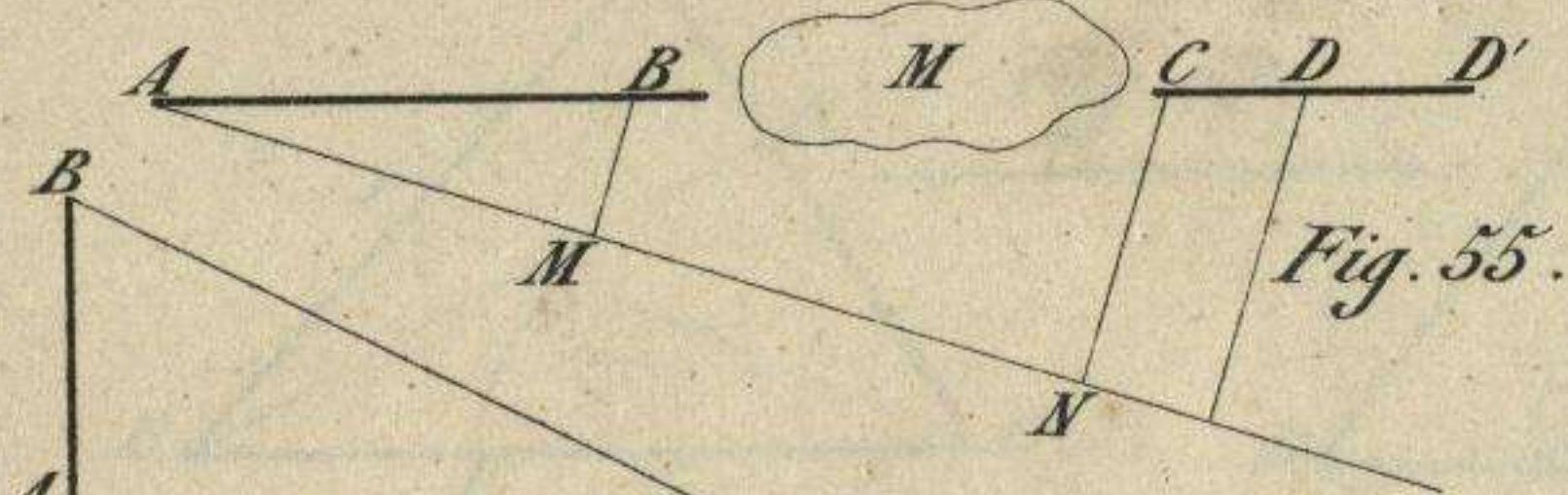

Fig. 55.

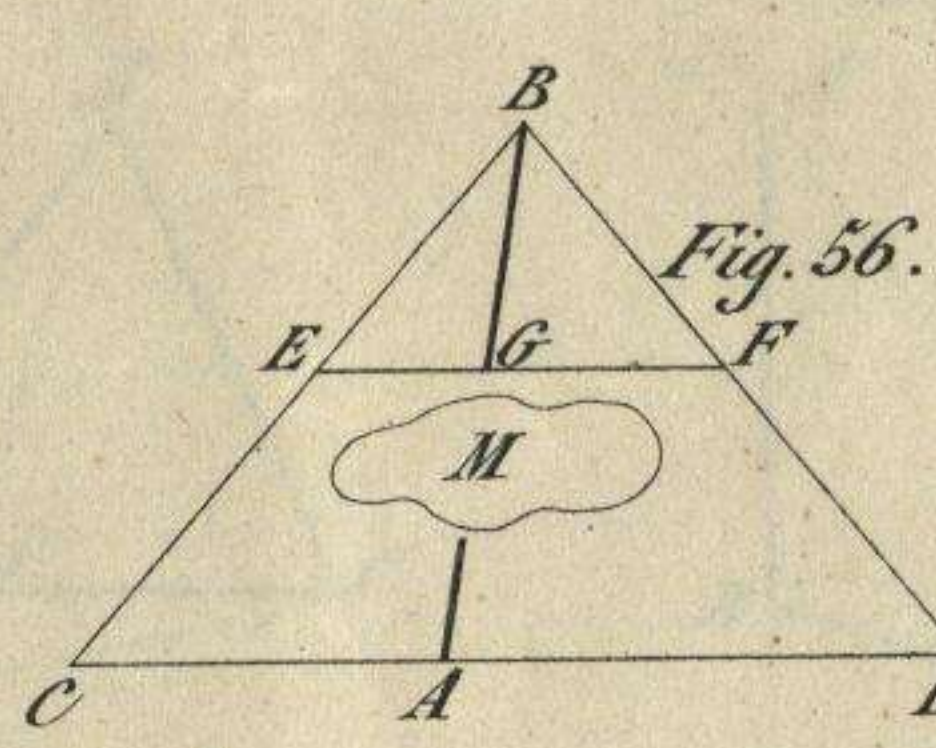

Fig. 56.

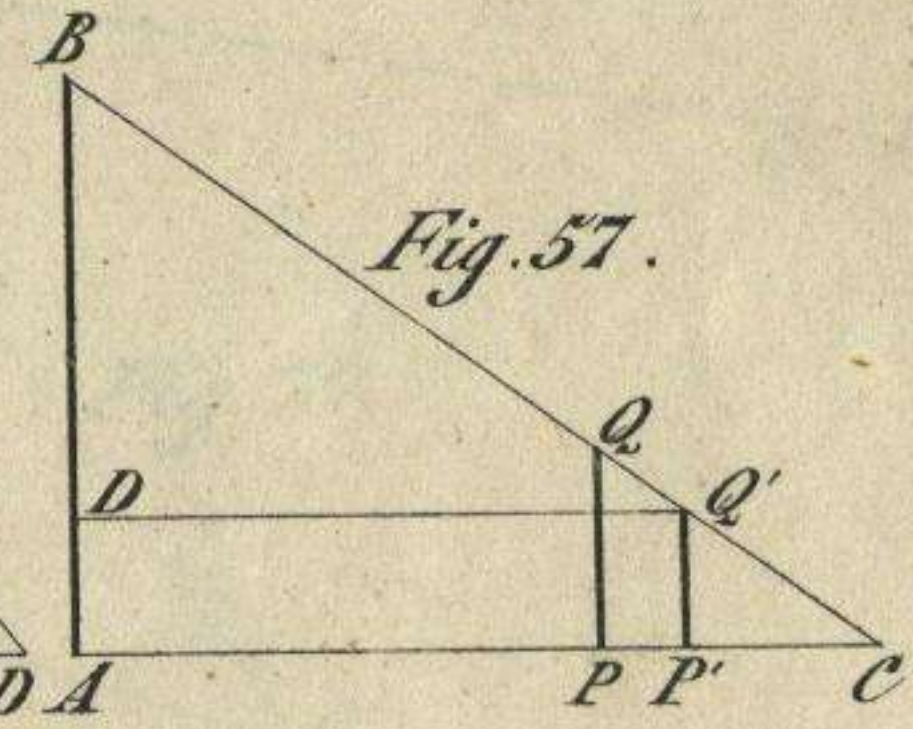

Fig. 57.

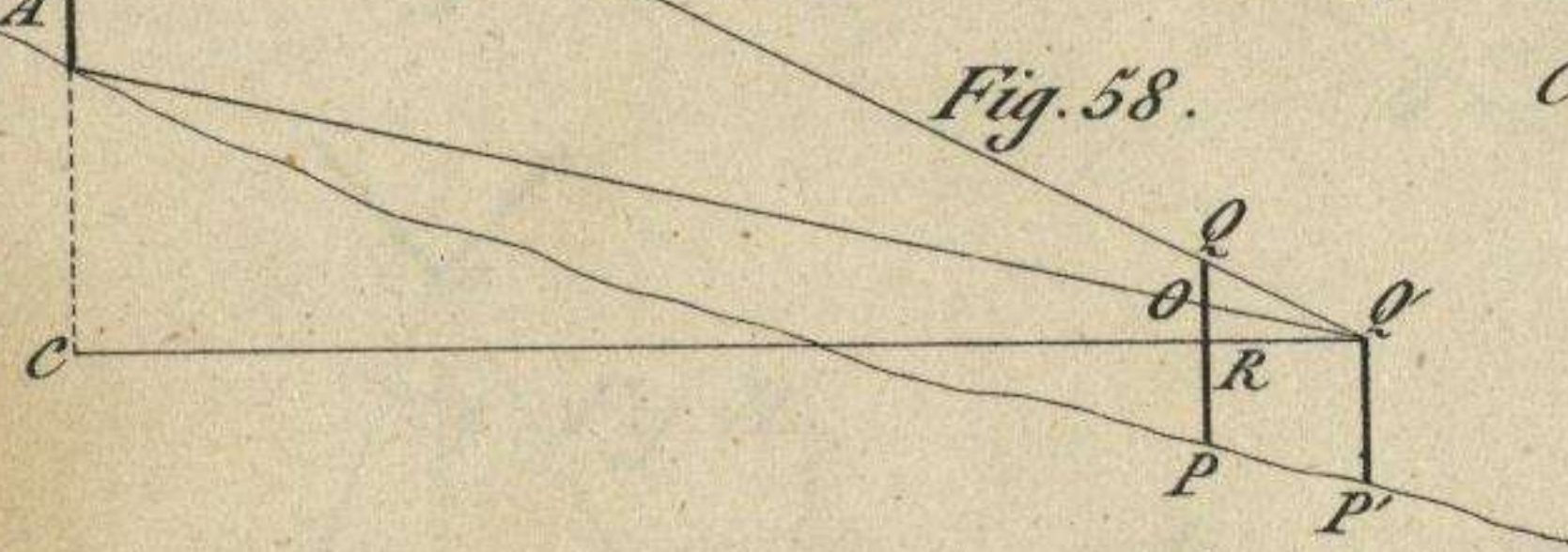

Fig. 58.

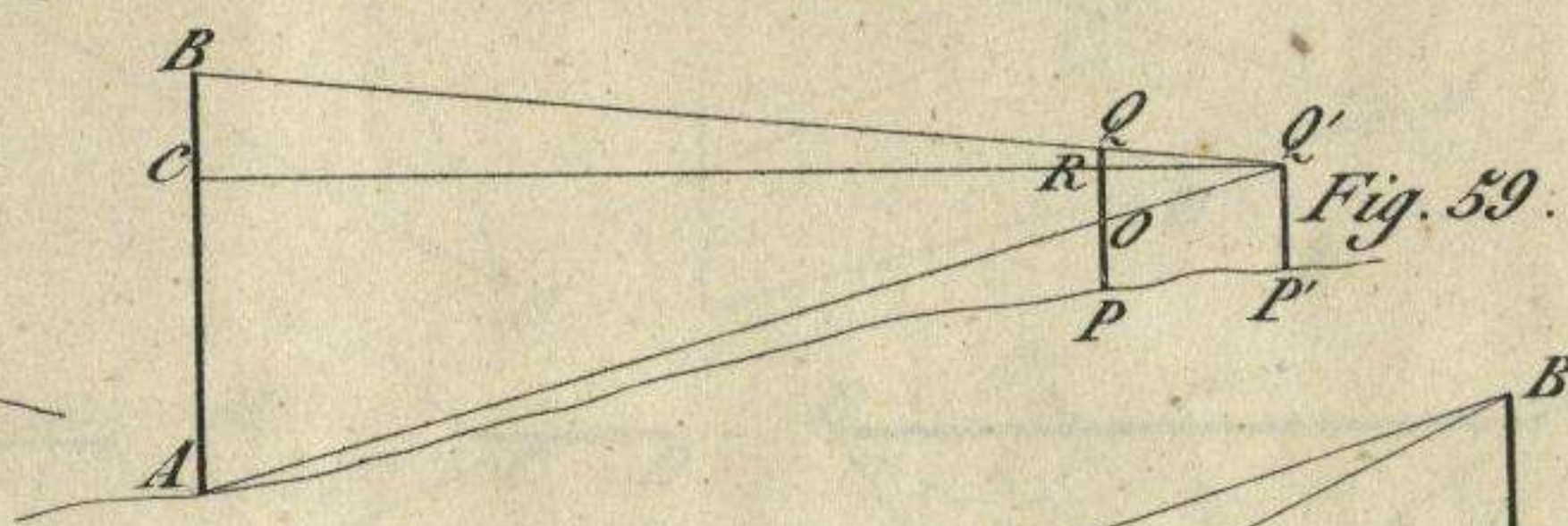

Fig. 59.



Fig. 60.

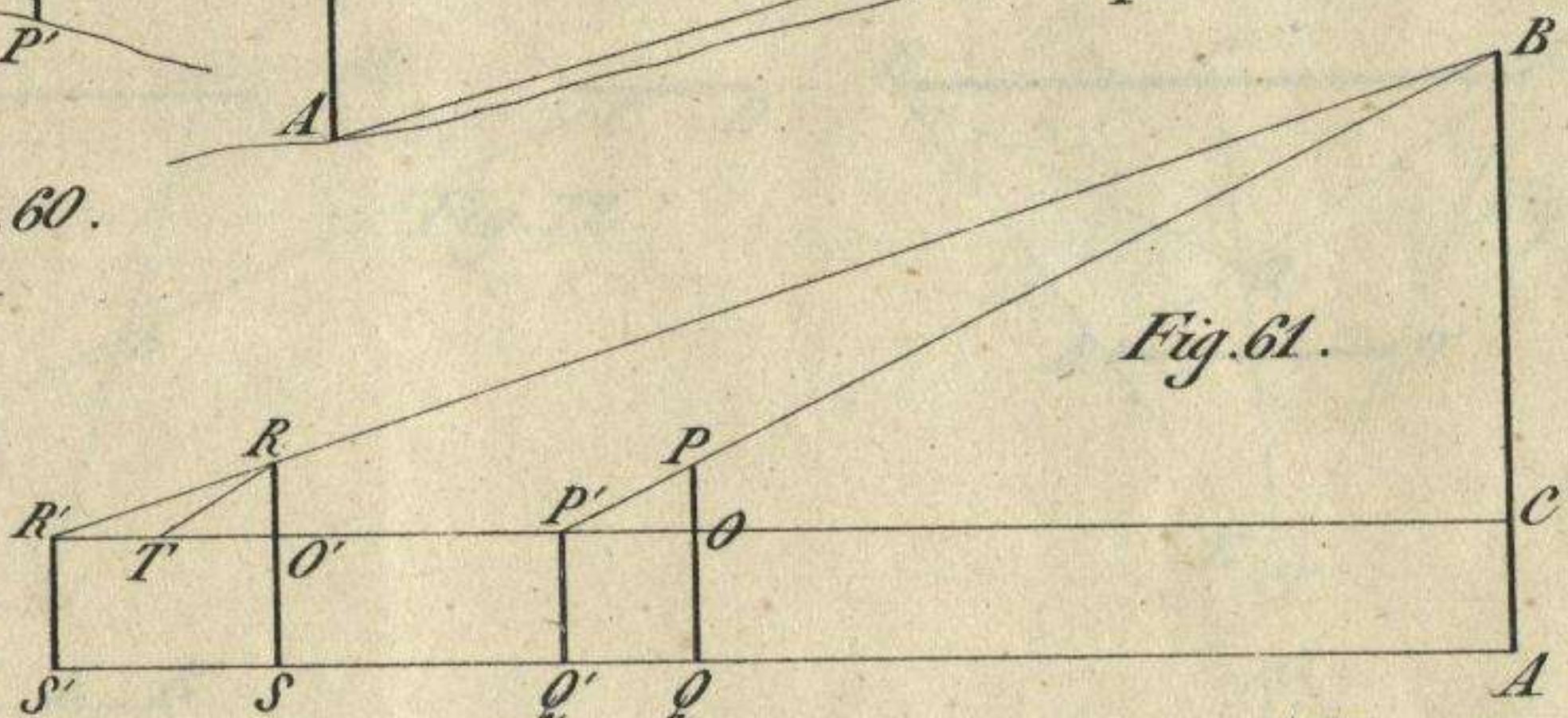

Fig. 61.

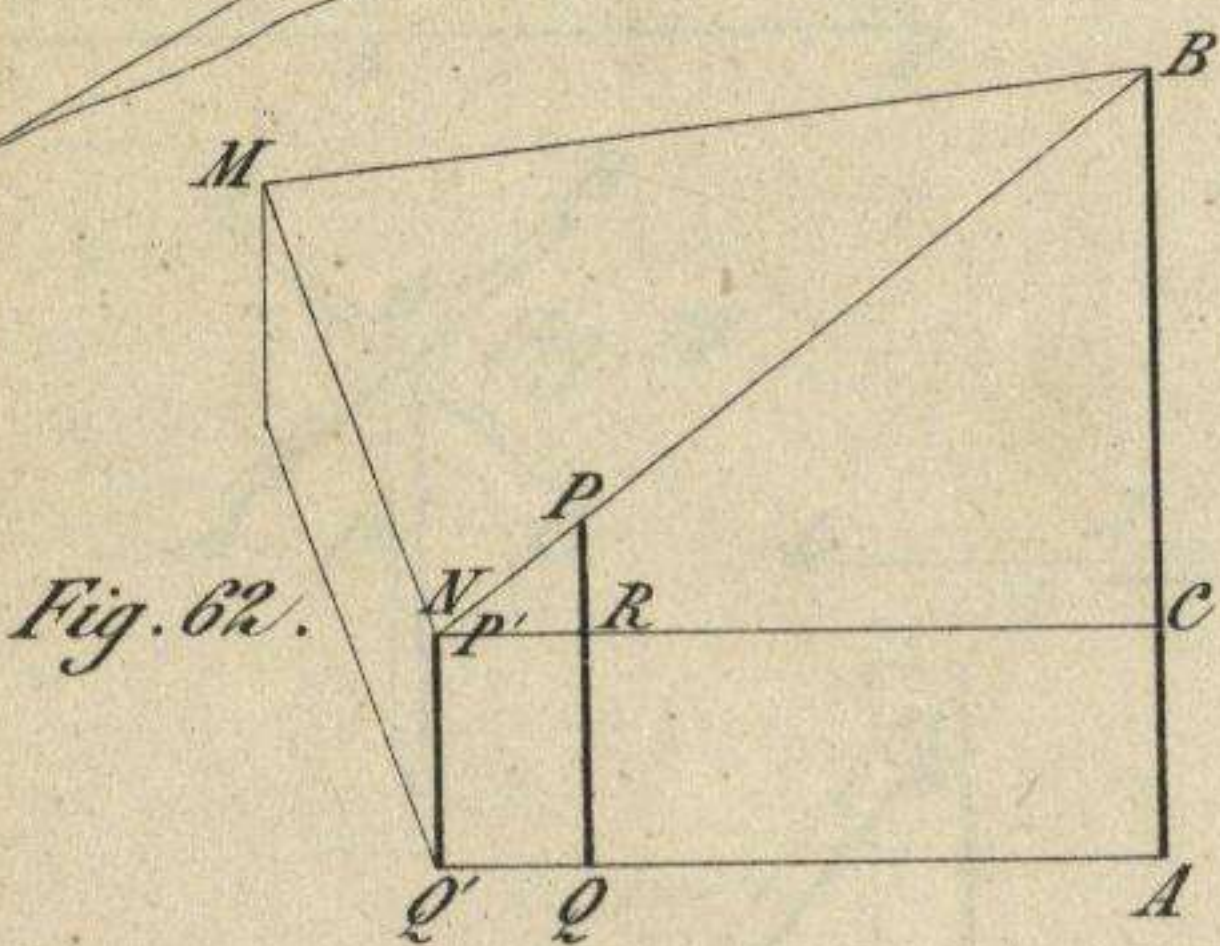

Fig. 62.

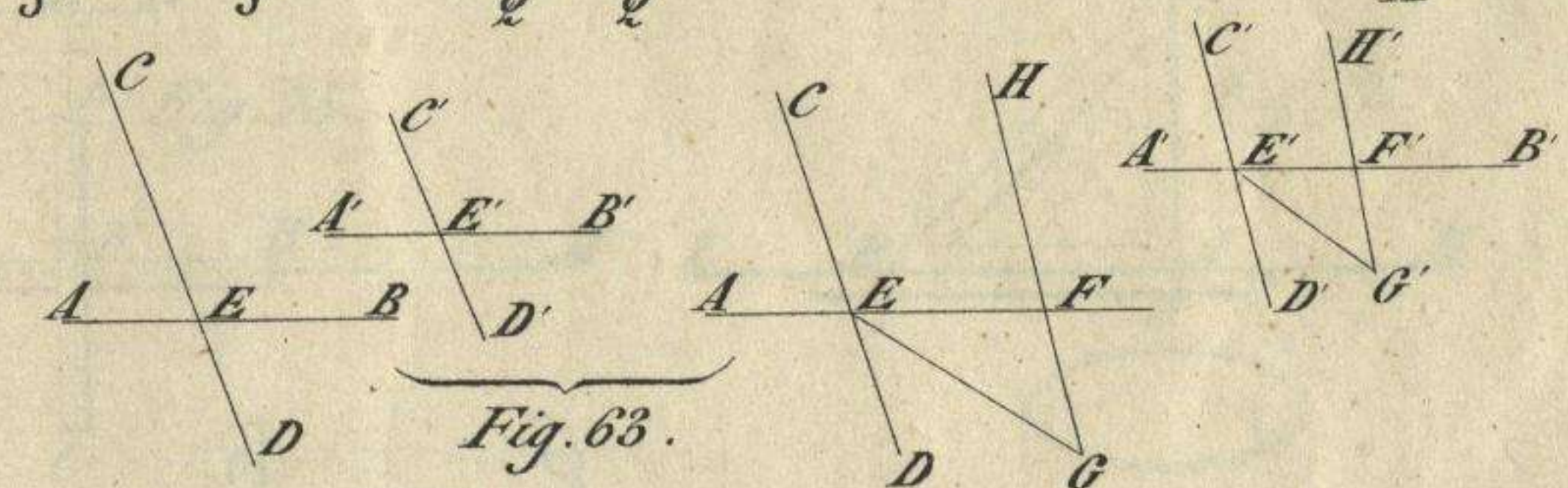

Fig. 63.

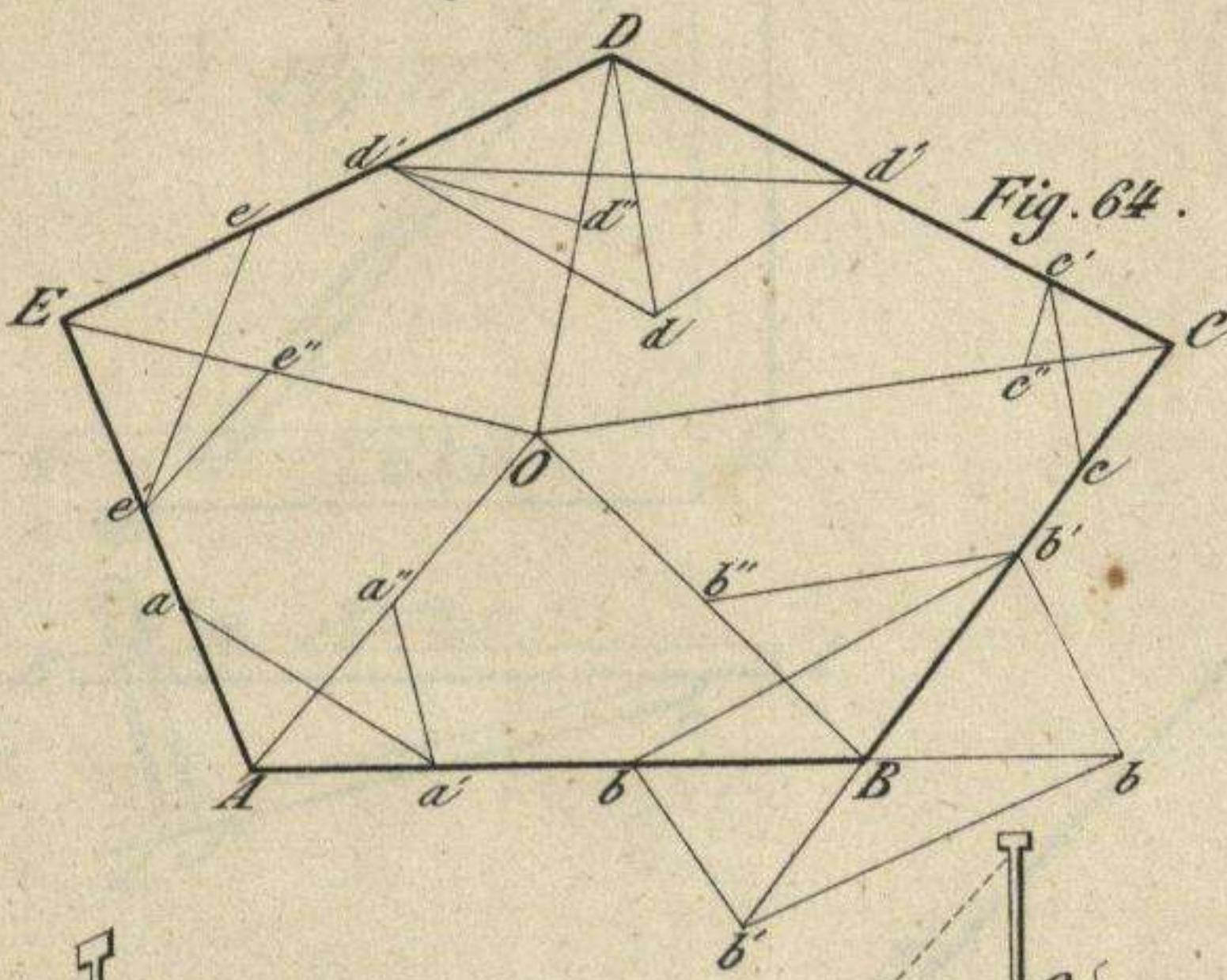

Fig. 64.

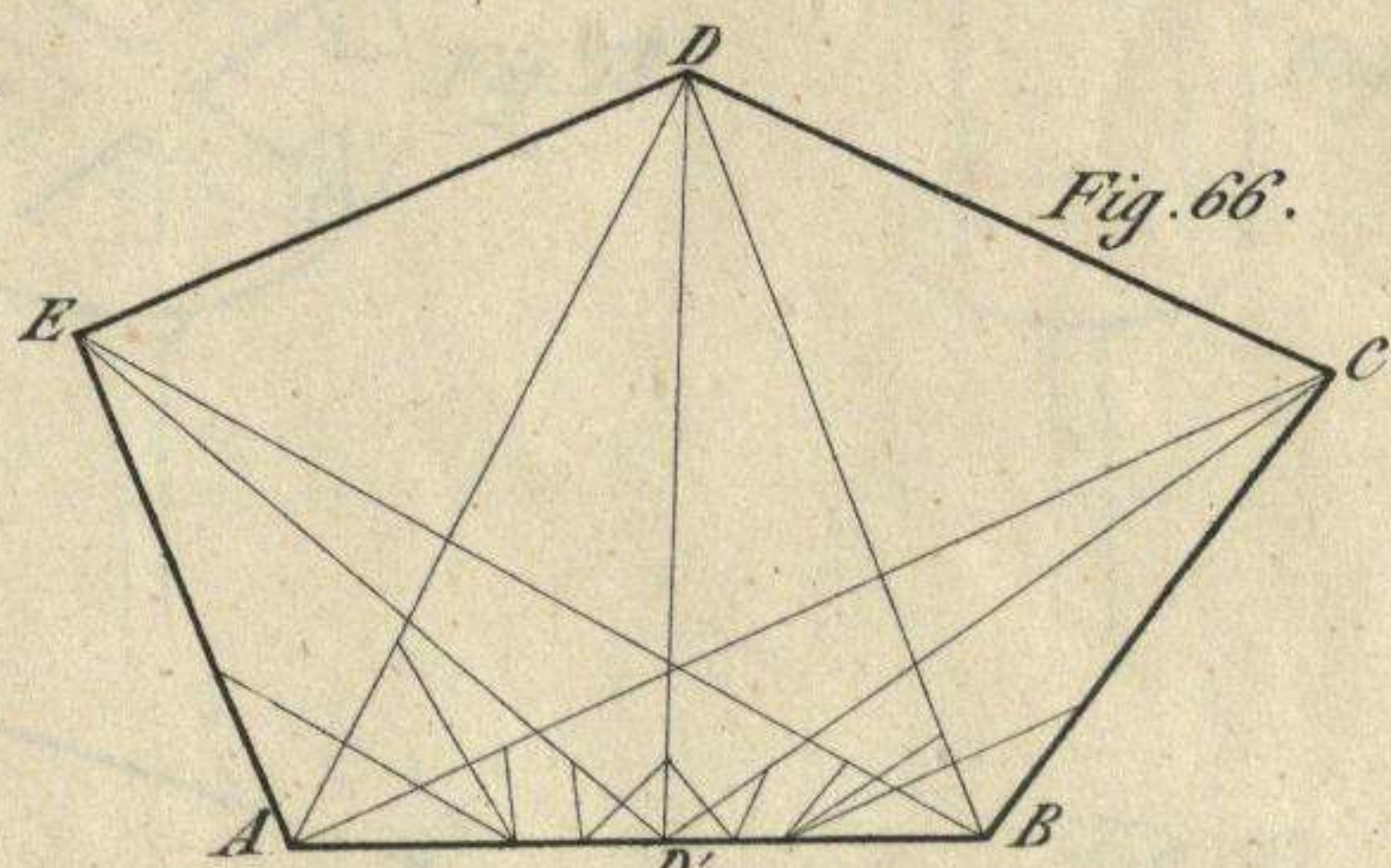

Fig. 66.

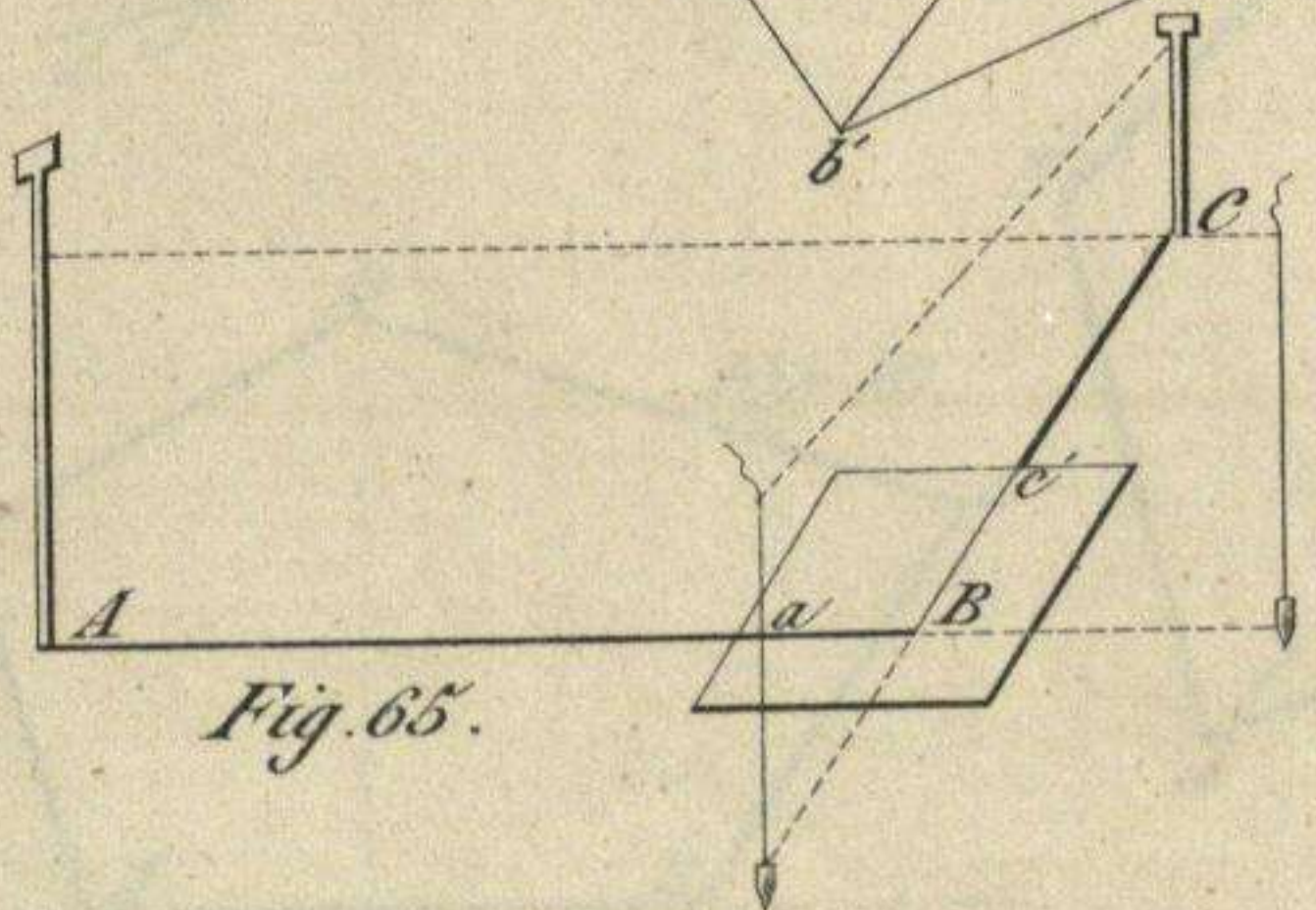

Fig. 65.

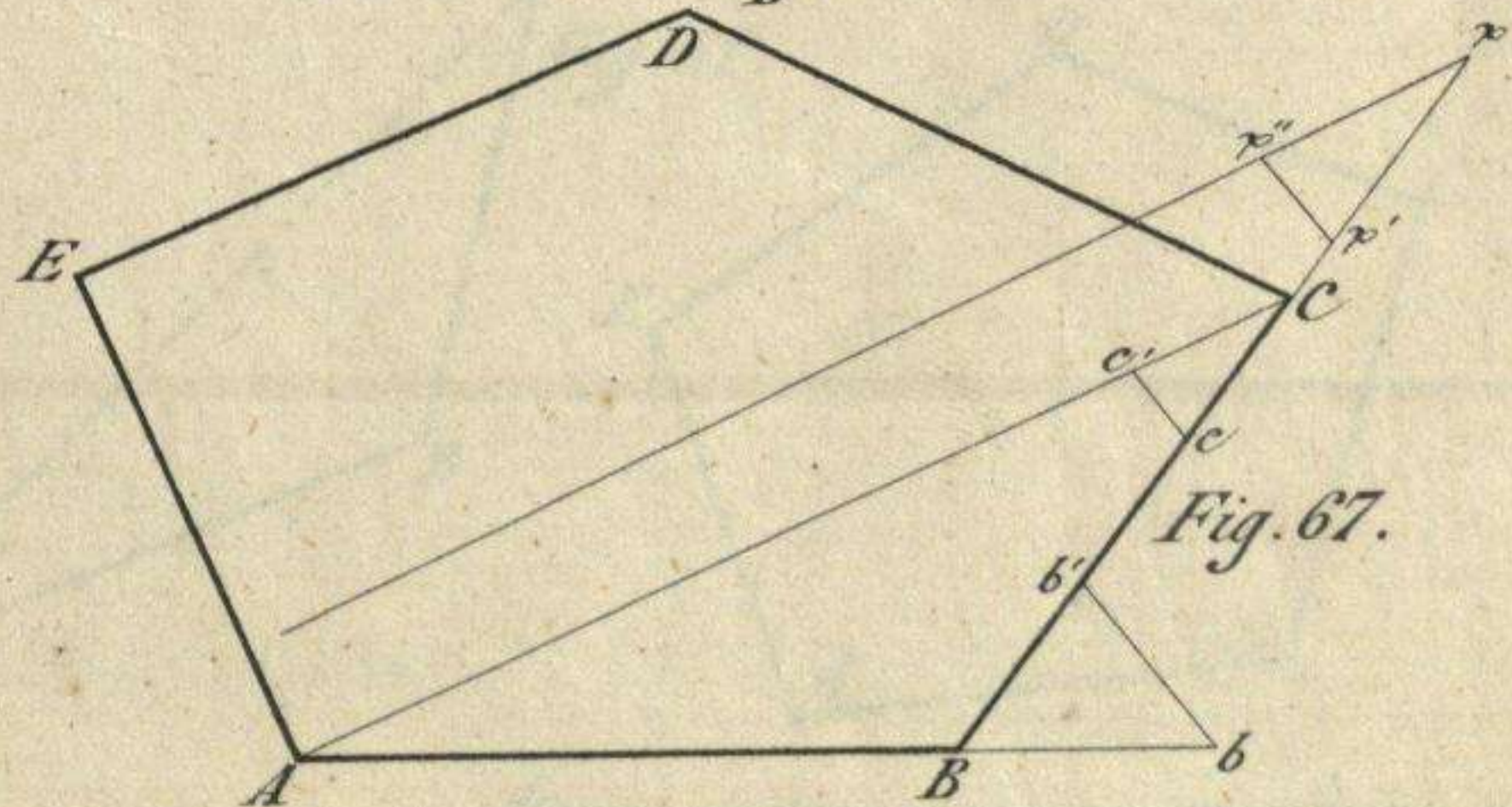
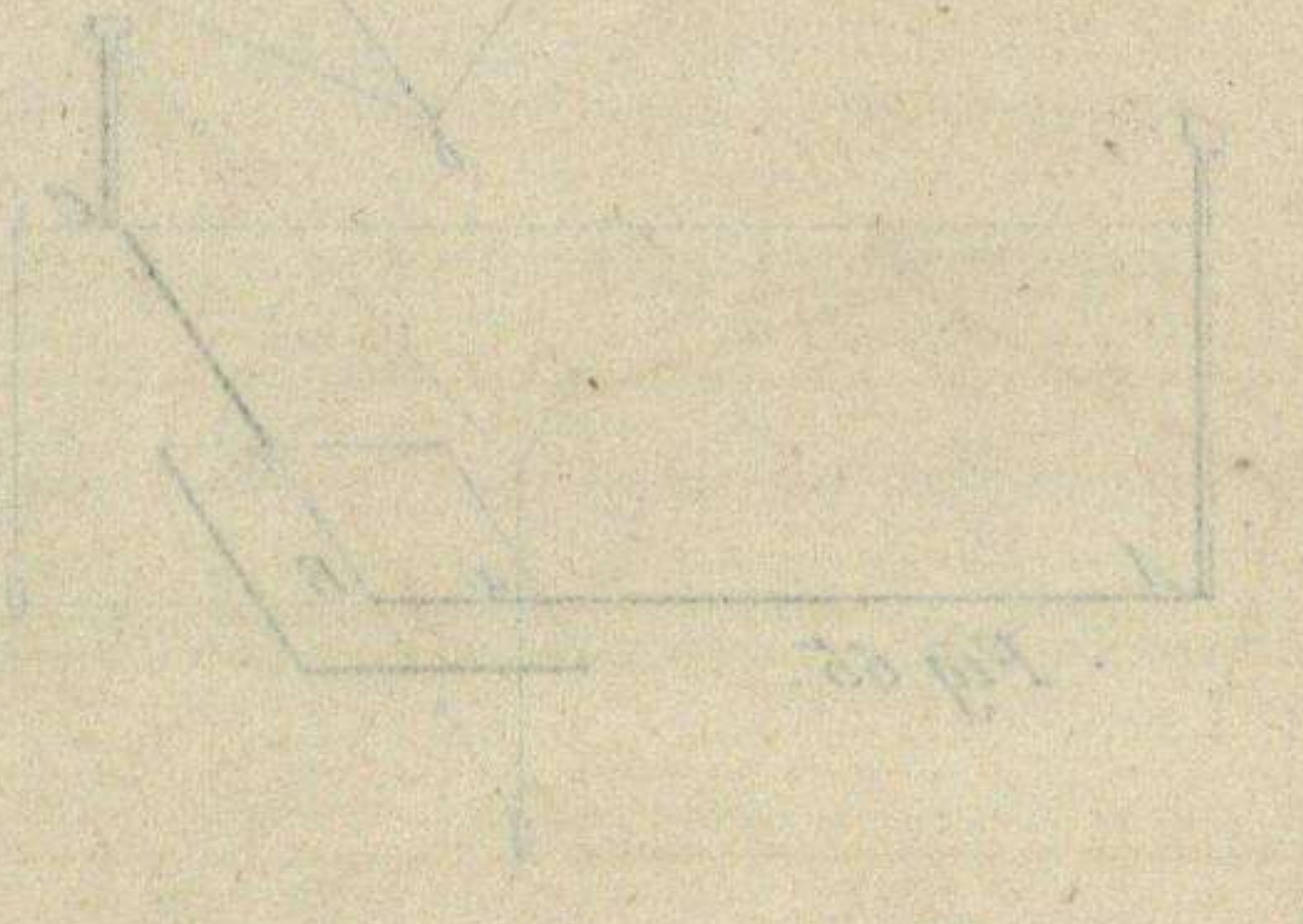
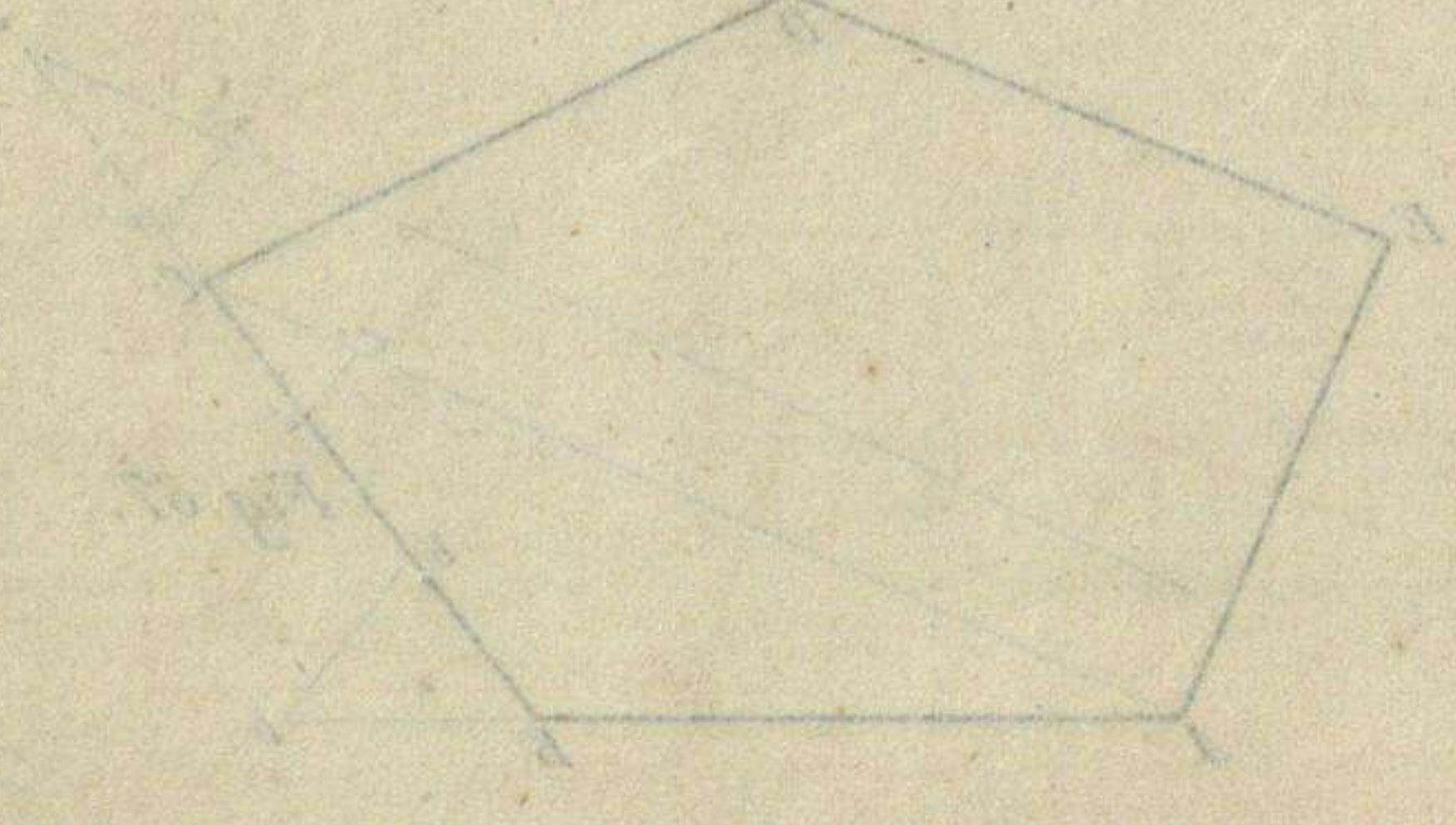
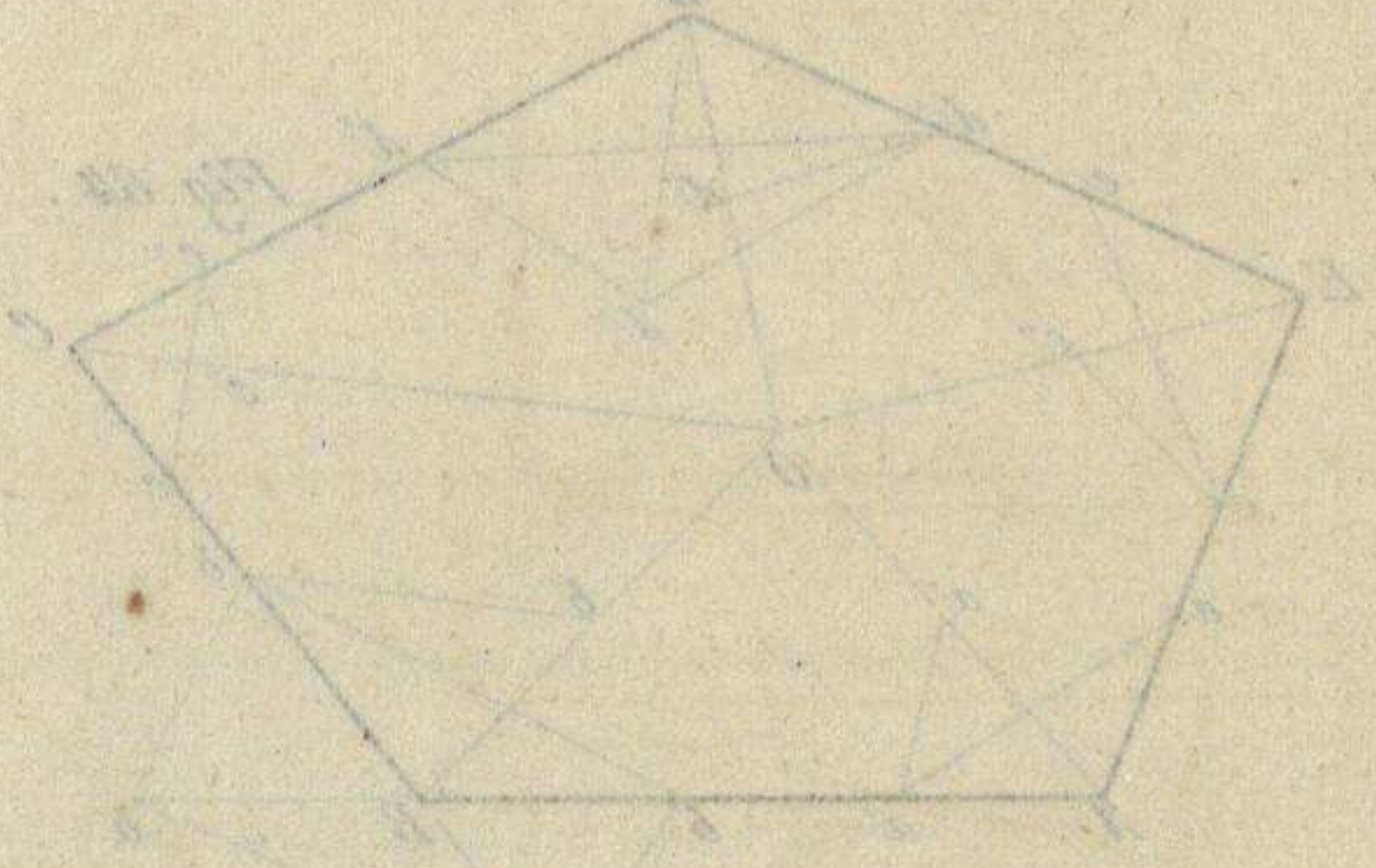
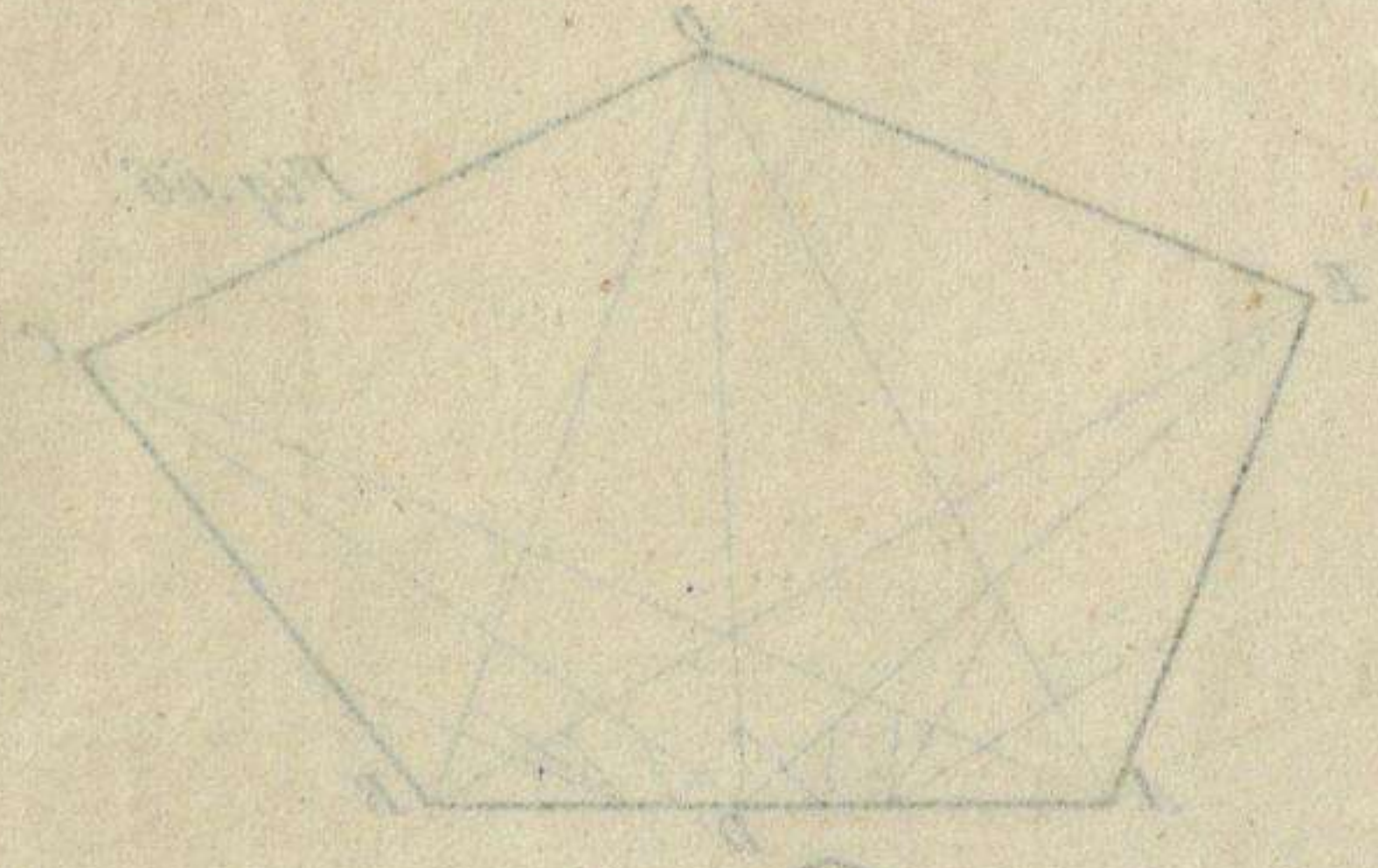
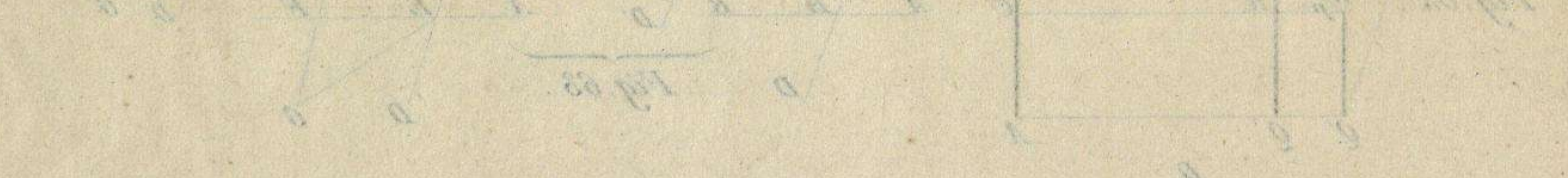
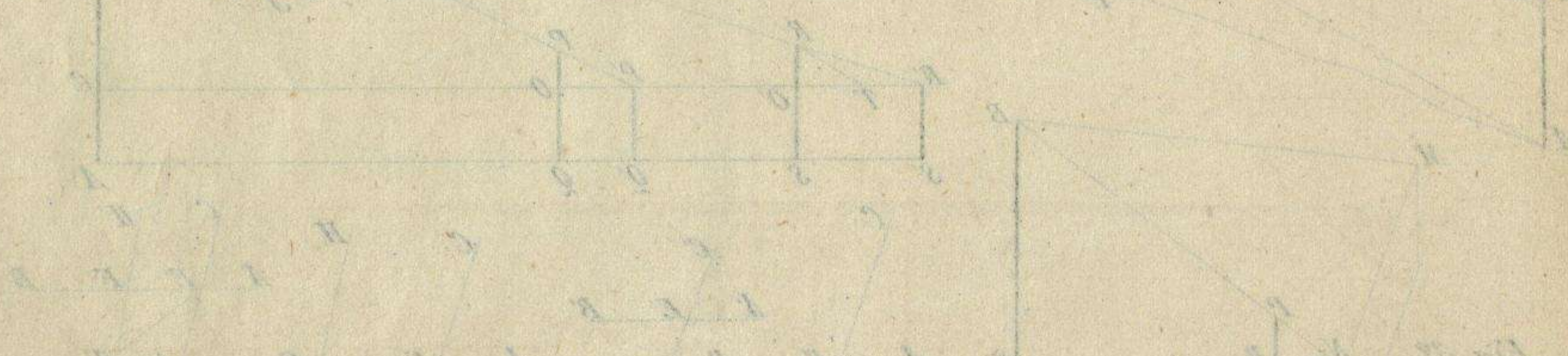
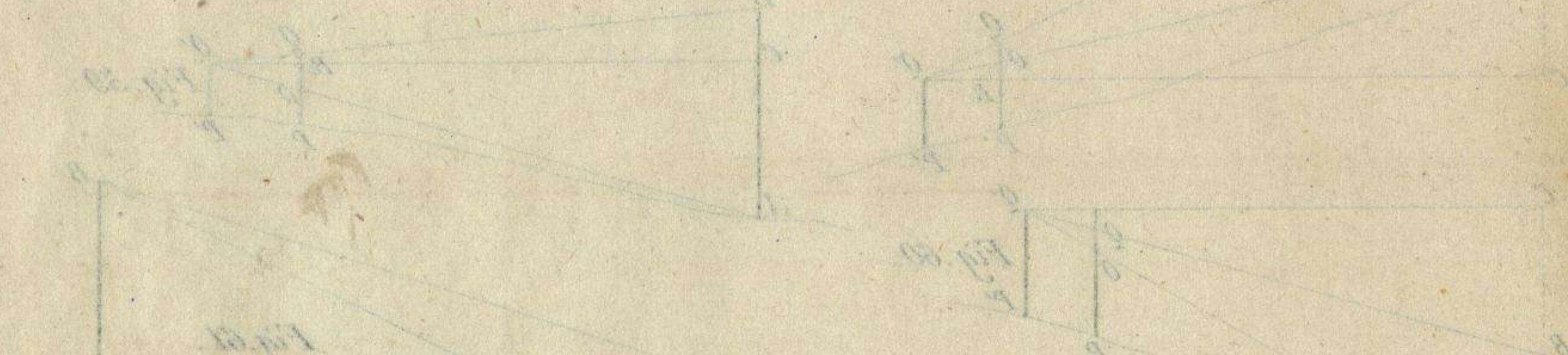
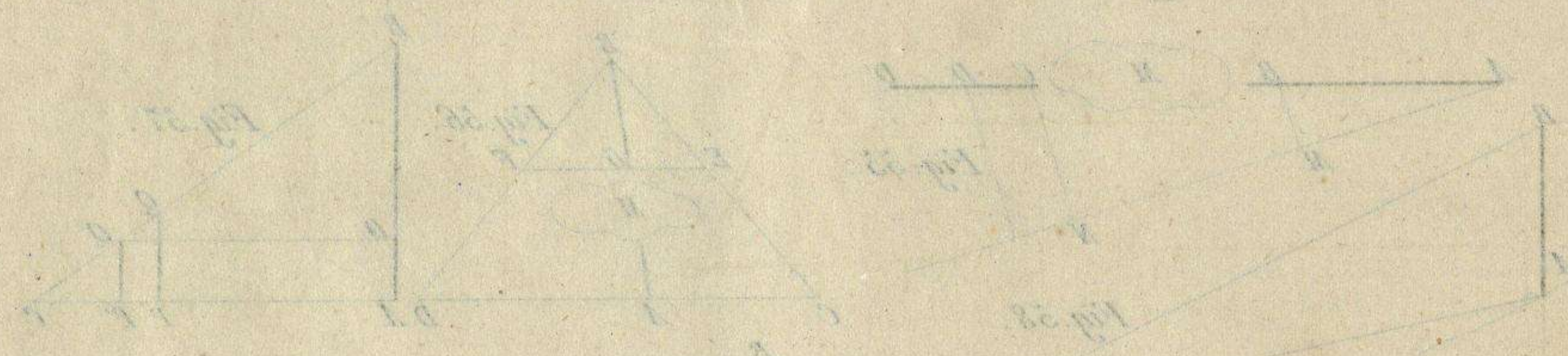
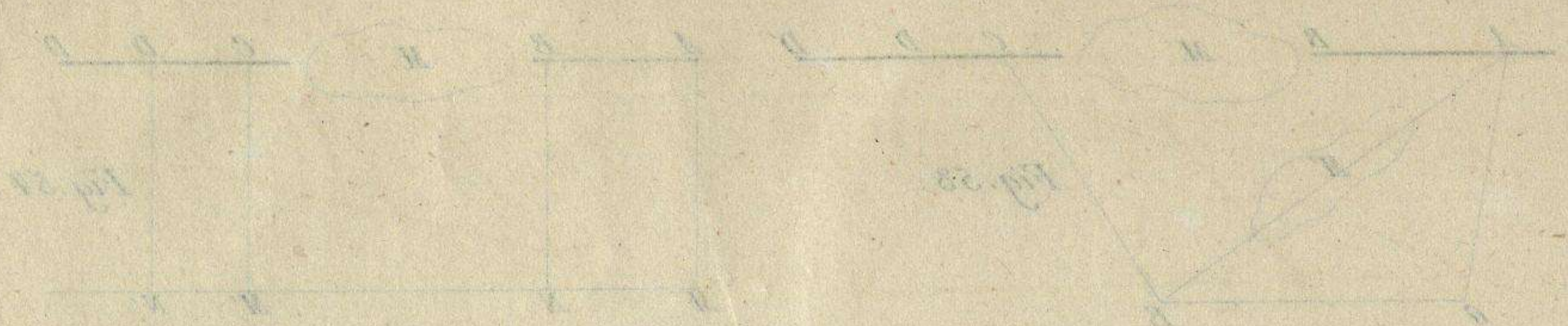
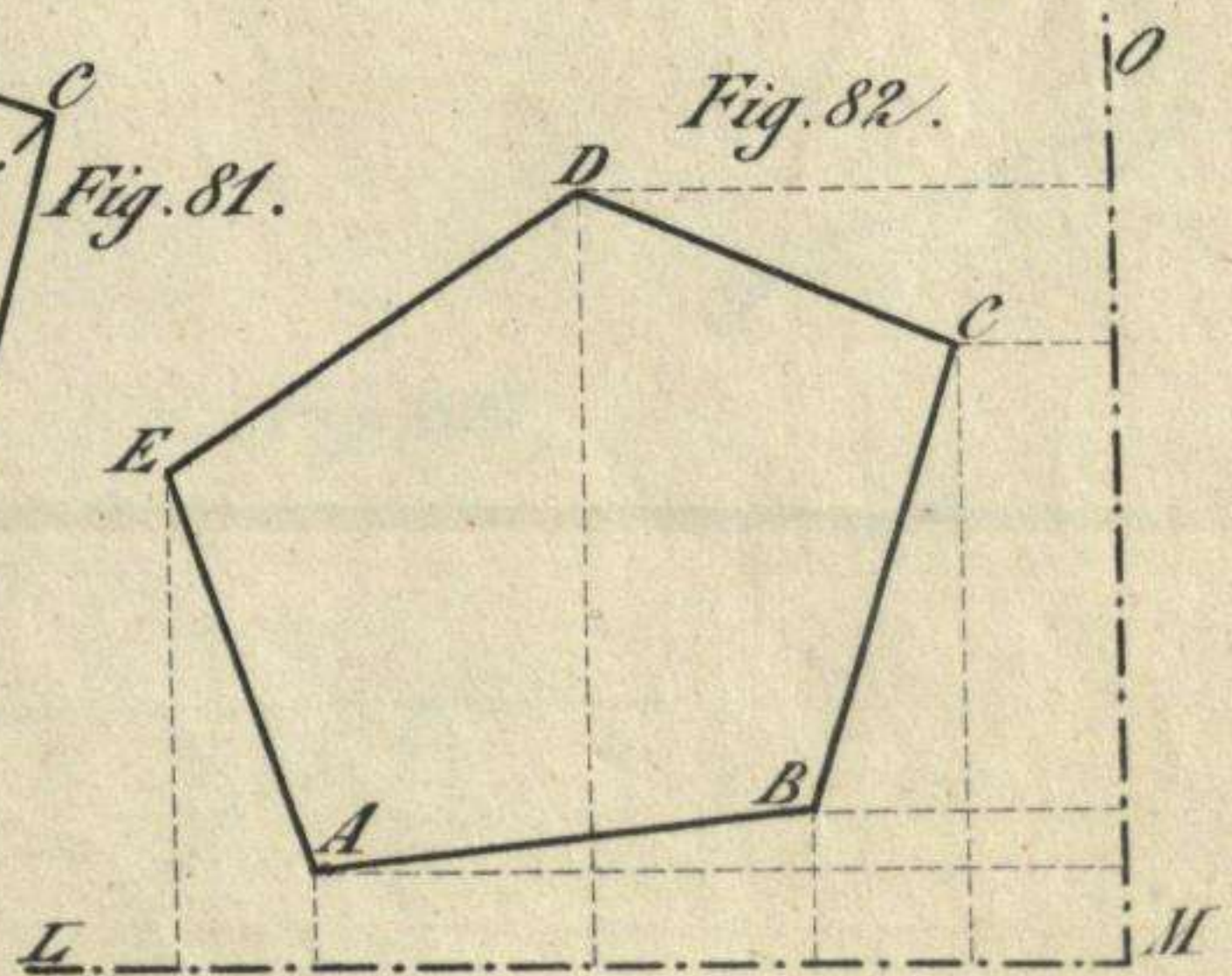
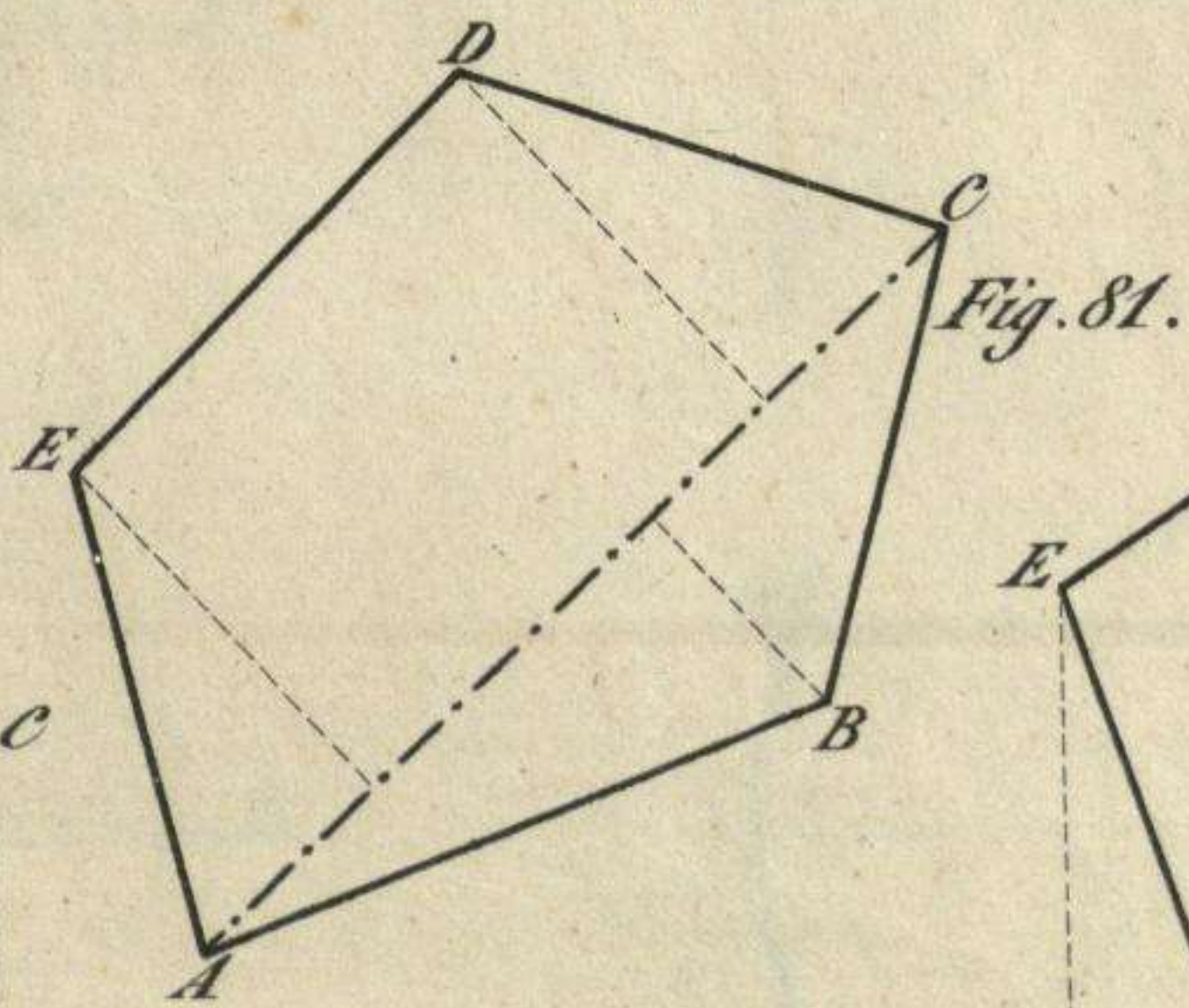
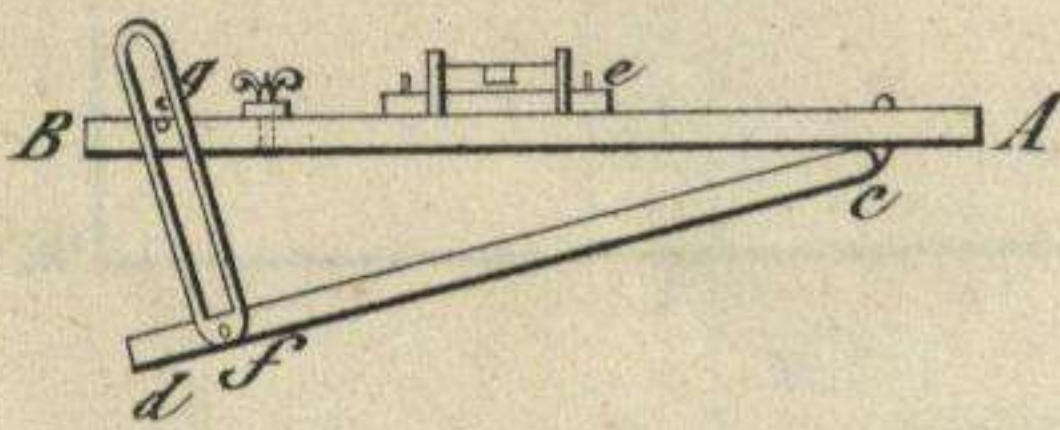
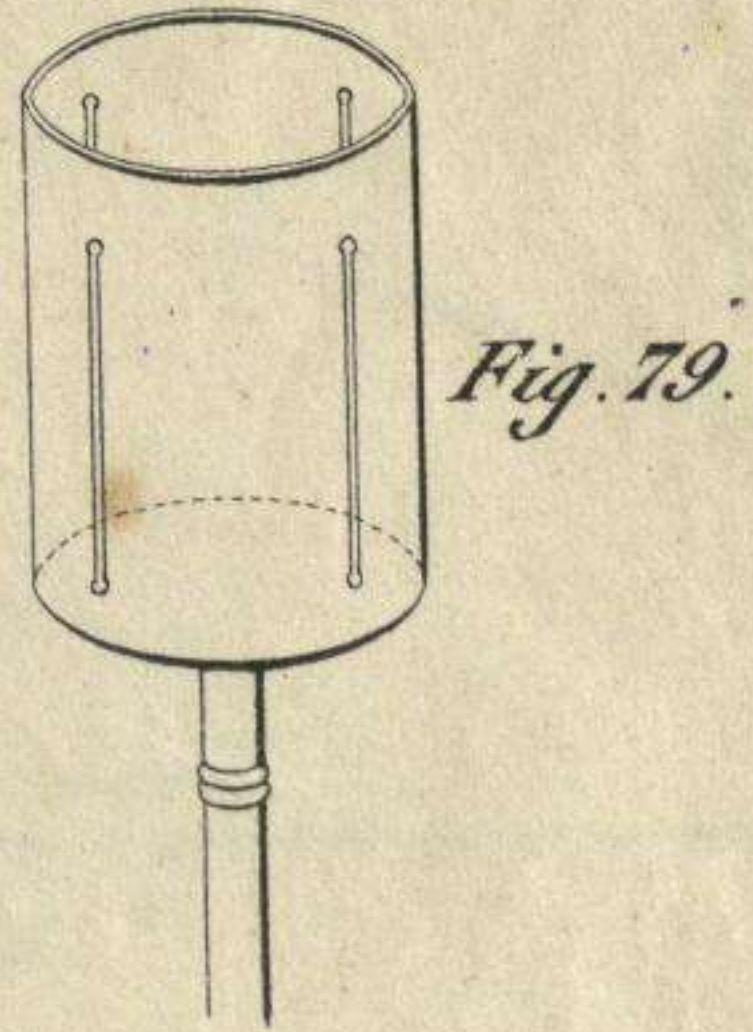
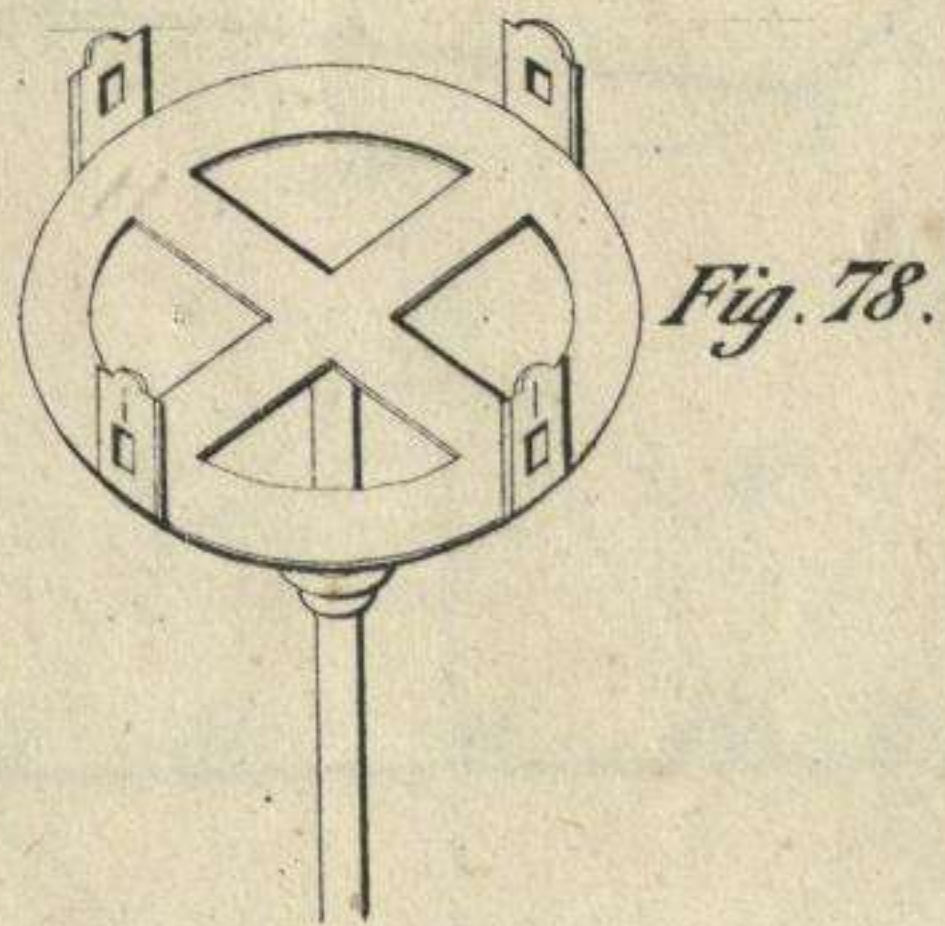
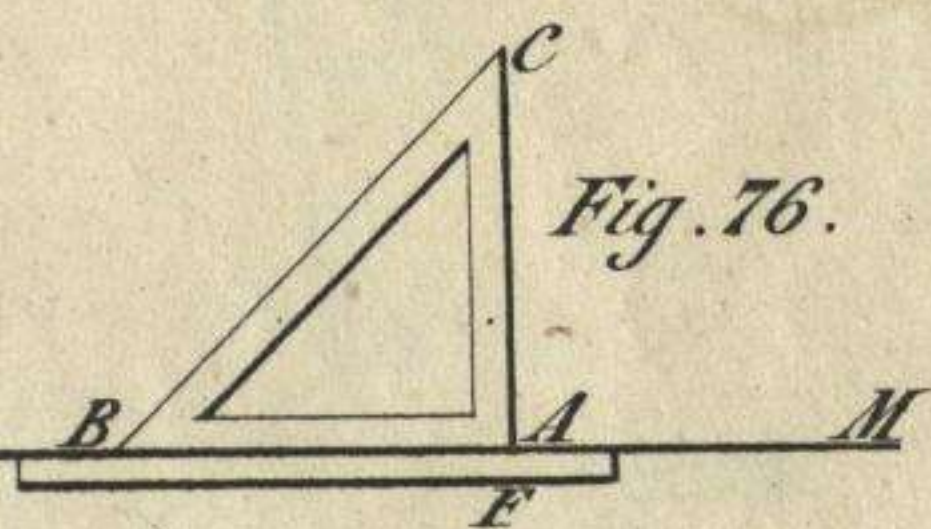
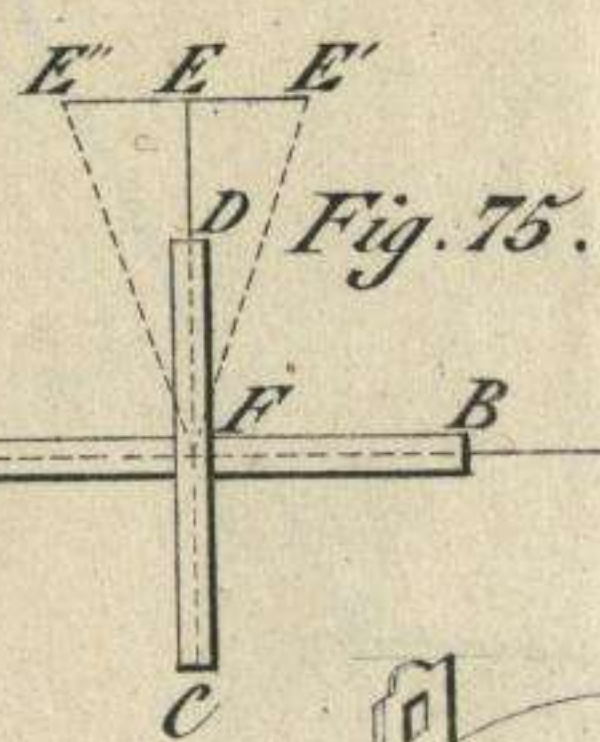
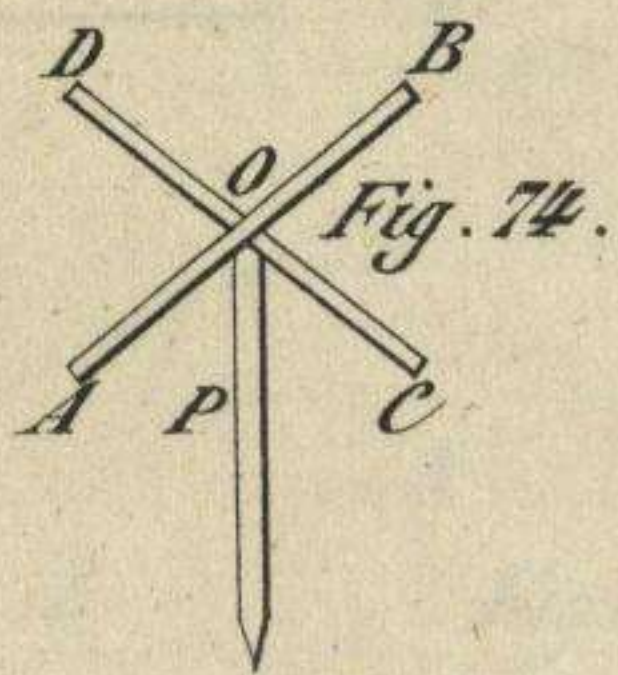
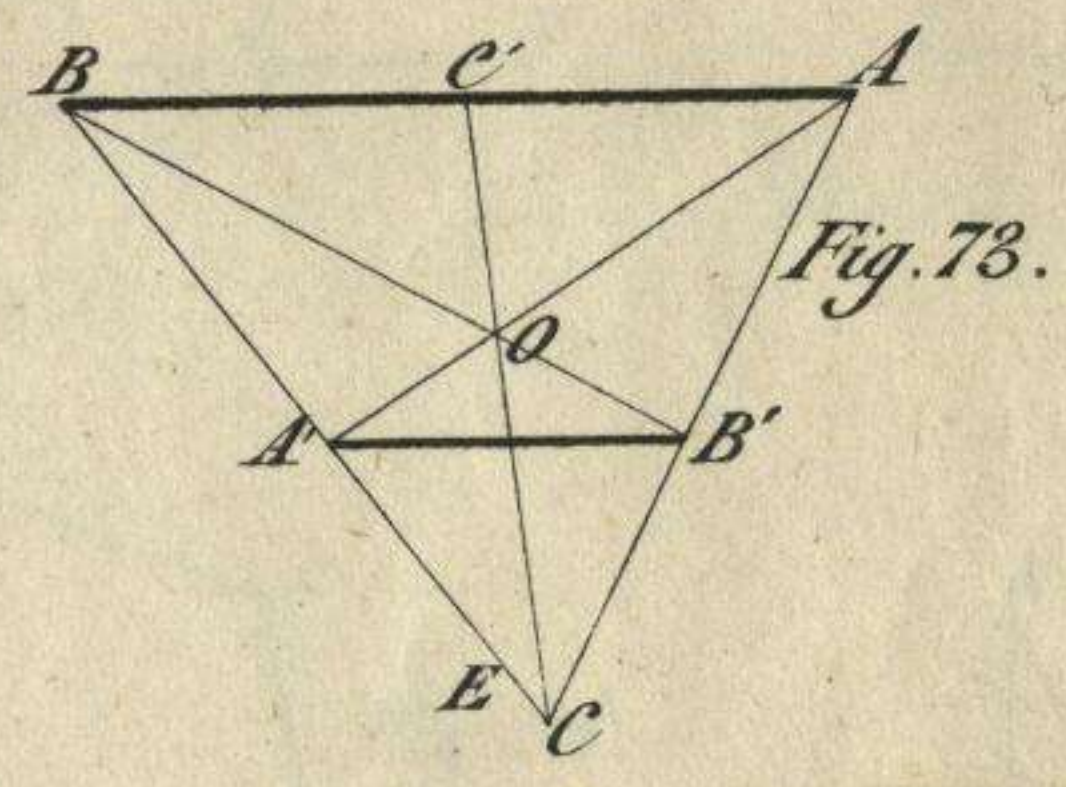
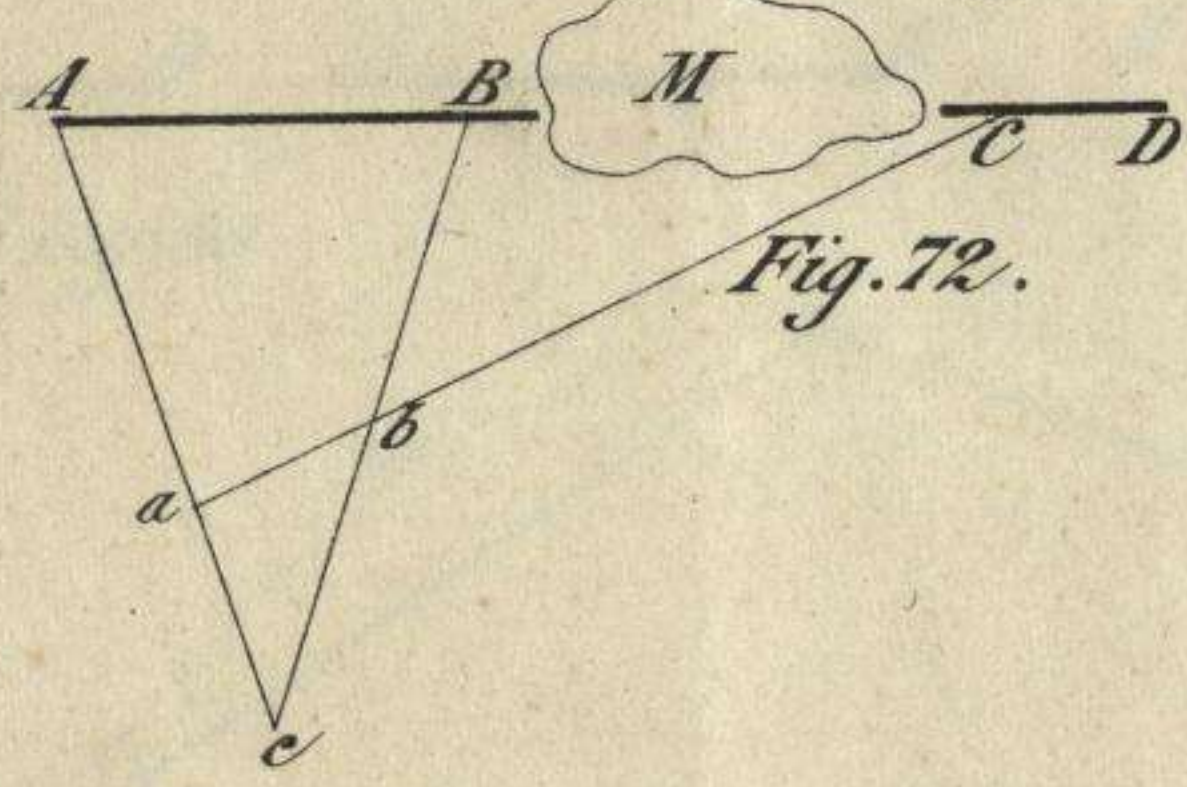
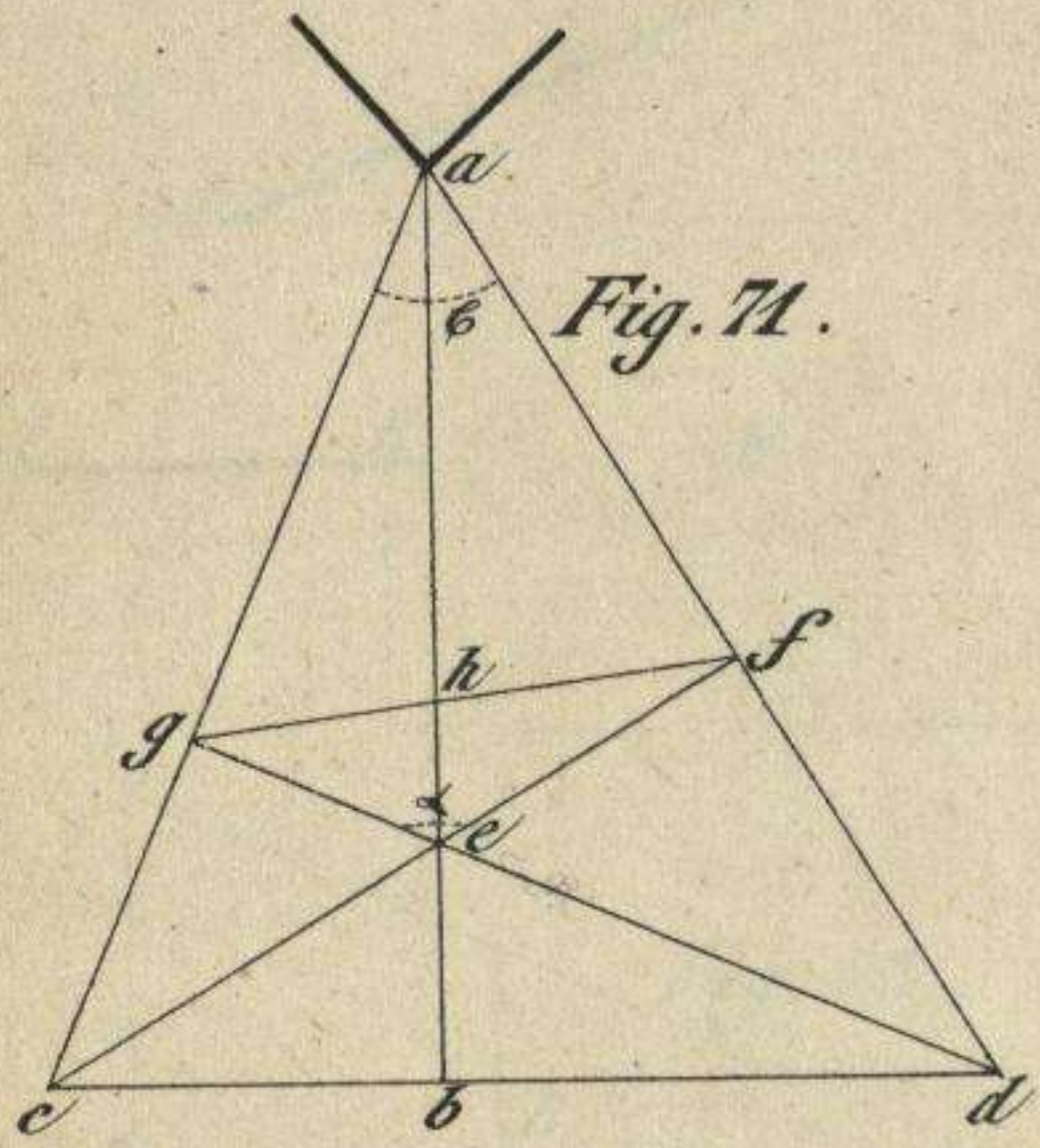
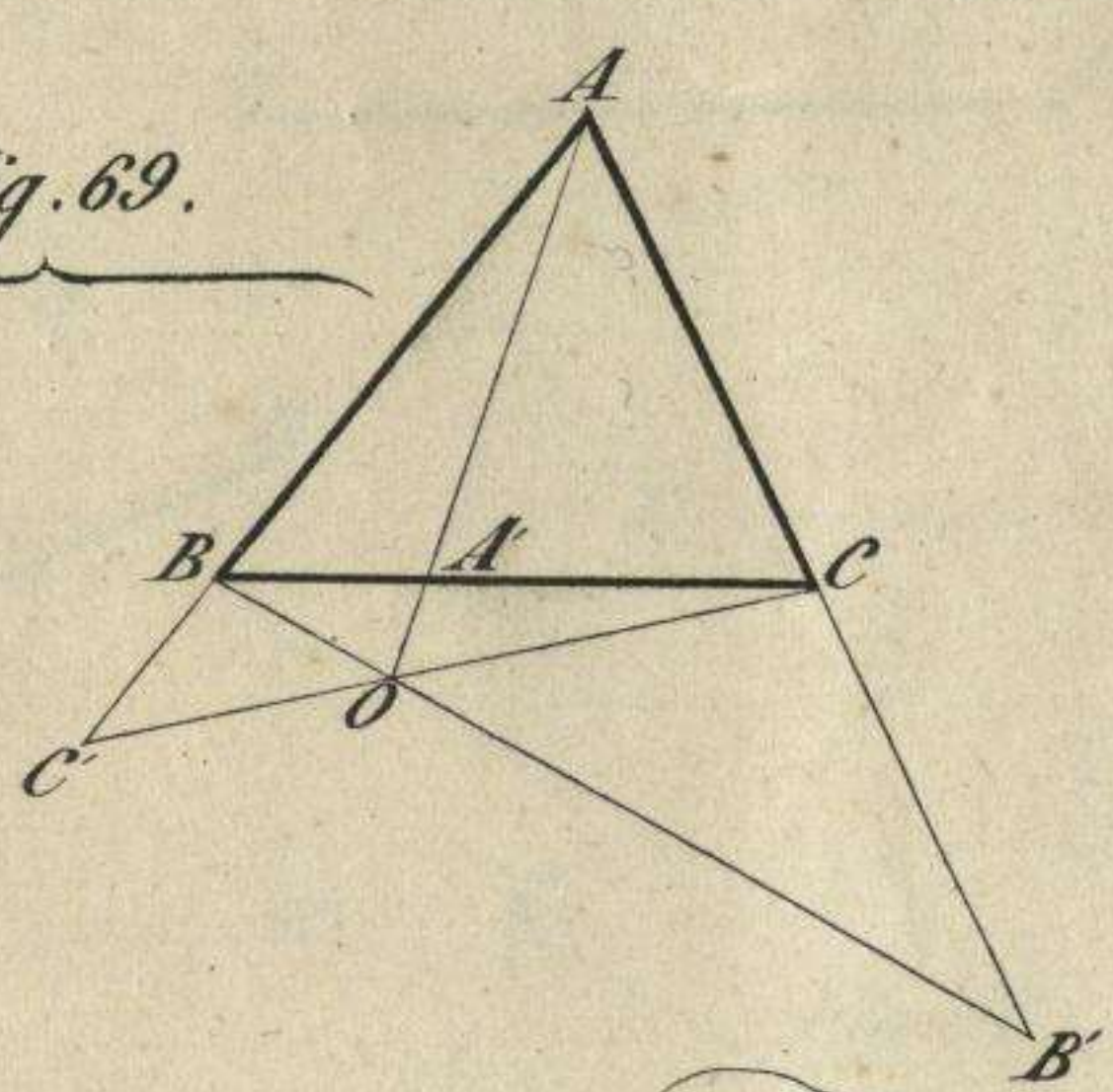
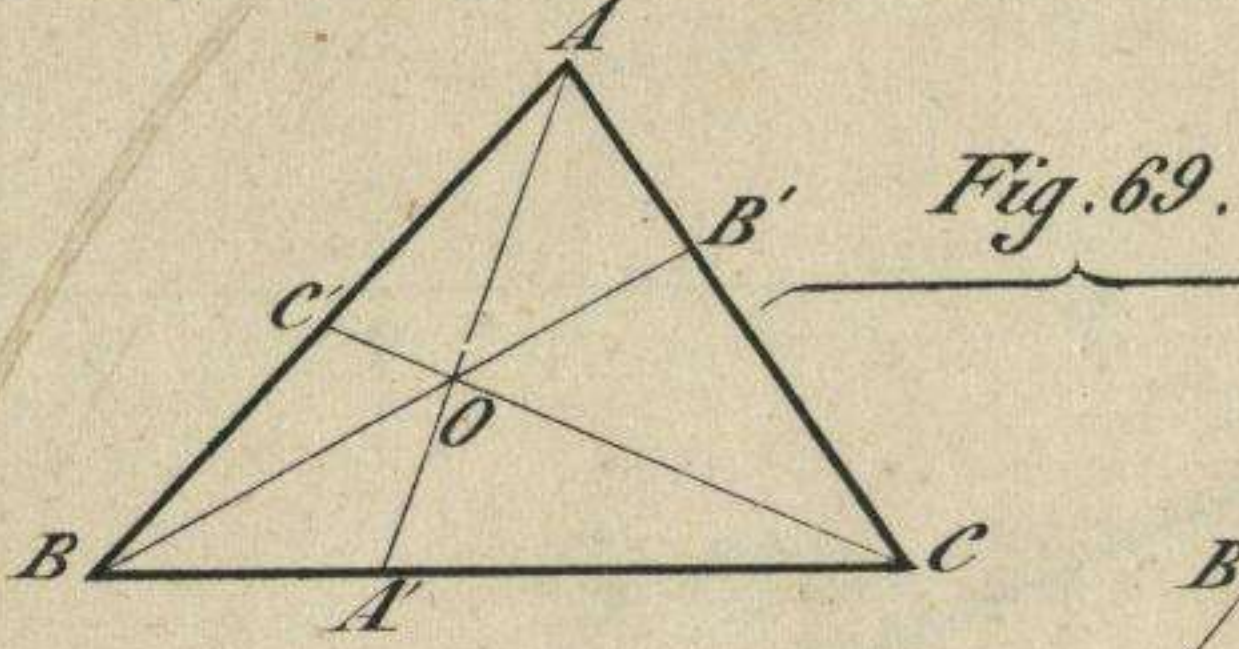
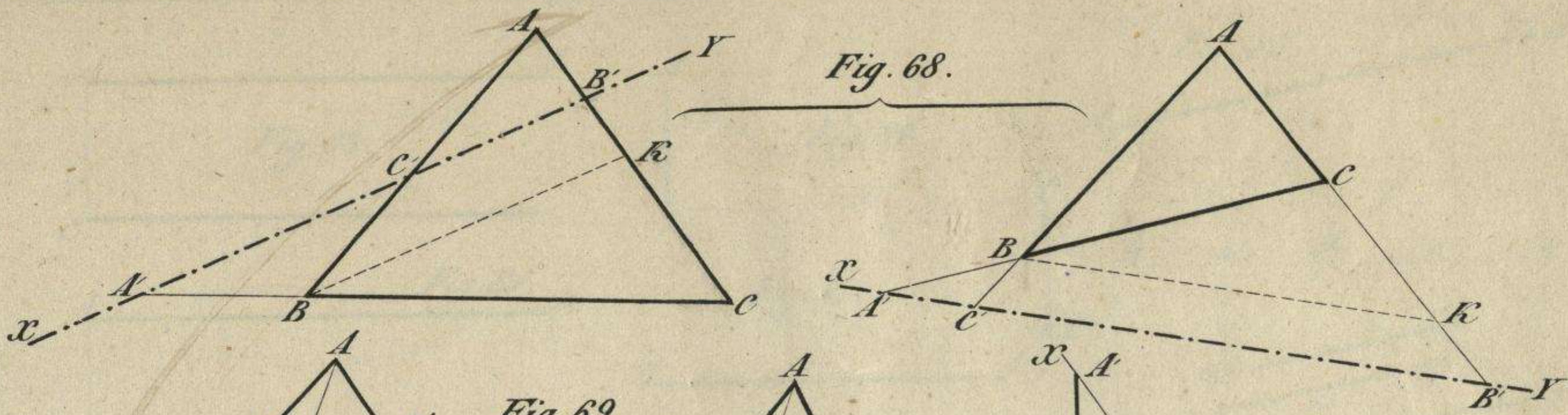
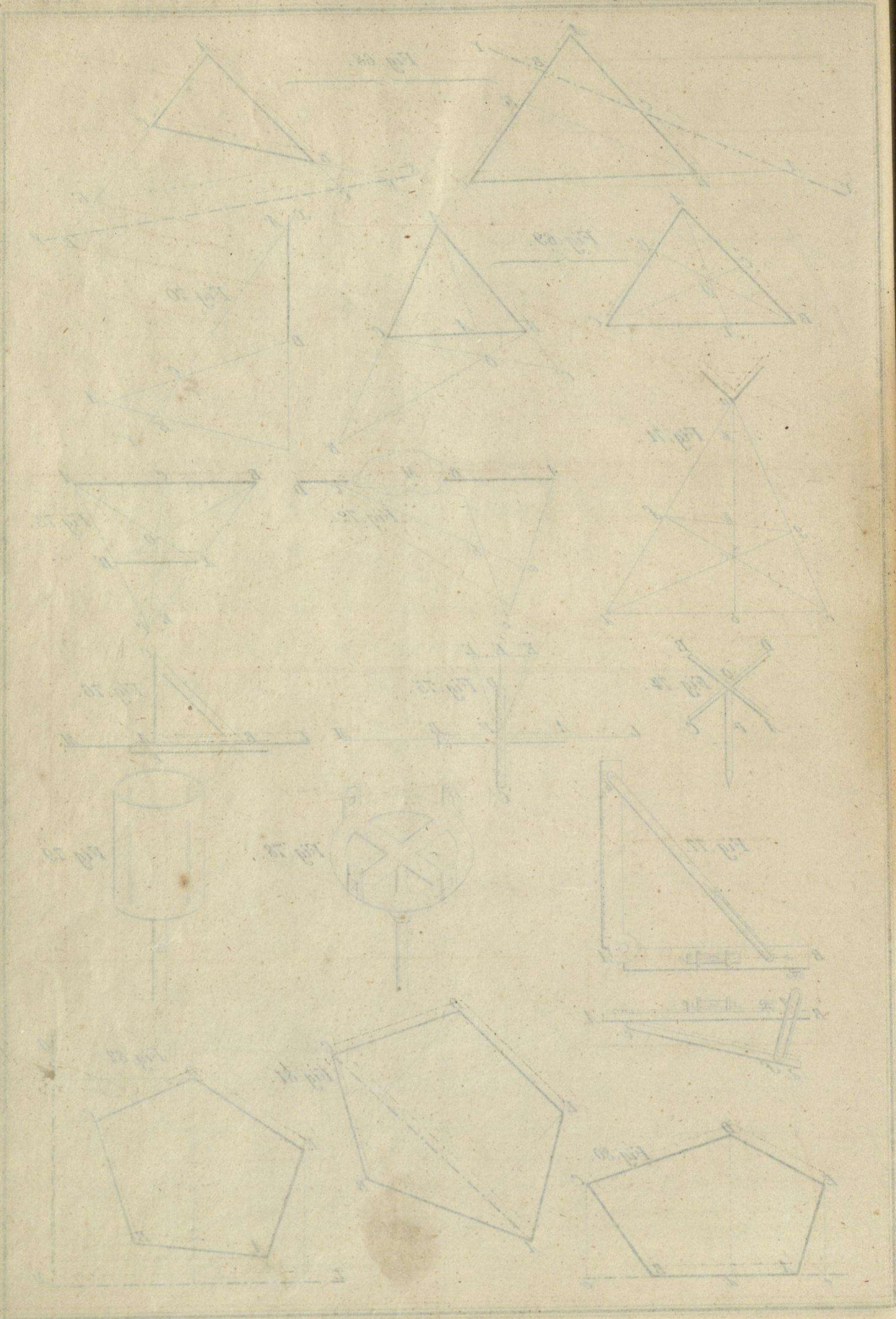

Fig. 67.







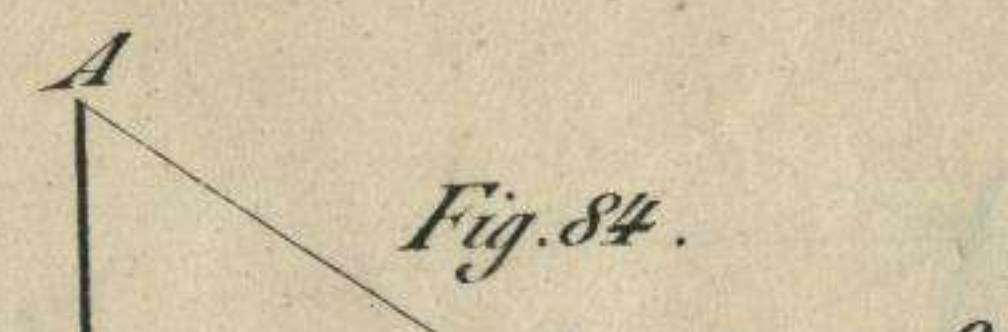
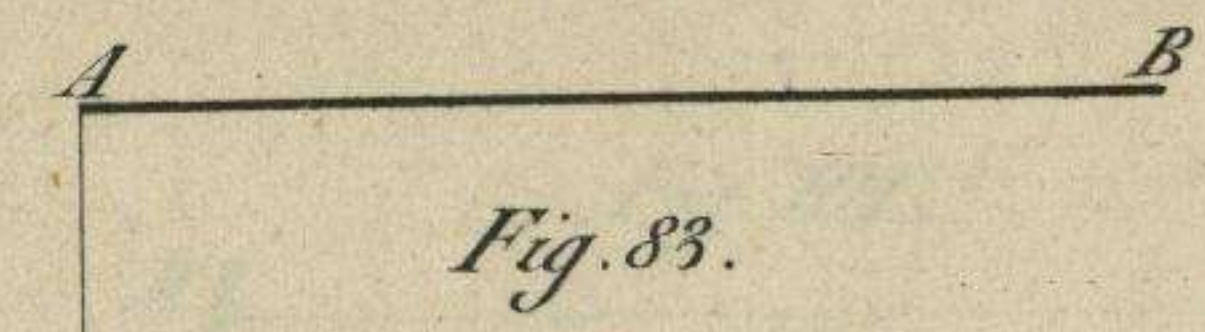
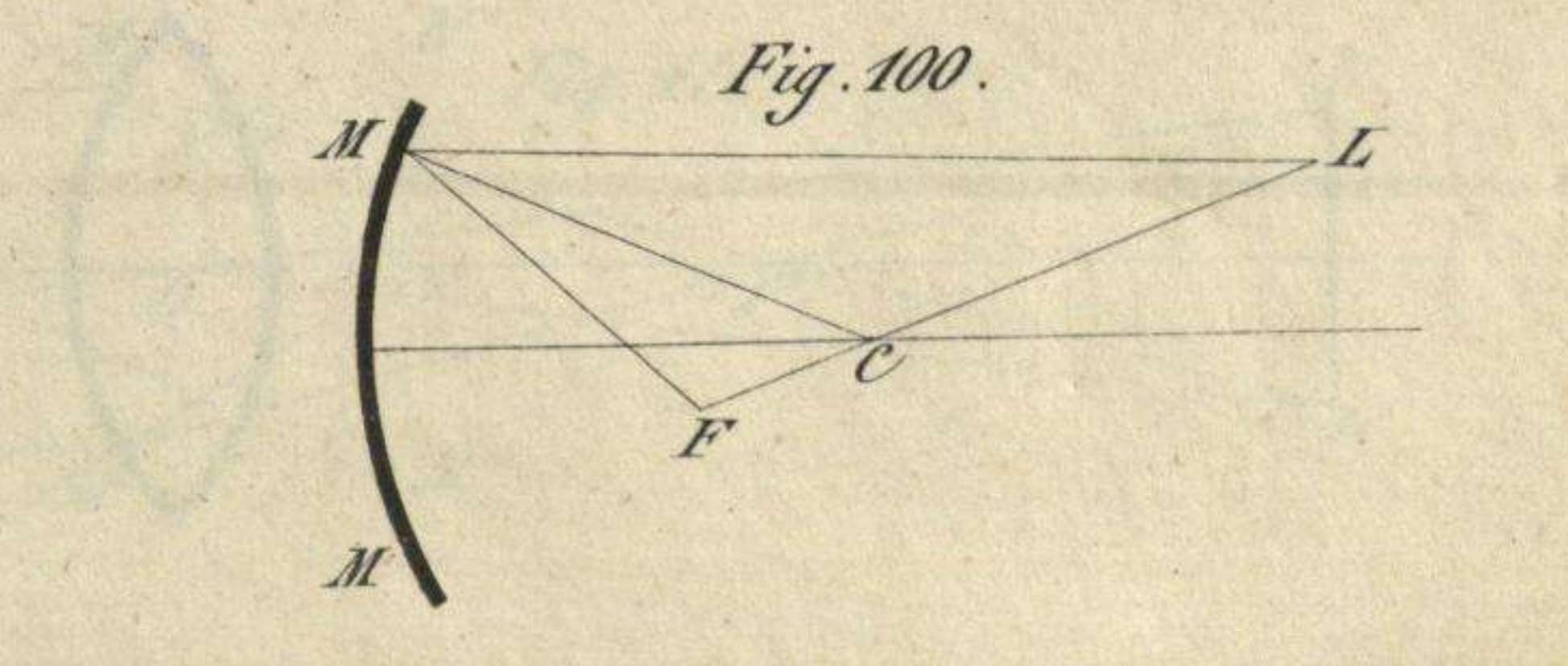
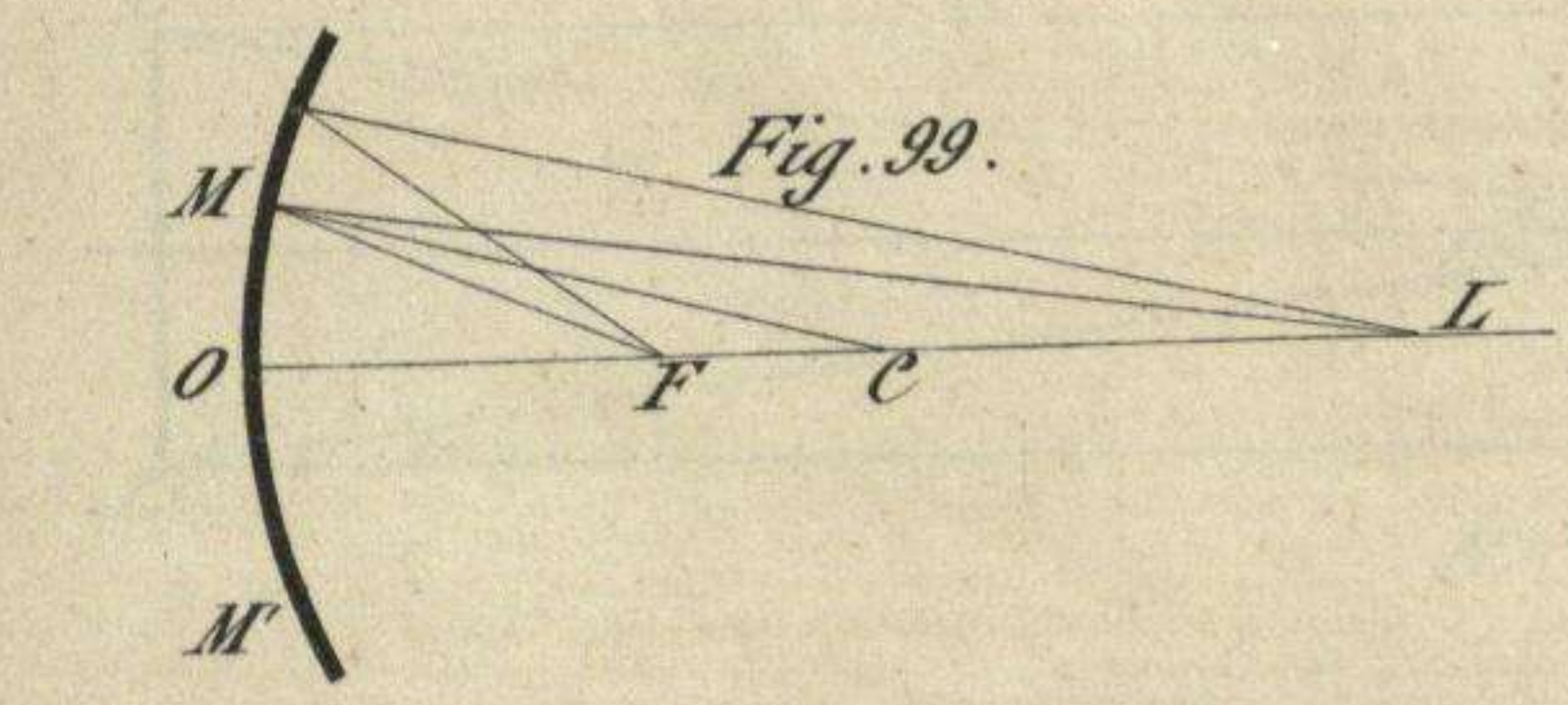
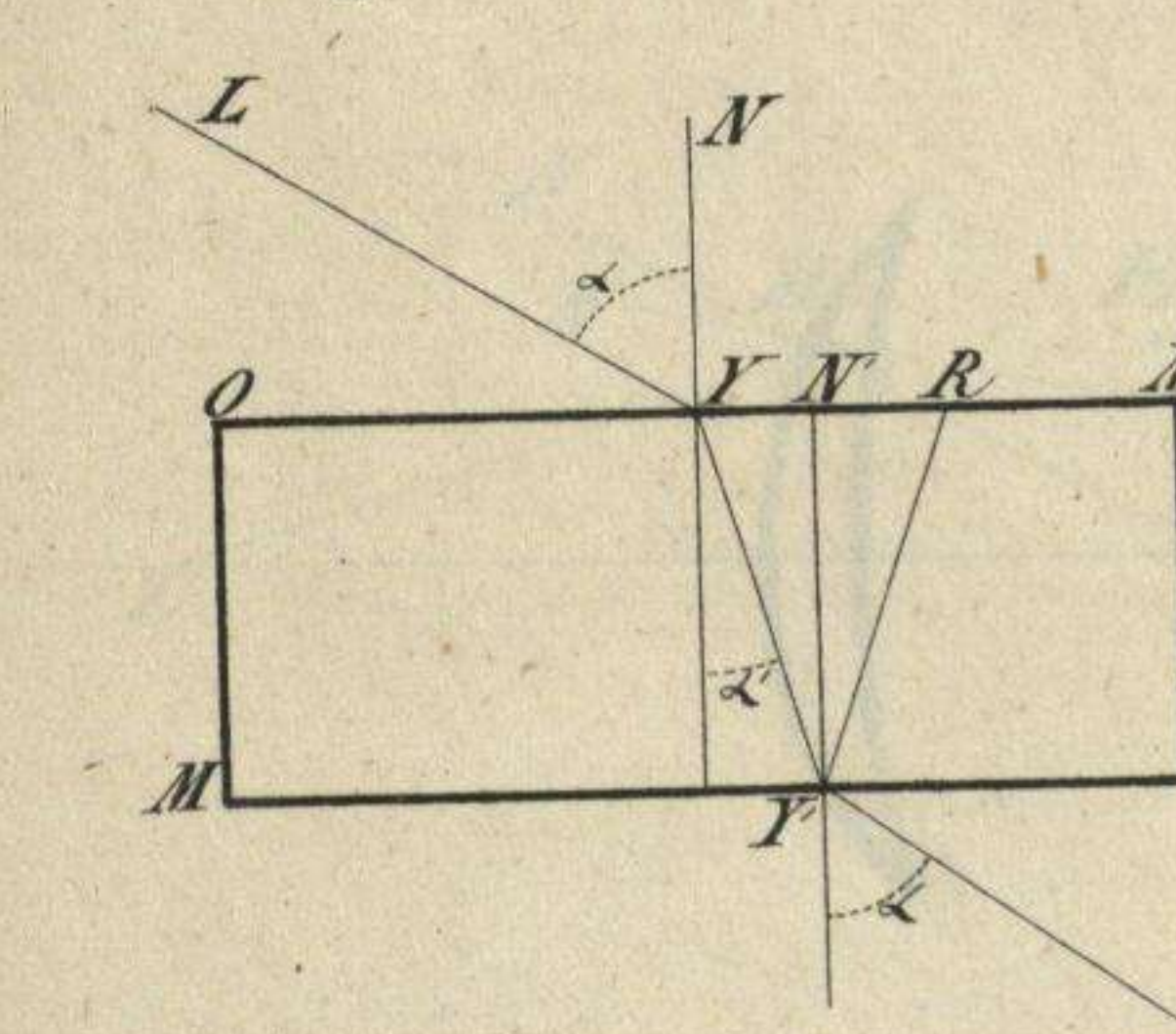
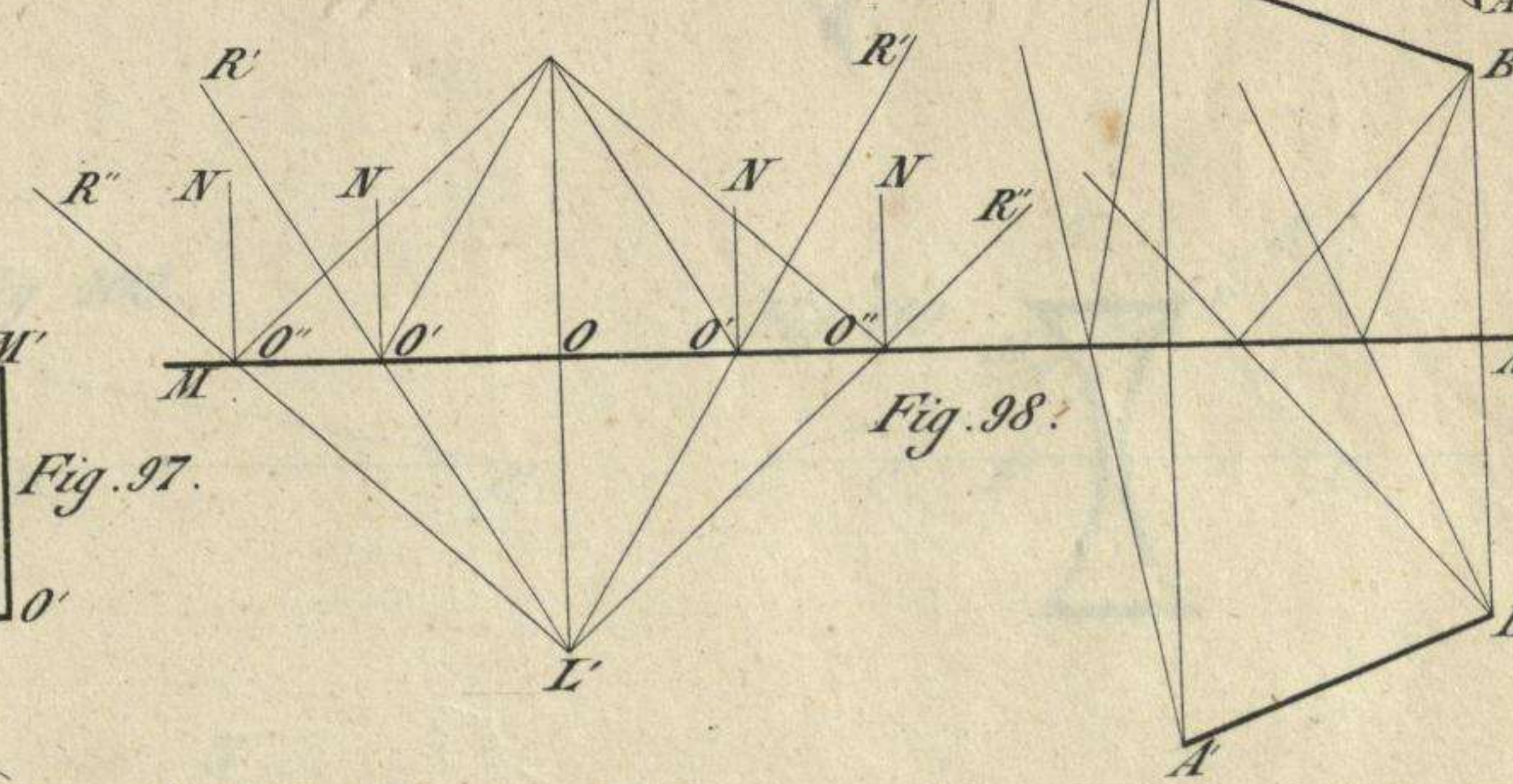
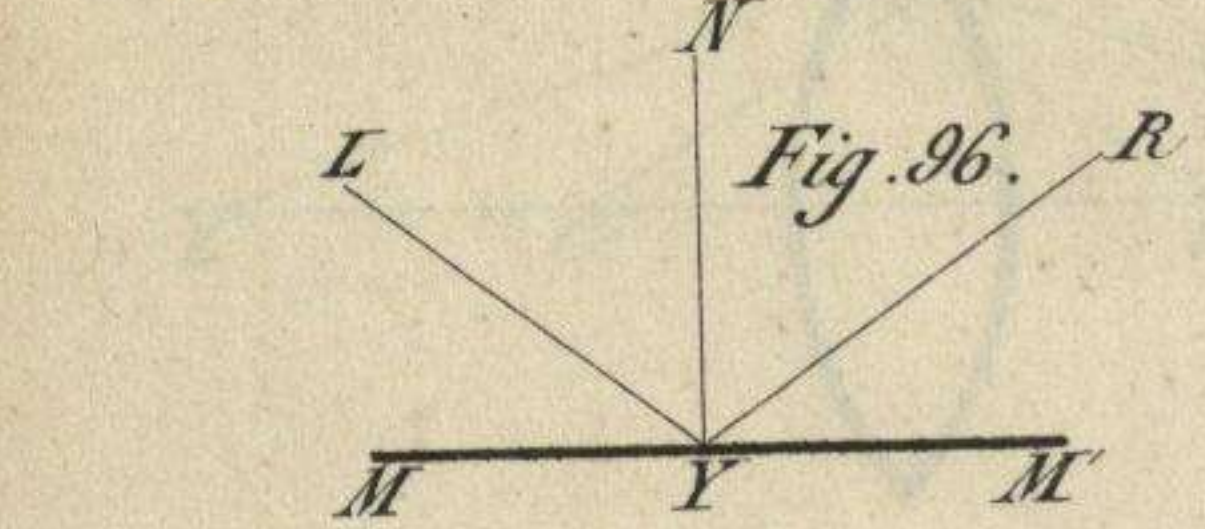
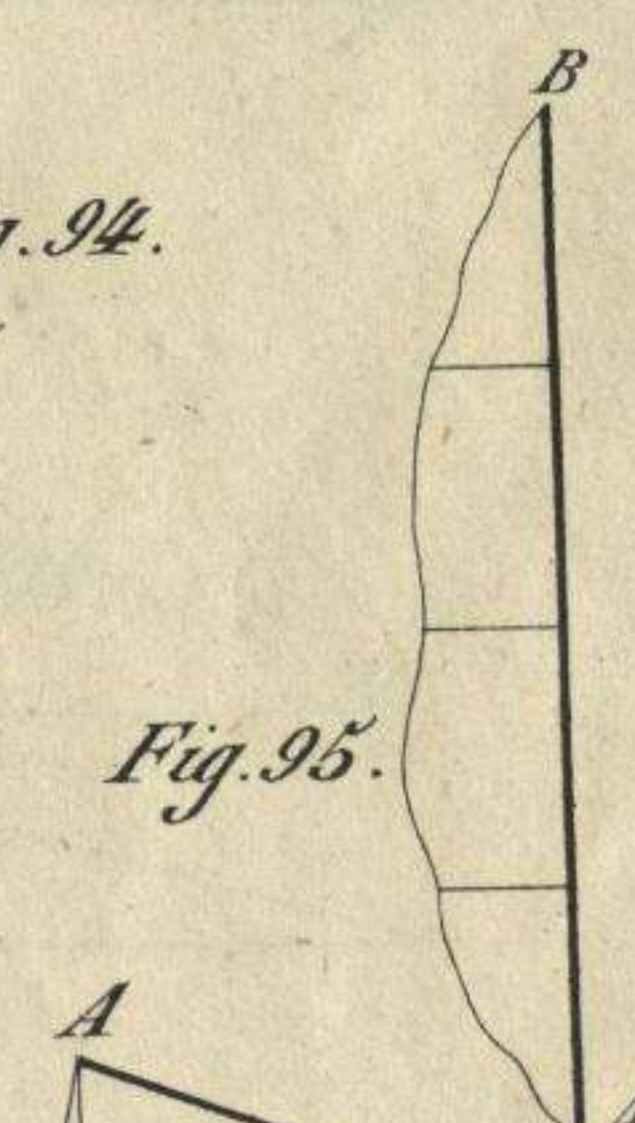
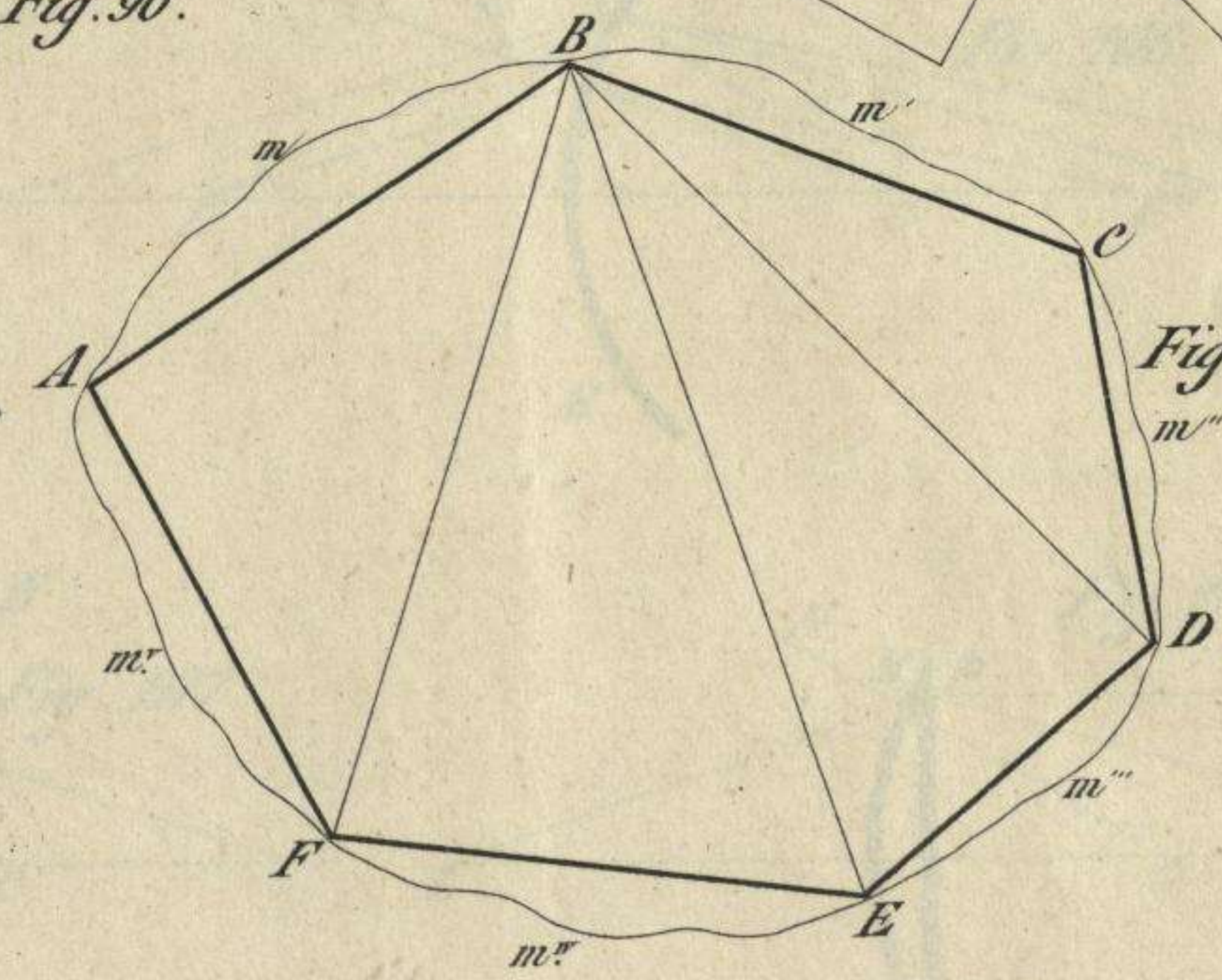
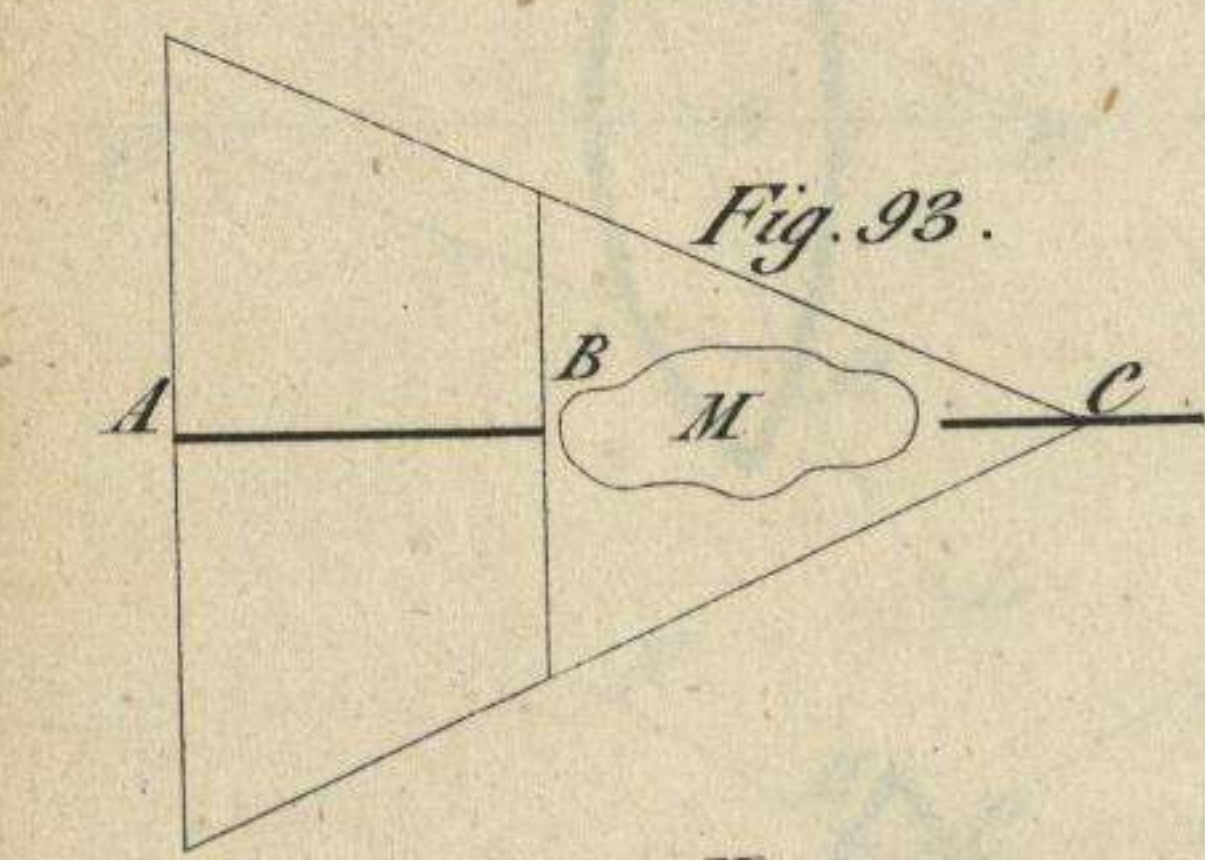
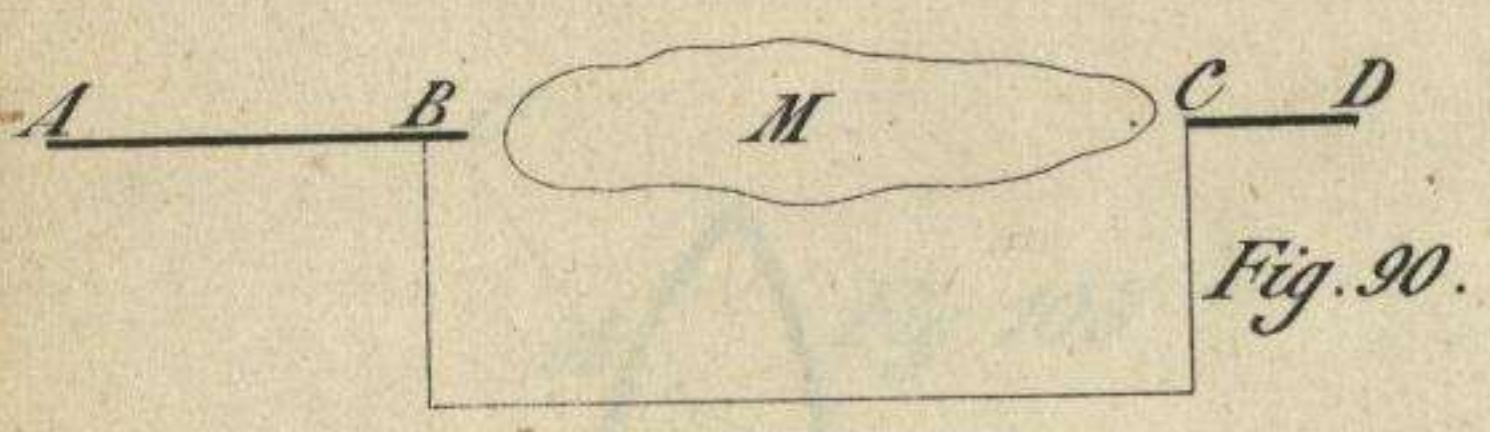
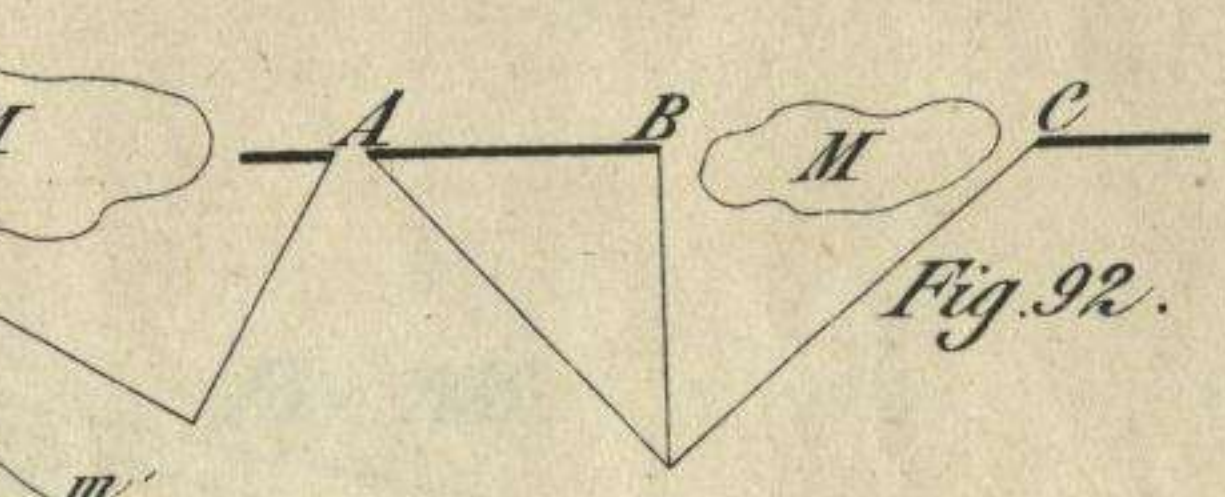
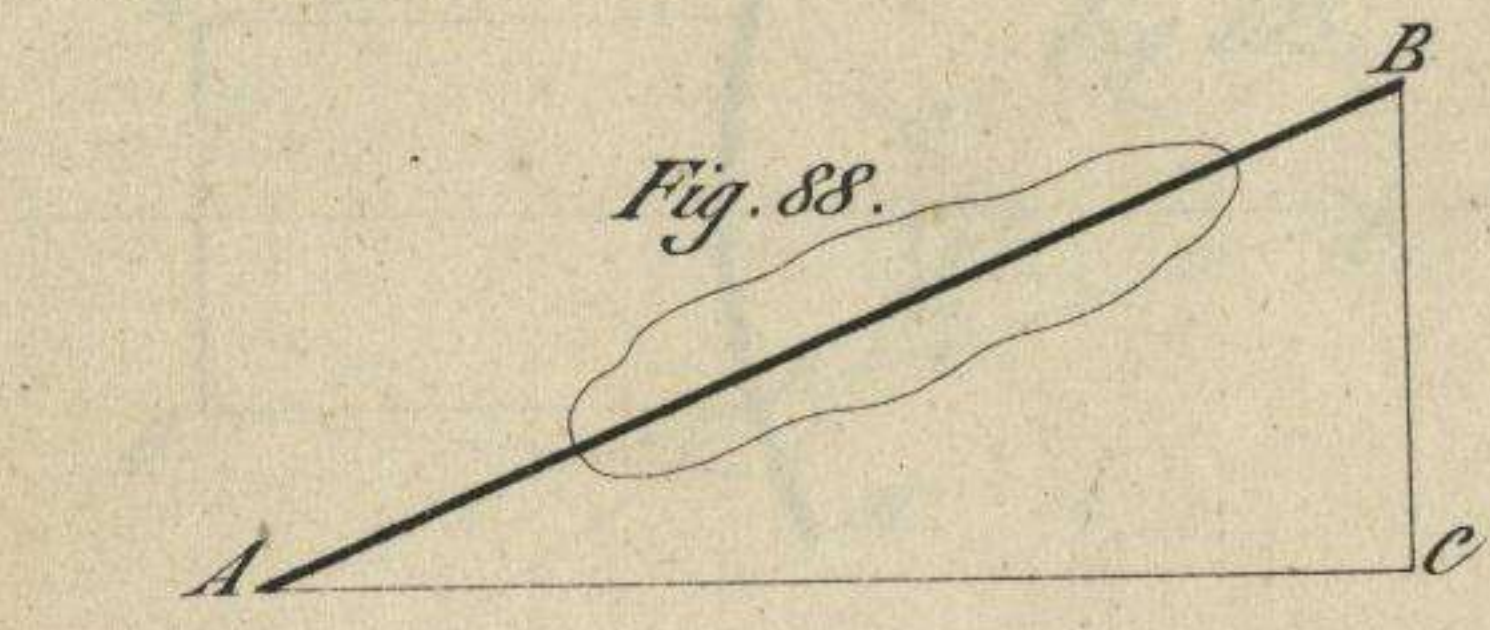
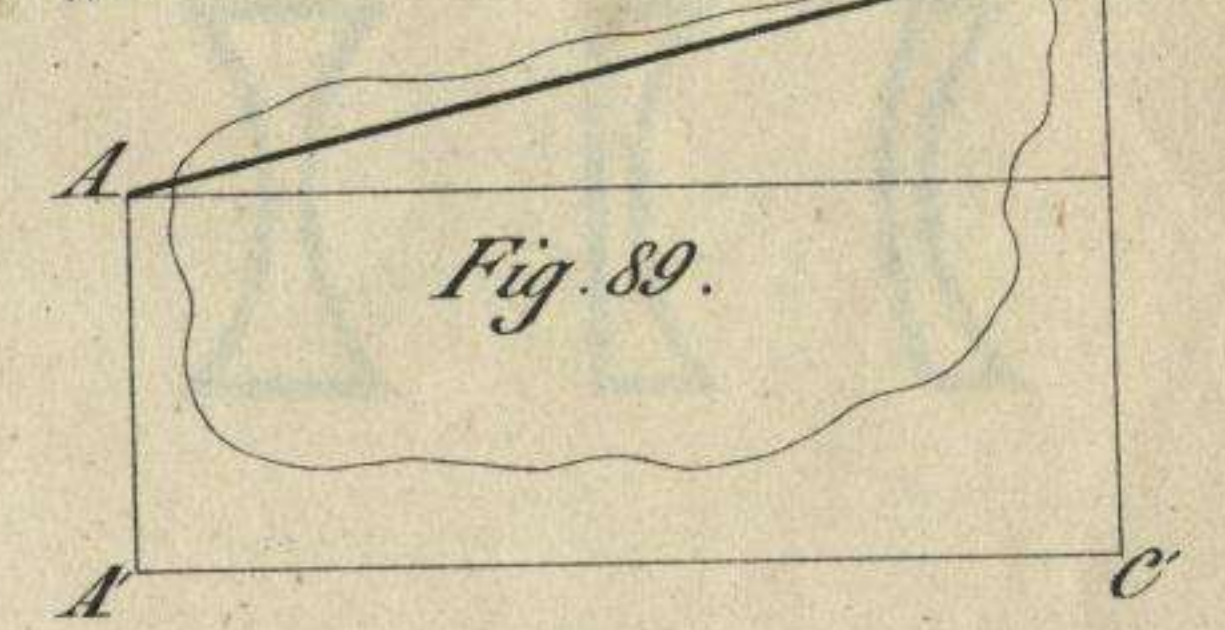
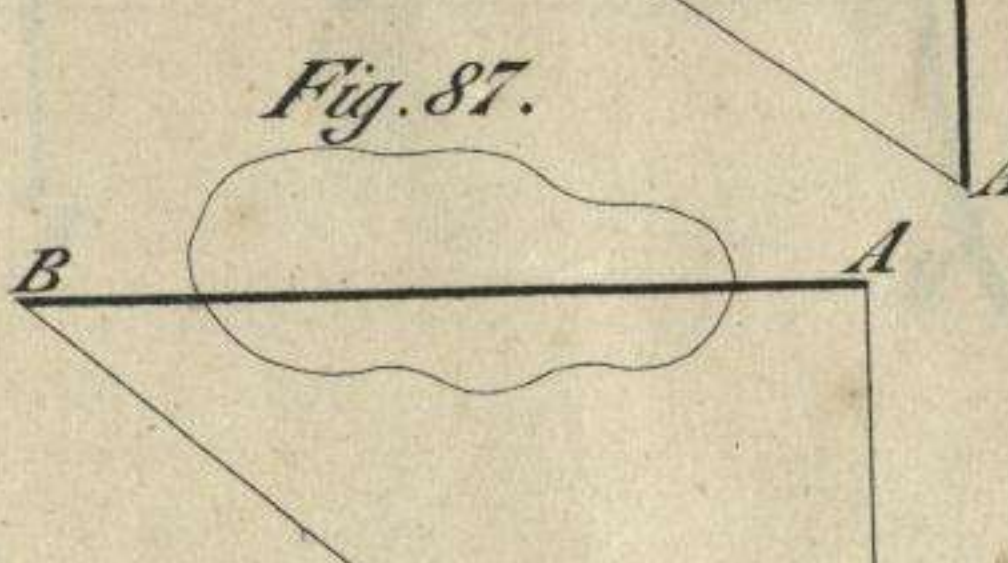
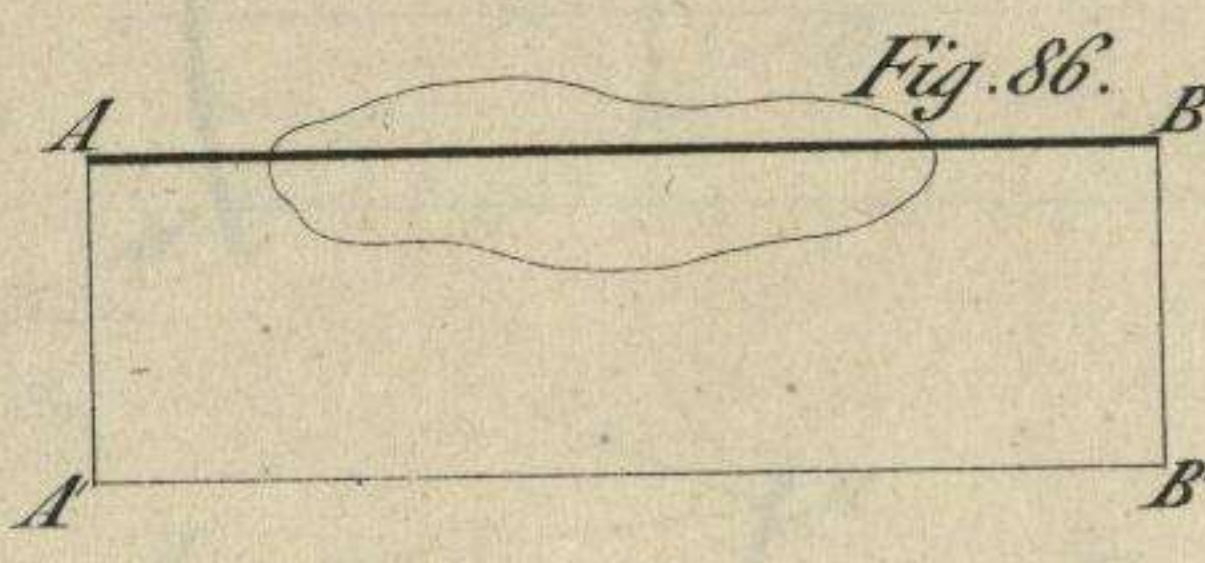
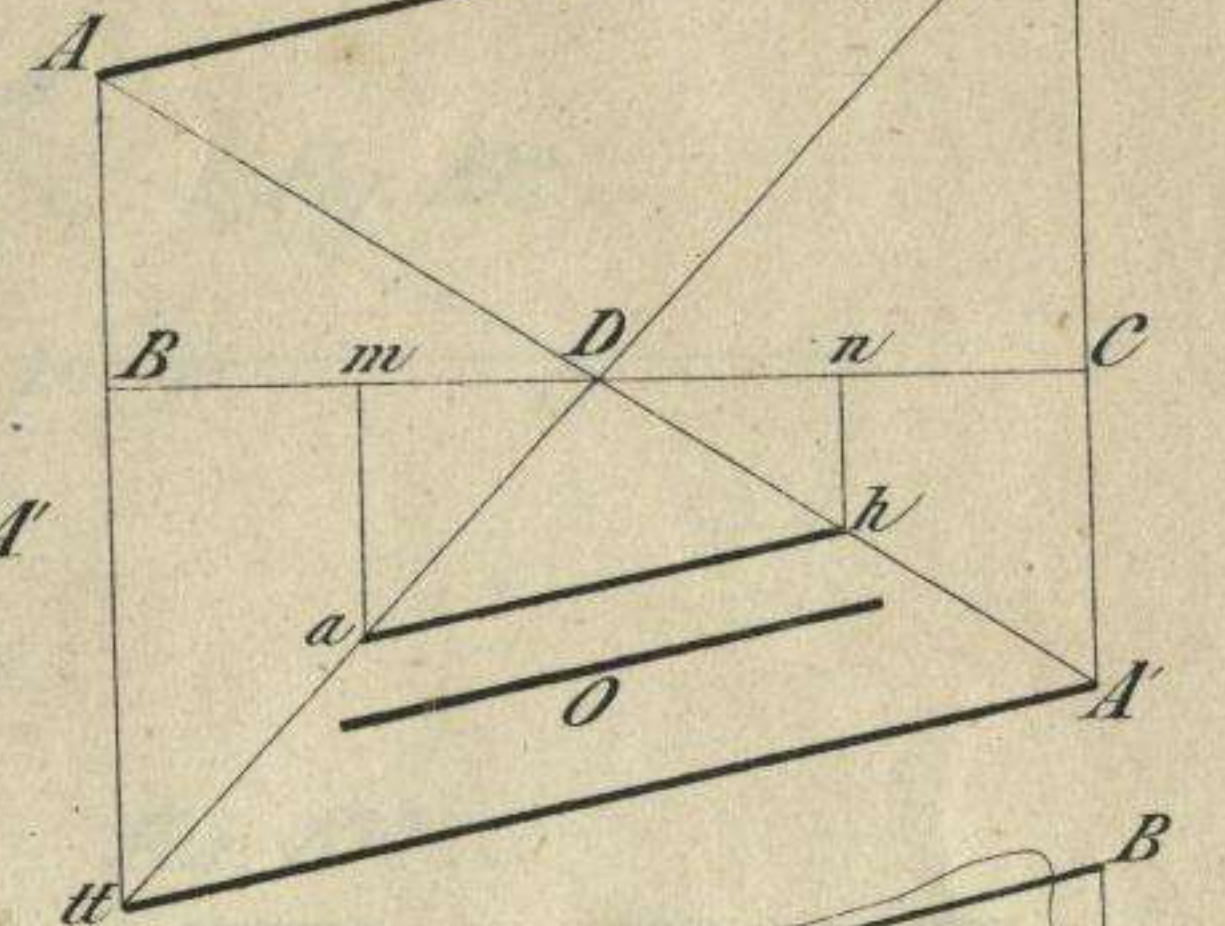
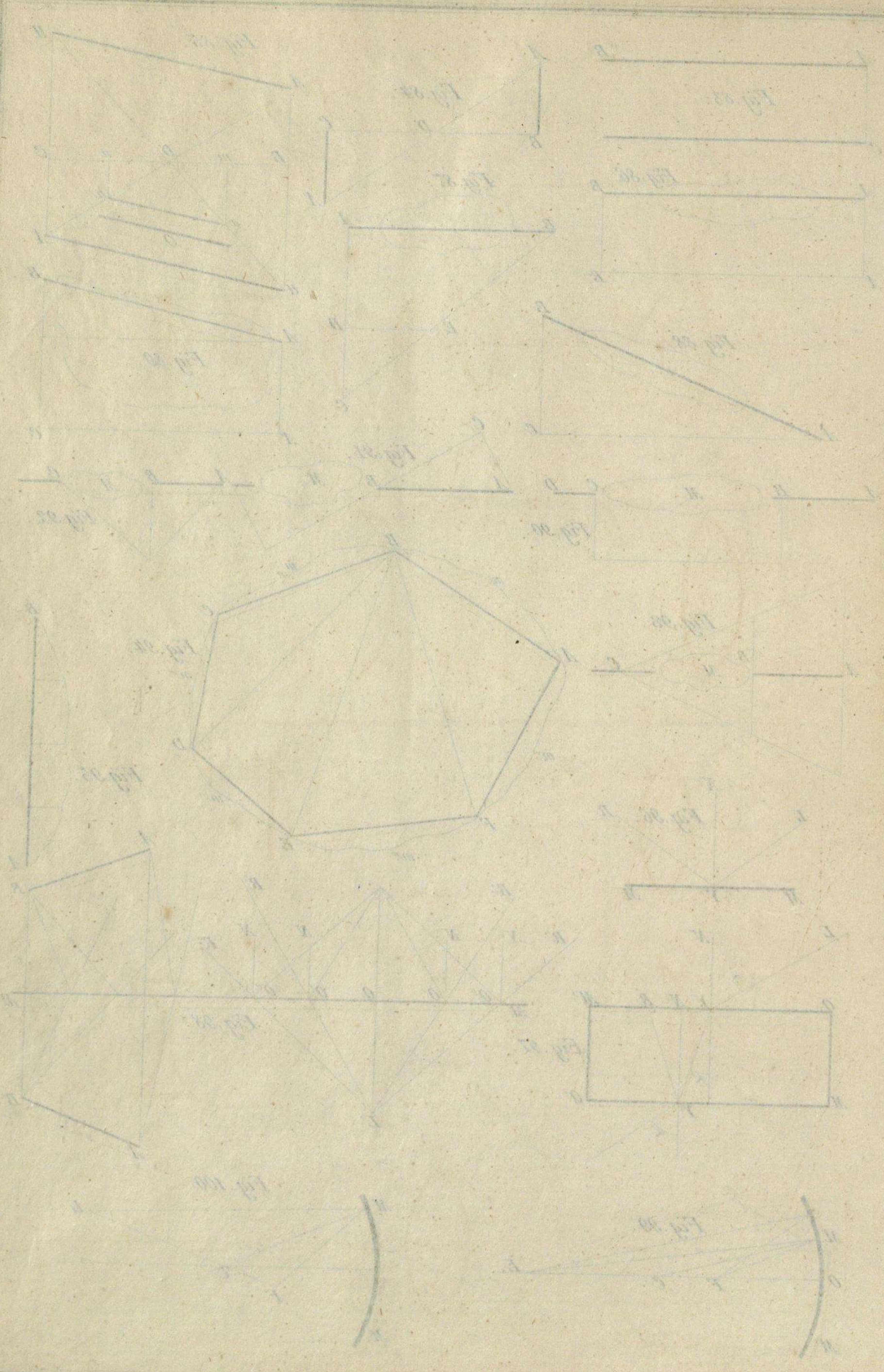
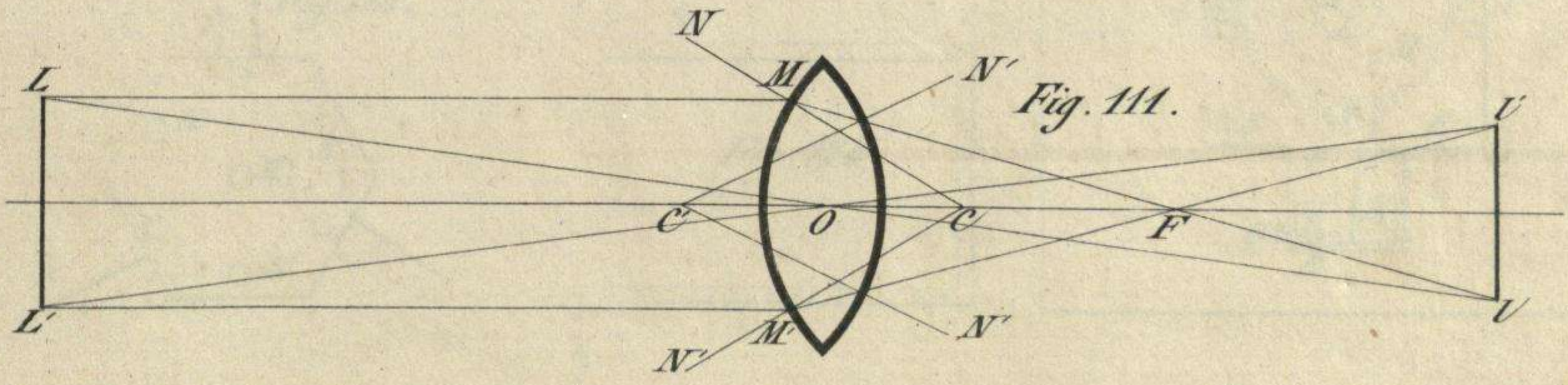
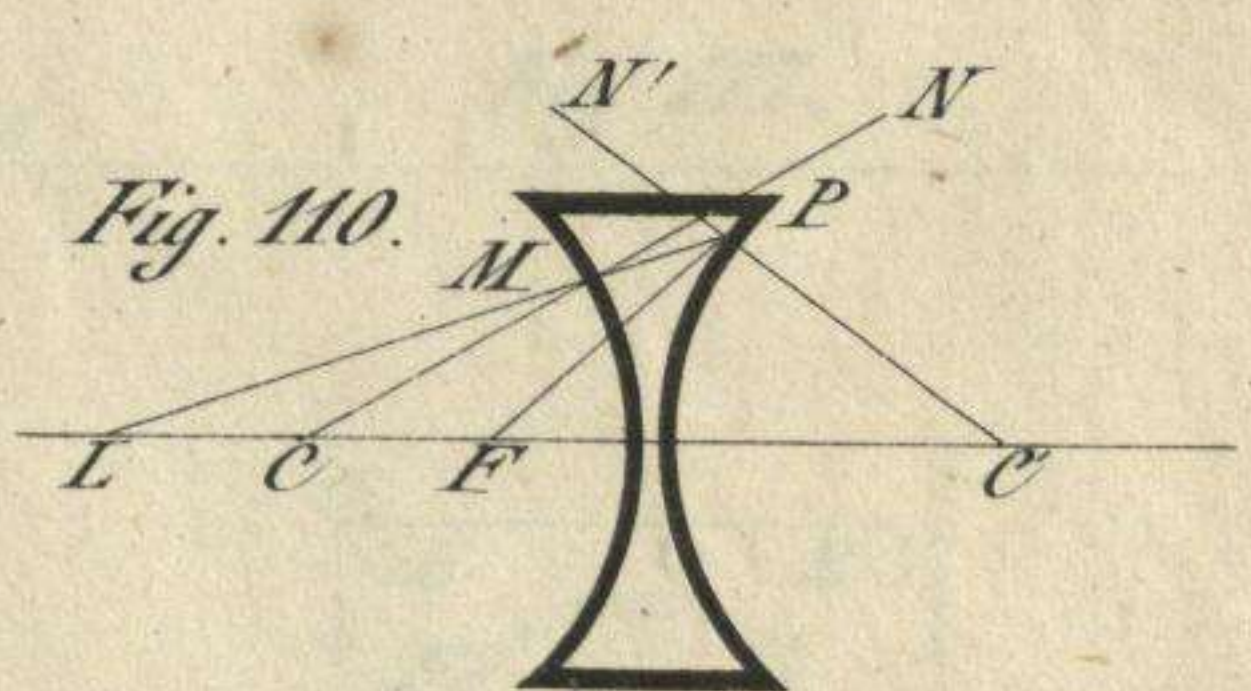
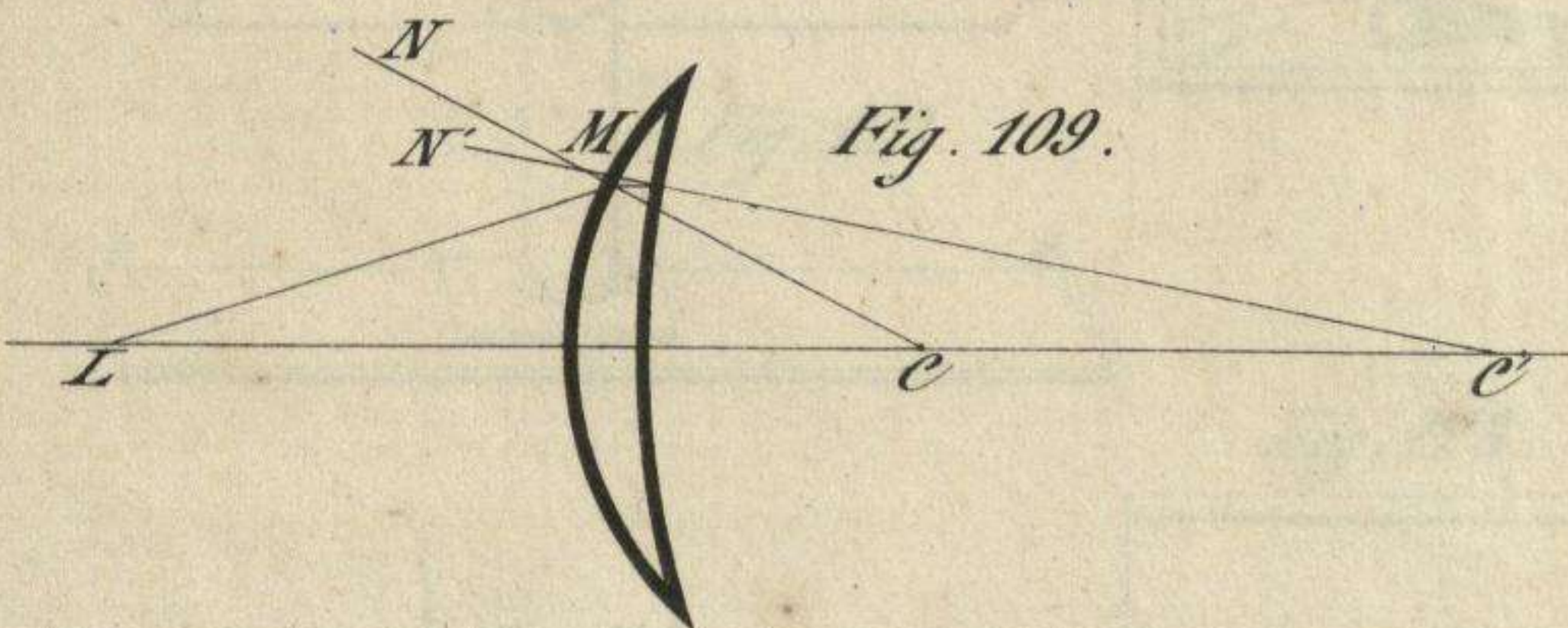
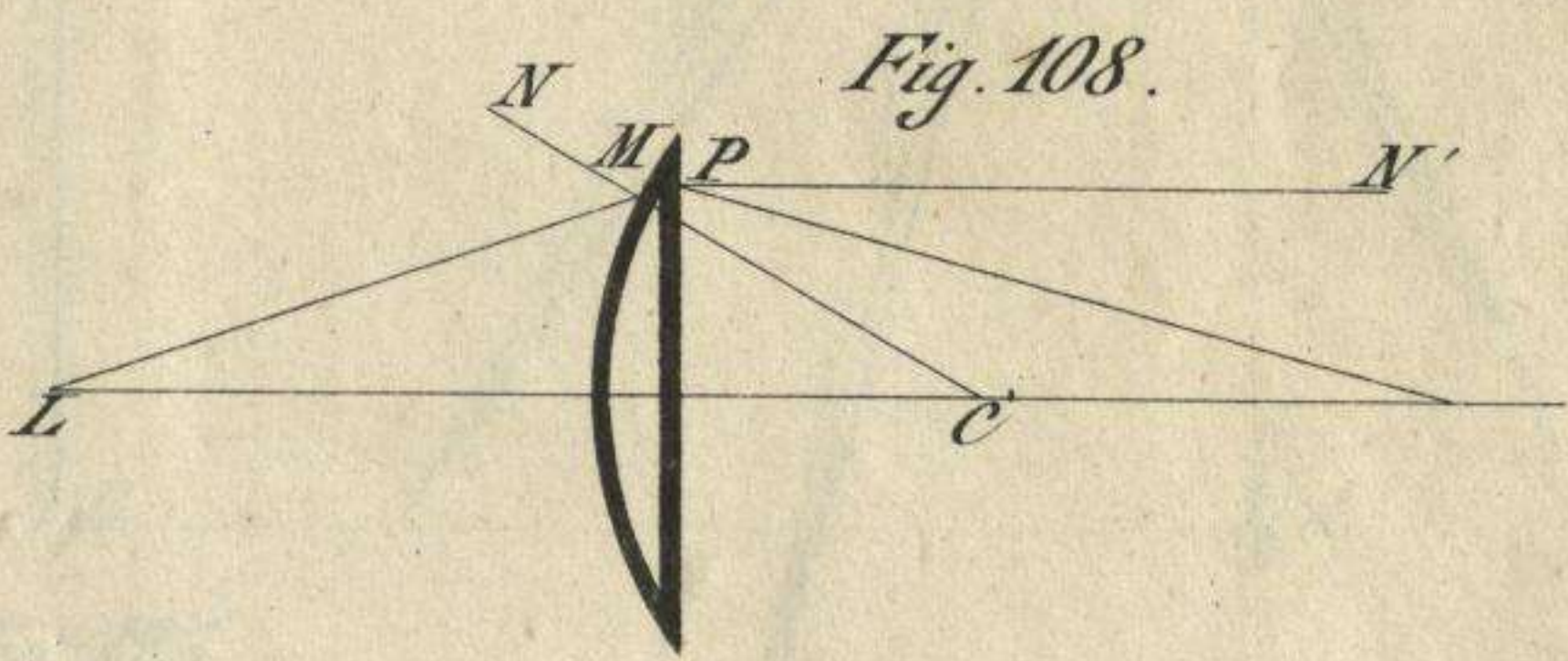
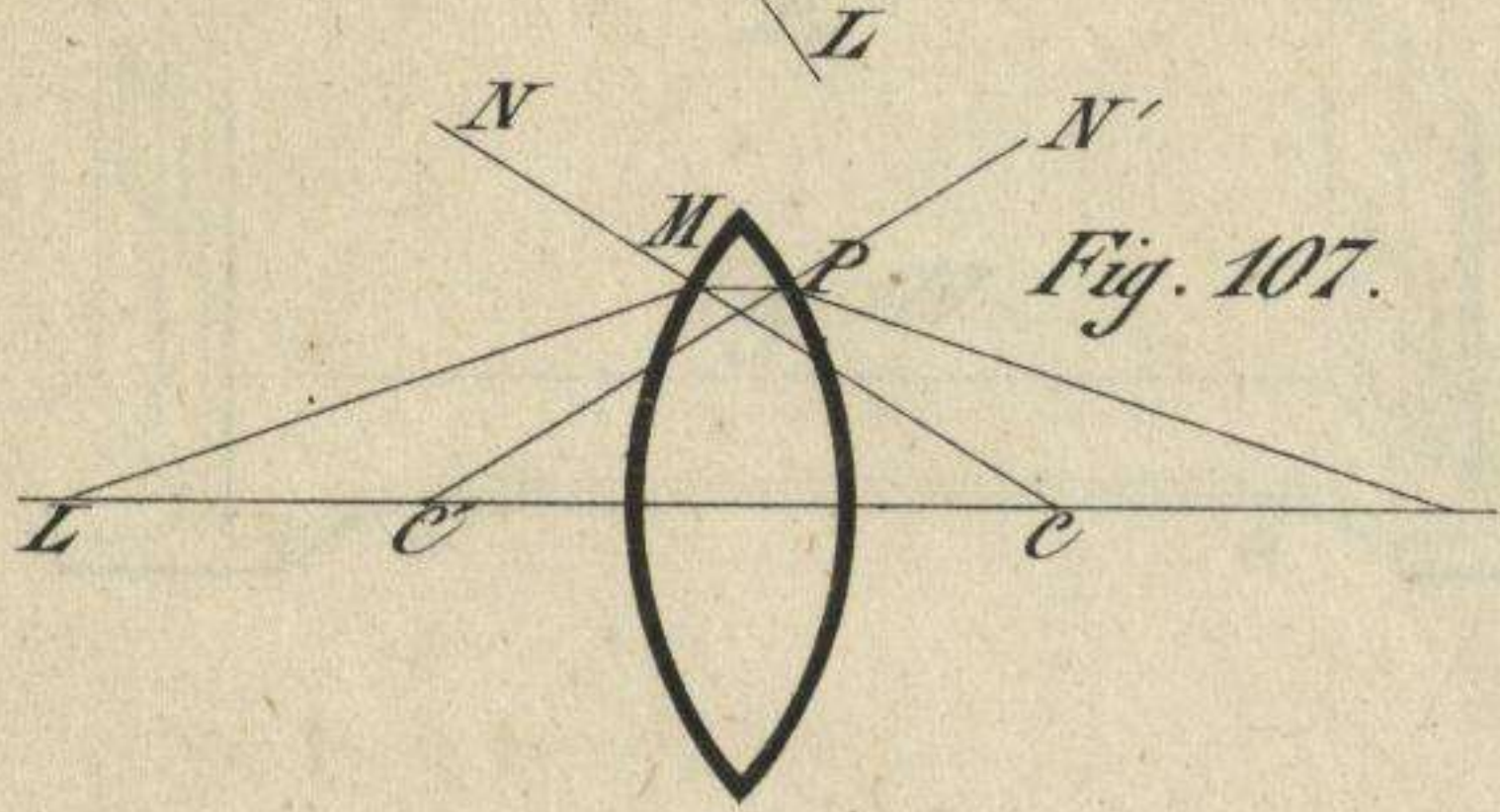
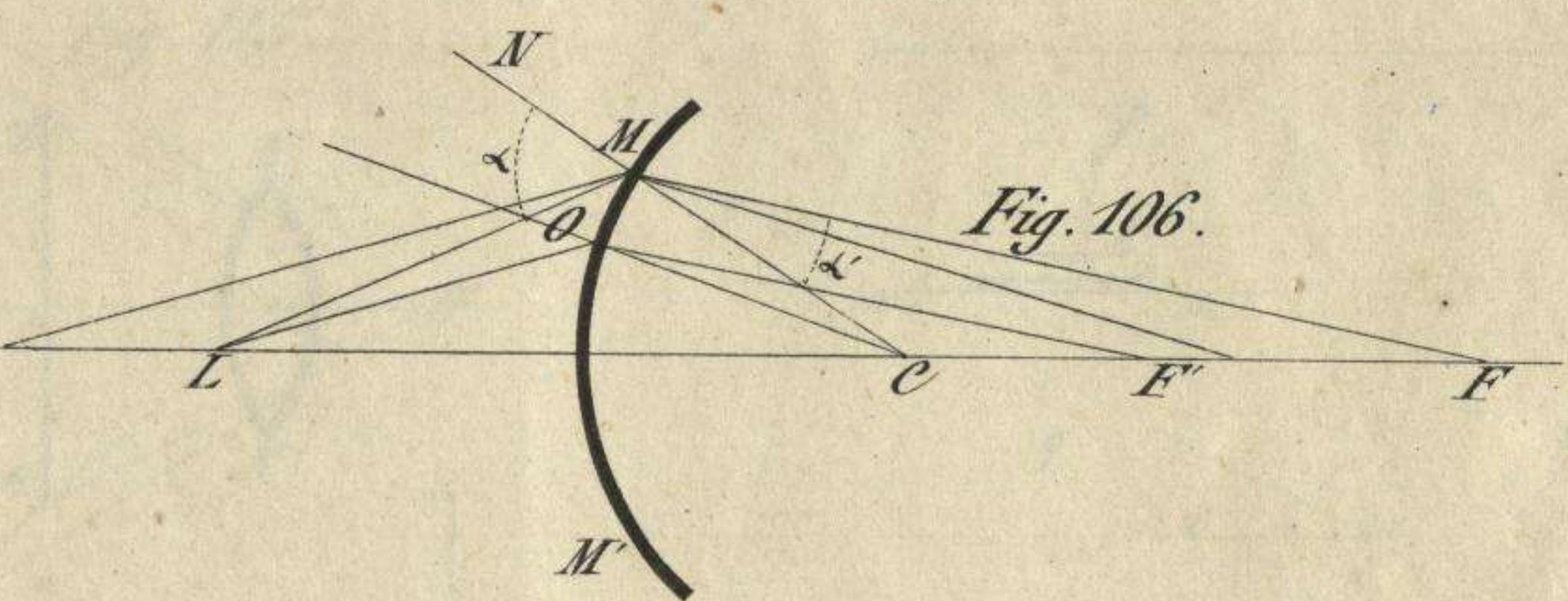
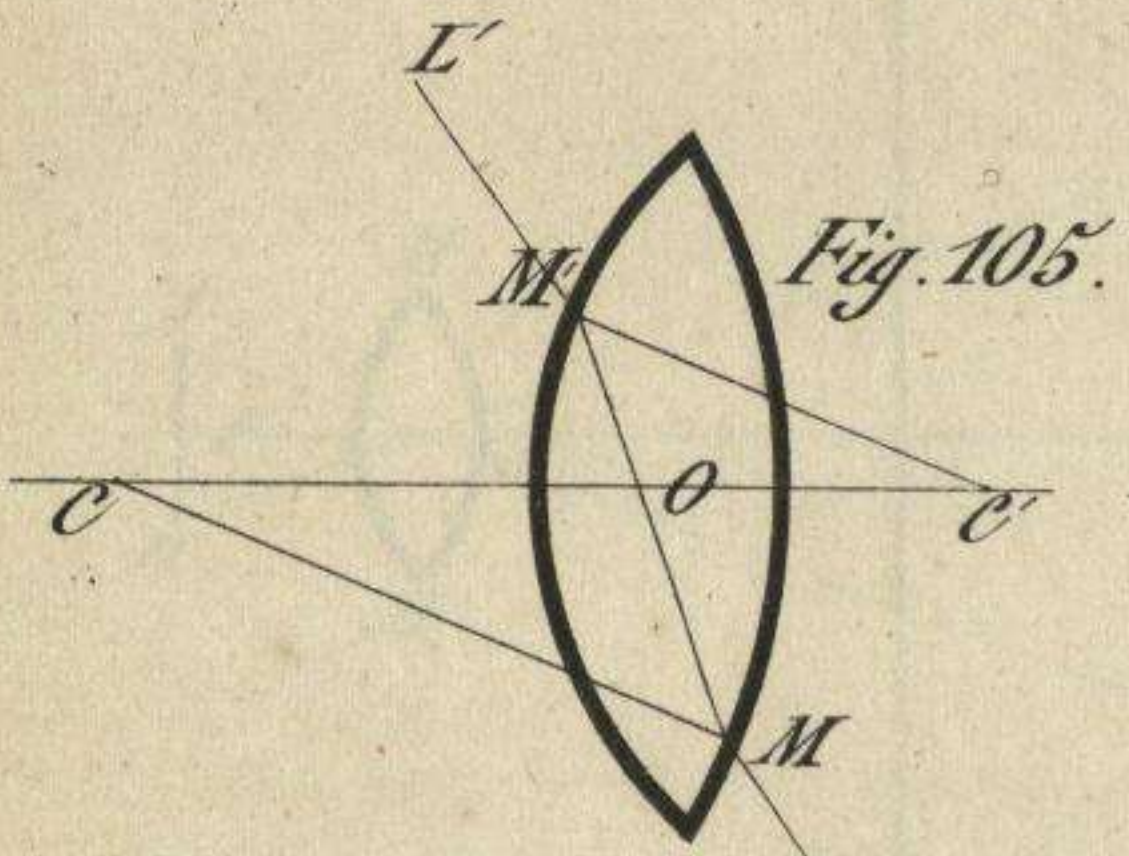
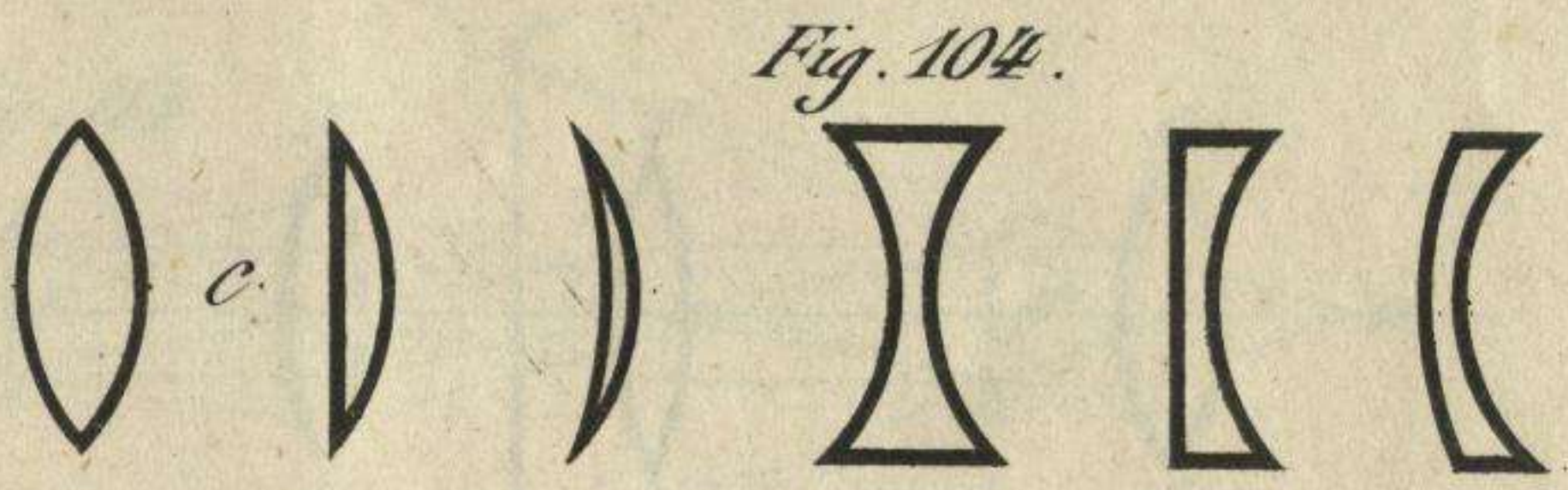
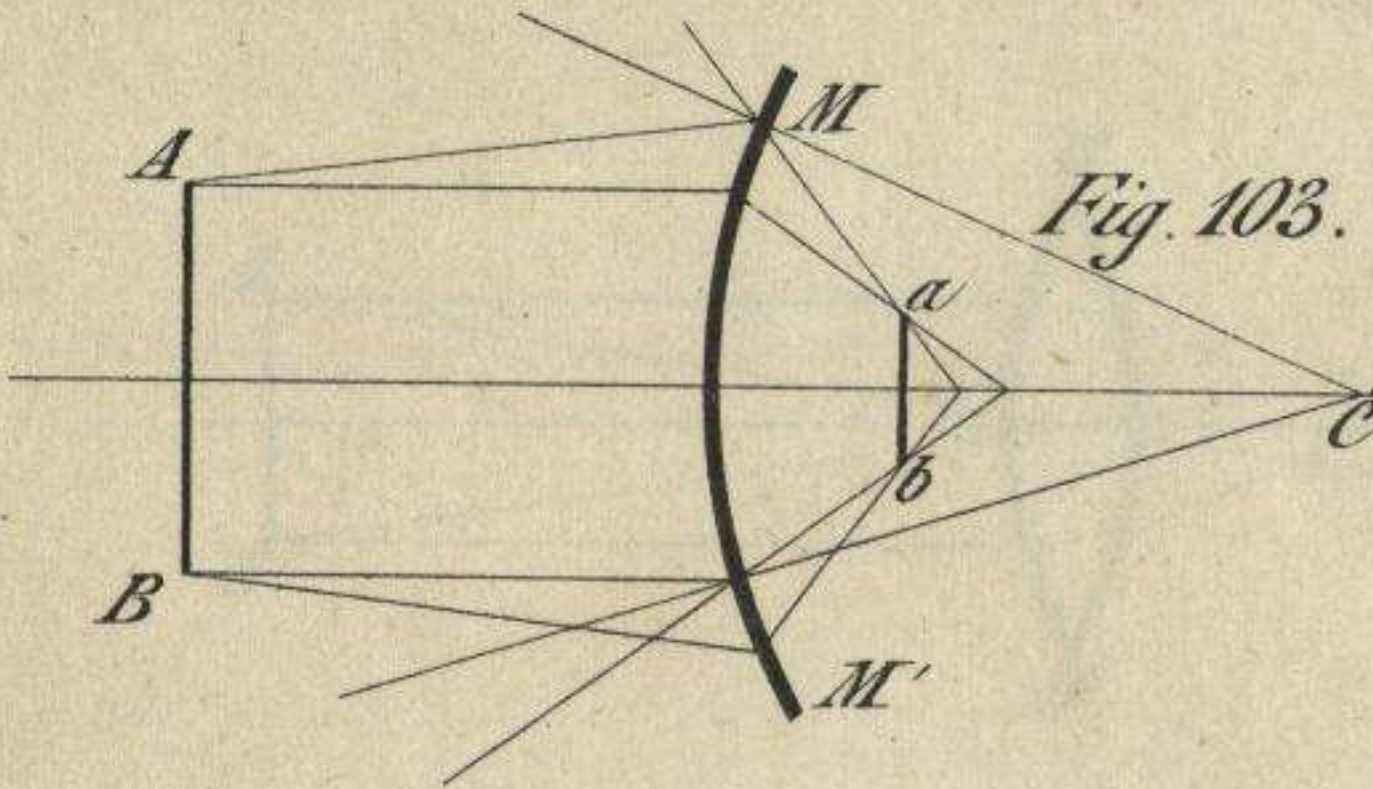
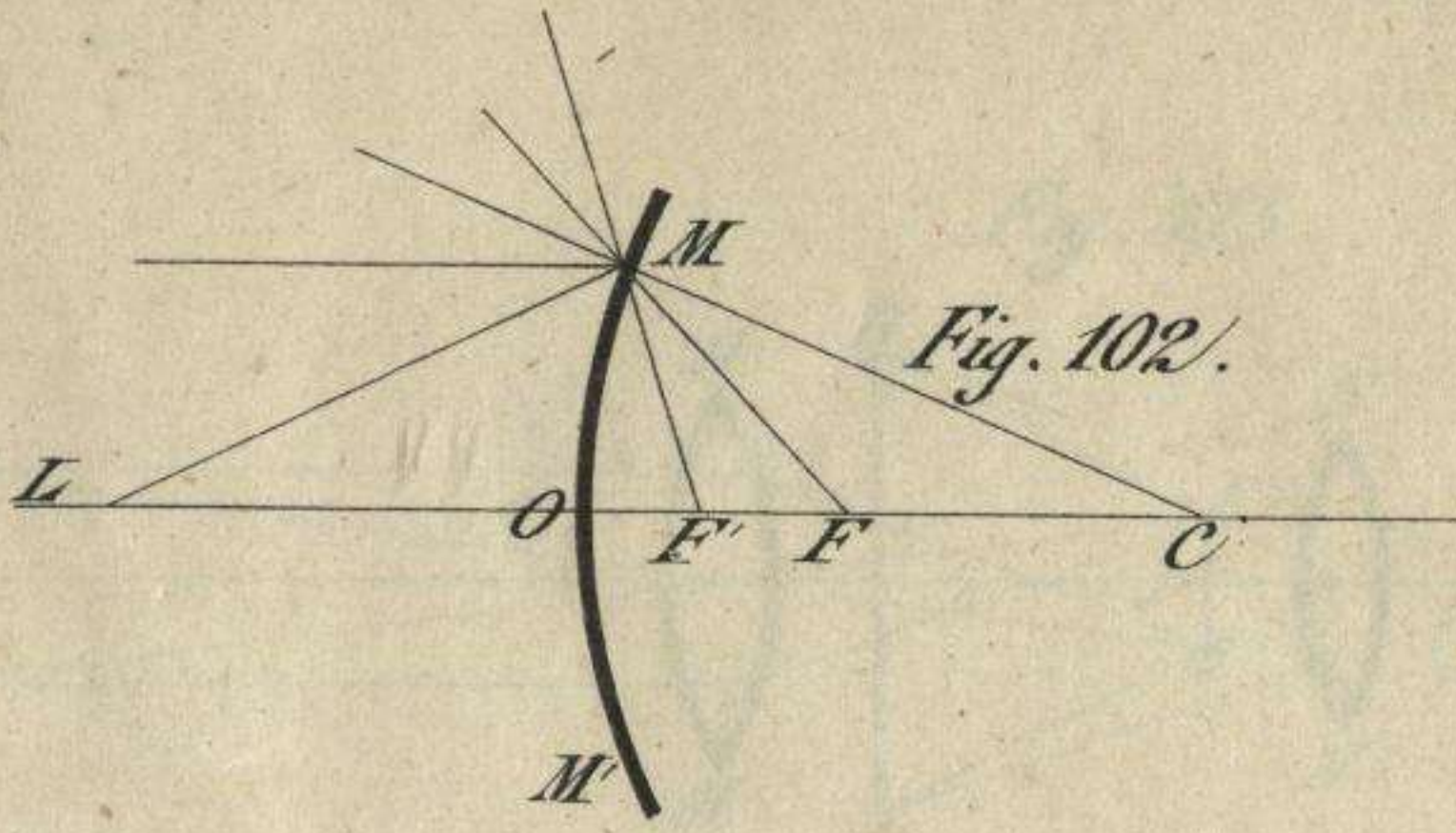
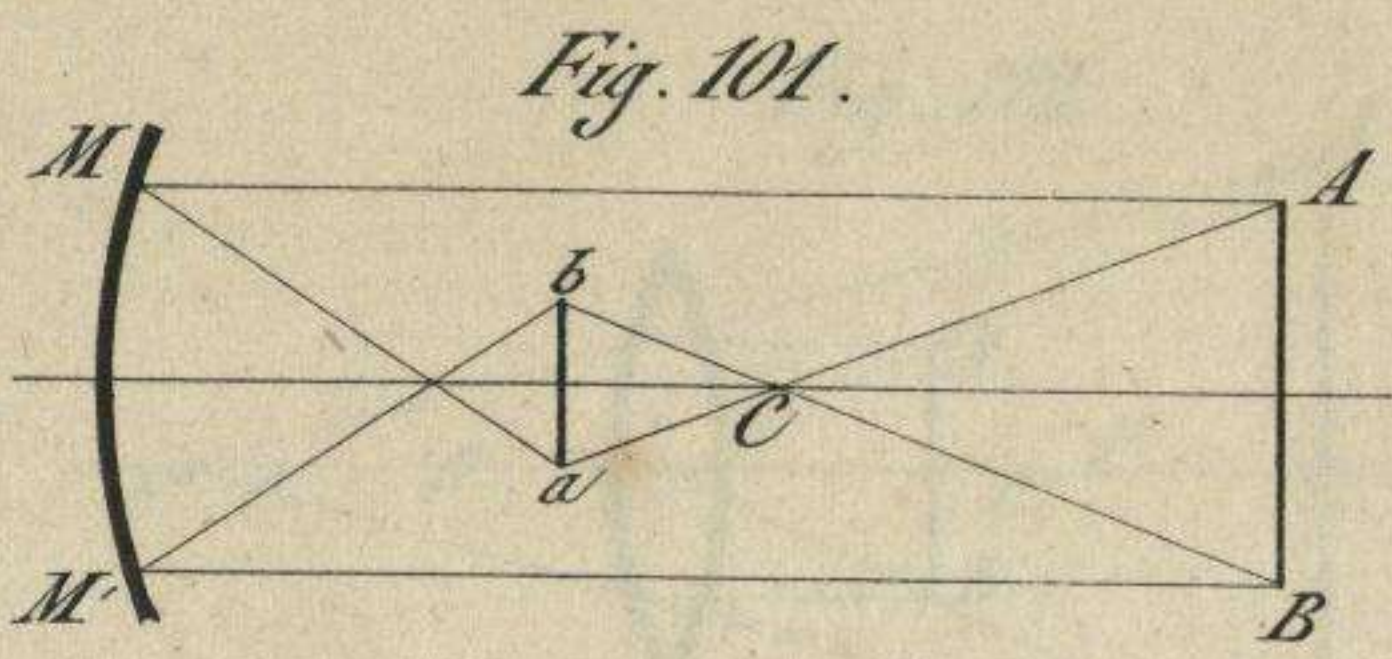

Fig. 85.







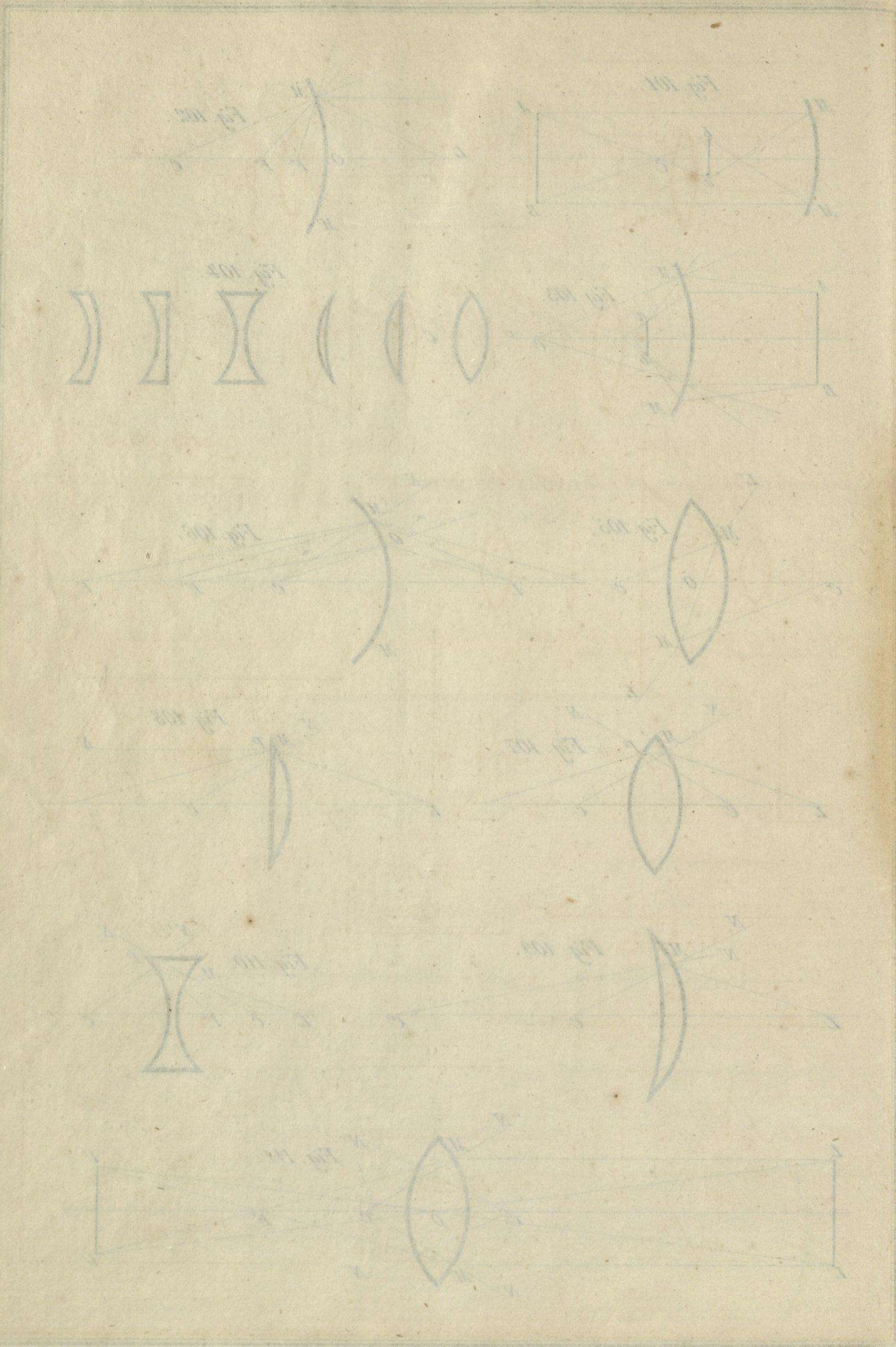

Fig. 112.

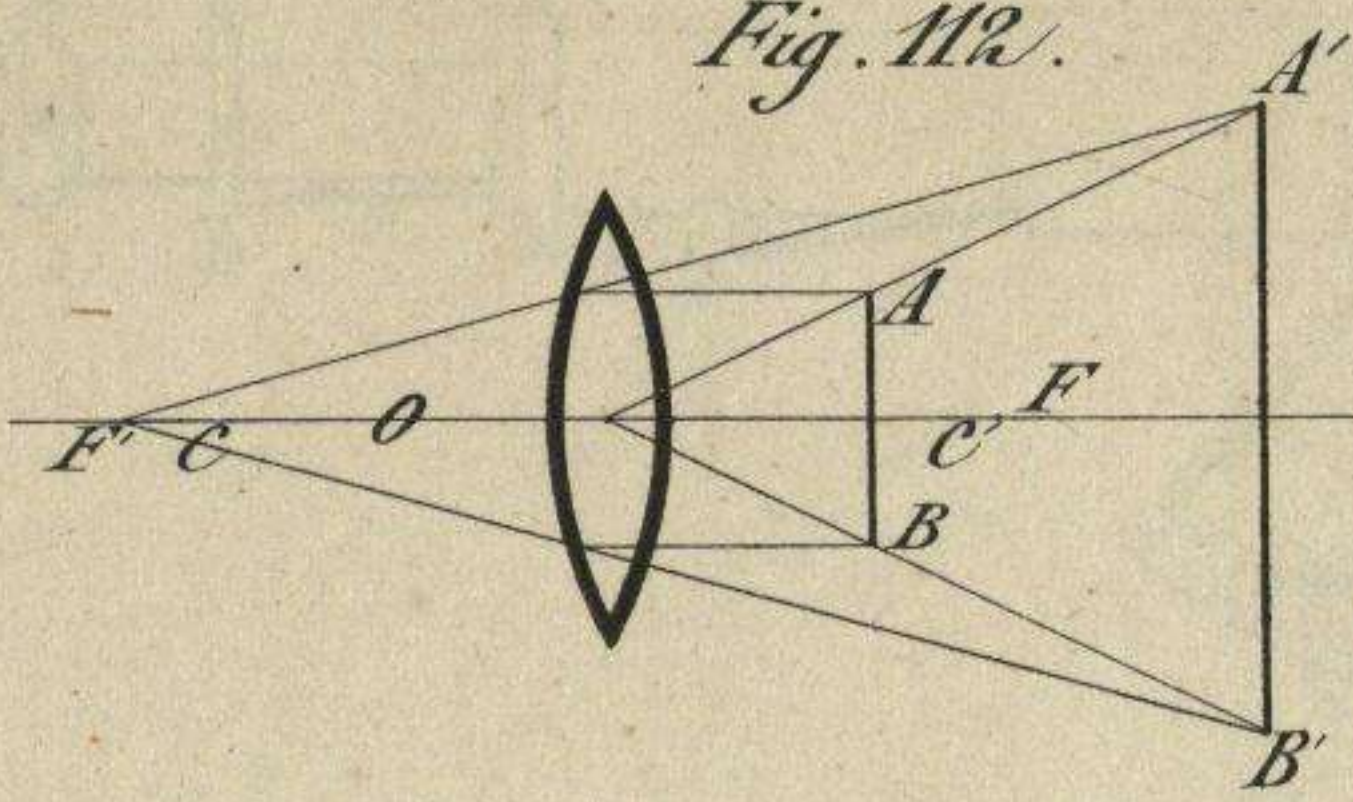

Fig. 113.

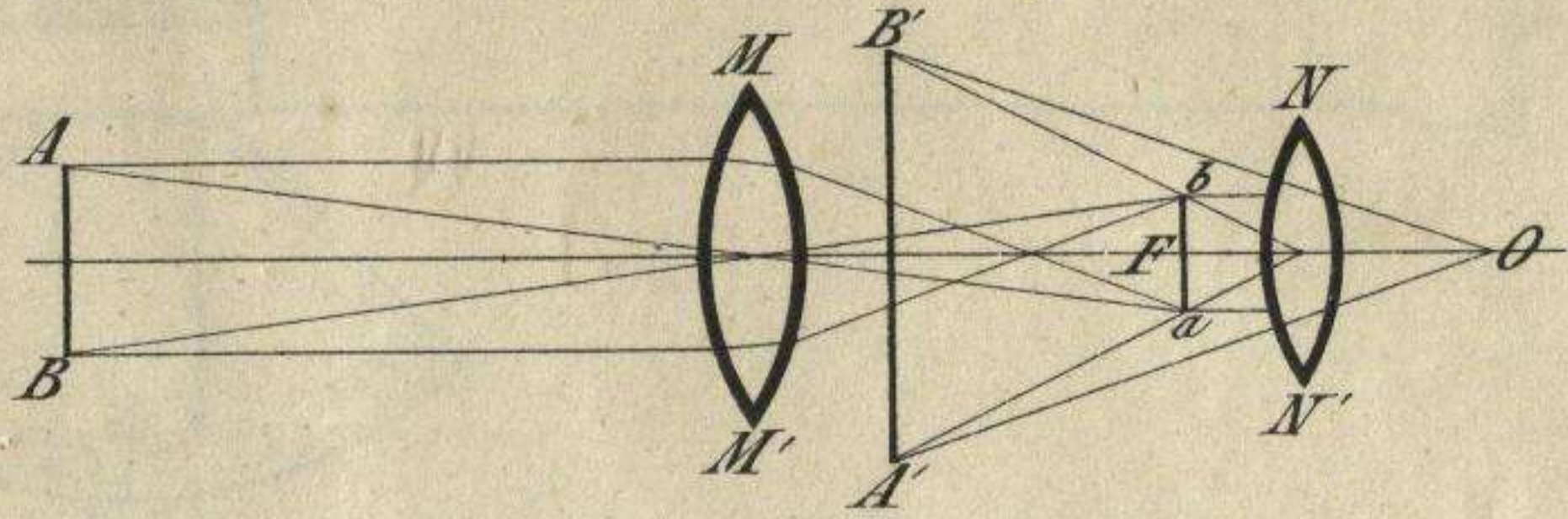

Fig. 114.

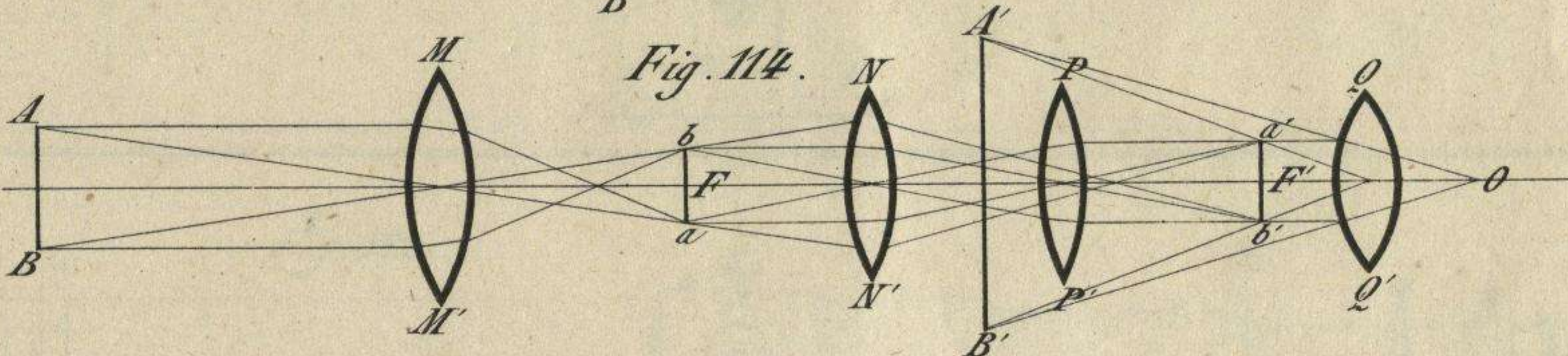

Fig. 115.

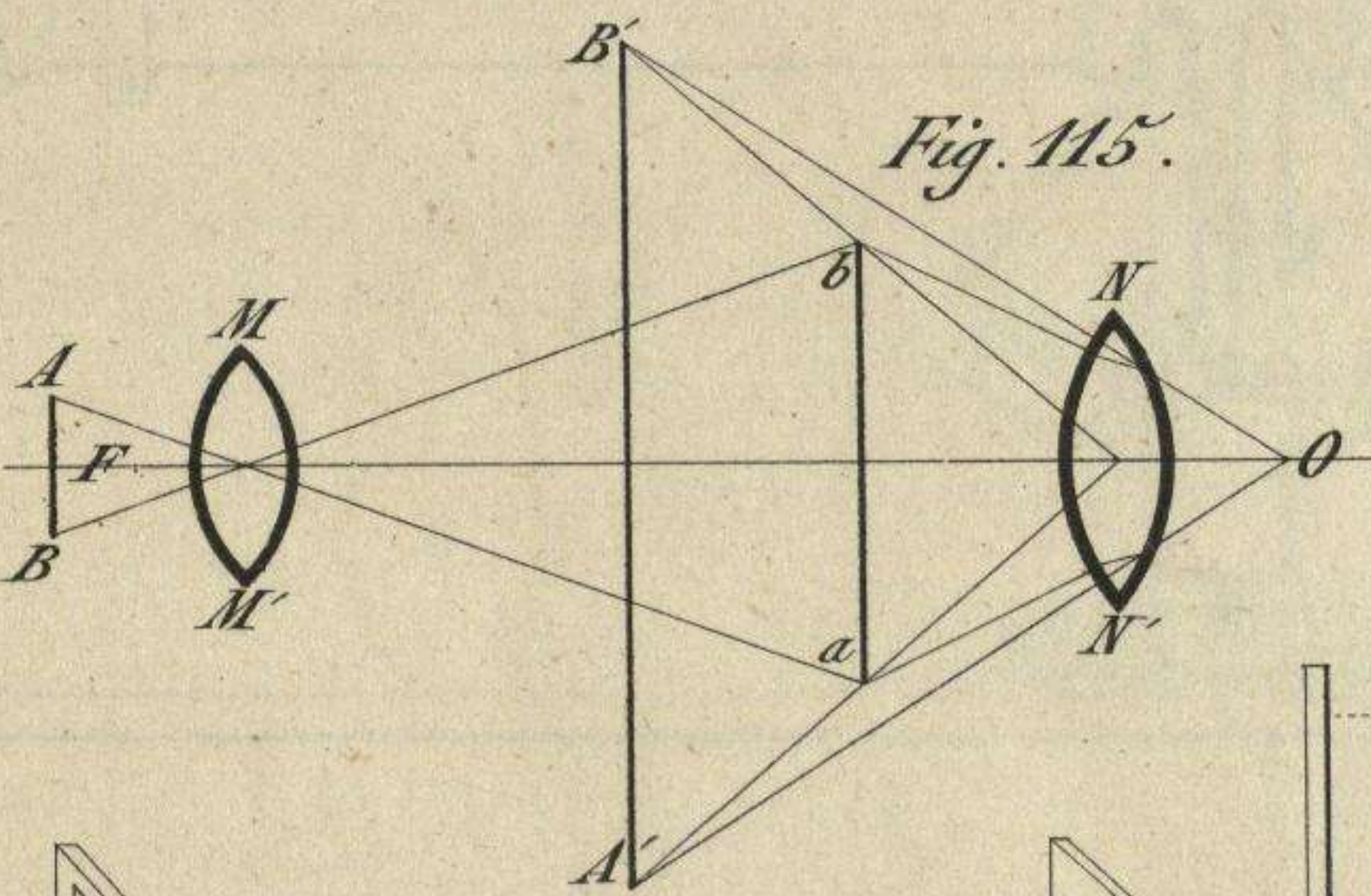

Fig. 116.

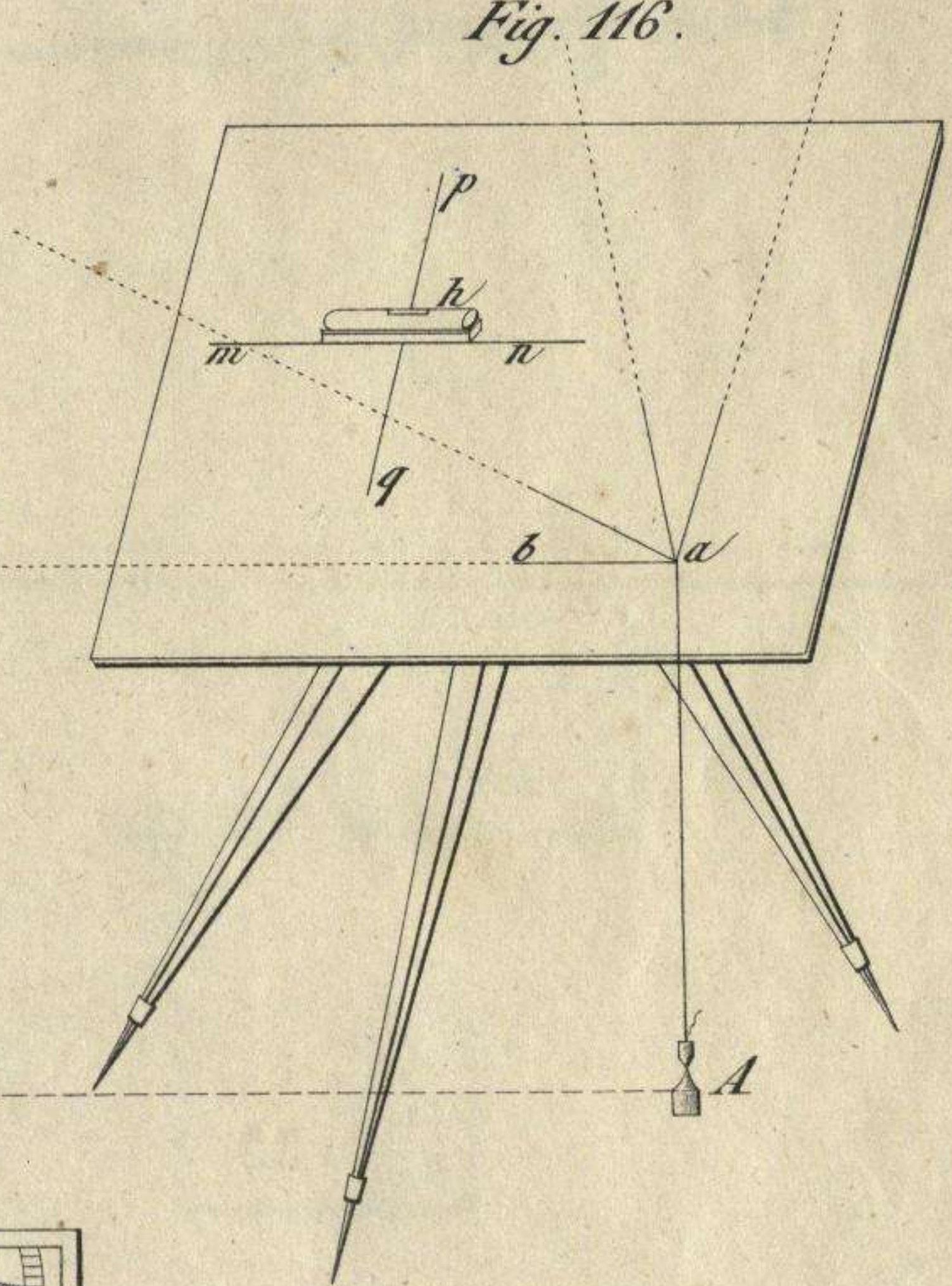

Fig. 119.

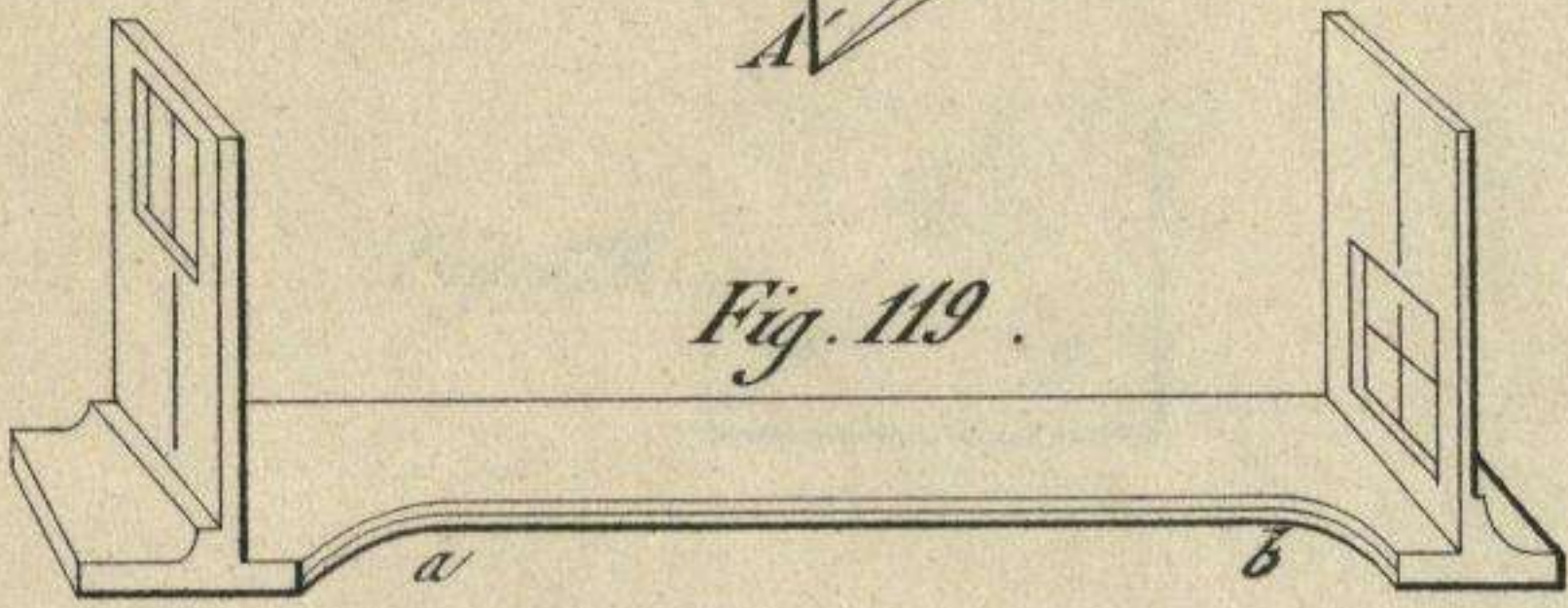

Fig. 125.

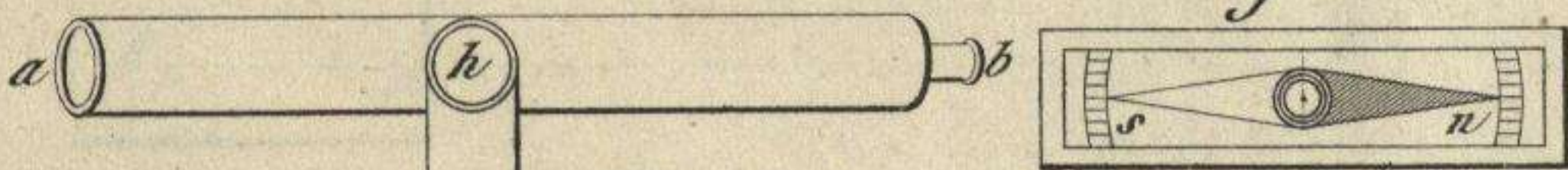

Fig. 120.

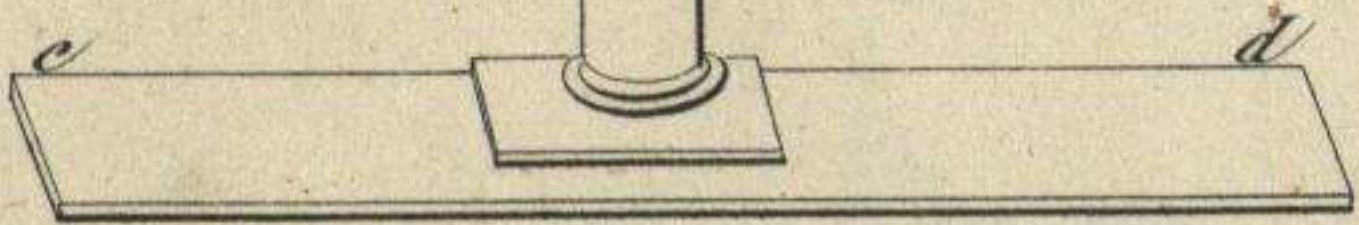

Fig. 117.

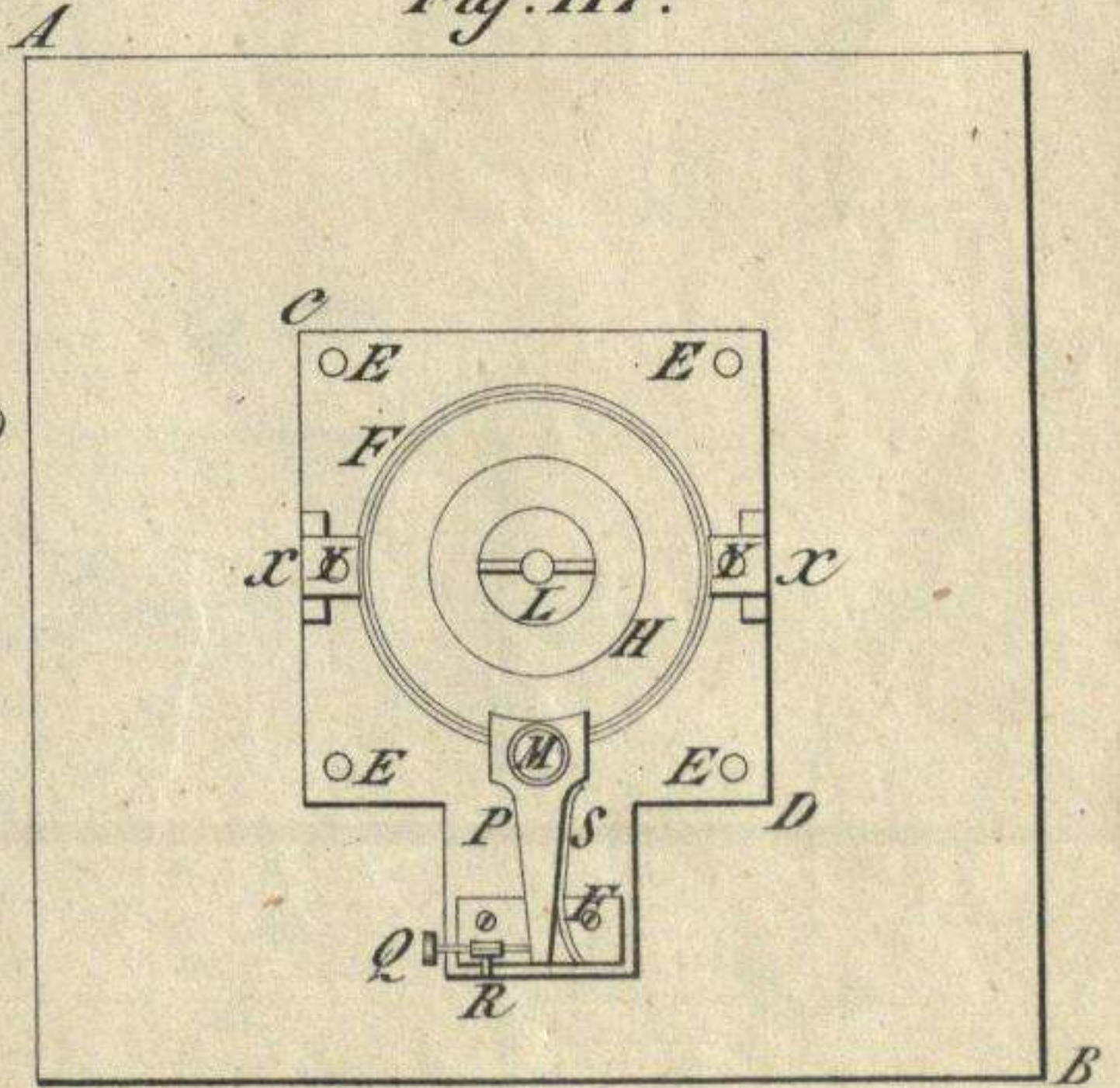

Fig. 123.

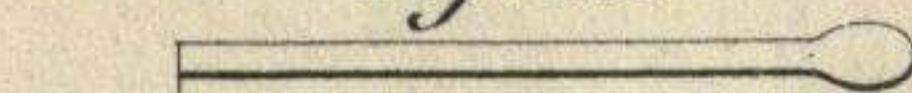

Fig. 124.

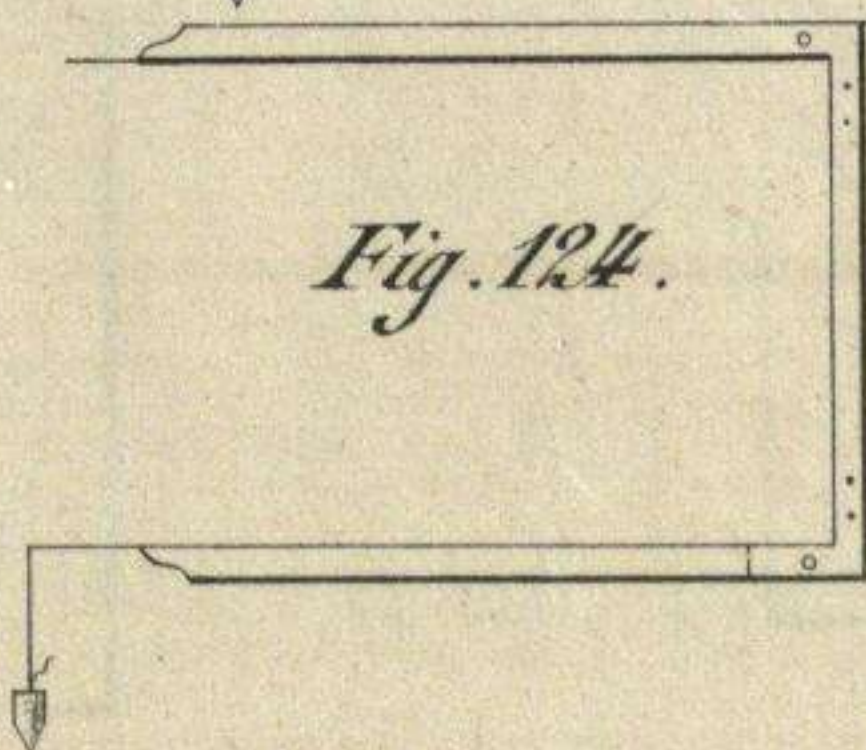
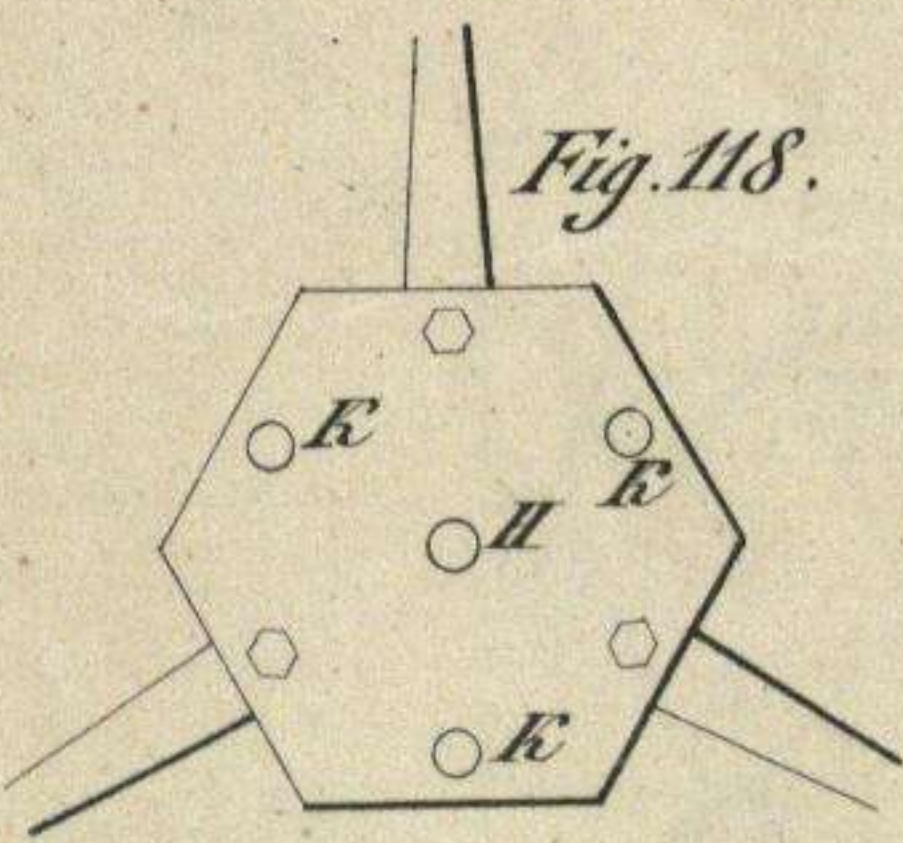

Fig. 118.



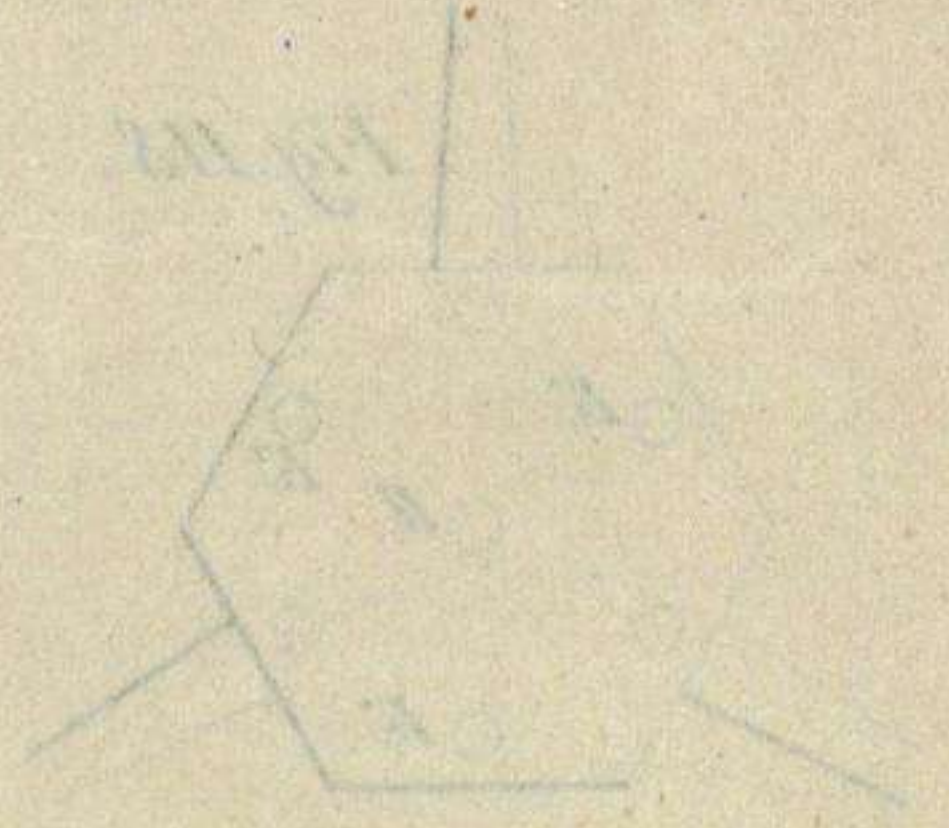
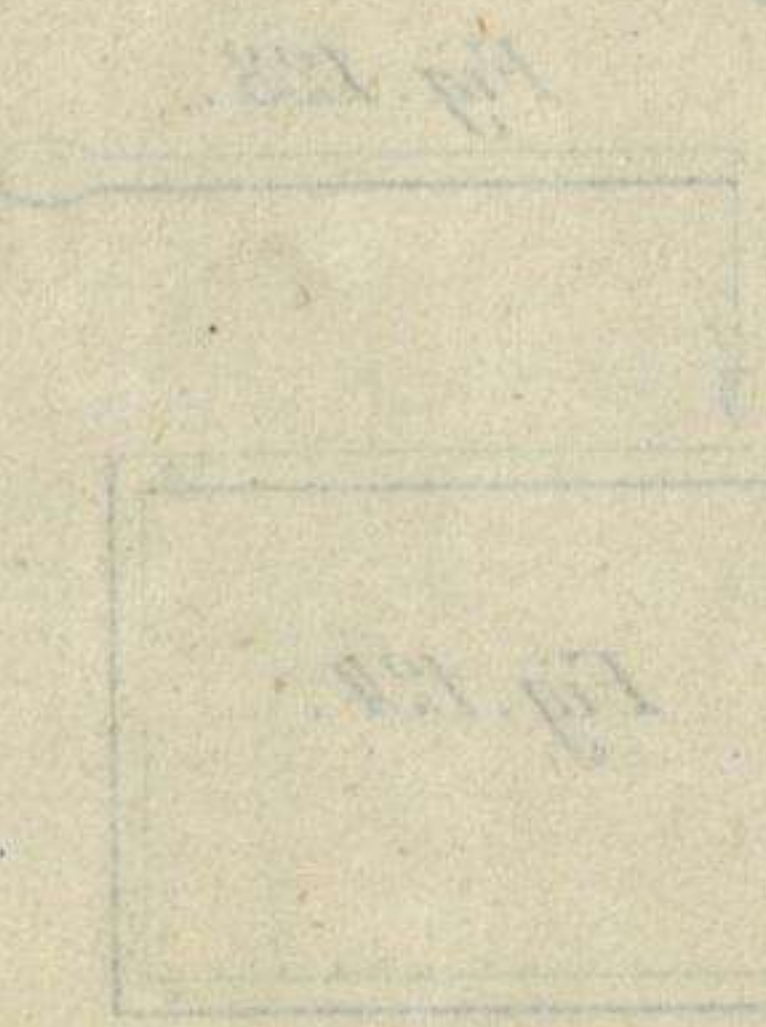
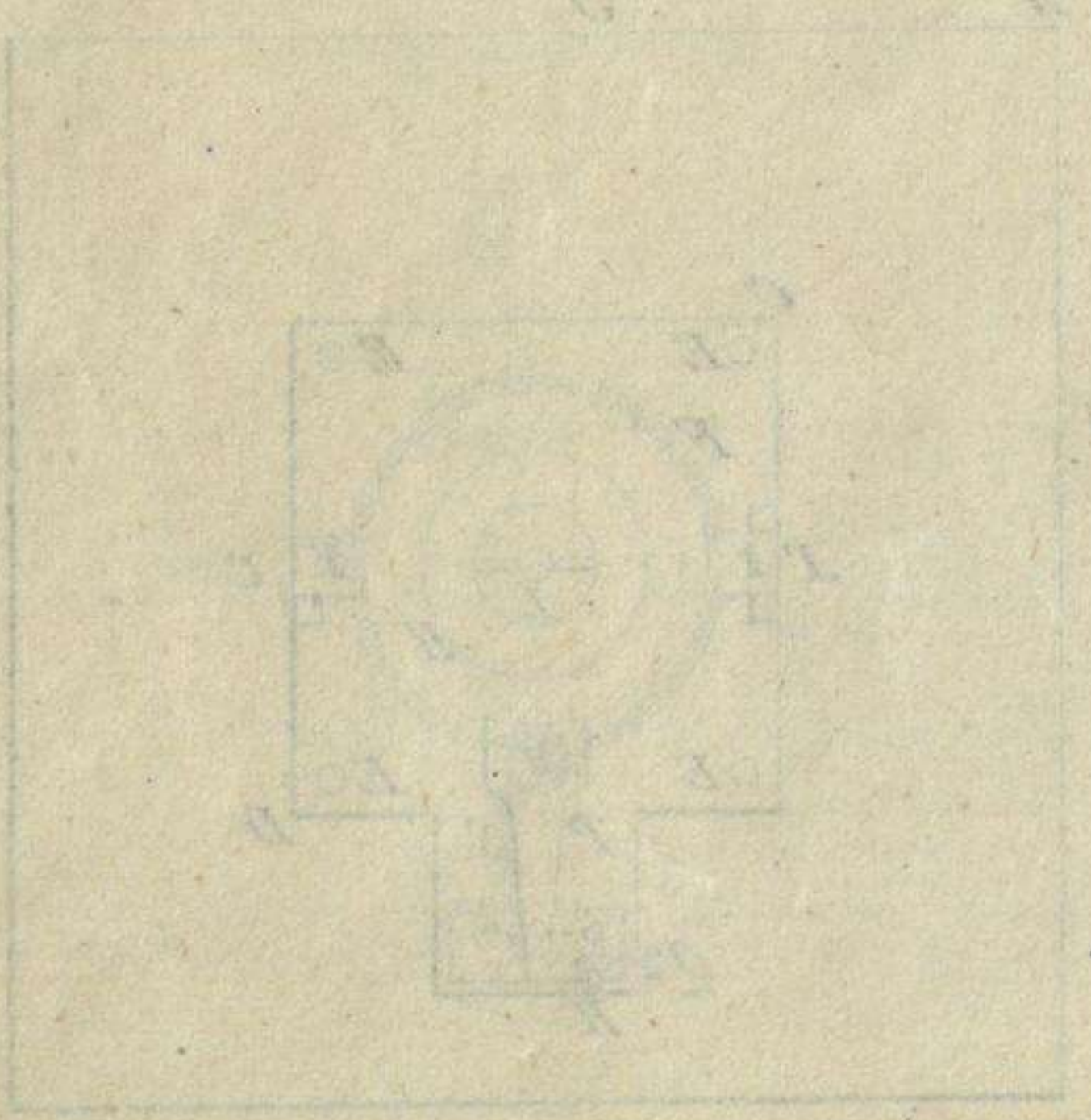
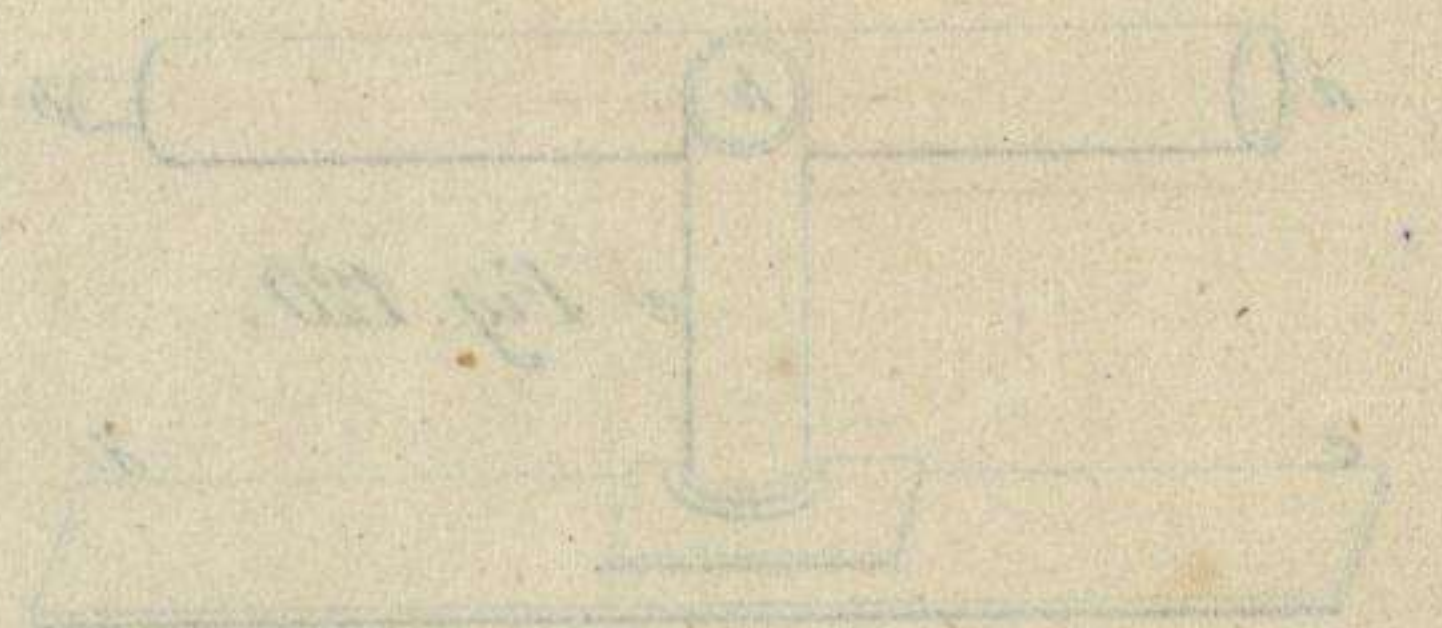
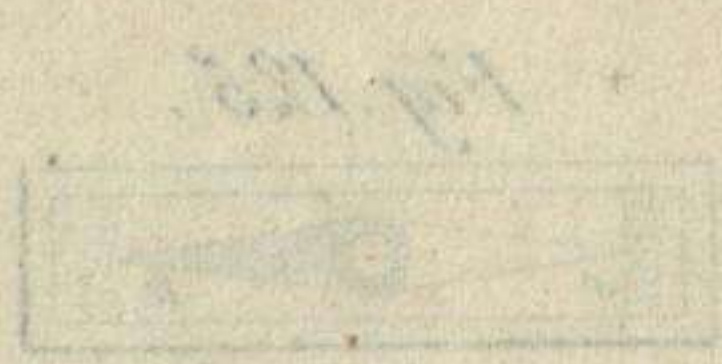
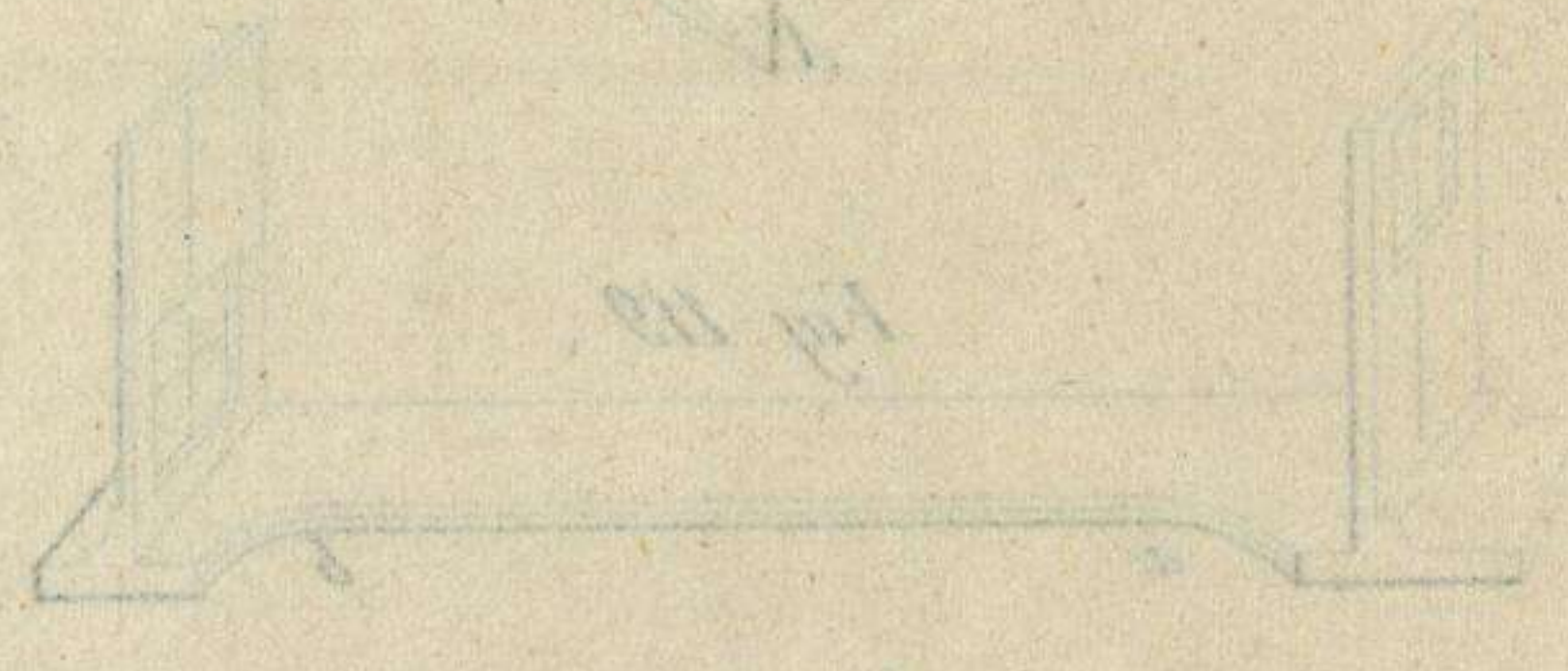
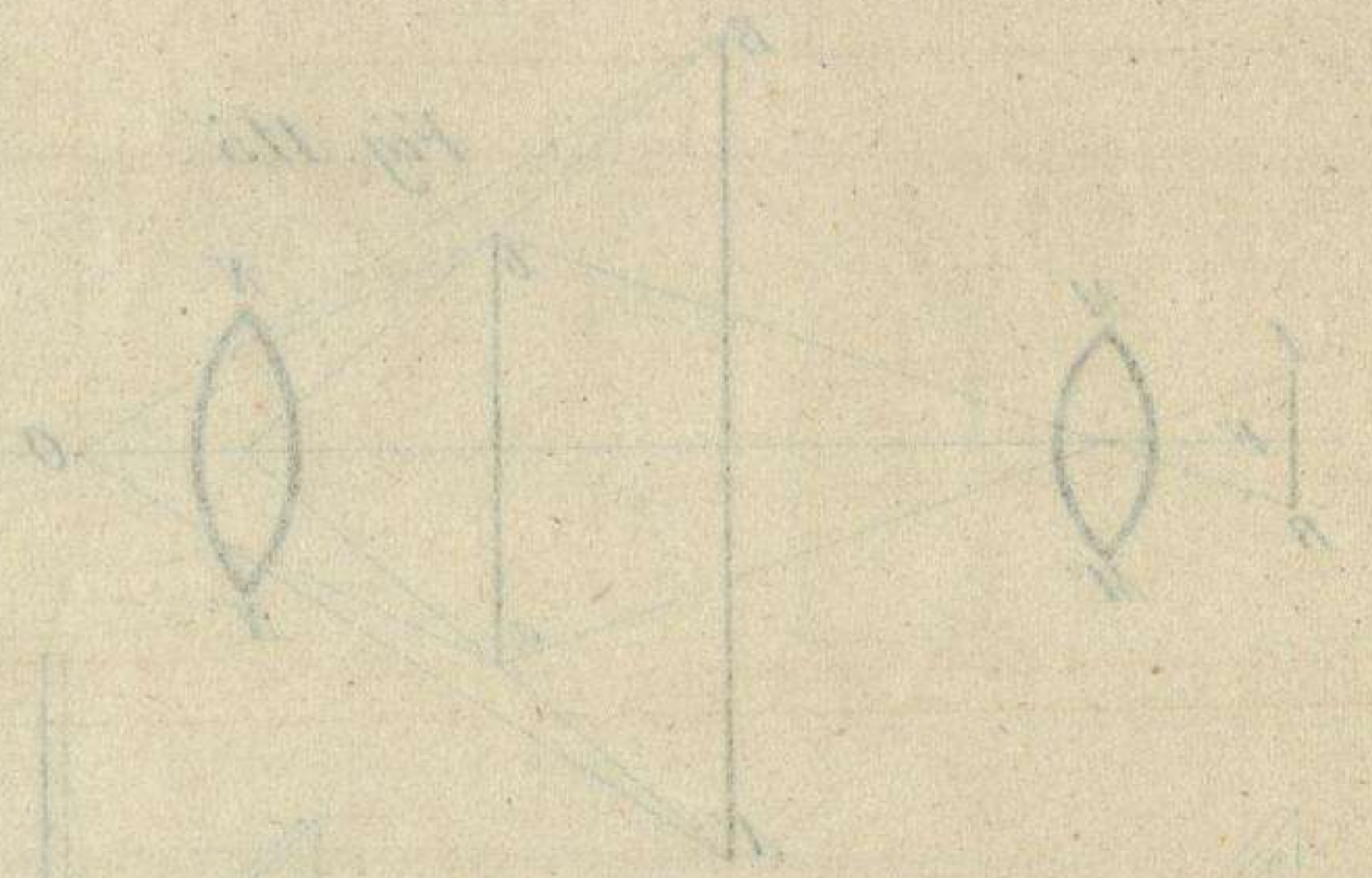
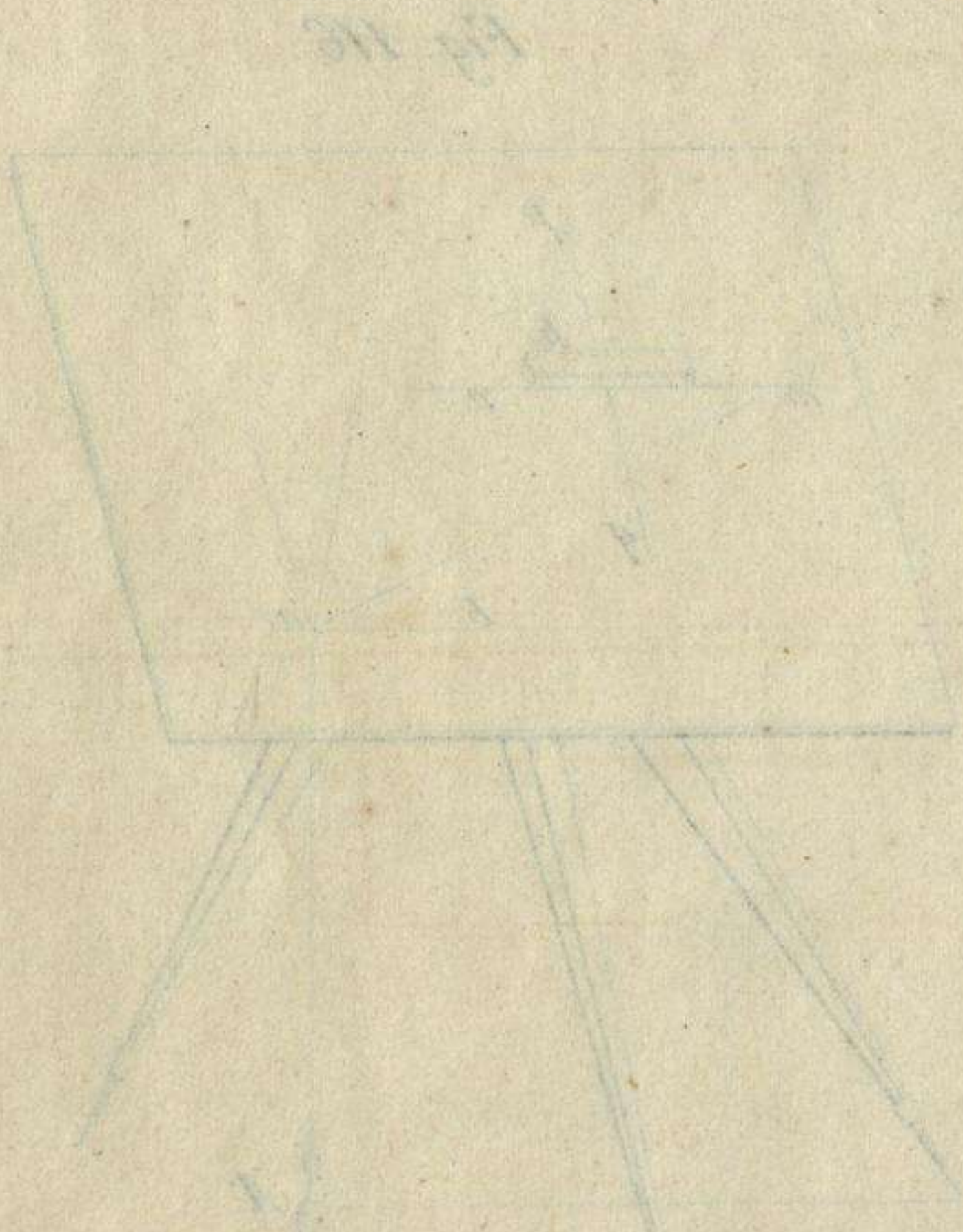
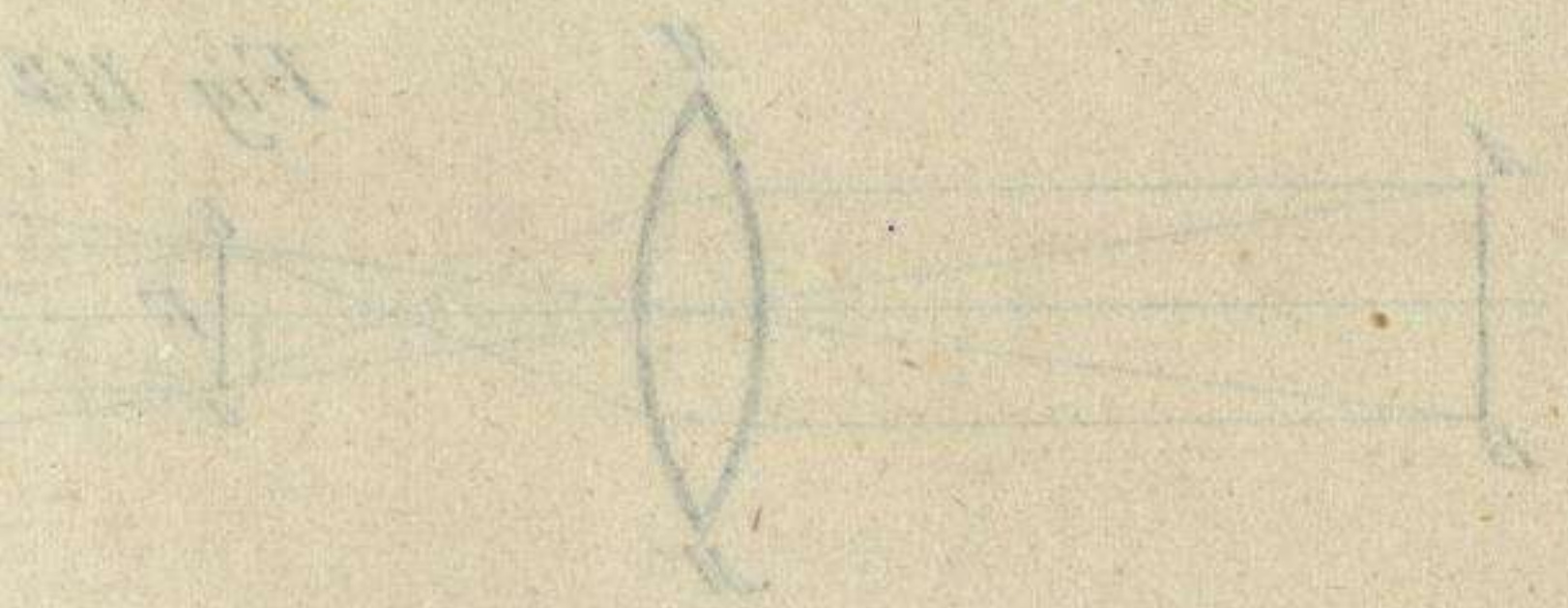
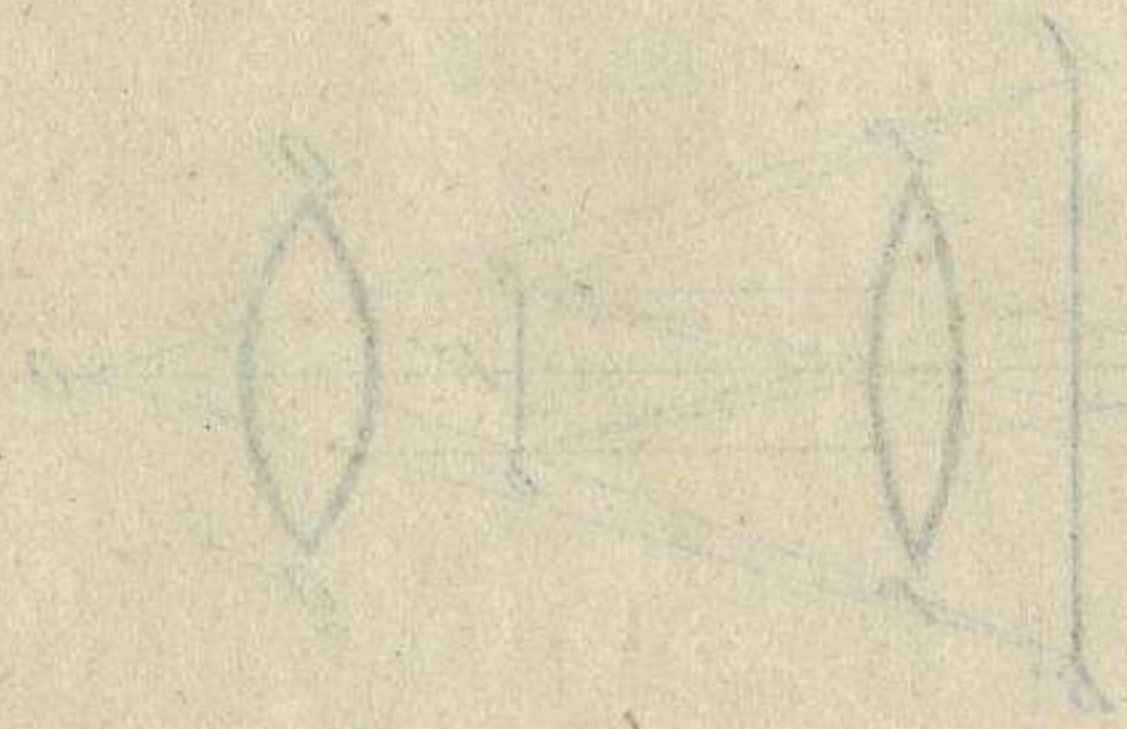
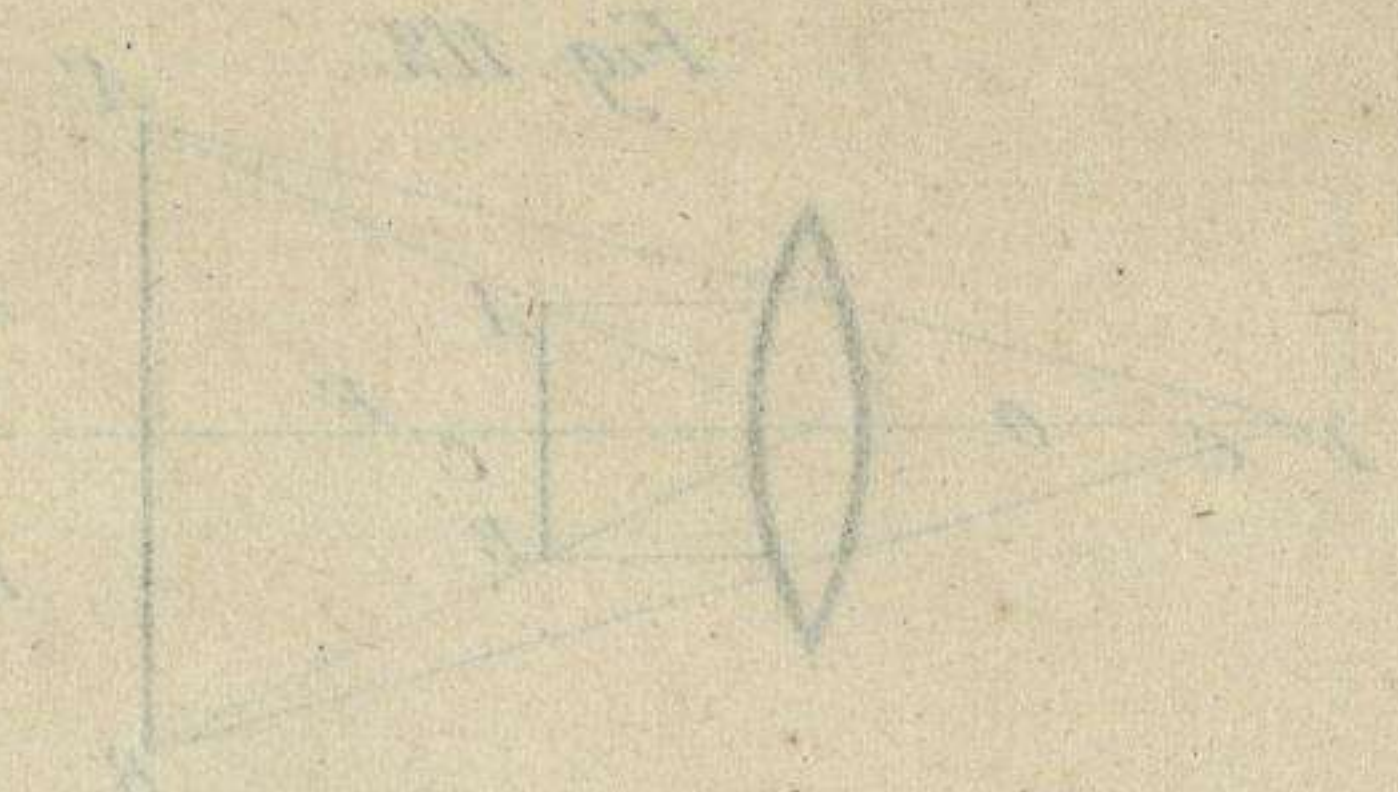
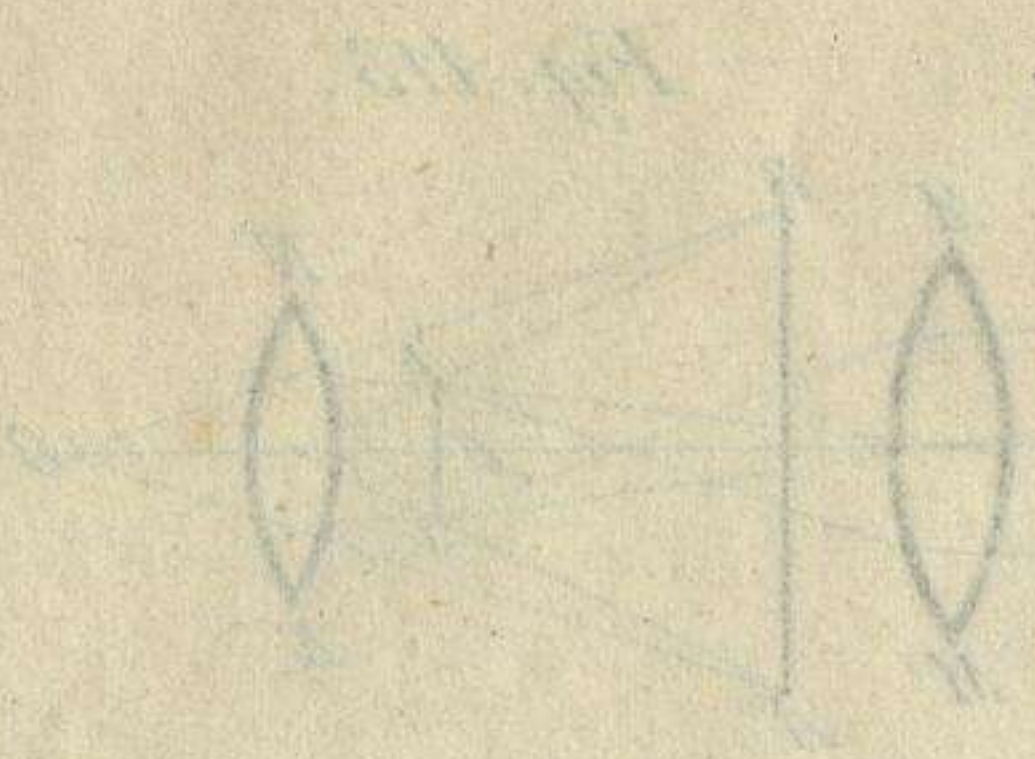

Fig. 121.

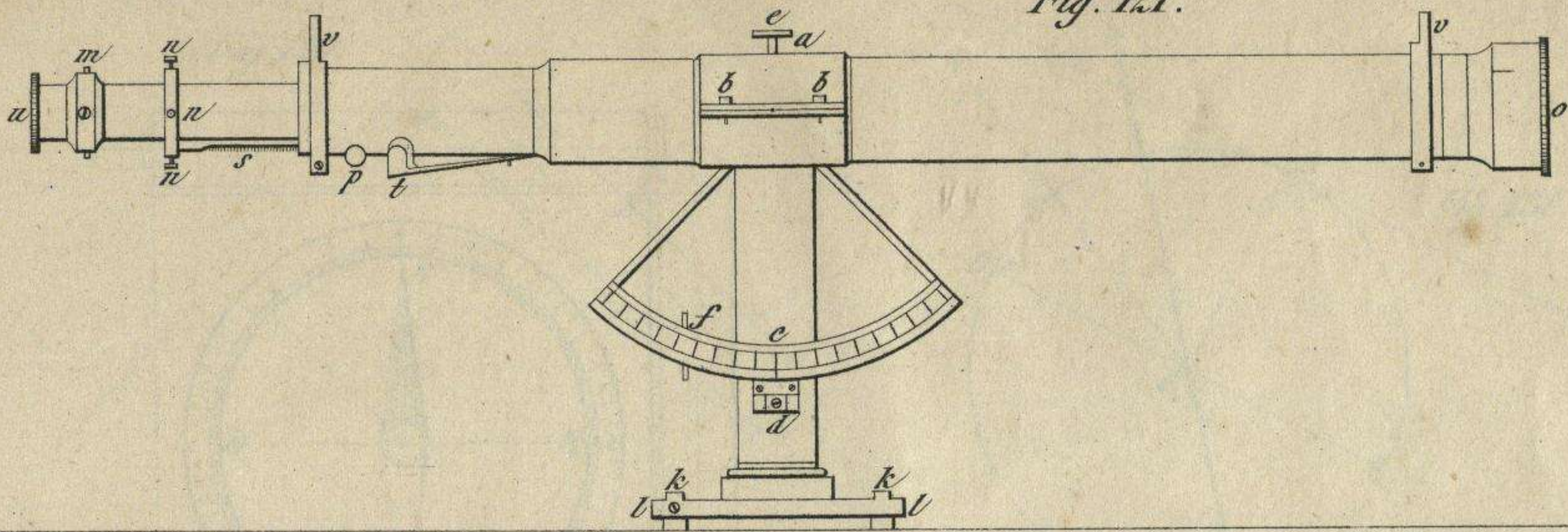

Fig. 122.

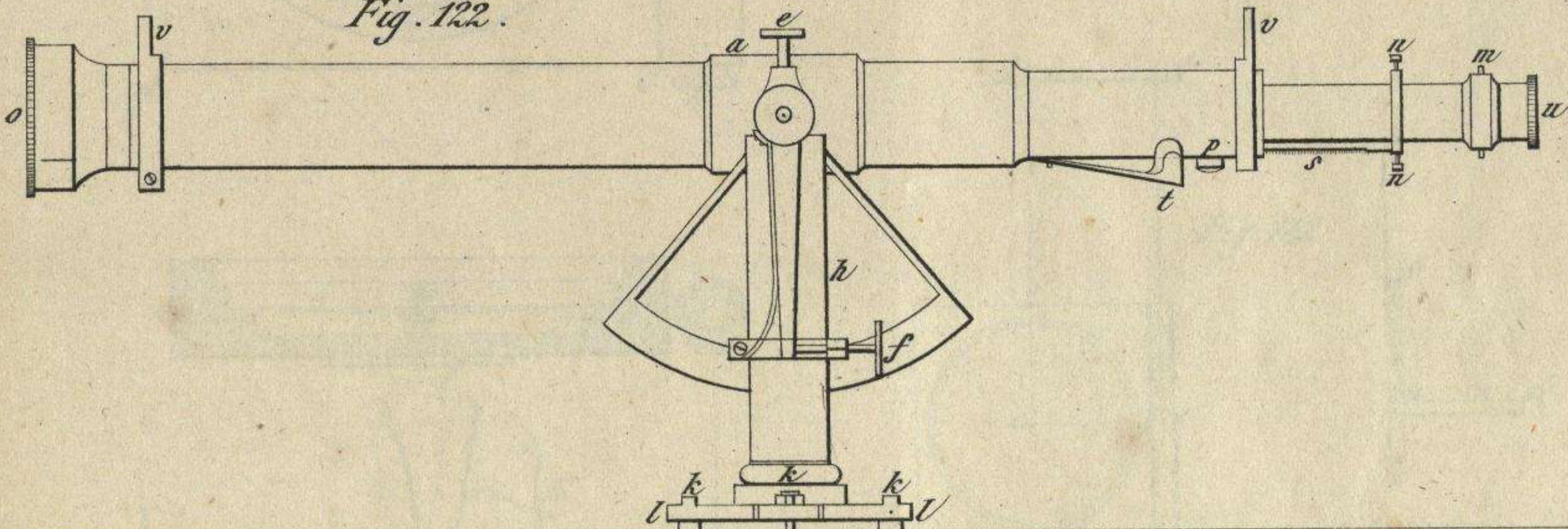

Fig. 126.

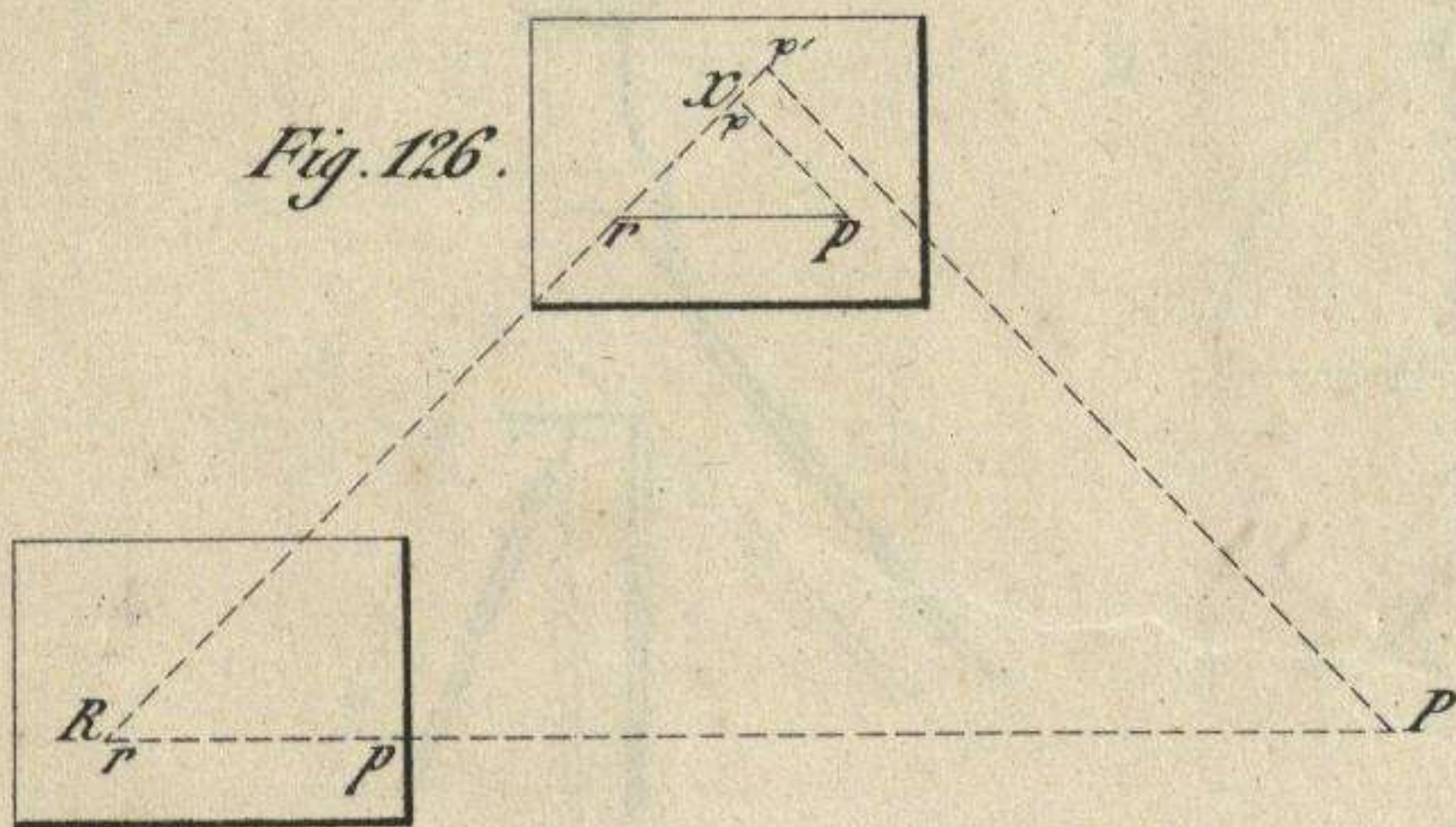

Fig. 127.

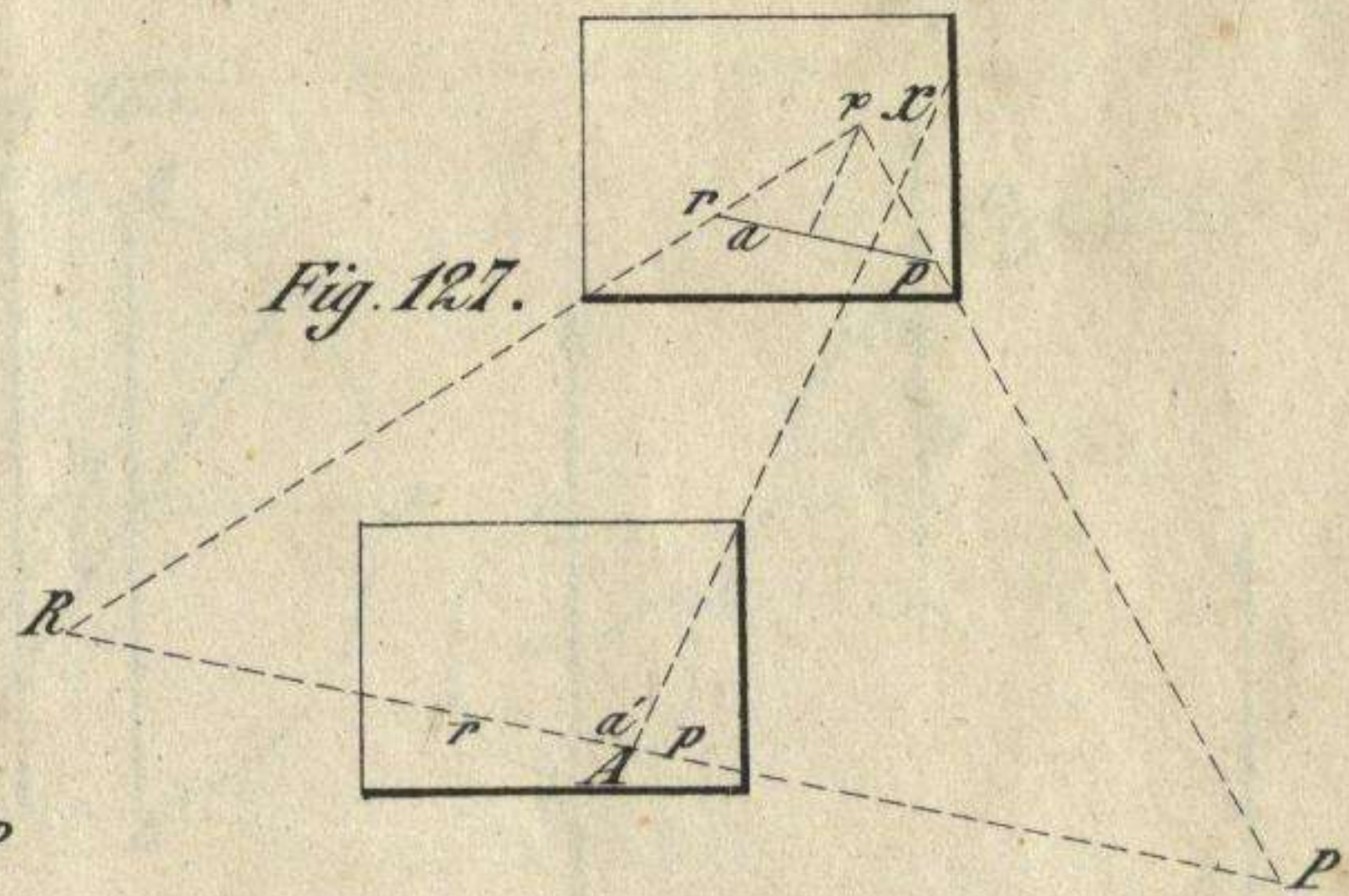

Fig. 128.

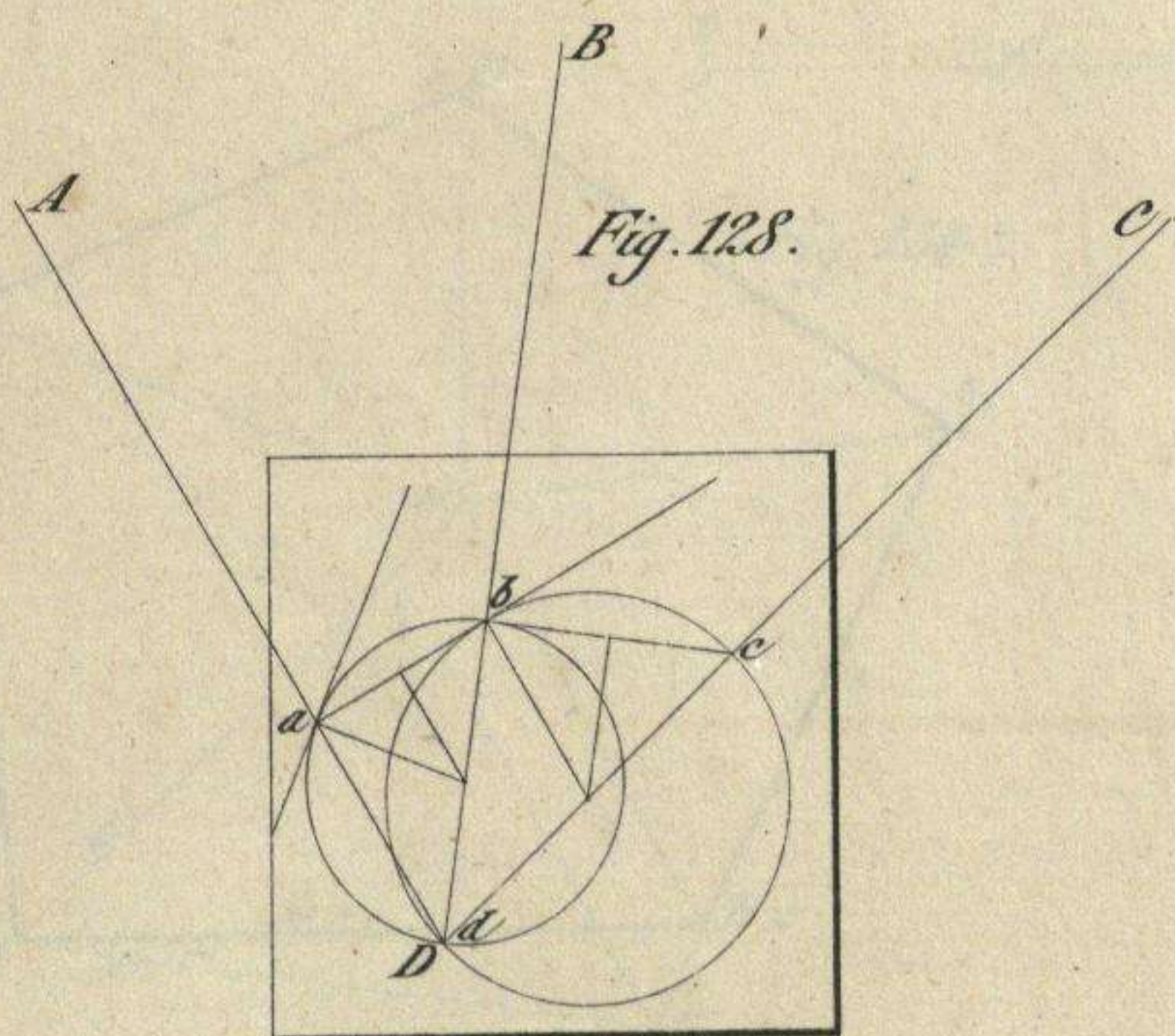
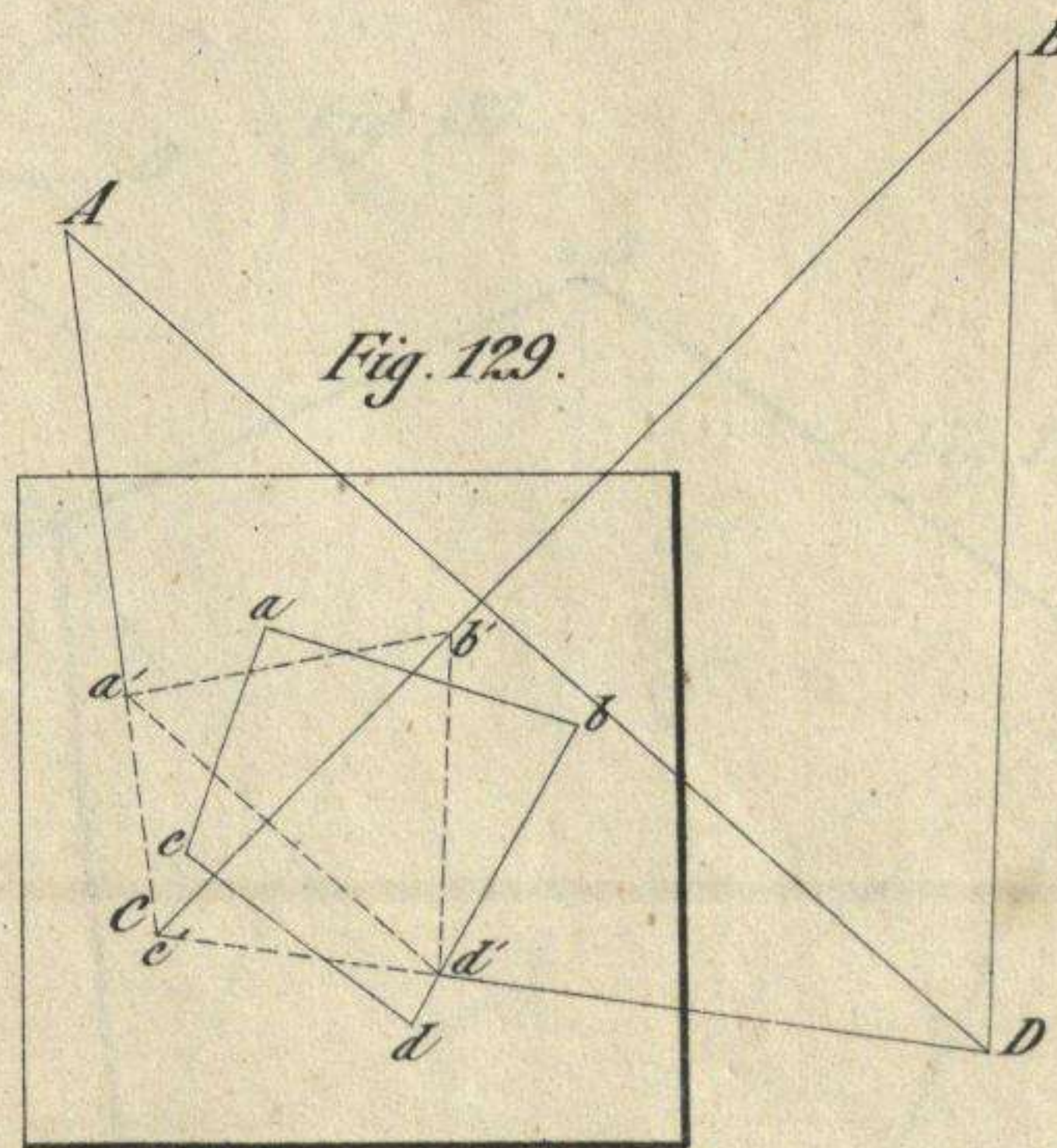

Fig. 129.



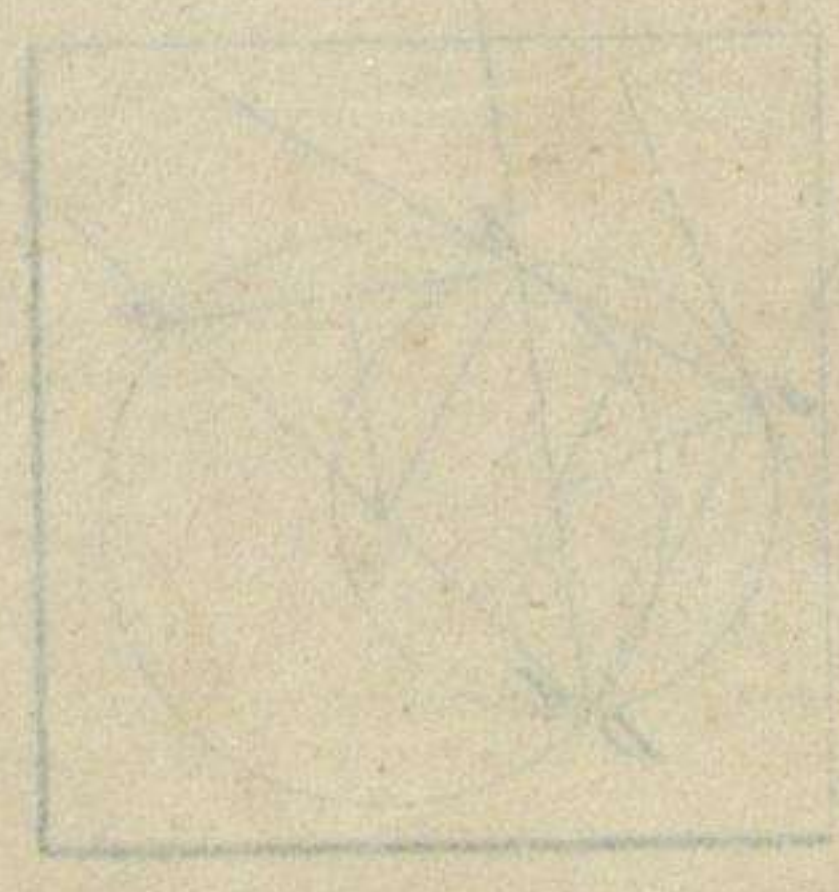
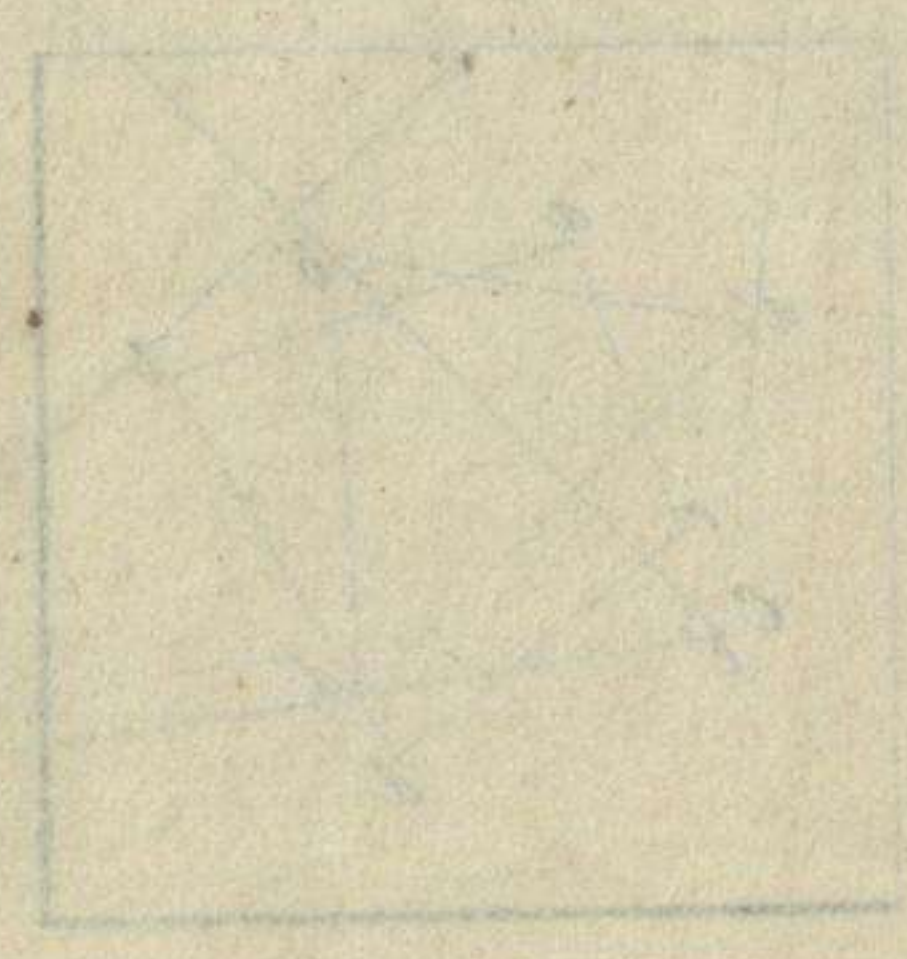
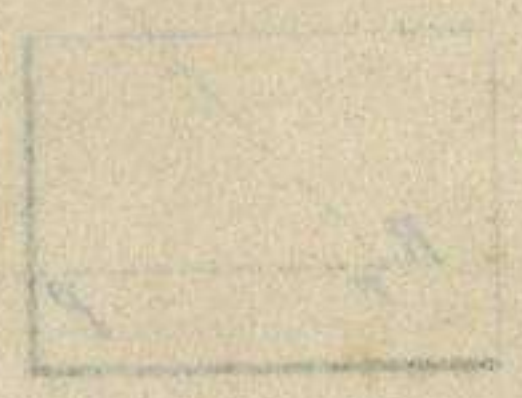
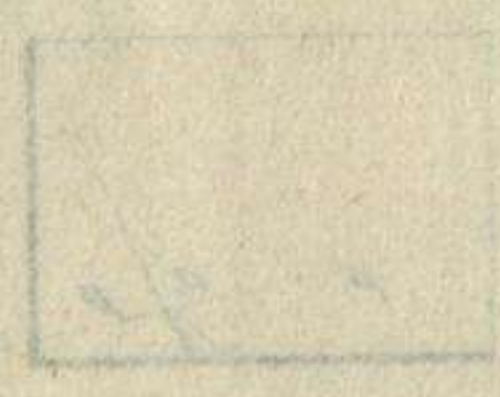
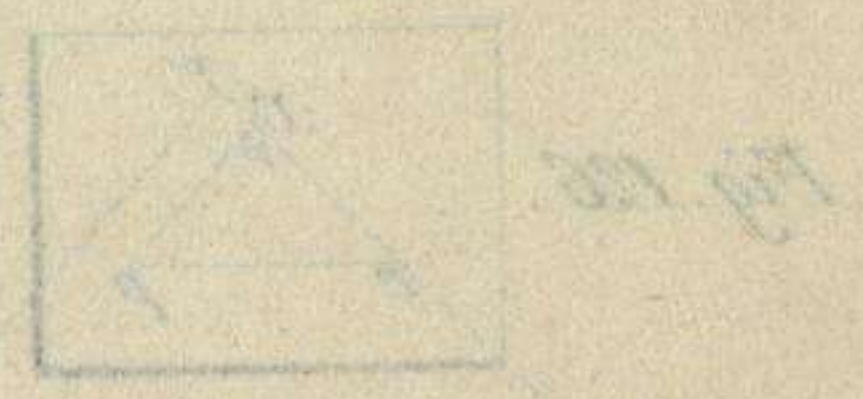
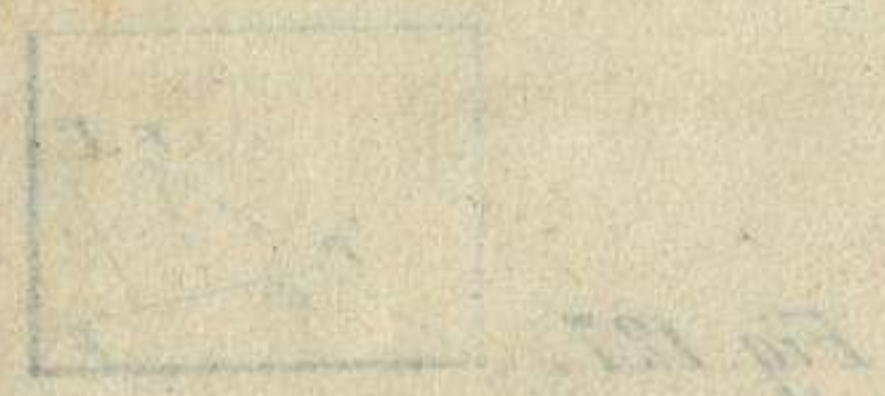
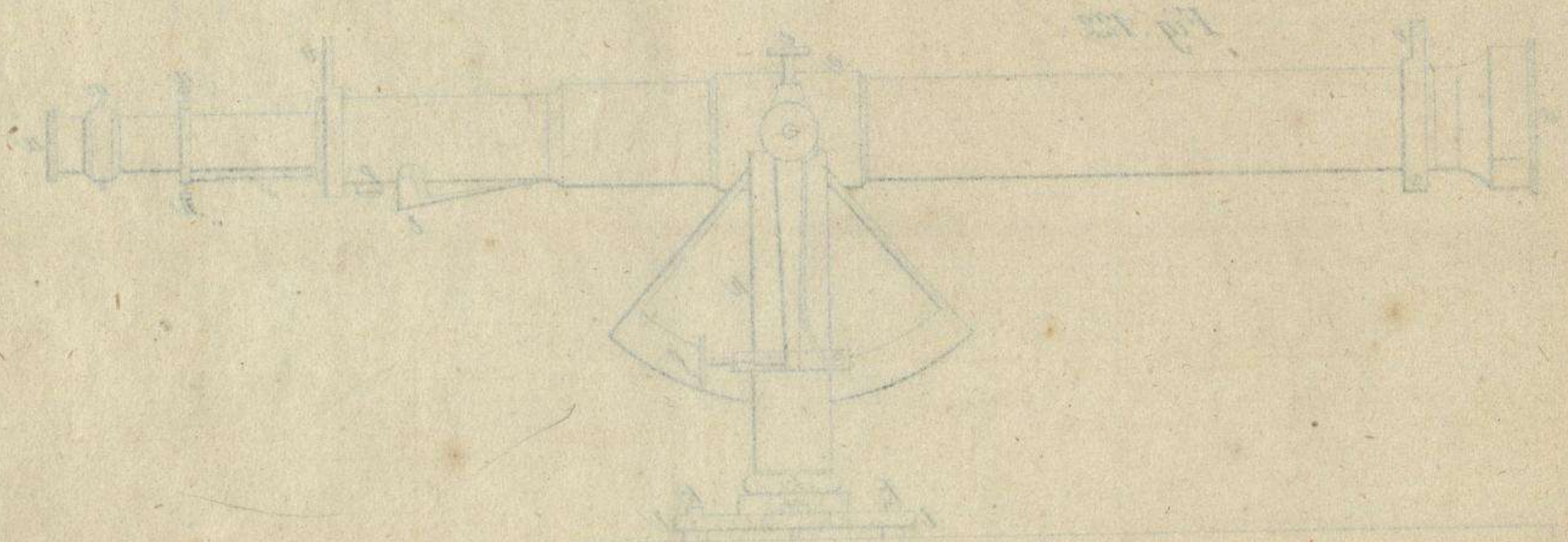
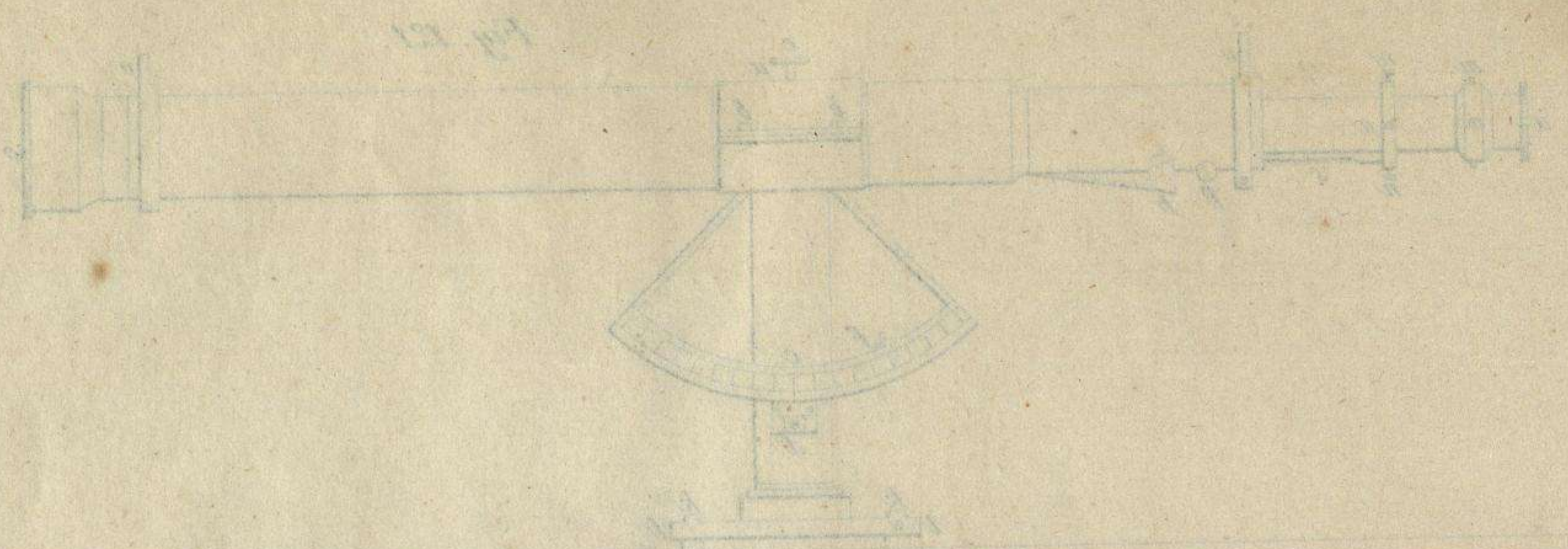

Fig. 130.

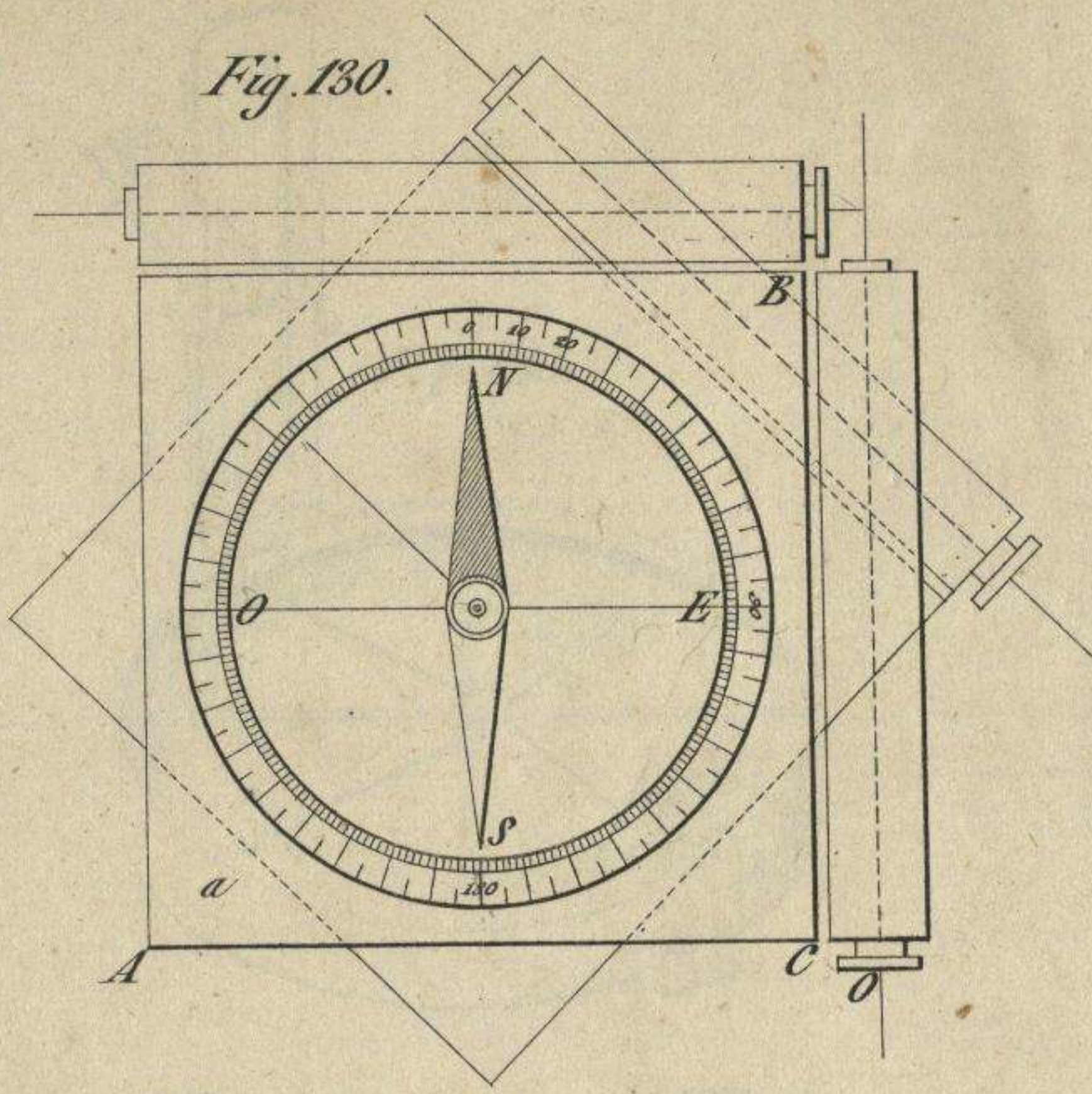

Fig. 131.

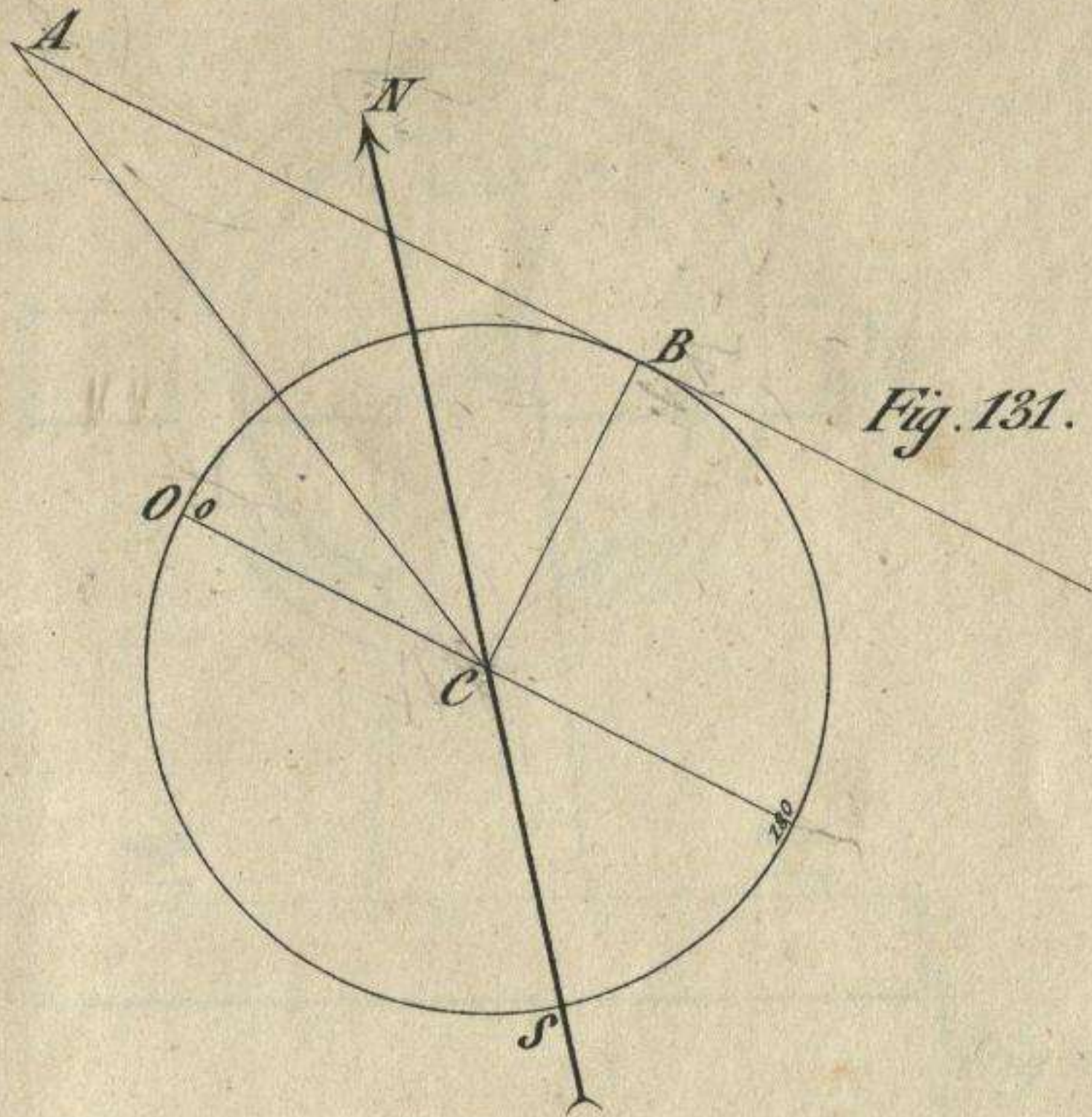

Fig. 132.

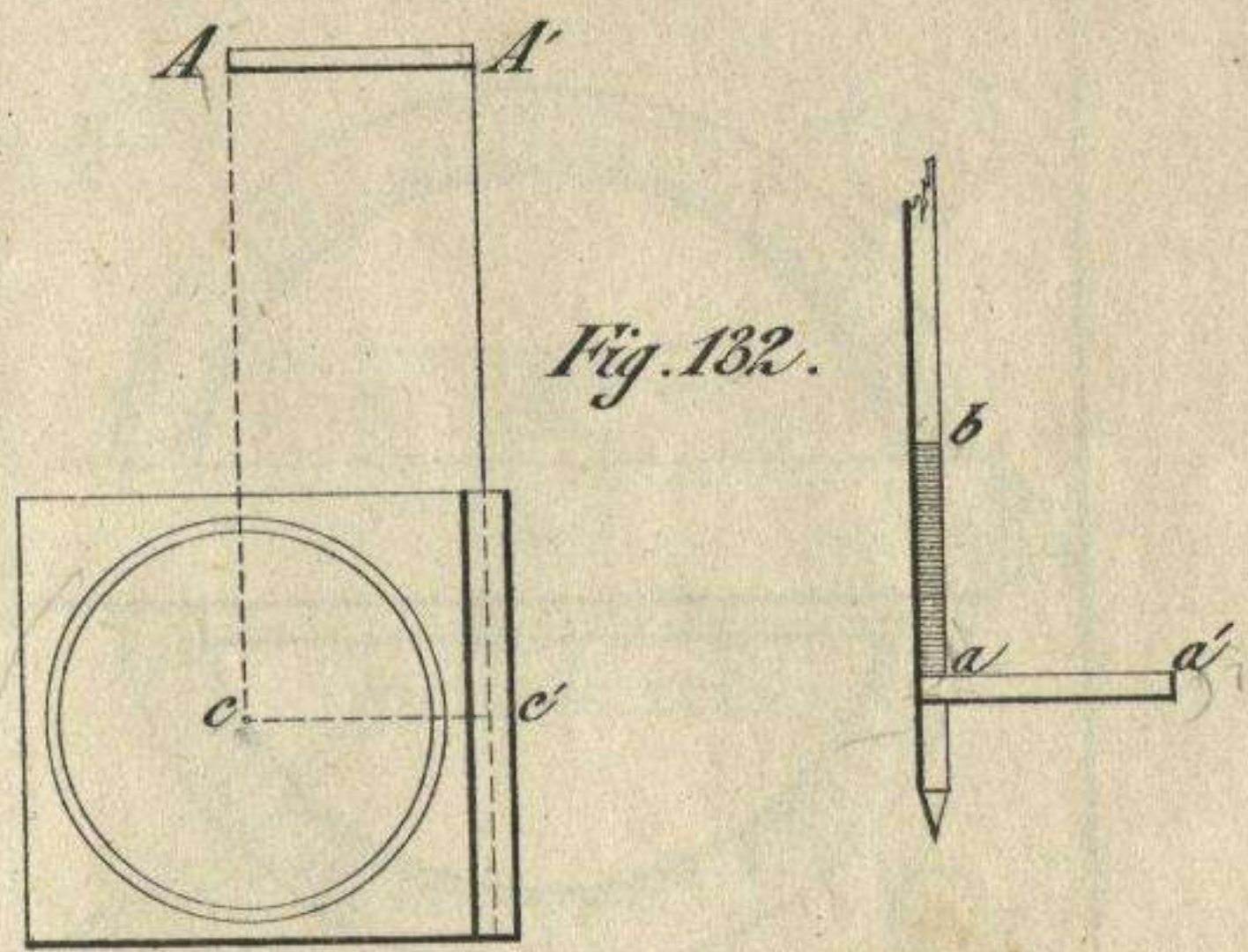

Fig. 133.

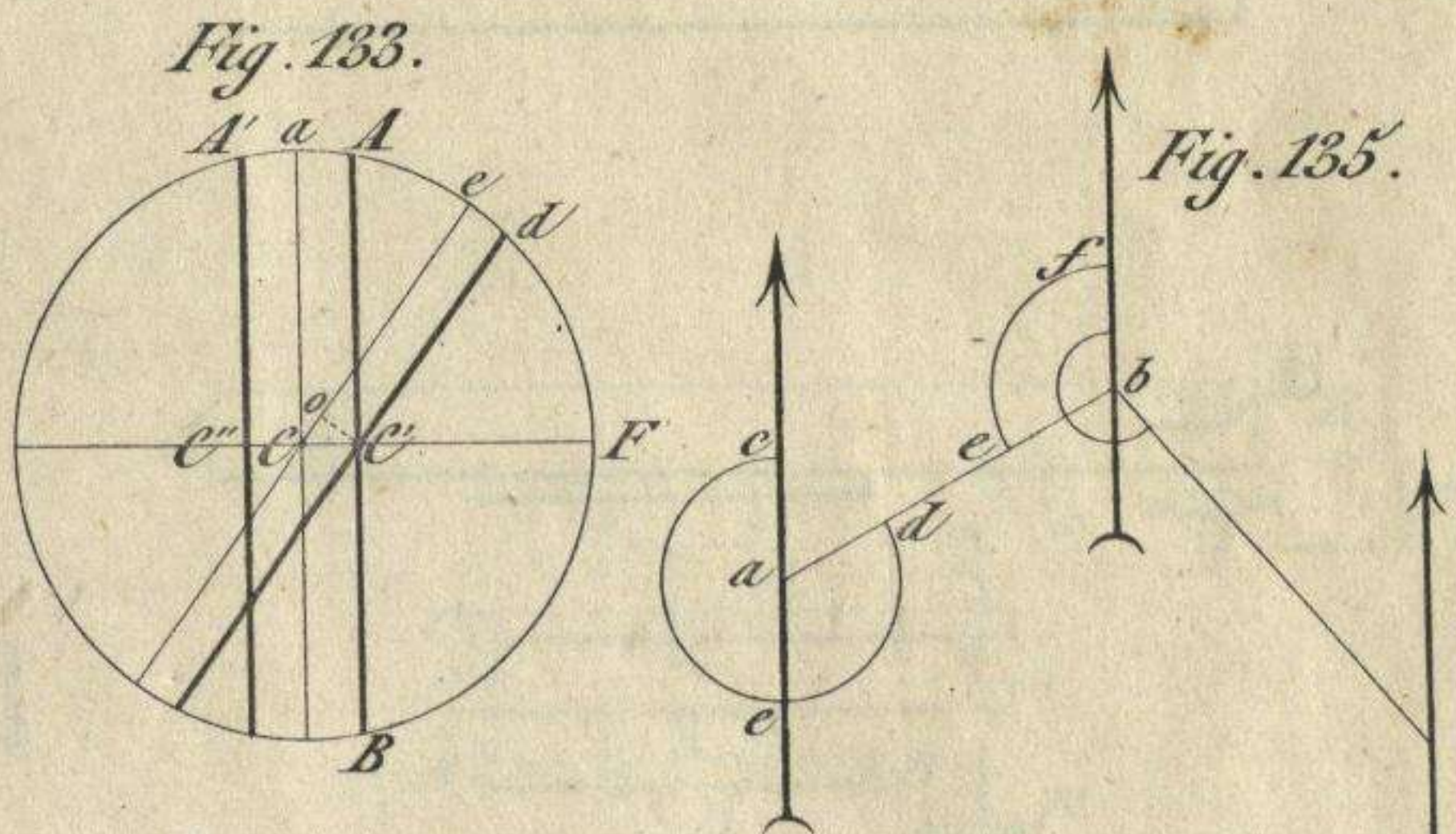

Fig. 135.

Fig. 137.

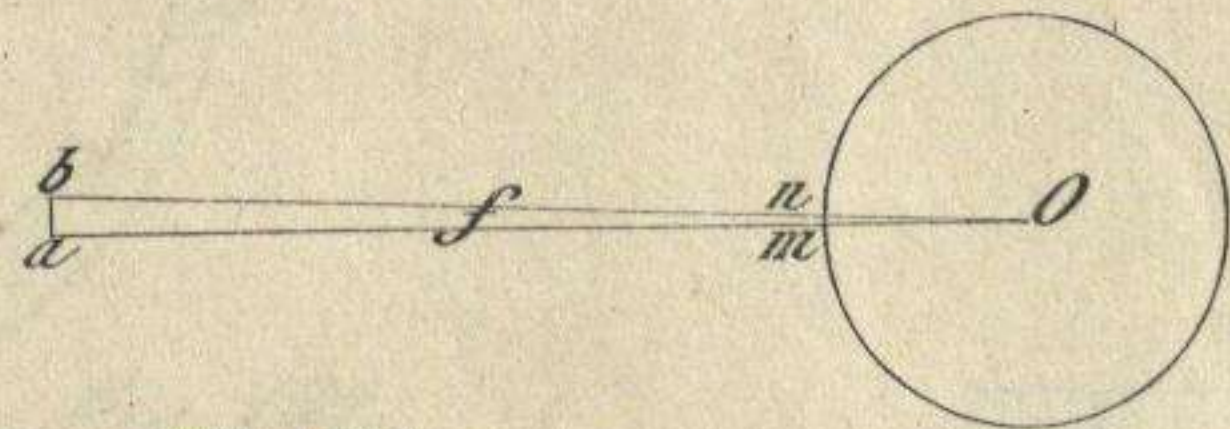

Fig. 134.

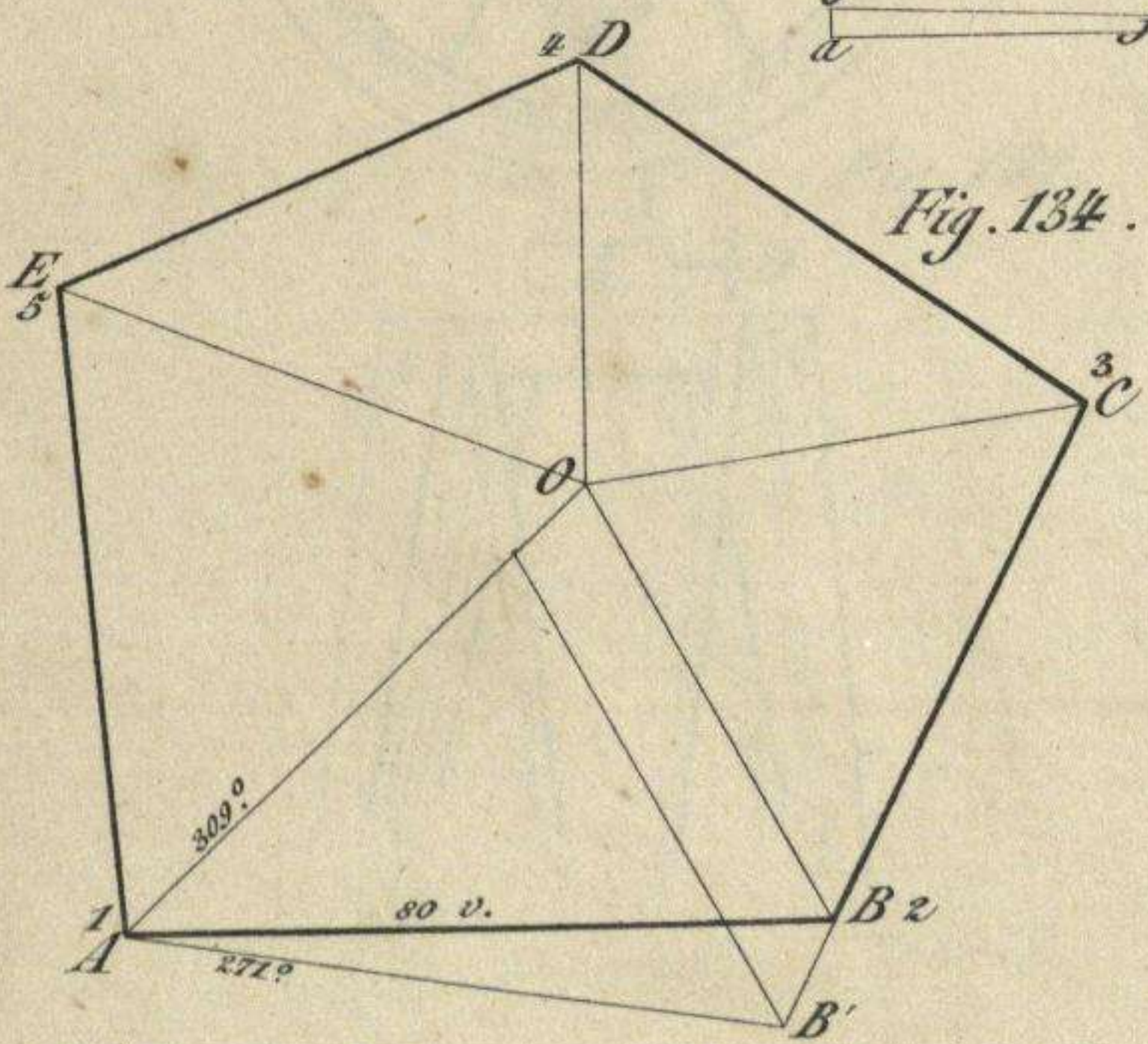
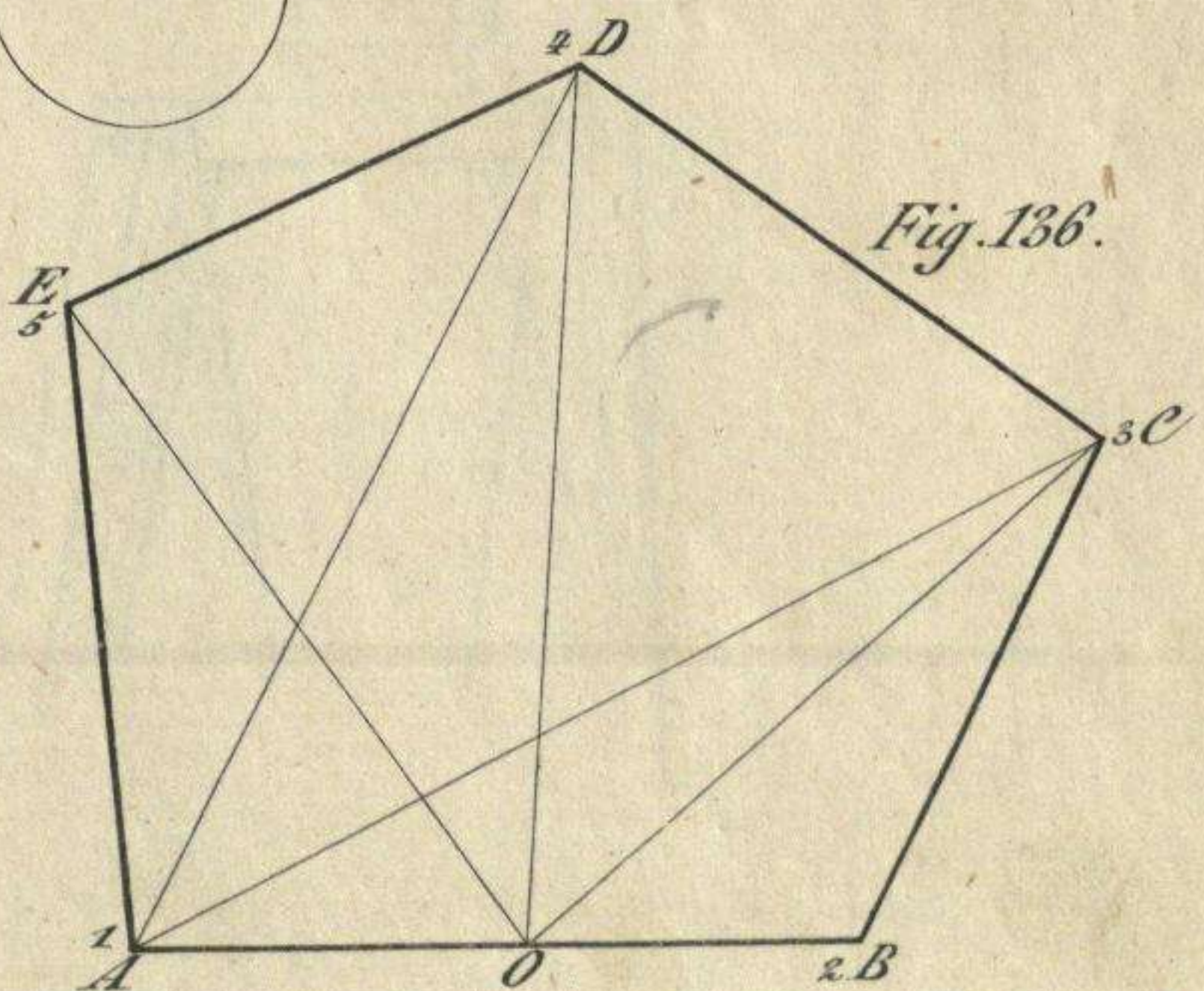
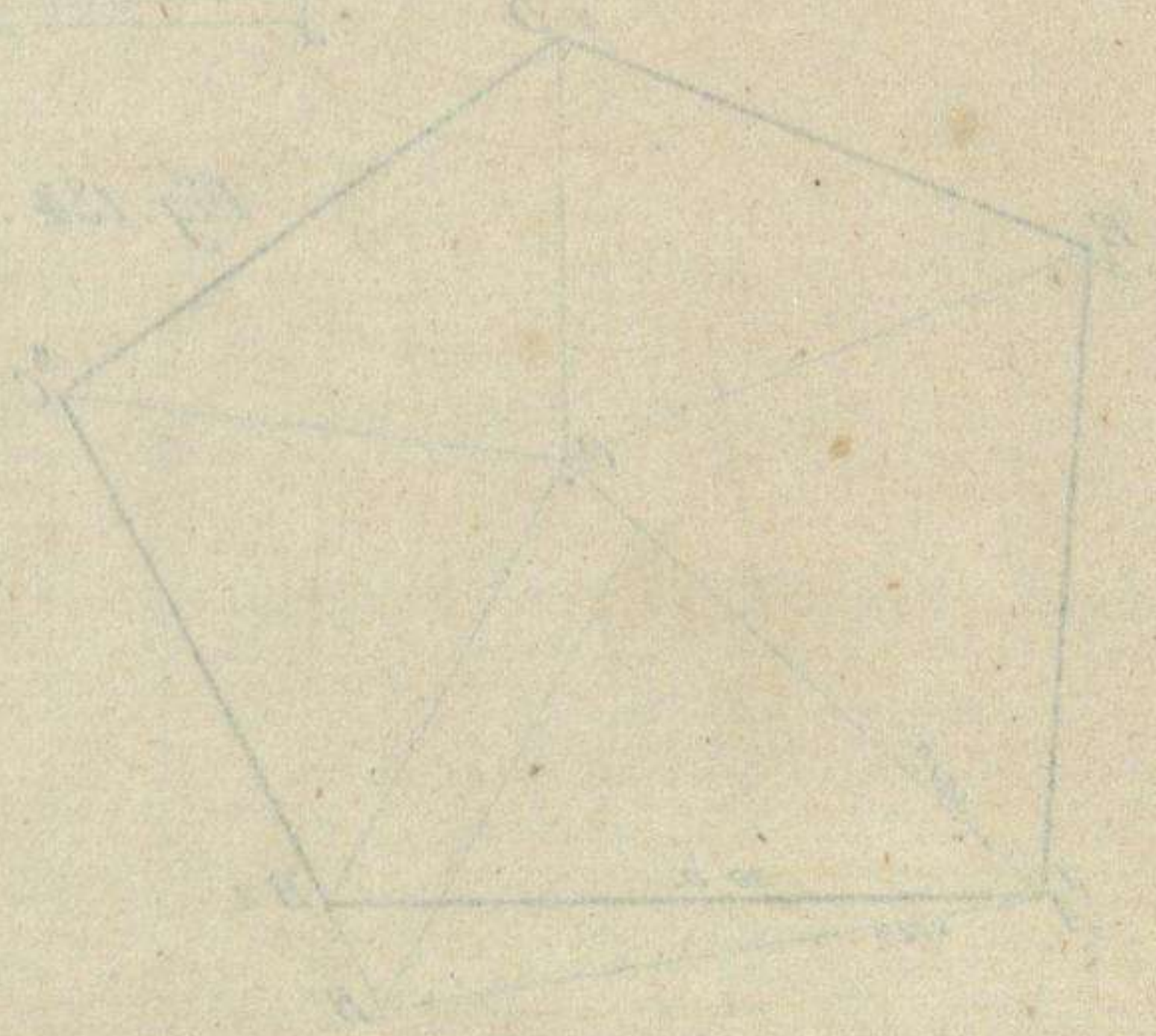
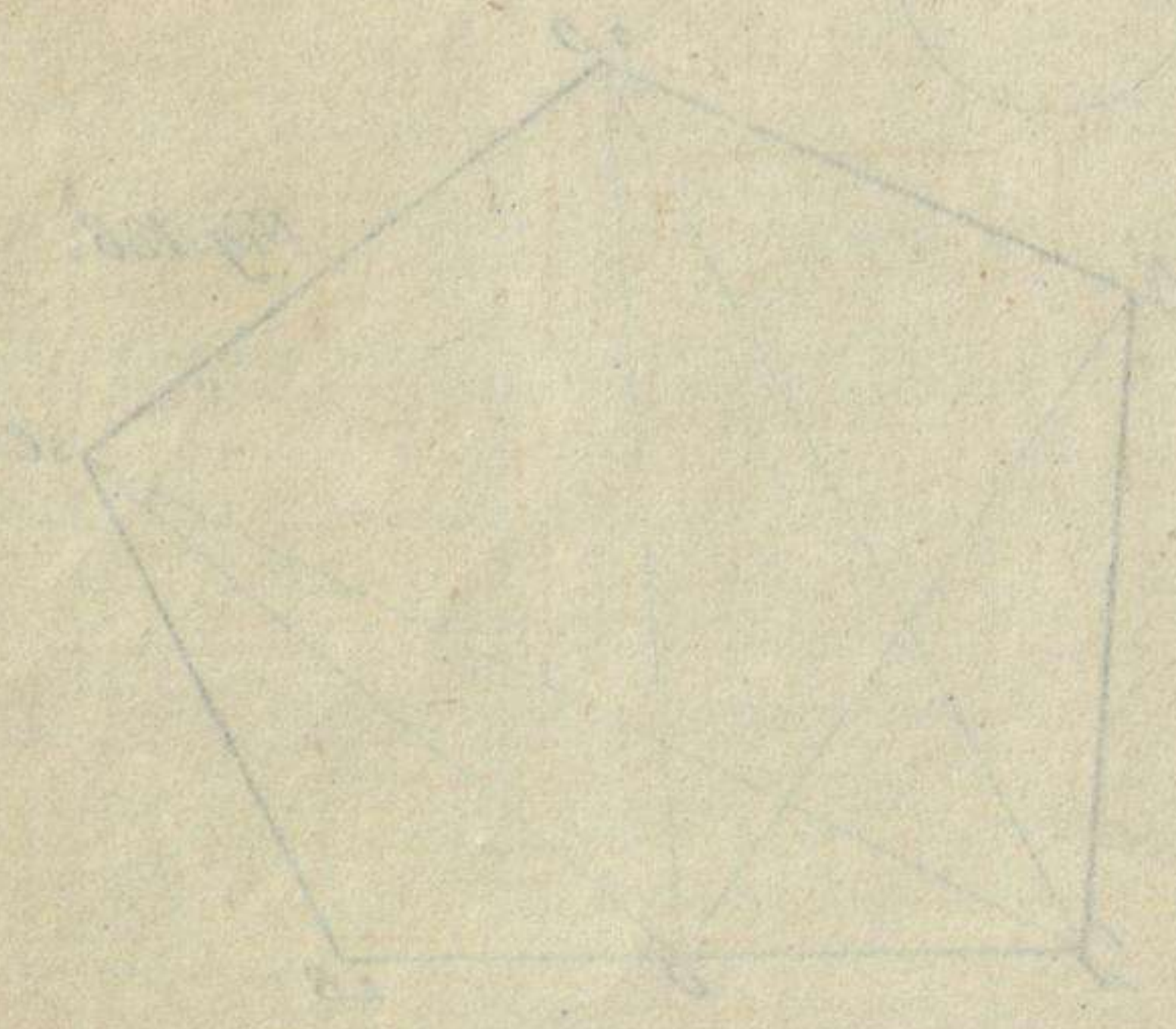
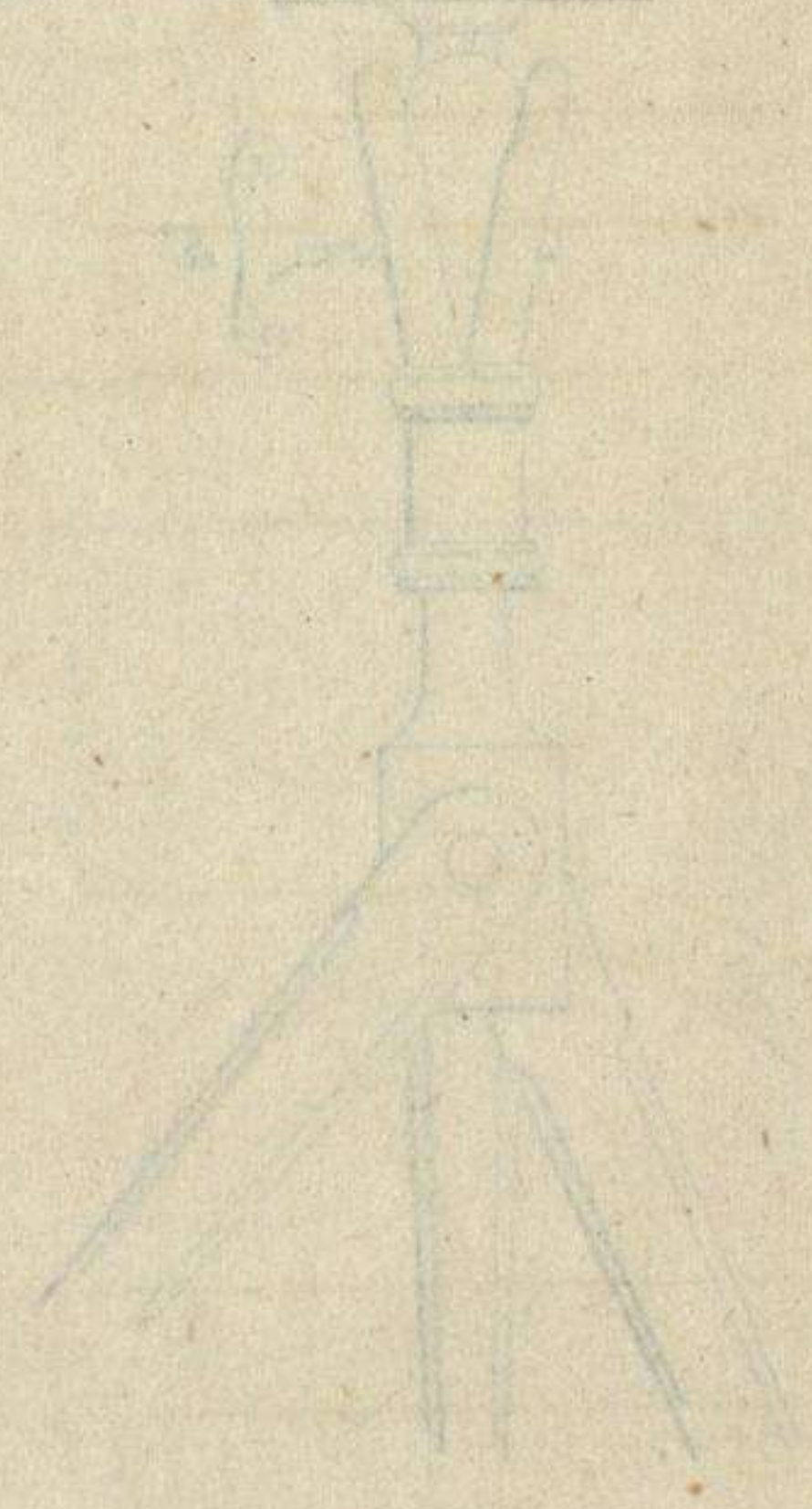
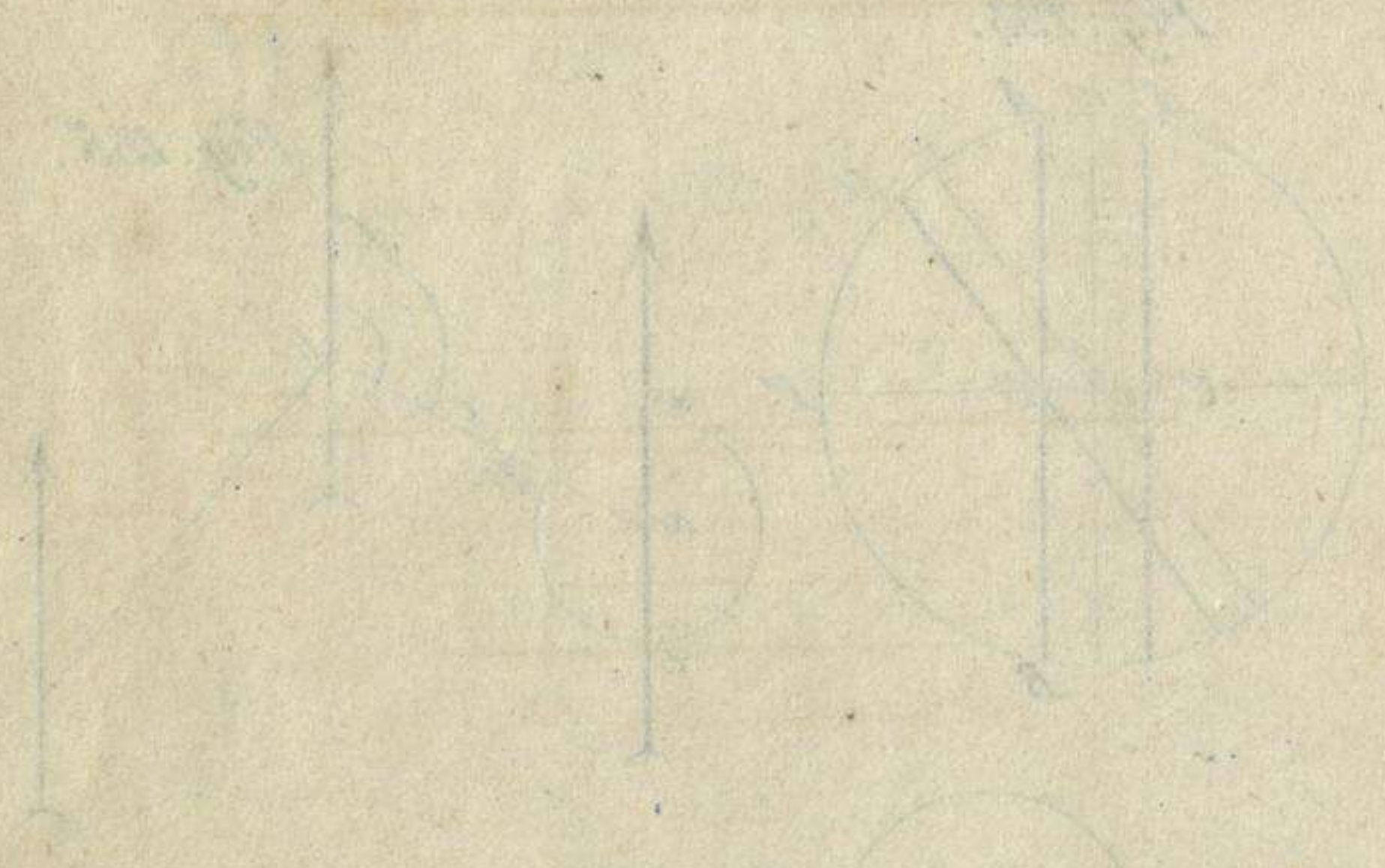
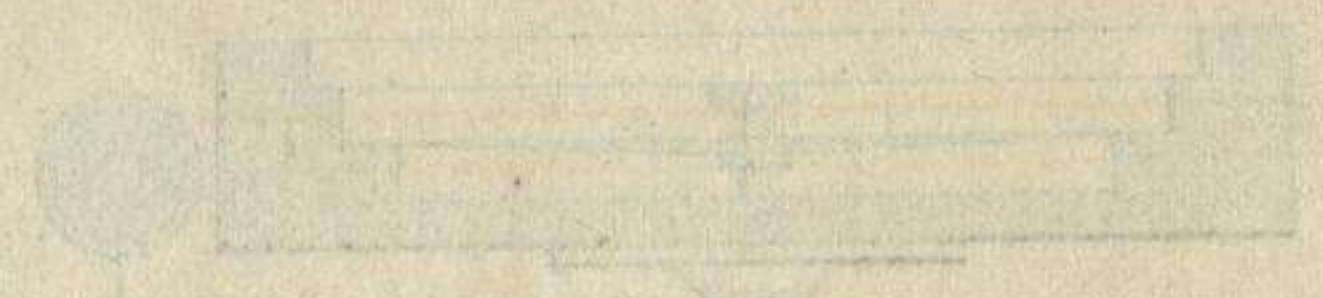
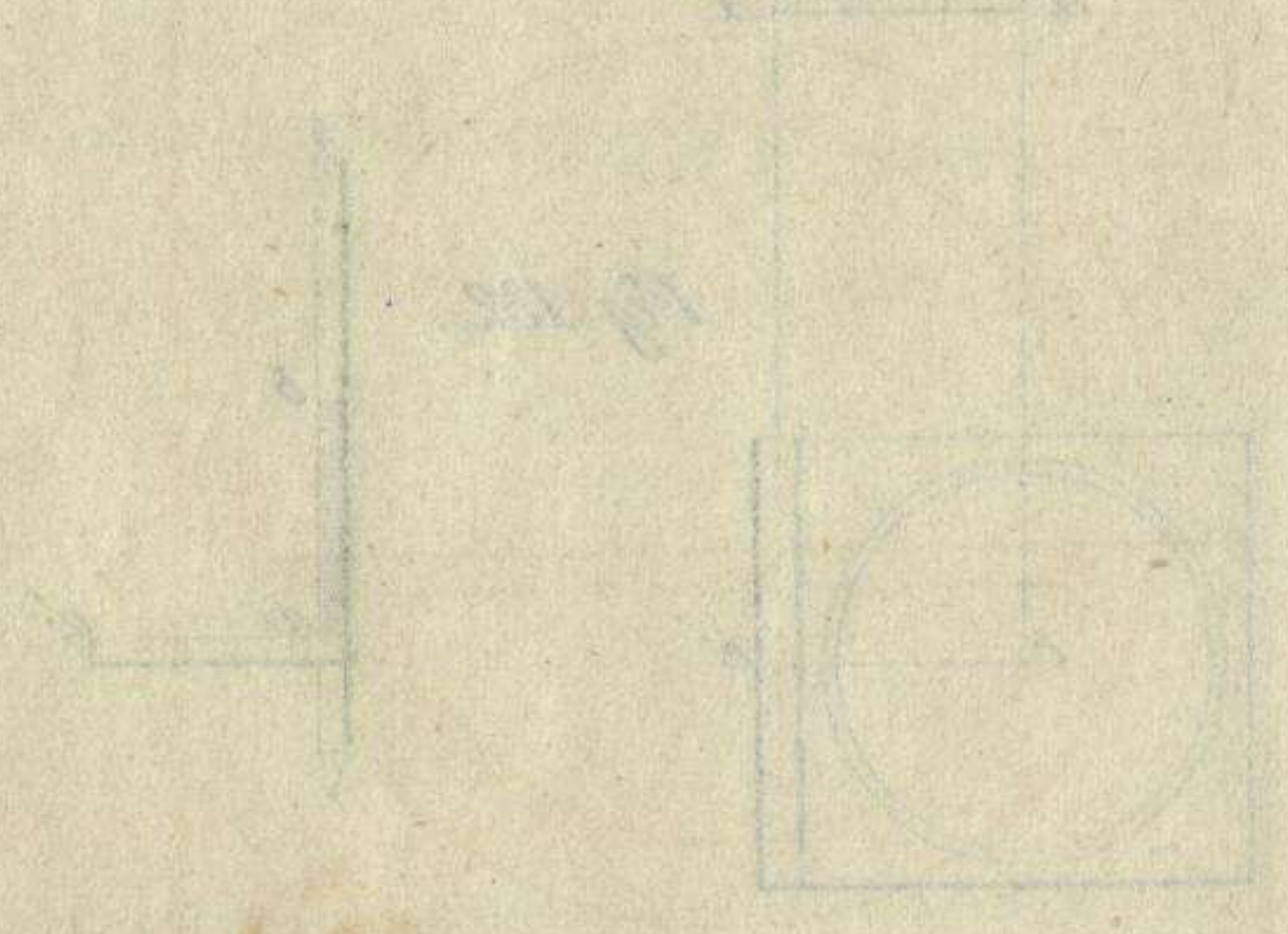
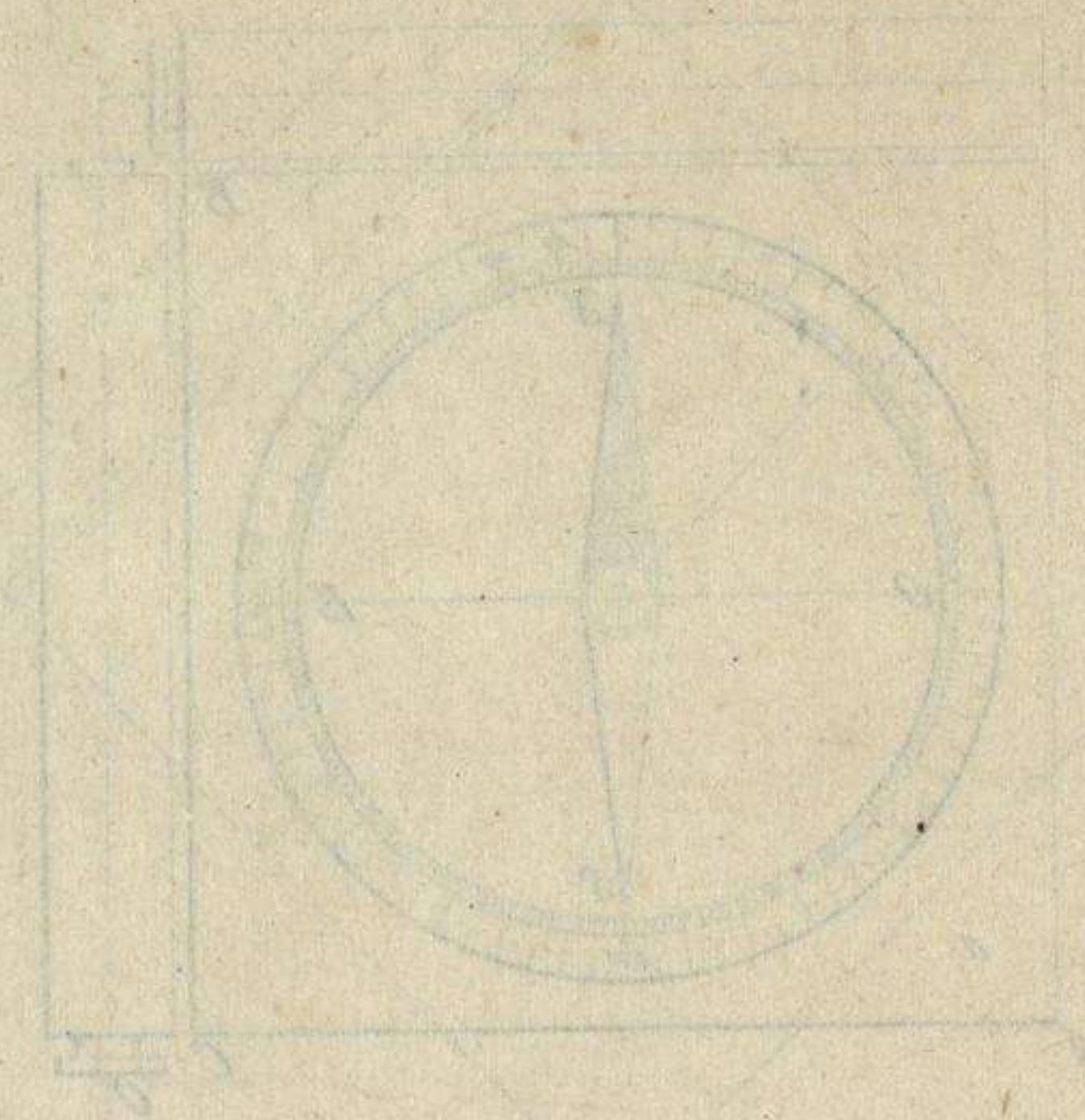
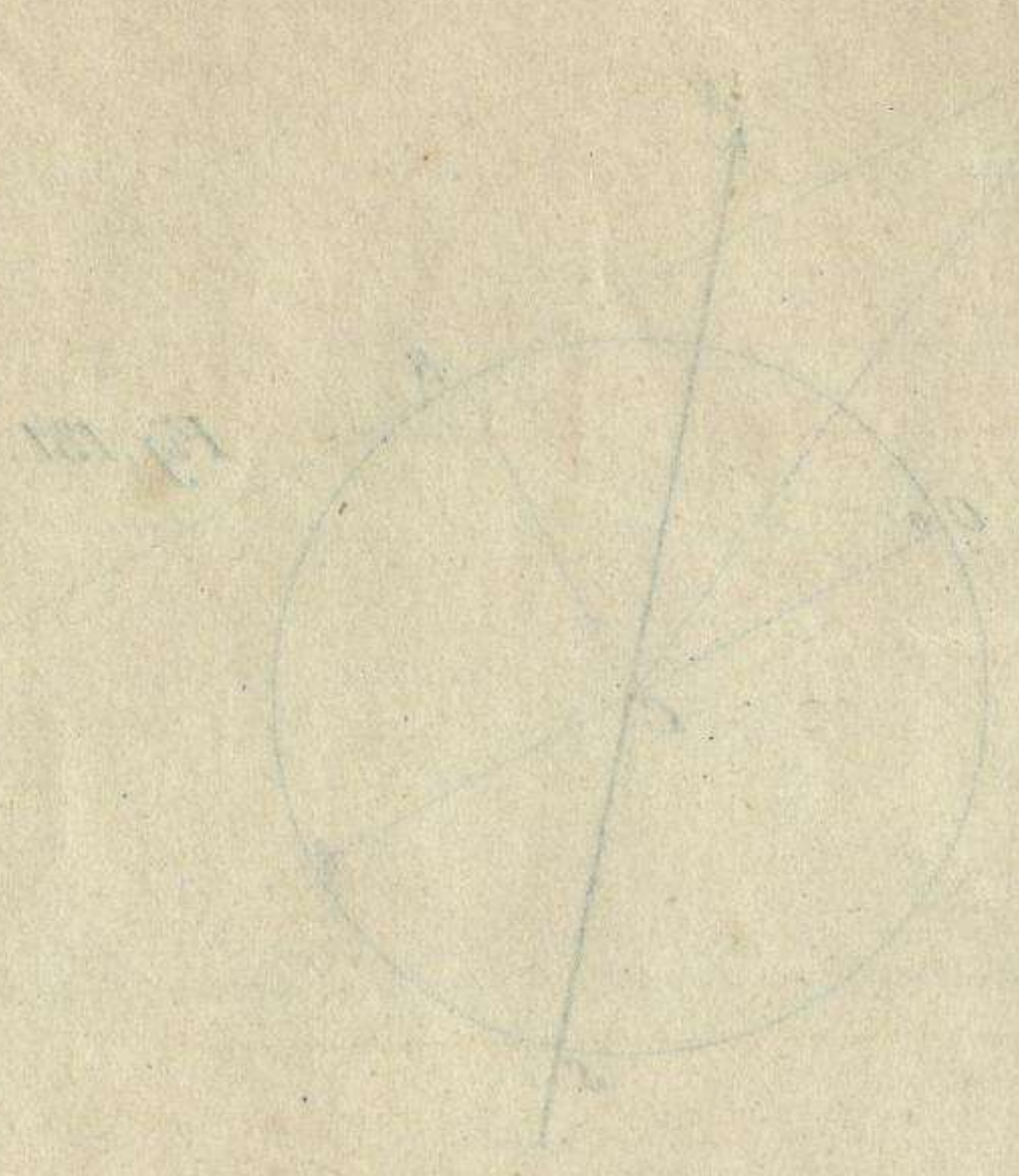

Fig. 136.





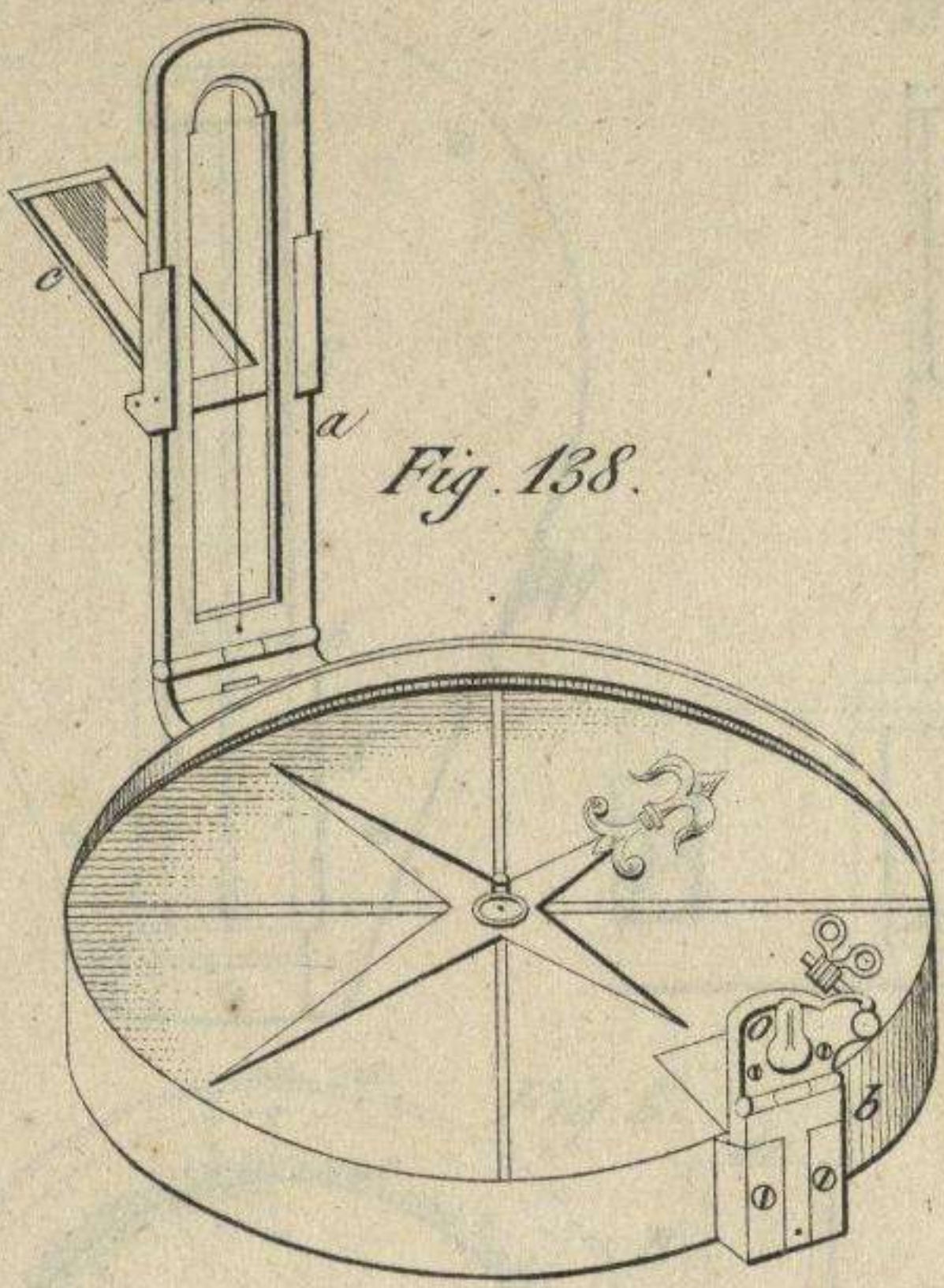

Fig. 138.

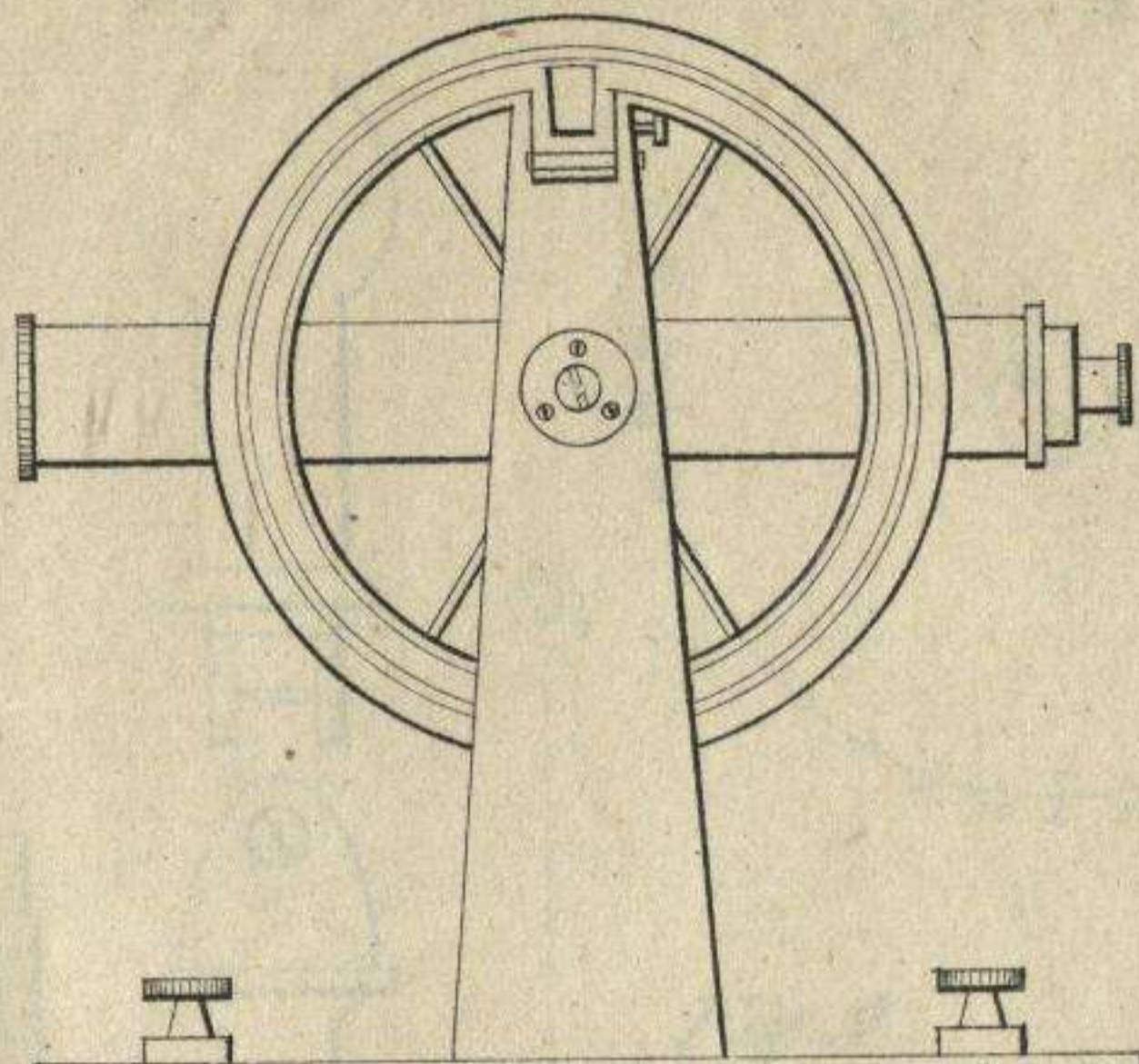

Fig. 140.

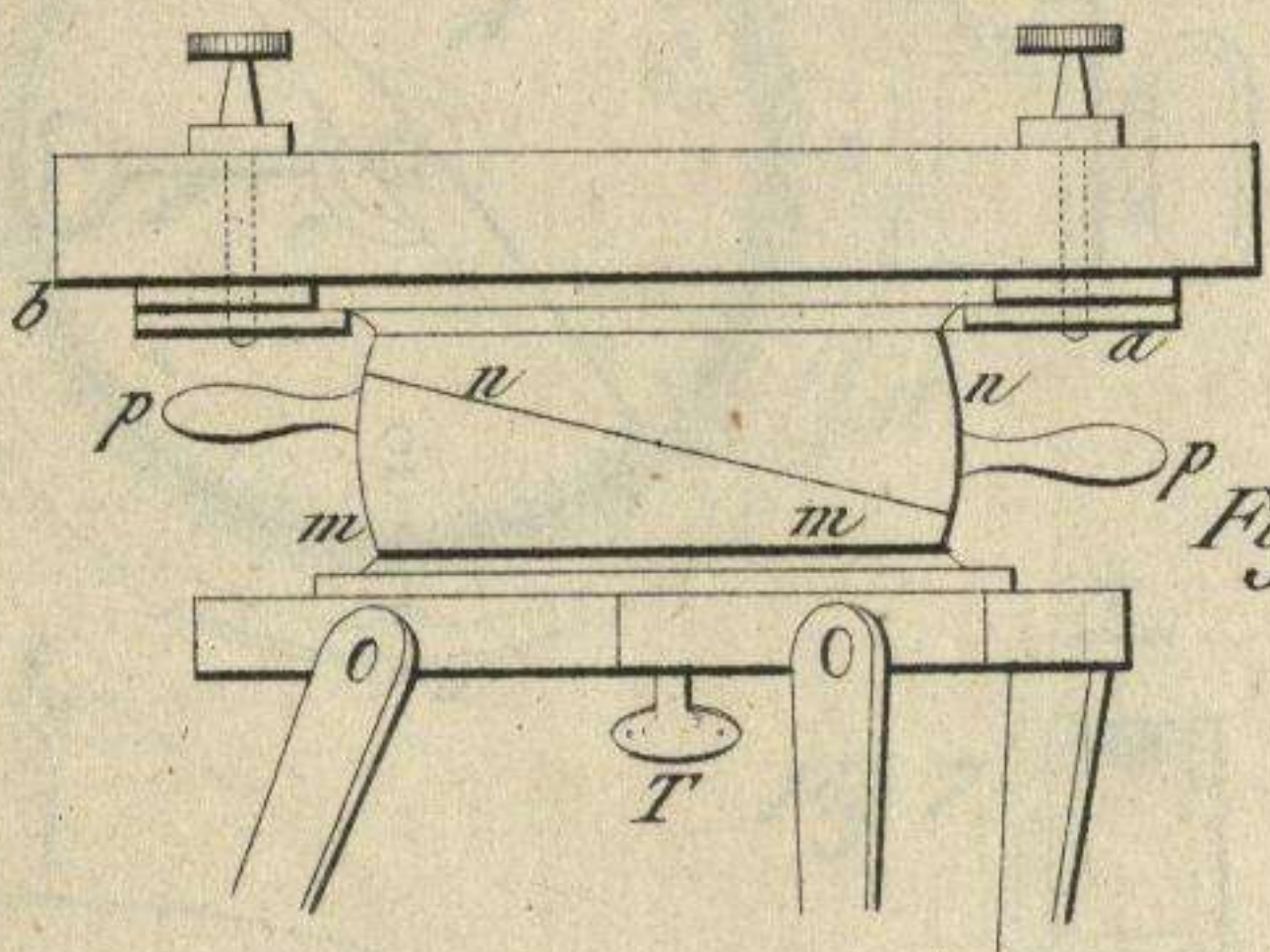

Fig. 139.

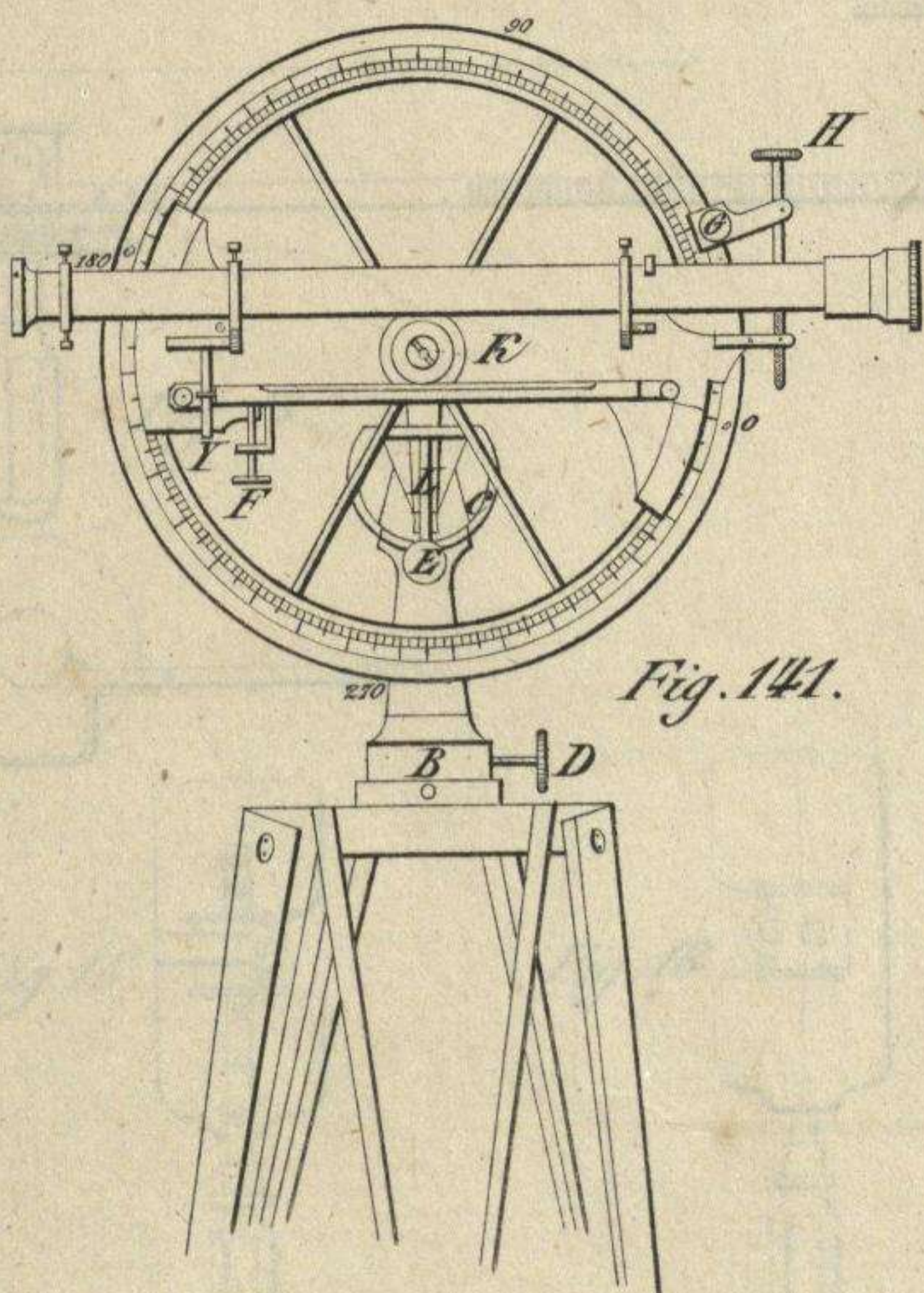
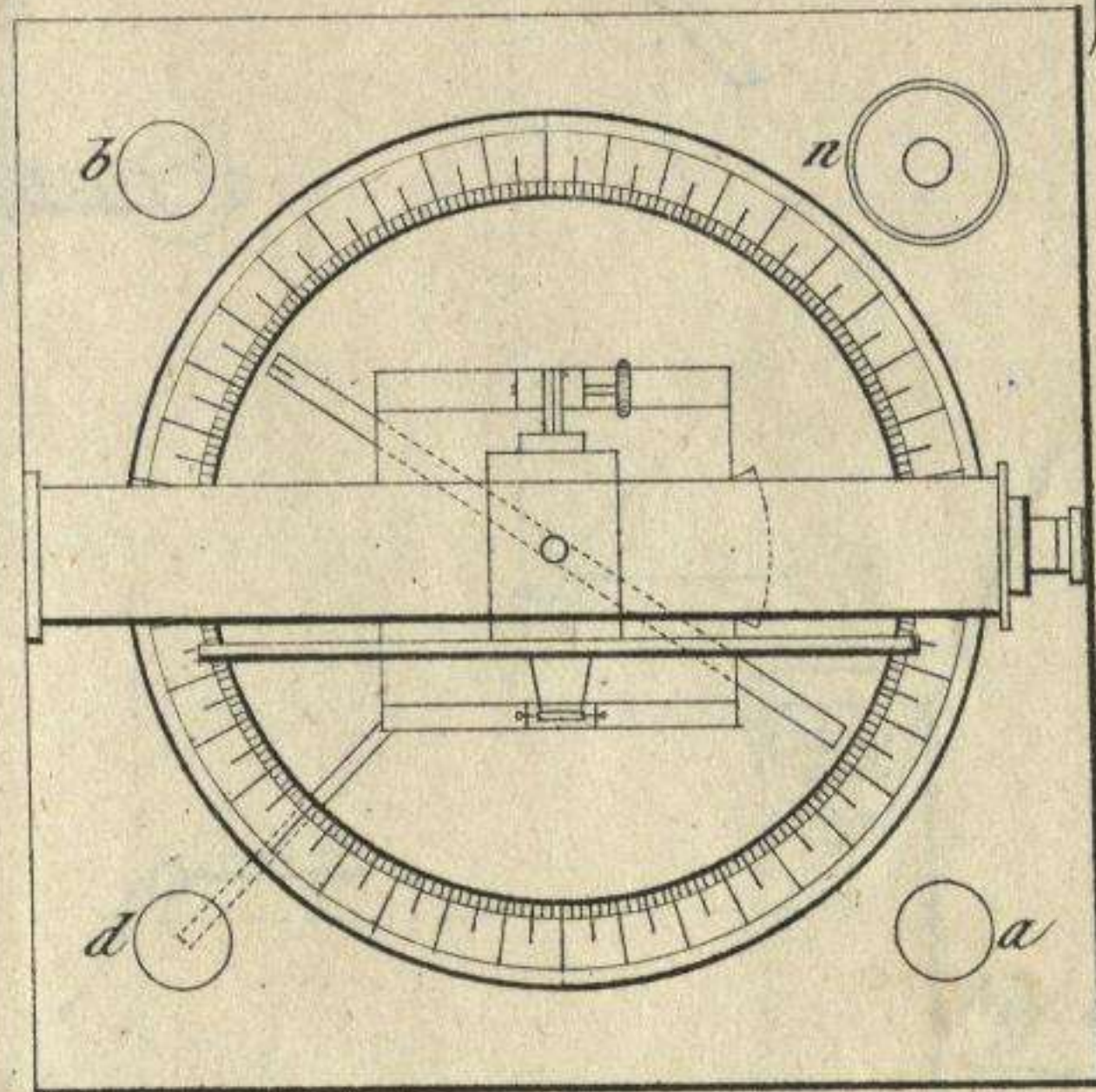

Fig. 141.

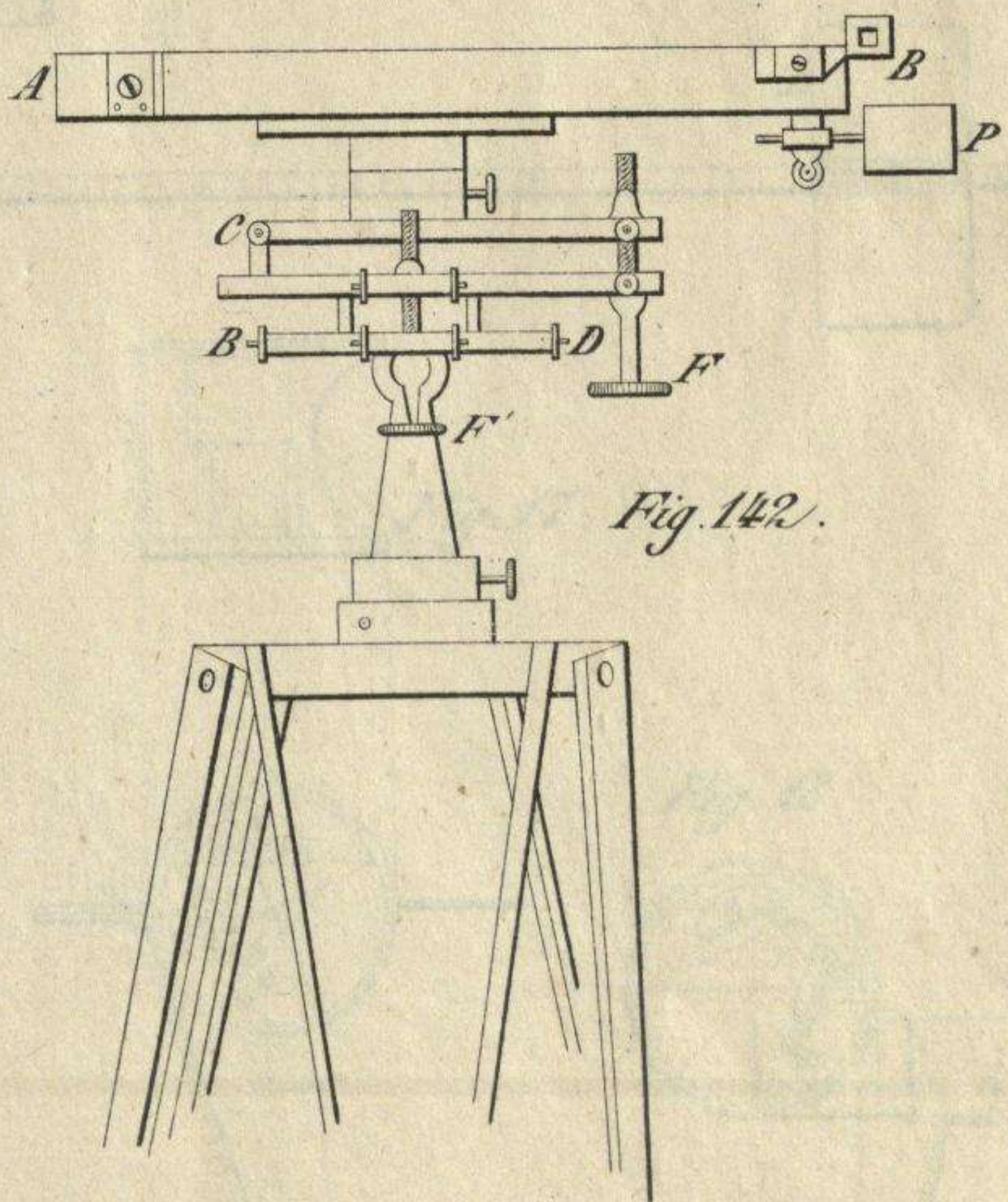

Fig. 142.

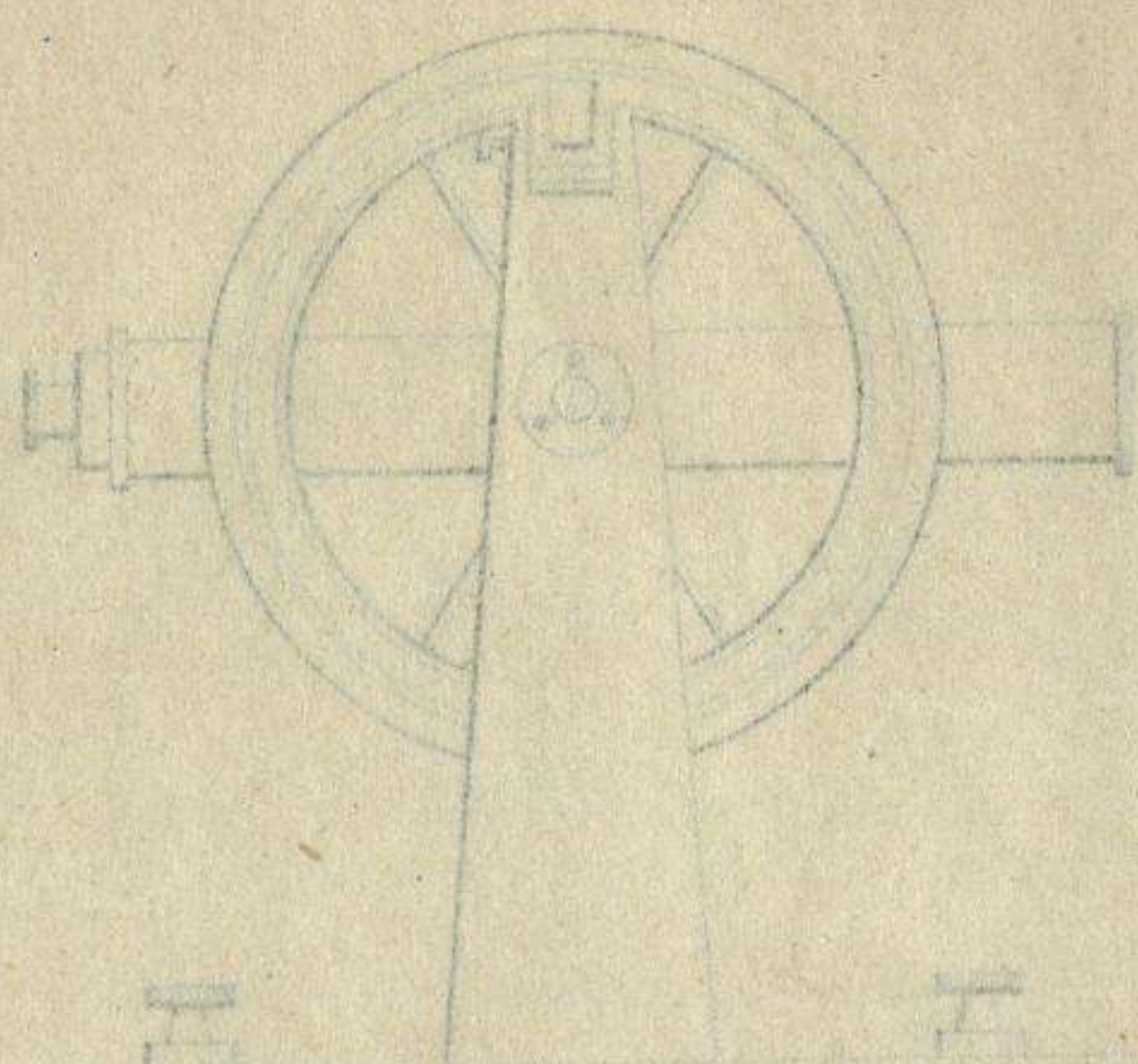

Fig. 140

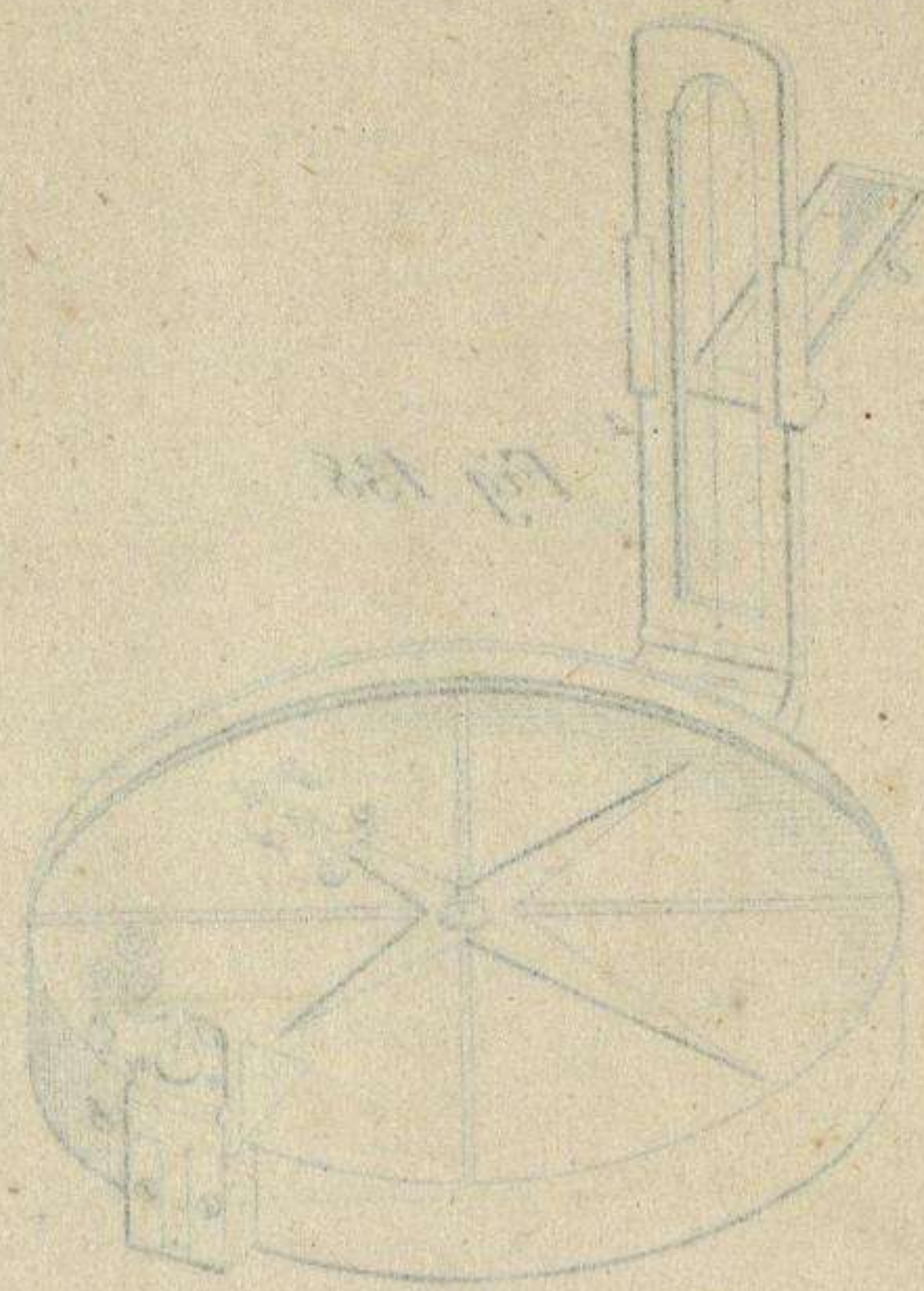
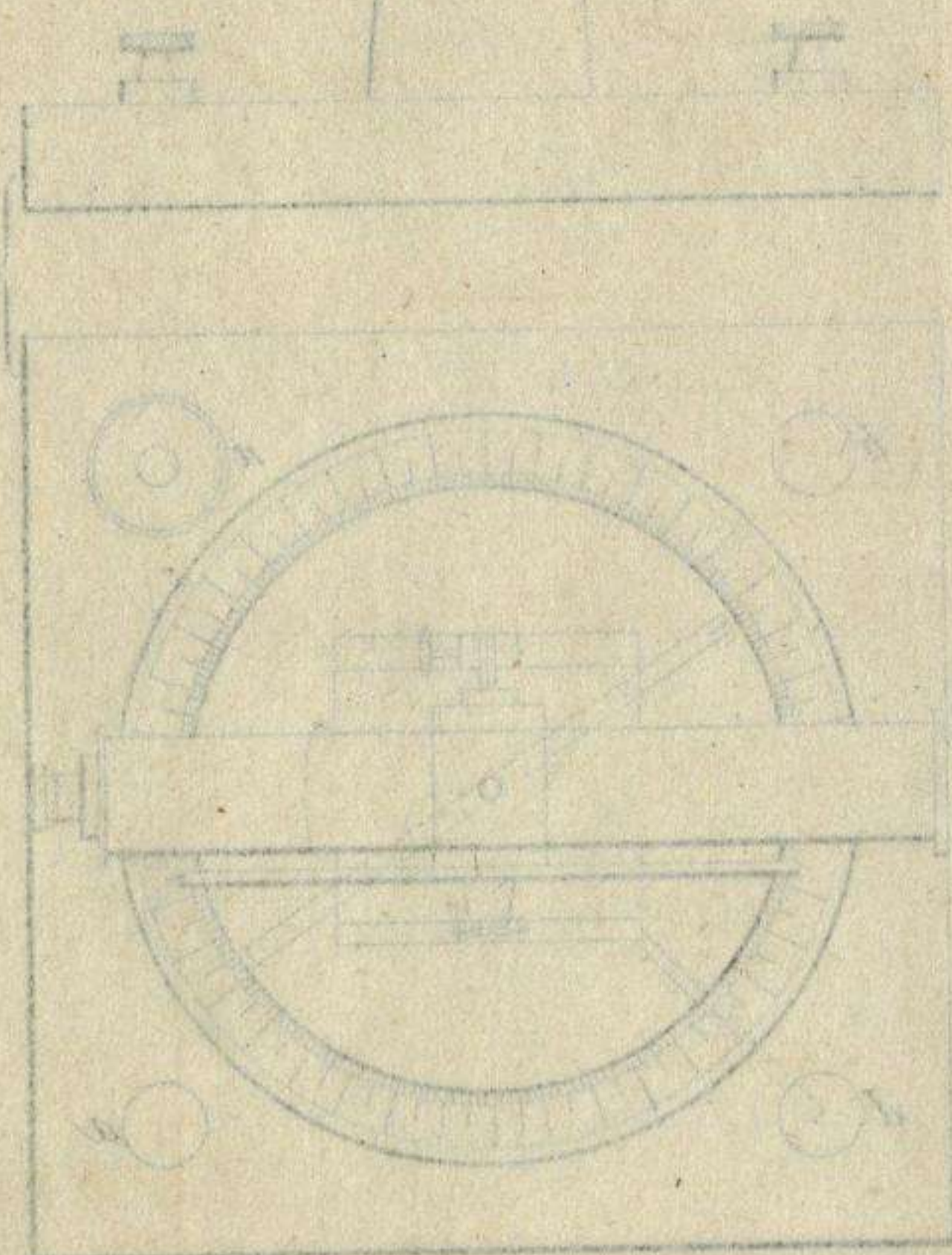

Fig. 138

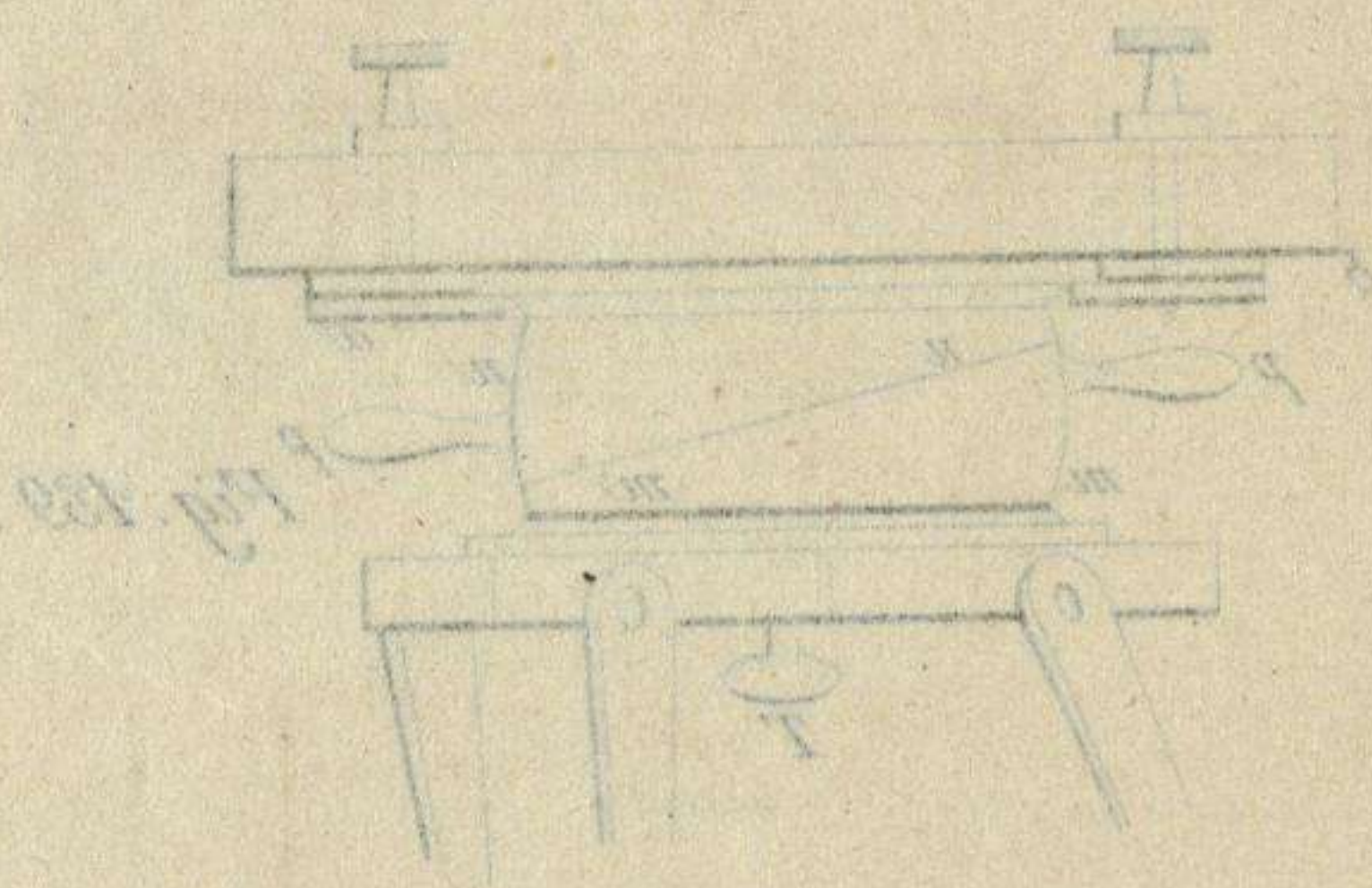

Fig. 137

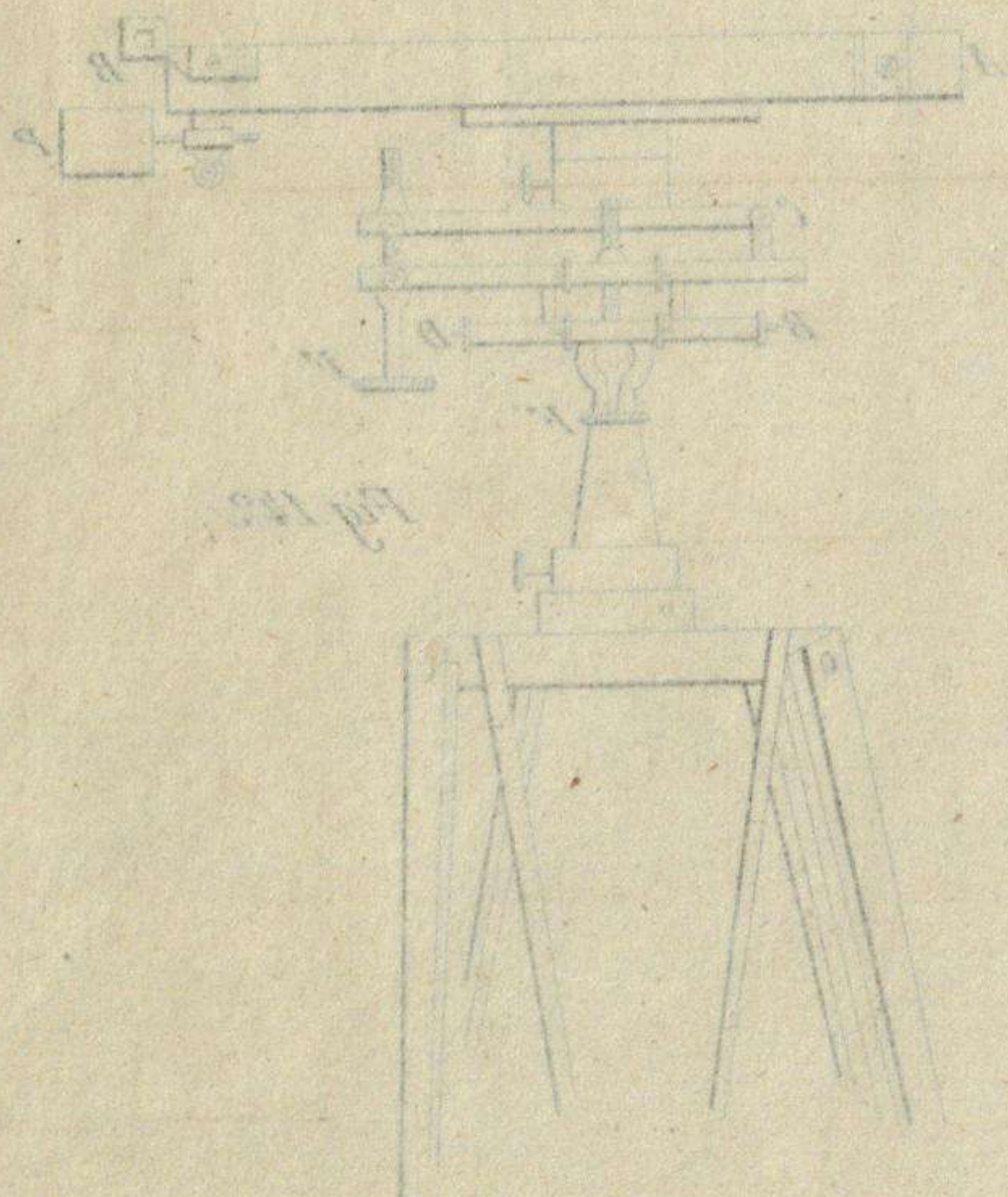

Fig. 136

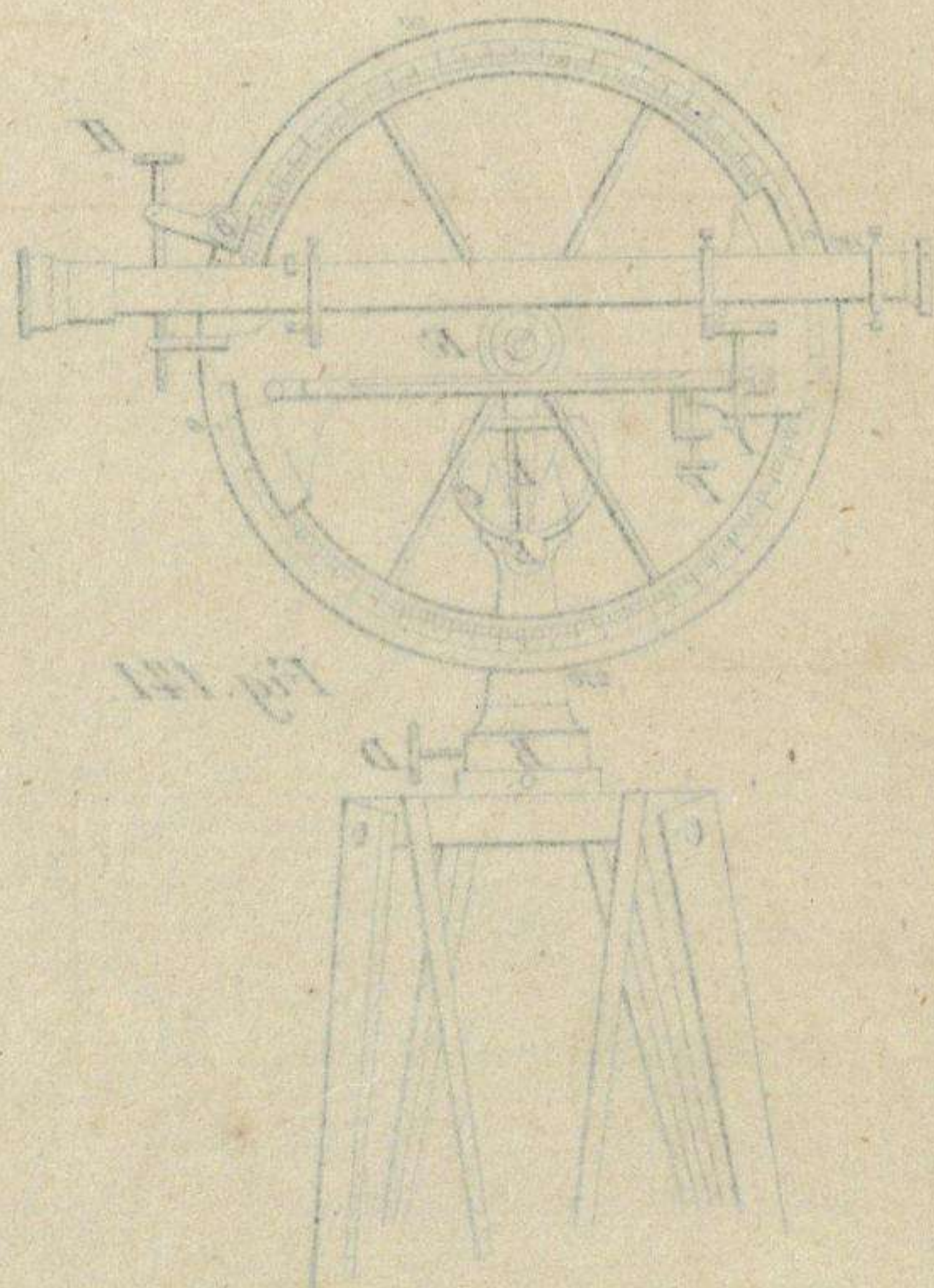

Fig. 135

Fig. 1.

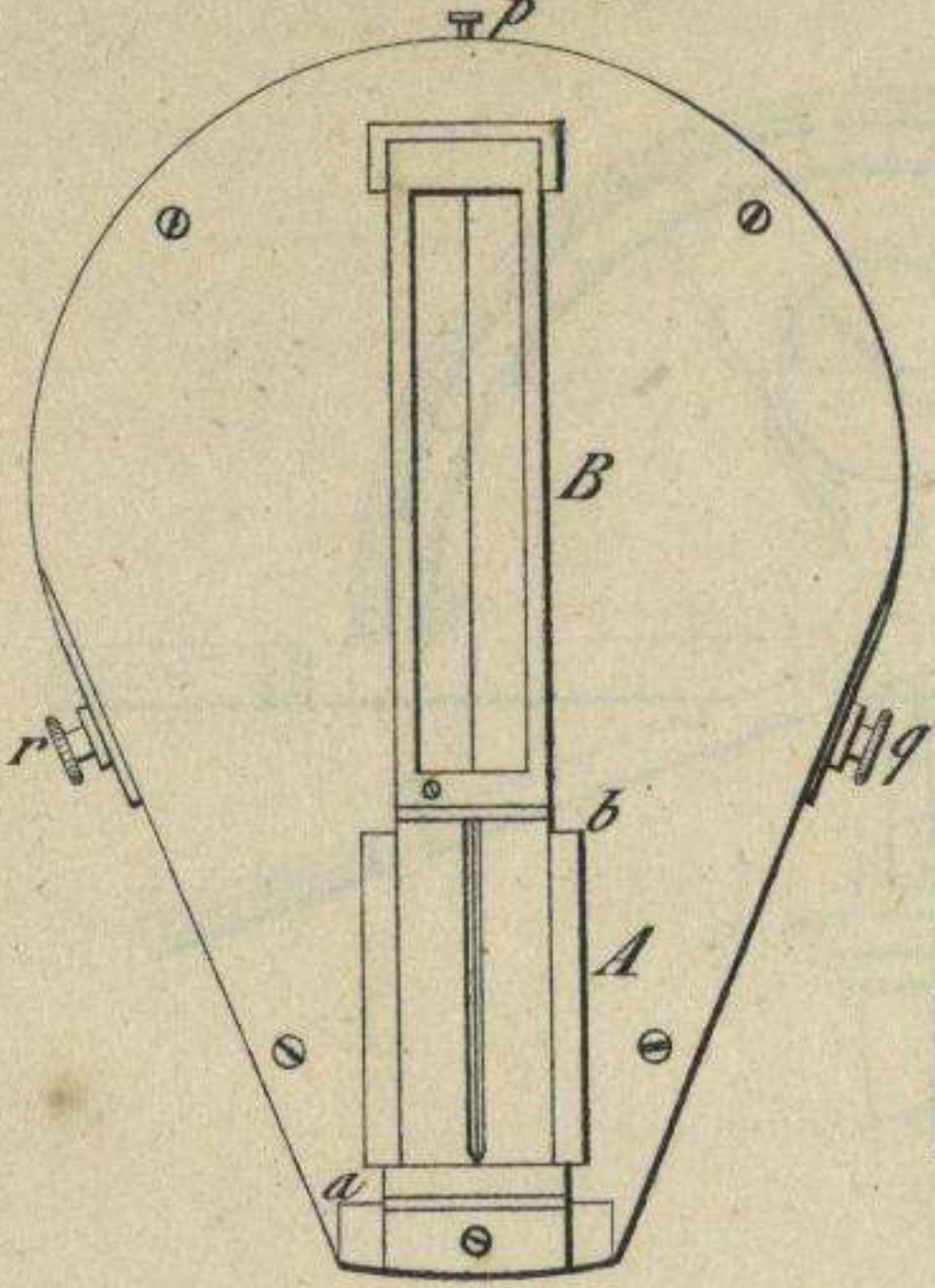

Fig. 2.

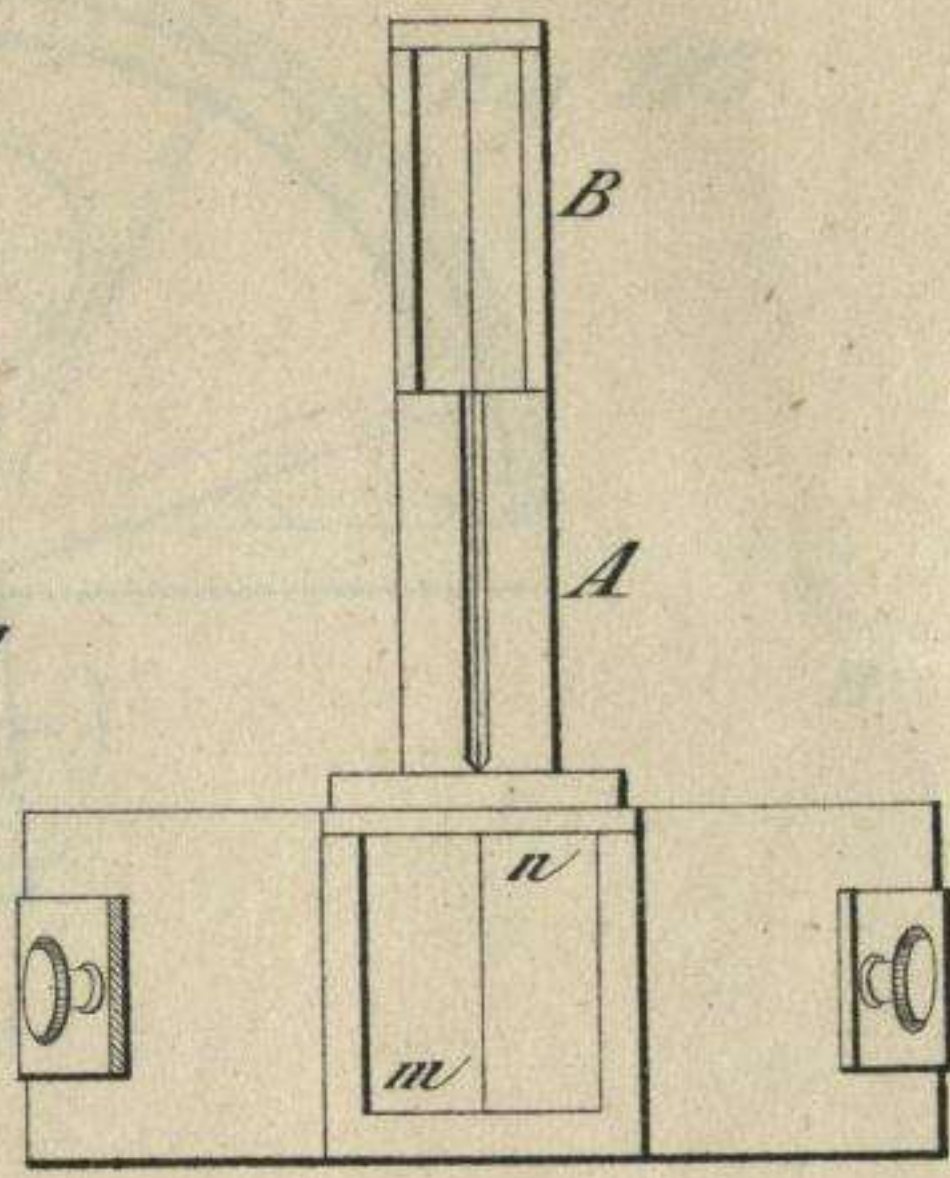

Fig. 3.

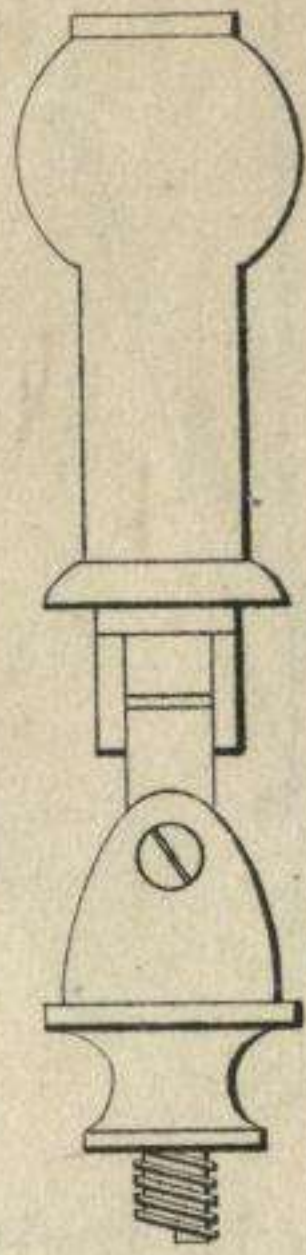

Fig. 4.

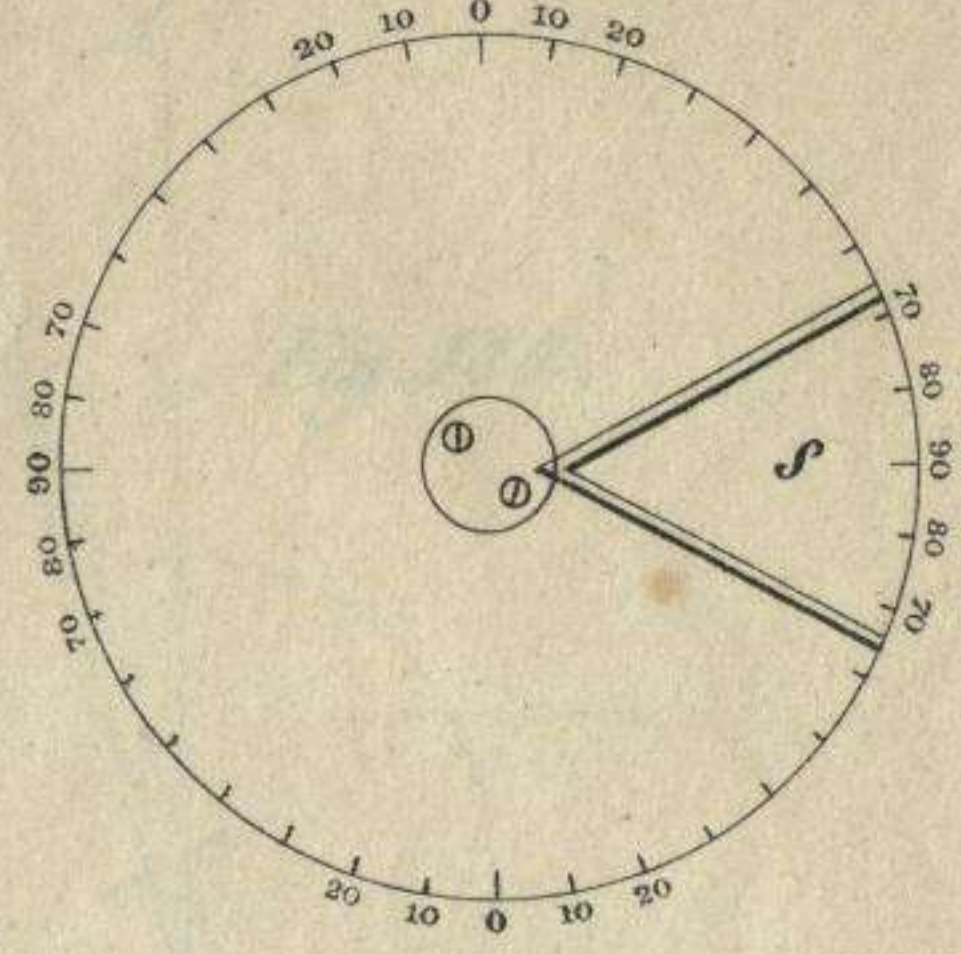

Fig. 9.

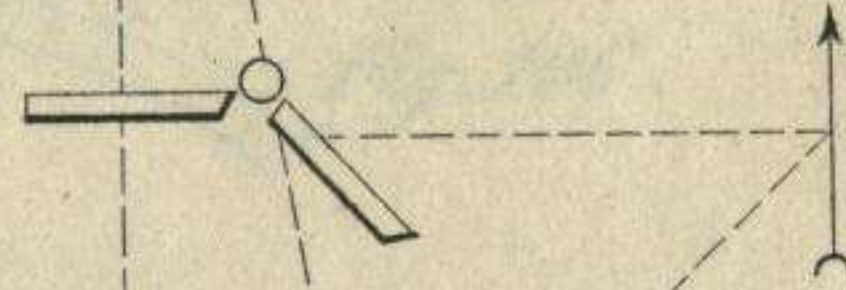

Fig. 5.

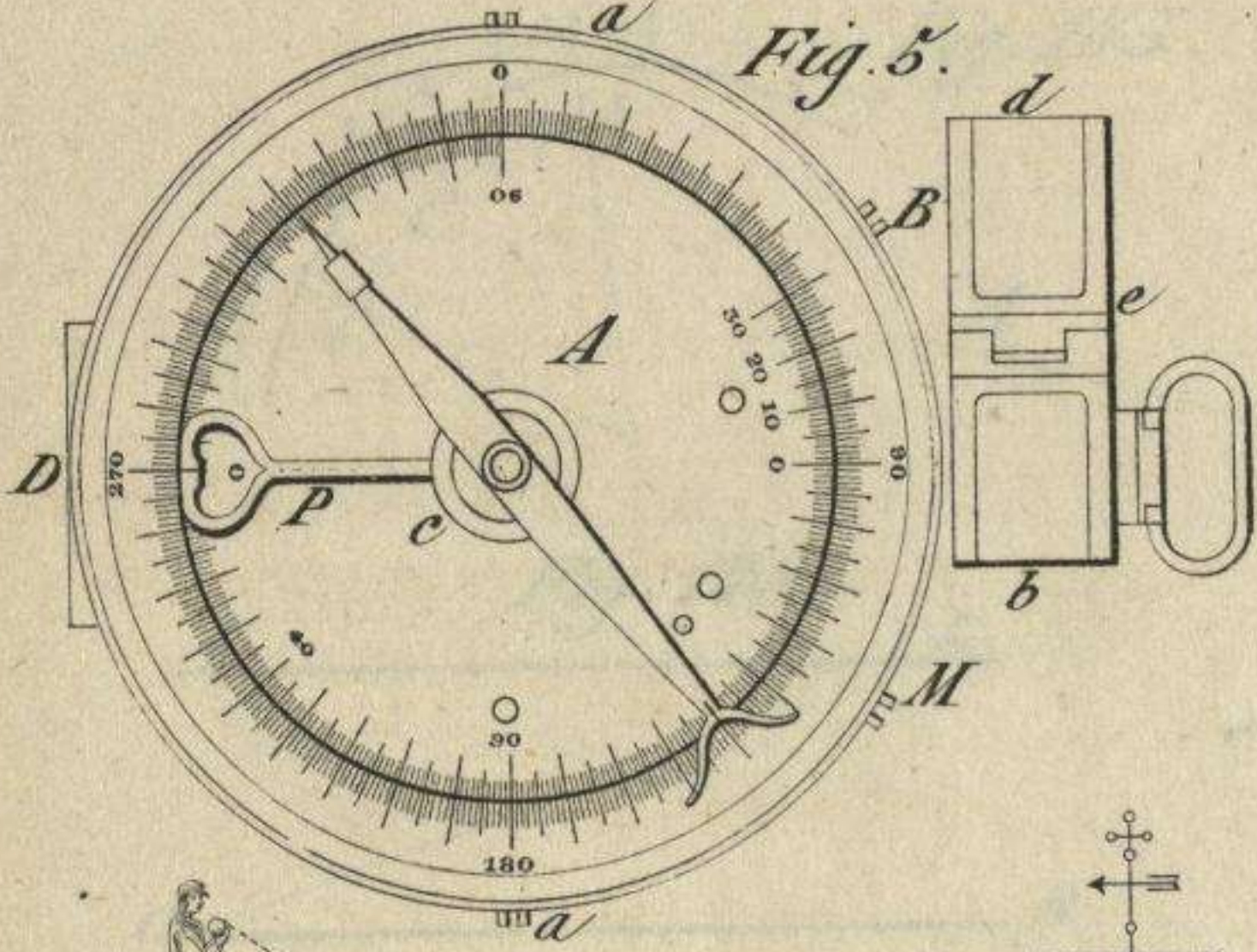

Fig. 6.

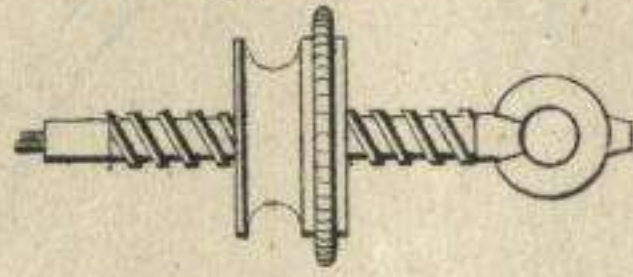

Fig. 8.

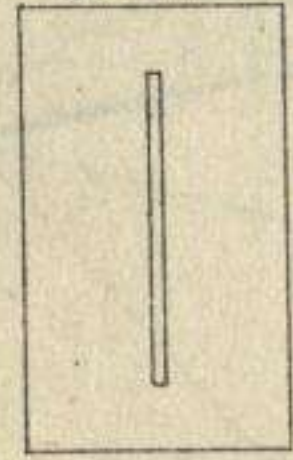

Fig. 7.

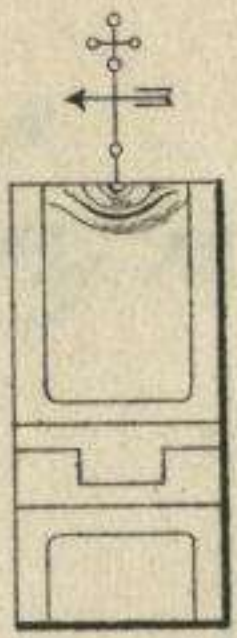

Fig. 12.

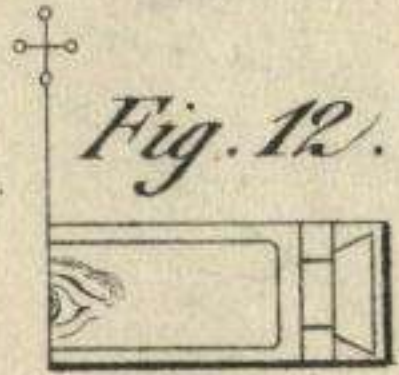

Fig. 13.

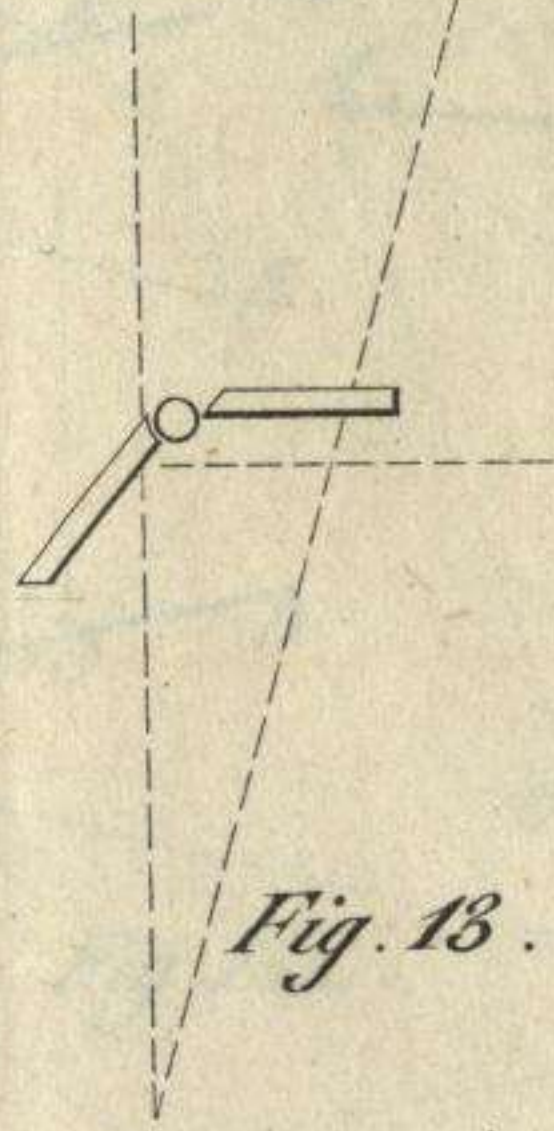

Fig. 10.

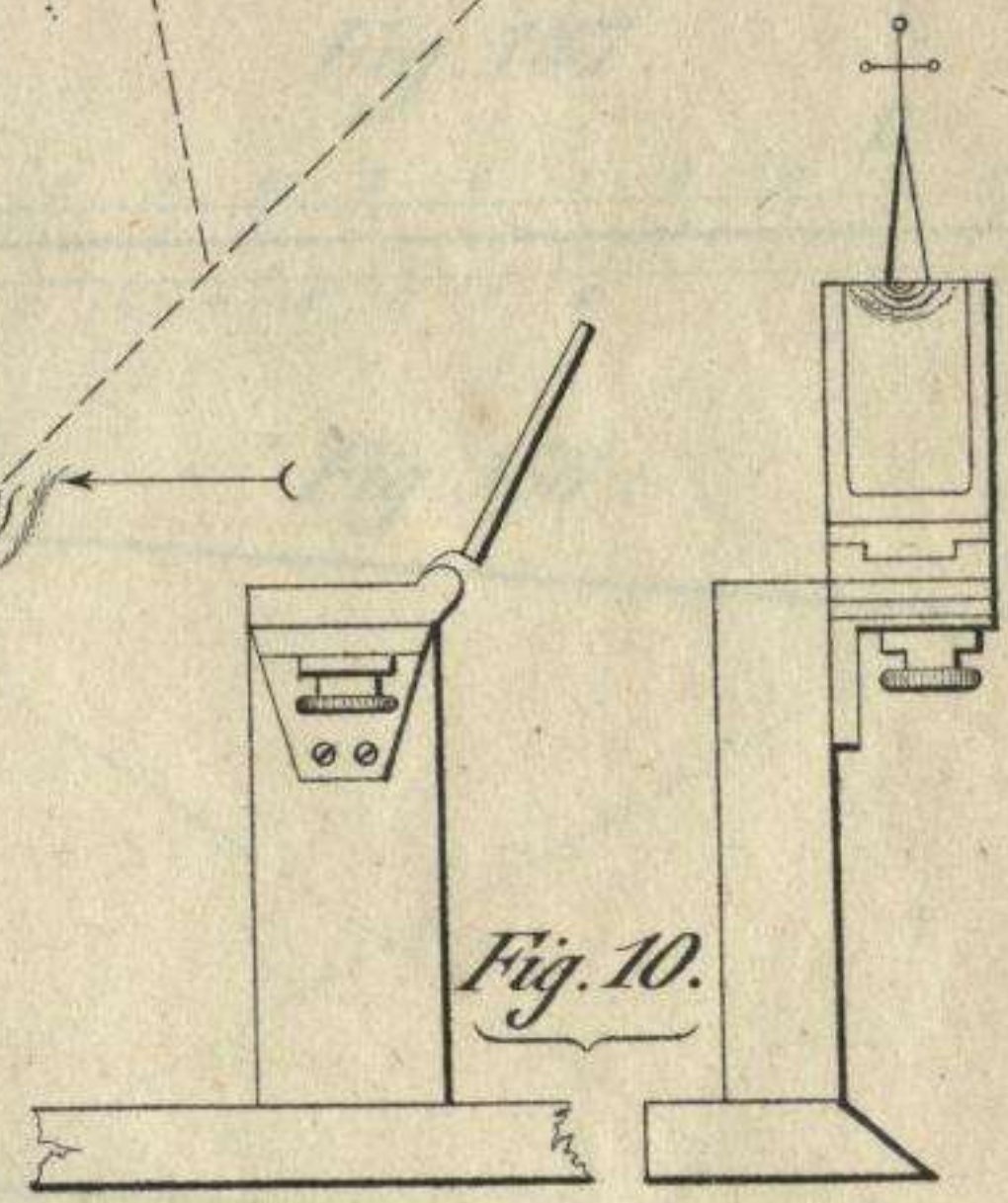

Fig. 11.

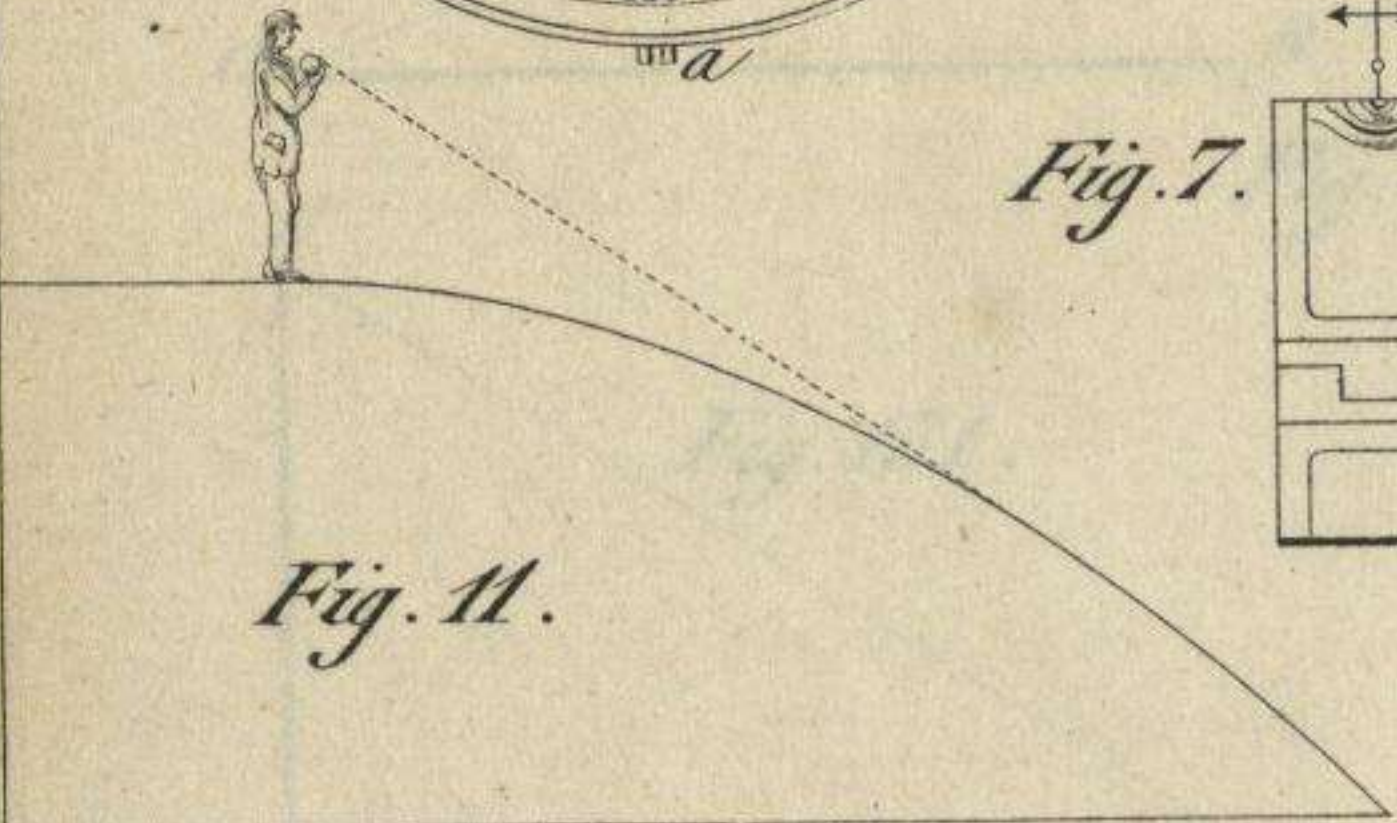

Fig. 14.

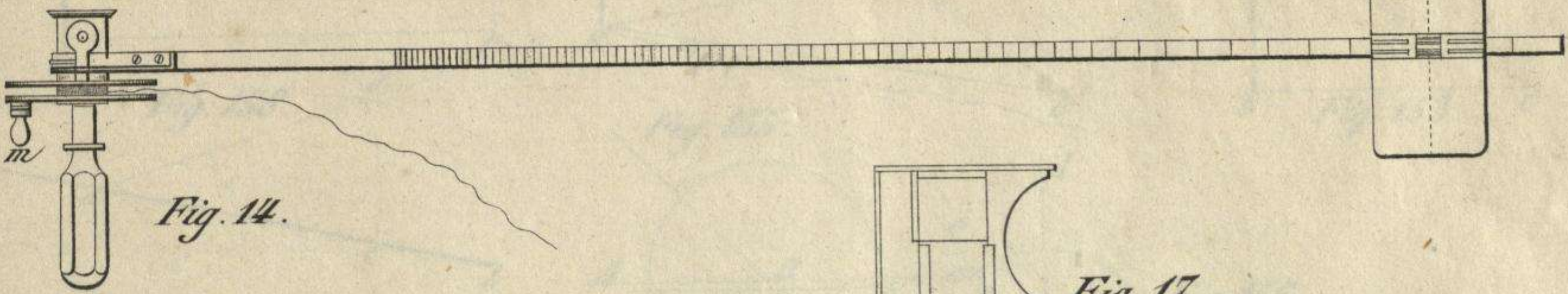

Fig. 17.

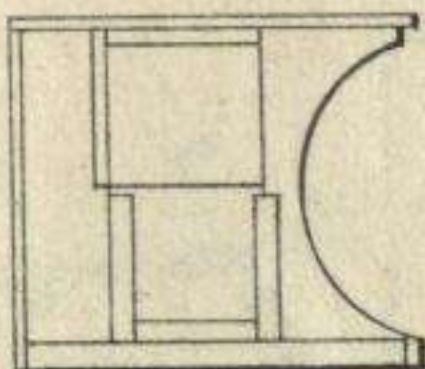

Fig. 15.

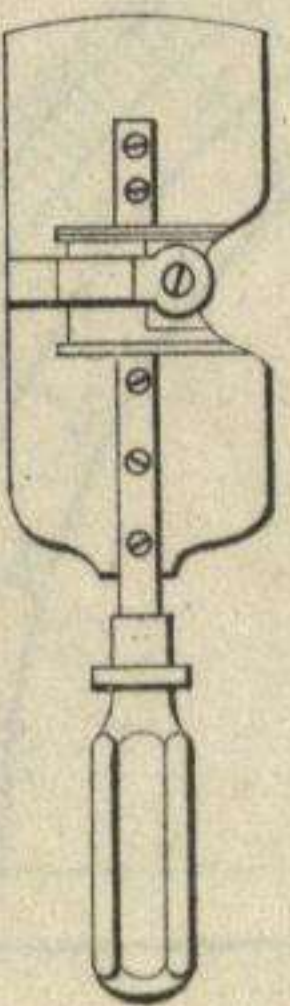

Fig. 16.

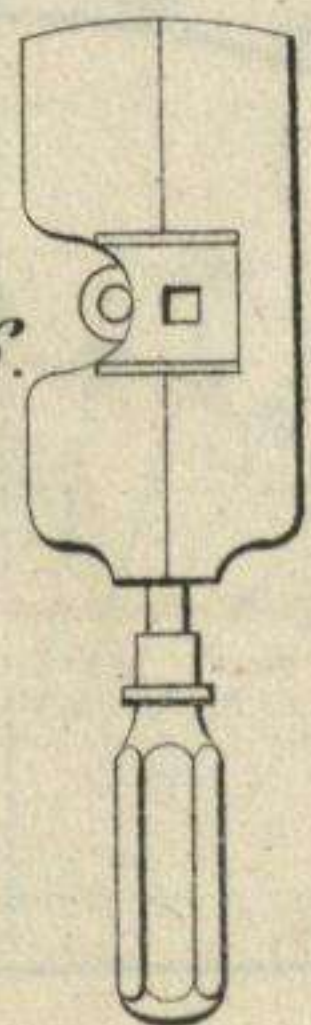
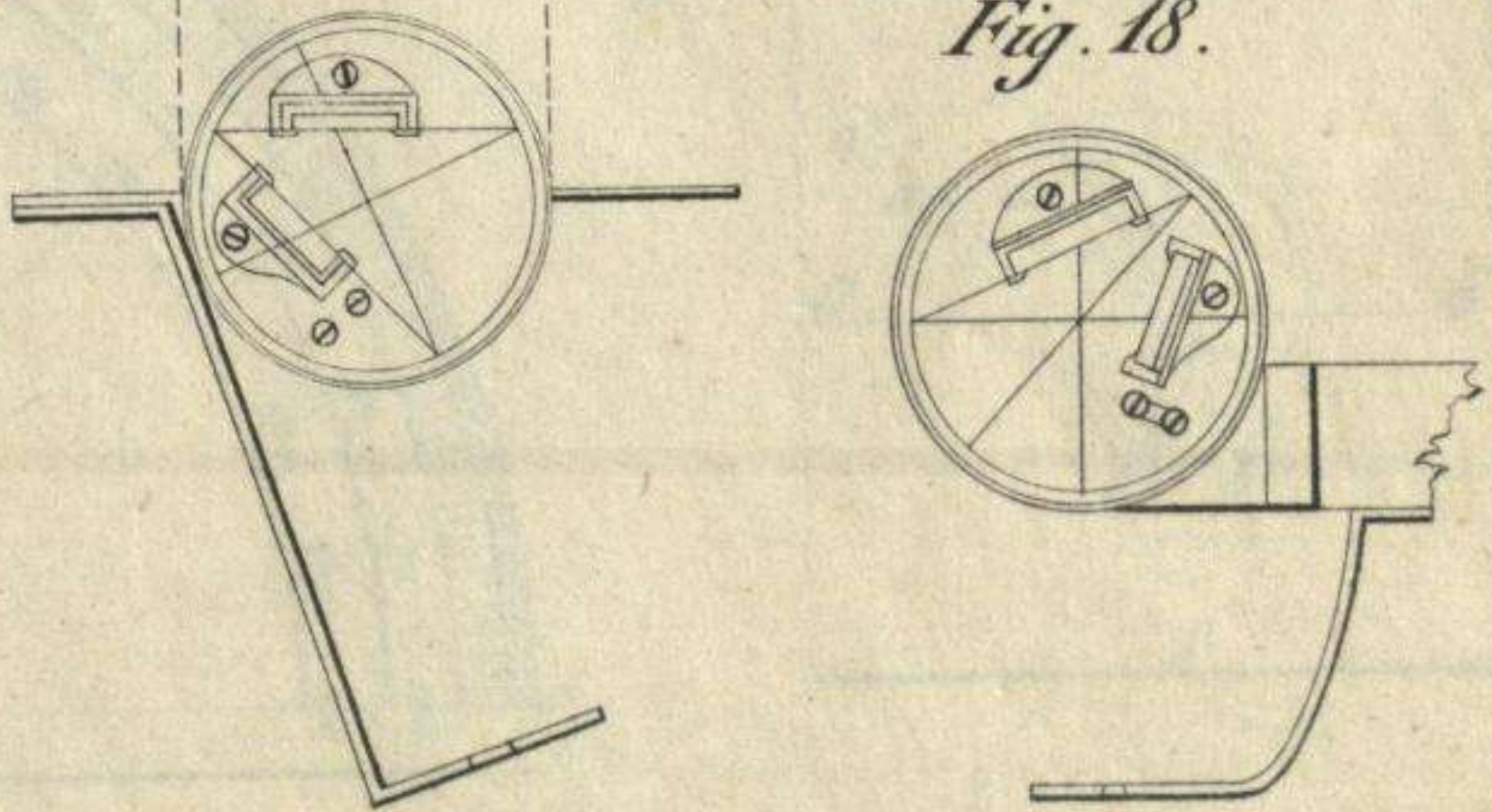
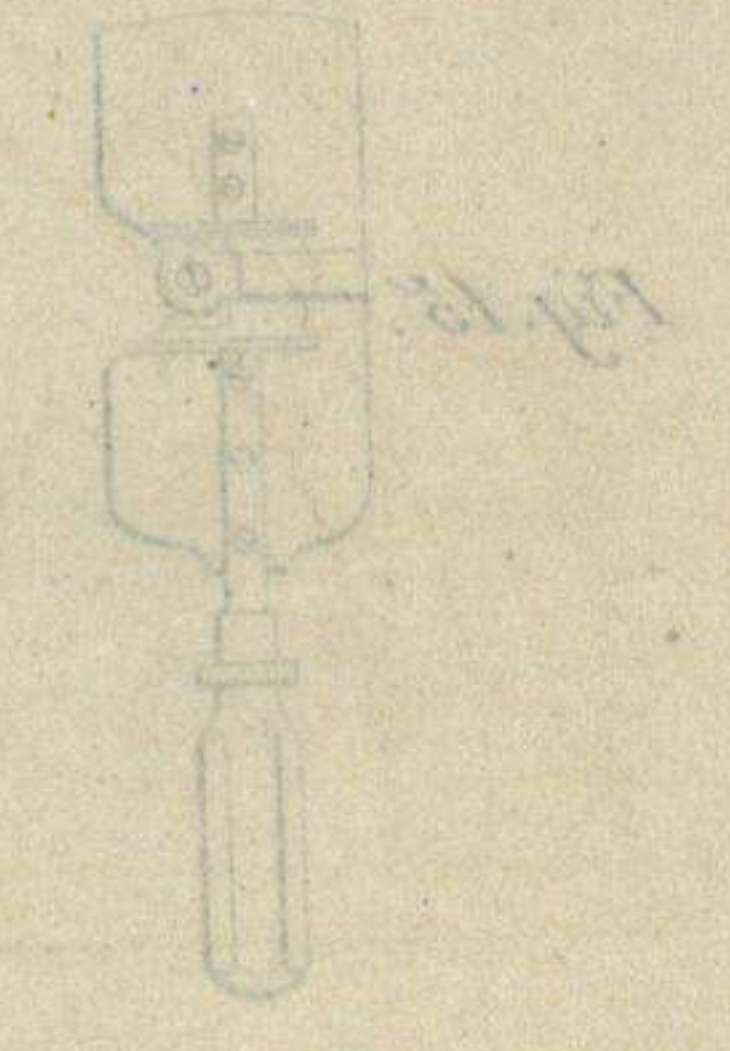
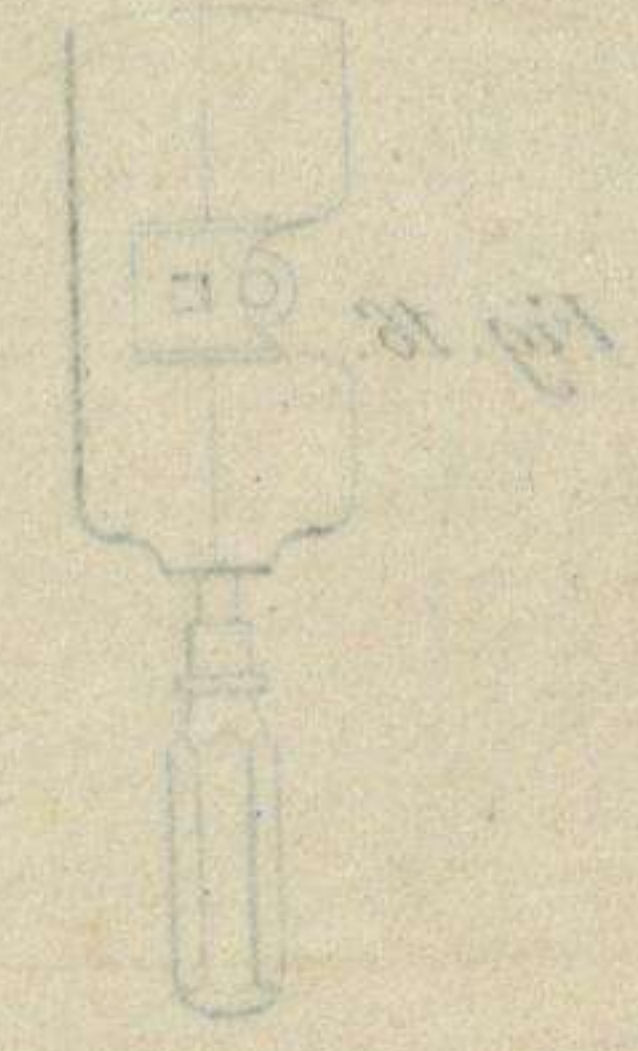
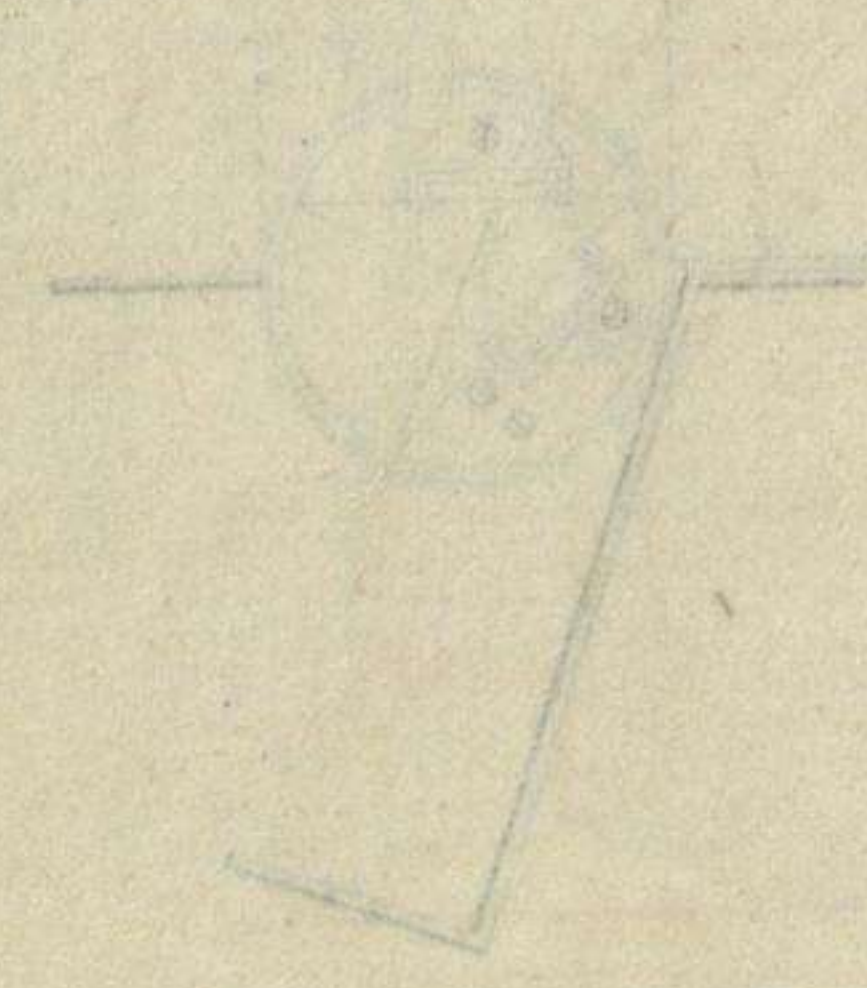
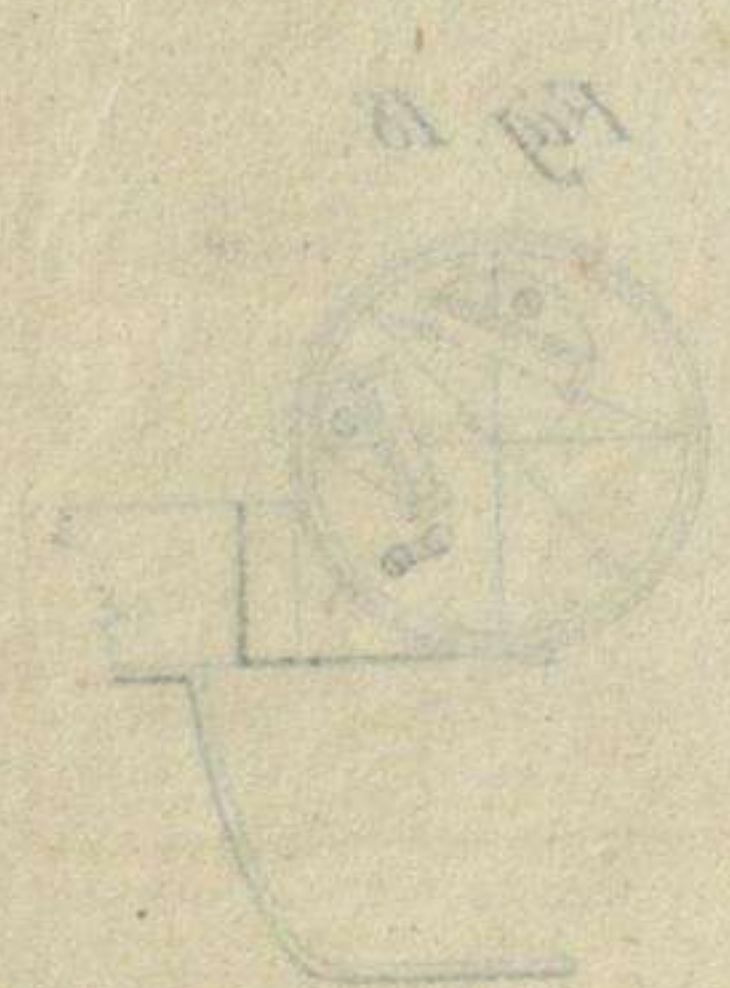
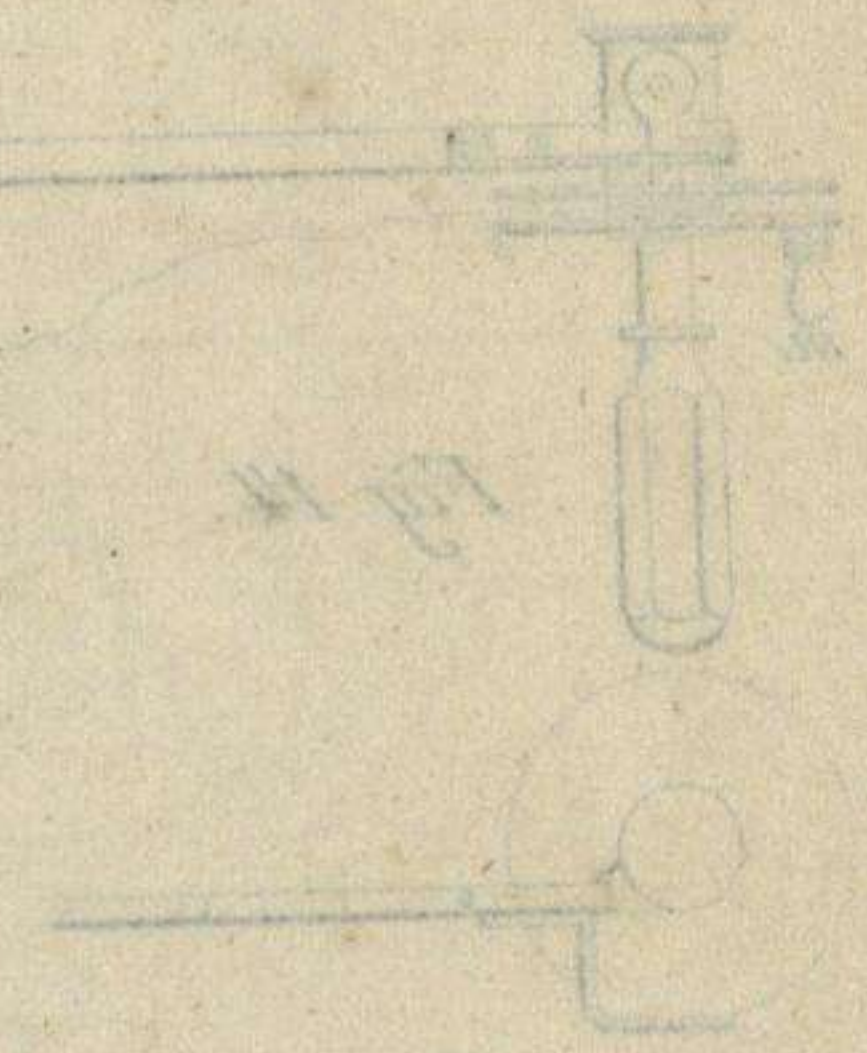
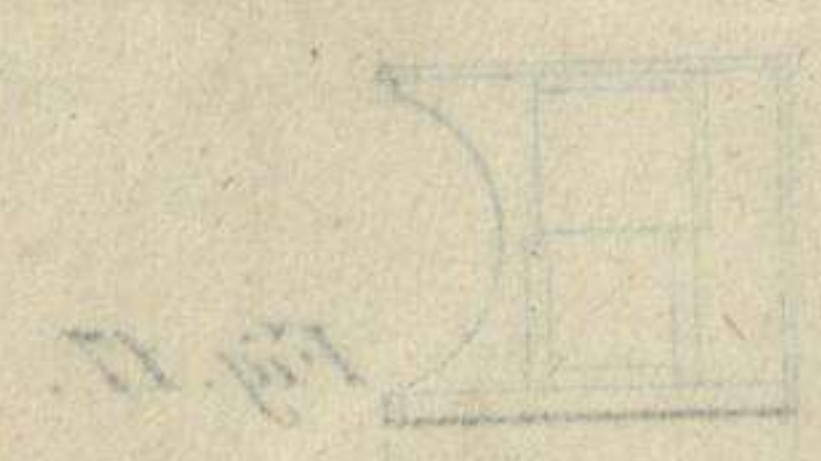
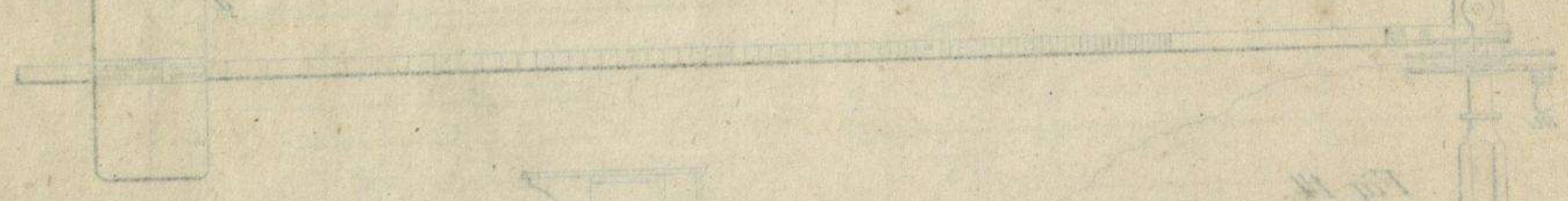
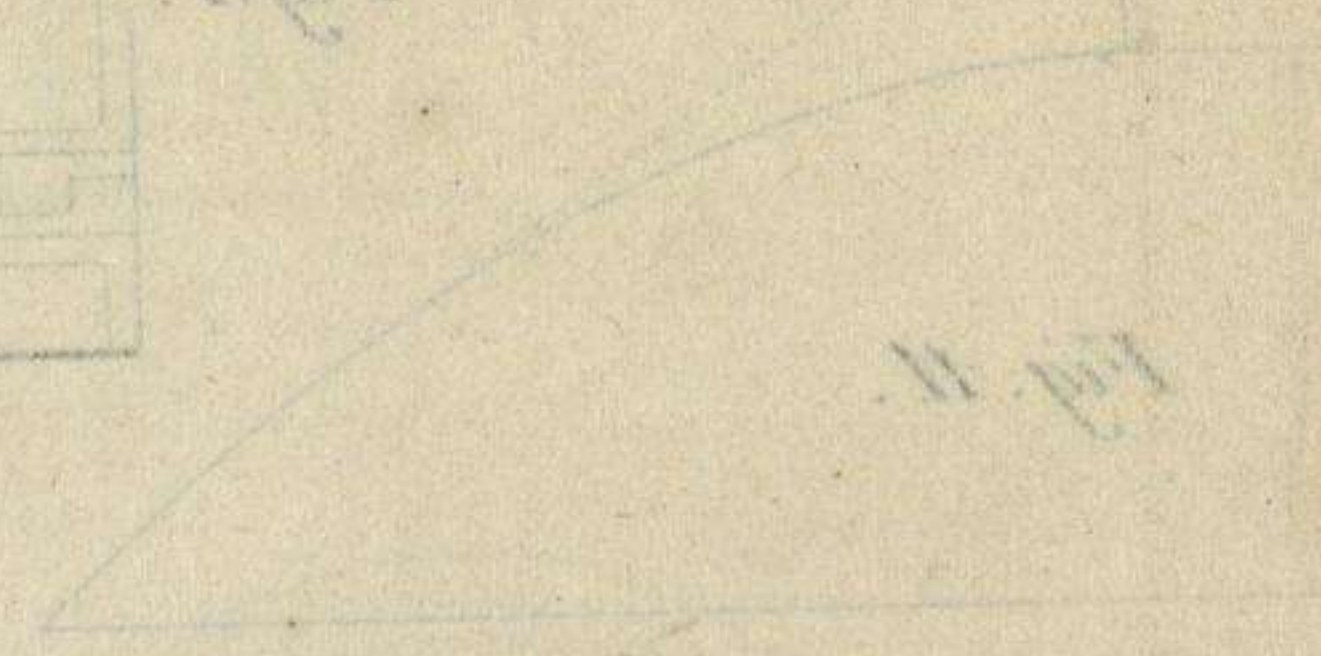
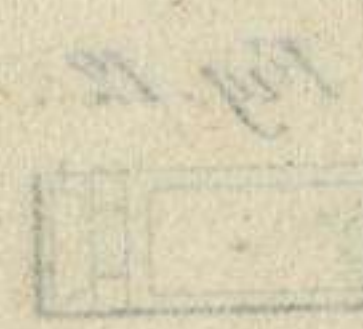
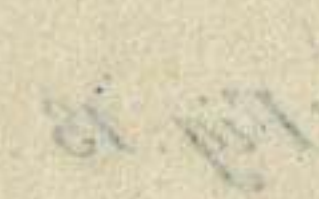
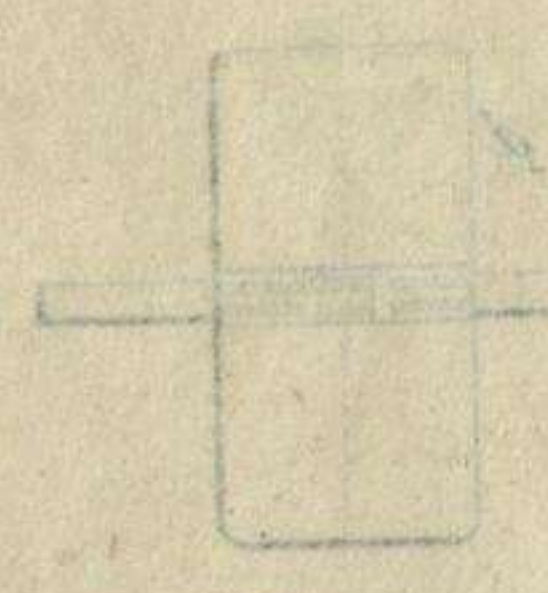
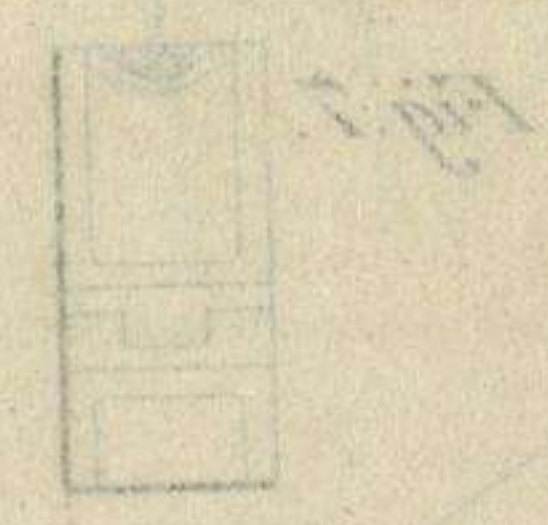
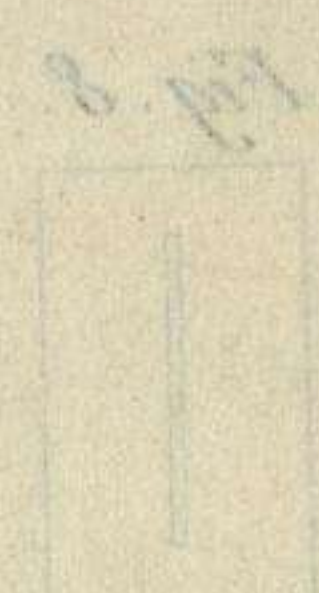
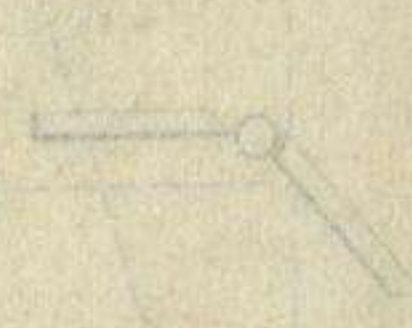
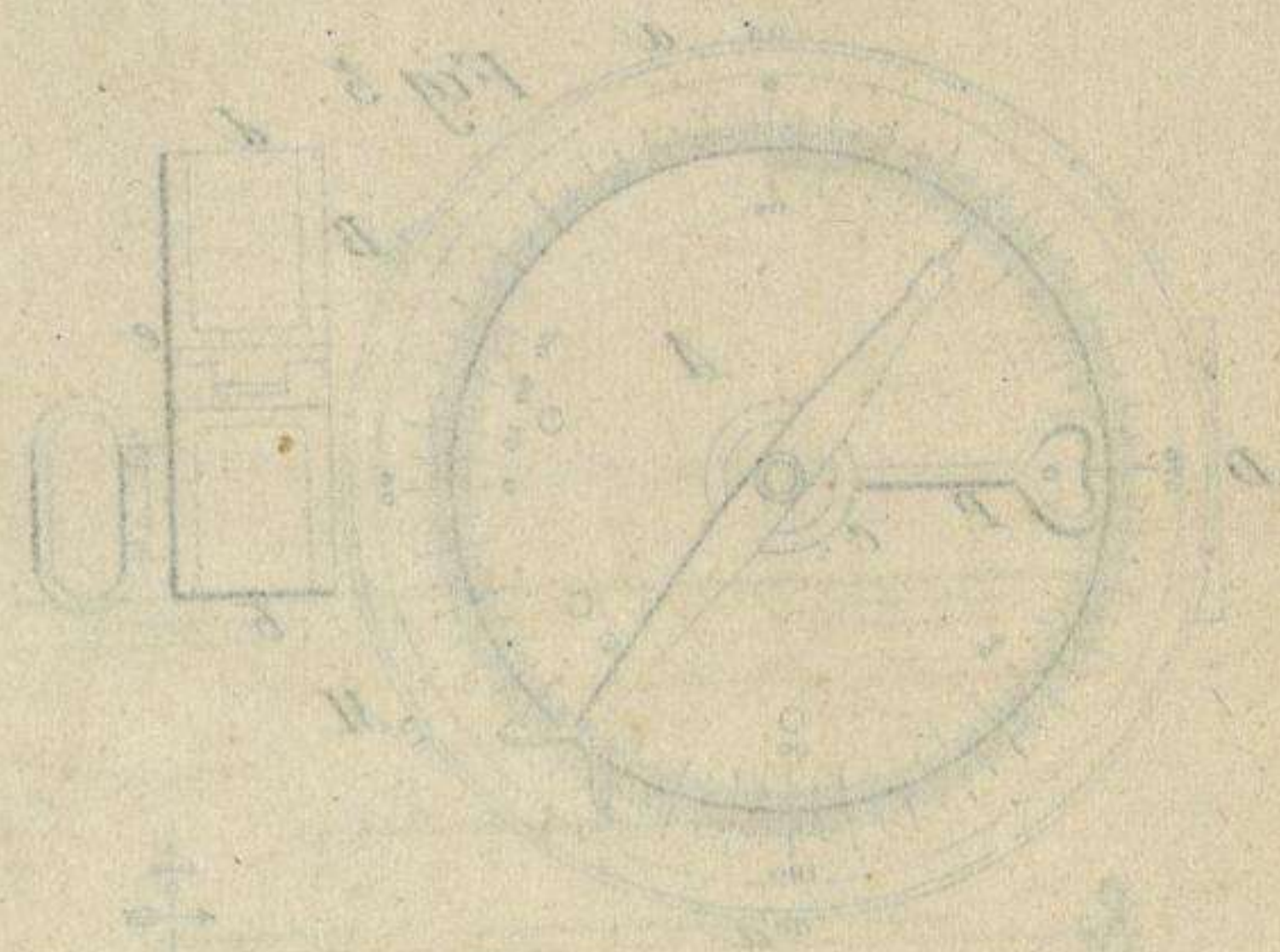
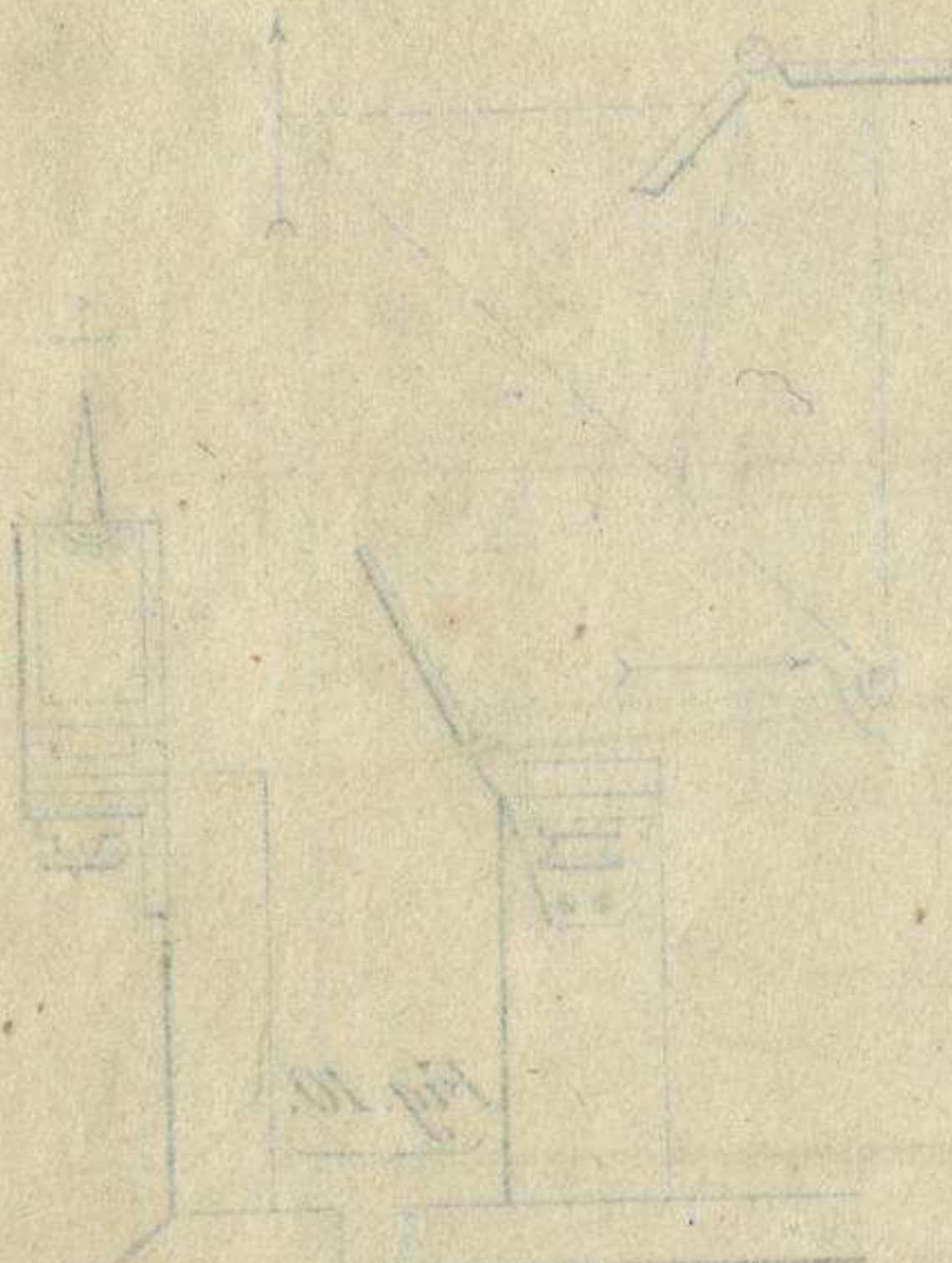
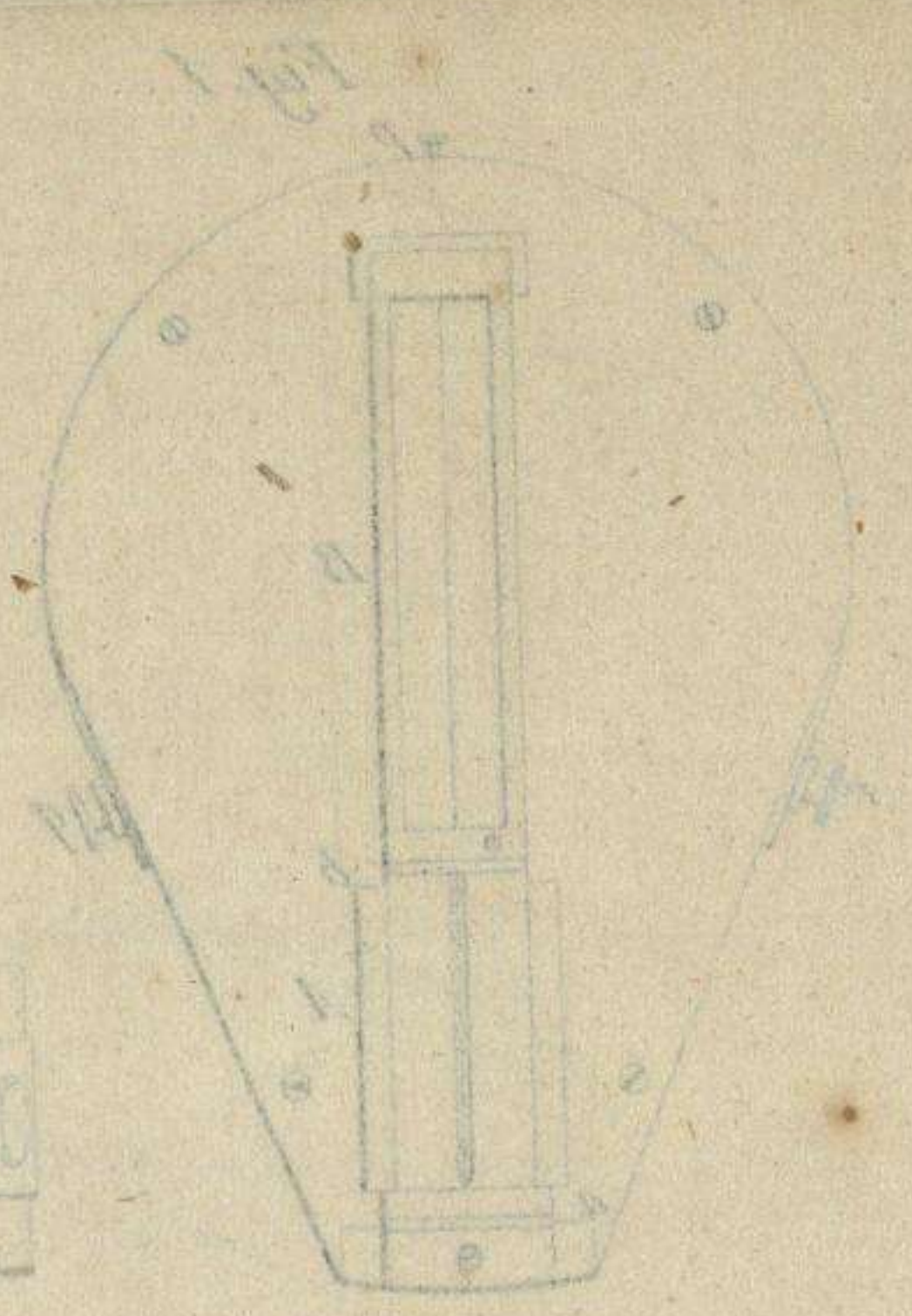
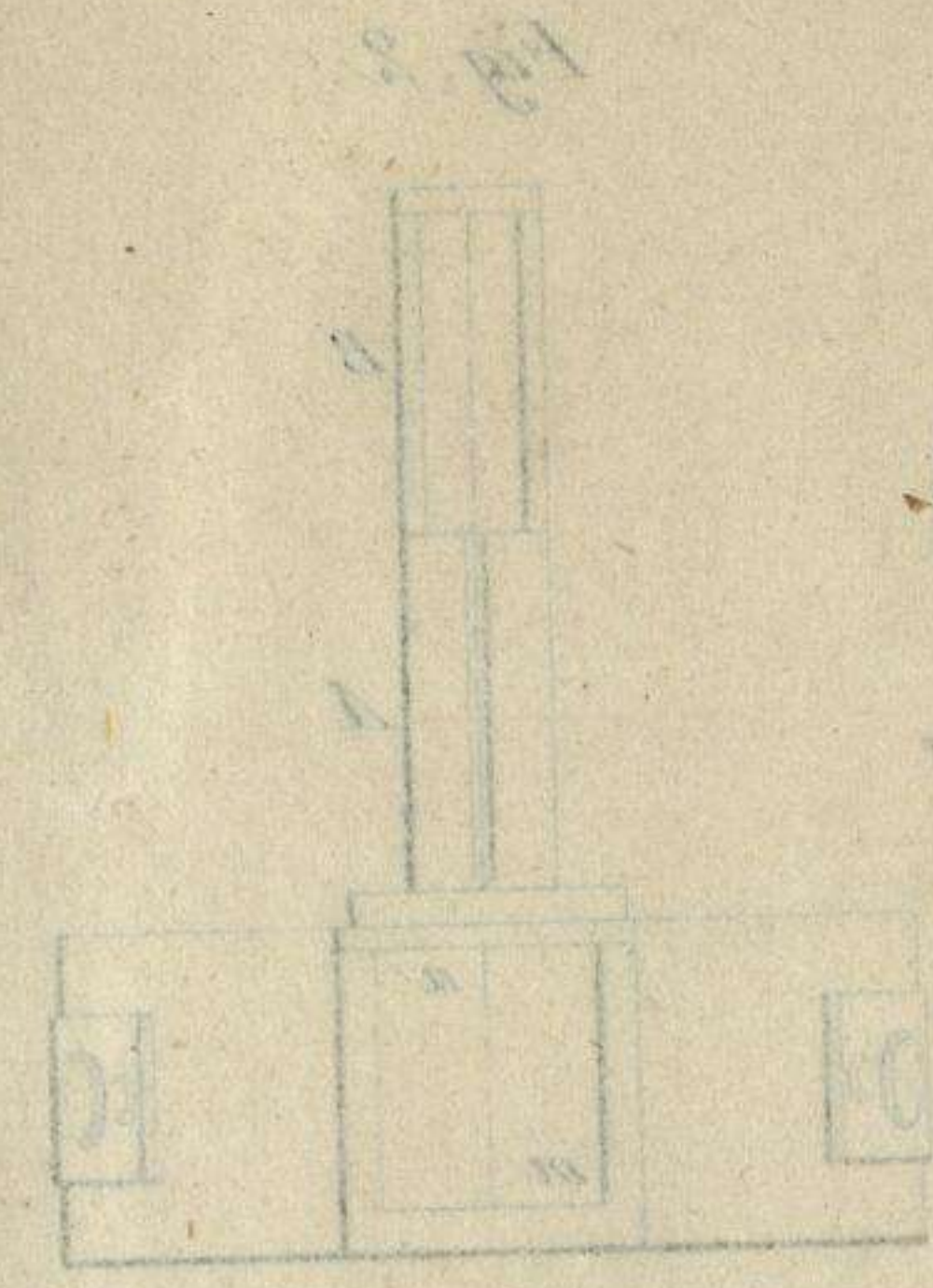
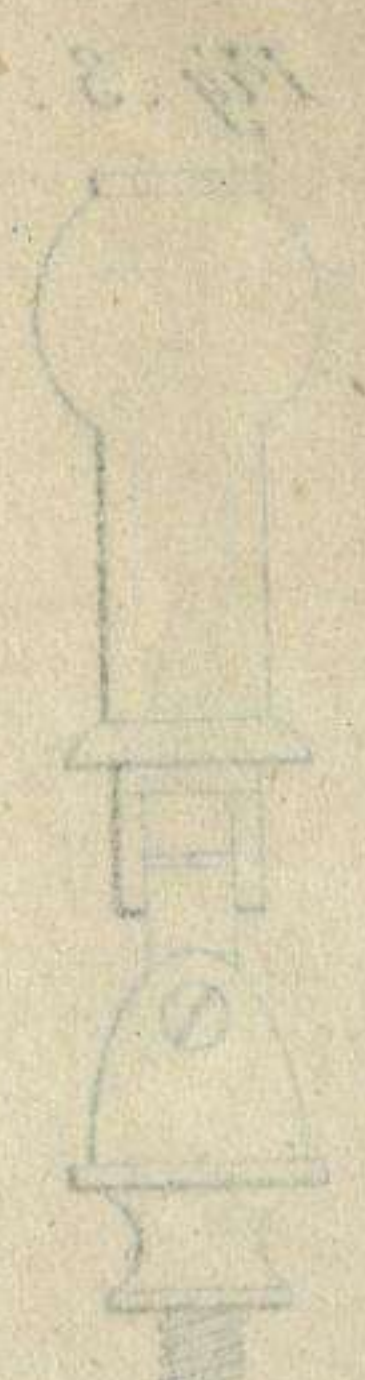

Fig. 18.





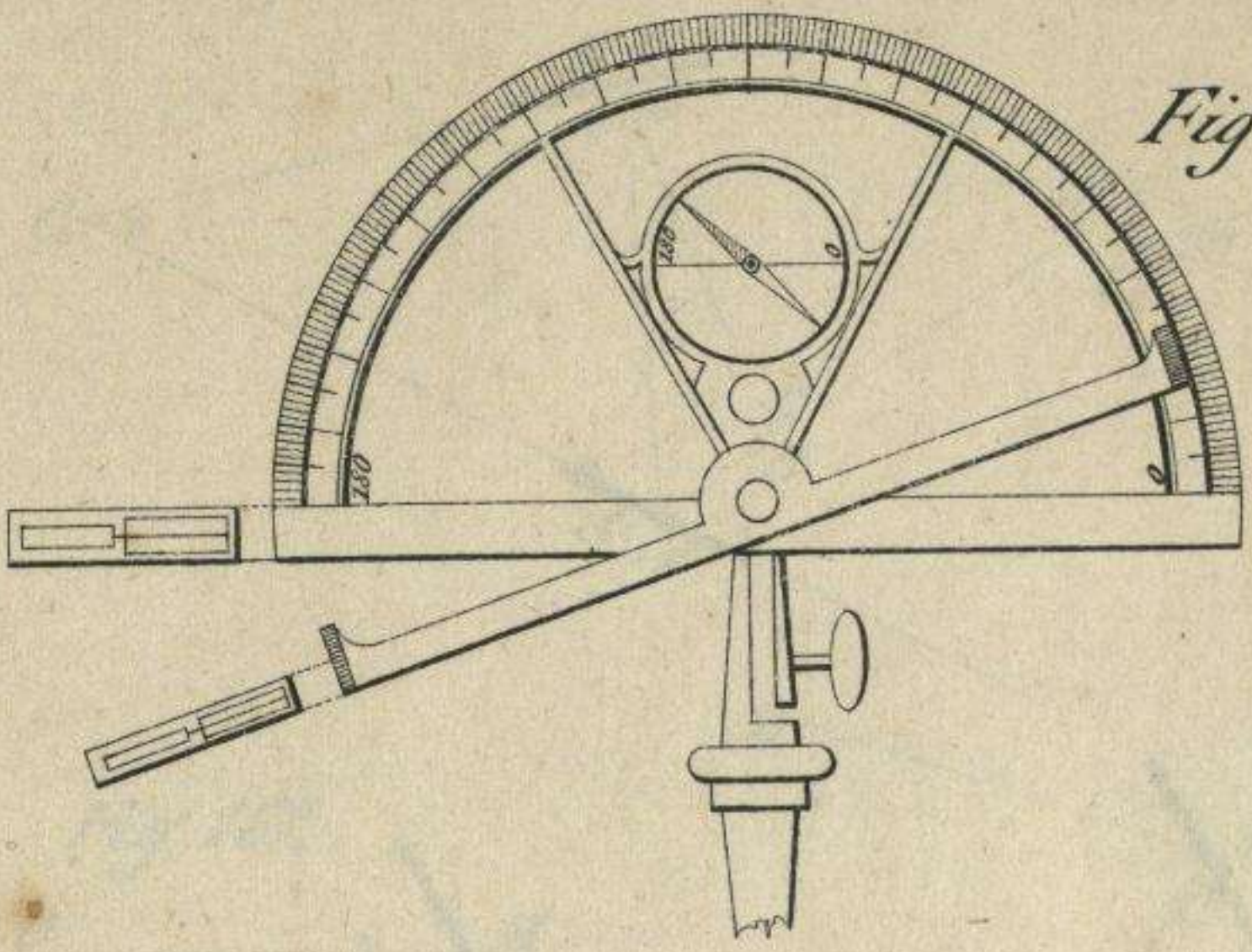

Fig. 143.

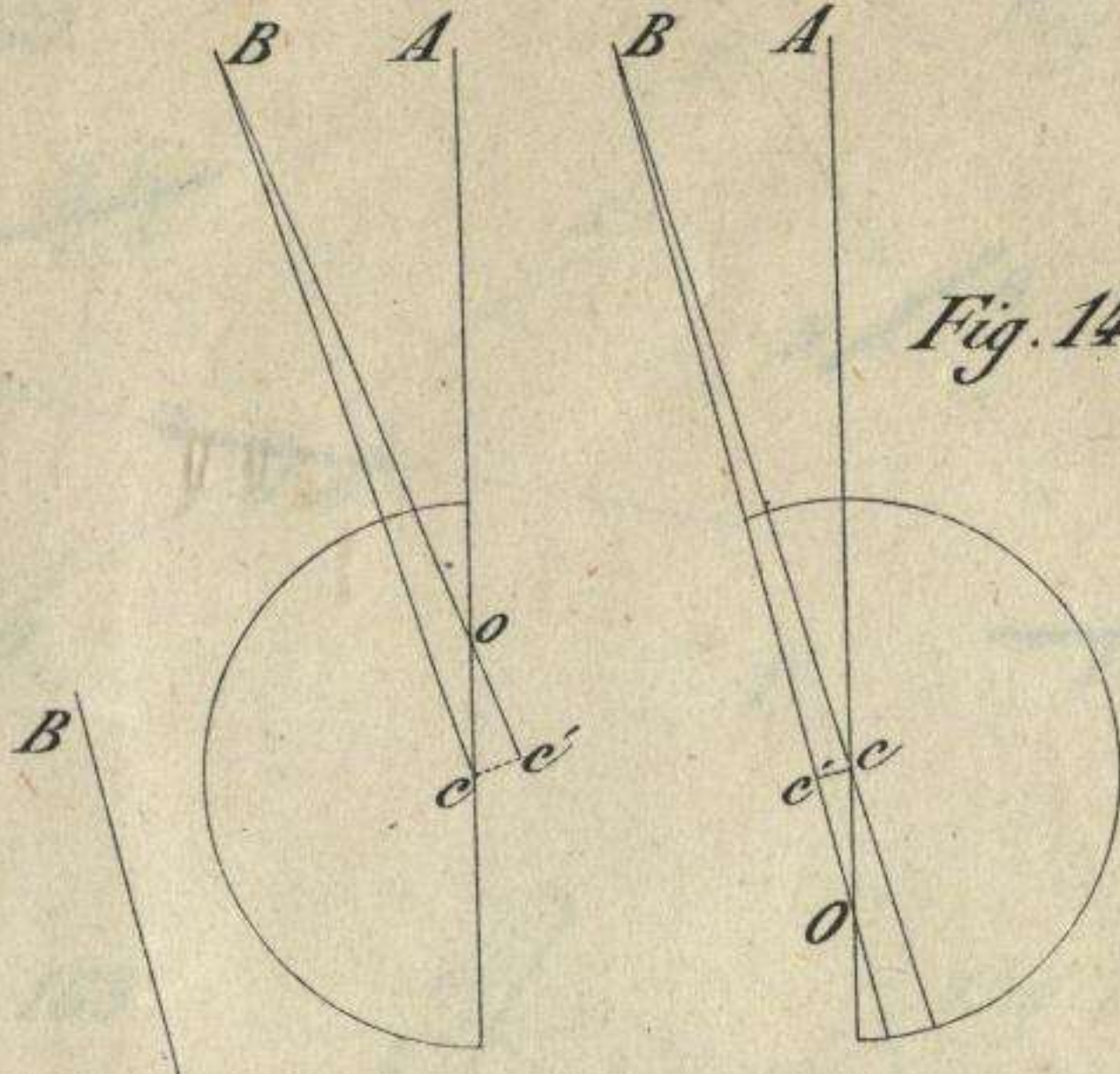

Fig. 144.

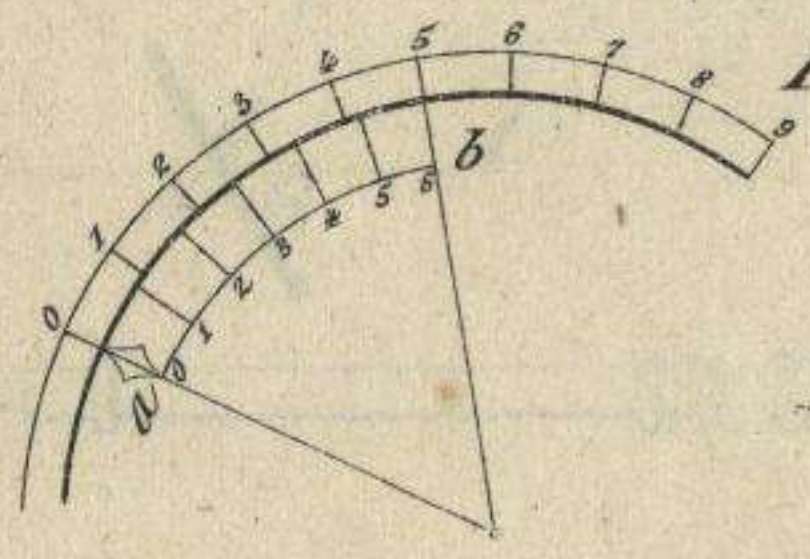

Fig. 145.

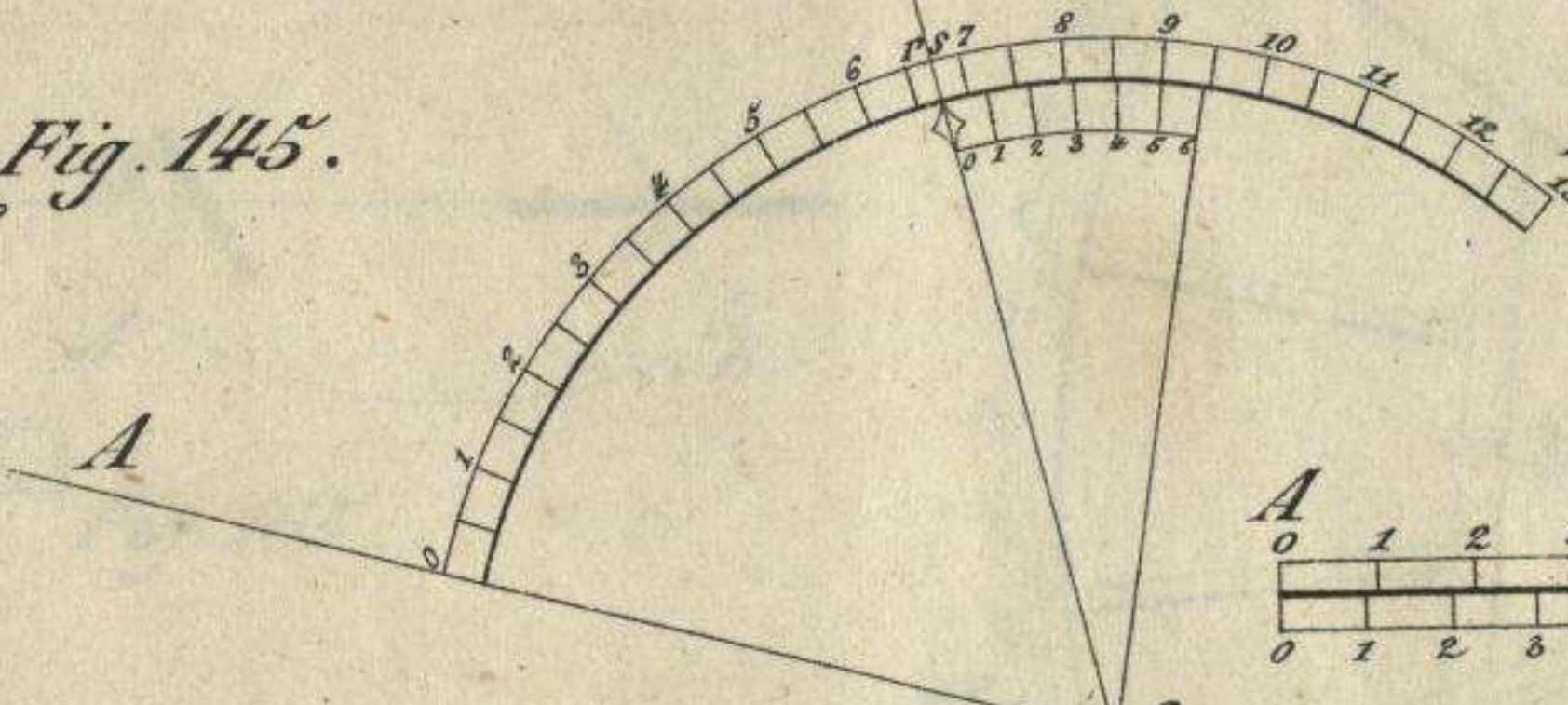

Fig. 146.



Fig. 147.

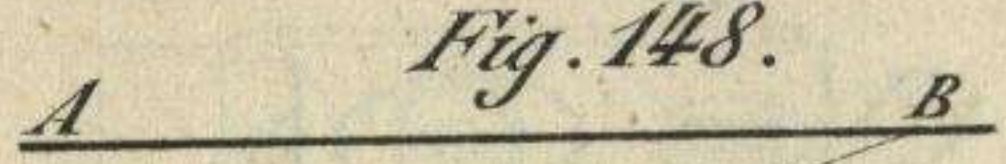

Fig. 148.

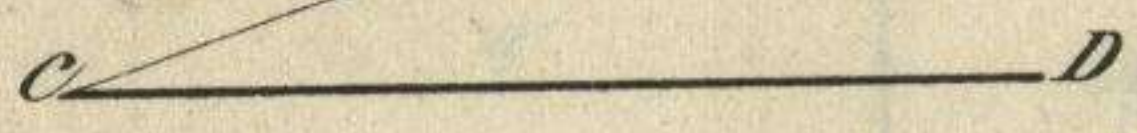

Fig. 149.

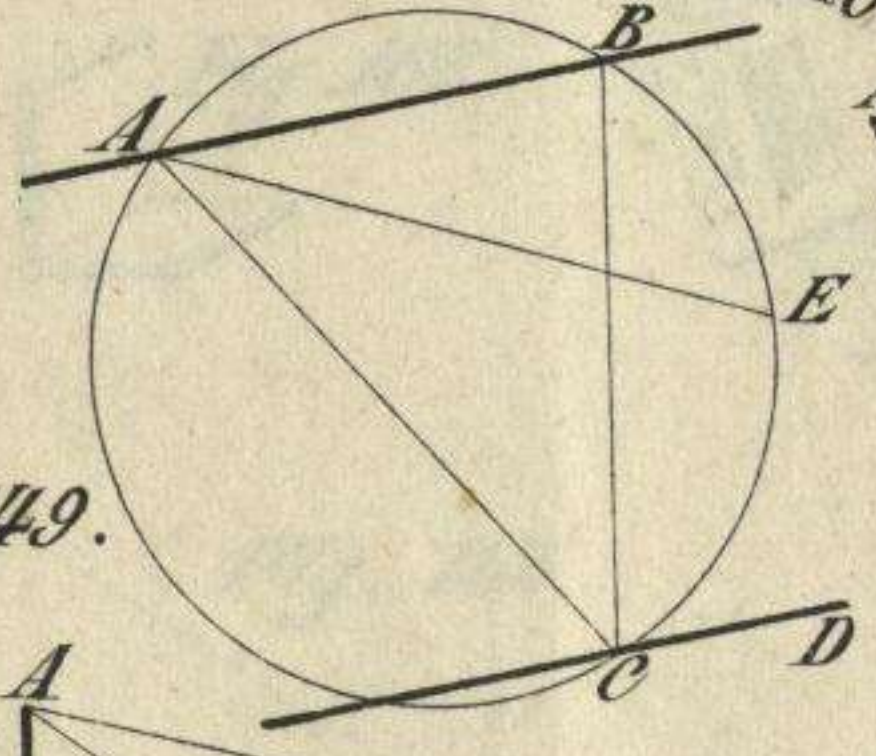

Fig. 150.

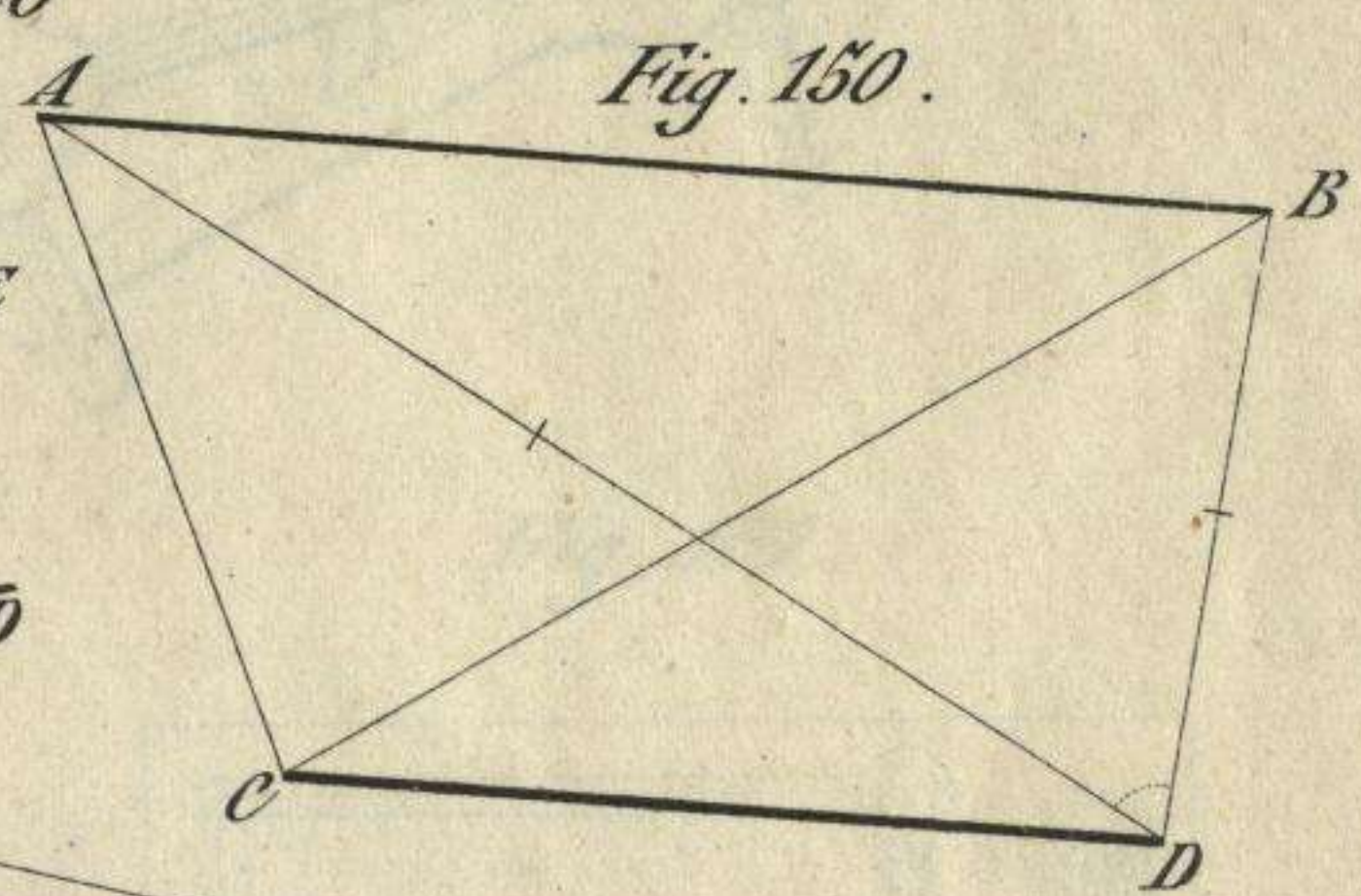

Fig. 151.

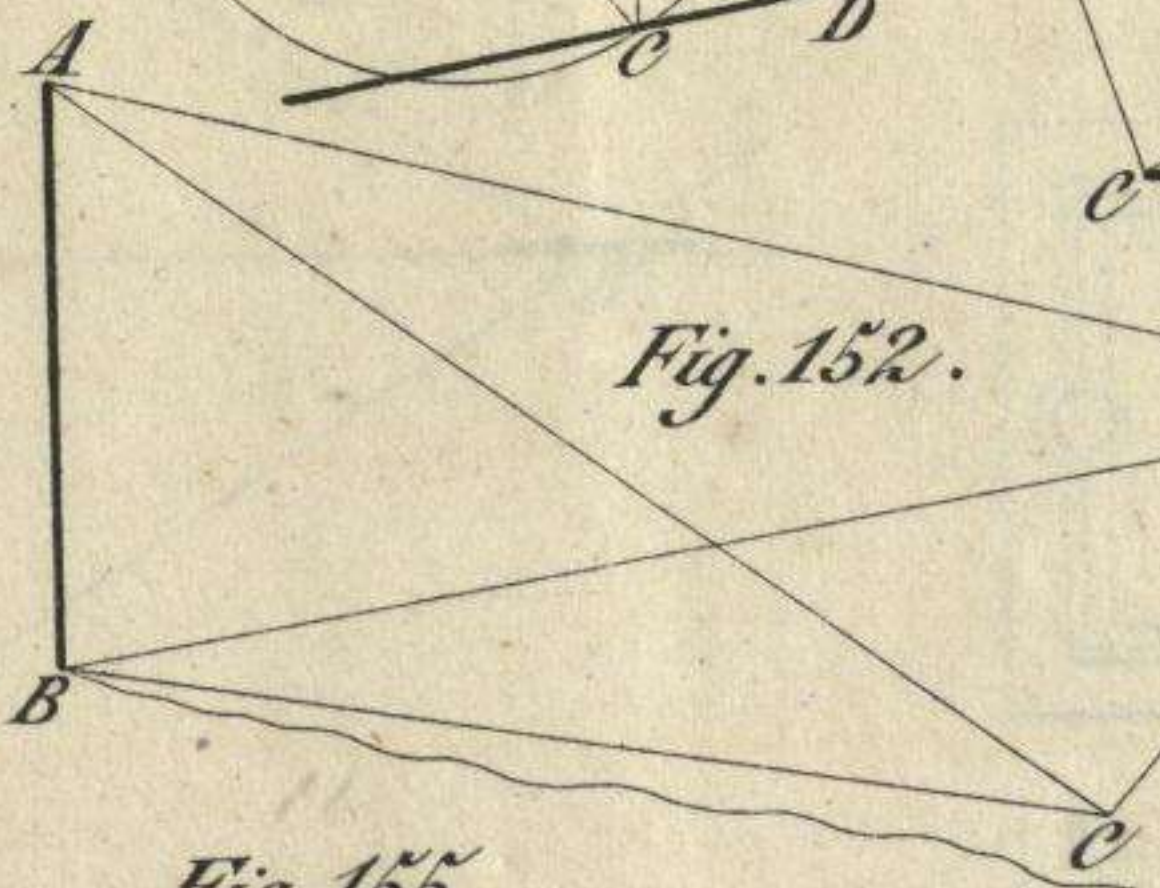

Fig. 152.

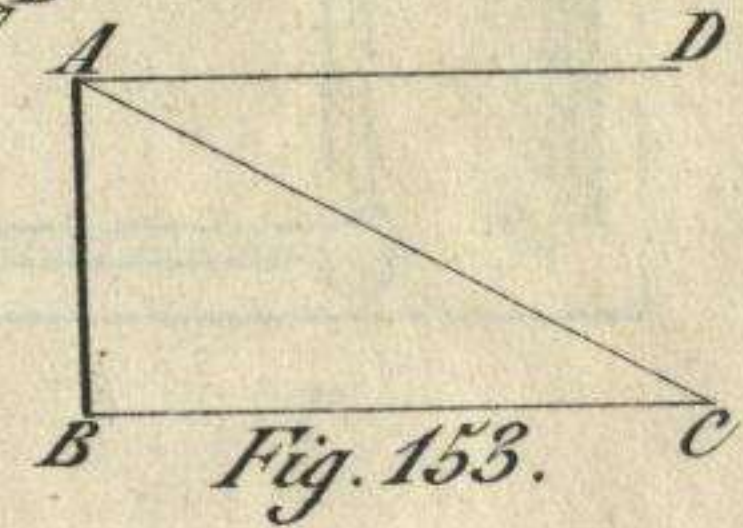

Fig. 153.

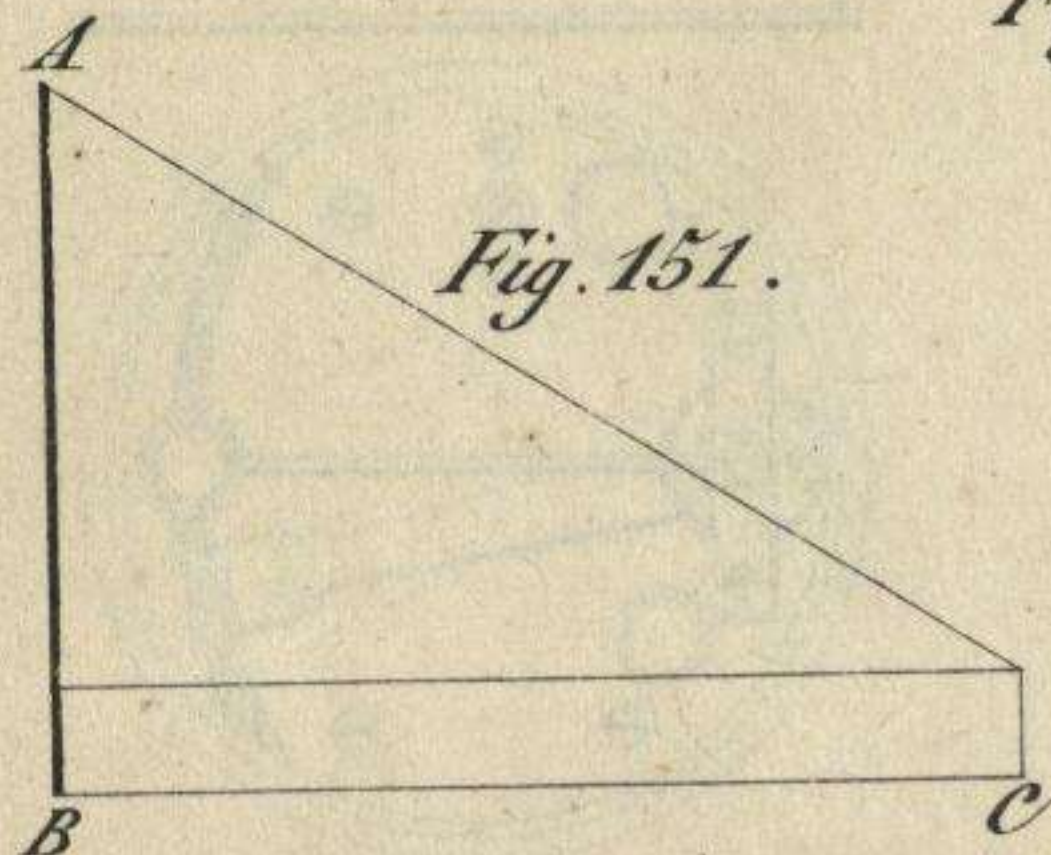

Fig. 154.

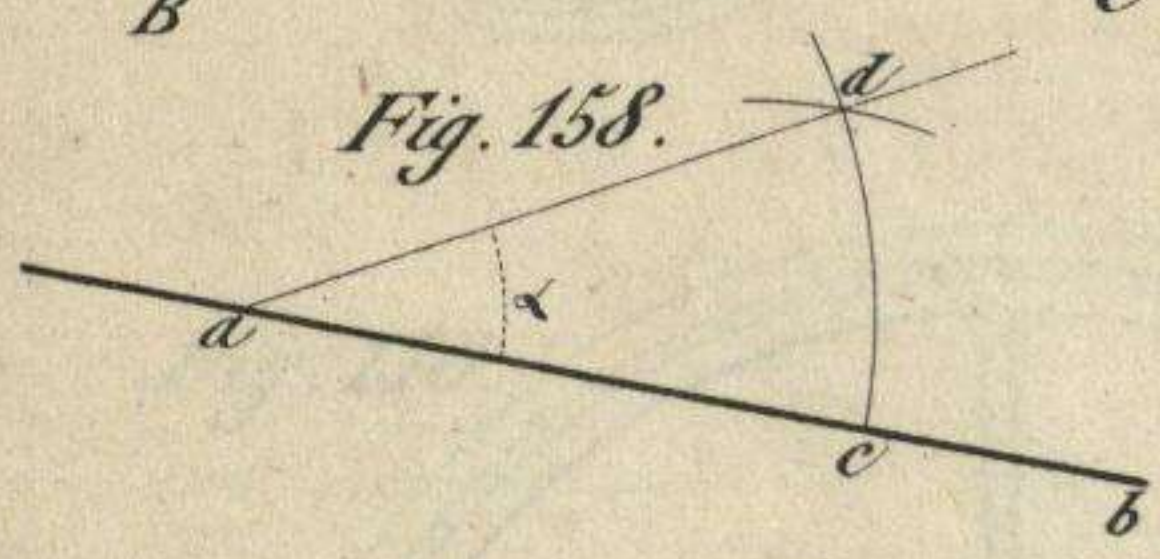

Fig. 155.

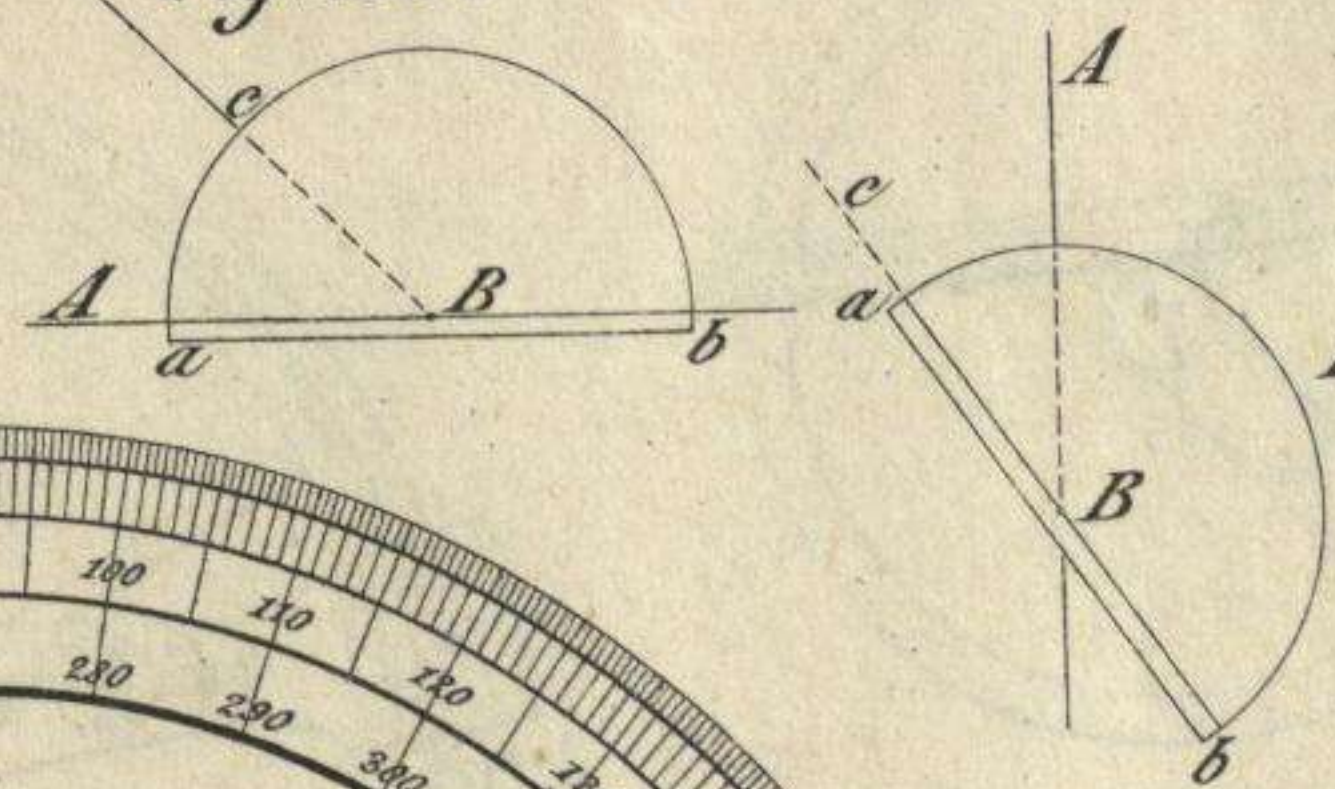

Fig. 156.

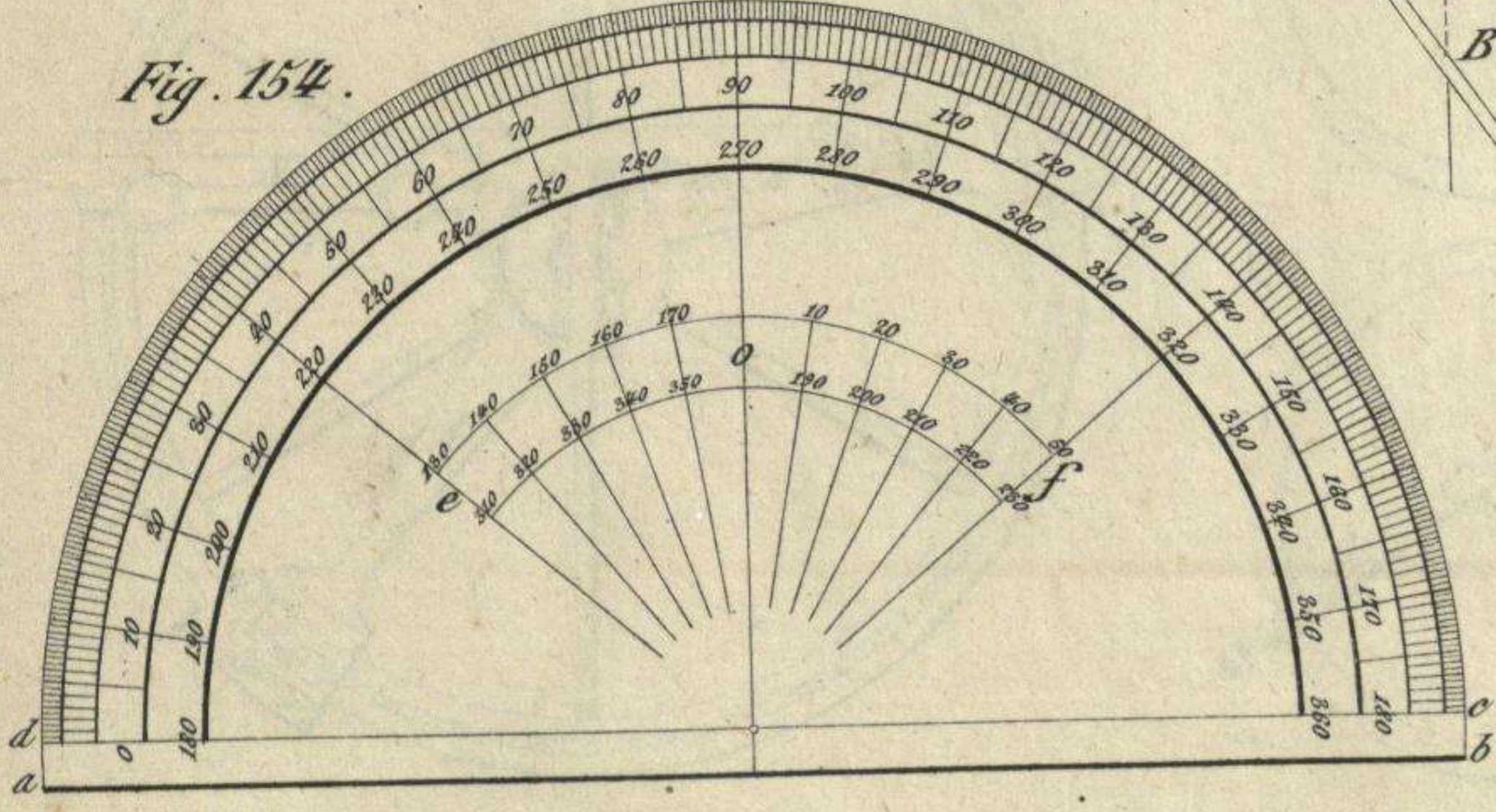

Fig. 157.

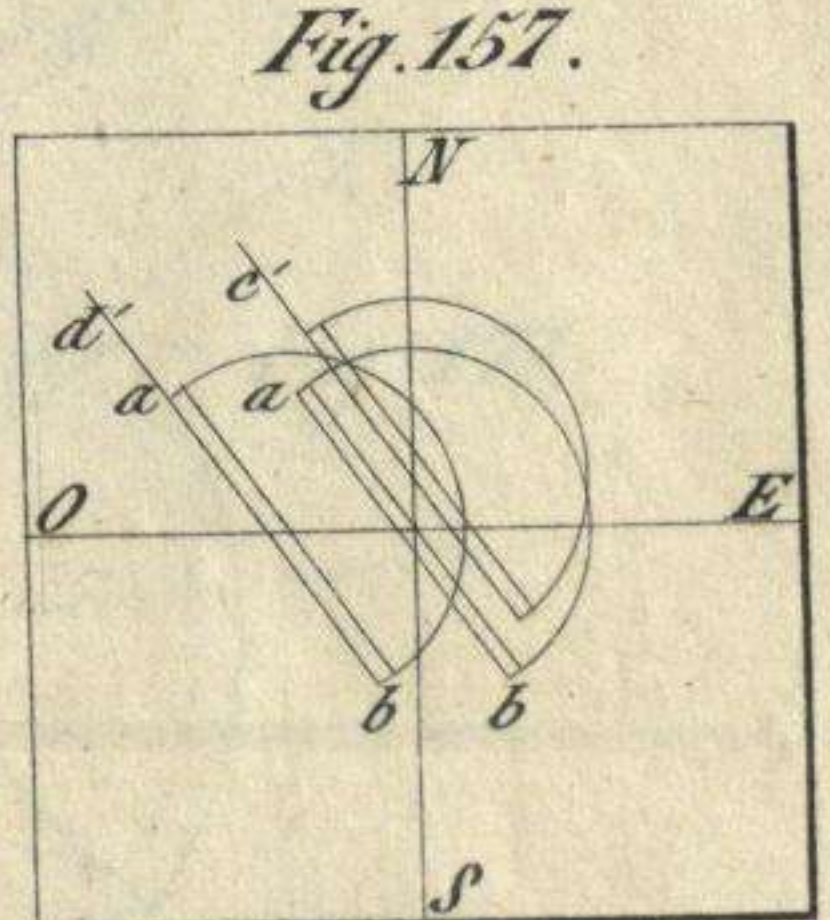

Fig. 158.

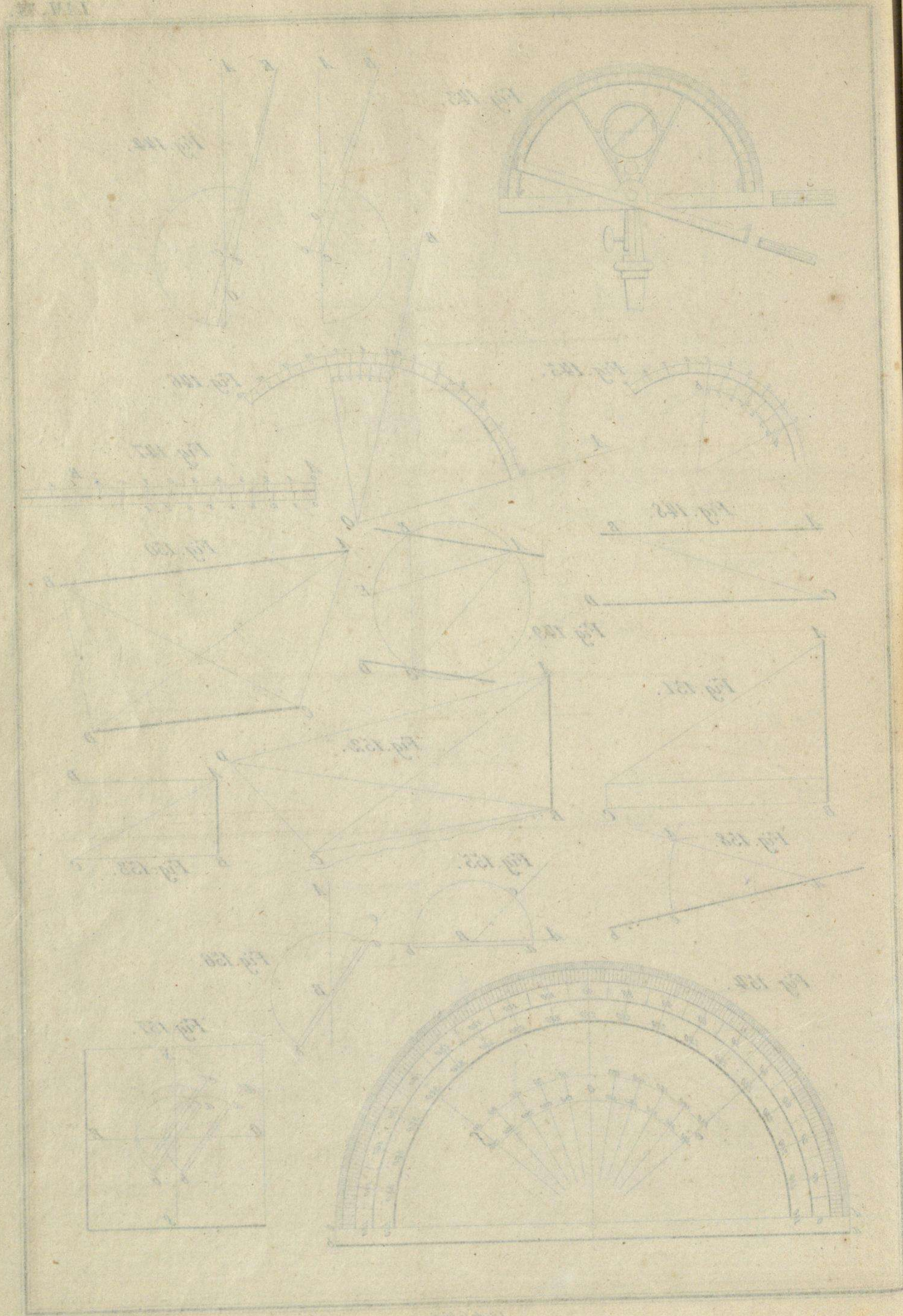

Fig. 159.

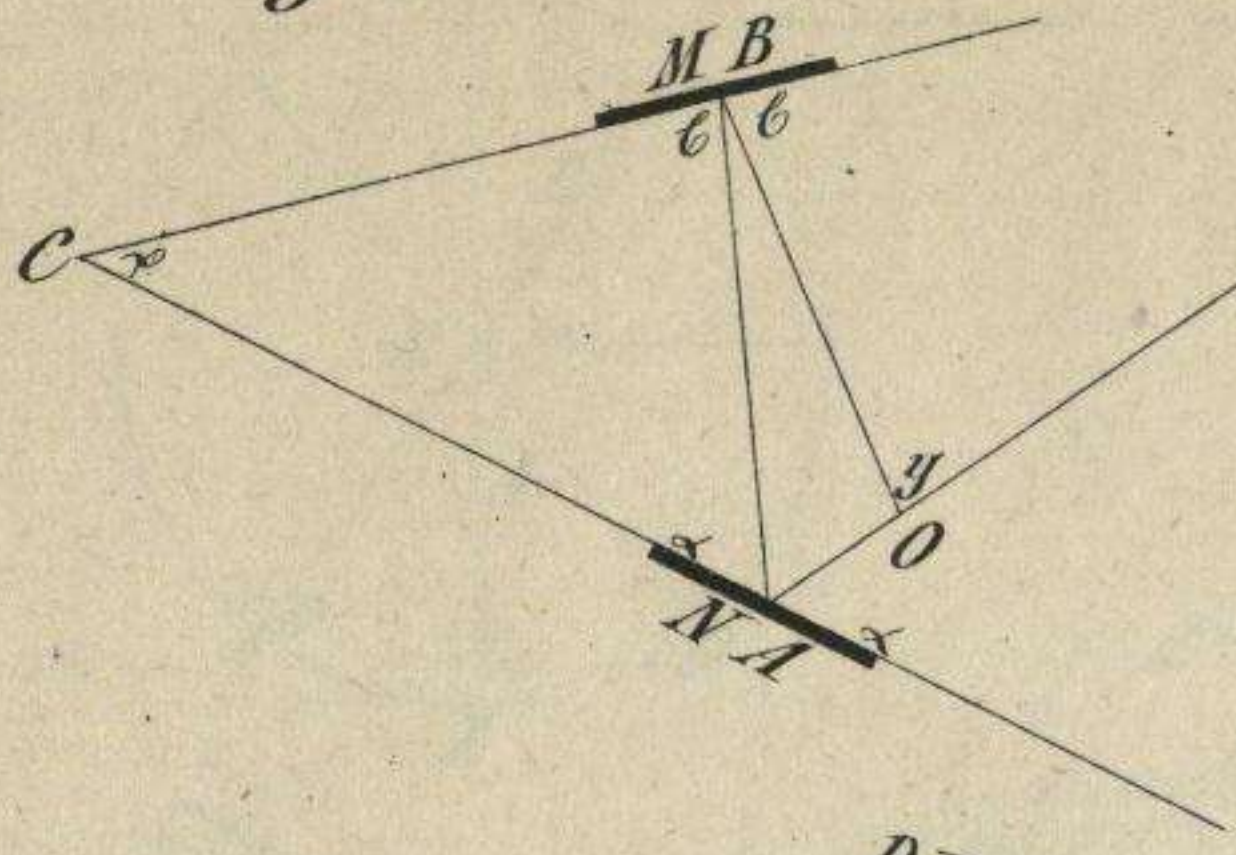

Fig. 160.

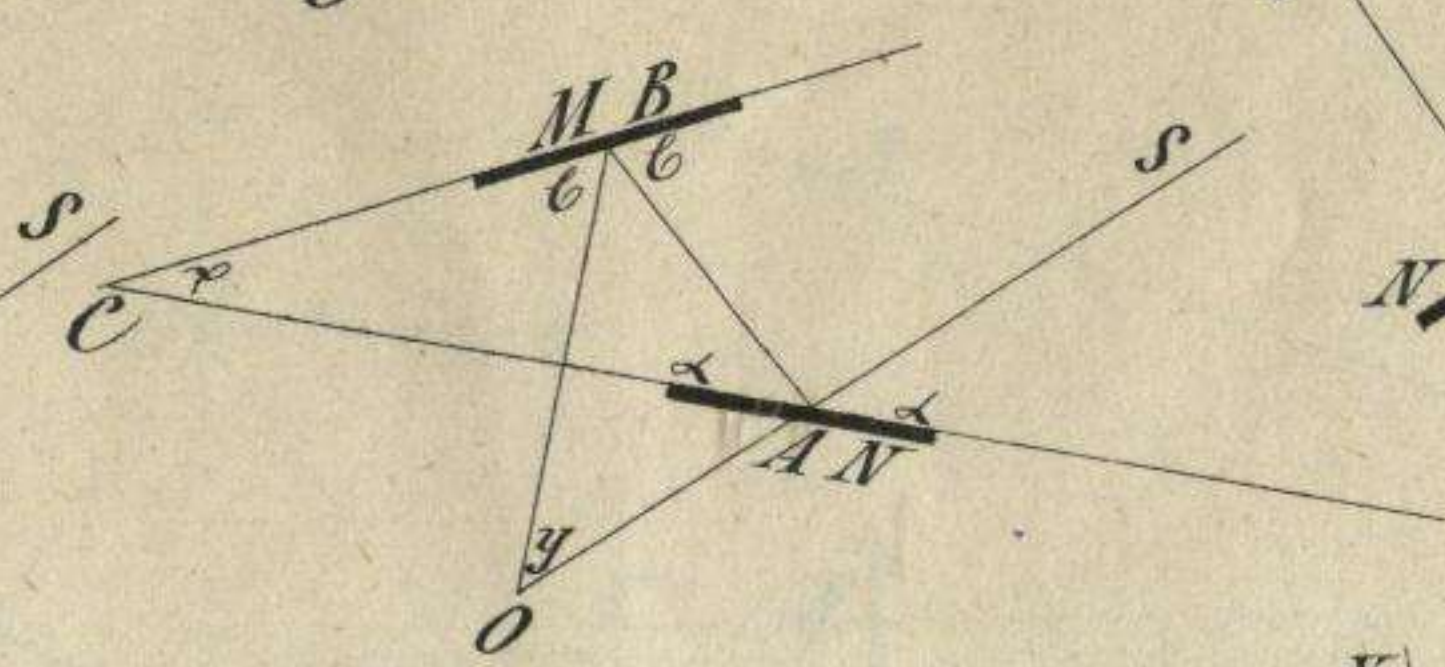

Fig. 161.

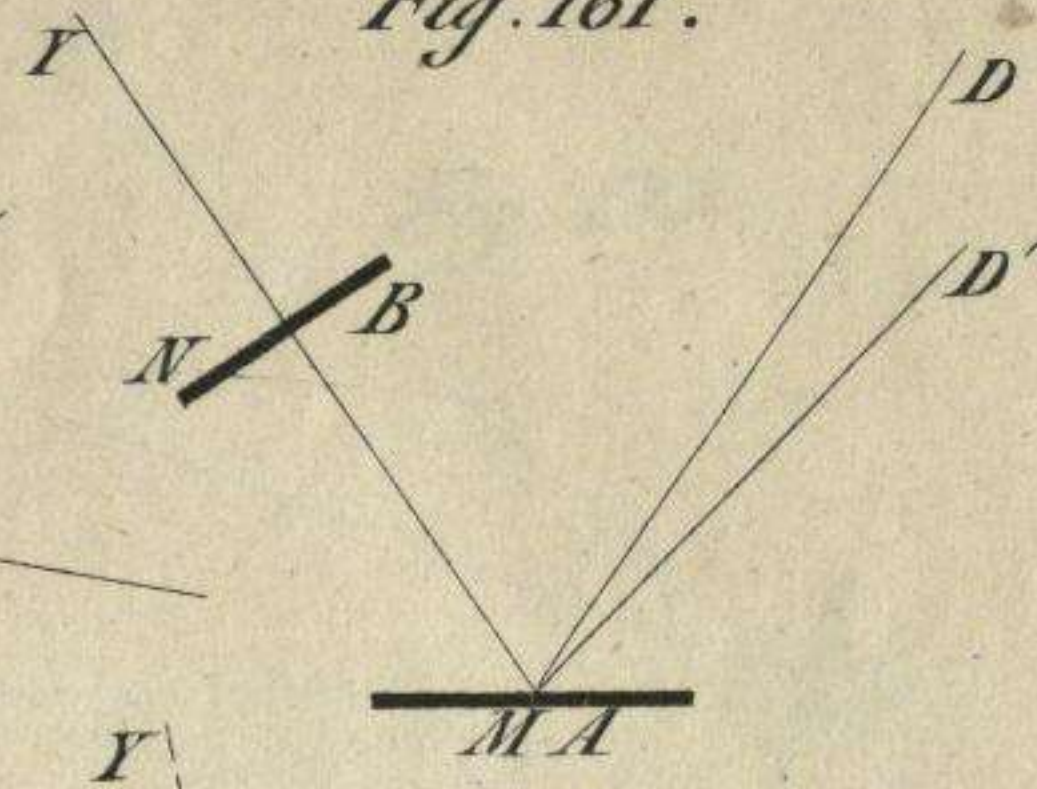

Fig. 162.

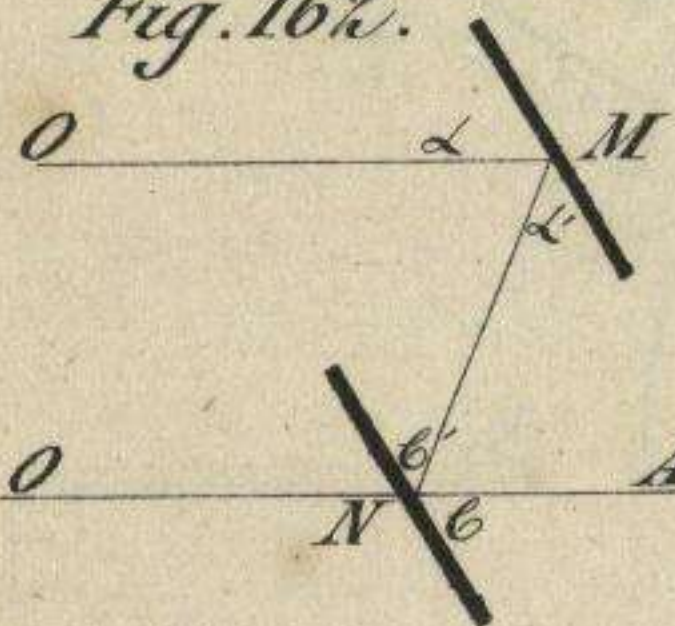

Fig. 163.

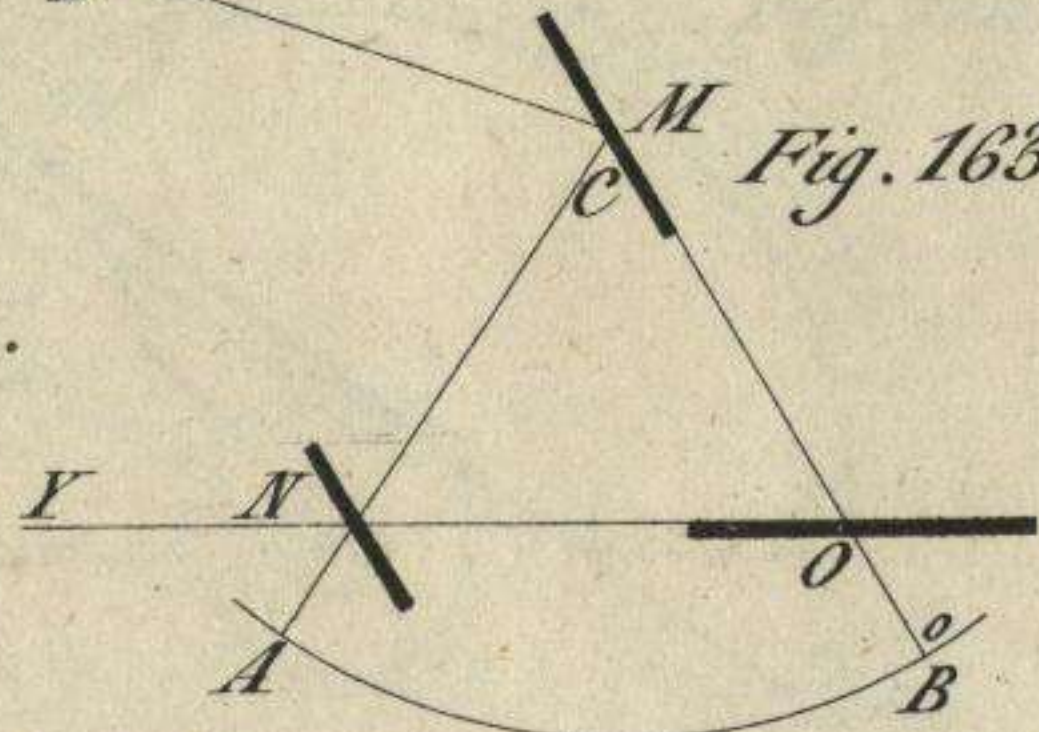

Fig. 165.

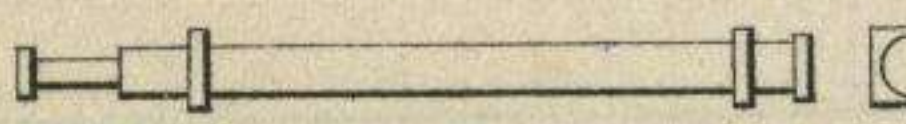

Fig. 164.

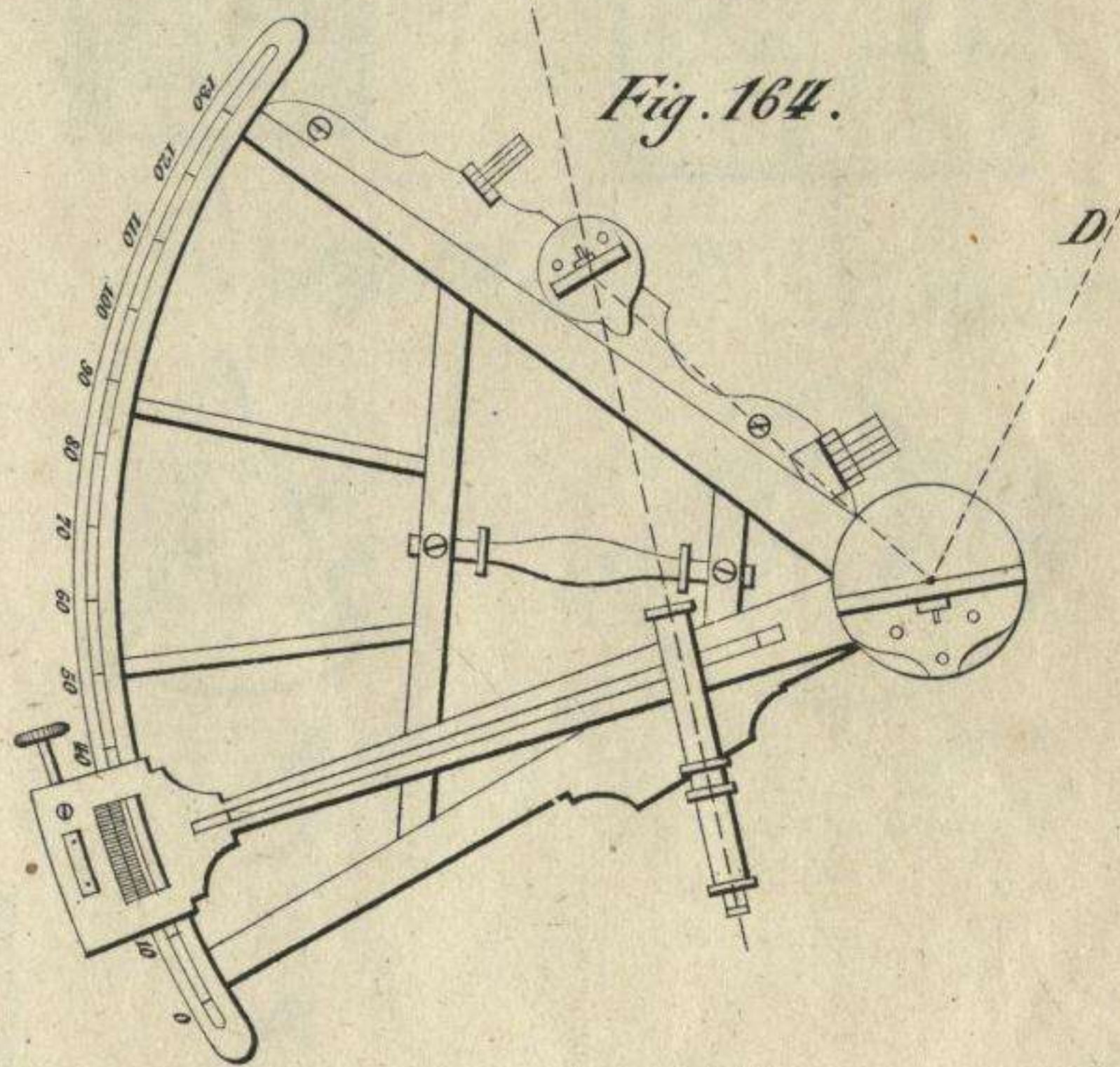

Fig. 169.

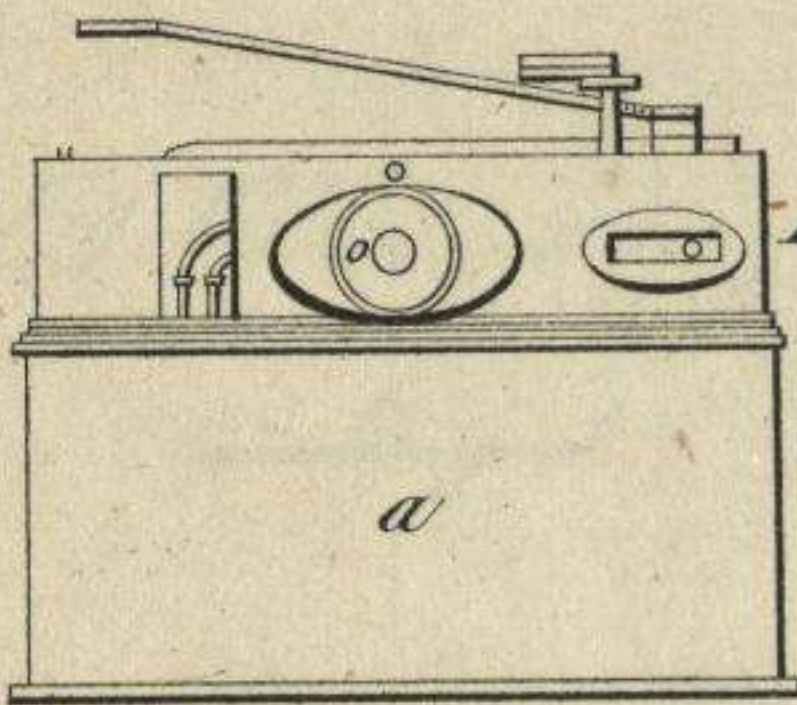

Fig. 168.

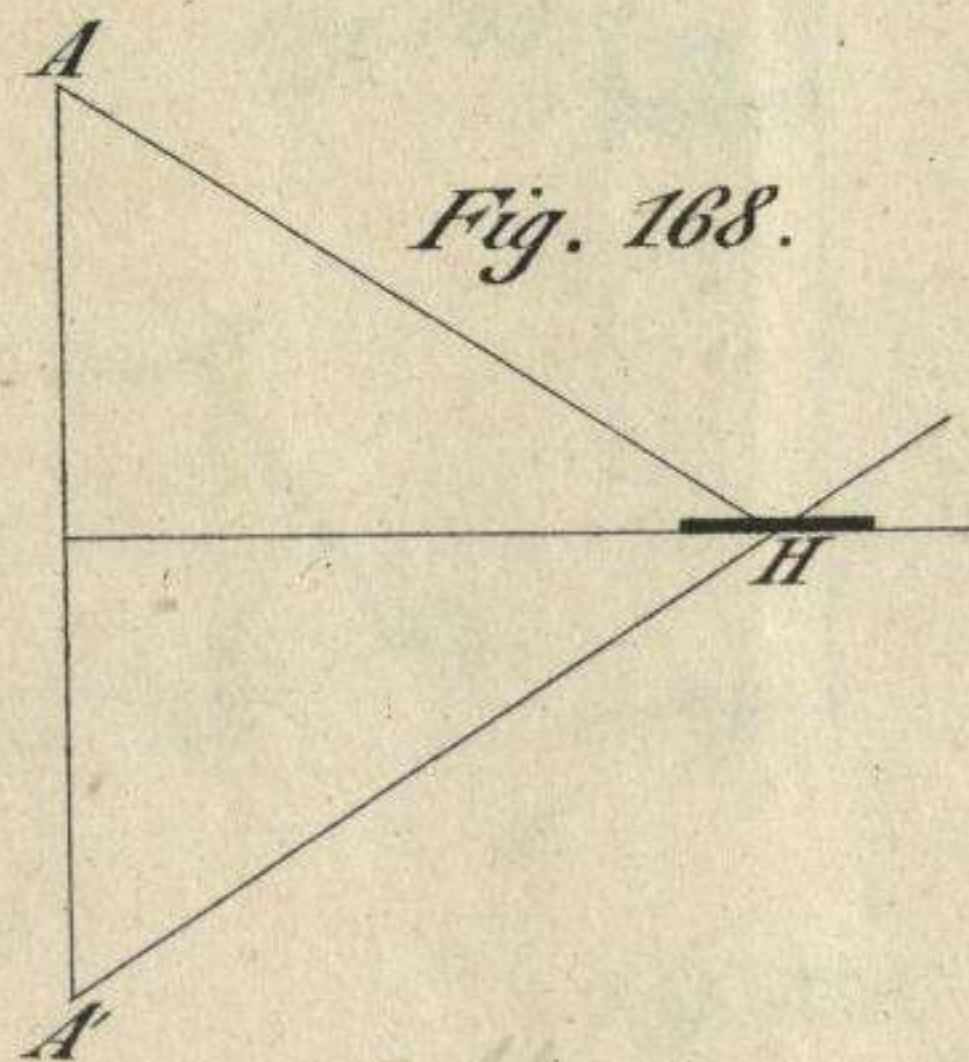

Fig. 167.

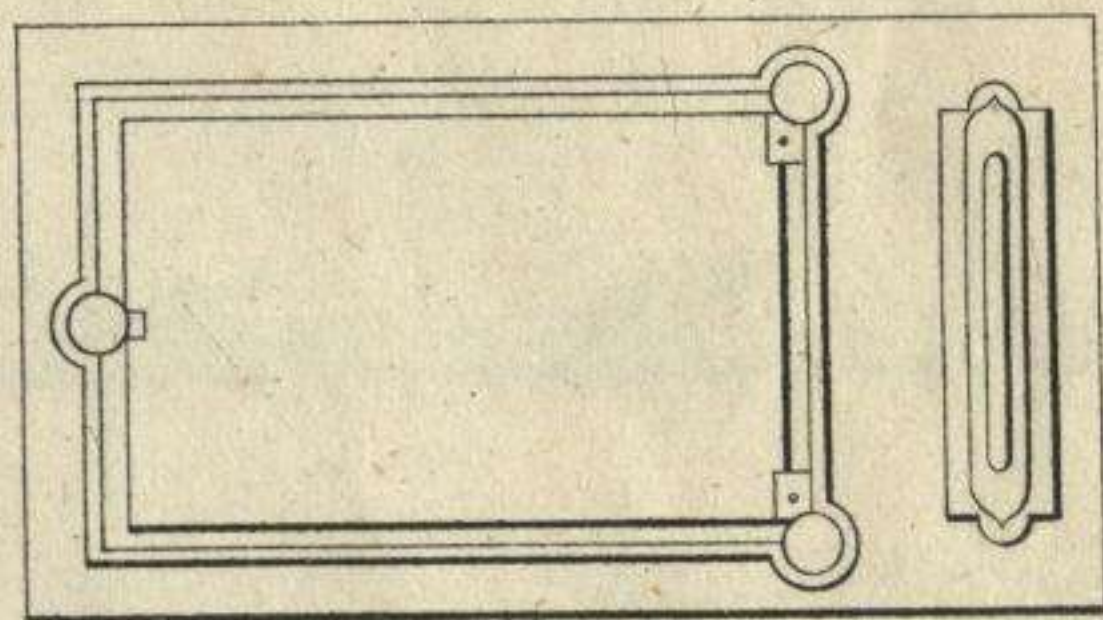

Fig. 170.

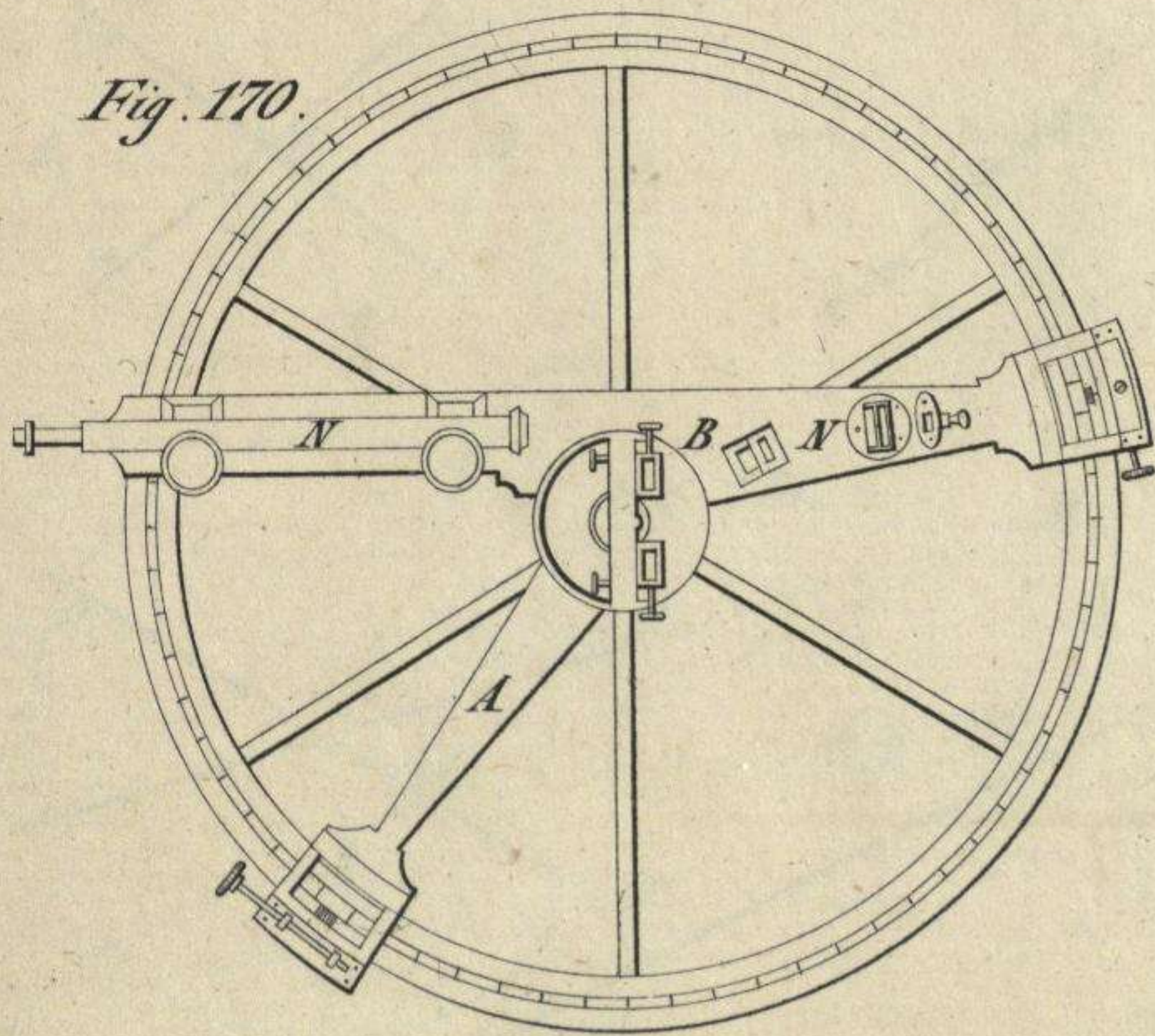

Fig. 172.

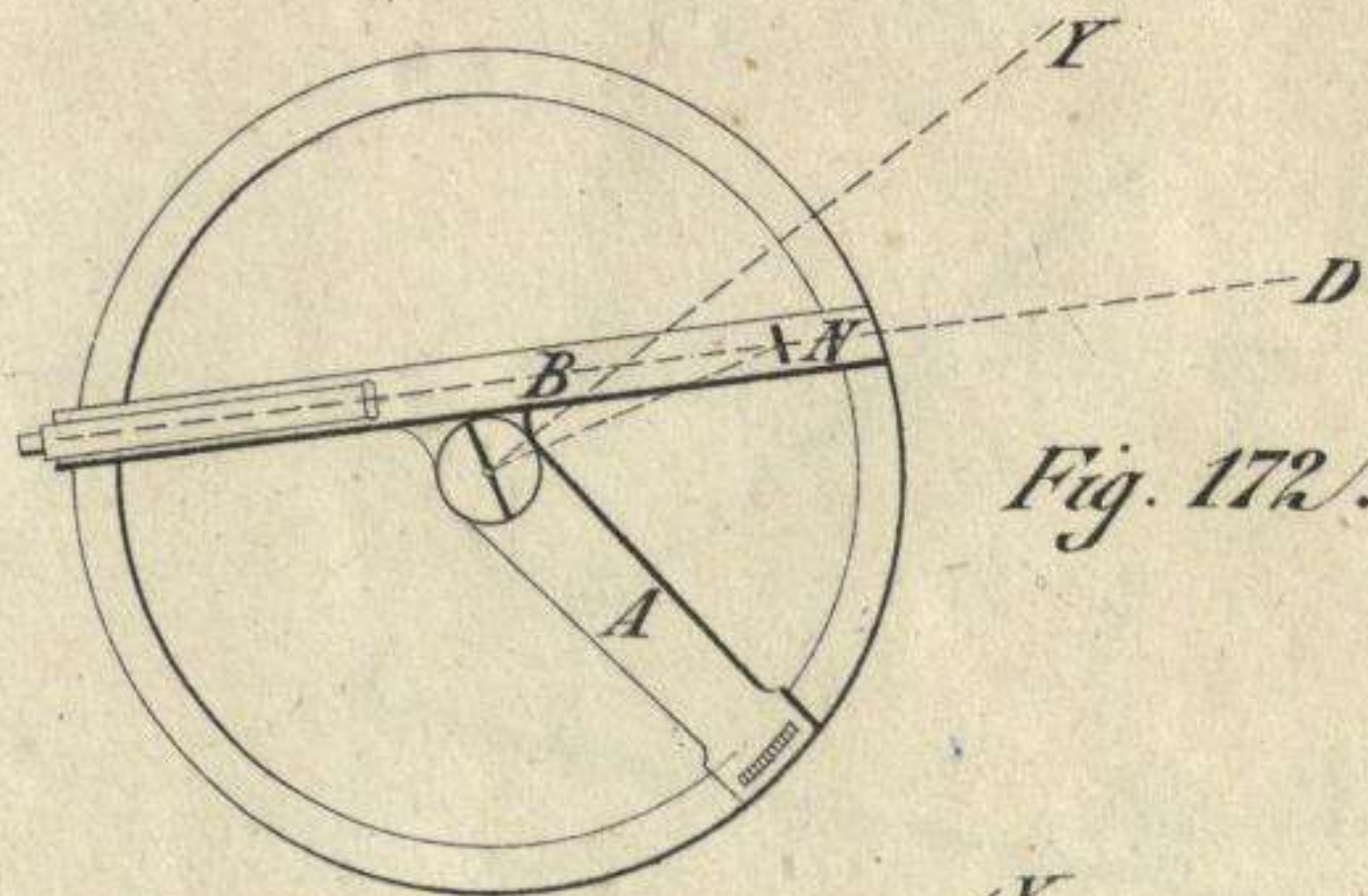
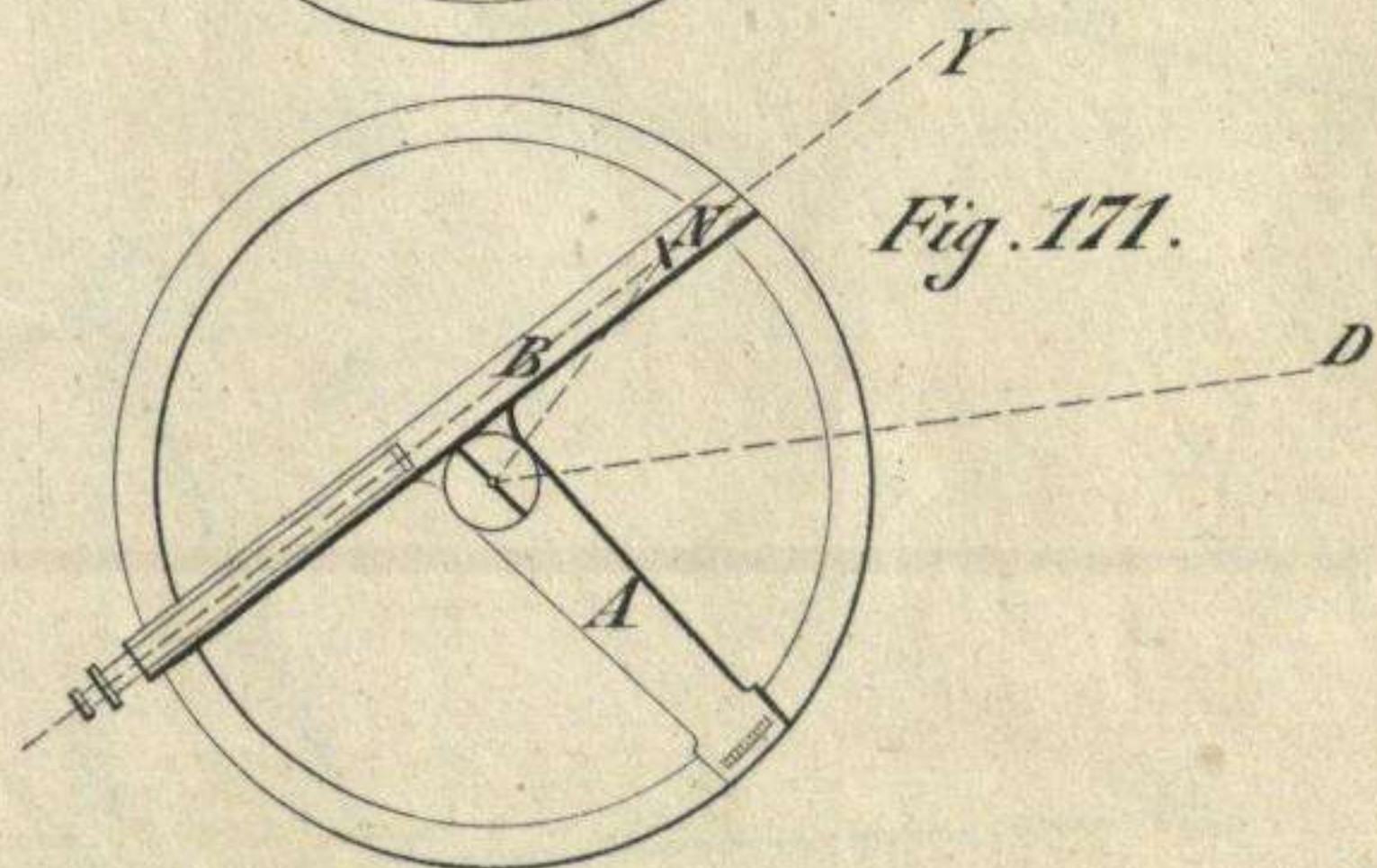
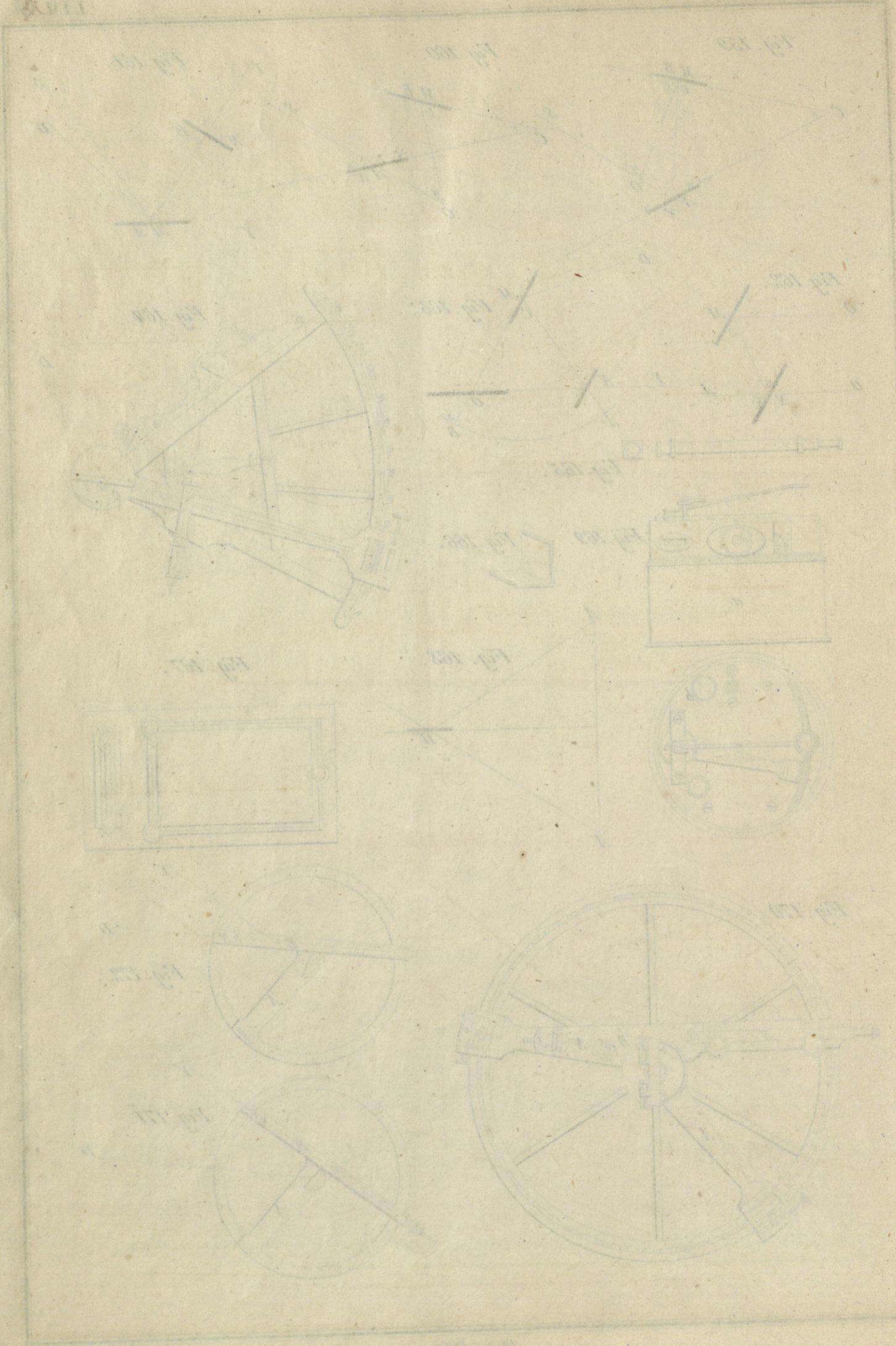
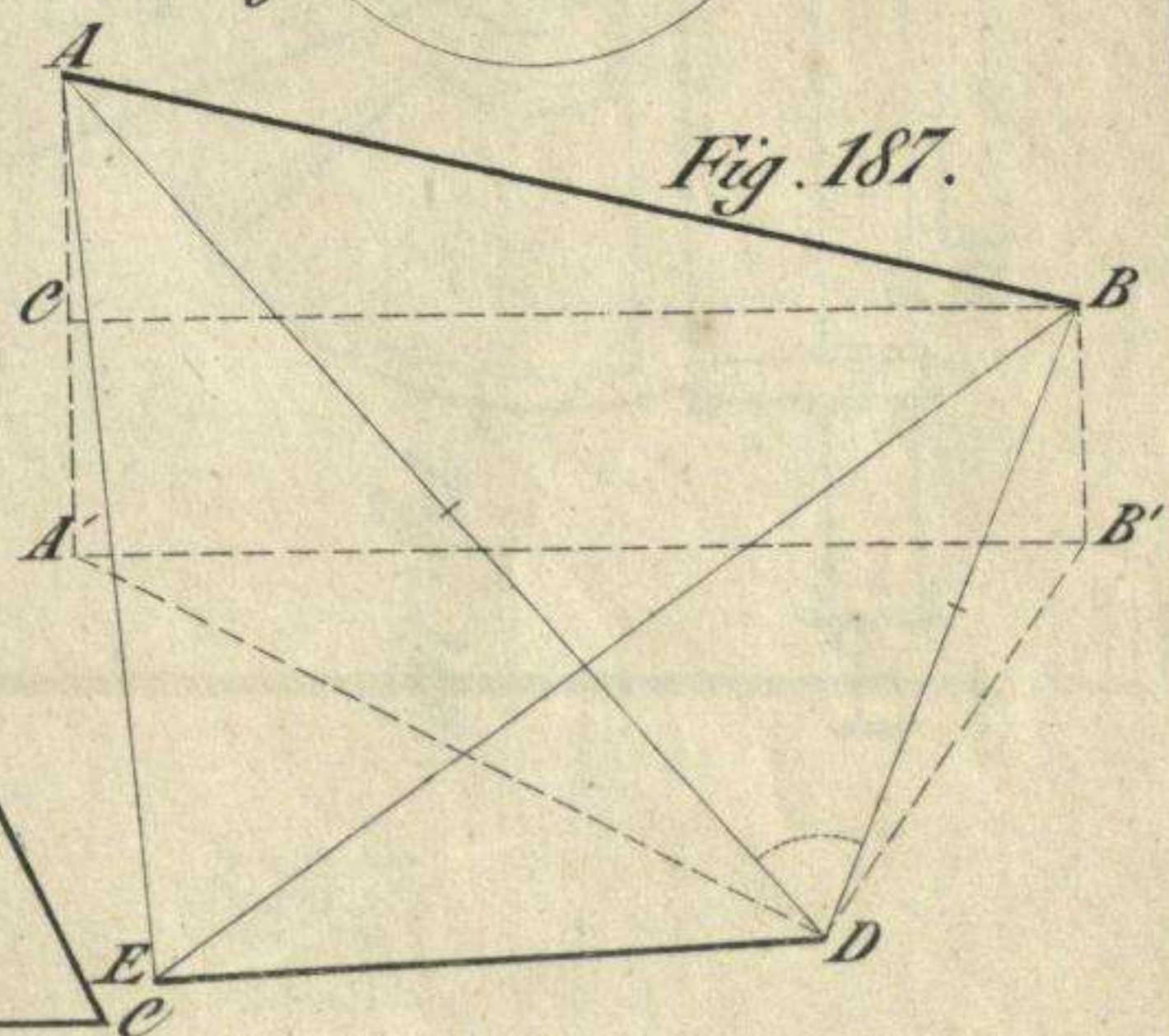
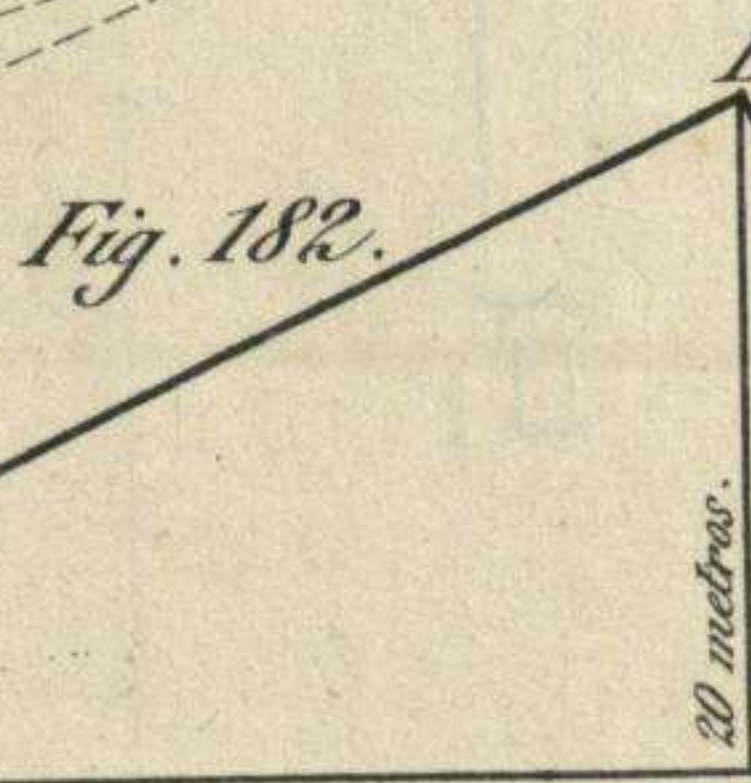
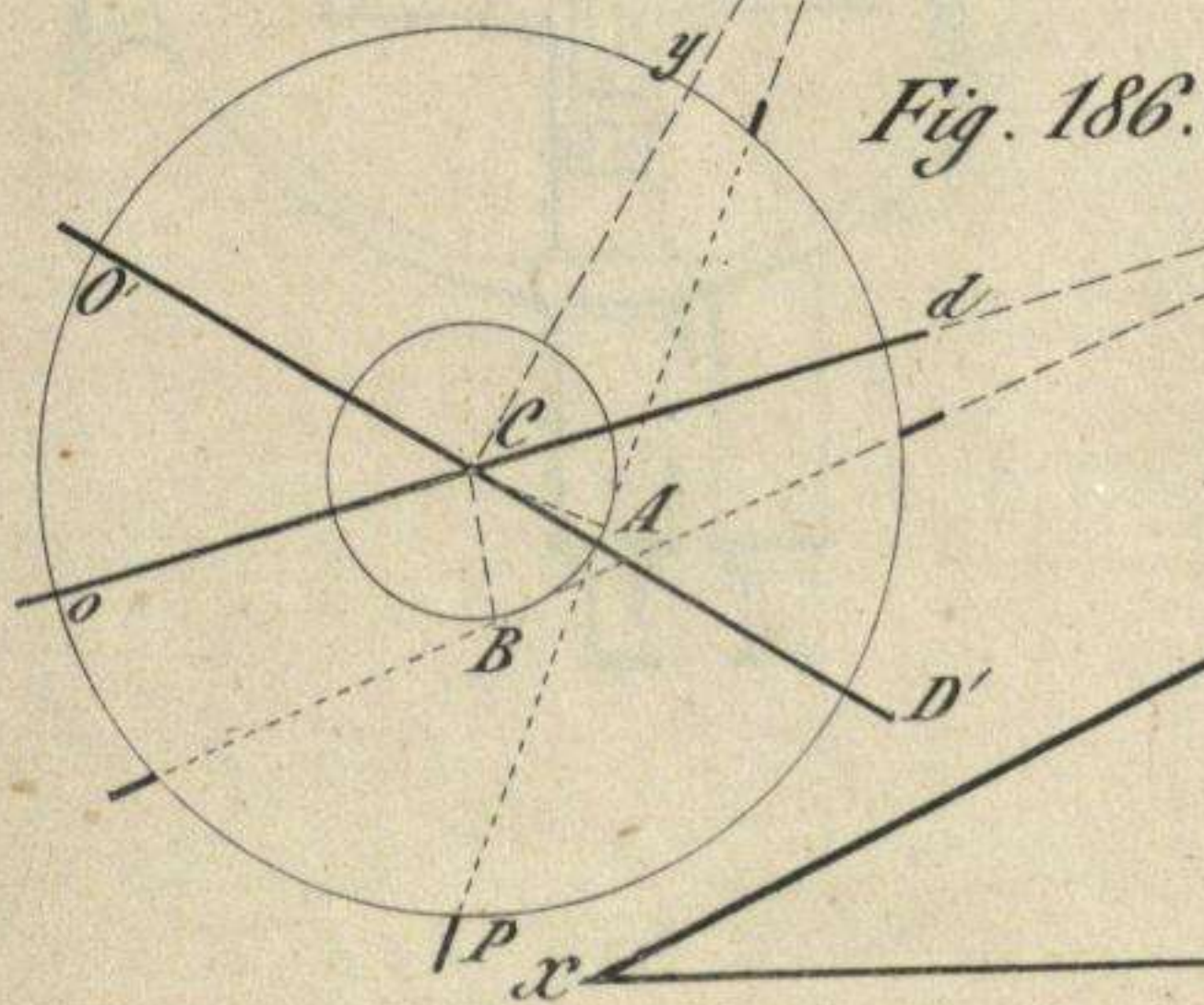
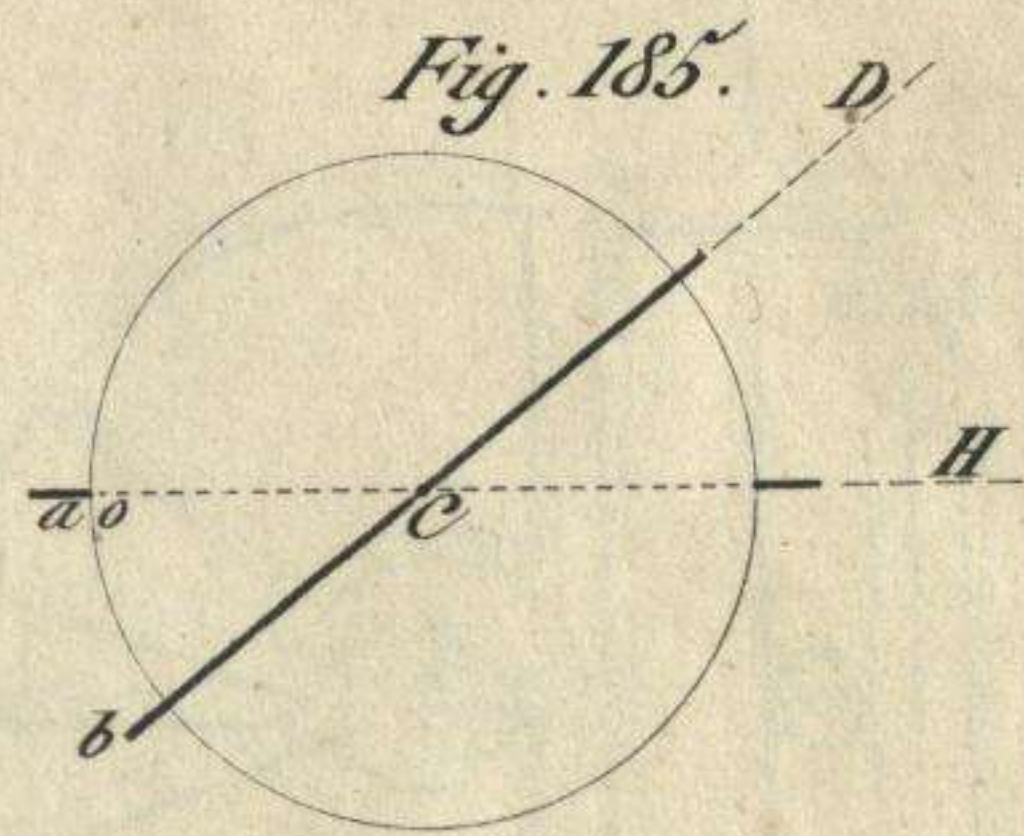
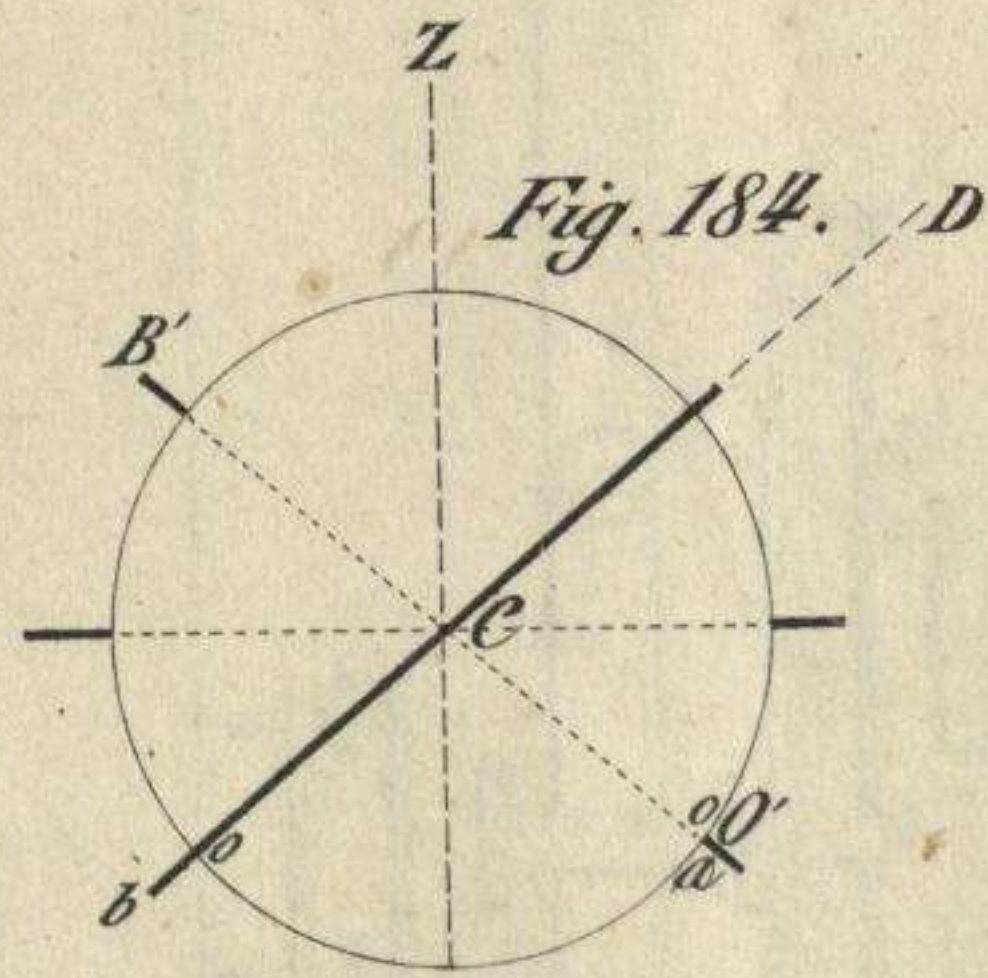
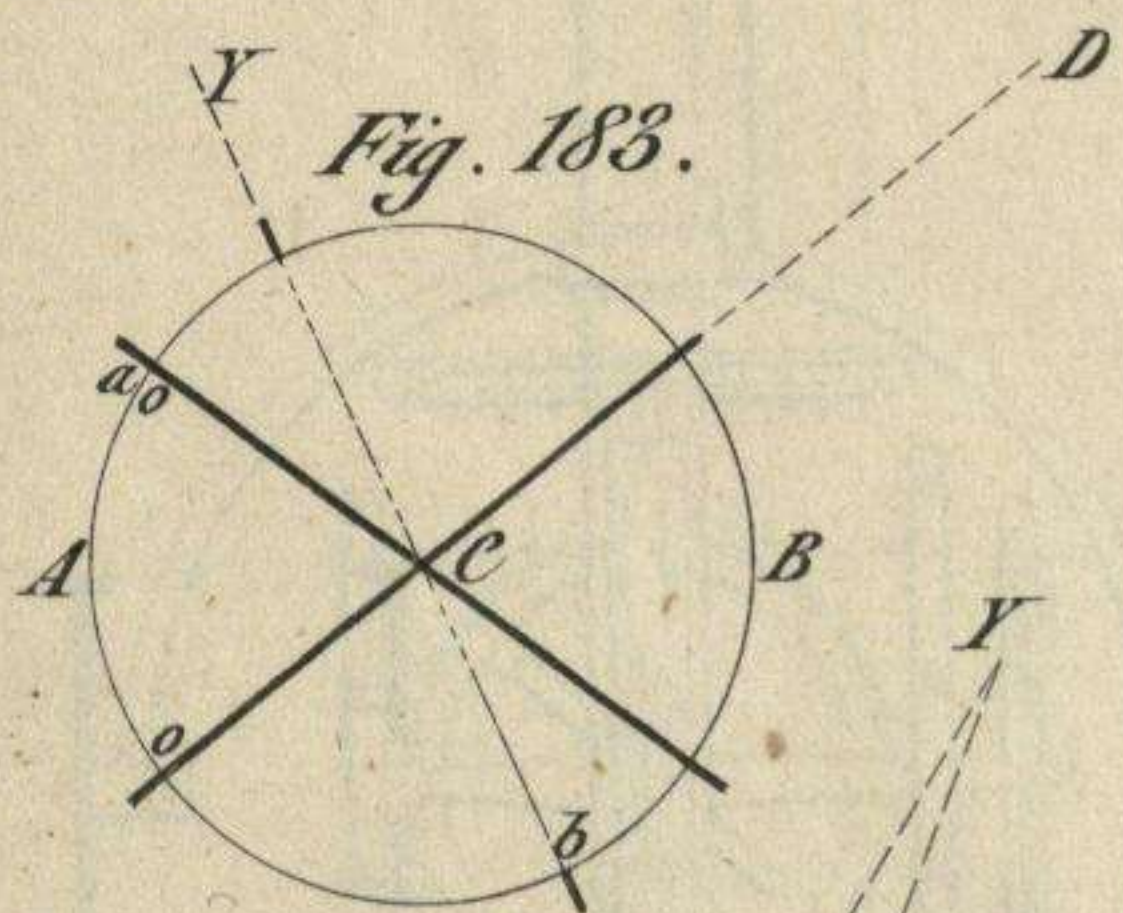
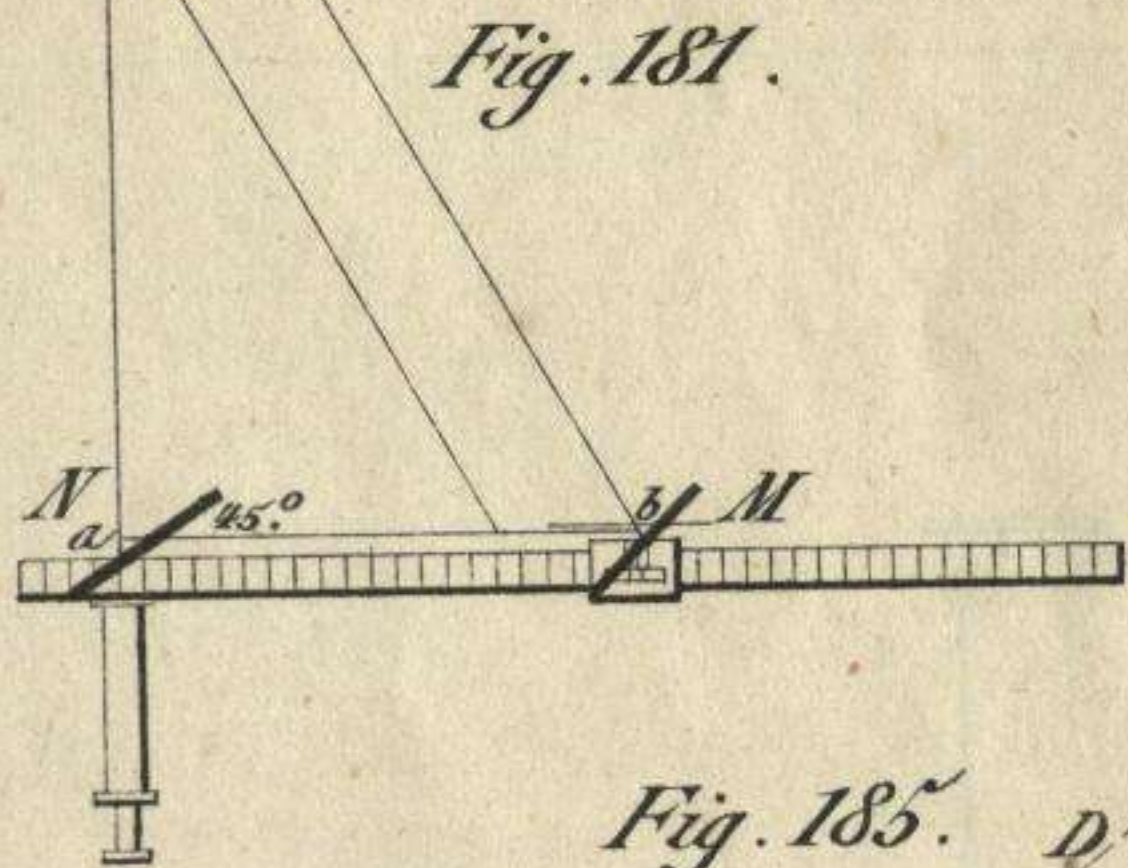
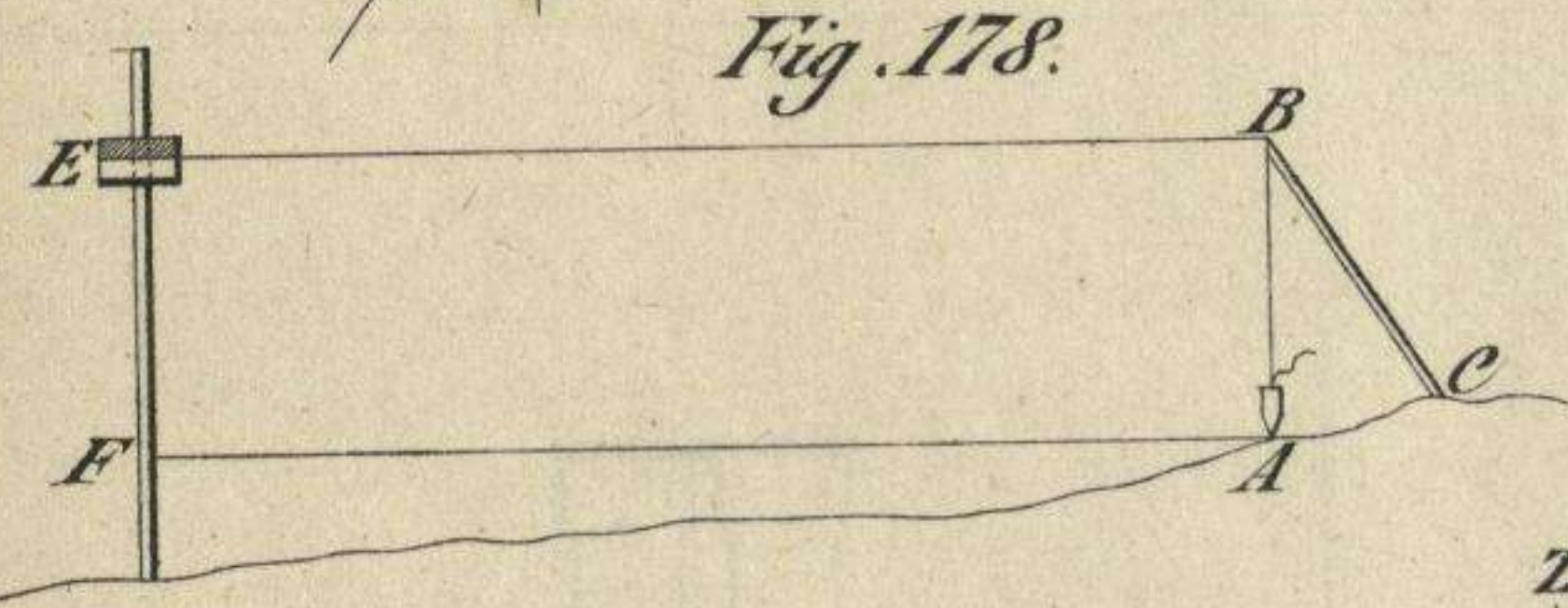
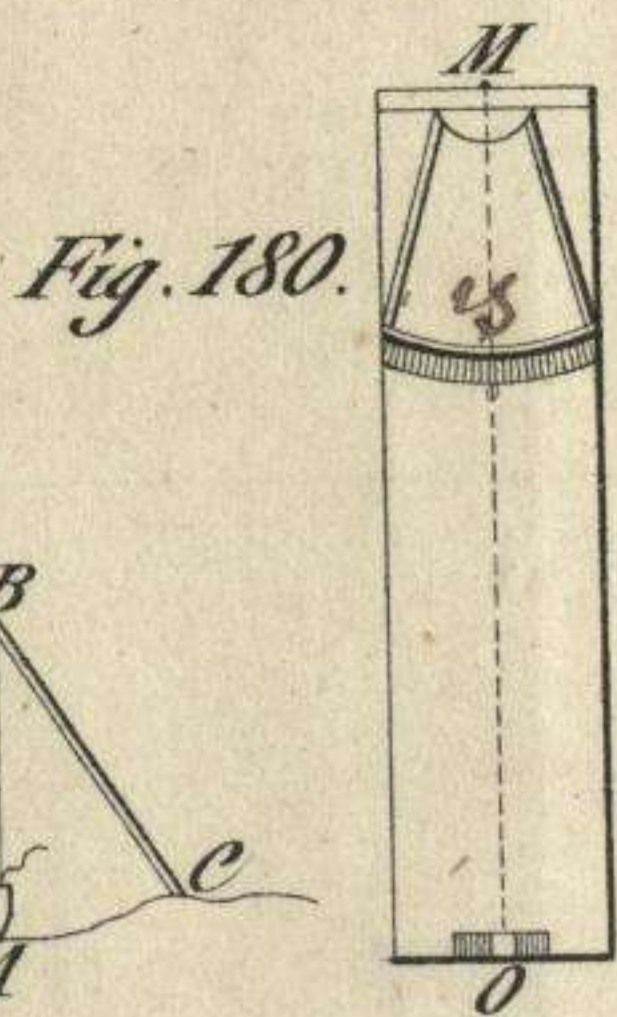
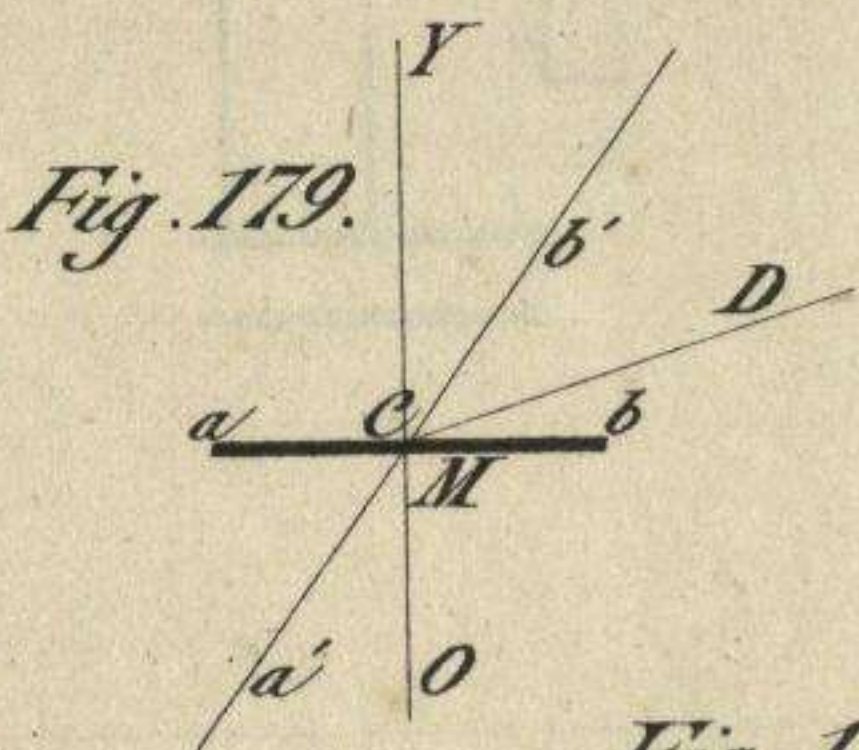
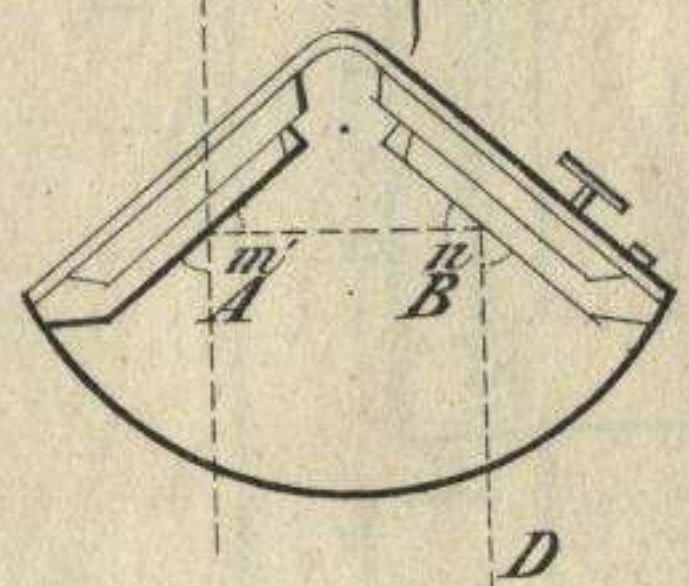
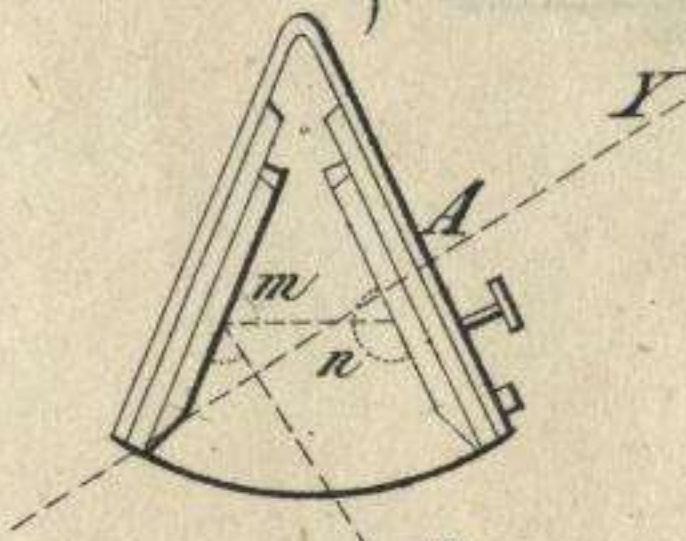
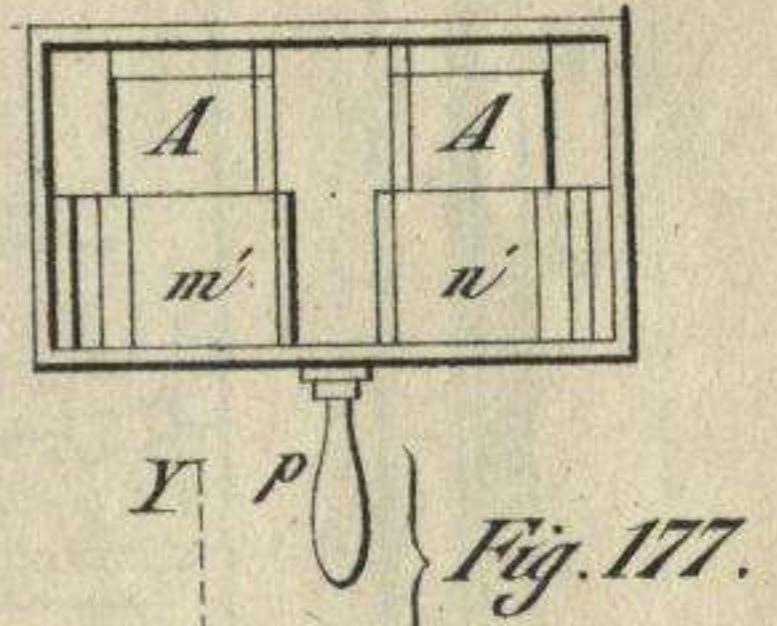
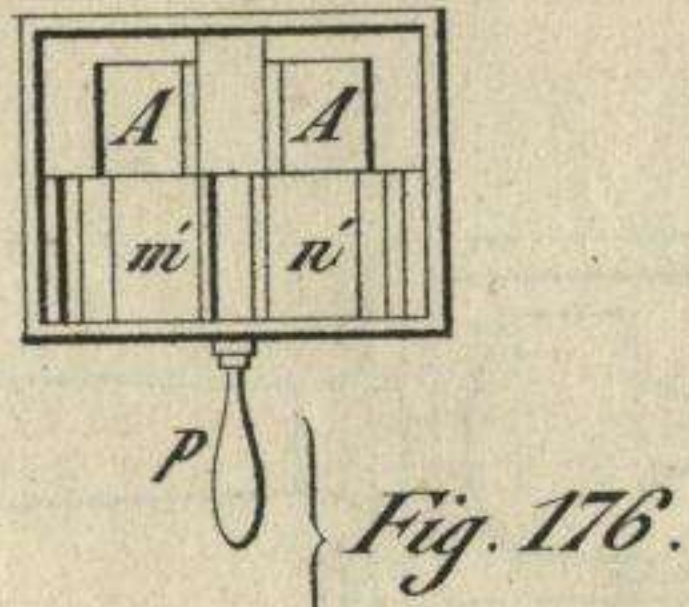
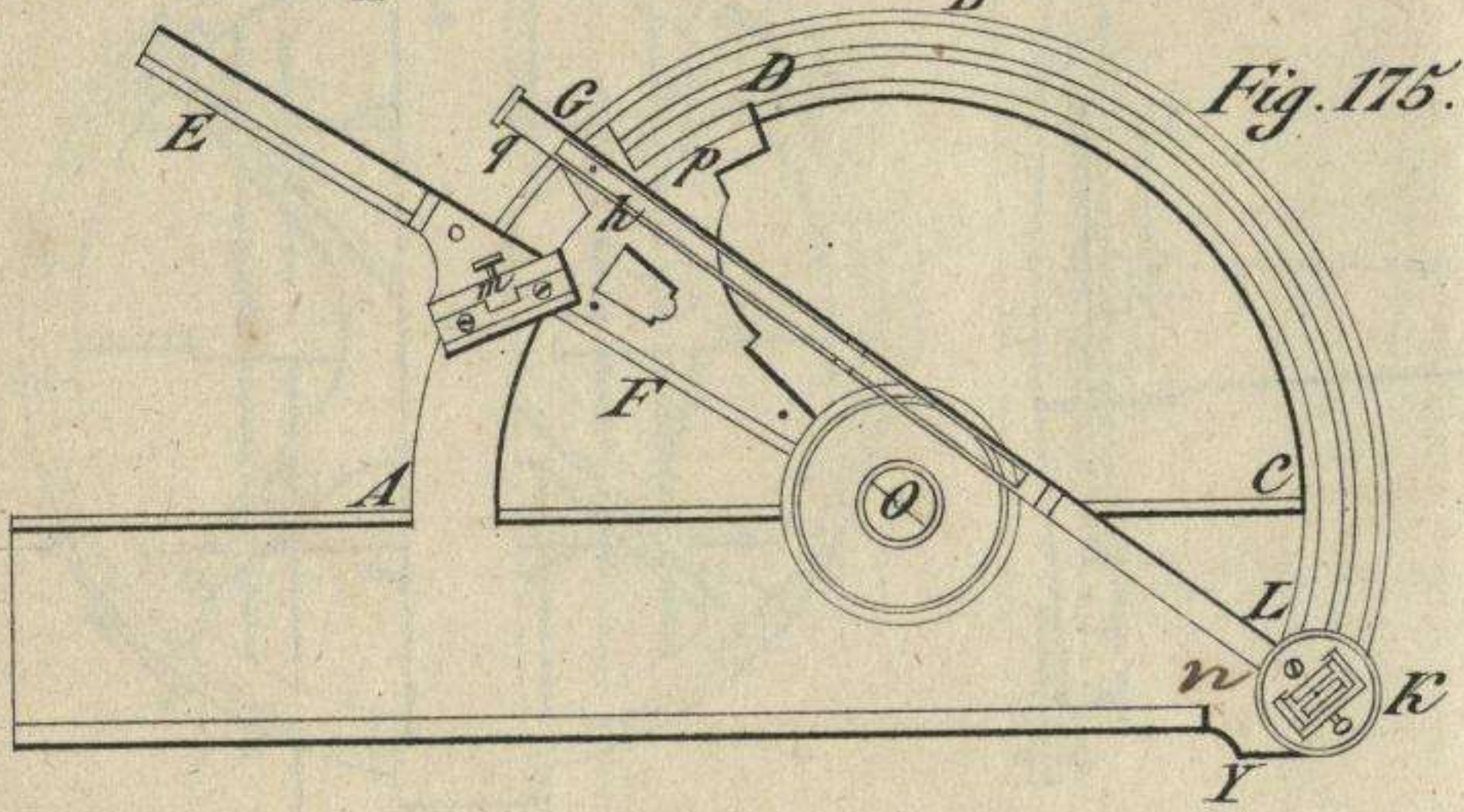
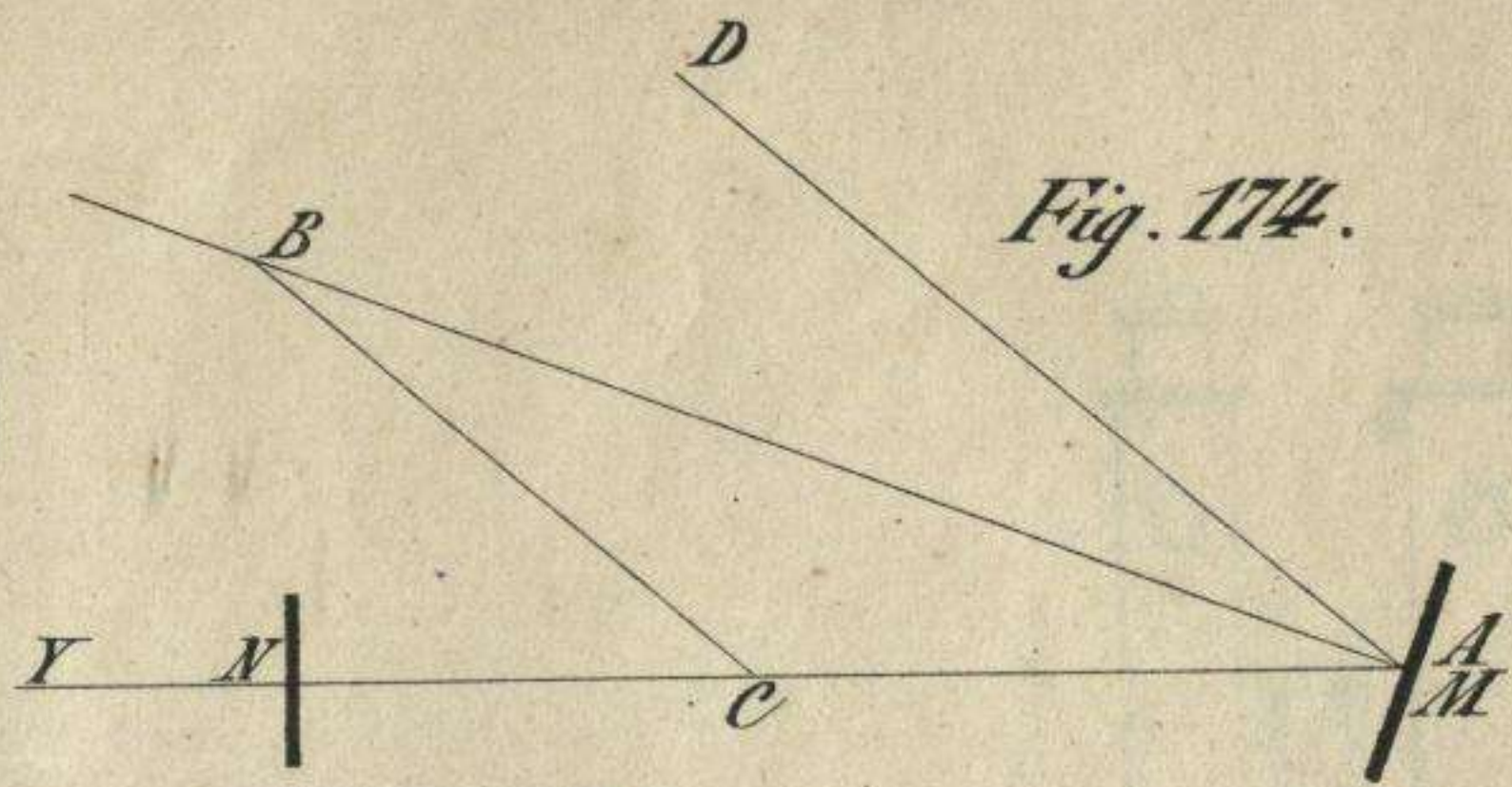
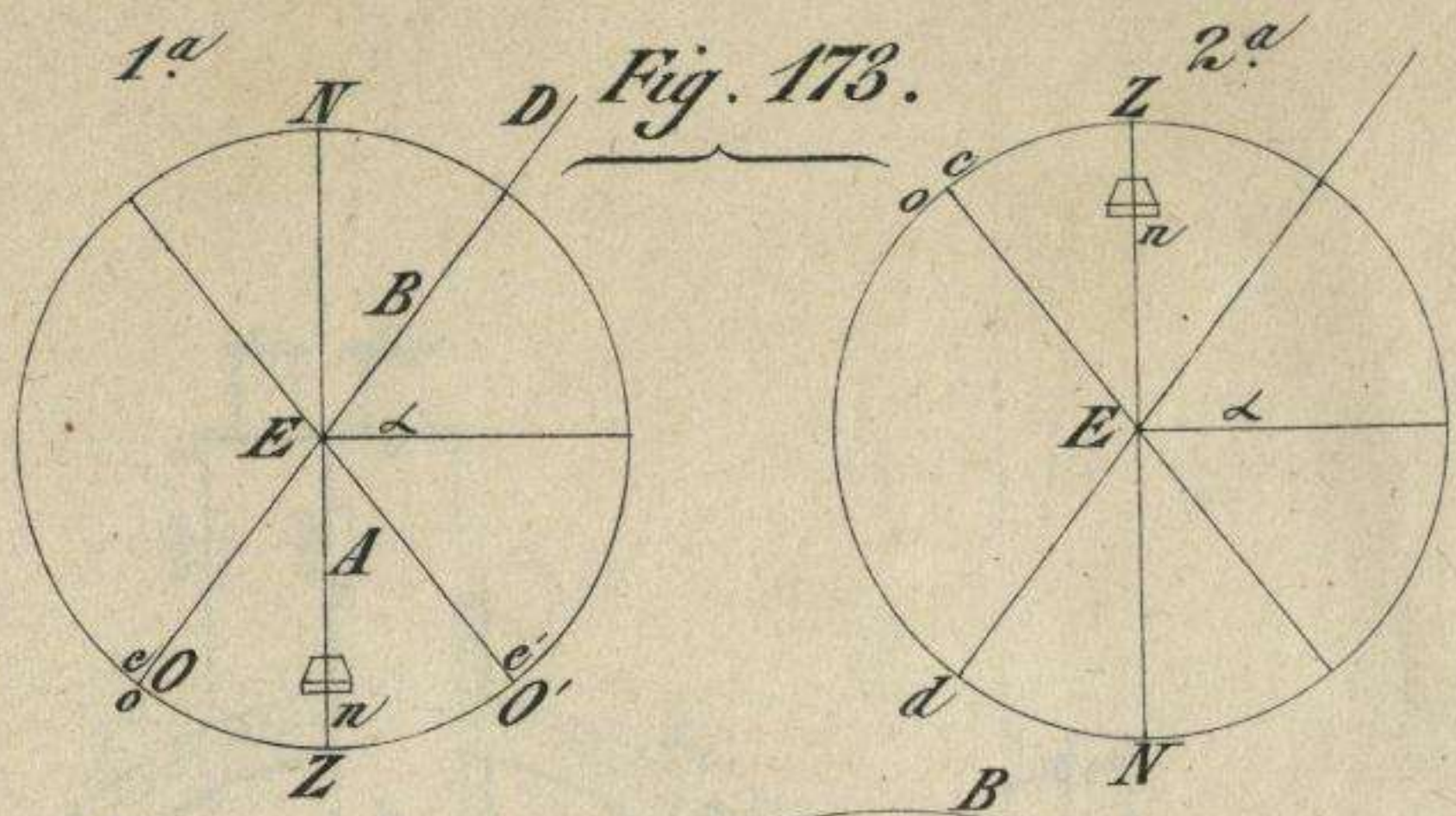
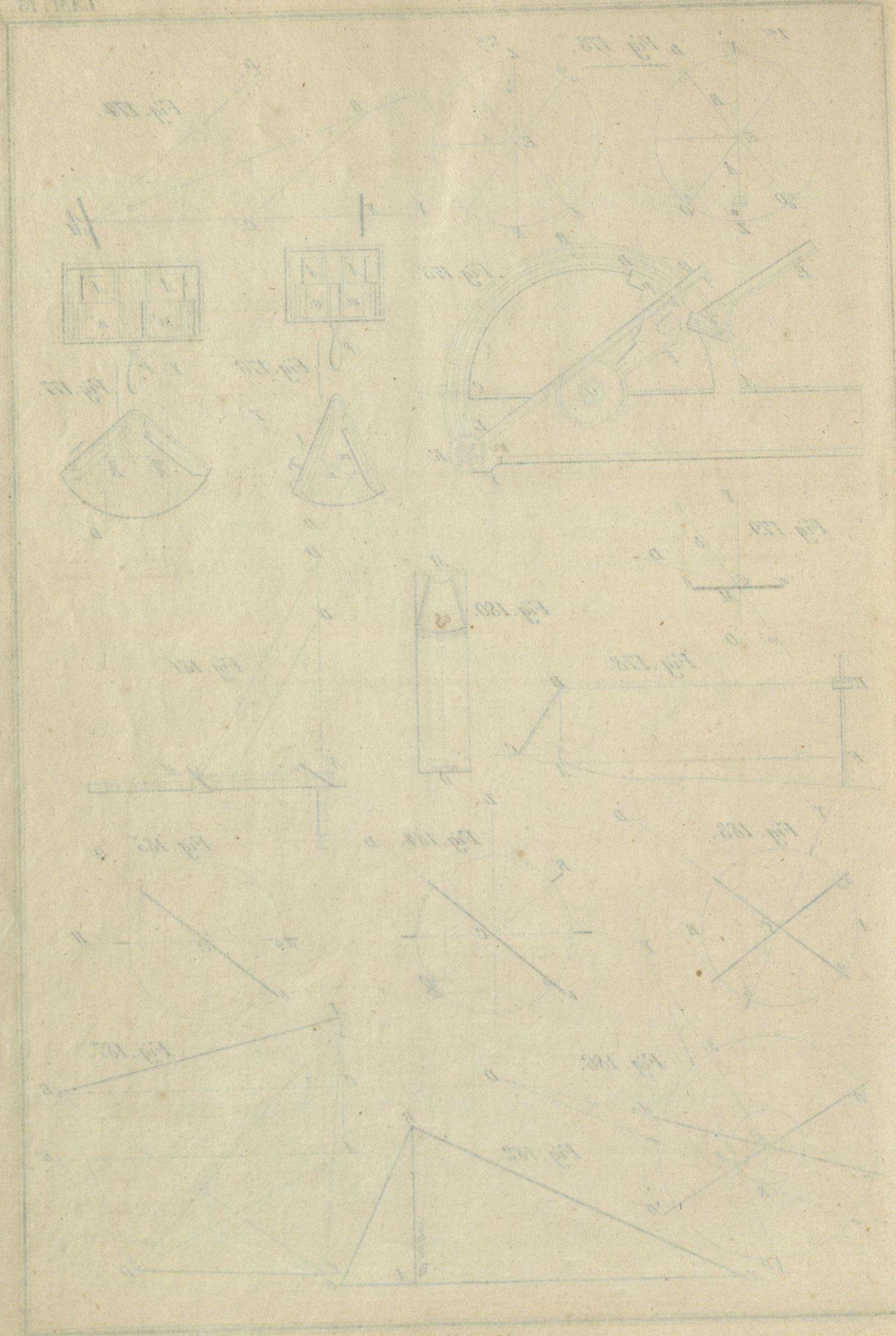

Fig. 171.









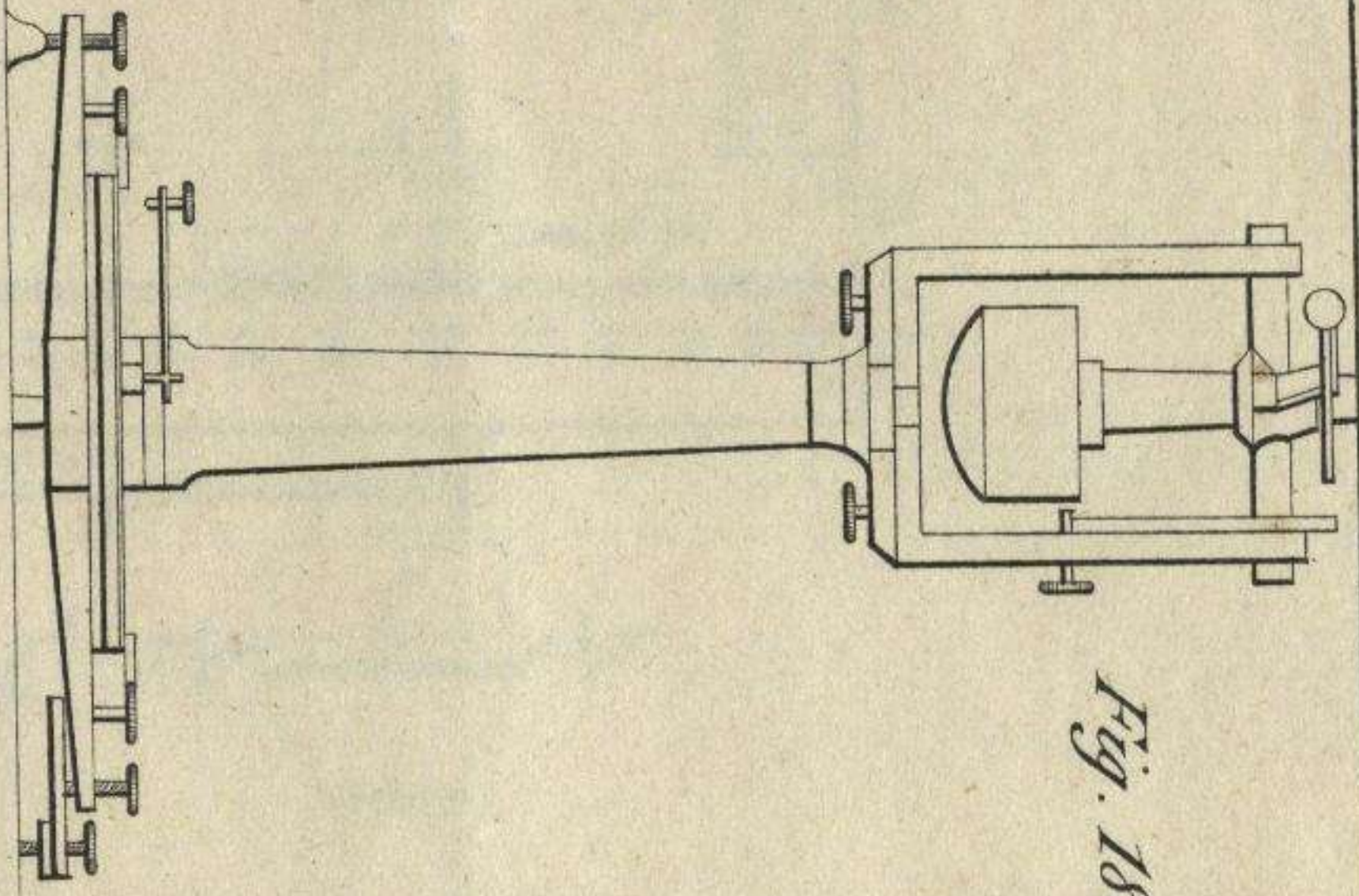
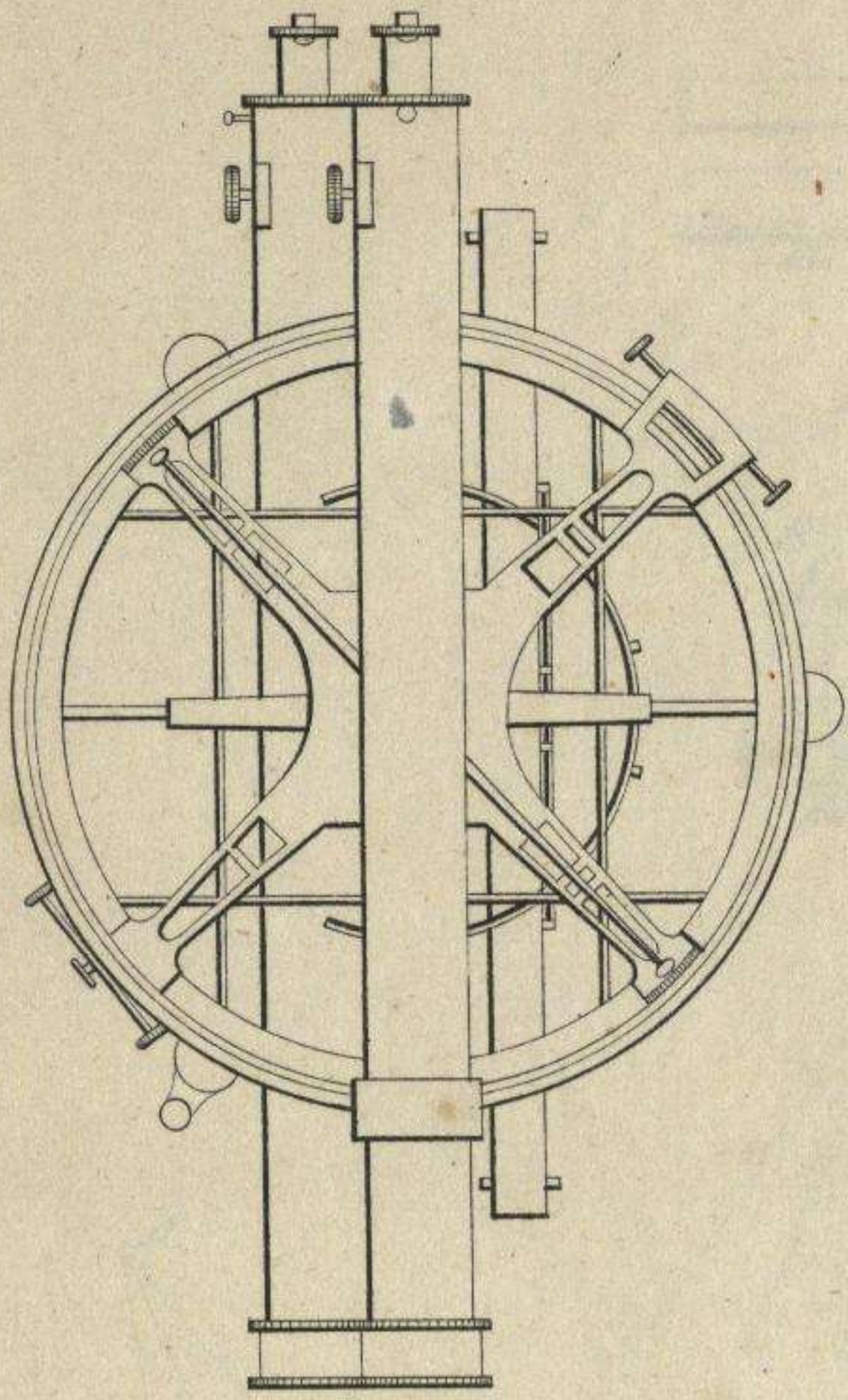

Fig. 188.

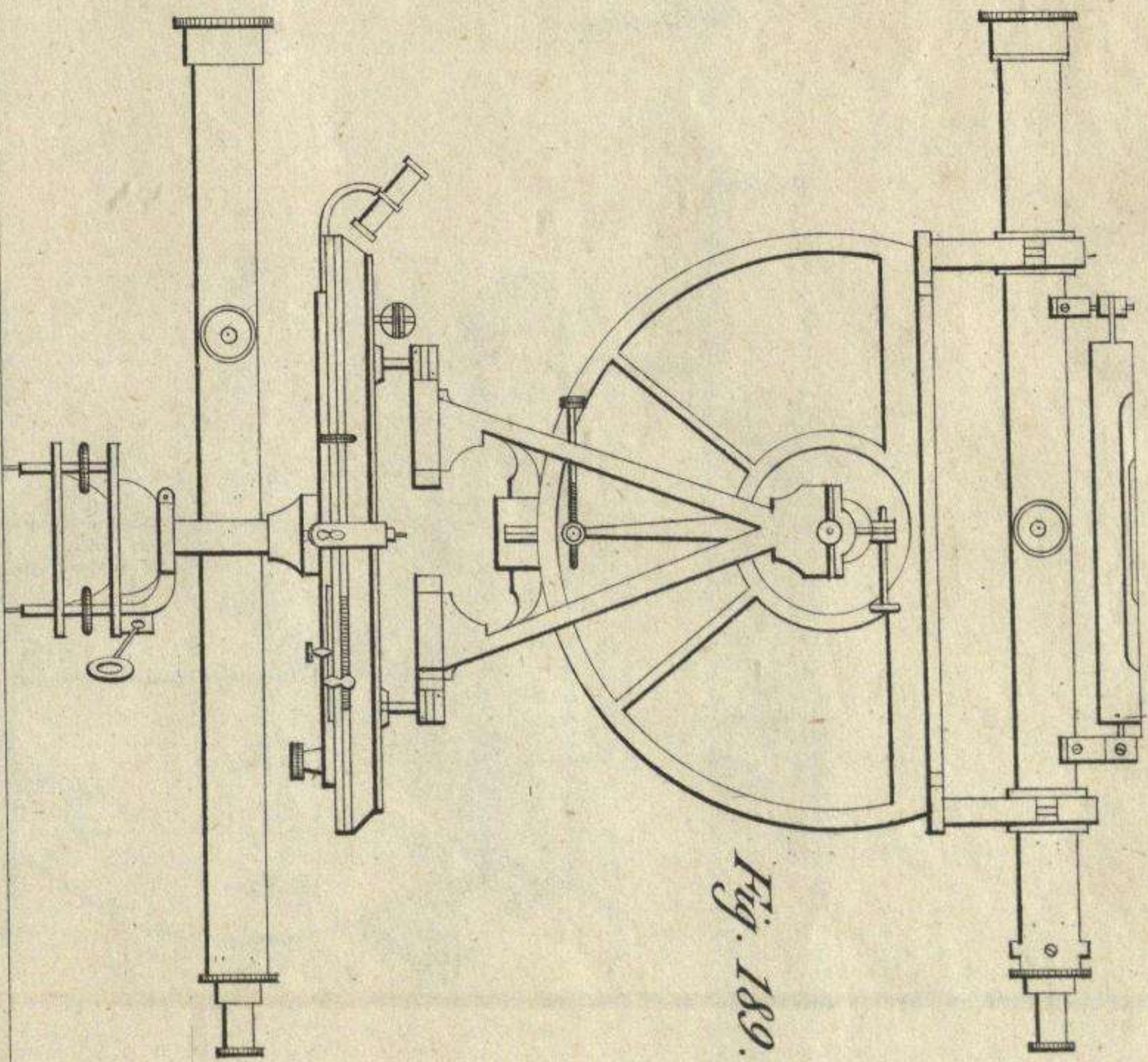
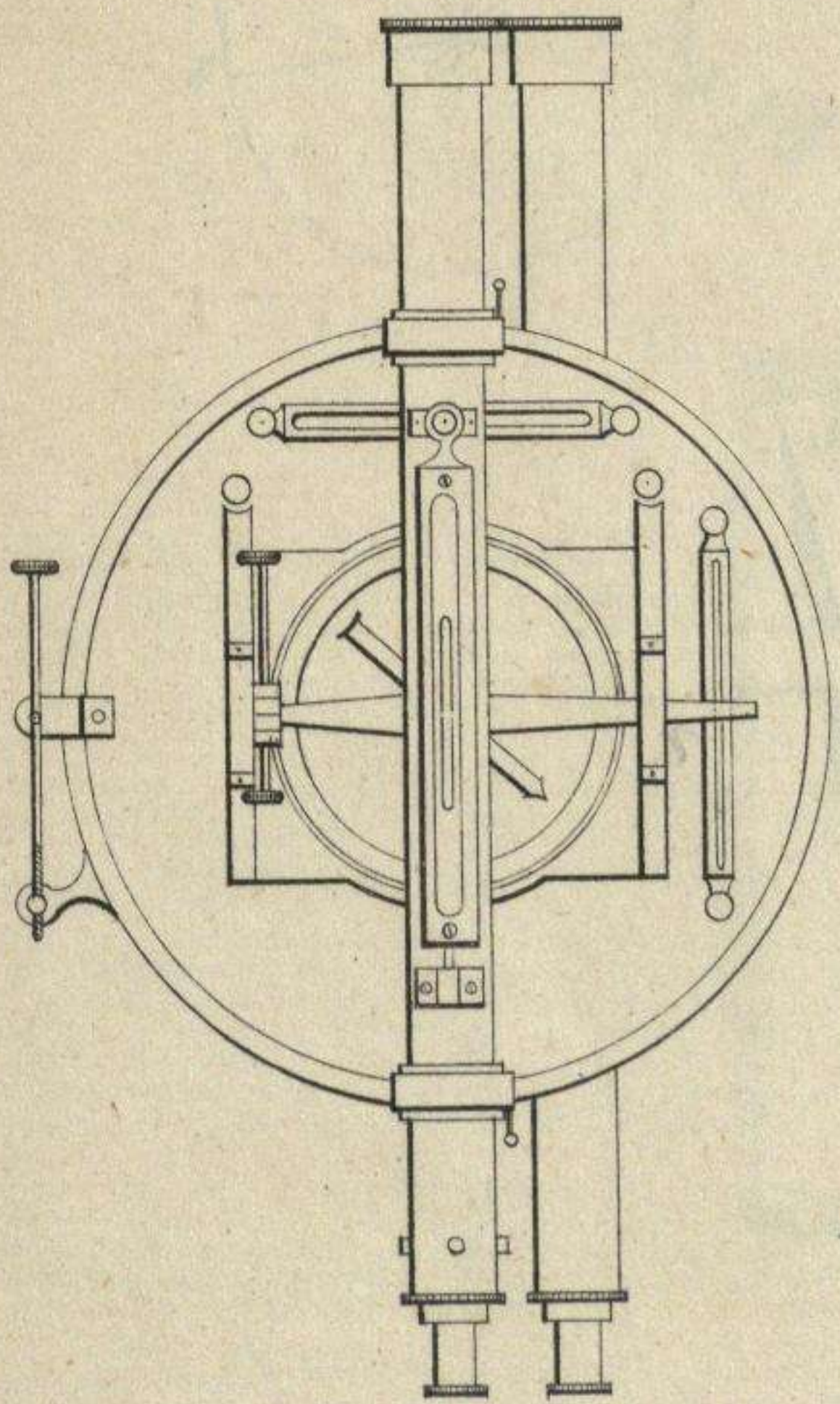
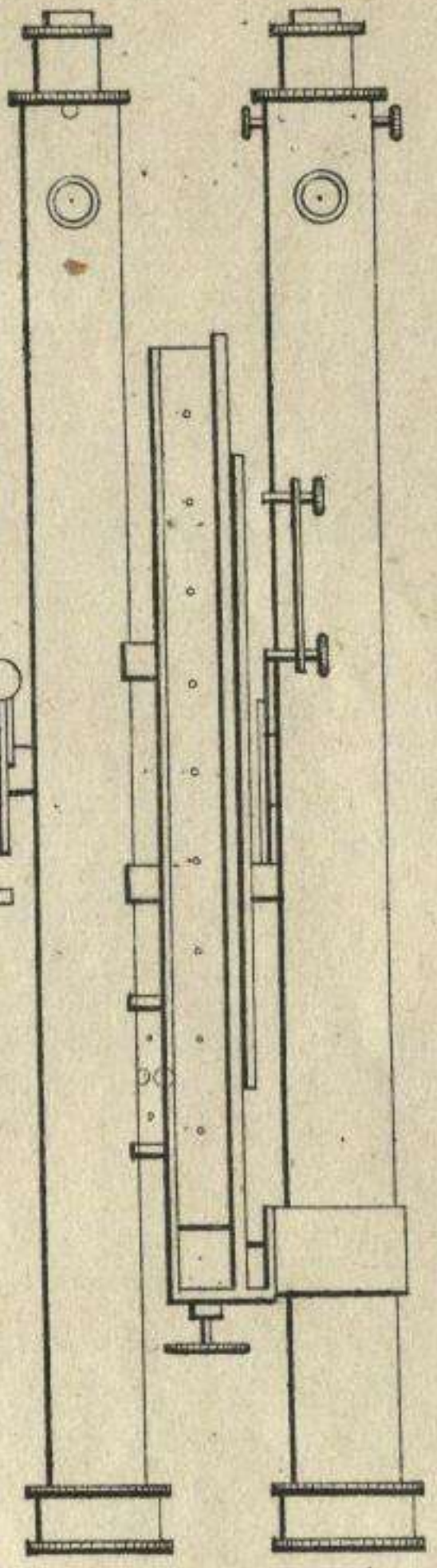

Fig. 189.

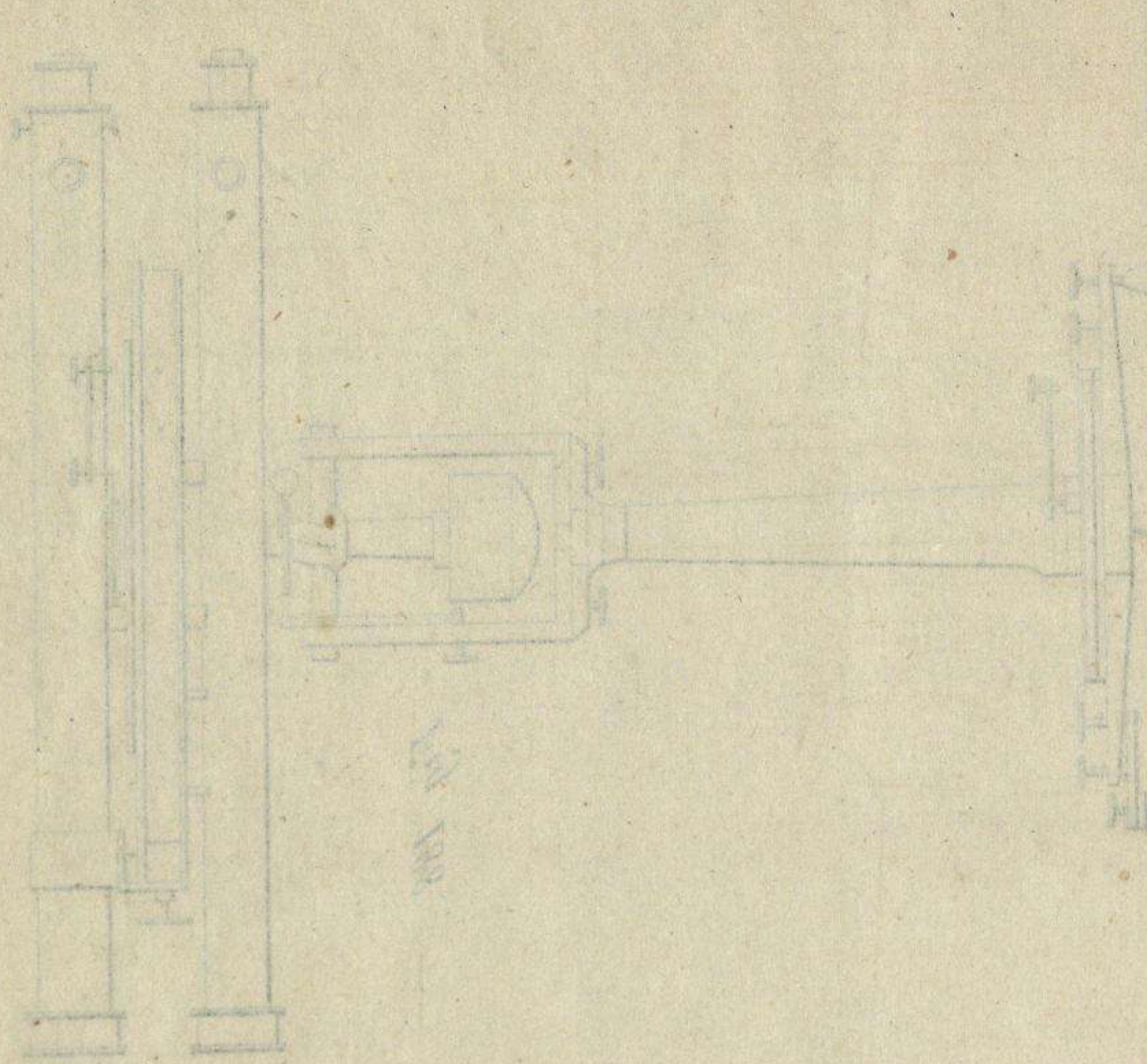

Fig. 100

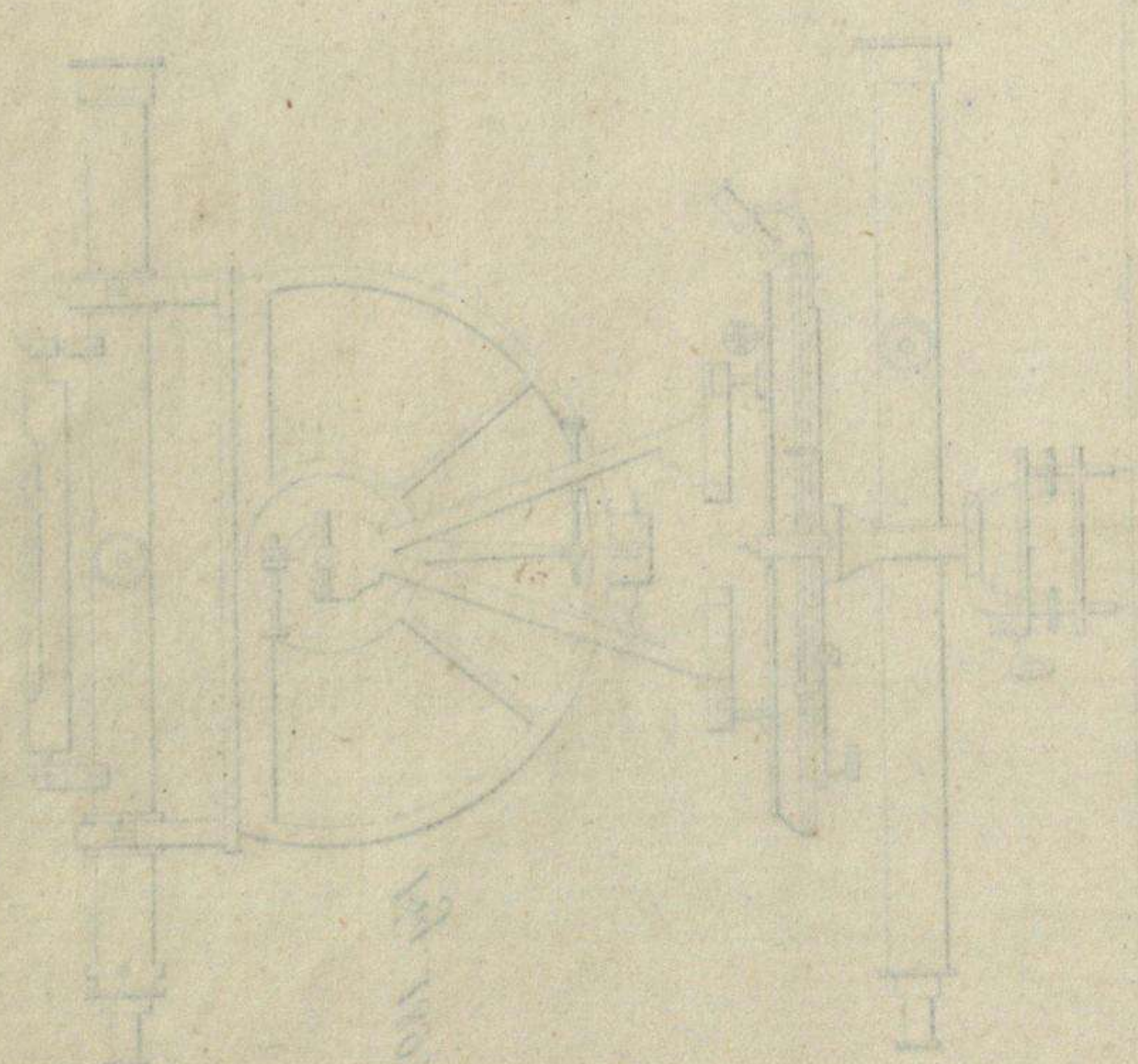
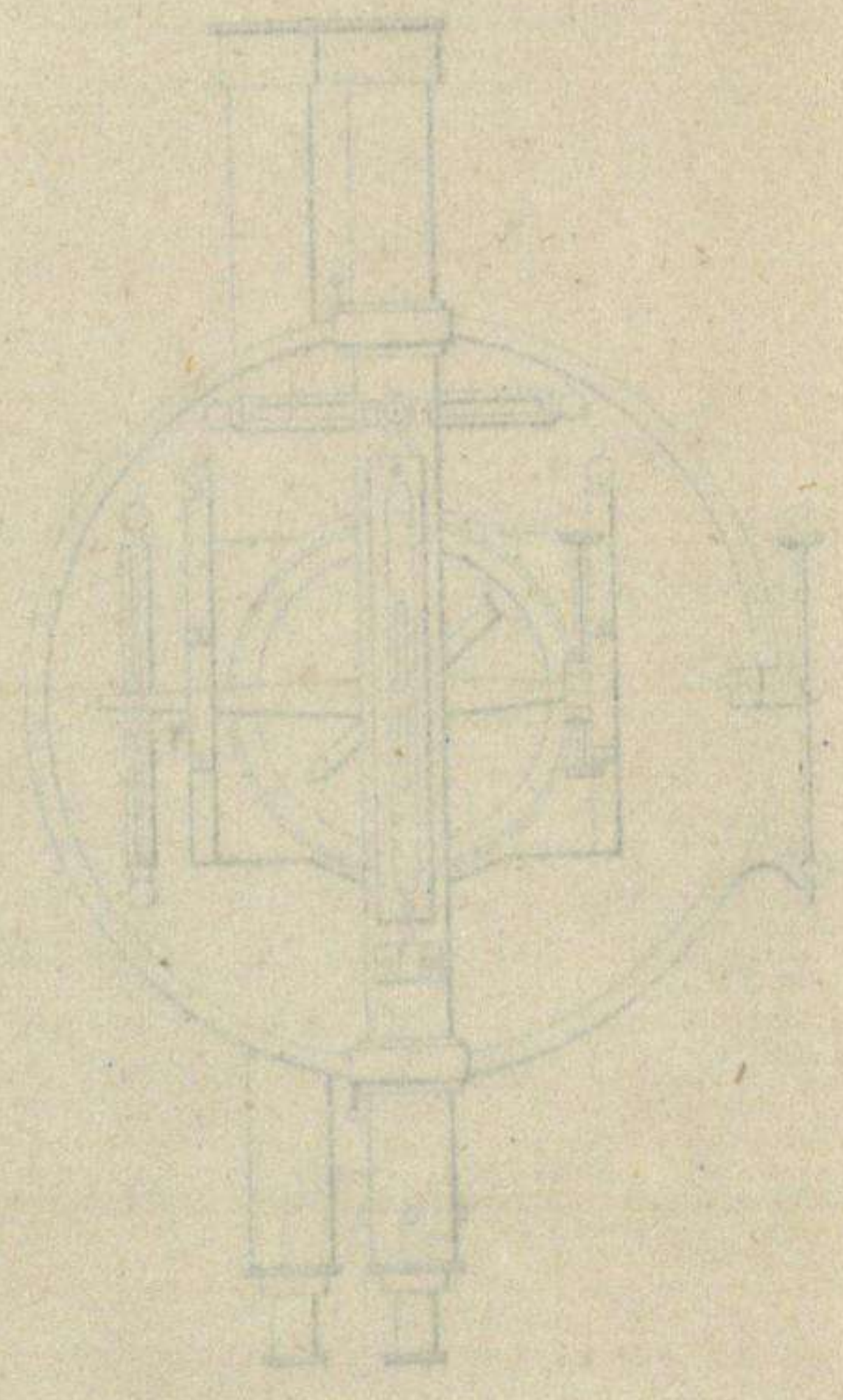

Fig. 101



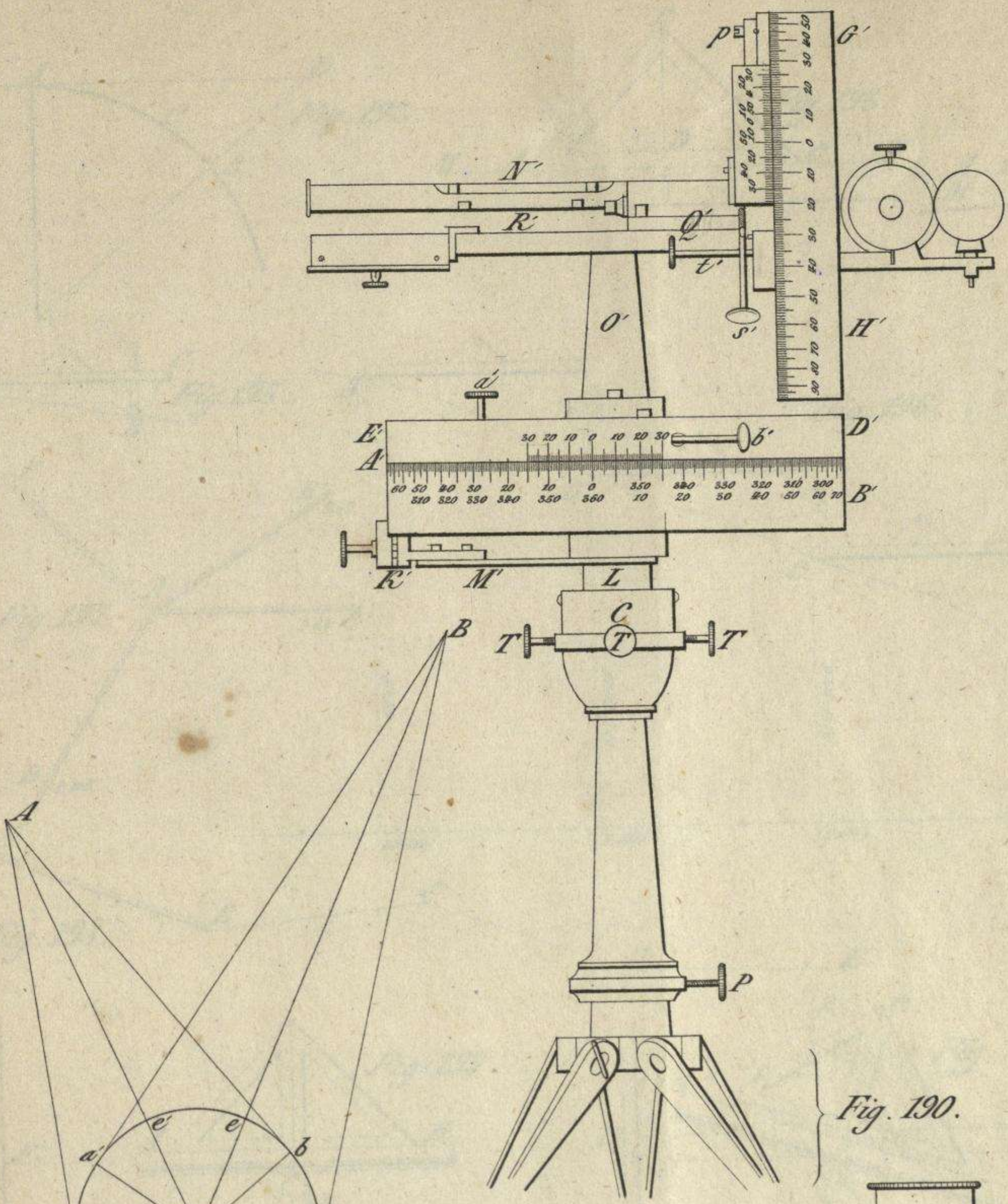

Fig. 190.

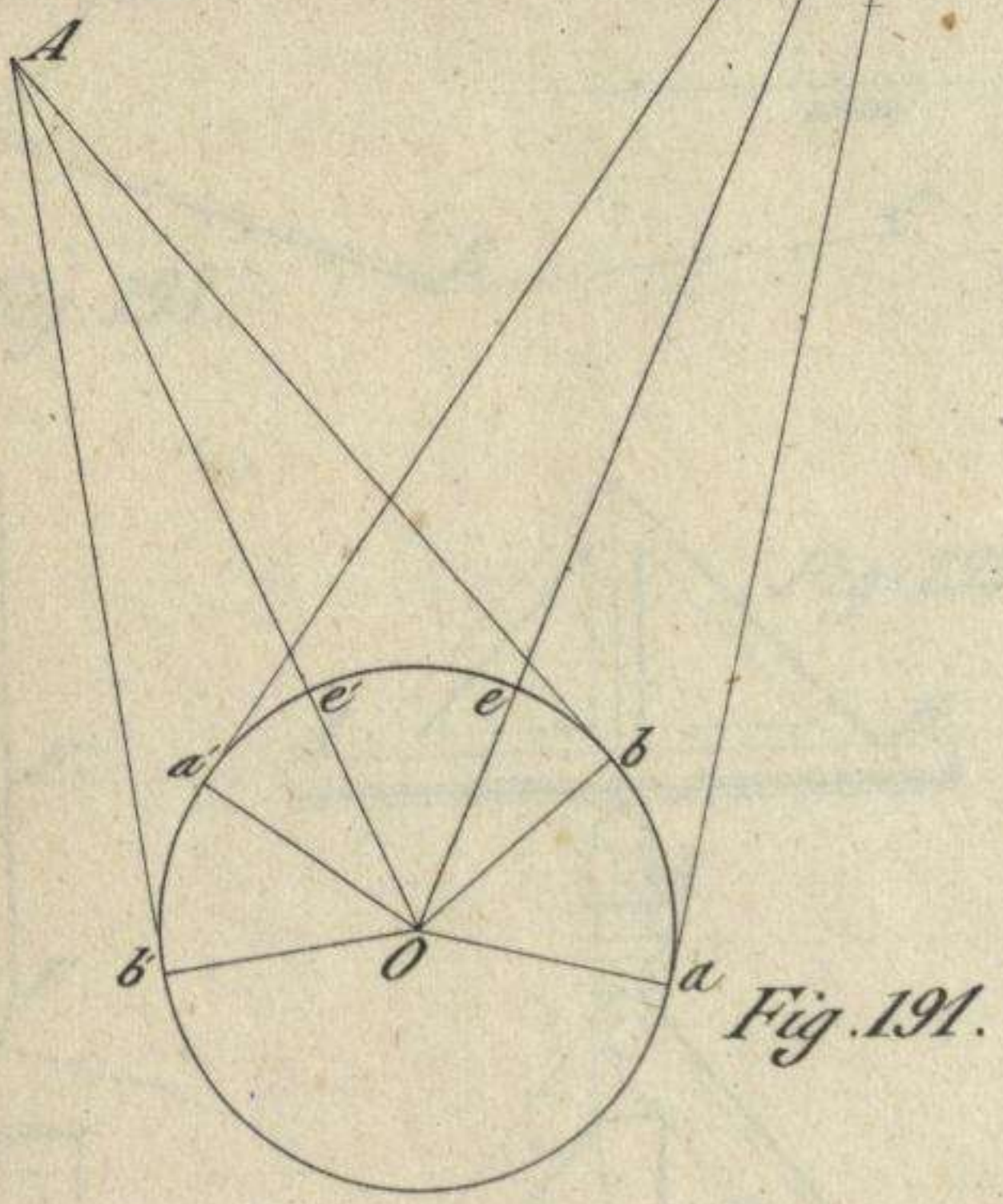
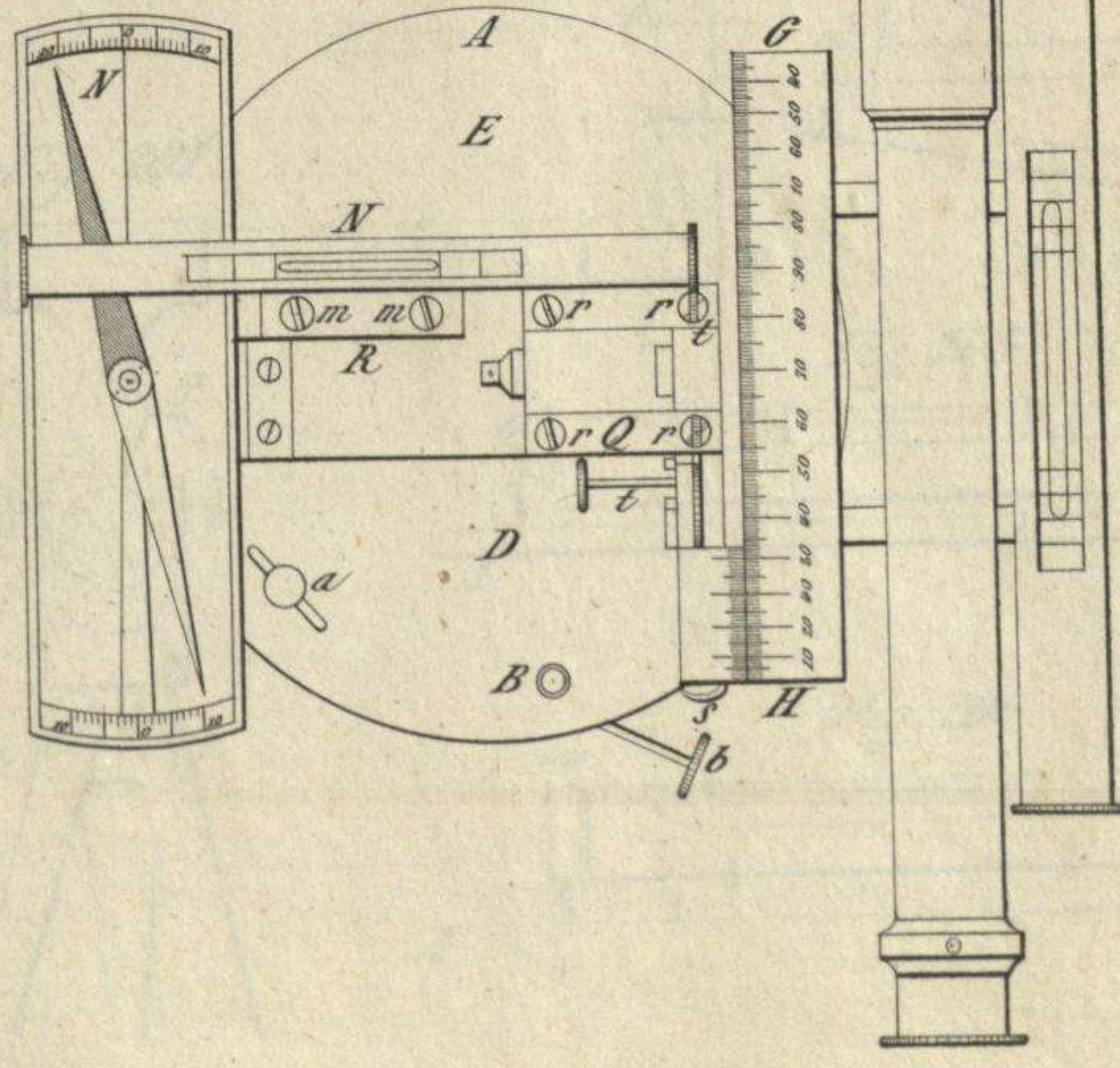
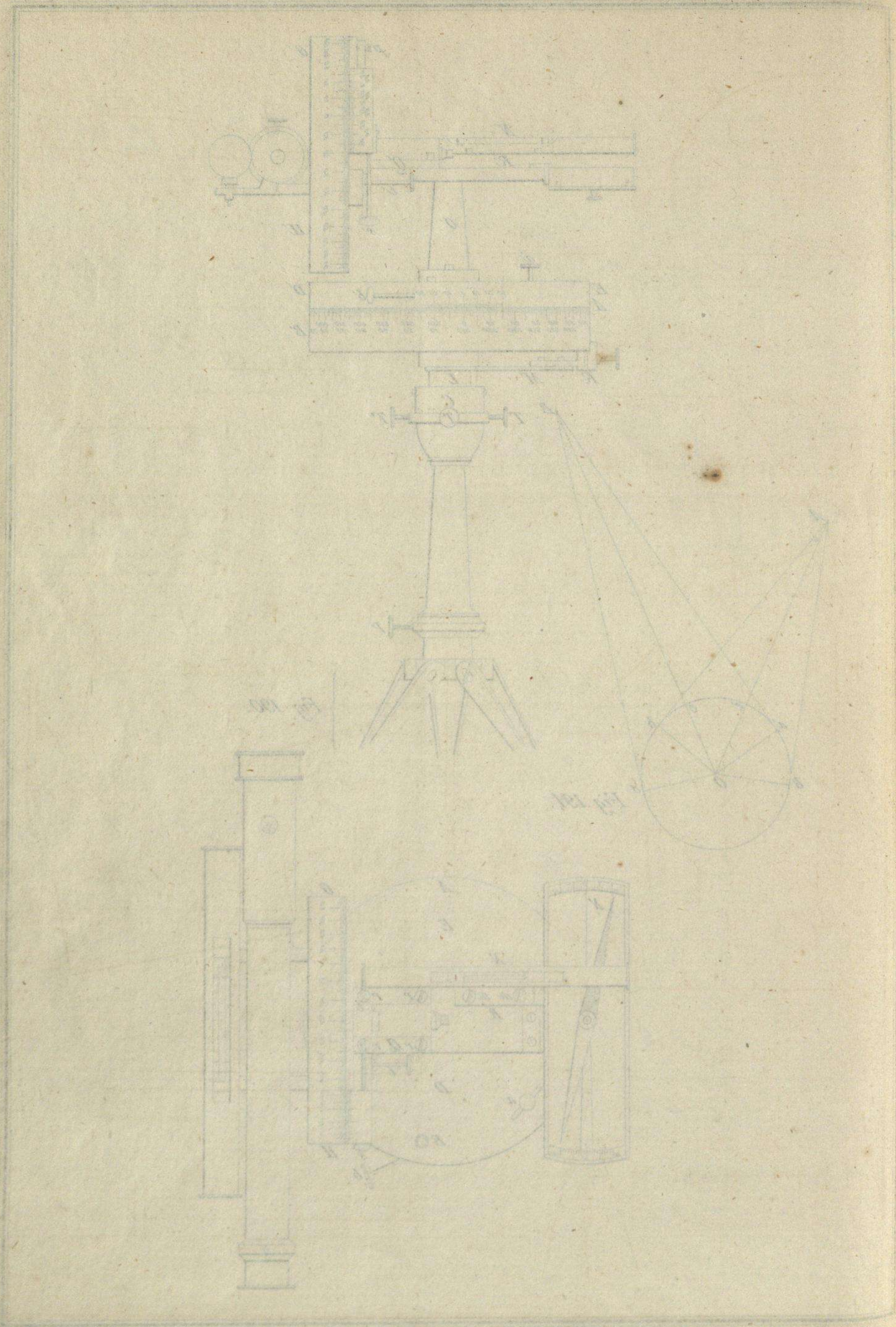

Fig. 191.





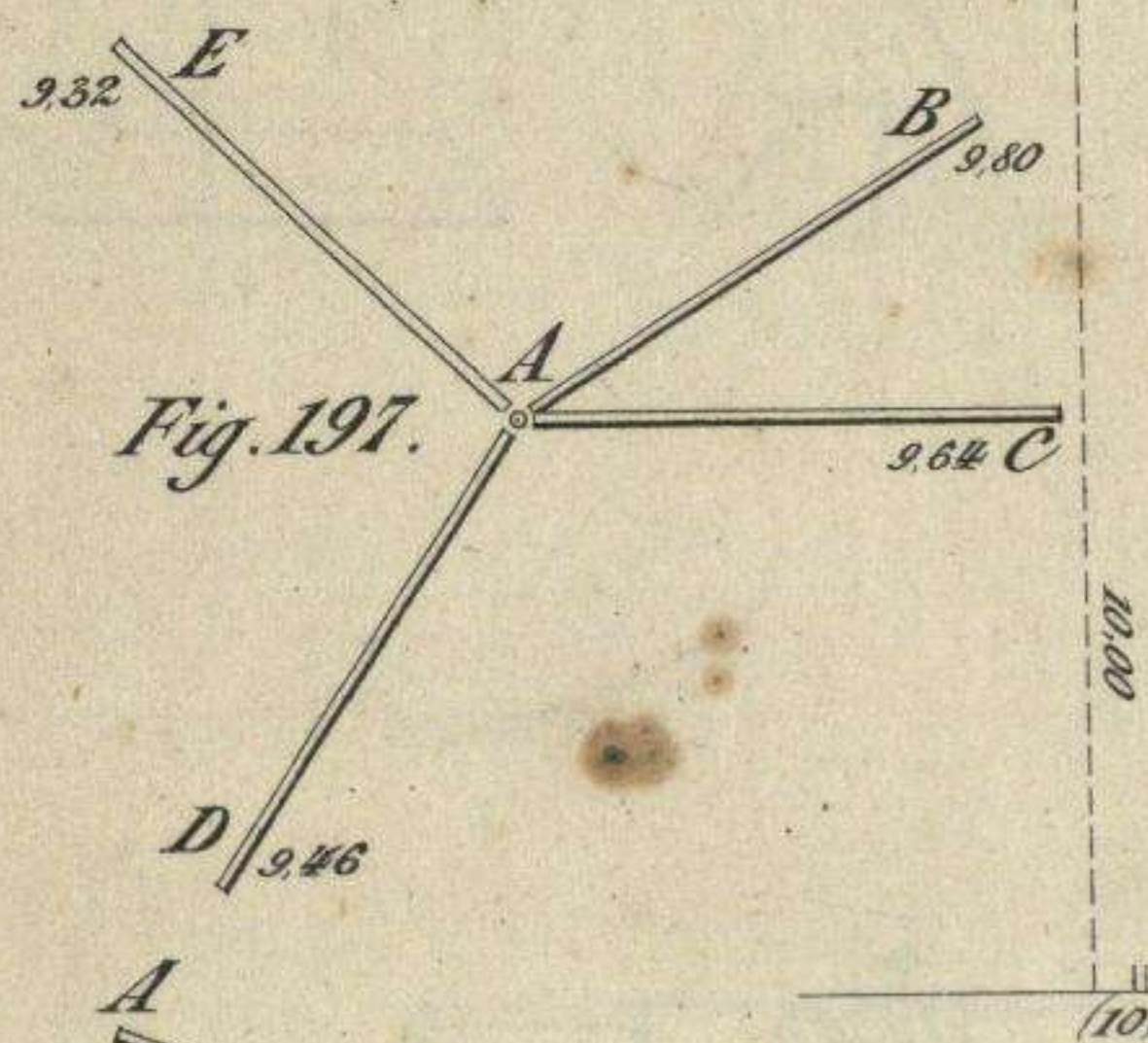
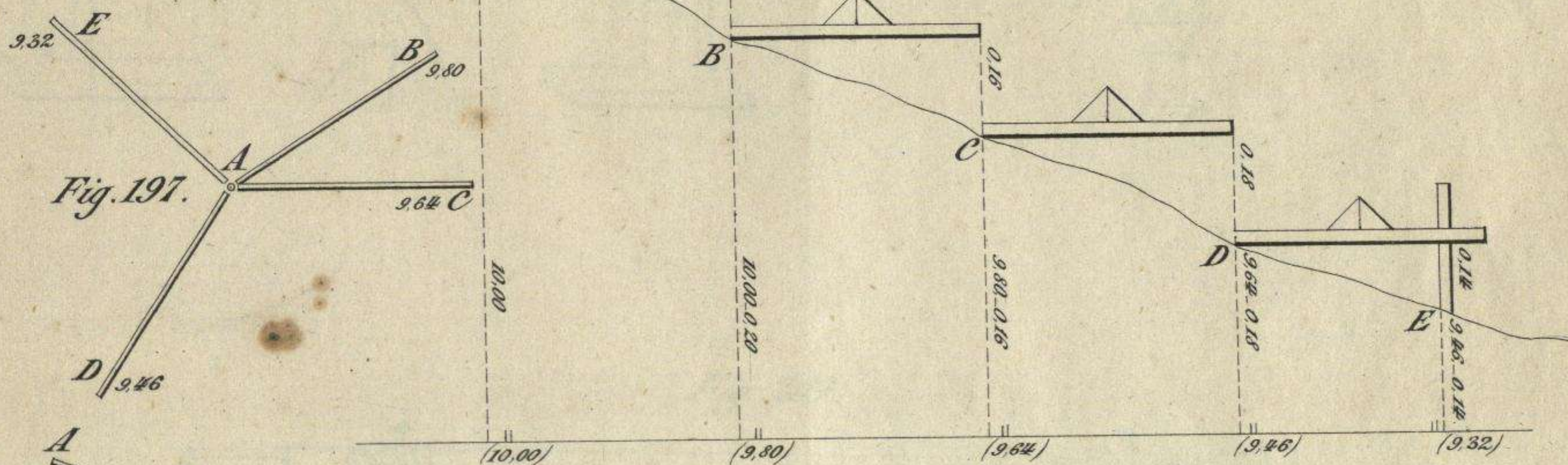
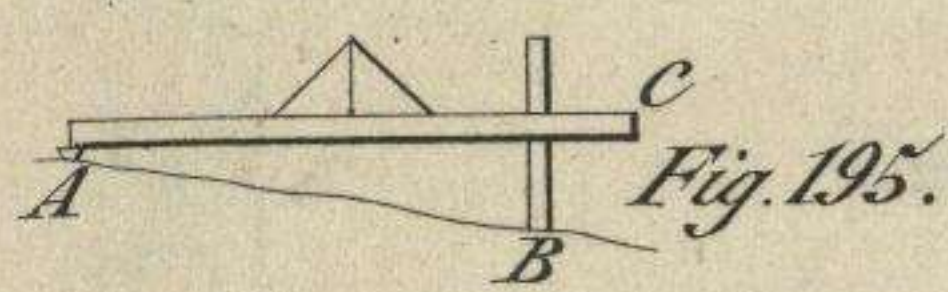
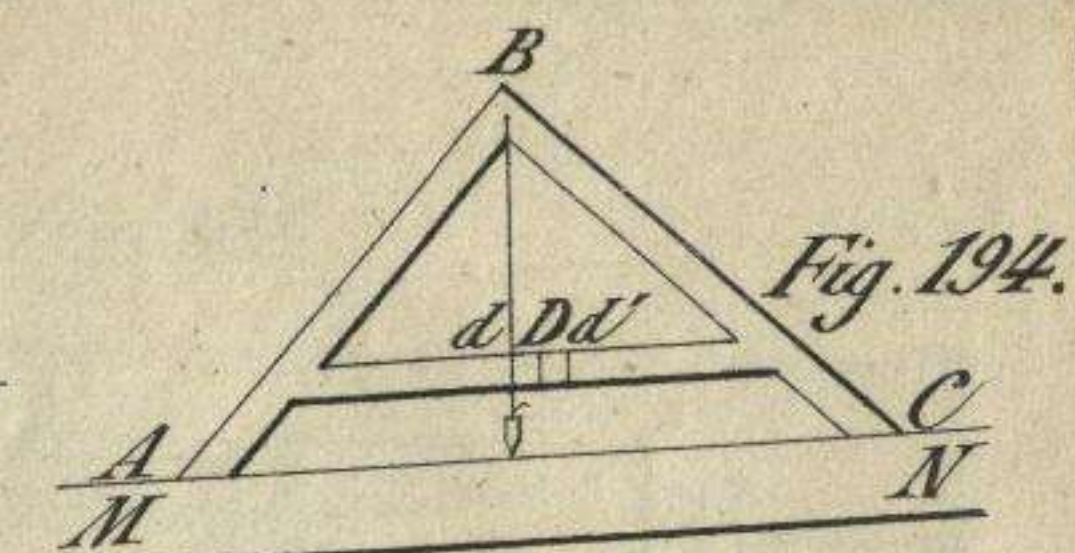
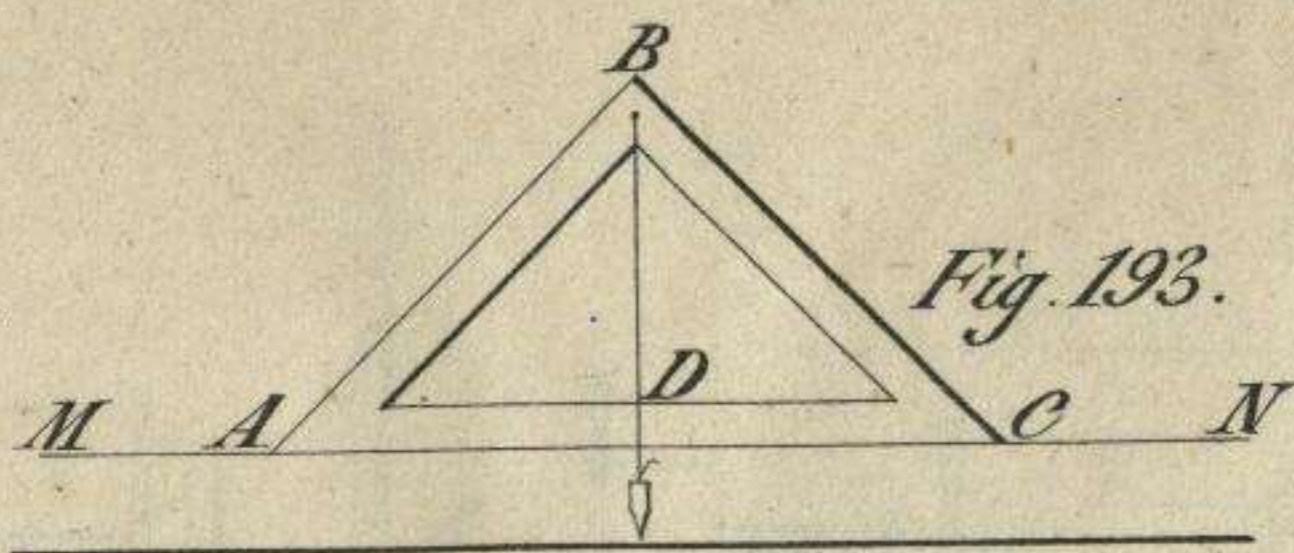
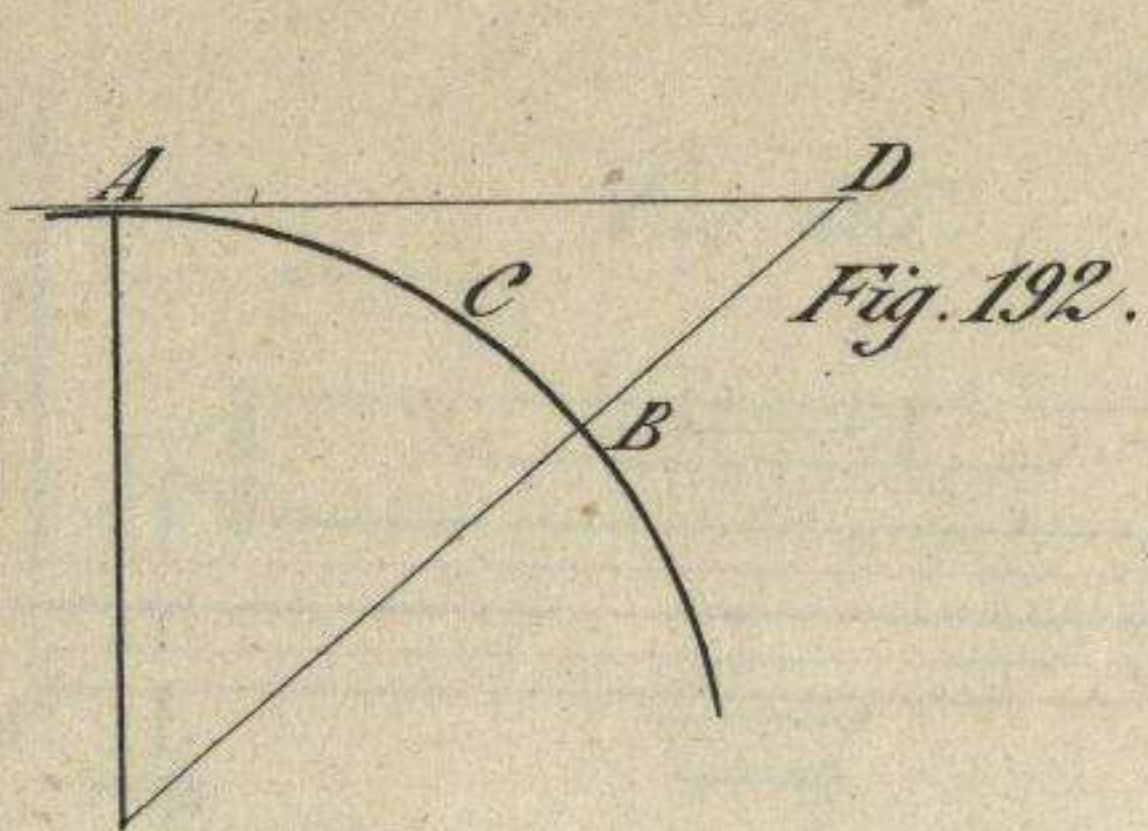
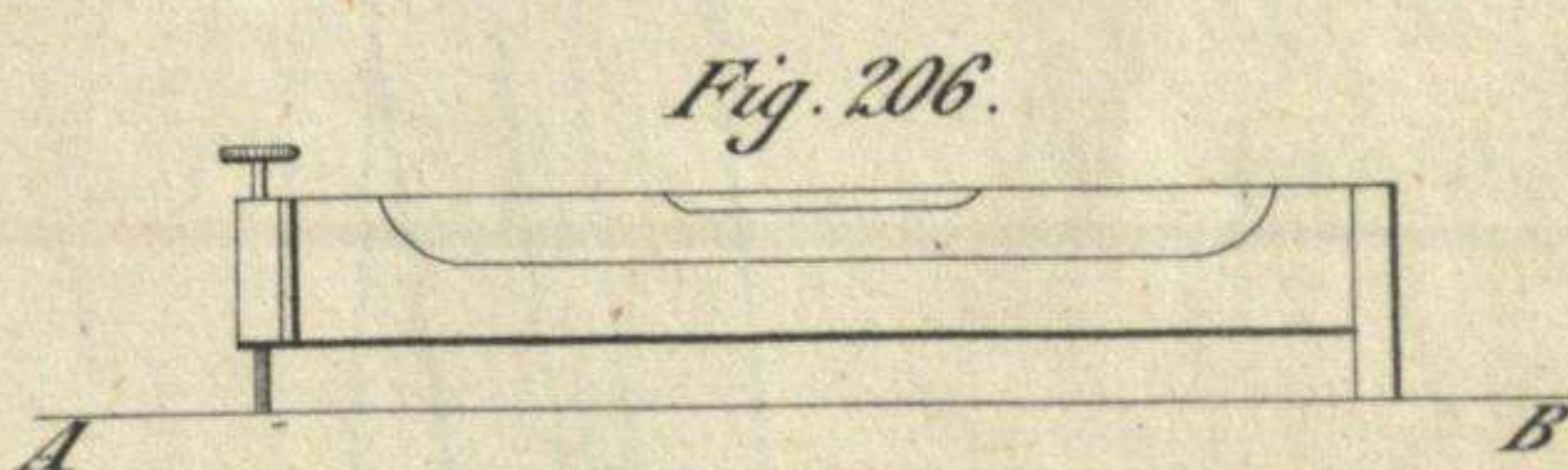
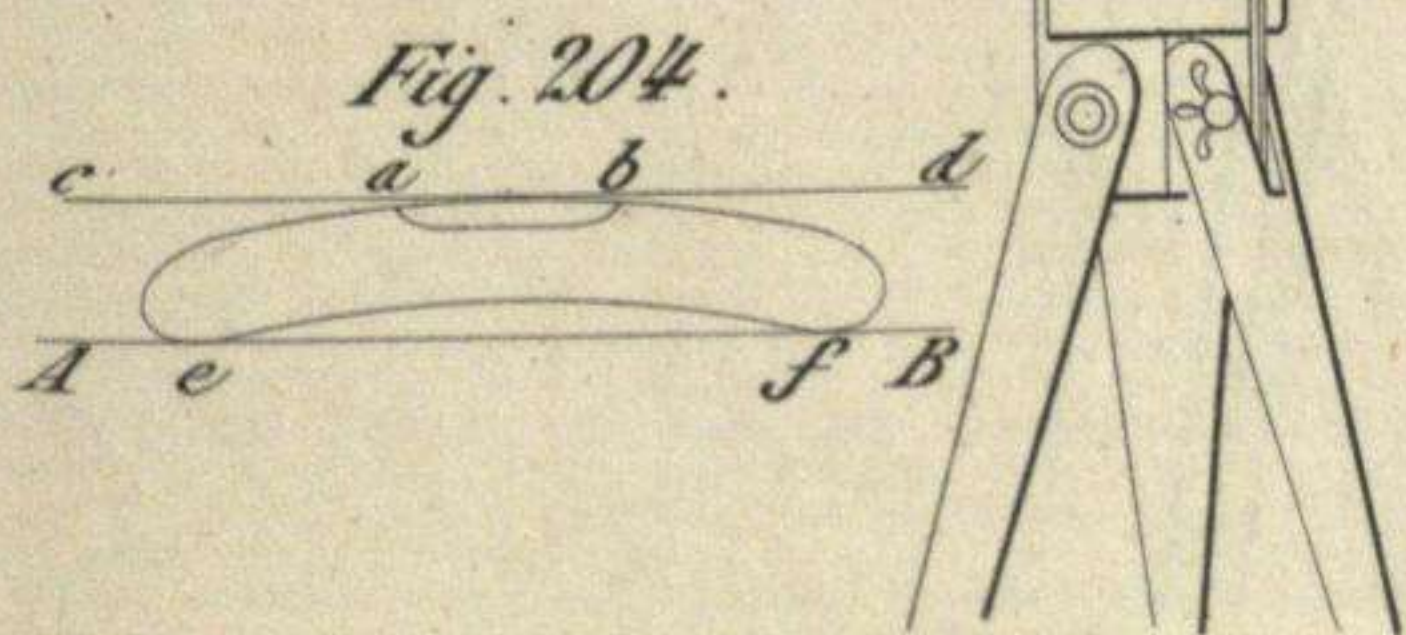
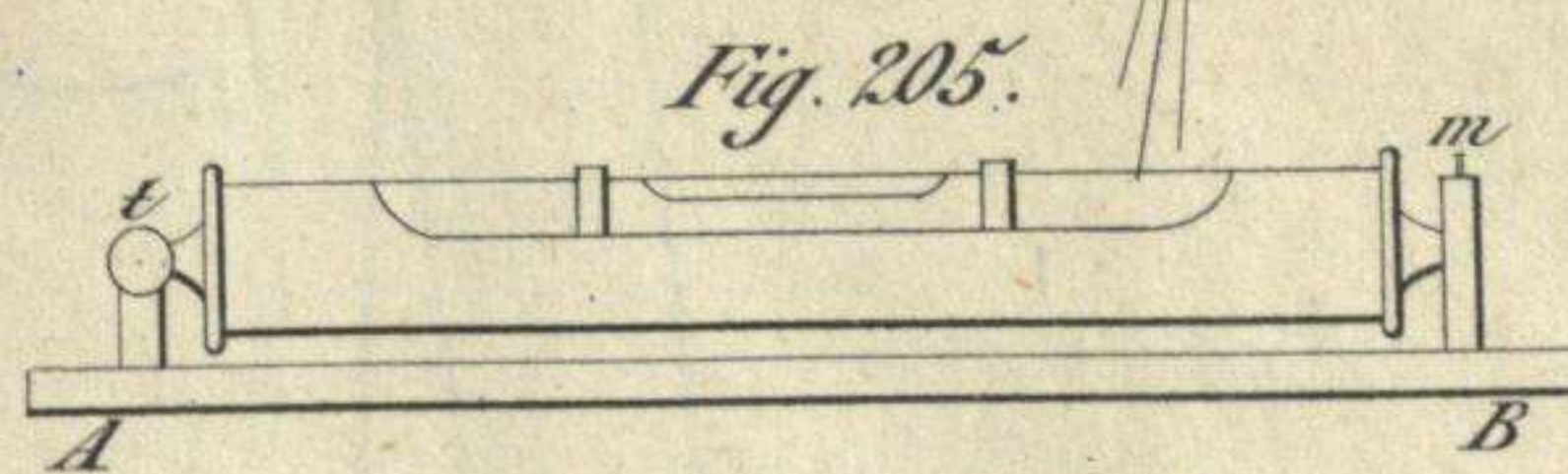
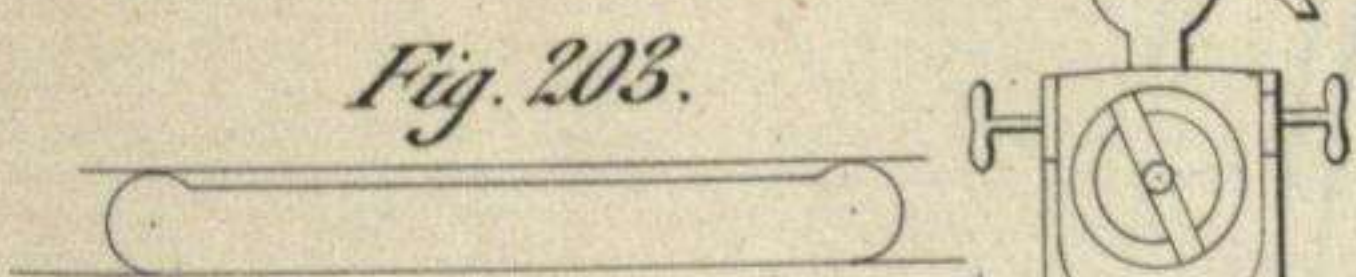
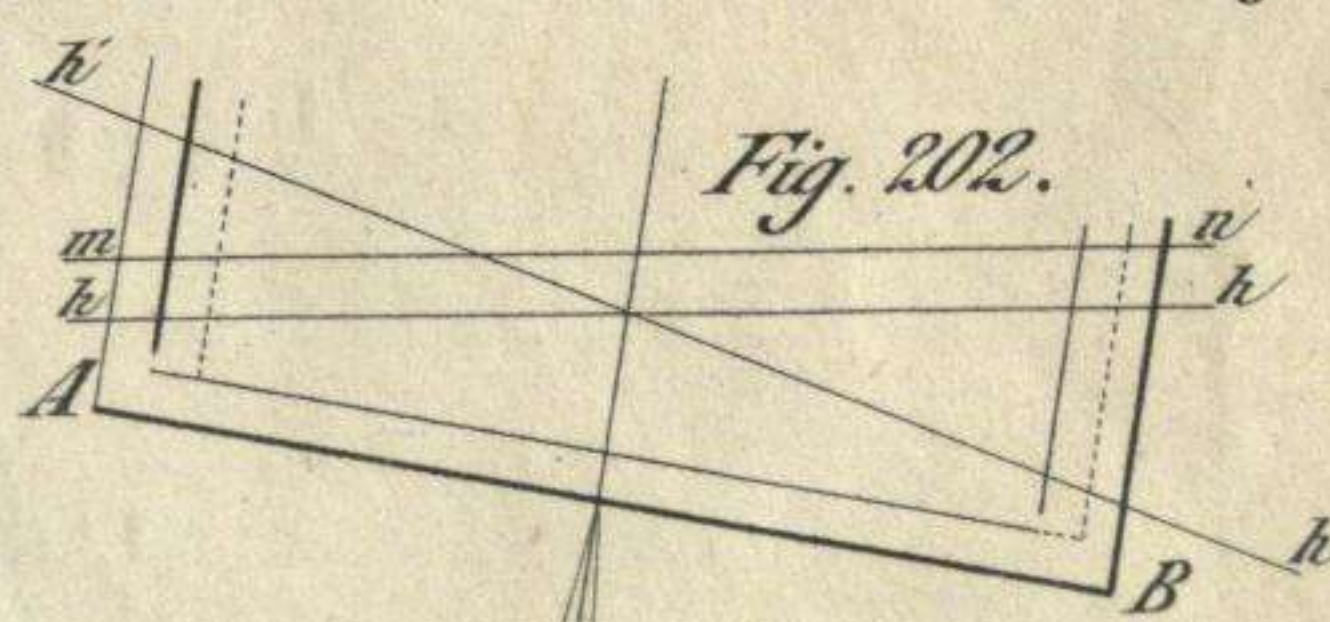
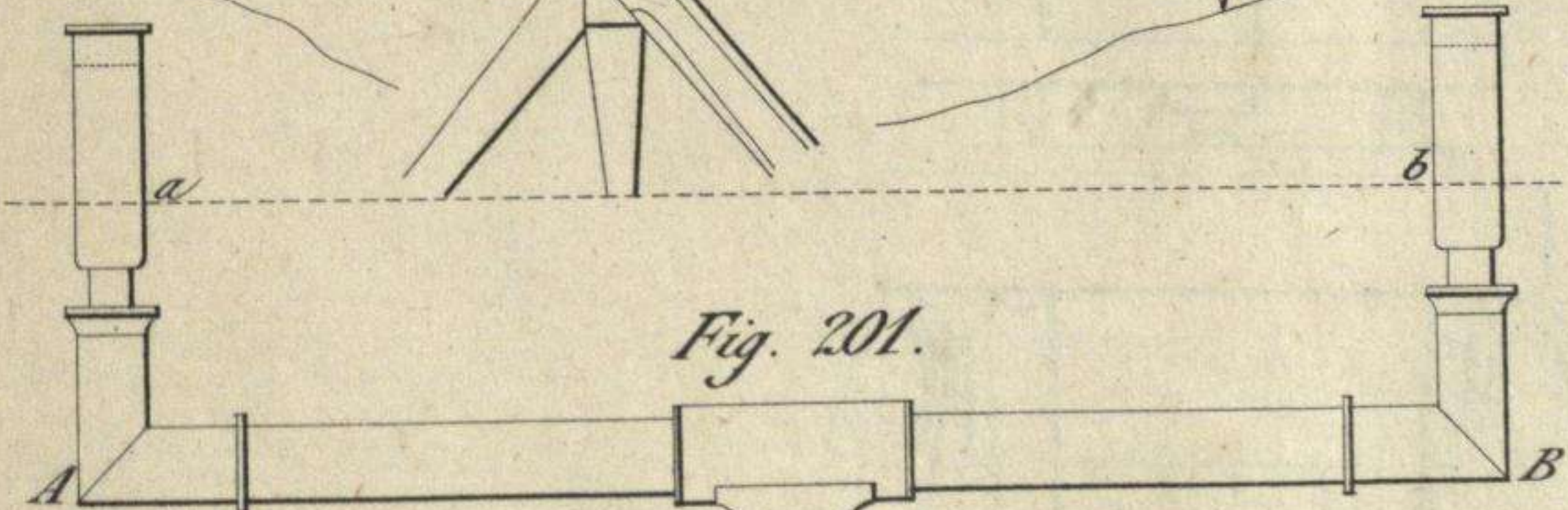
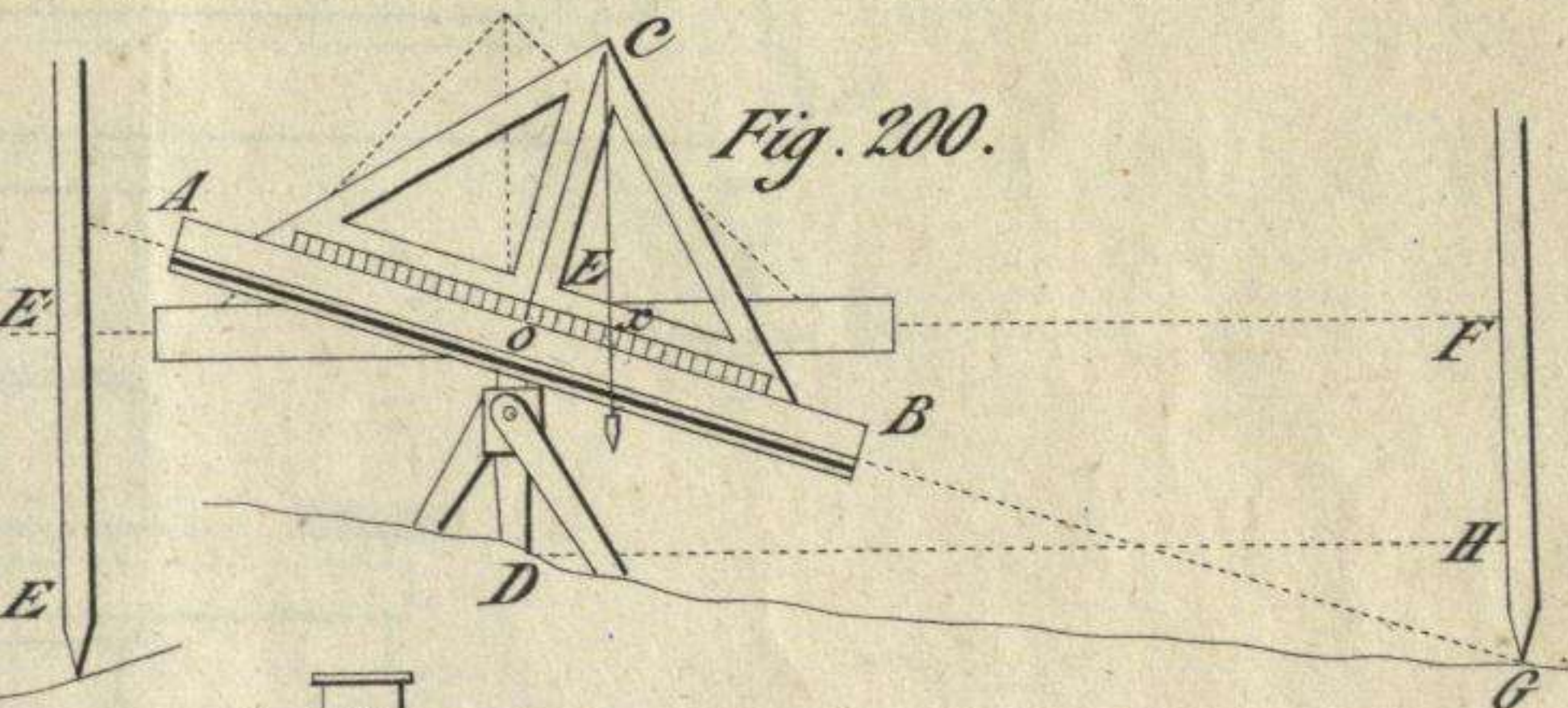
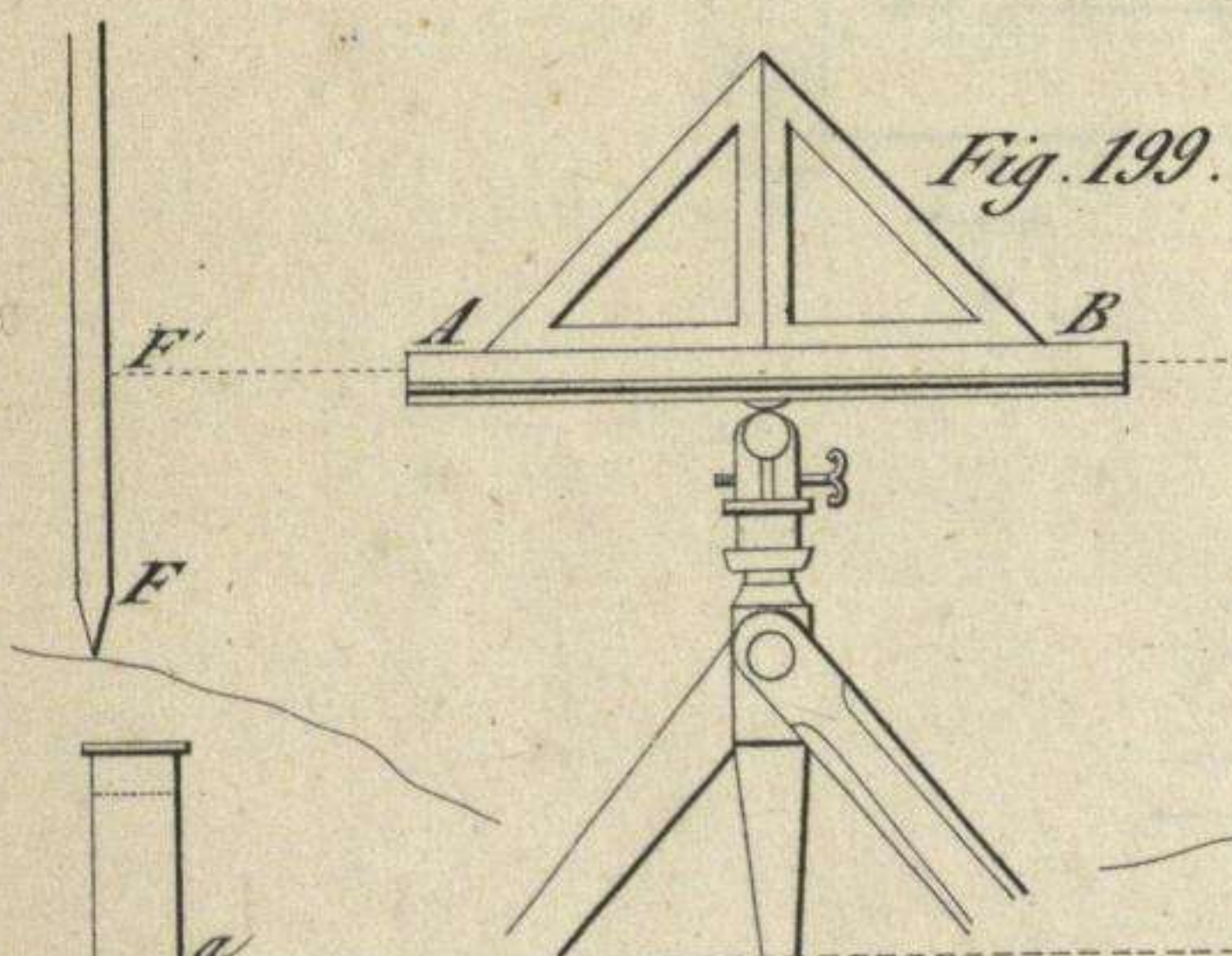
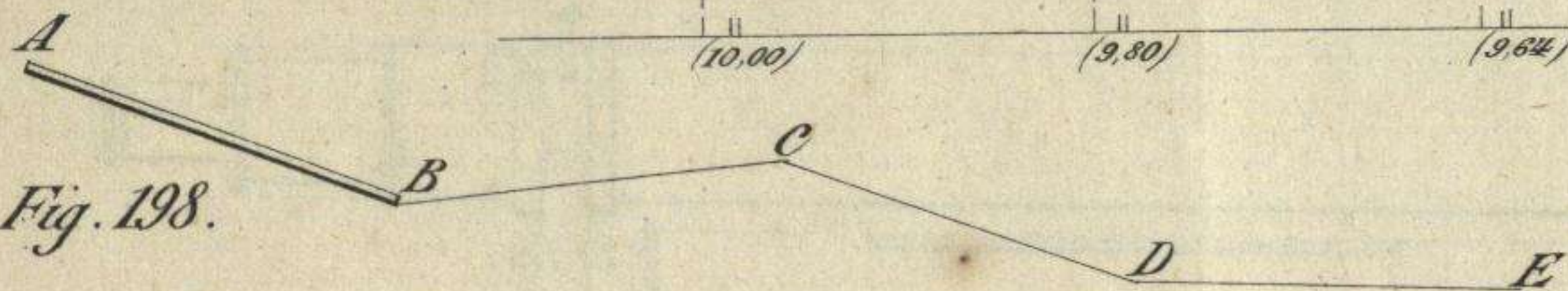

Fig. 198.



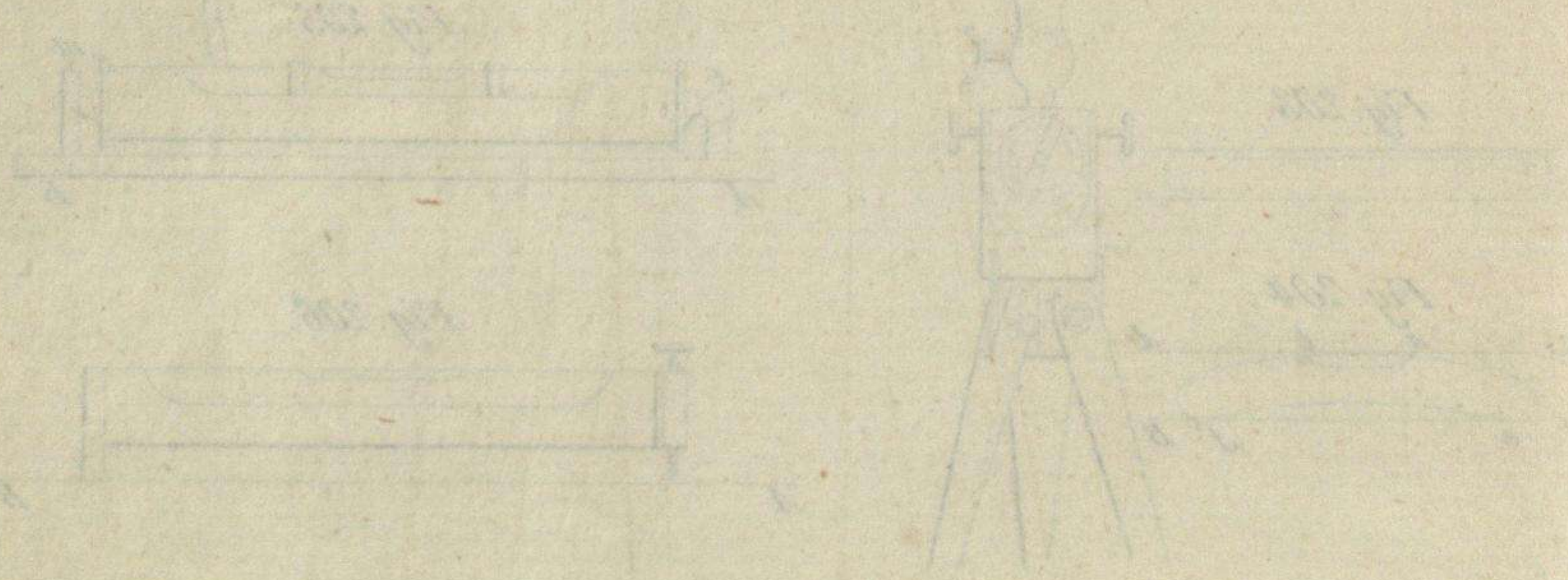
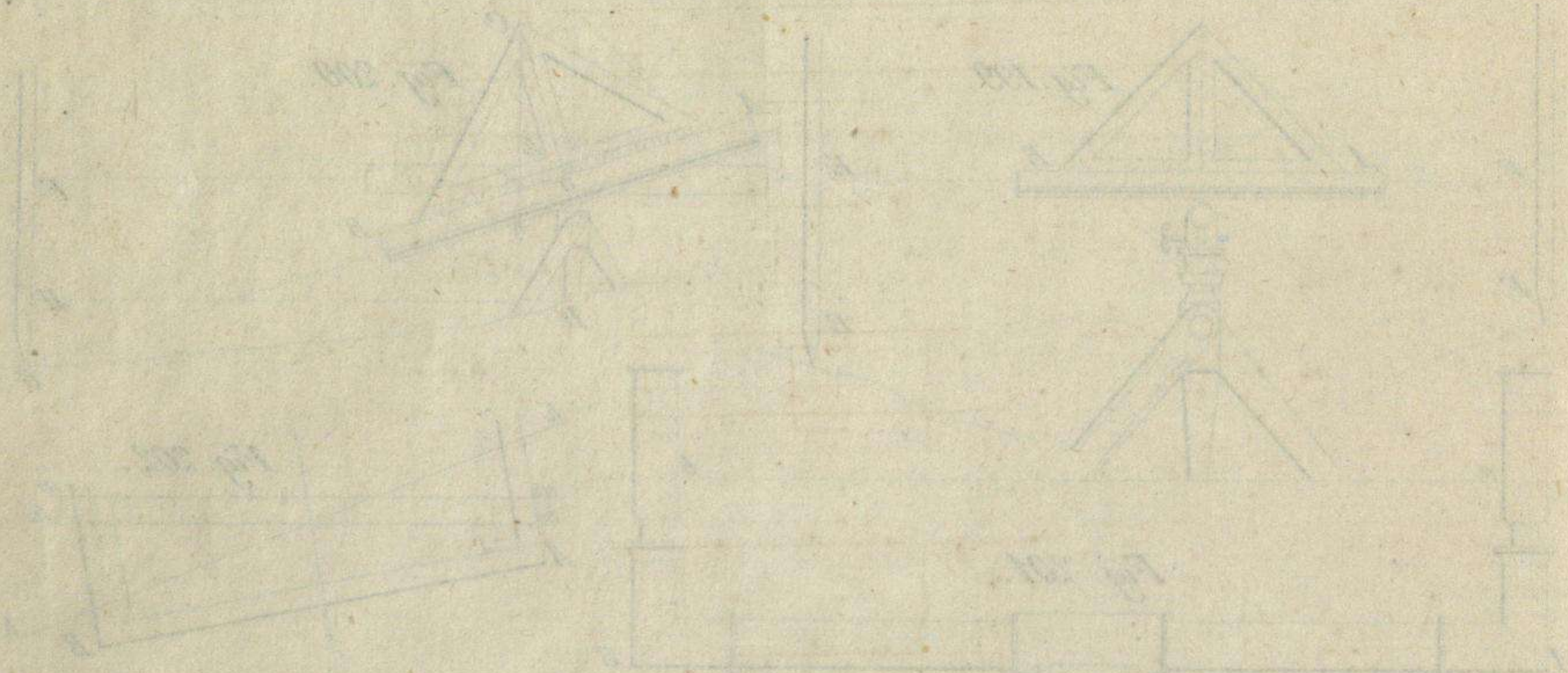
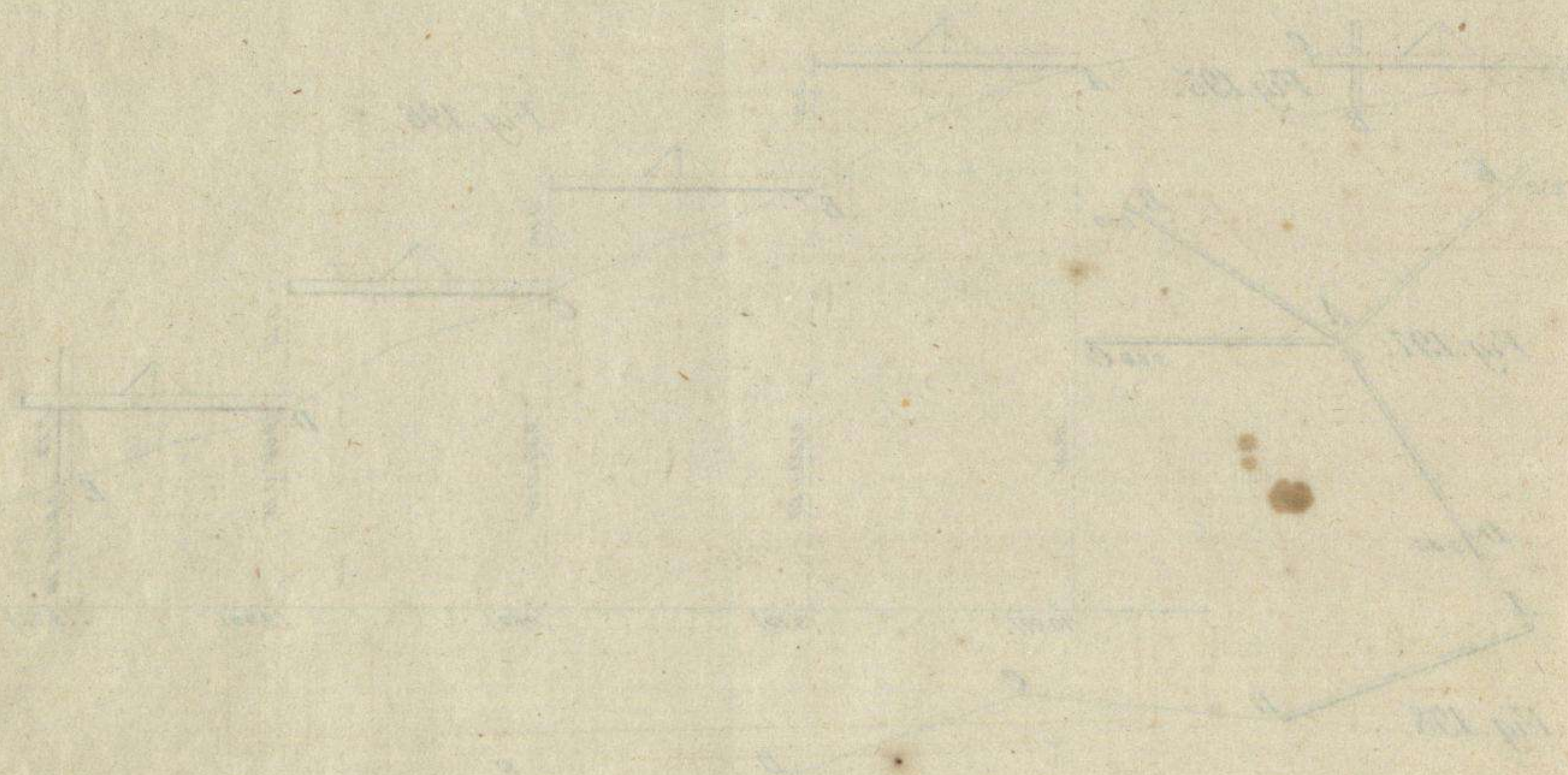
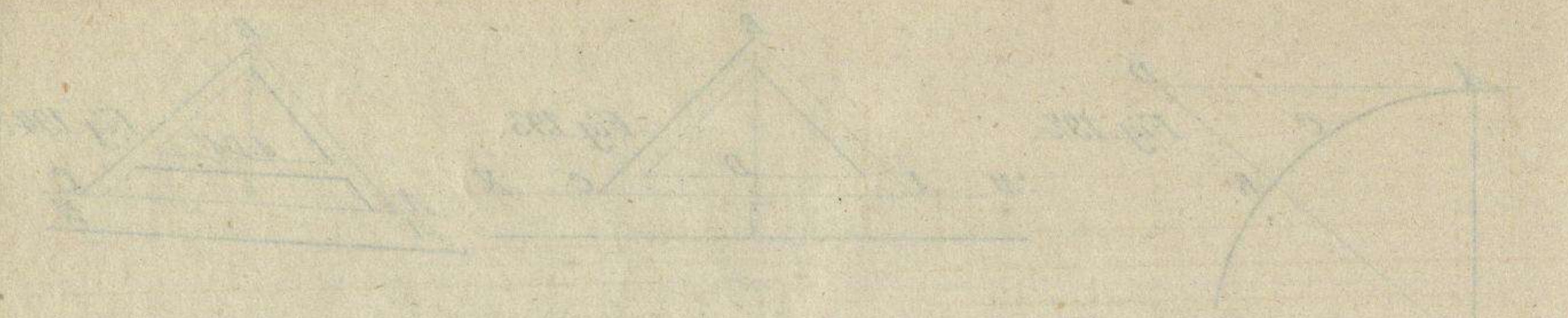

Fig. 207.

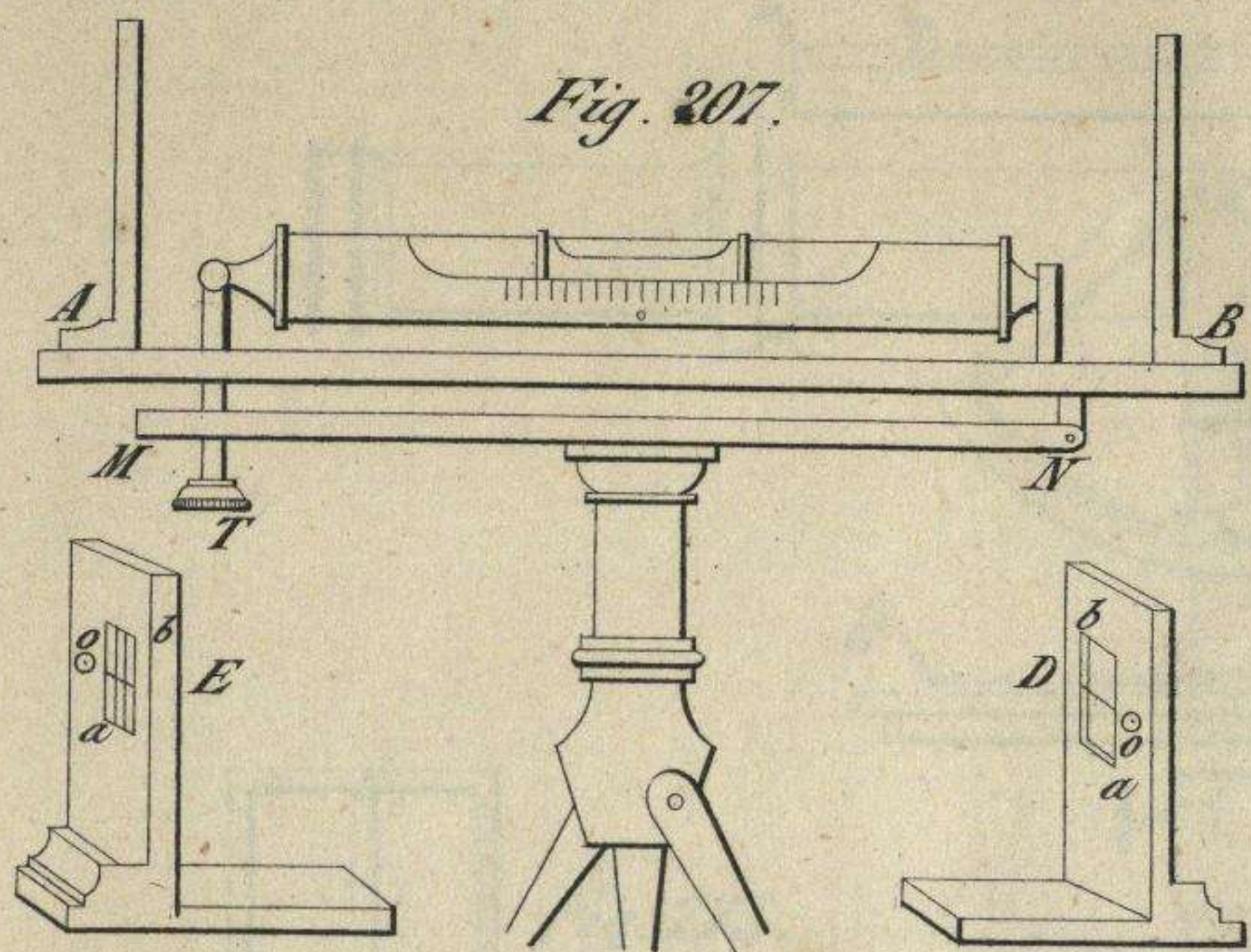

Fig. 208.

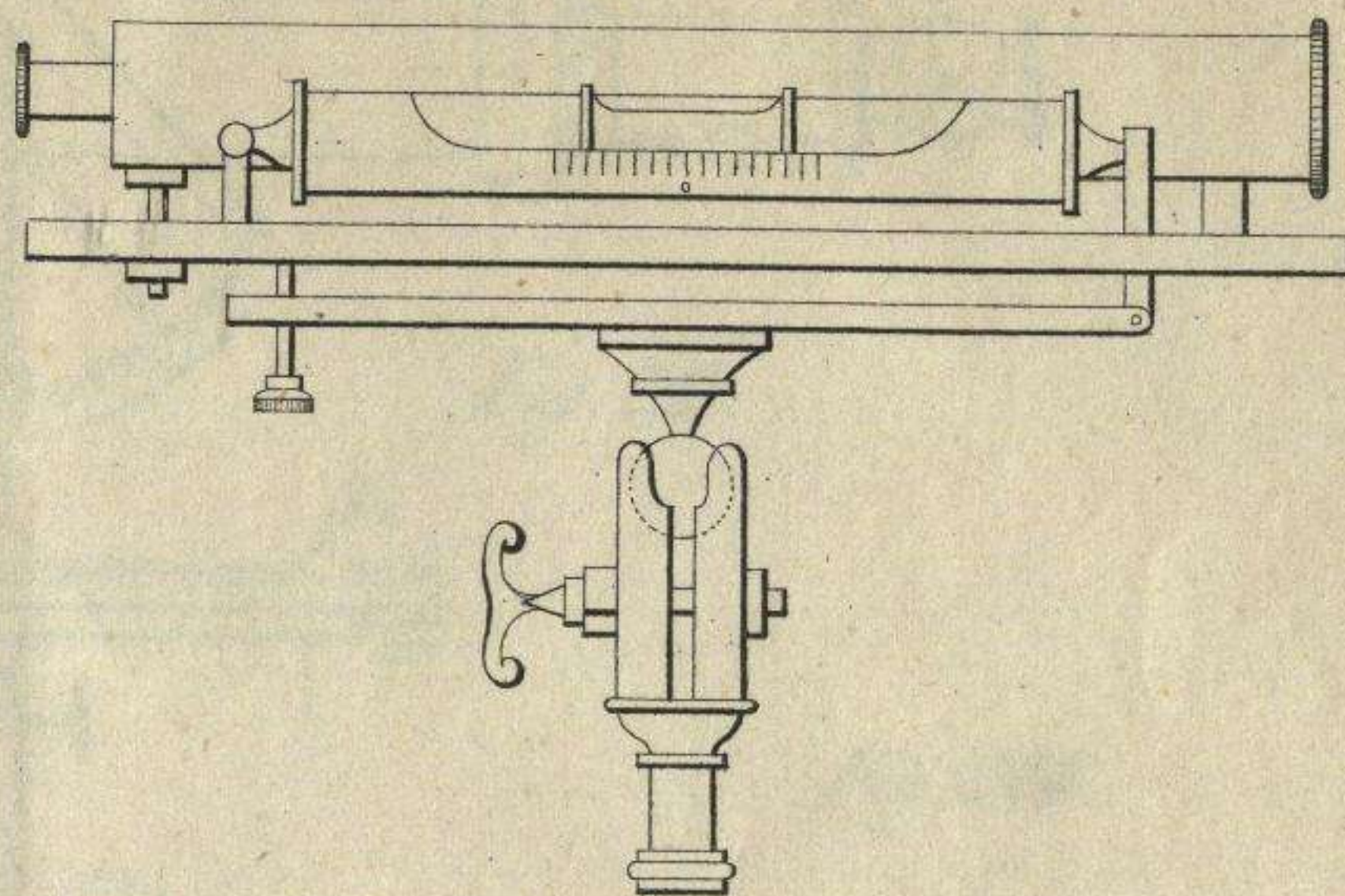
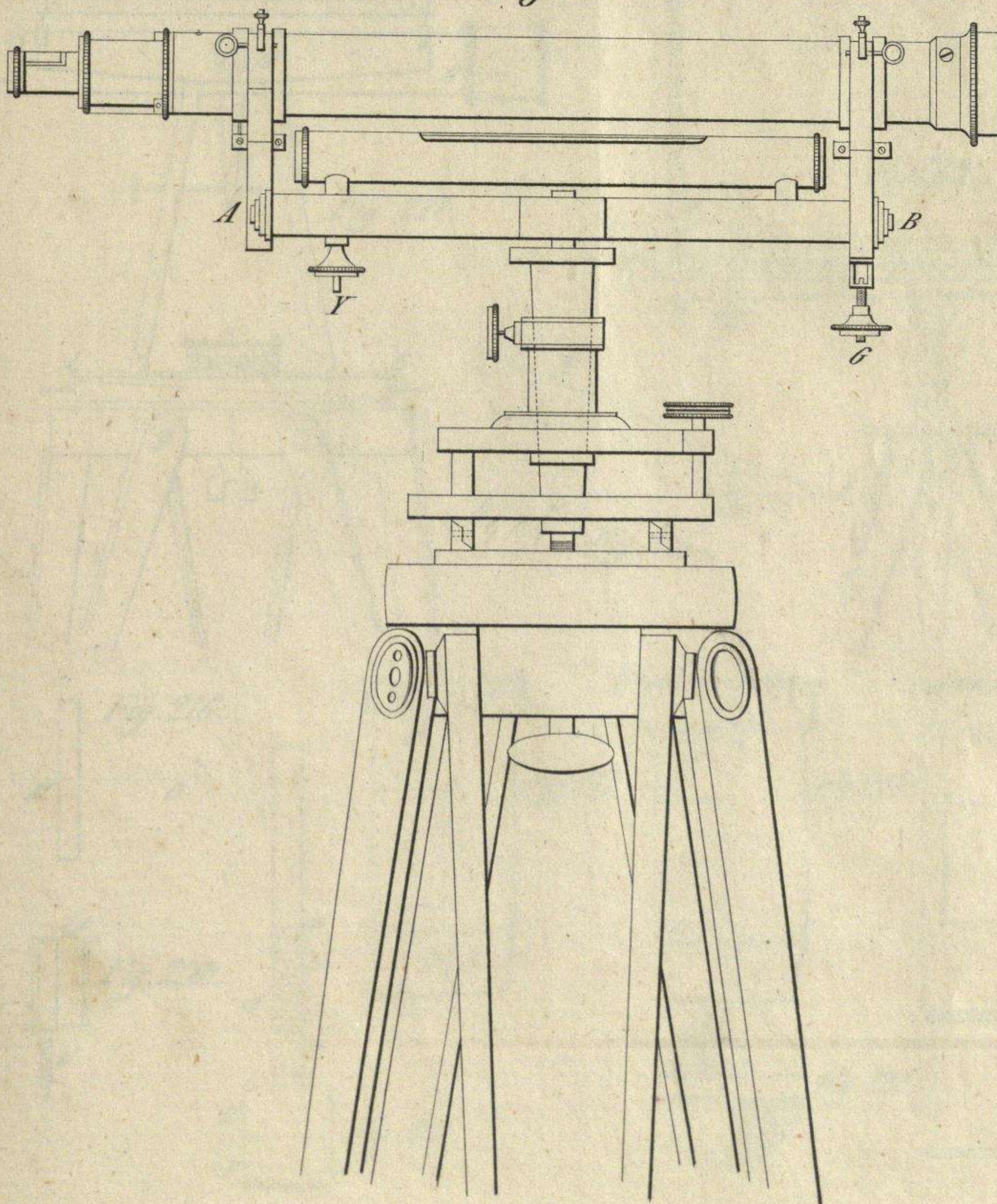
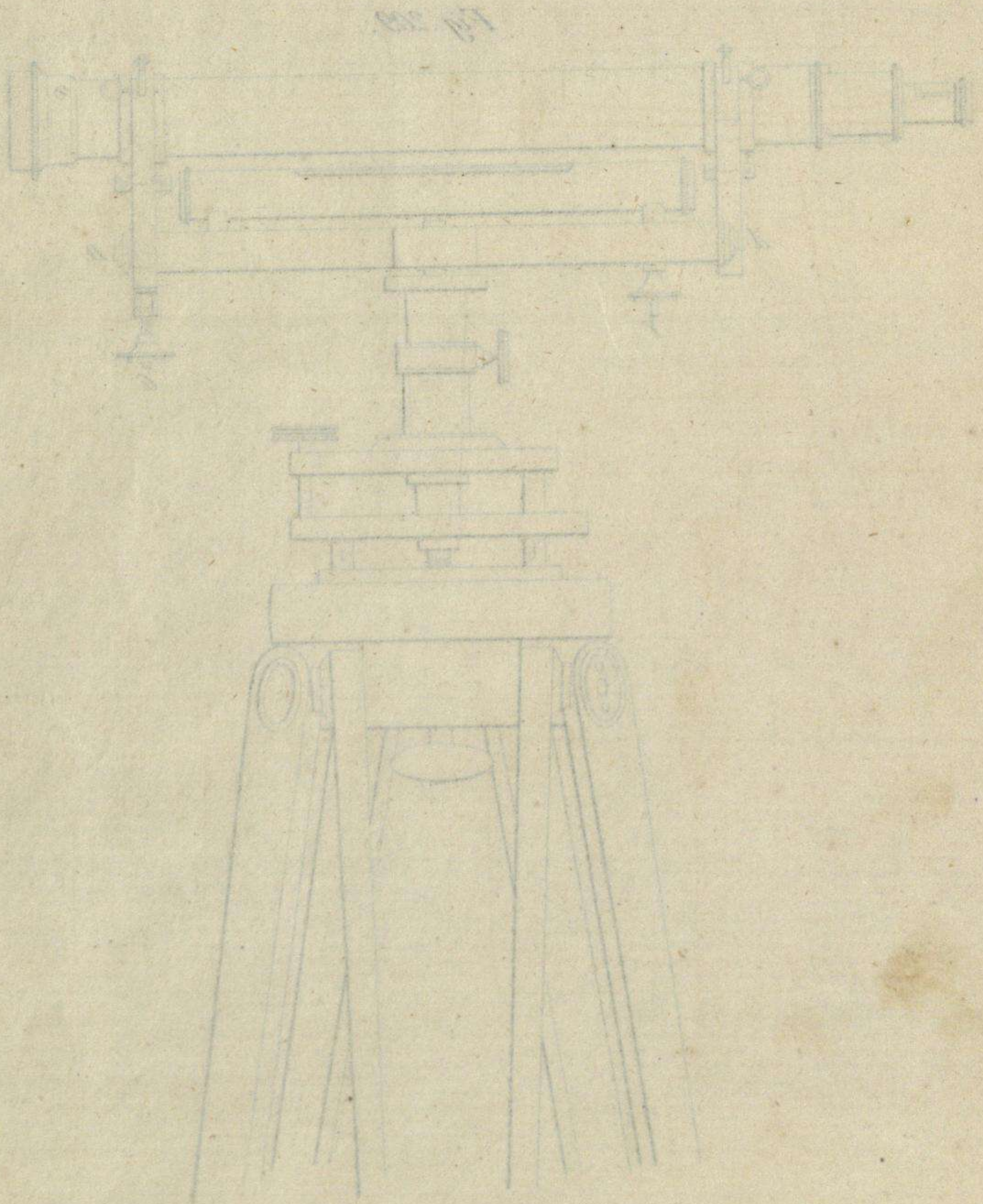
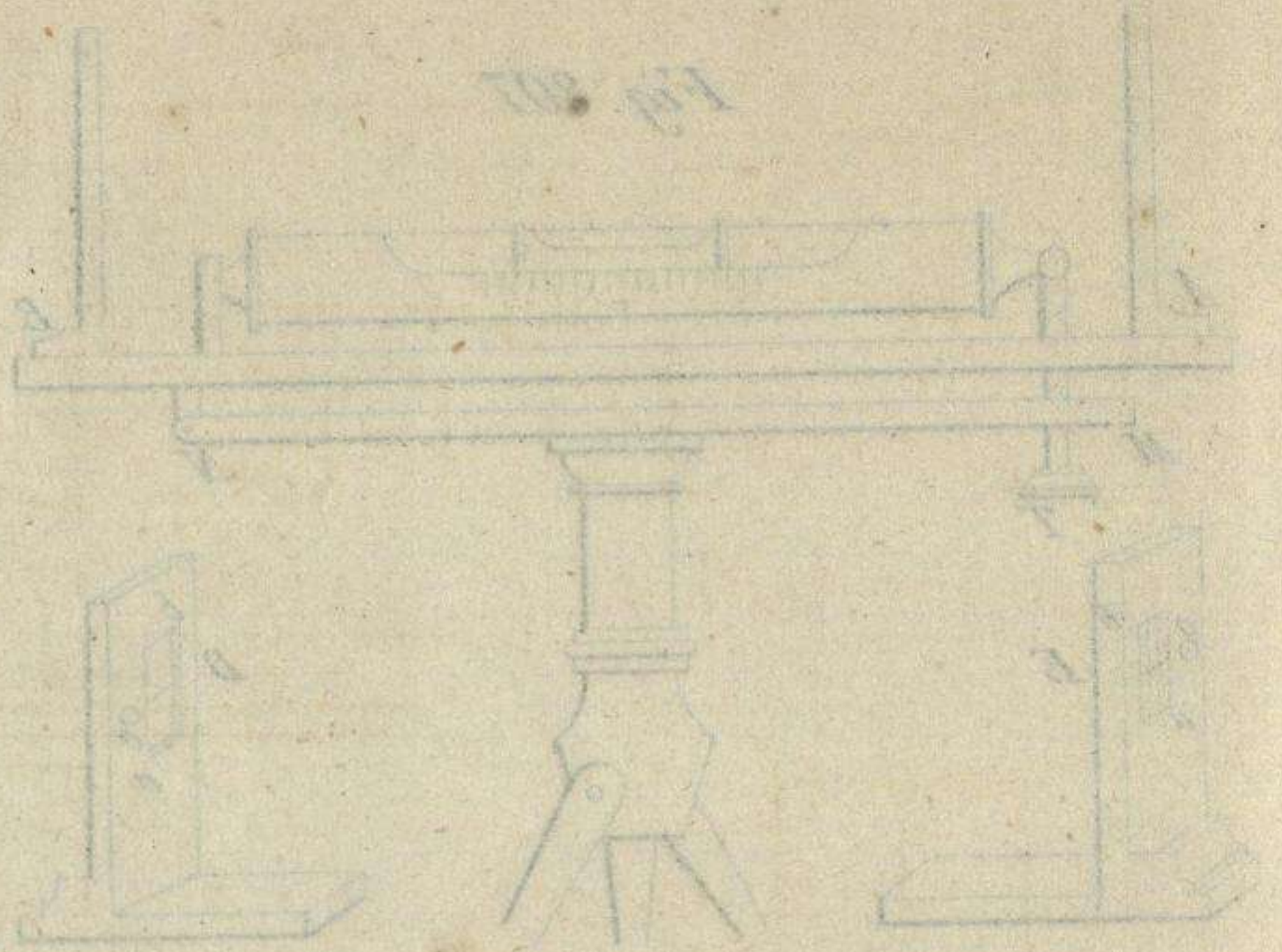
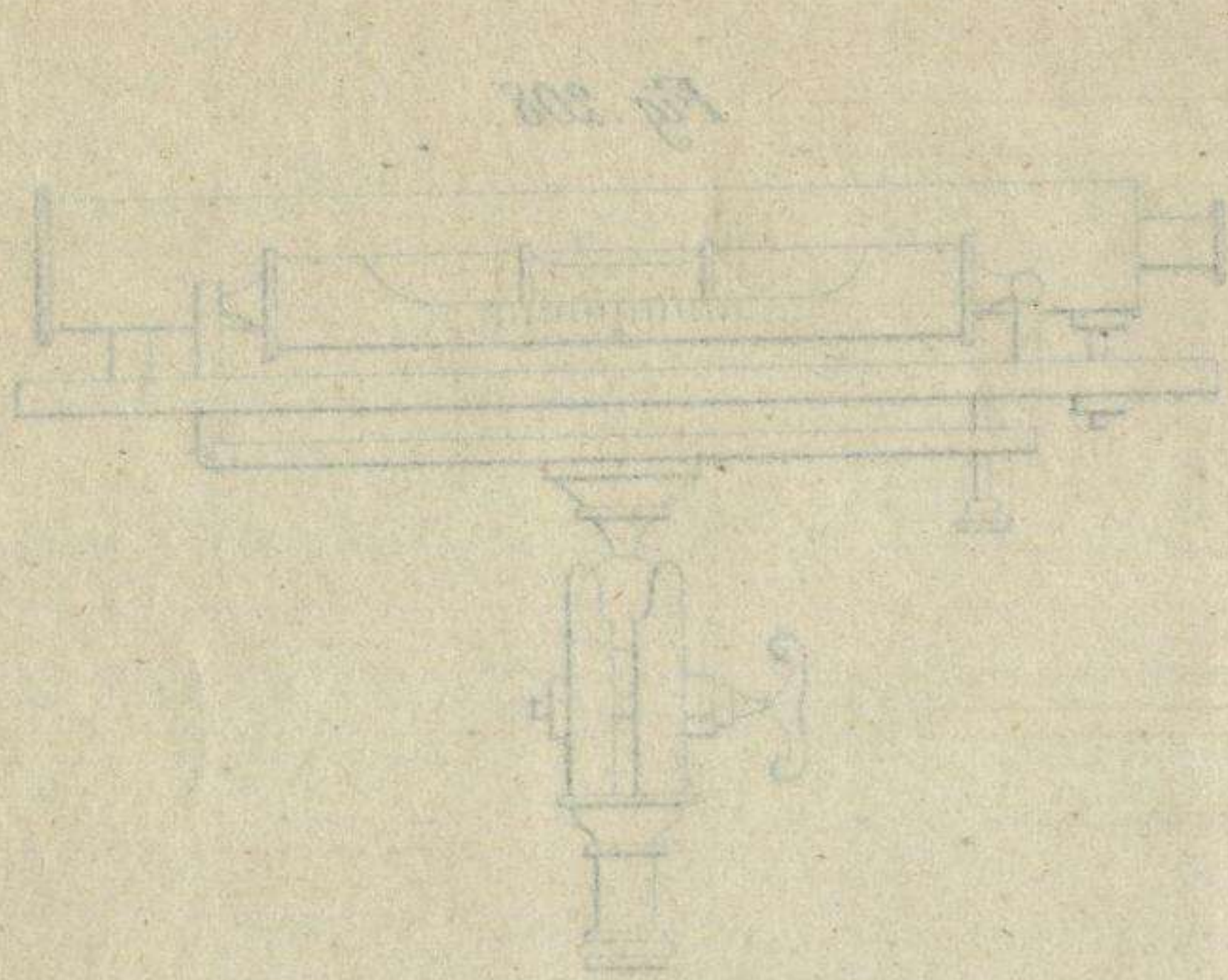

Fig. 209.





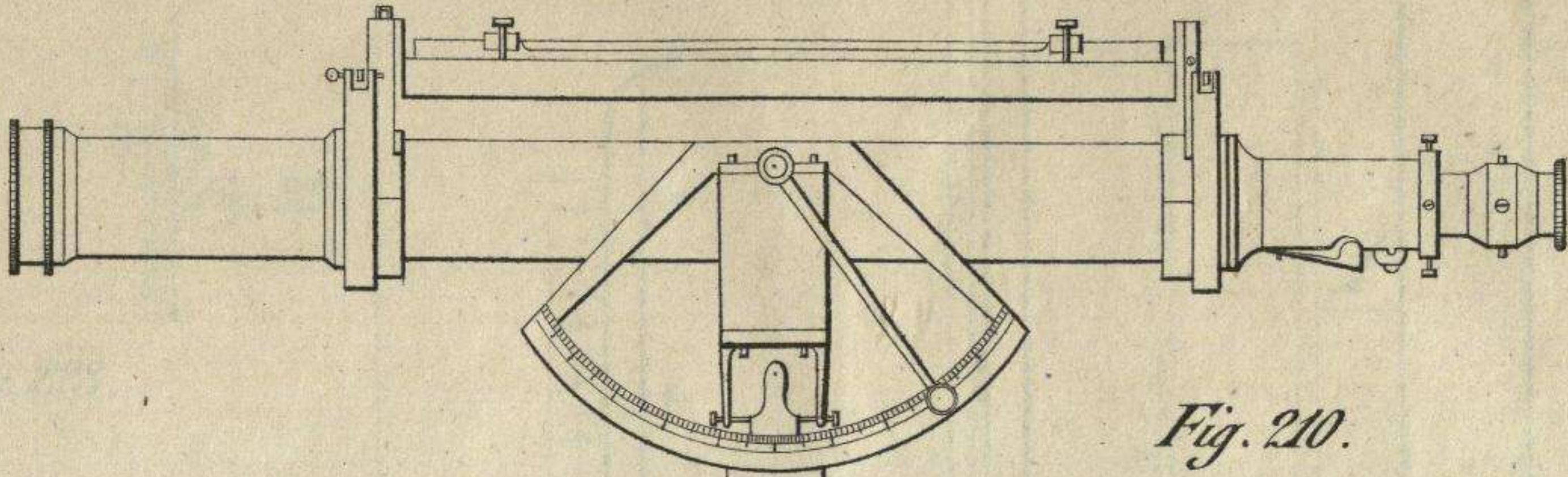

Fig. 210.

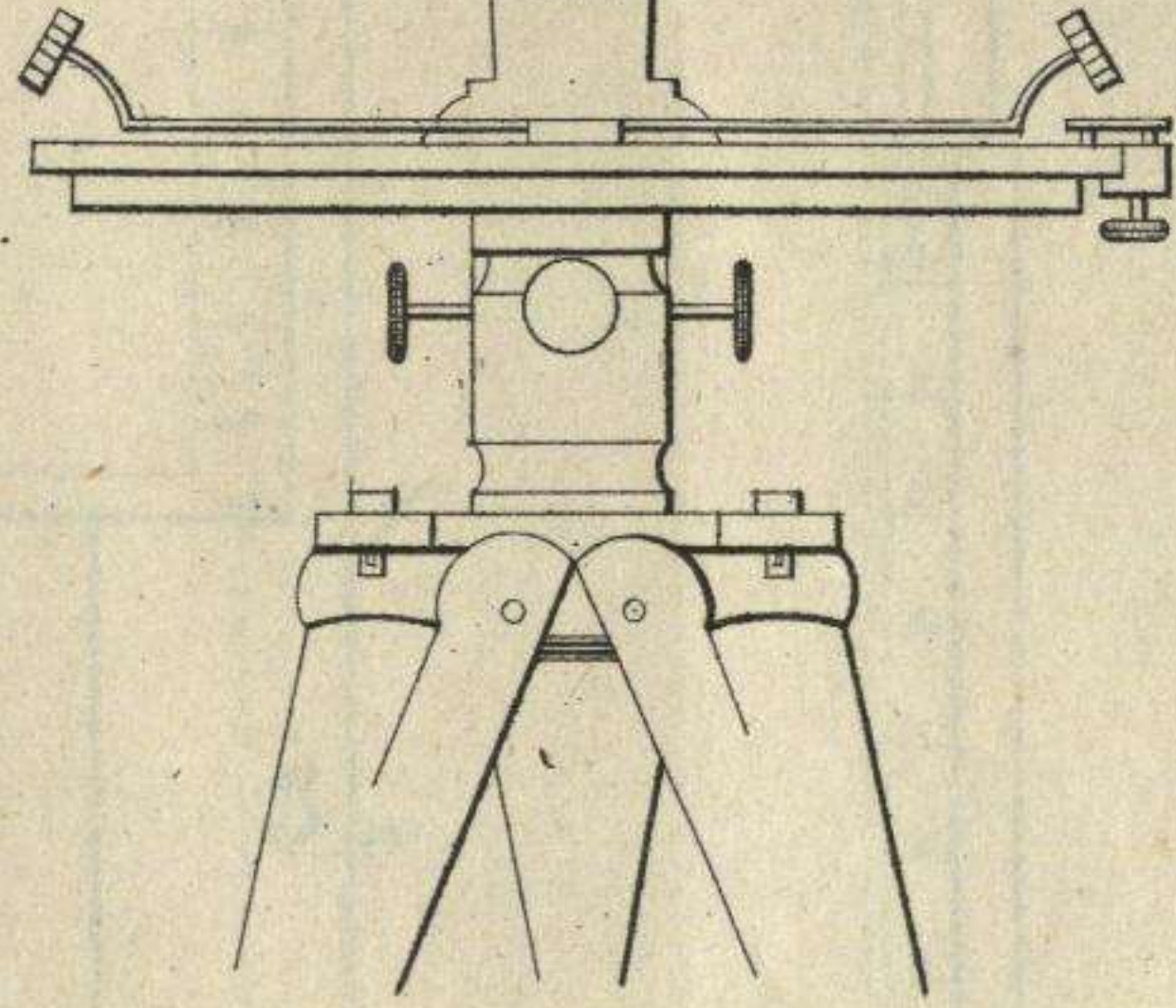

Fig. 213.

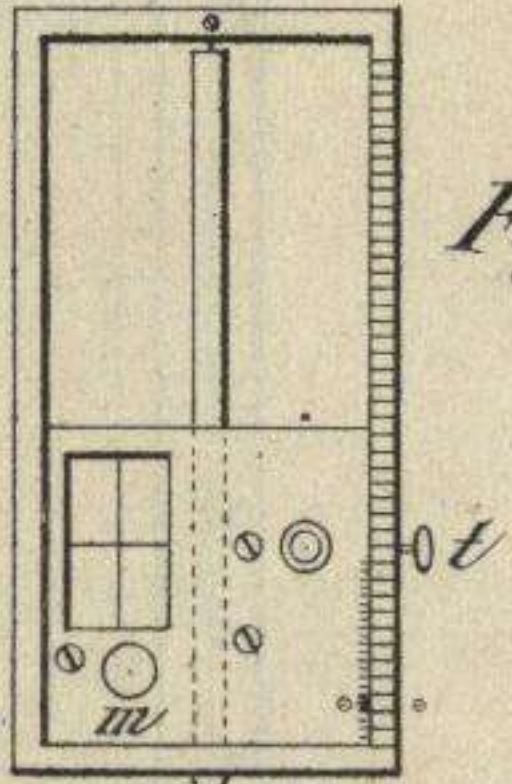

Fig. 214.

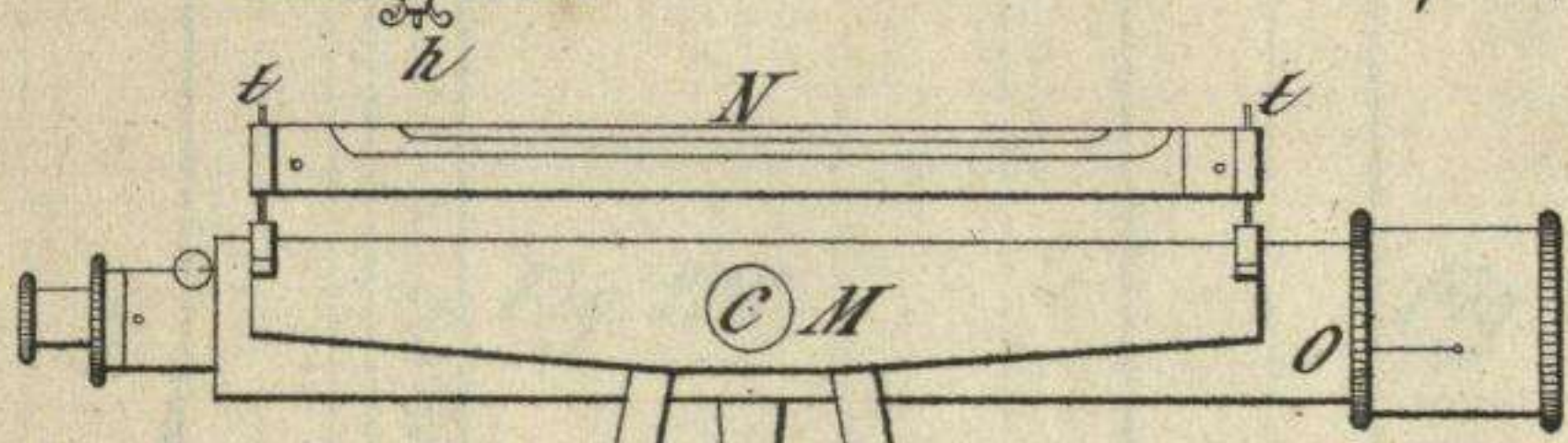
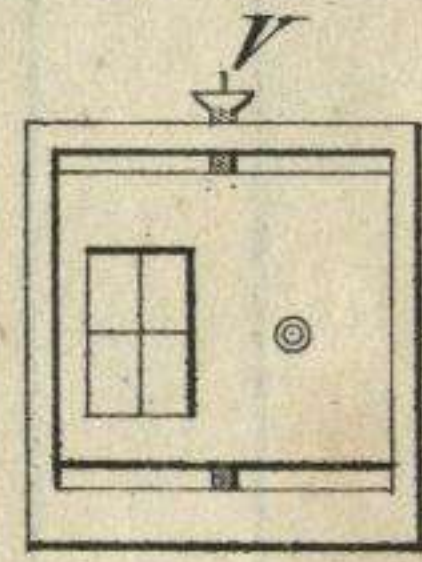

Fig. 211.

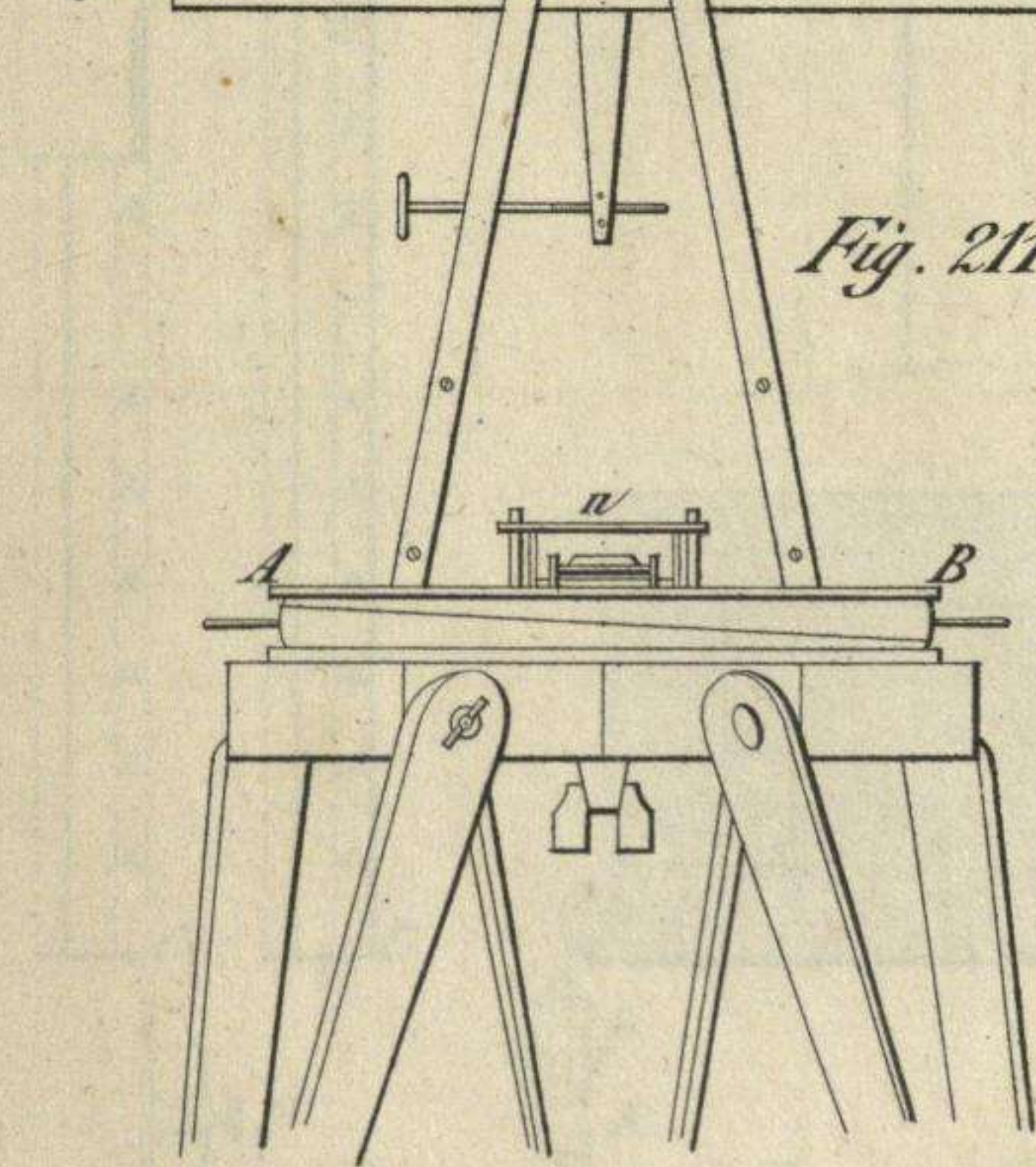

Fig. 212.

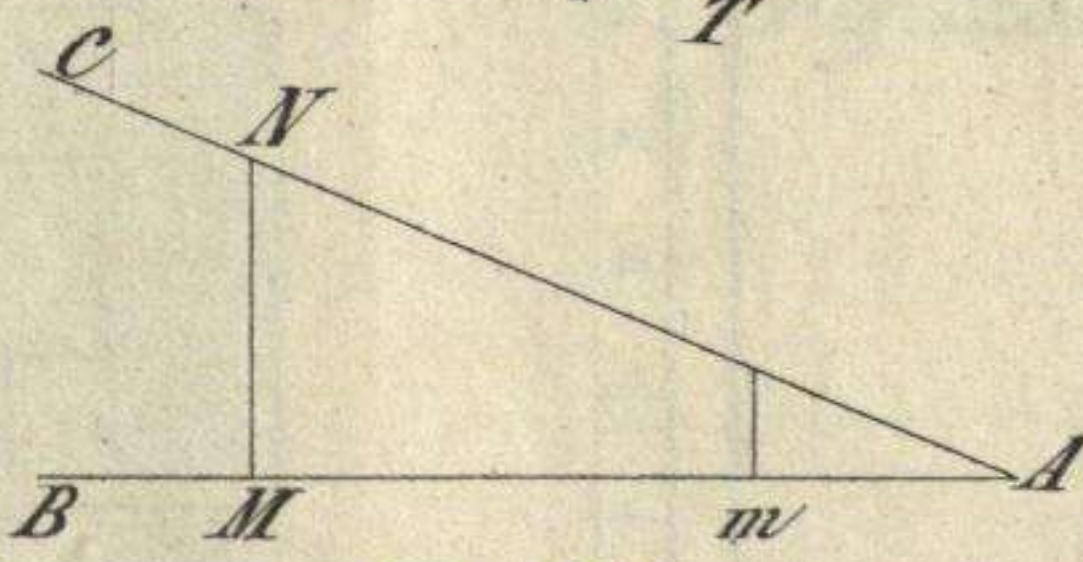
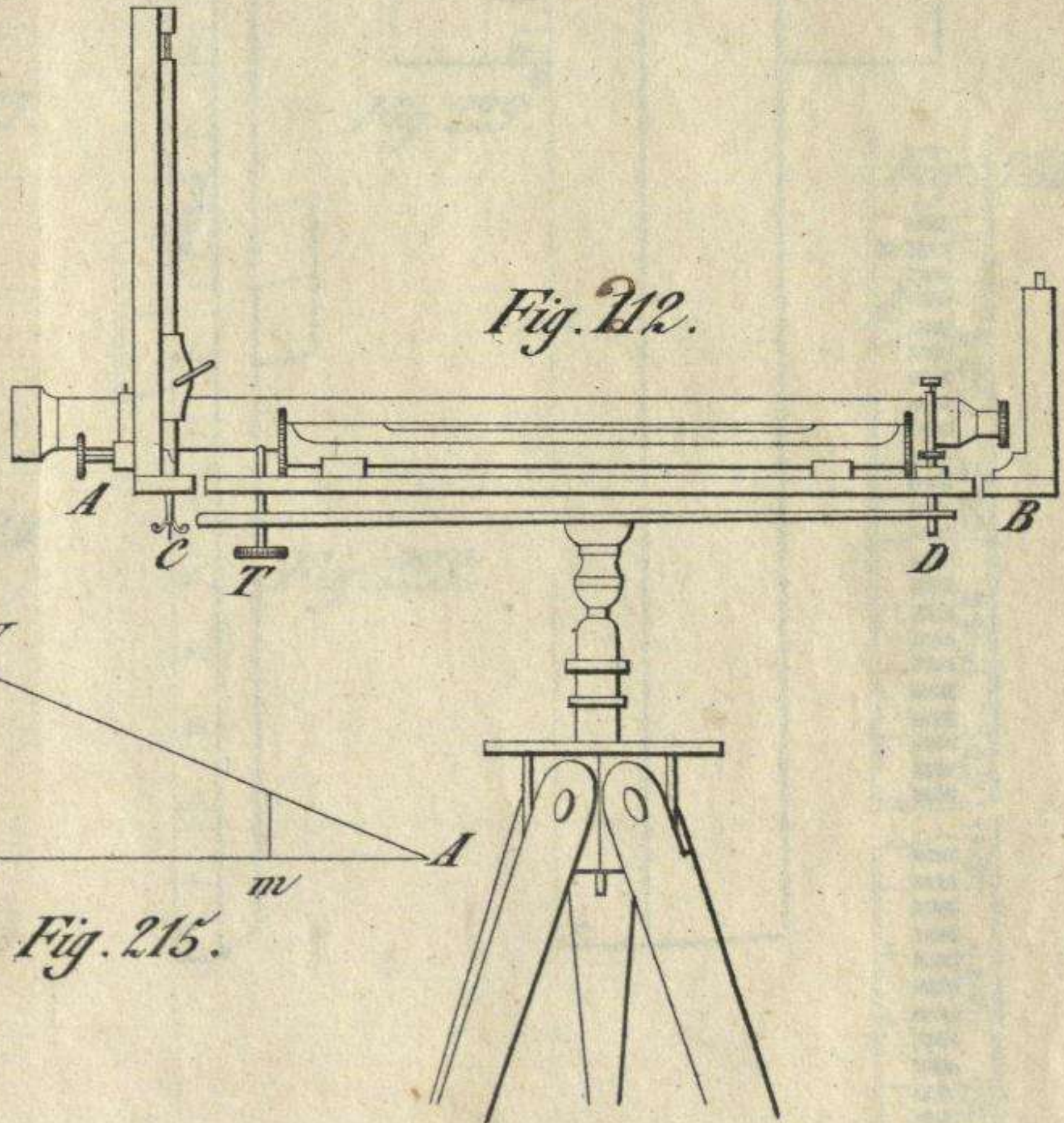

Fig. 215.

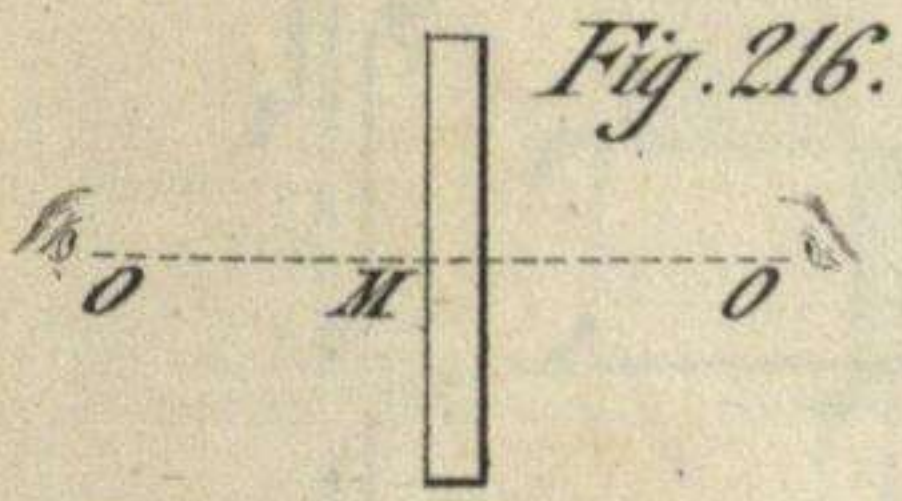

Fig. 216.

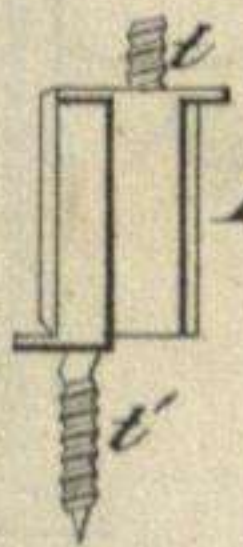

Fig. 220.

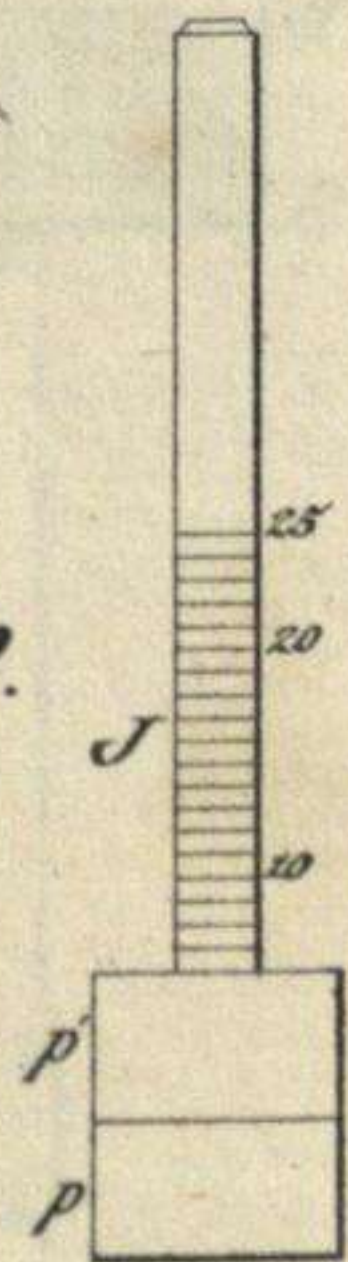

Fig. 221.

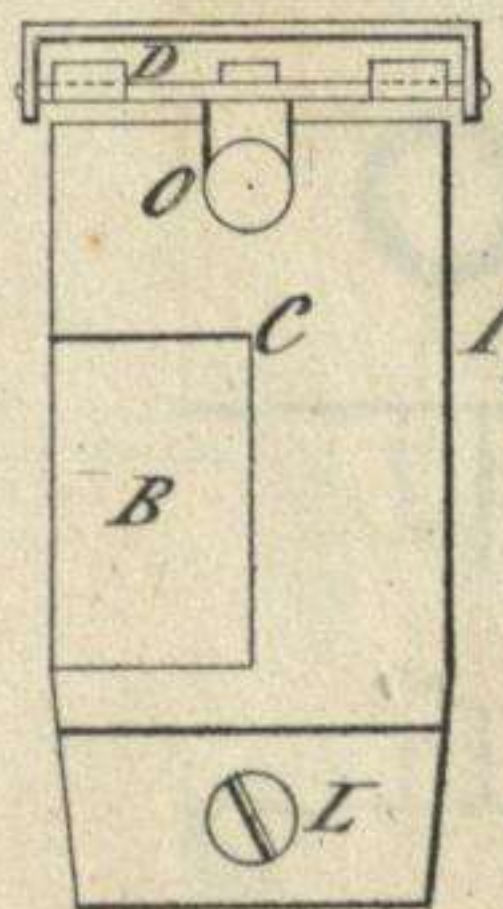

Fig. 217.

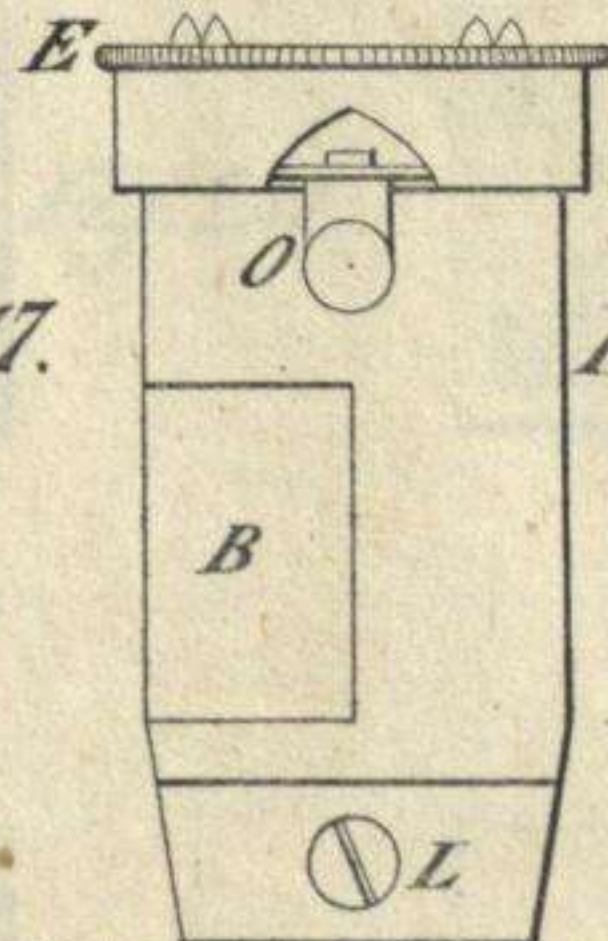

Fig. 218.

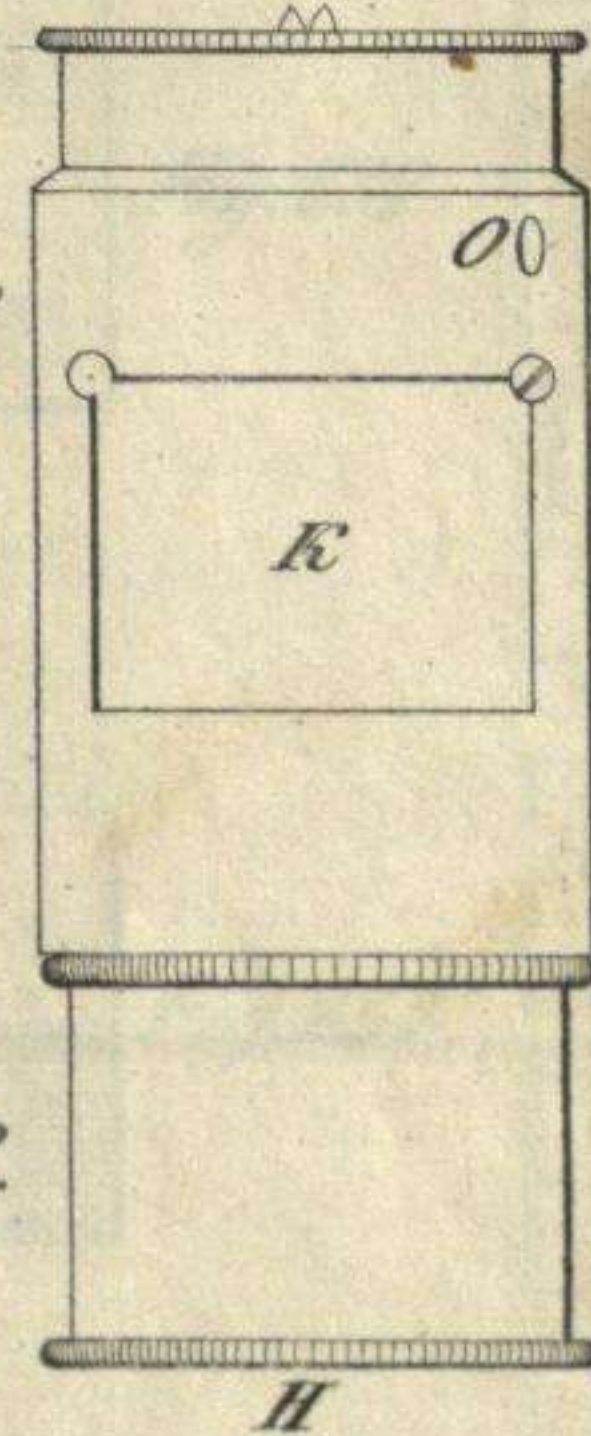

Fig. 219.

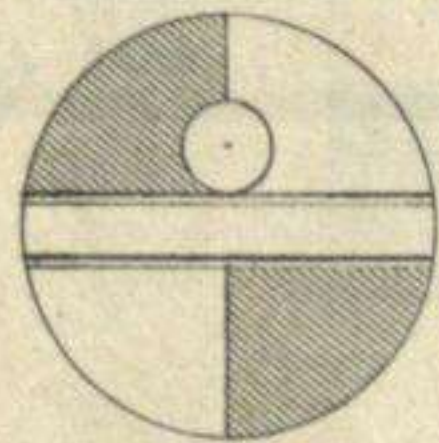

Fig. 222.

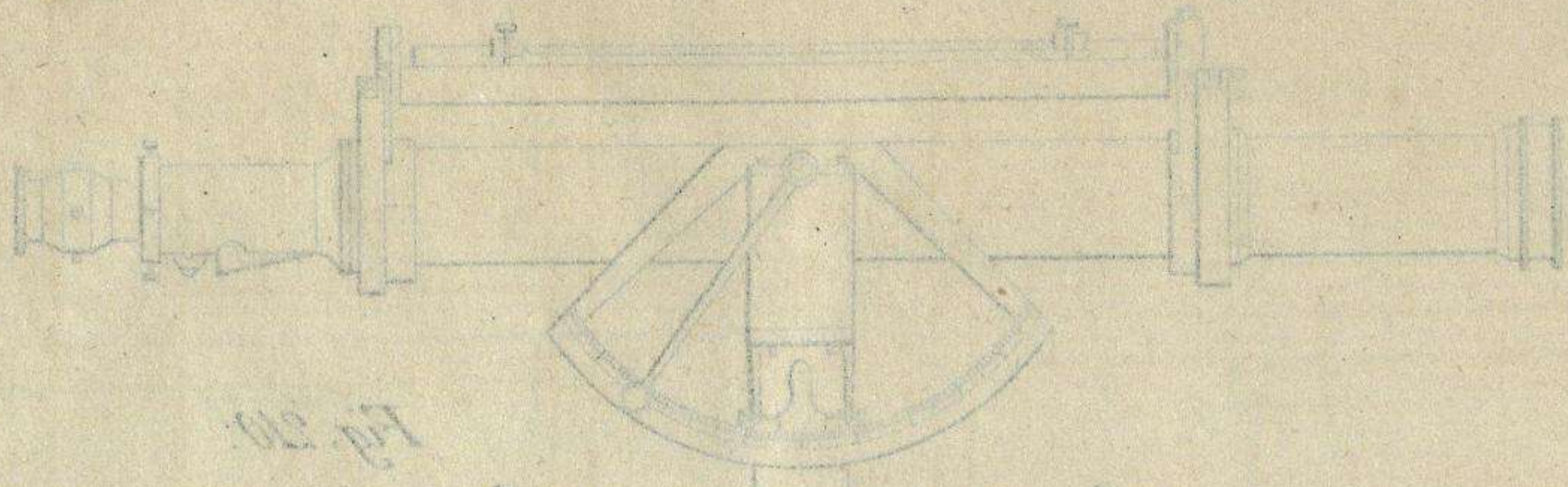

Fig. 20

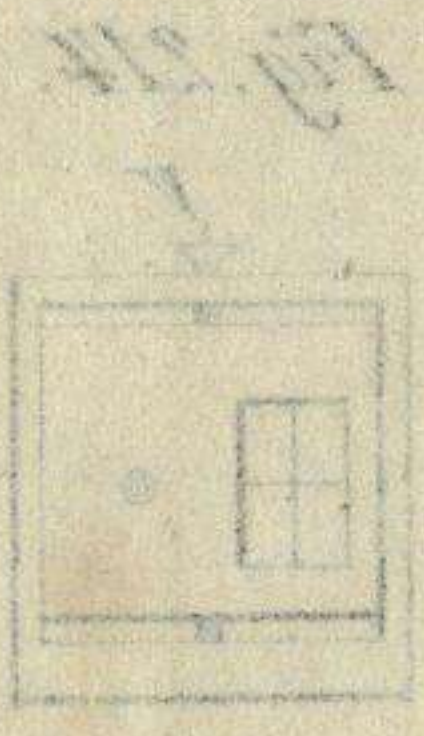

Fig. 21

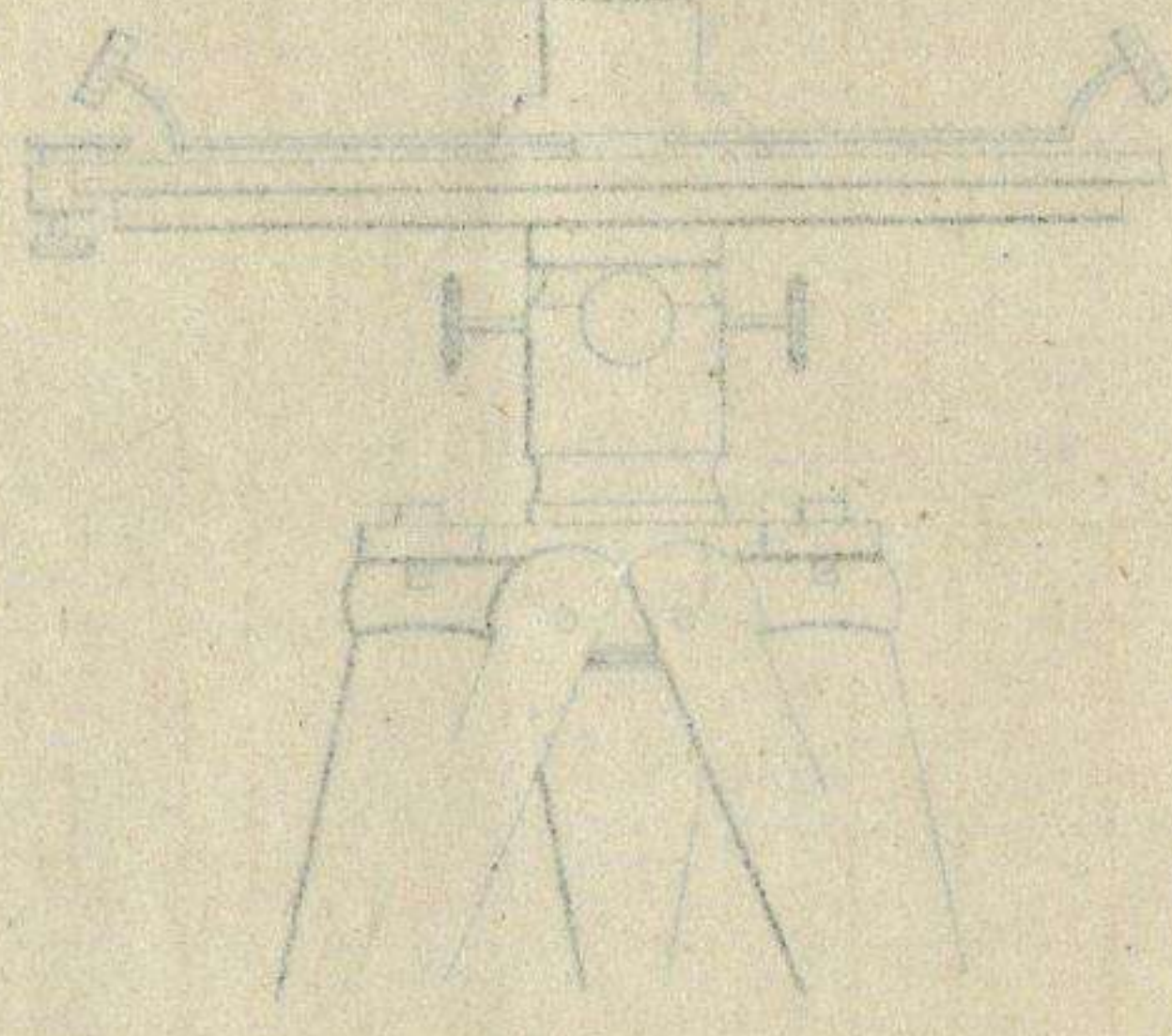

Fig. 22

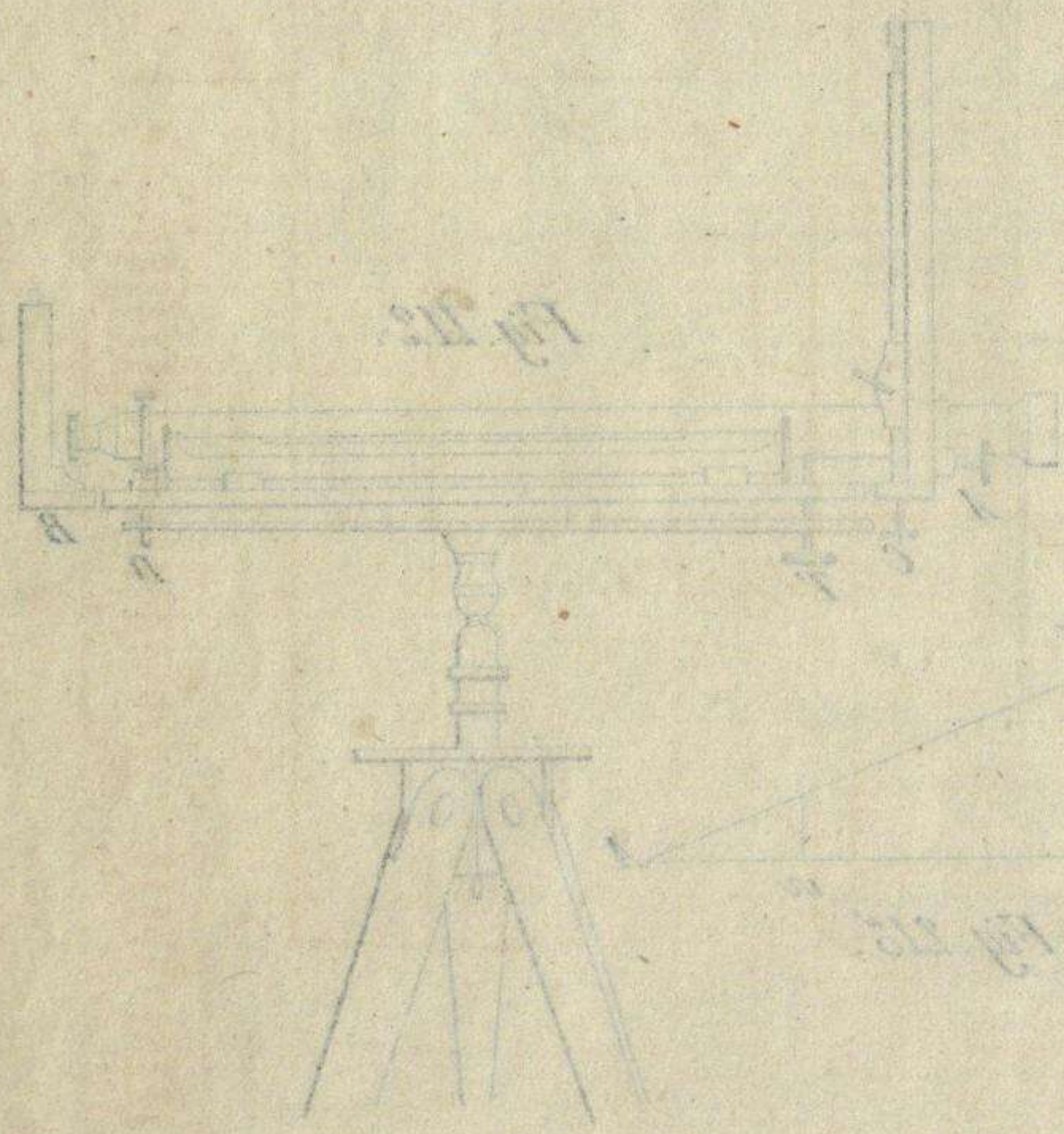

Fig. 24

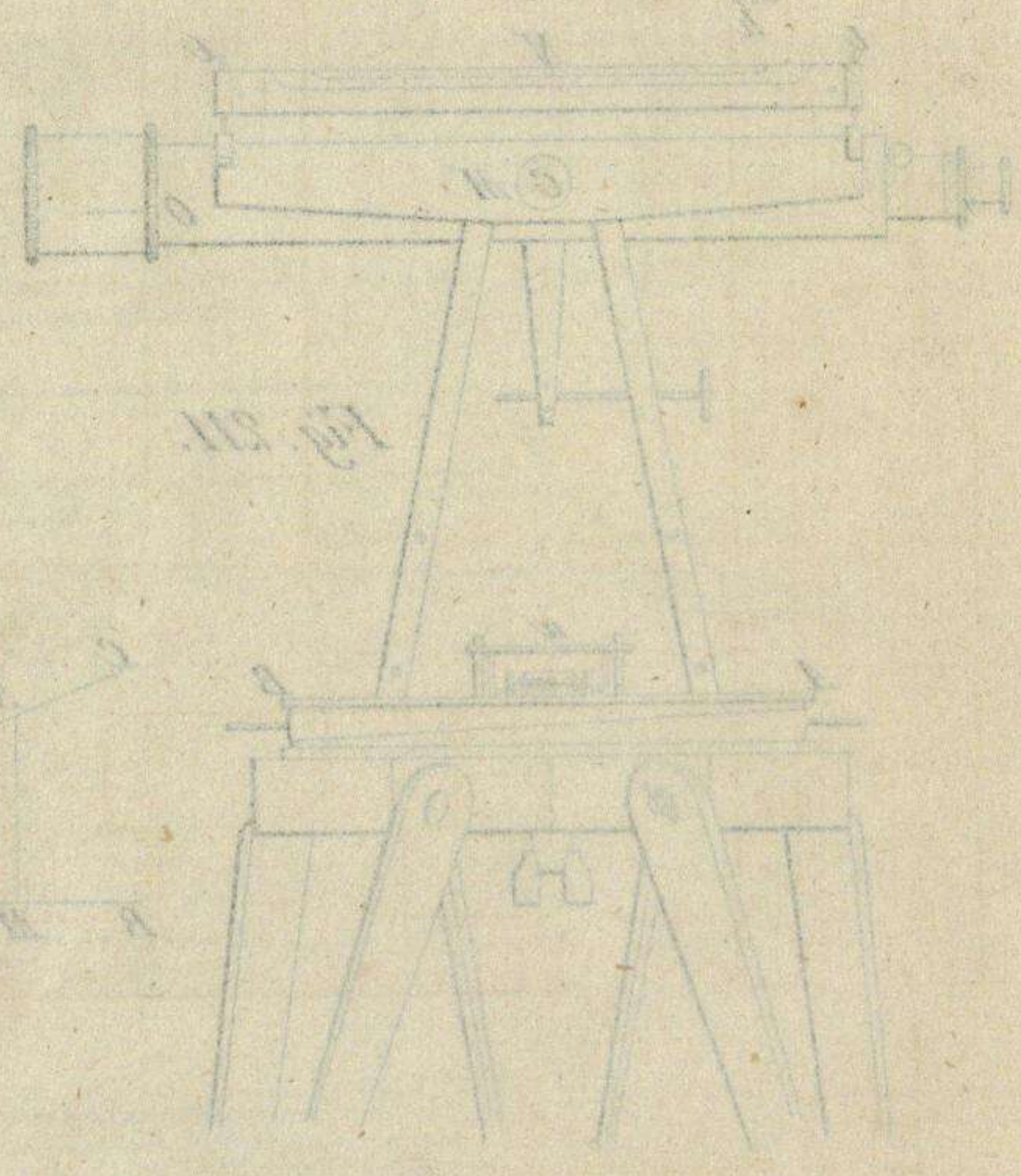

Fig. 25

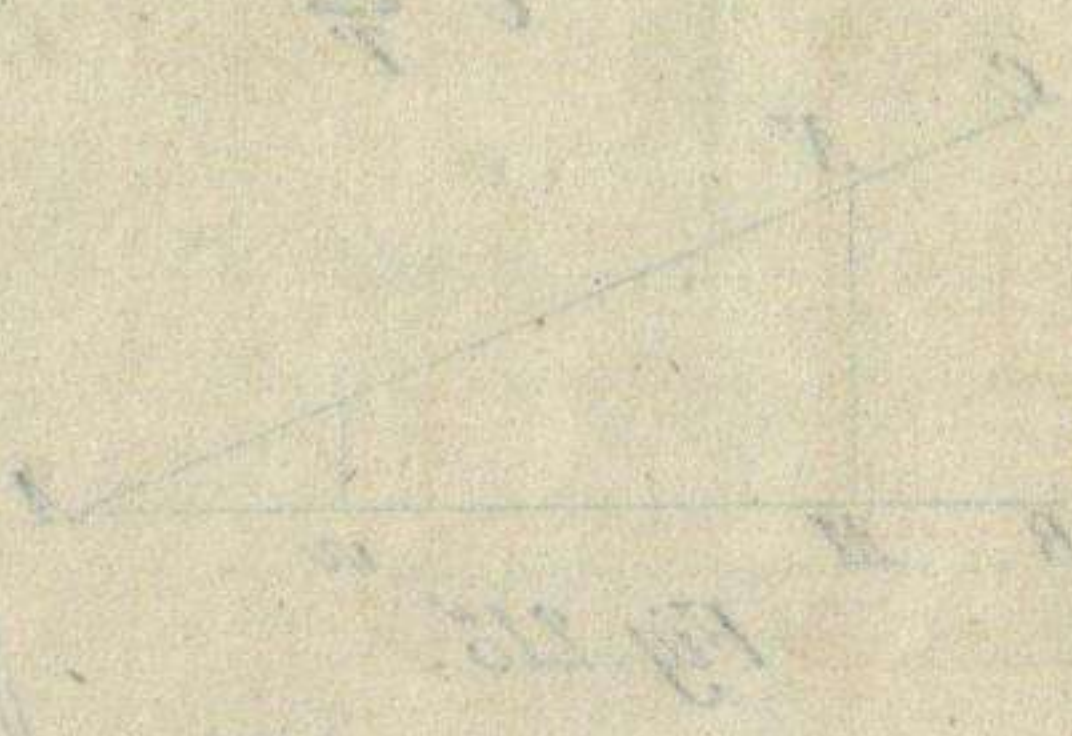

Fig. 26

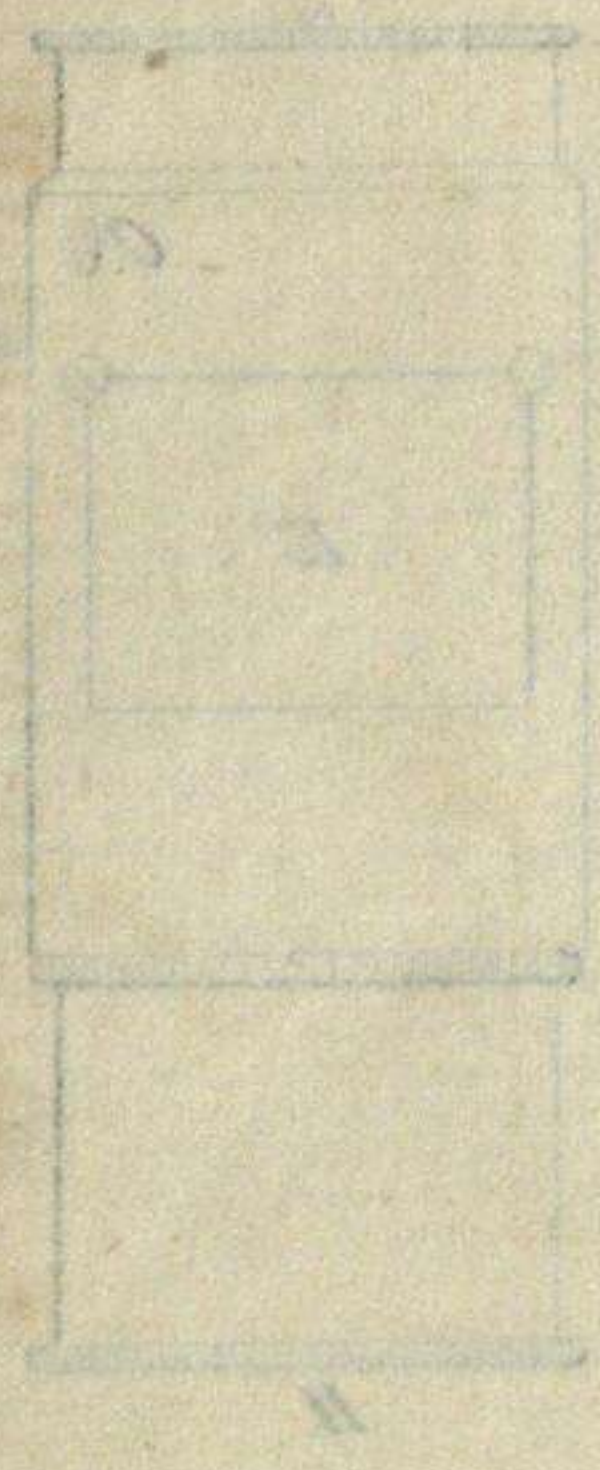

Fig. 27

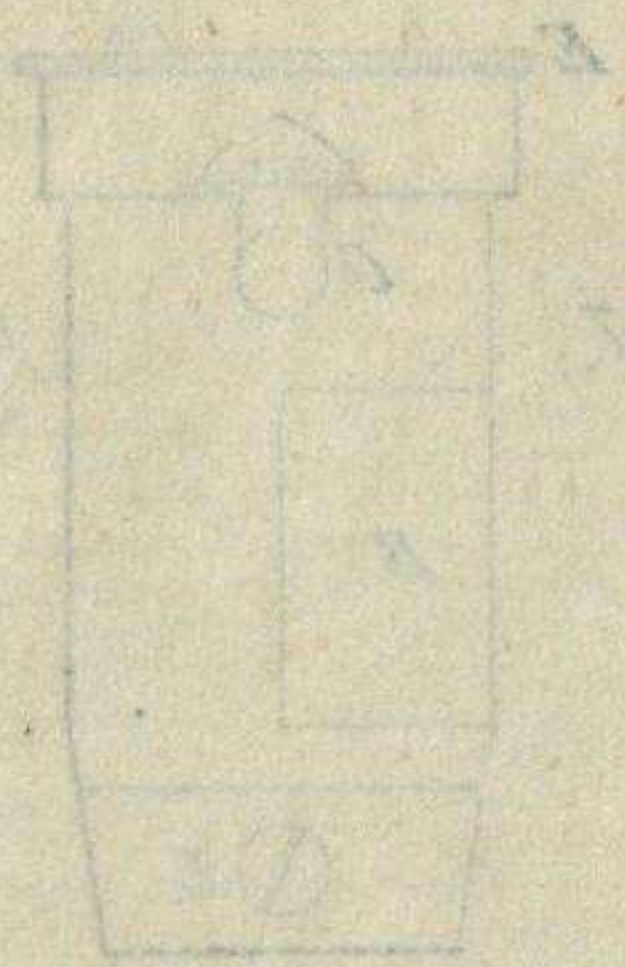

Fig. 28

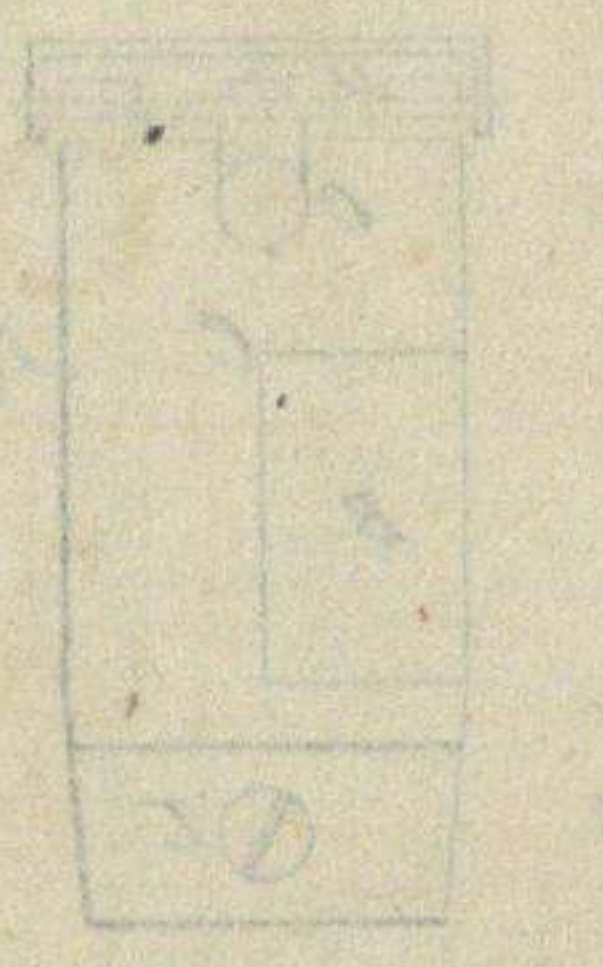

Fig. 29

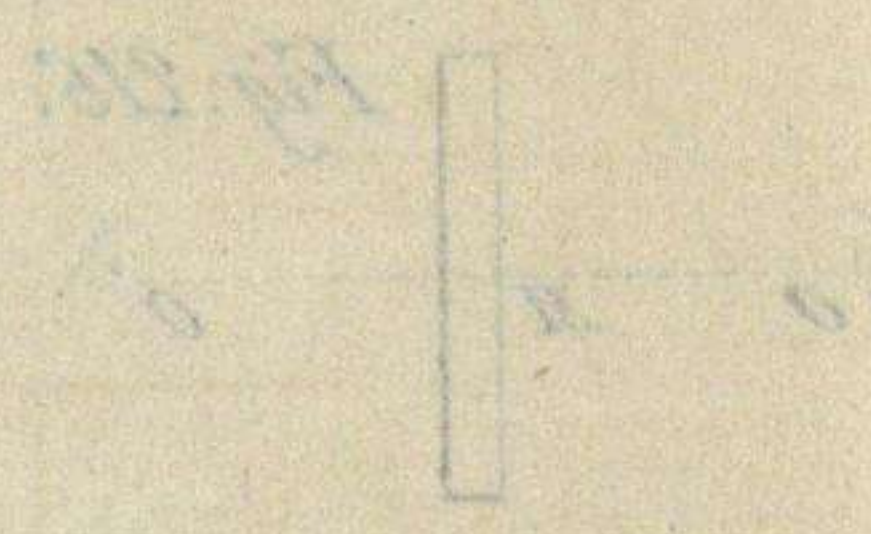

Fig. 30

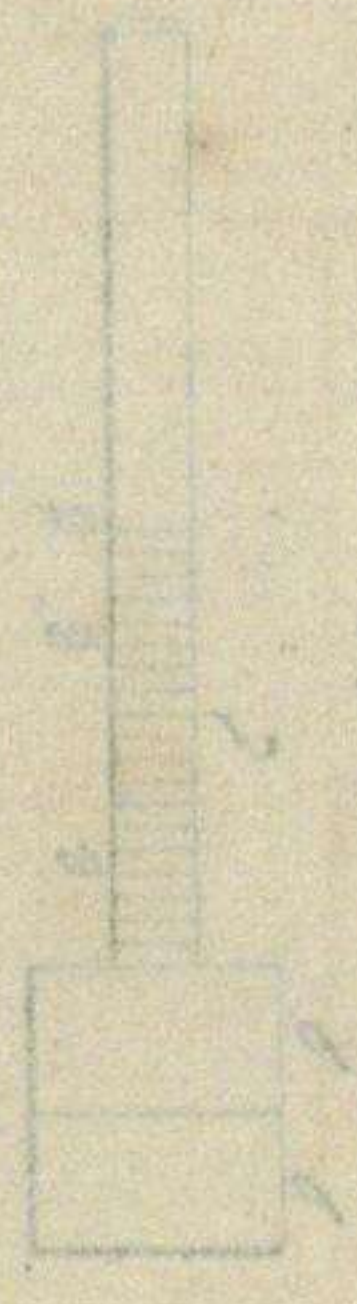

Fig. 31

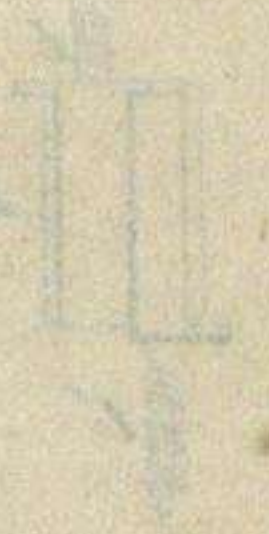

Fig. 32



Fig. 33

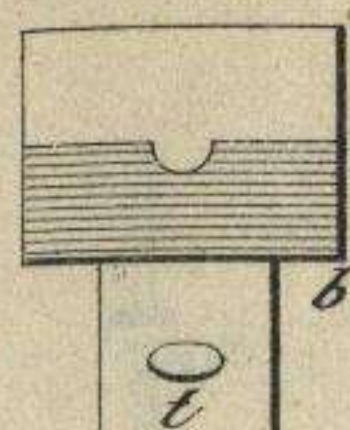

Fig. 223.

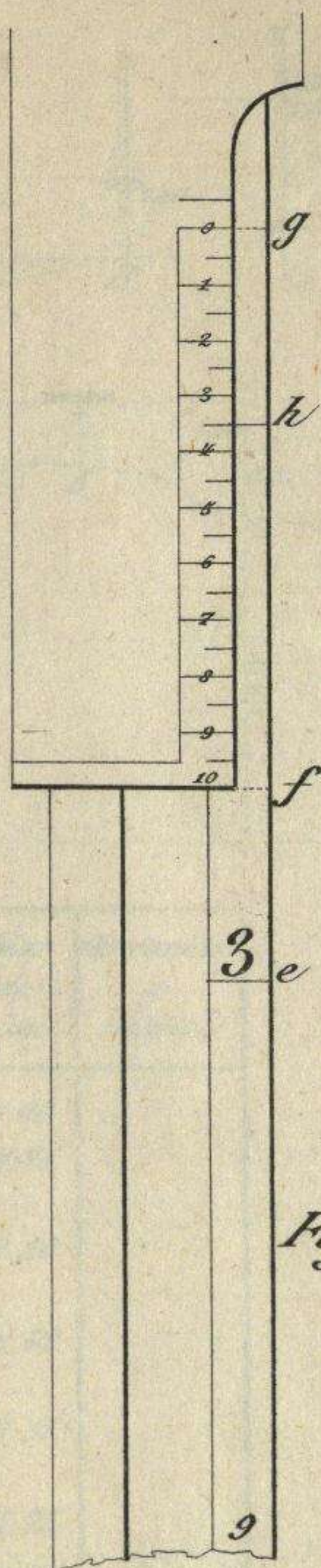

Fig. 227.

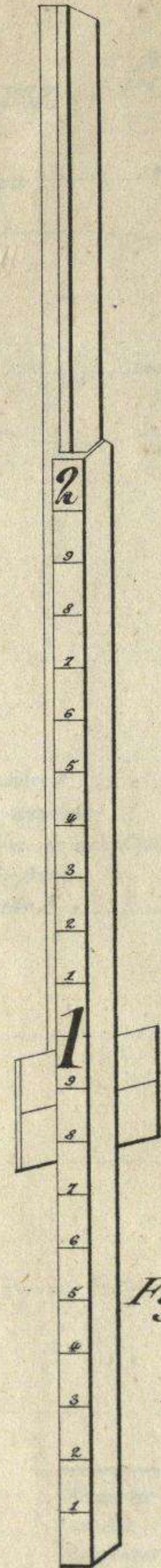

Fig. 228.

Fig. 229.

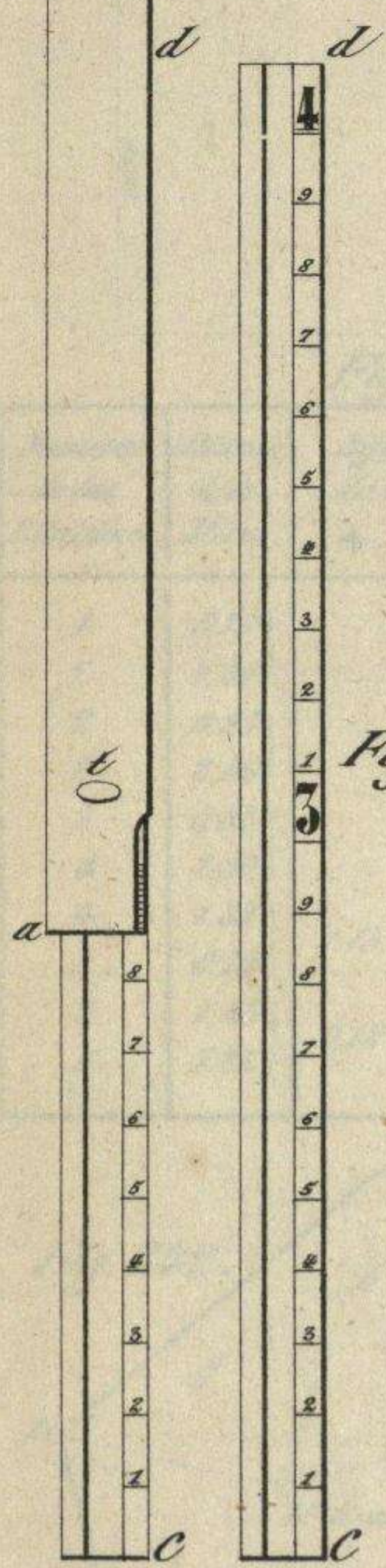
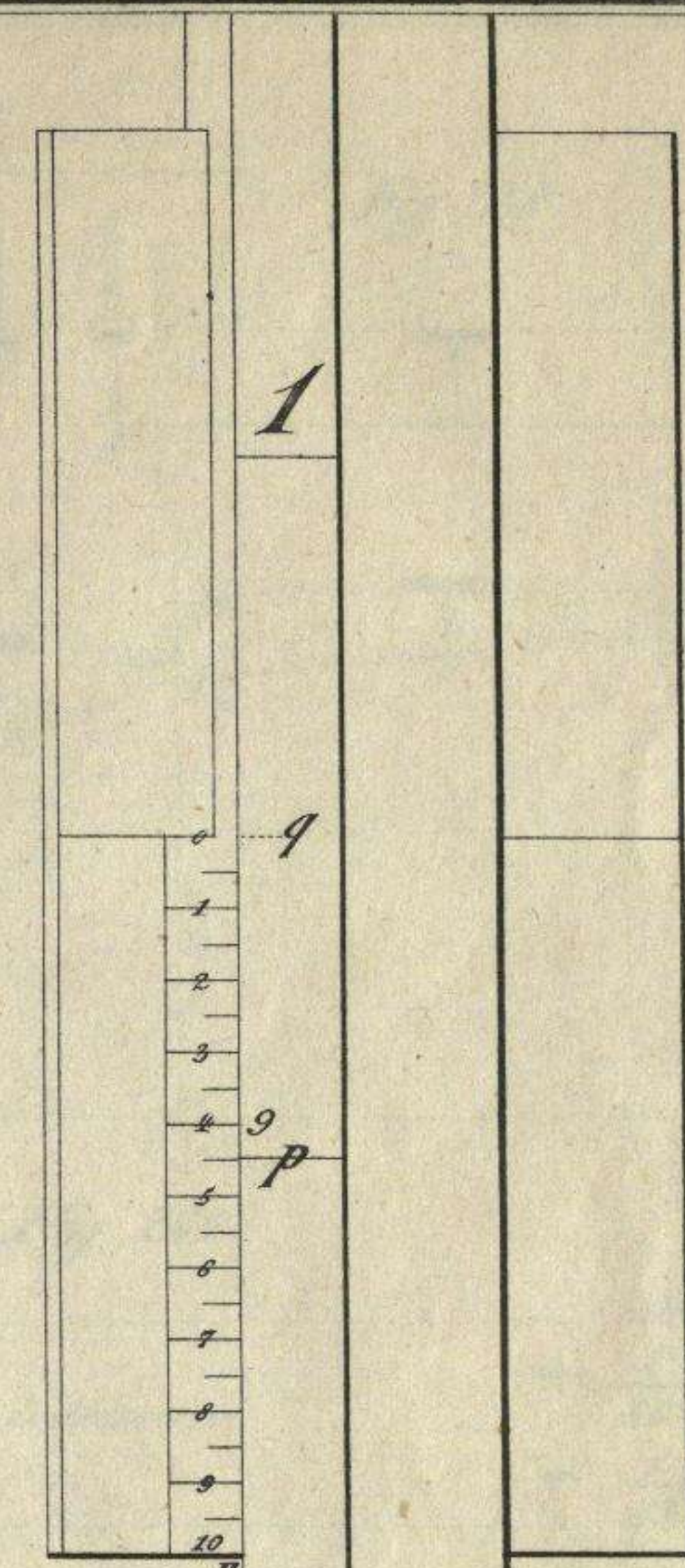

Fig. 226.

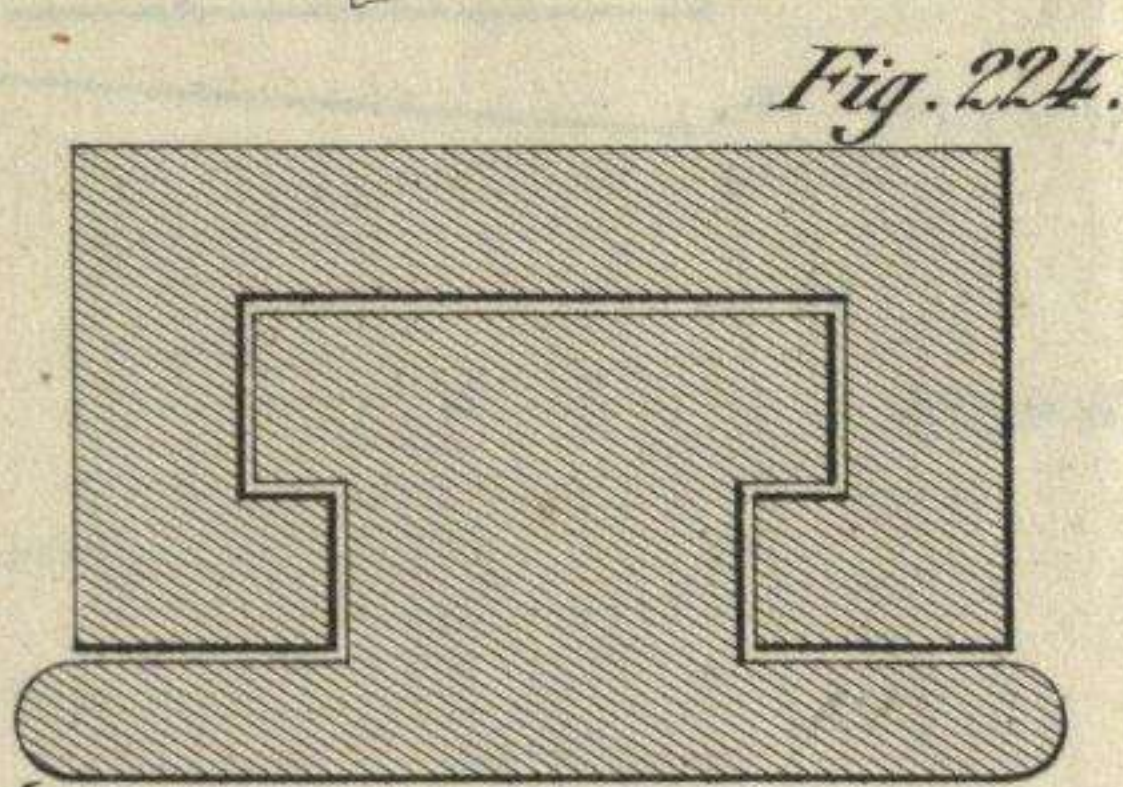

Fig. 224.

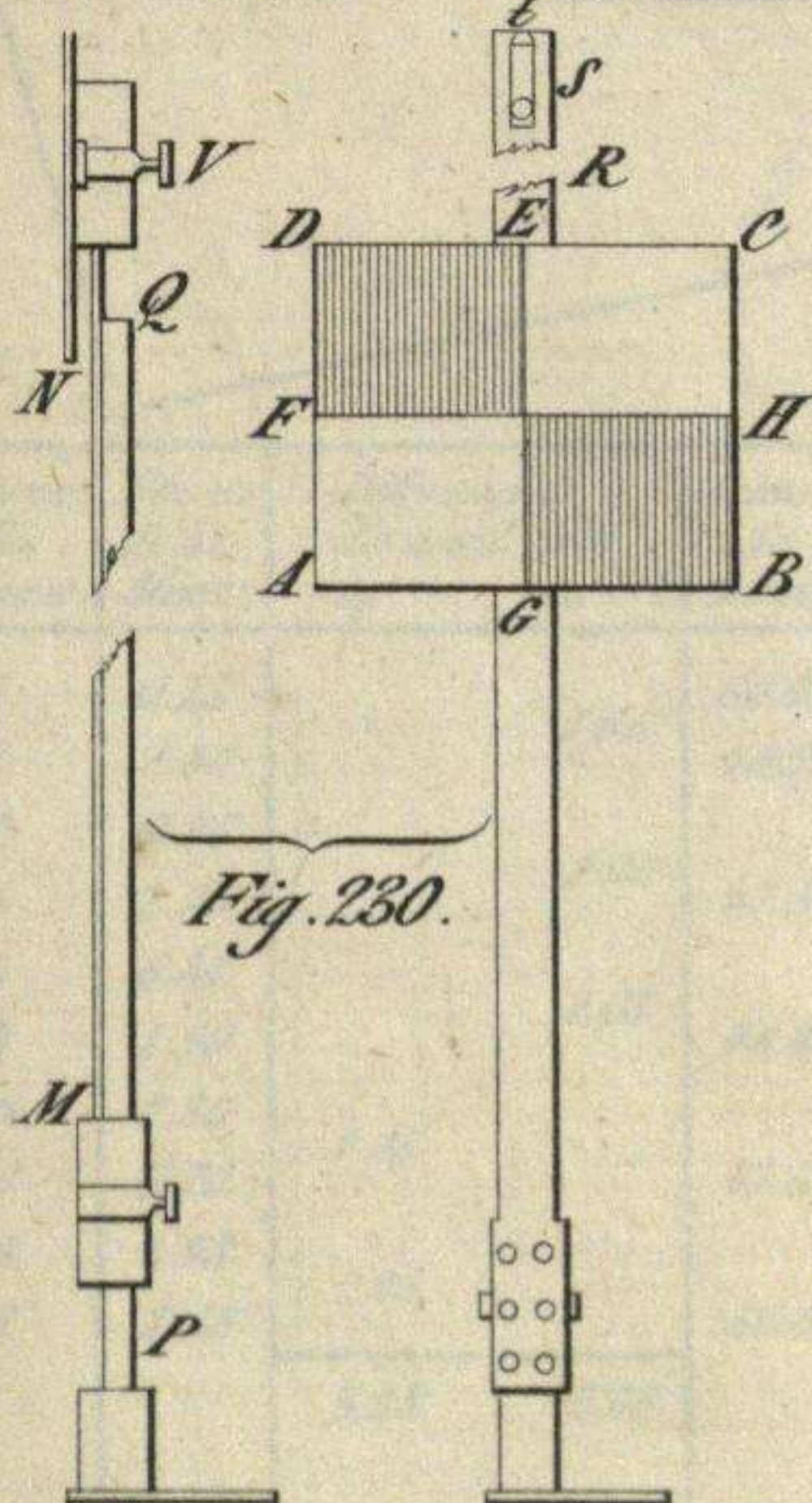
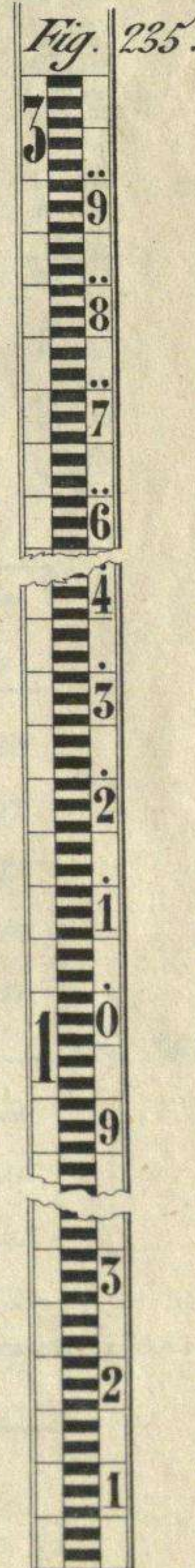

Fig. 230.

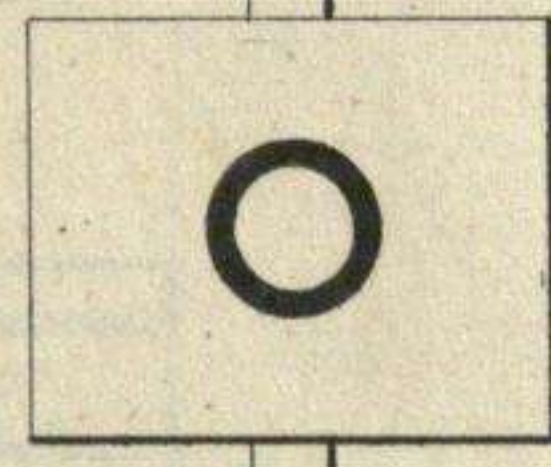

Fig. 231.

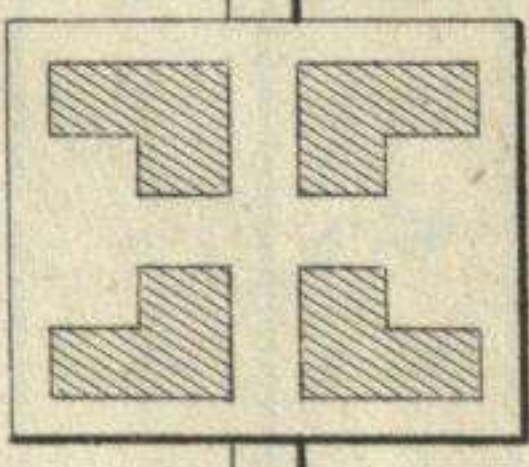

Fig. 232.

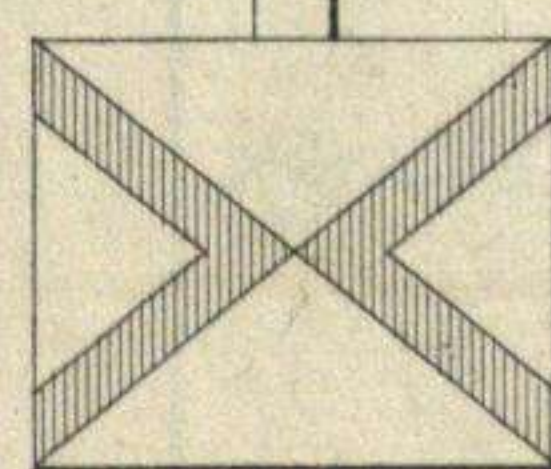

Fig. 233.

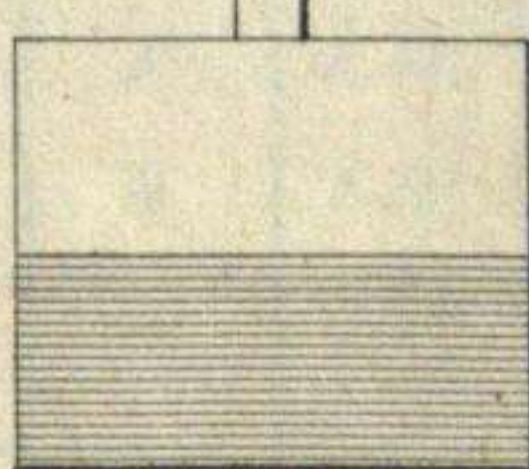
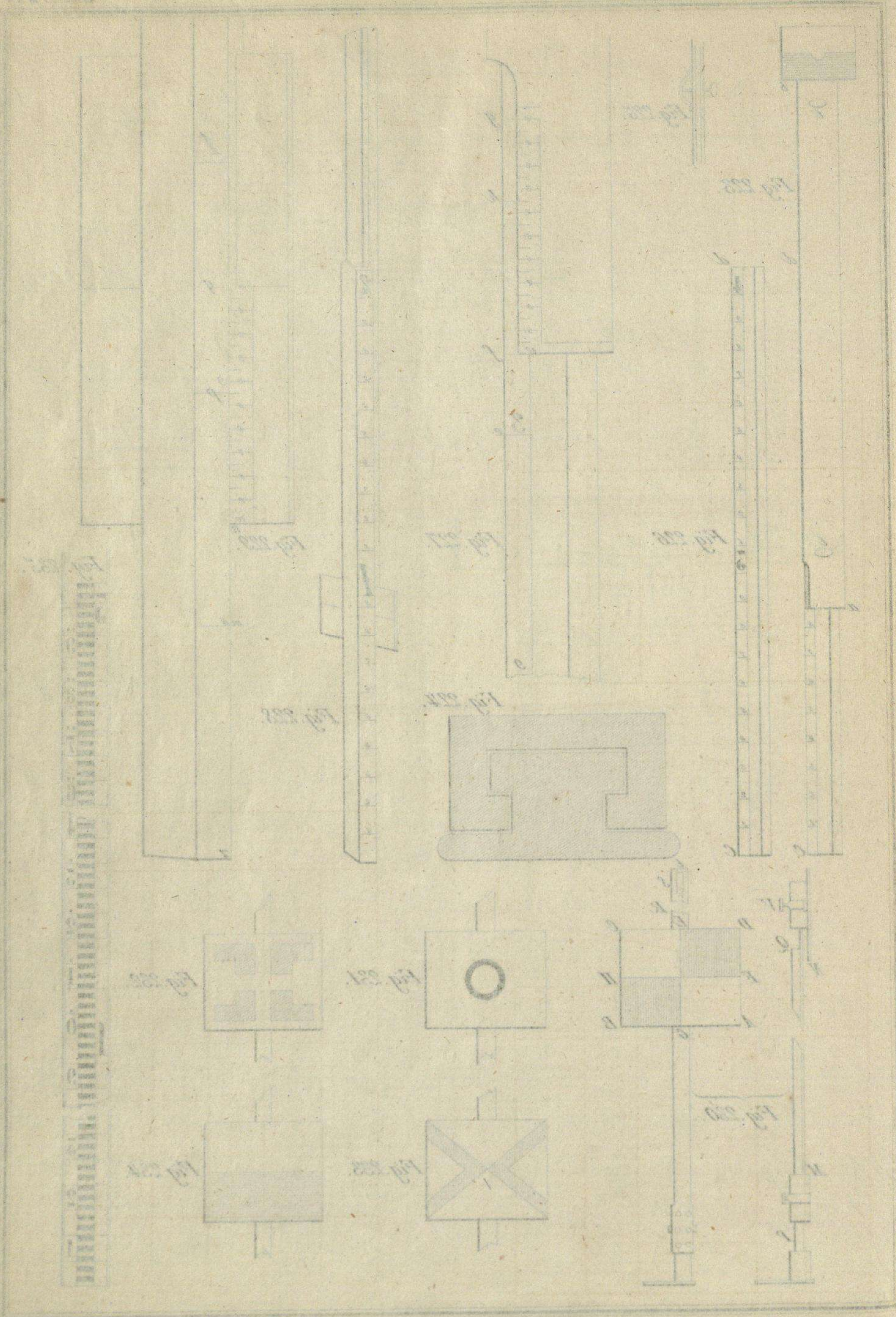

Fig. 234.



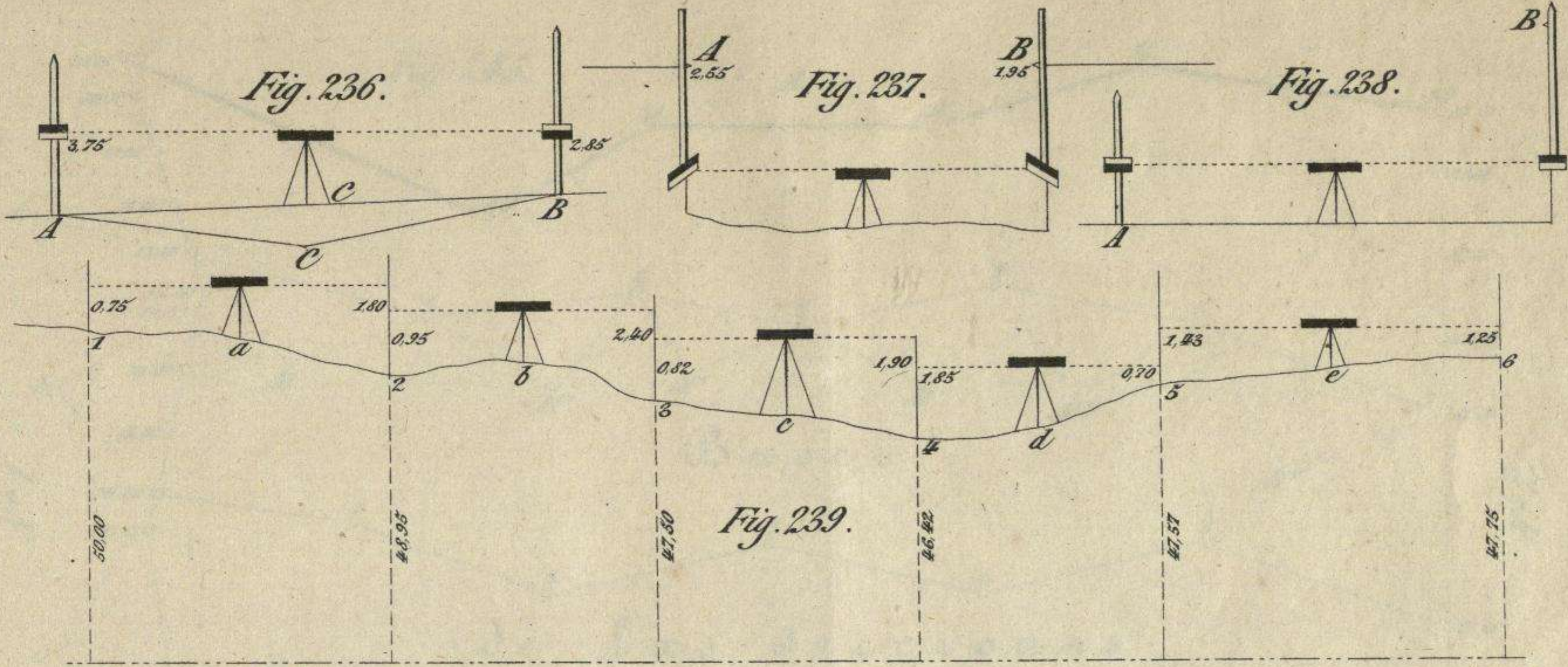

Fig. 240.

Números de las Estaciones.	Alturas de la Mira.	Diferencias de nivel en		Cotas de nivel.	Observaciones y Señales.
		+	-		
1	0,75			50,00	
2	1,80		1,05	48,95	
2	0,95		1,45	47,50	
3	2,40		1,08	46,42	
4	1,90		1,15	47,57	
5	0,70		0,18	47,75	
6	1,25				

Fig. 241.

Cota del punto 1	50,00
Nivelada de espalda	+ 0,75
Cota del plano de nivel de instrumento	50,75
Nivelada de frente	- 1,80
Cota del punto 2	48,95
	+ 0,95
	49,90
	- 2,40
Punto 3	47,50
	+ 0,82
	48,32
	- 1,90
Punto 4	46,42
	+ 1,85
	48,27
	- 0,70
Punto 5	47,57
	+ 1,43
	49,00
	- 1,25
Punto 6	47,75

Fig. 242.

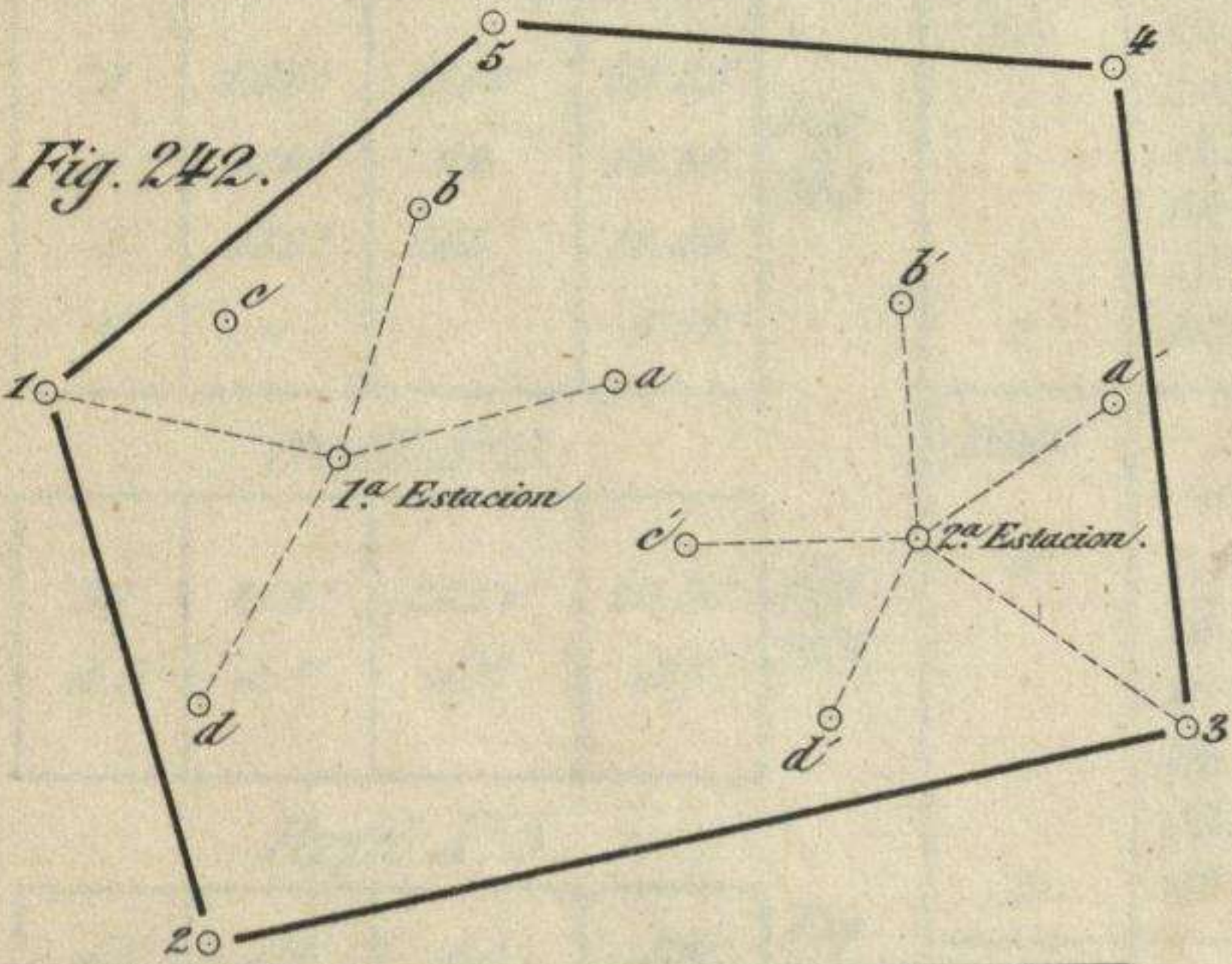

Números de las Estaciones.	Alturas de la Mira.	Diferencias de nivel en		Cotas de nivel.	Observaciones y Señales.
		+	-		
1	0,75			50,00	
2	1,80		1,05	48,95	
2	0,95		1,45	47,50	
3	2,40		1,08	46,42	
4	1,90		1,15	47,57	
4	1,85		2,43	50,00	
5	0,70				
5	3,98				
1	1,55	3,58	3,58		

Fig. 243.

Números de las Estaciones.	Puntos nivelados.	Alturas de la Mira.	Plano del nivel.	Cotas de nivel.
1ª Estación.	1	1,20	51,20	50,00
	a	1,08	51,20	50,12
	b	0,95	51,20	50,25
	c	0,76	51,20	50,44
	d	1,50	51,20	49,70
2ª Estación.	3	2,70	50,20	47,50
	a'	3,40	50,20	46,80
	b'	2,08	50,20	48,12
	c'	1,90	50,20	48,30
	d'	2,50	50,20	47,70

Fig. 244.

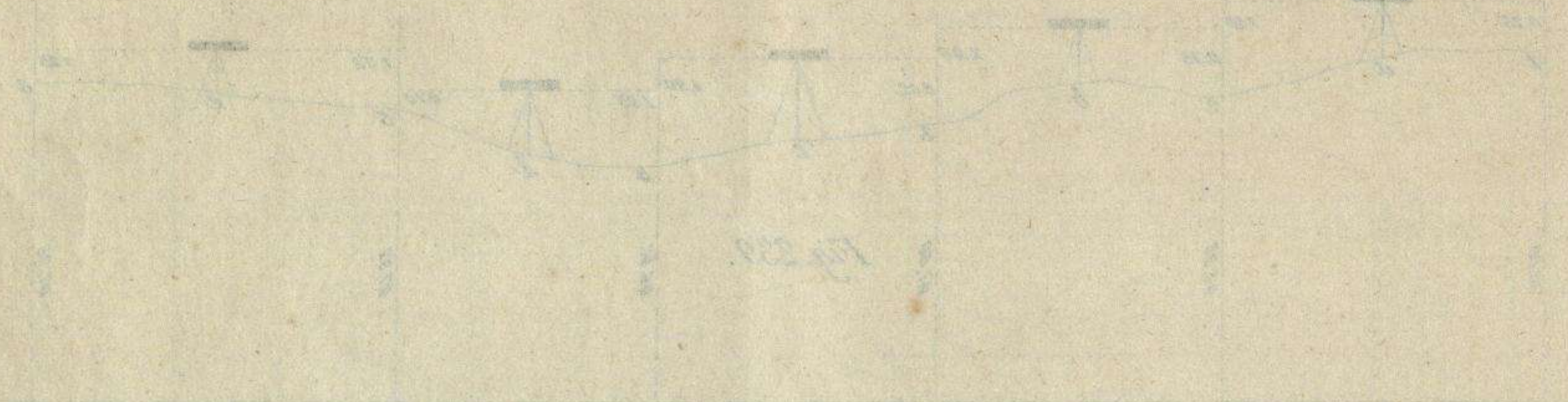
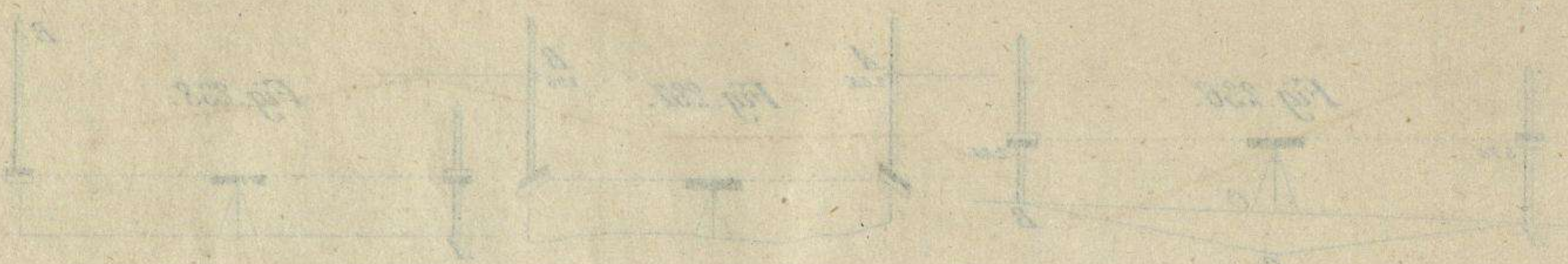

Fig 1
 Fig 2
 Fig 3
 Fig 4
 Fig 5
 Fig 6
 Fig 7
 Fig 8
 Fig 9
 Fig 10
 Fig 11
 Fig 12
 Fig 13
 Fig 14
 Fig 15
 Fig 16
 Fig 17
 Fig 18
 Fig 19
 Fig 20
 Fig 21
 Fig 22
 Fig 23
 Fig 24
 Fig 25
 Fig 26
 Fig 27
 Fig 28
 Fig 29
 Fig 30
 Fig 31
 Fig 32
 Fig 33
 Fig 34
 Fig 35
 Fig 36
 Fig 37
 Fig 38
 Fig 39
 Fig 40
 Fig 41
 Fig 42
 Fig 43
 Fig 44
 Fig 45
 Fig 46
 Fig 47
 Fig 48
 Fig 49
 Fig 50
 Fig 51
 Fig 52
 Fig 53
 Fig 54
 Fig 55
 Fig 56
 Fig 57
 Fig 58
 Fig 59
 Fig 60
 Fig 61
 Fig 62
 Fig 63
 Fig 64
 Fig 65
 Fig 66
 Fig 67
 Fig 68
 Fig 69
 Fig 70
 Fig 71
 Fig 72
 Fig 73
 Fig 74
 Fig 75
 Fig 76
 Fig 77
 Fig 78
 Fig 79
 Fig 80
 Fig 81
 Fig 82
 Fig 83
 Fig 84
 Fig 85
 Fig 86
 Fig 87
 Fig 88
 Fig 89
 Fig 90
 Fig 91
 Fig 92
 Fig 93
 Fig 94
 Fig 95
 Fig 96
 Fig 97
 Fig 98
 Fig 99
 Fig 100

Area	Length	Breadth	Area
1	10	5	50
2	10	5	50
3	10	5	50
4	10	5	50
5	10	5	50
6	10	5	50
7	10	5	50
8	10	5	50
9	10	5	50
10	10	5	50
11	10	5	50
12	10	5	50
13	10	5	50
14	10	5	50
15	10	5	50
16	10	5	50
17	10	5	50
18	10	5	50
19	10	5	50
20	10	5	50
21	10	5	50
22	10	5	50
23	10	5	50
24	10	5	50
25	10	5	50
26	10	5	50
27	10	5	50
28	10	5	50
29	10	5	50
30	10	5	50
31	10	5	50
32	10	5	50
33	10	5	50
34	10	5	50
35	10	5	50
36	10	5	50
37	10	5	50
38	10	5	50
39	10	5	50
40	10	5	50
41	10	5	50
42	10	5	50
43	10	5	50
44	10	5	50
45	10	5	50
46	10	5	50
47	10	5	50
48	10	5	50
49	10	5	50
50	10	5	50



Area	Length	Breadth	Area
1	10	5	50
2	10	5	50
3	10	5	50
4	10	5	50
5	10	5	50
6	10	5	50
7	10	5	50
8	10	5	50
9	10	5	50
10	10	5	50
11	10	5	50
12	10	5	50
13	10	5	50
14	10	5	50
15	10	5	50
16	10	5	50
17	10	5	50
18	10	5	50
19	10	5	50
20	10	5	50
21	10	5	50
22	10	5	50
23	10	5	50
24	10	5	50
25	10	5	50
26	10	5	50
27	10	5	50
28	10	5	50
29	10	5	50
30	10	5	50
31	10	5	50
32	10	5	50
33	10	5	50
34	10	5	50
35	10	5	50
36	10	5	50
37	10	5	50
38	10	5	50
39	10	5	50
40	10	5	50
41	10	5	50
42	10	5	50
43	10	5	50
44	10	5	50
45	10	5	50
46	10	5	50
47	10	5	50
48	10	5	50
49	10	5	50
50	10	5	50

Area	Length	Breadth	Area
1	10	5	50
2	10	5	50
3	10	5	50
4	10	5	50
5	10	5	50
6	10	5	50
7	10	5	50
8	10	5	50
9	10	5	50
10	10	5	50
11	10	5	50
12	10	5	50
13	10	5	50
14	10	5	50
15	10	5	50
16	10	5	50
17	10	5	50
18	10	5	50
19	10	5	50
20	10	5	50
21	10	5	50
22	10	5	50
23	10	5	50
24	10	5	50
25	10	5	50
26	10	5	50
27	10	5	50
28	10	5	50
29	10	5	50
30	10	5	50
31	10	5	50
32	10	5	50
33	10	5	50
34	10	5	50
35	10	5	50
36	10	5	50
37	10	5	50
38	10	5	50
39	10	5	50
40	10	5	50
41	10	5	50
42	10	5	50
43	10	5	50
44	10	5	50
45	10	5	50
46	10	5	50
47	10	5	50
48	10	5	50
49	10	5	50
50	10	5	50

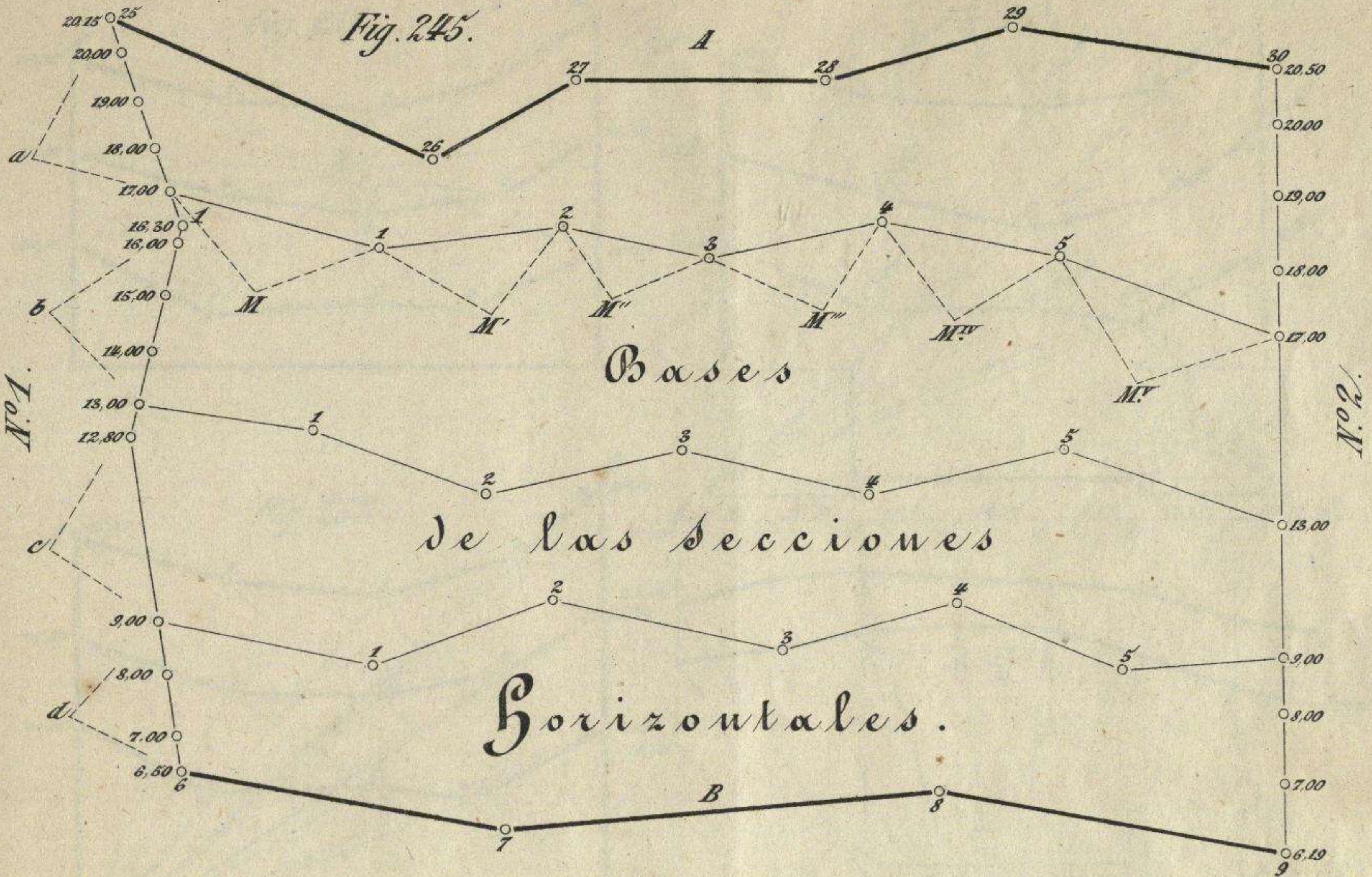

Perfil N.º 1.

Puntos de Estación.	Medida de los Angulos Lados.		Cotas de nivel.
25	143°	120 v.º	20.15
1	124°	99	16.30
2	153°	205	12.80
6	"	"	6.50

Fig. 246.

Perfil N.º 2.

30	113°	285 v.º	20.50
6.º	6.º	6.º	6.º

Fig. 247.

Perfil N.º 3.

6.º	6.º	6.º	6.º
-----	-----	-----	-----

Fig. 248.

Fig. 250.

Puntos de Estación	Medida de los Angulos Lados.		Cotas de nivel.
17.00	115°	72 v.º	17.00
1	98°	70	"
2	89°	68	"
3	110°	80	"
4	120°	90	"
5	130°	85	17.00

Fig. 249.

Puntos de partida.	Cotas de nivel.	Distancias entre los puntos.	Observ.º
25	20.15	17 v.º	
	20.00	29	
	19.00	15	
	18.00	24	
	17.00	23	
1	16.30	"	
Total/		108	
1	16.30	"	
	16.00	"	
	15.00	"	
	14.00	"	
	13.00	"	
2	12.00	"	
Total/		"	
2	12.80	"	
	12.00	"	
	11.00	"	
	10.00	"	
	9.00	"	
	8.00	"	
	7.00	"	
6	6.00	"	
Total/		"	

Fig. 254.

Bases y puntos de Estac.º	Puntos observados.	Angulos	Cotas de la horizontal observada.	Observaciones.
C D	A	230°	16.00	
	1	227°	"	
	2	218°	"	1.ª horiz.º
	3	209°	"	
1.ª estación C	4	201°	"	
	1	250°	15.00	
	2	"	"	
	3	"	"	2.ª horiz.º
Perfil C	4	"	"	
	Perfil/	"	14.00	
	1	"	"	
	2	"	"	3.ª horiz.º
2.ª estación D	3	"	"	
	4	"	"	
	A	"	16.00	
	1	"	"	1.ª horiz.º
3.ª estación D	2	"	"	
	3	"	"	2.ª horiz.º
	4	"	"	
	Perfil/	"	"	3.ª horiz.º

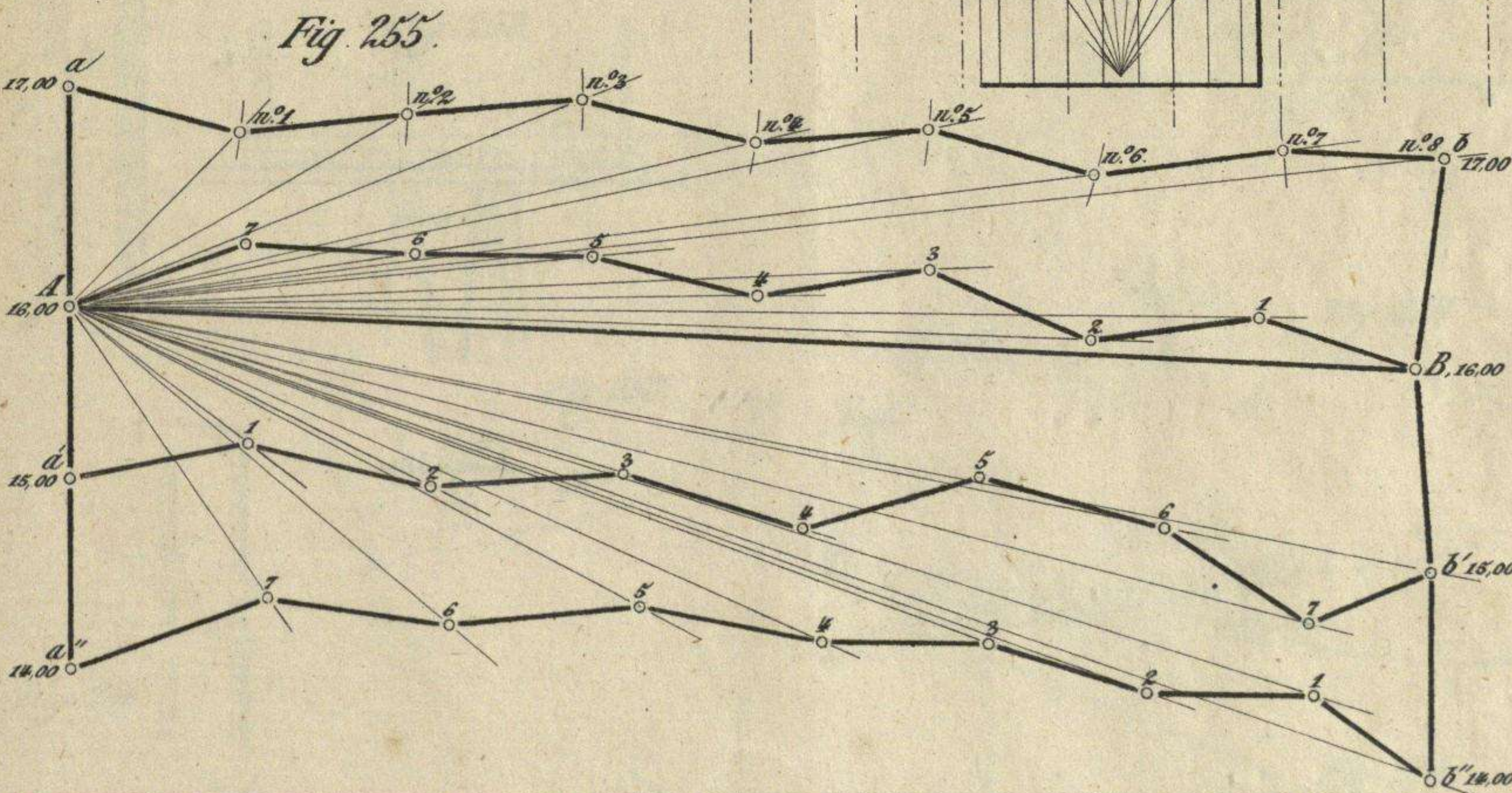
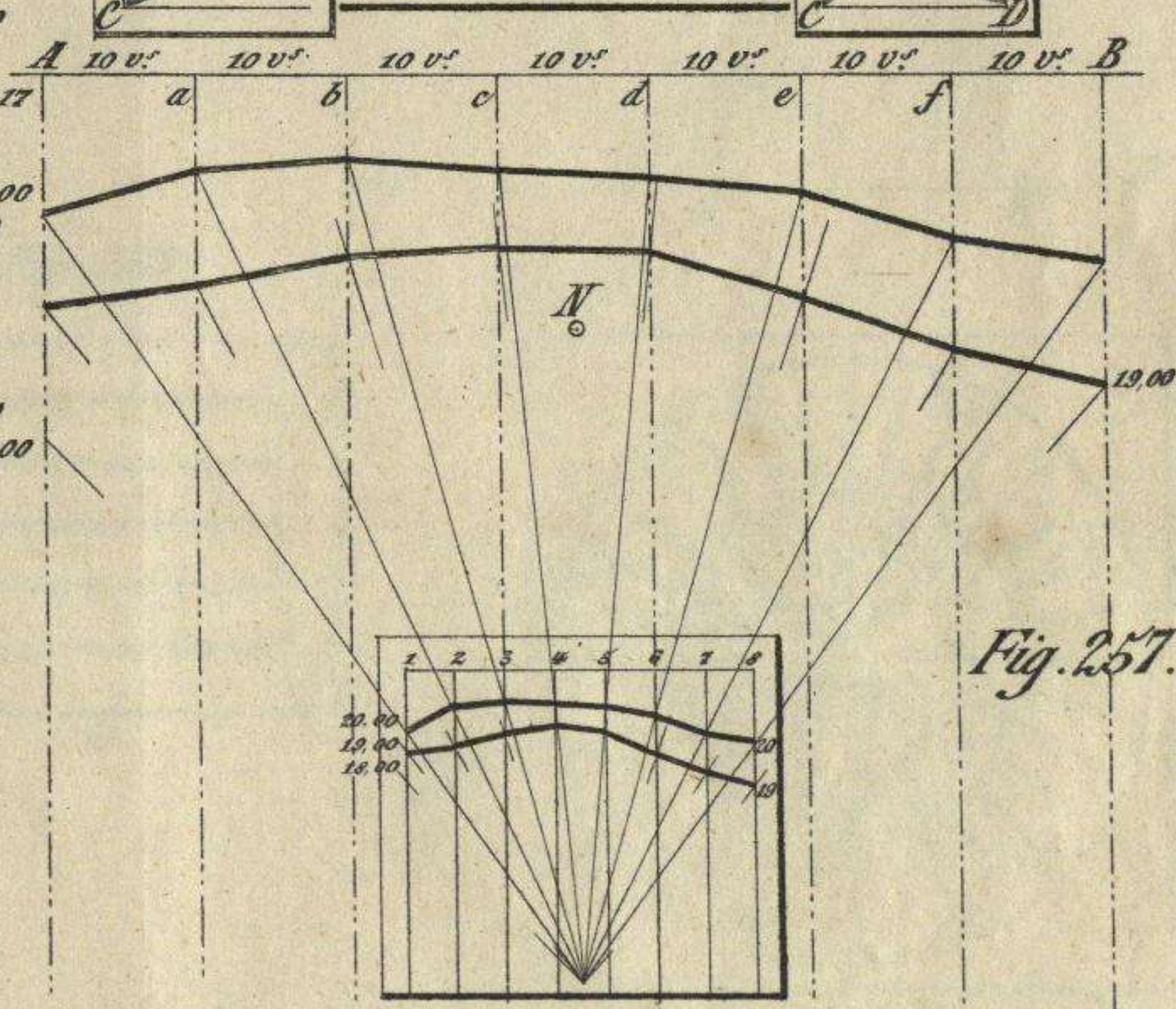
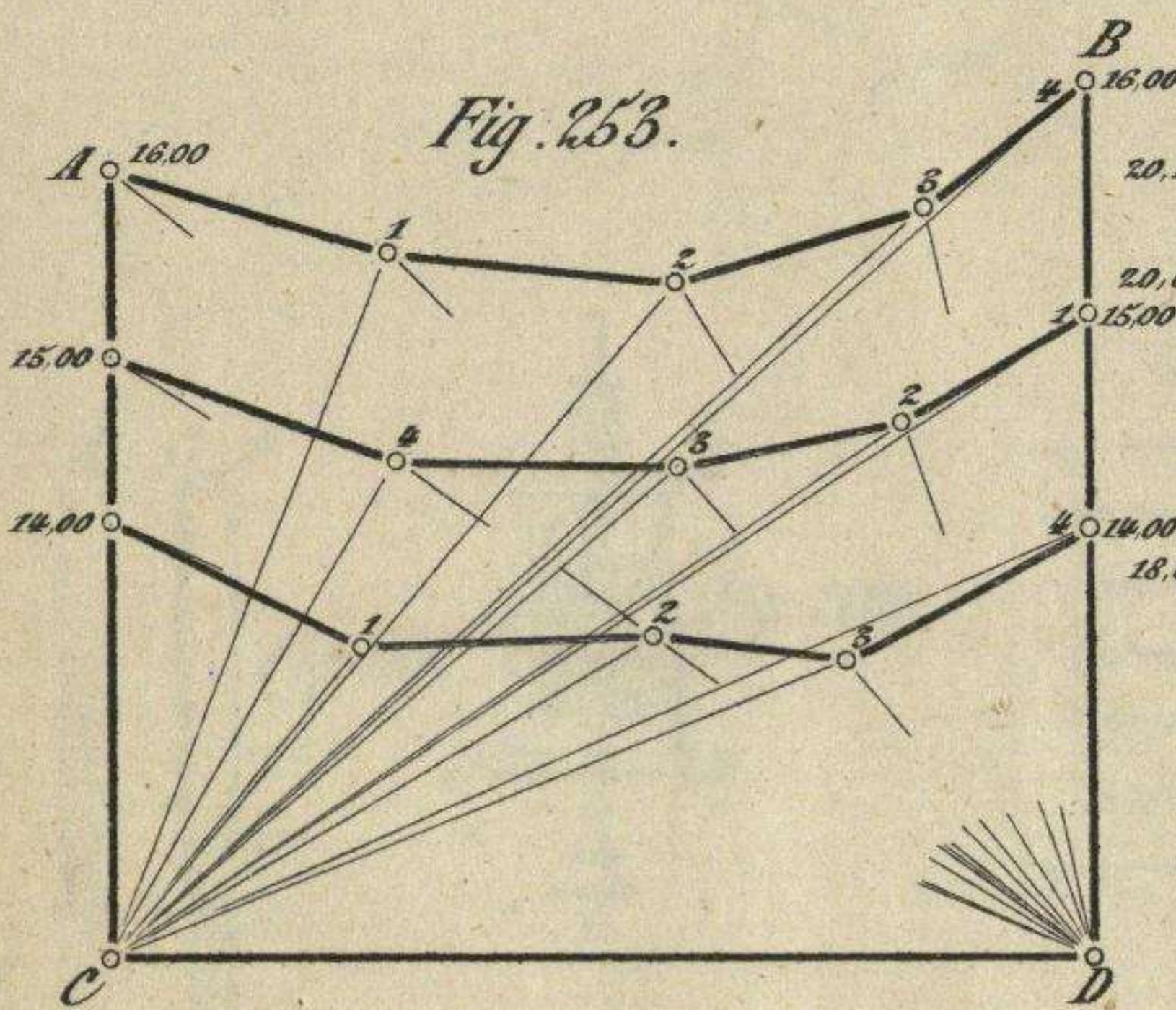
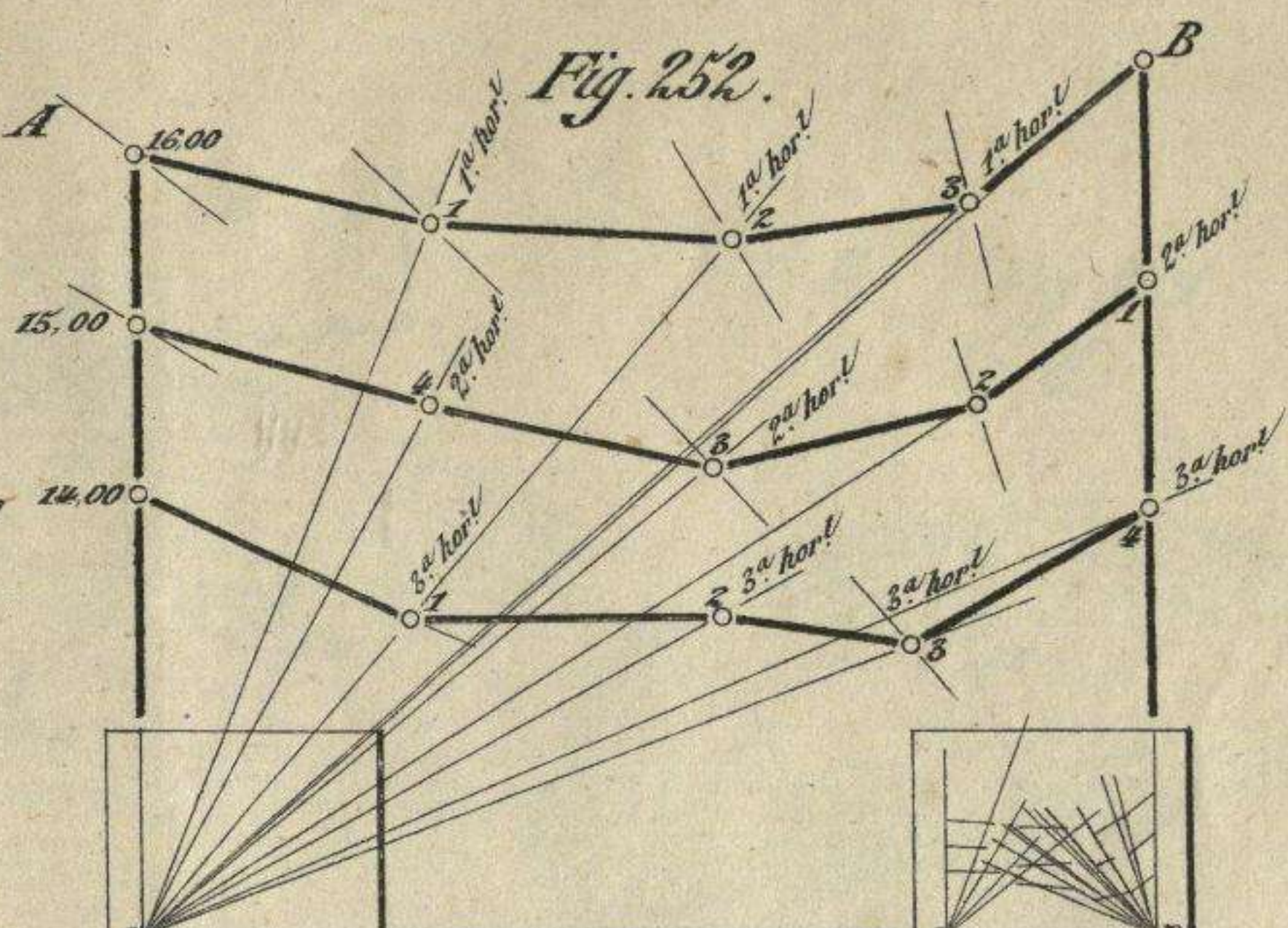
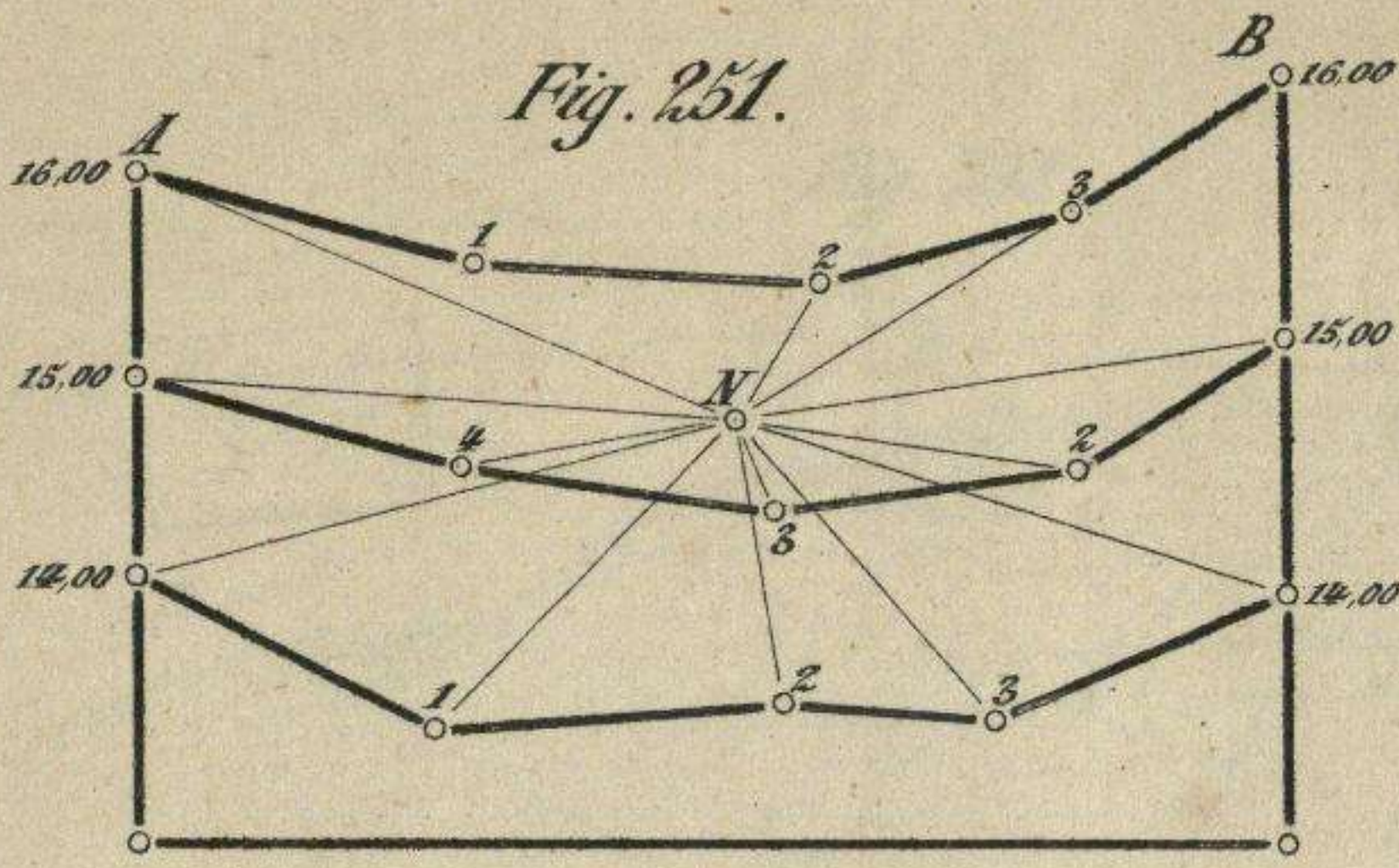

Bases y puntos de estación.		Escala. CIVIL.		A		Bases y puntos de estación.	
Puntos observados	a	1	2	3	4	5	6
Angulos.	40°	280°	280°	196°	174°	"	"
Cota de la horizontal observada.	17.00	16.00	16.00	16.00	16.00	14.00	"
Observaciones.	1ª Horizontal.	2ª Horizontal.	3ª Horizontal.	"	"	"	"

Fig. 256.

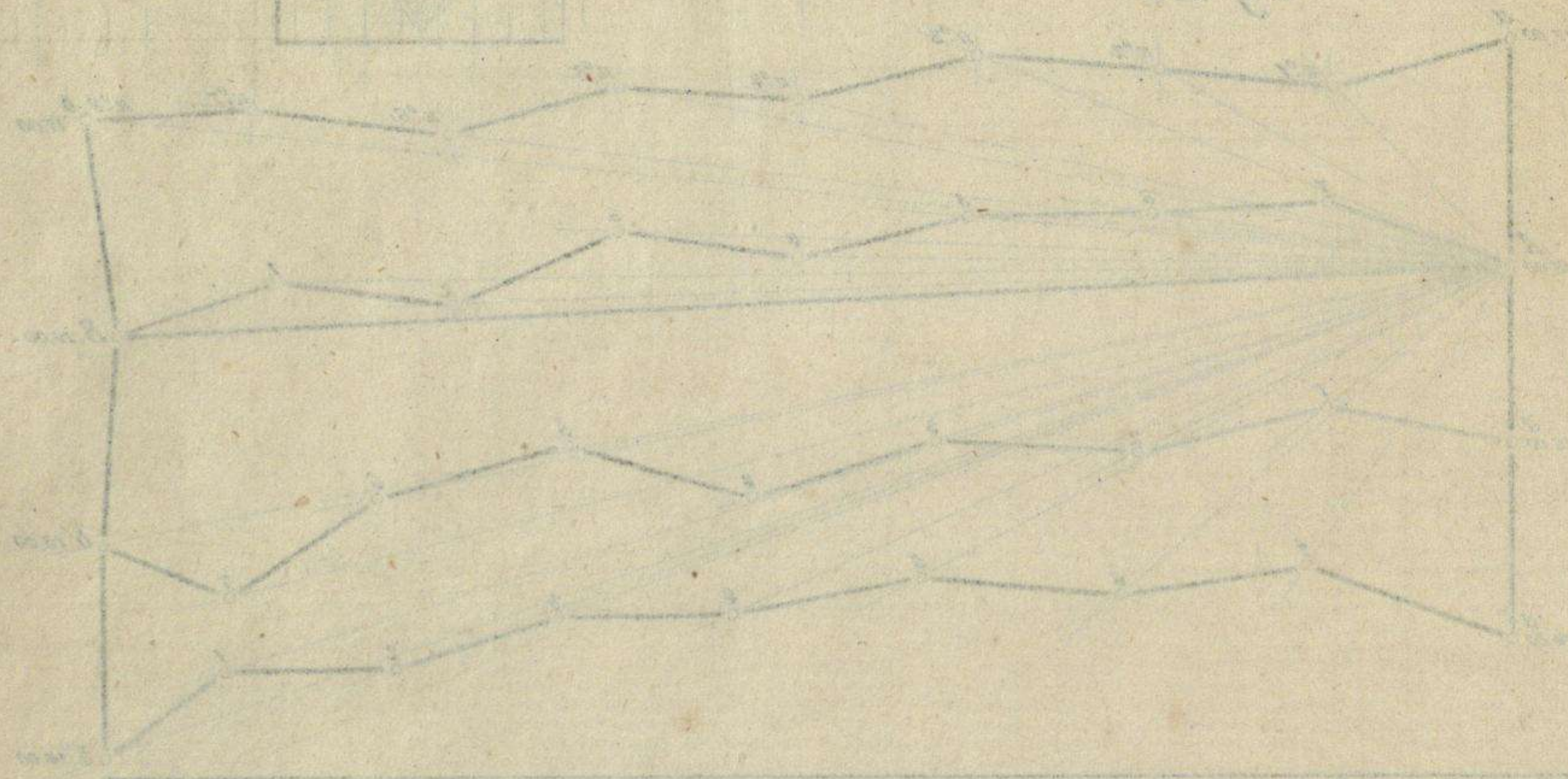
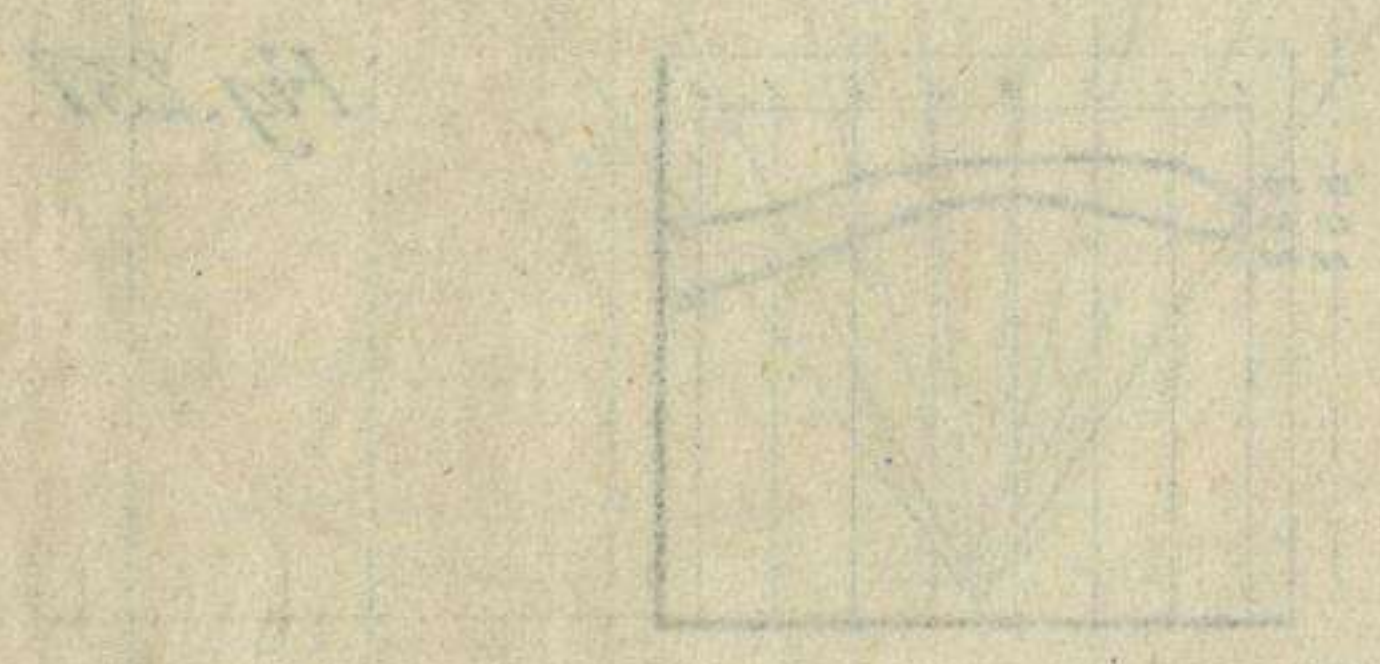
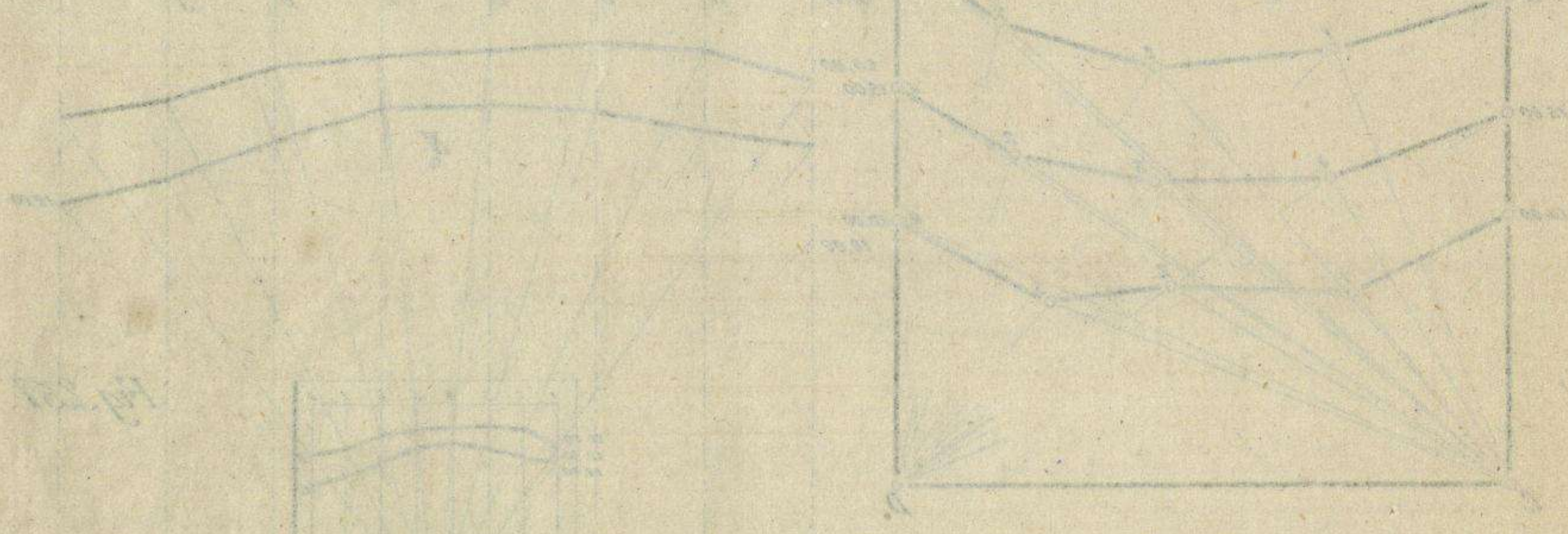
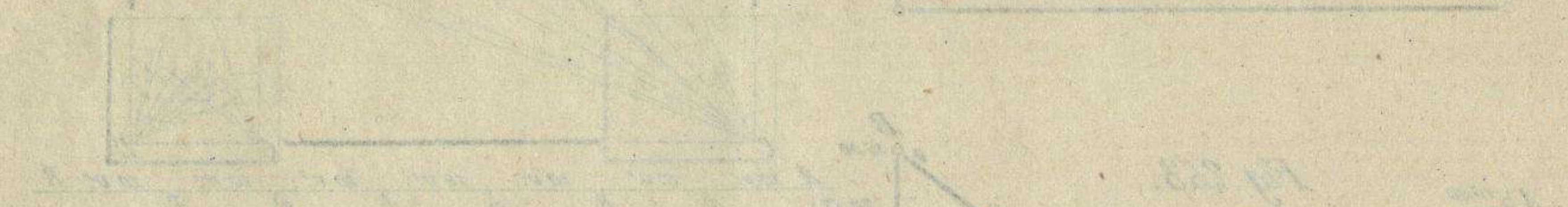
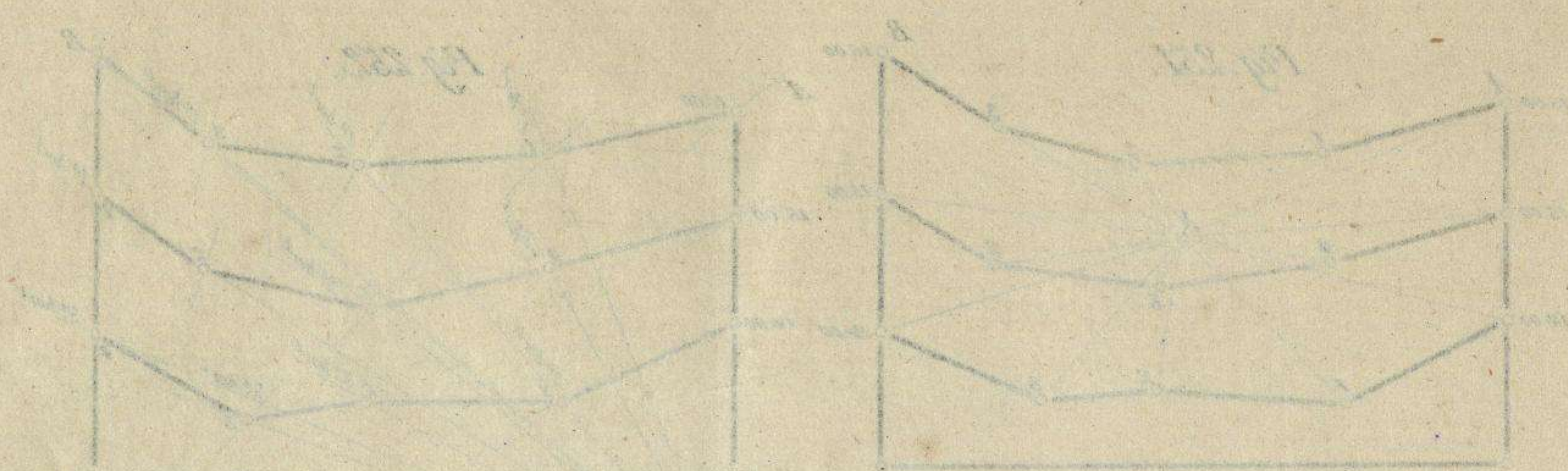

III			
1	2	3	4
5	6	7	8
9	10	11	12
13	14	15	16

Fig 26

Fig. 258.

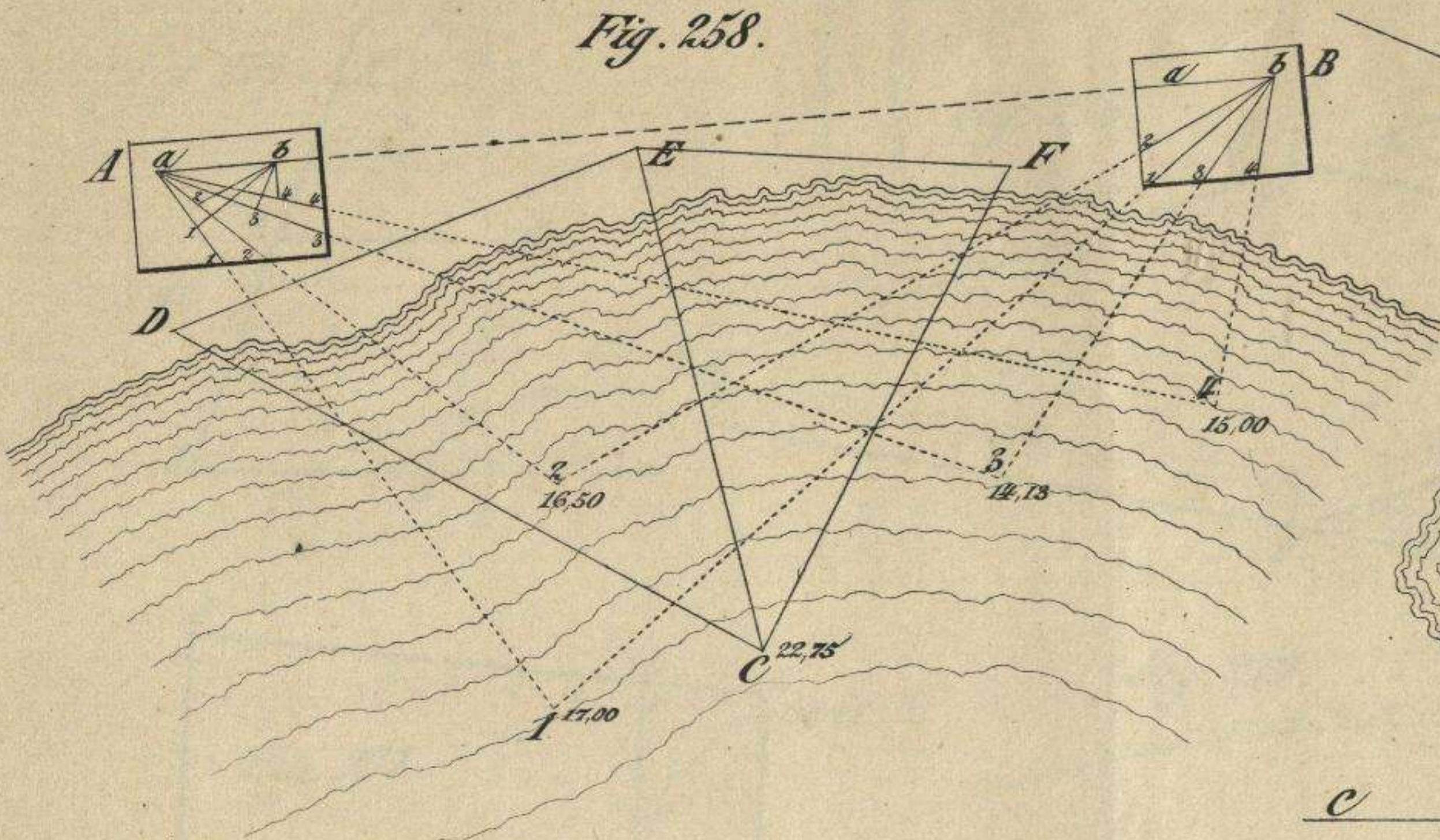

Fig. 259.

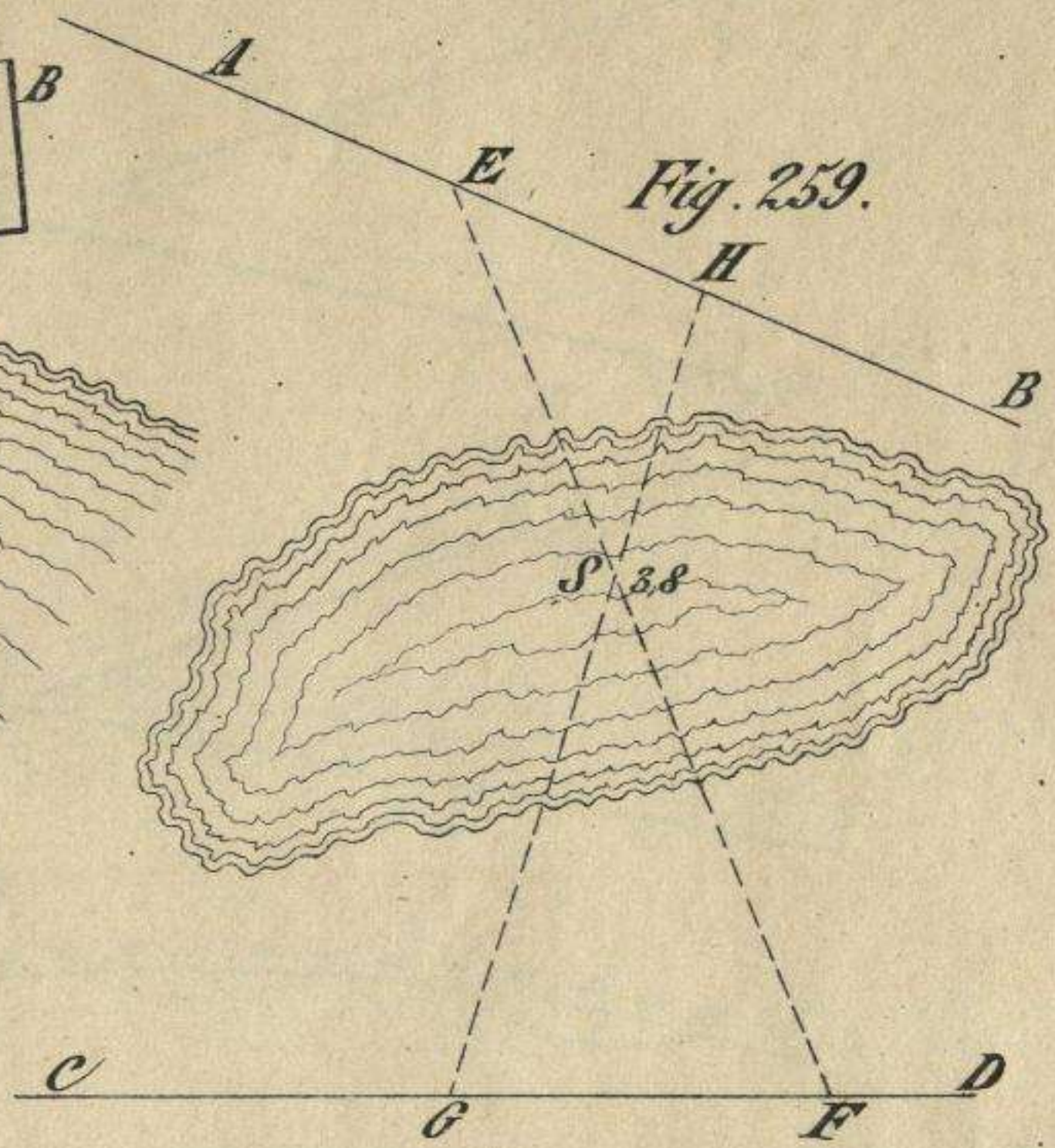

Fig. 264.

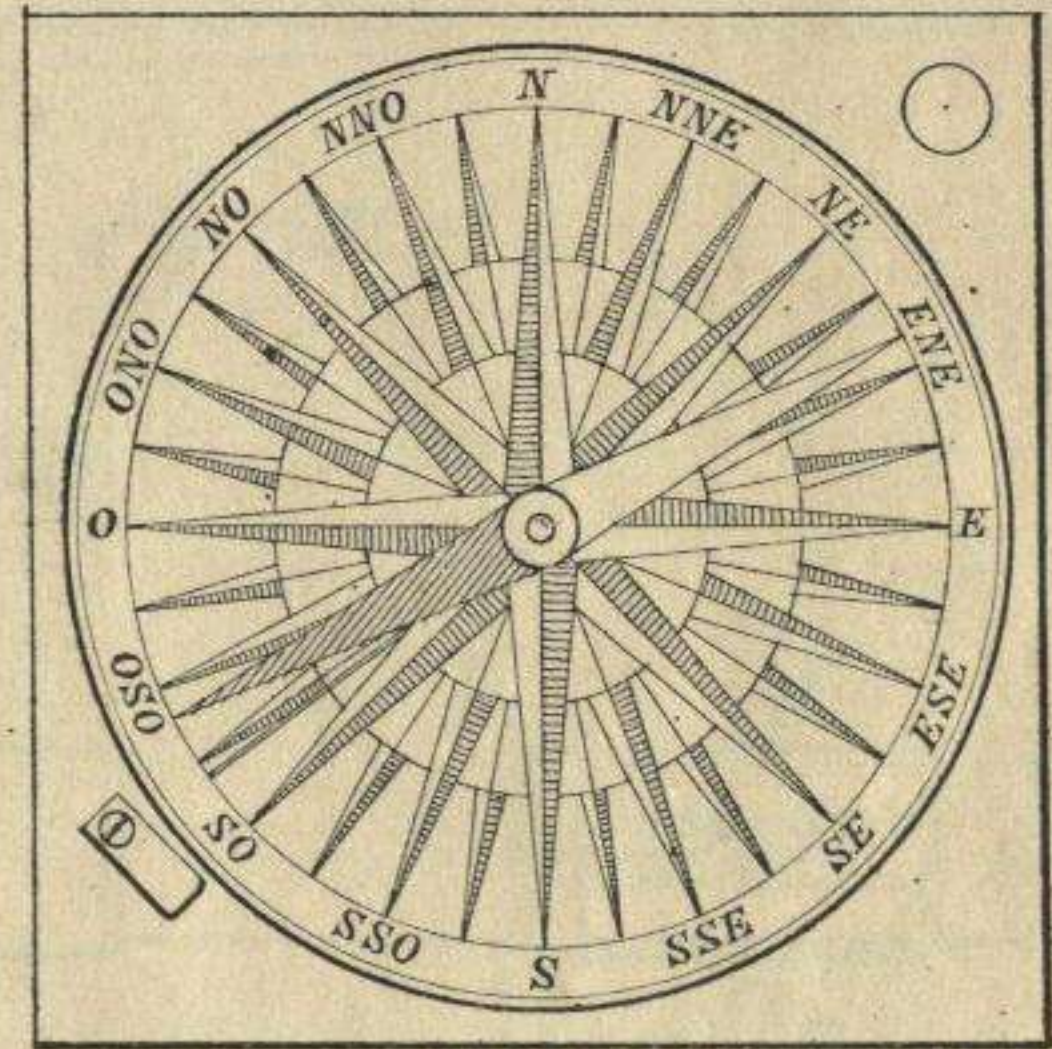
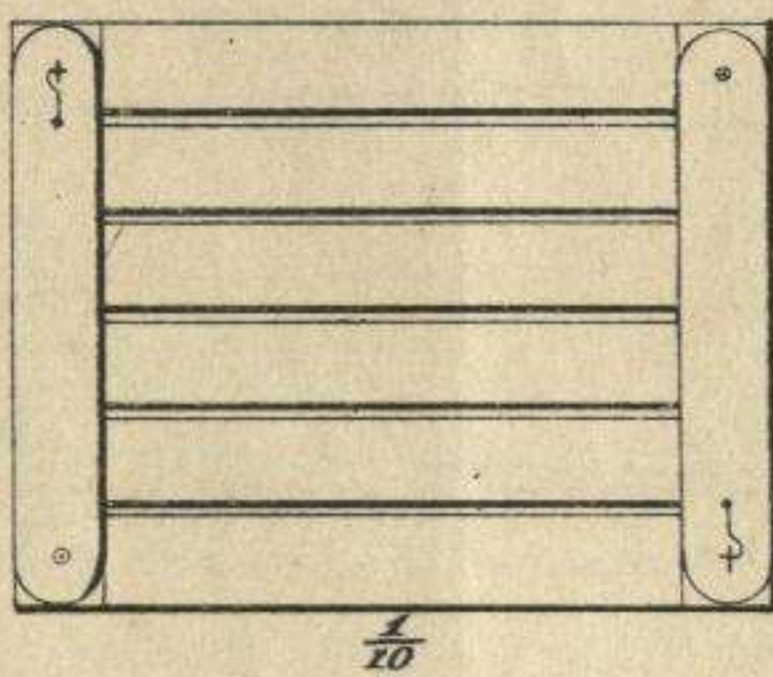

Fig. 265.

Fig. 260.

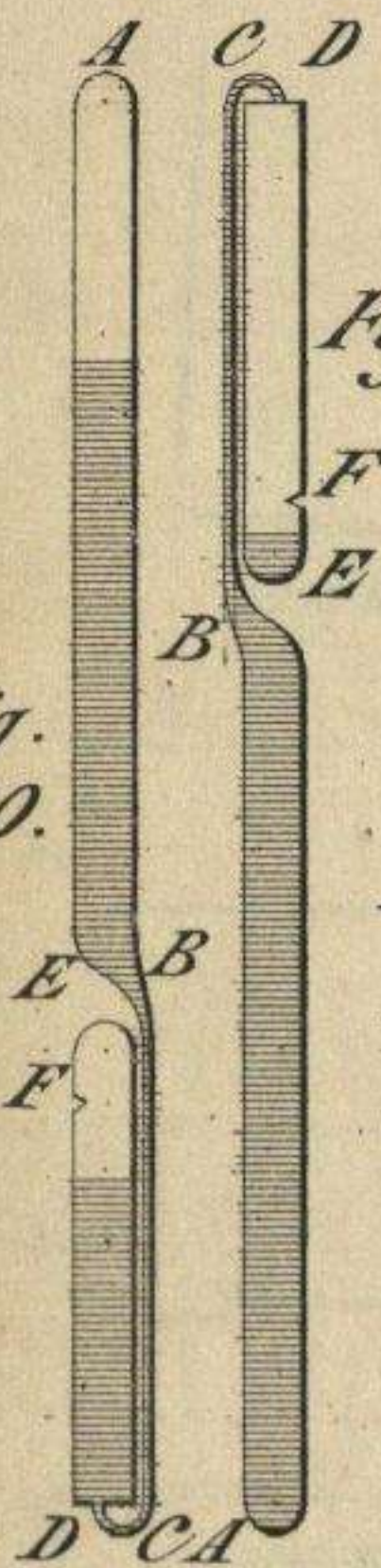

Fig. 261.

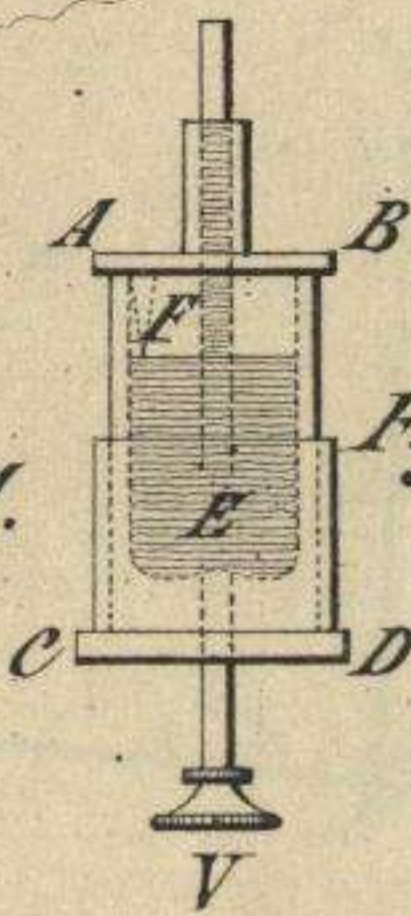

Fig. 262.

Fig. 263.

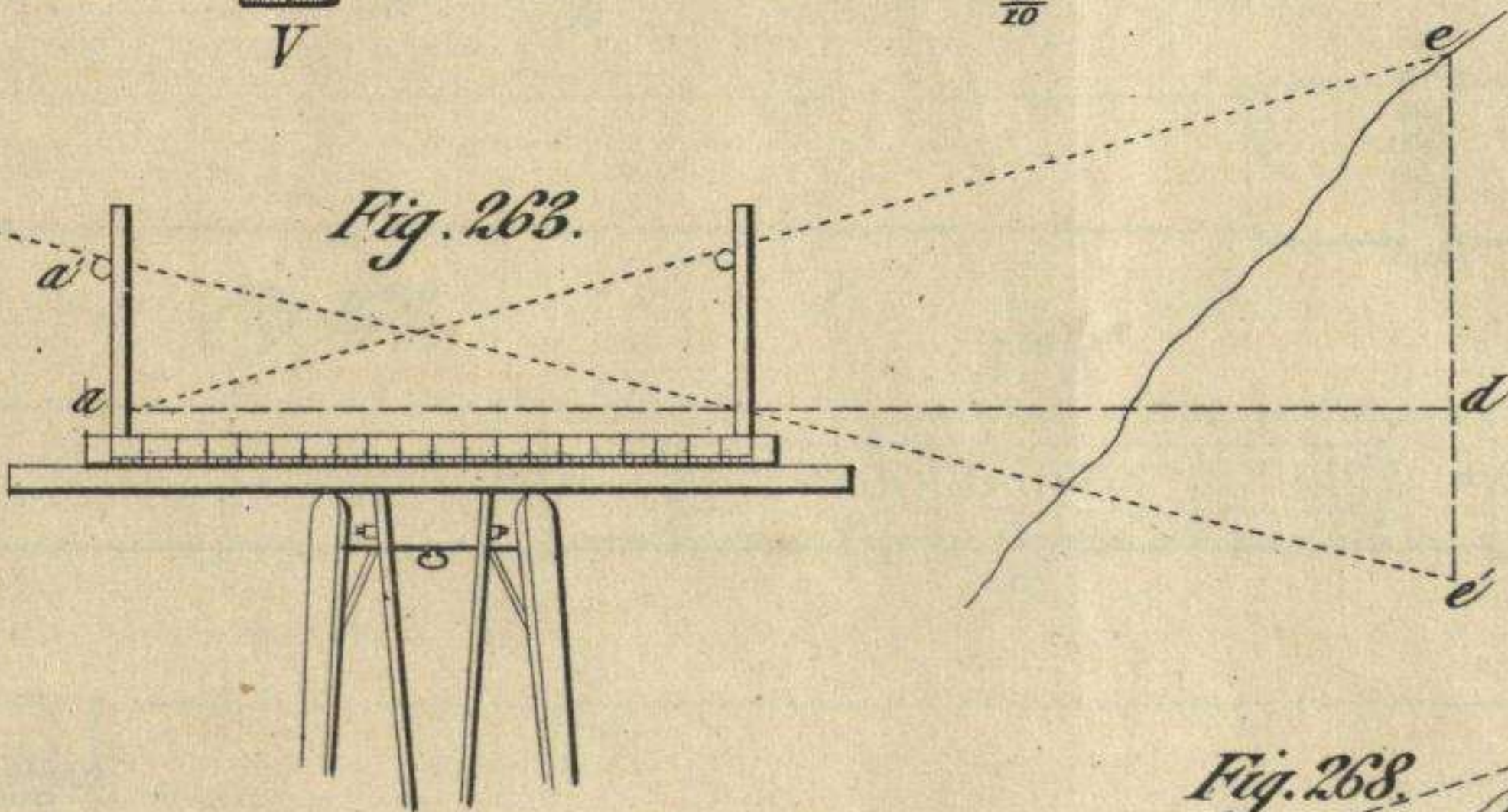

Fig. 267.

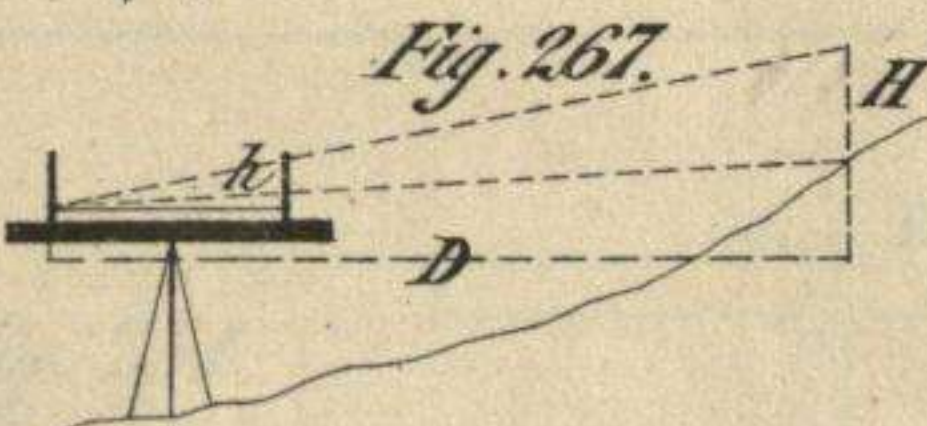

Fig. 268.

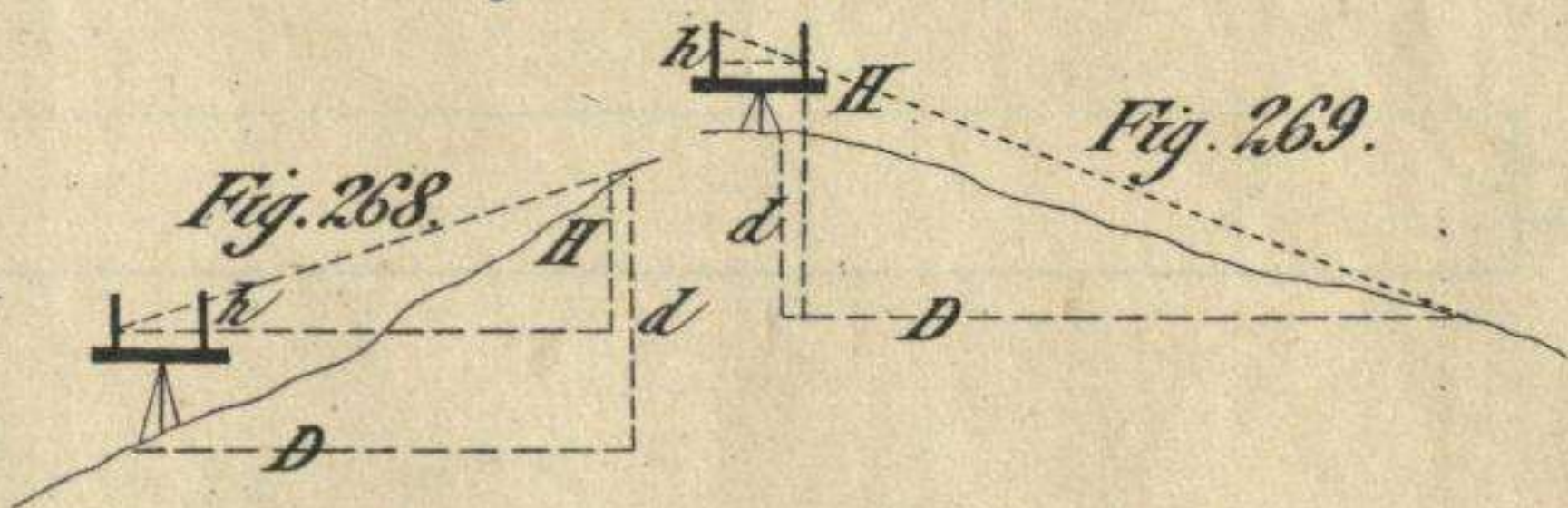

Fig. 269.

Fig. 266.

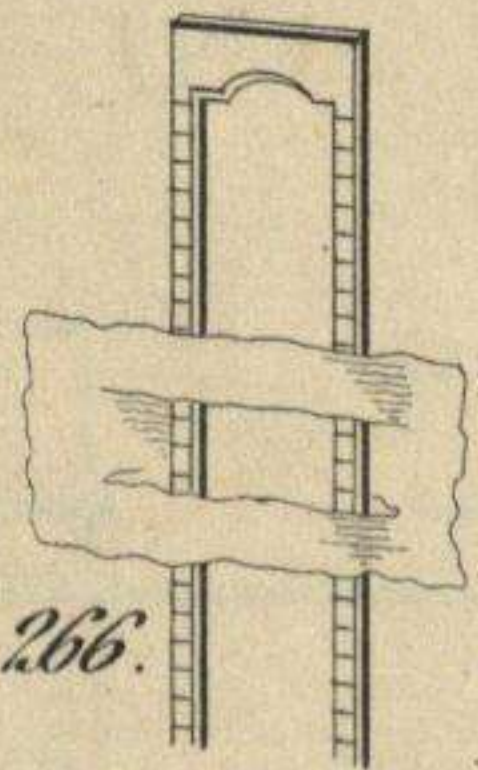

Fig. 270.

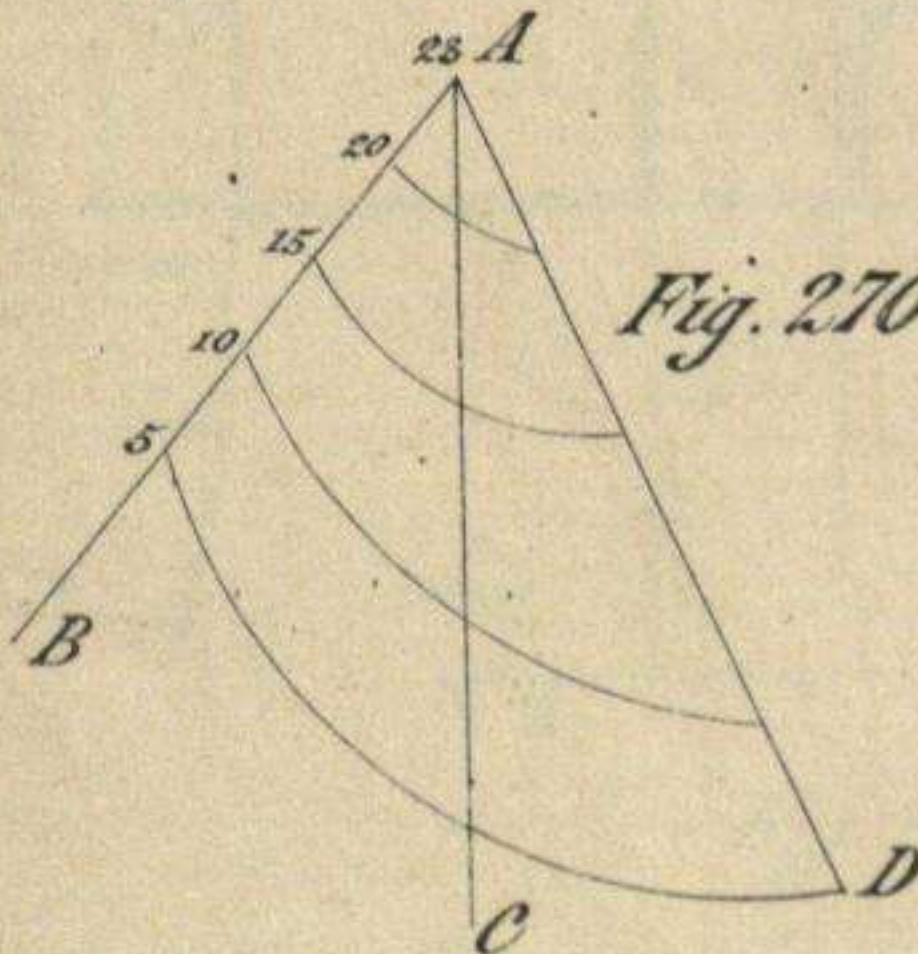

Fig. 271.

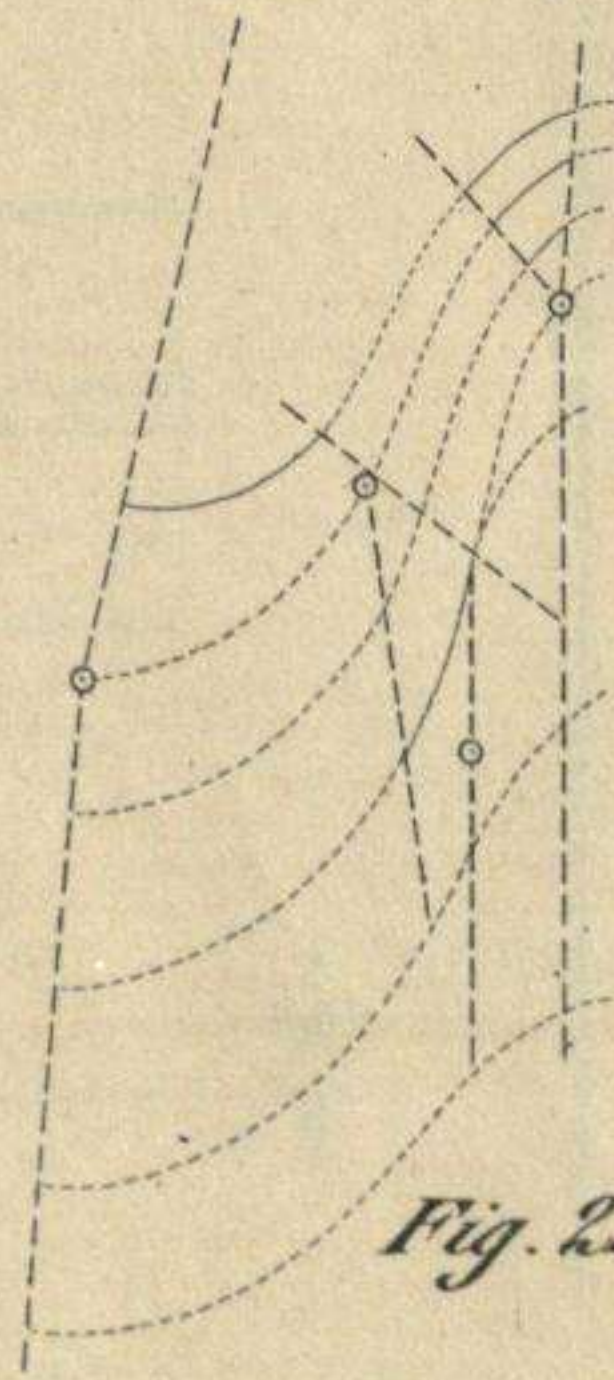

Fig. 272.



Fig. 273.

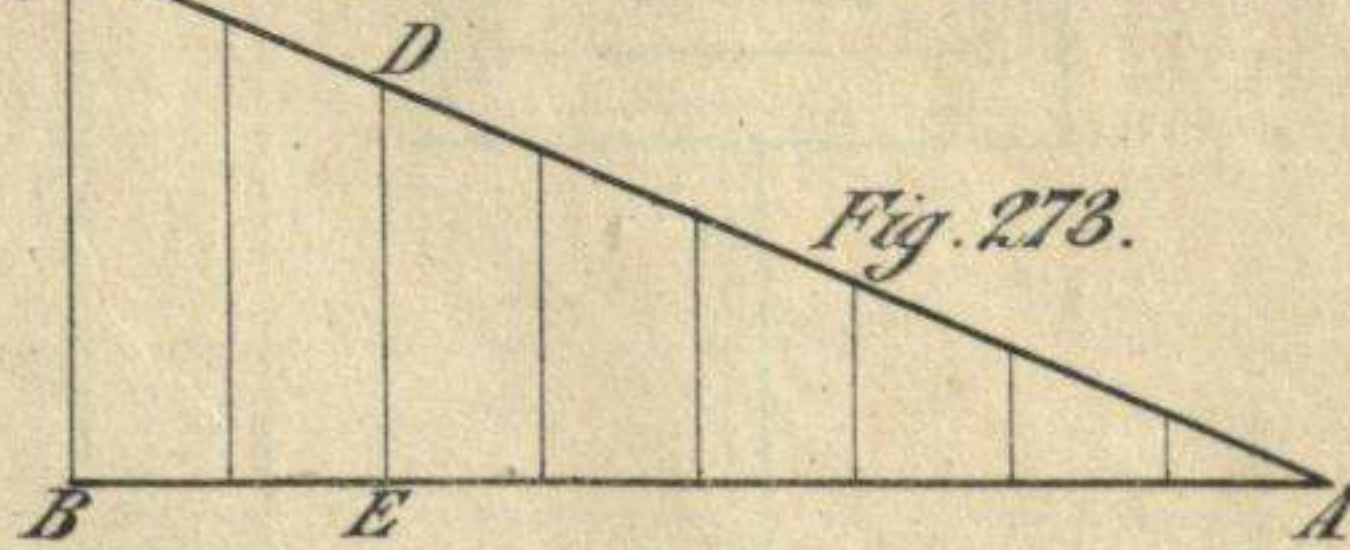
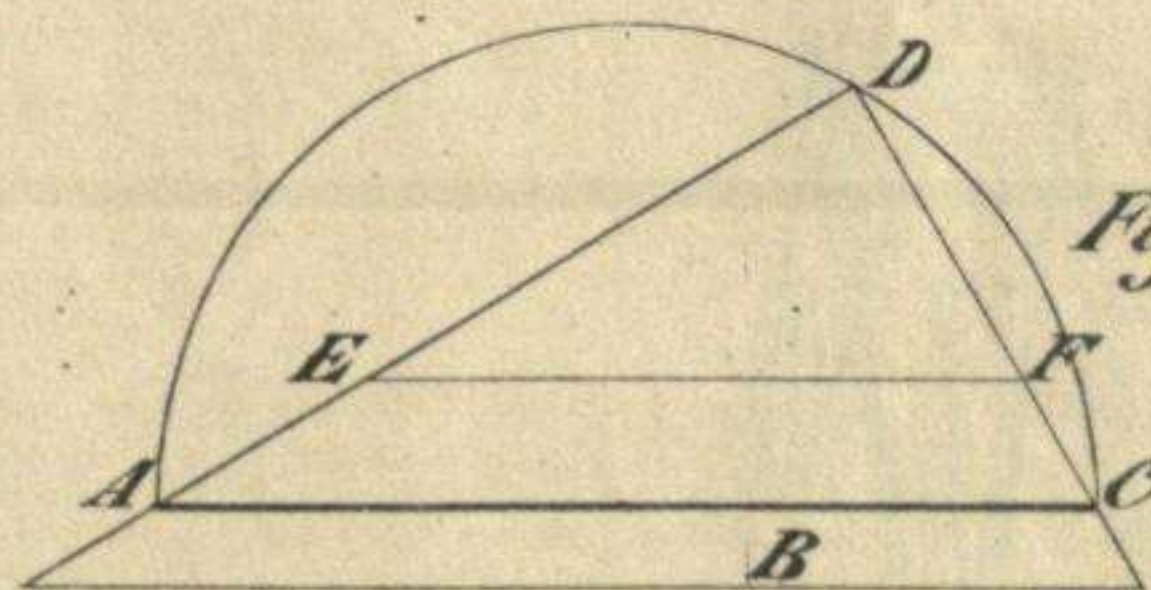
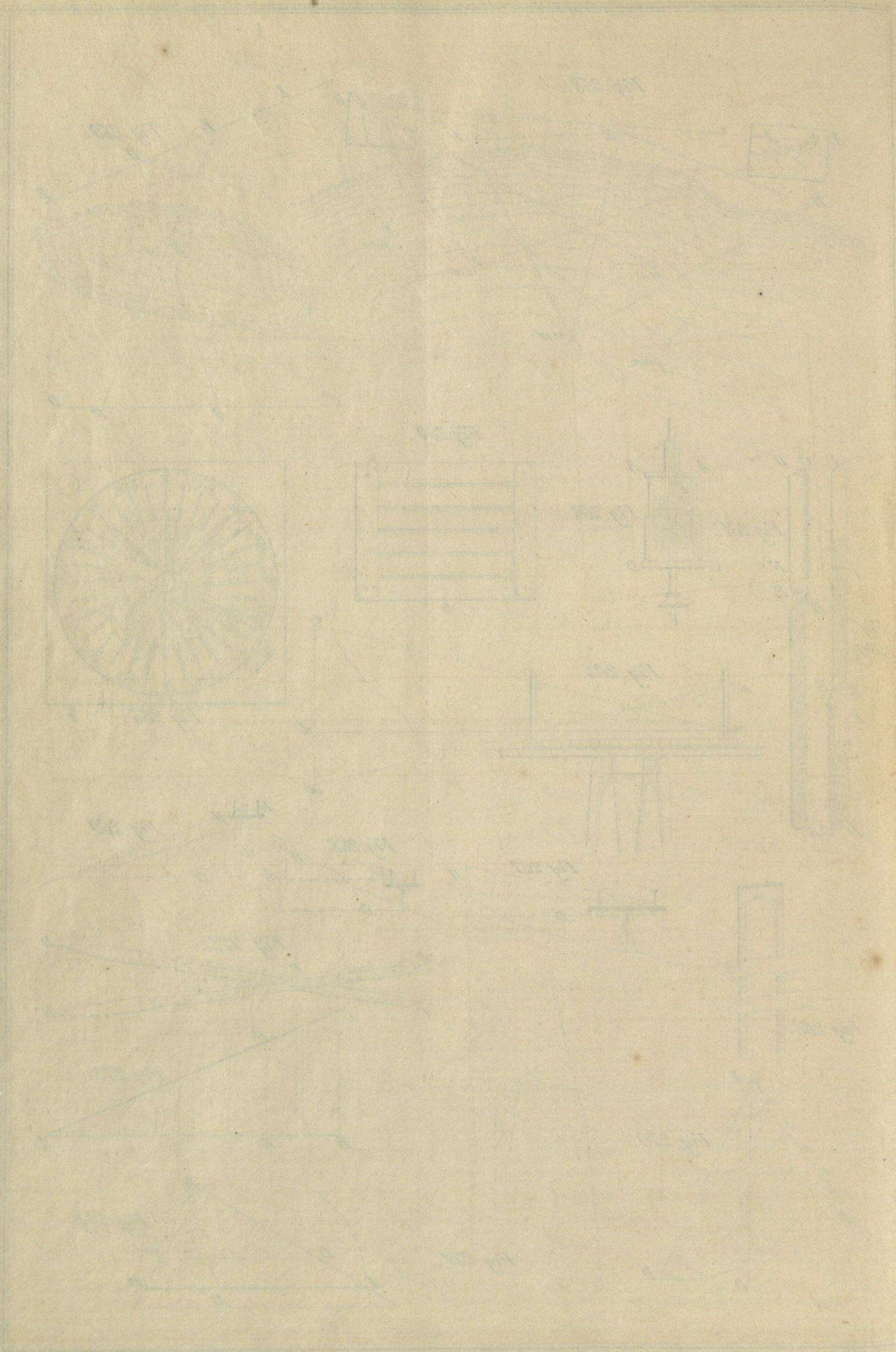
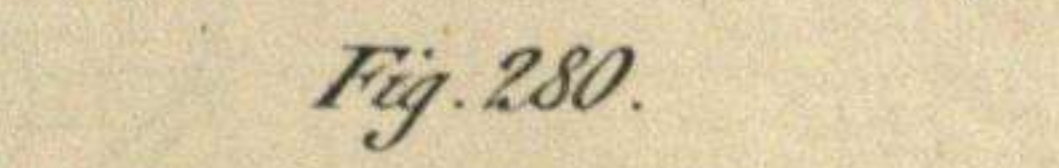
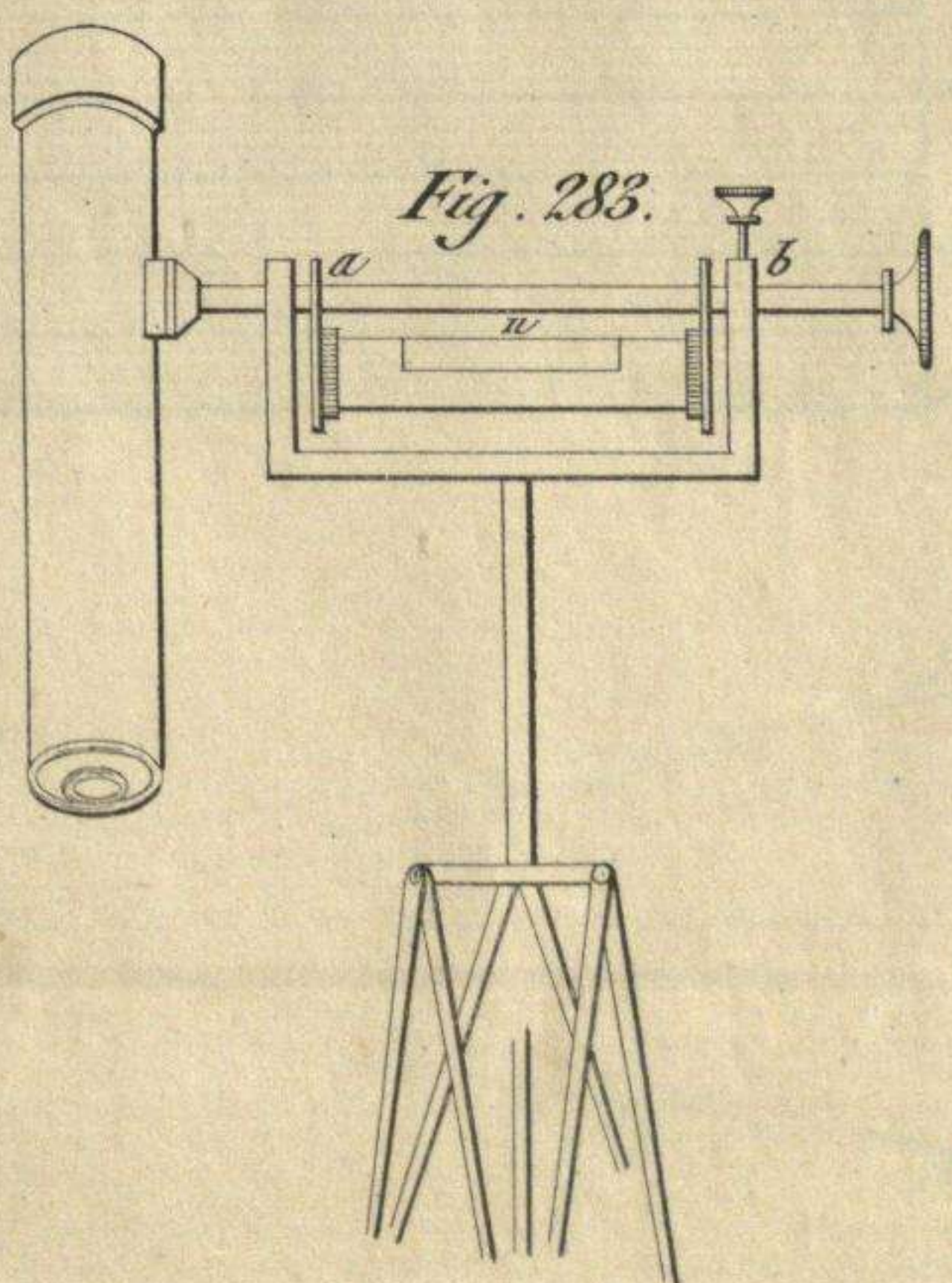
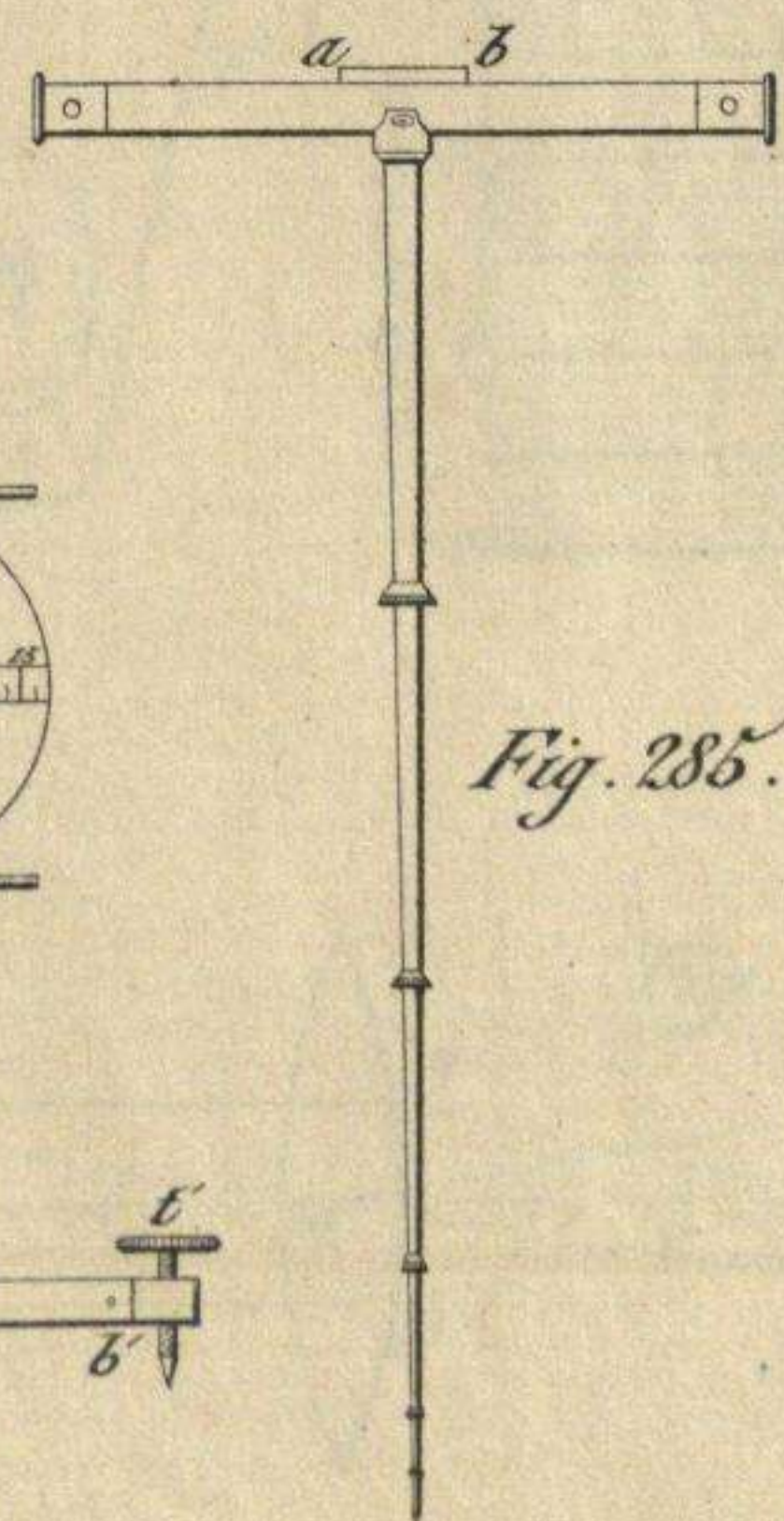
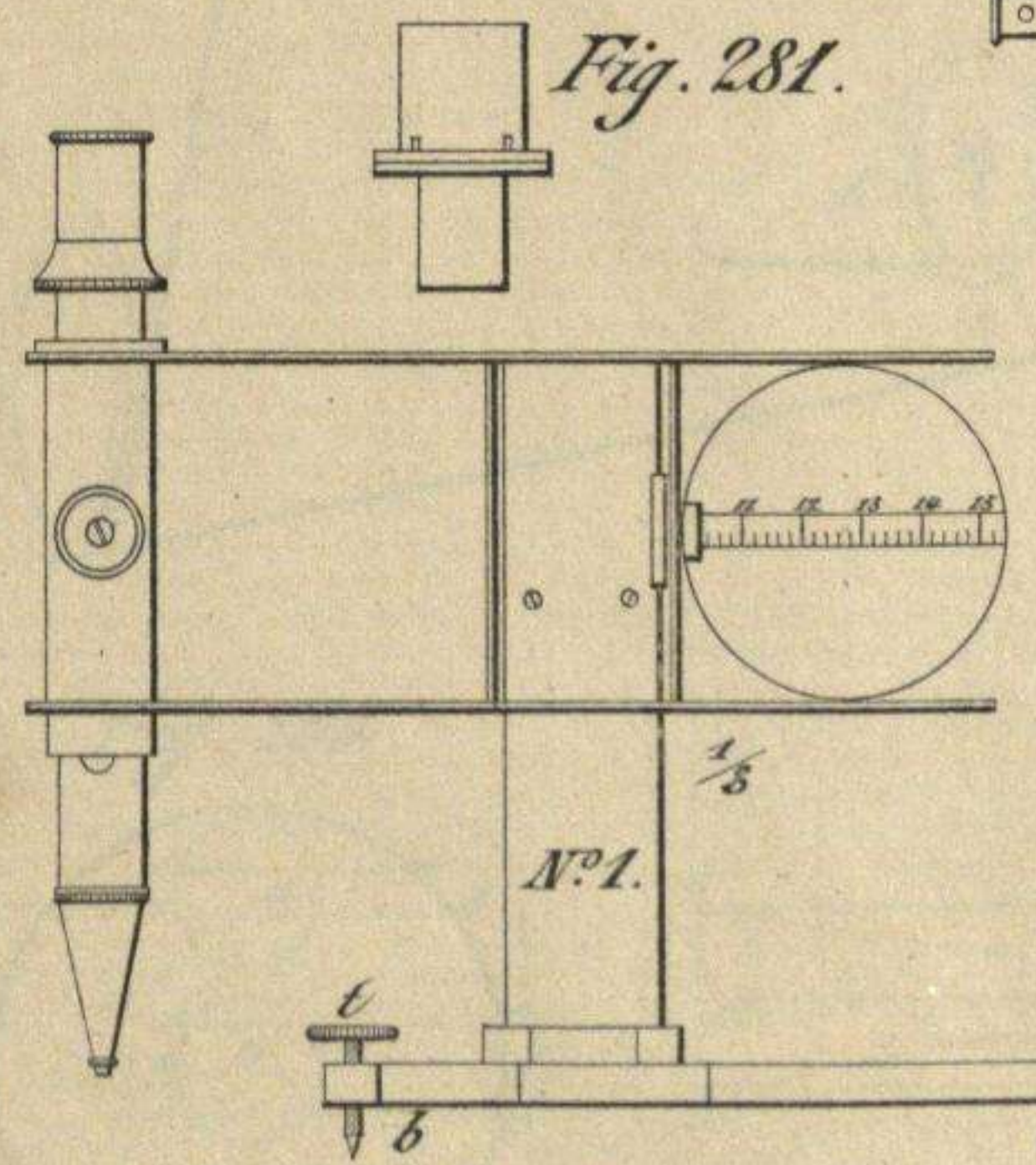
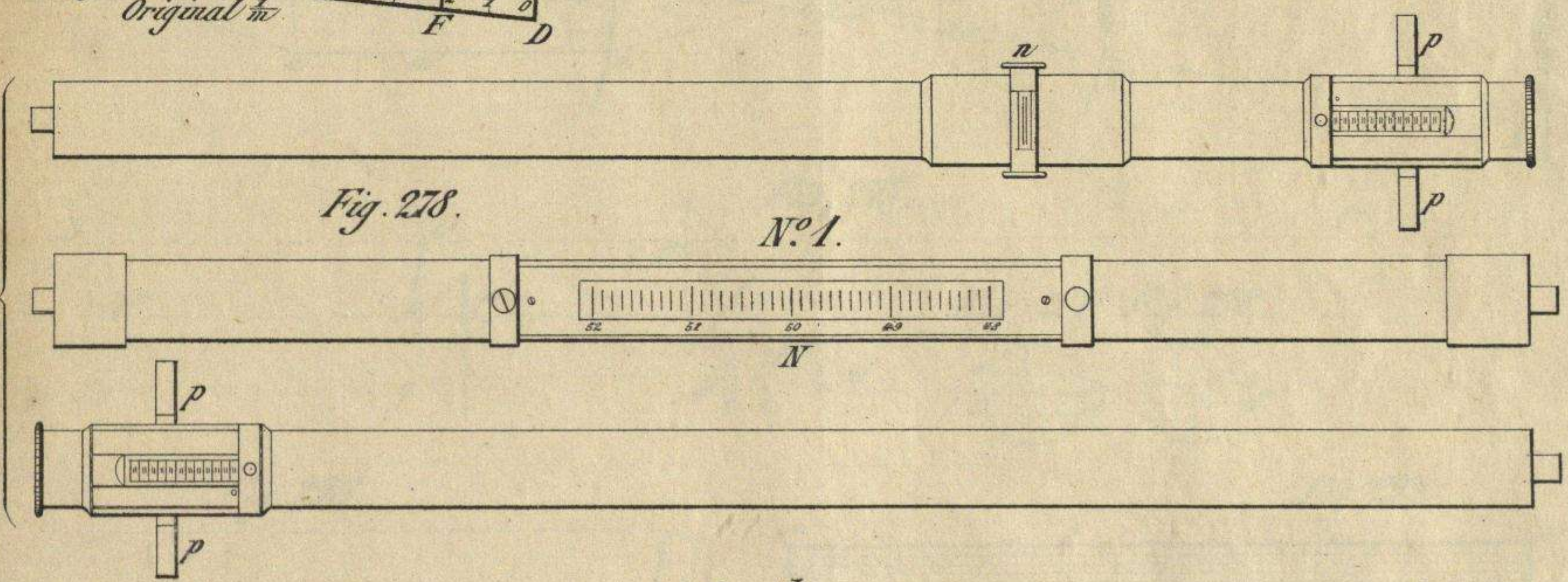
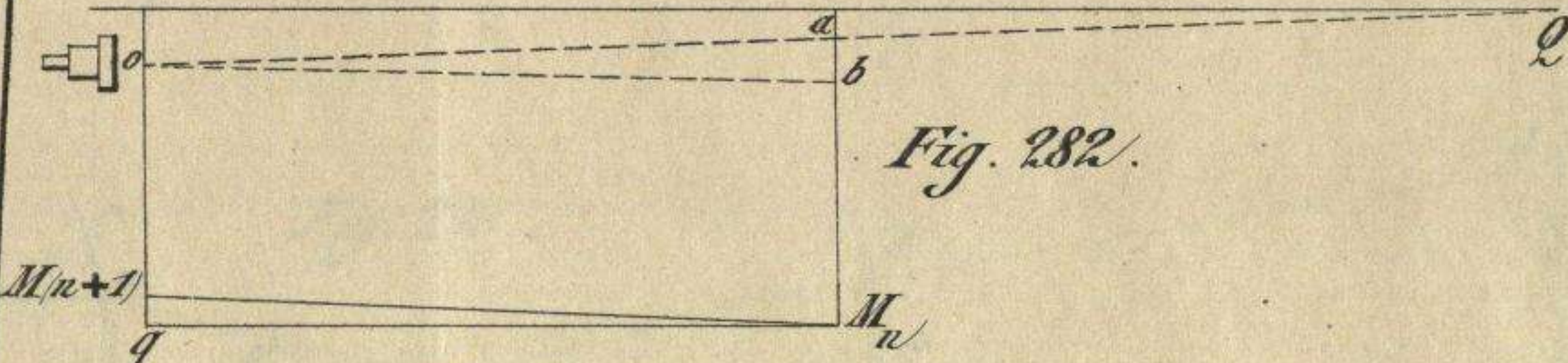
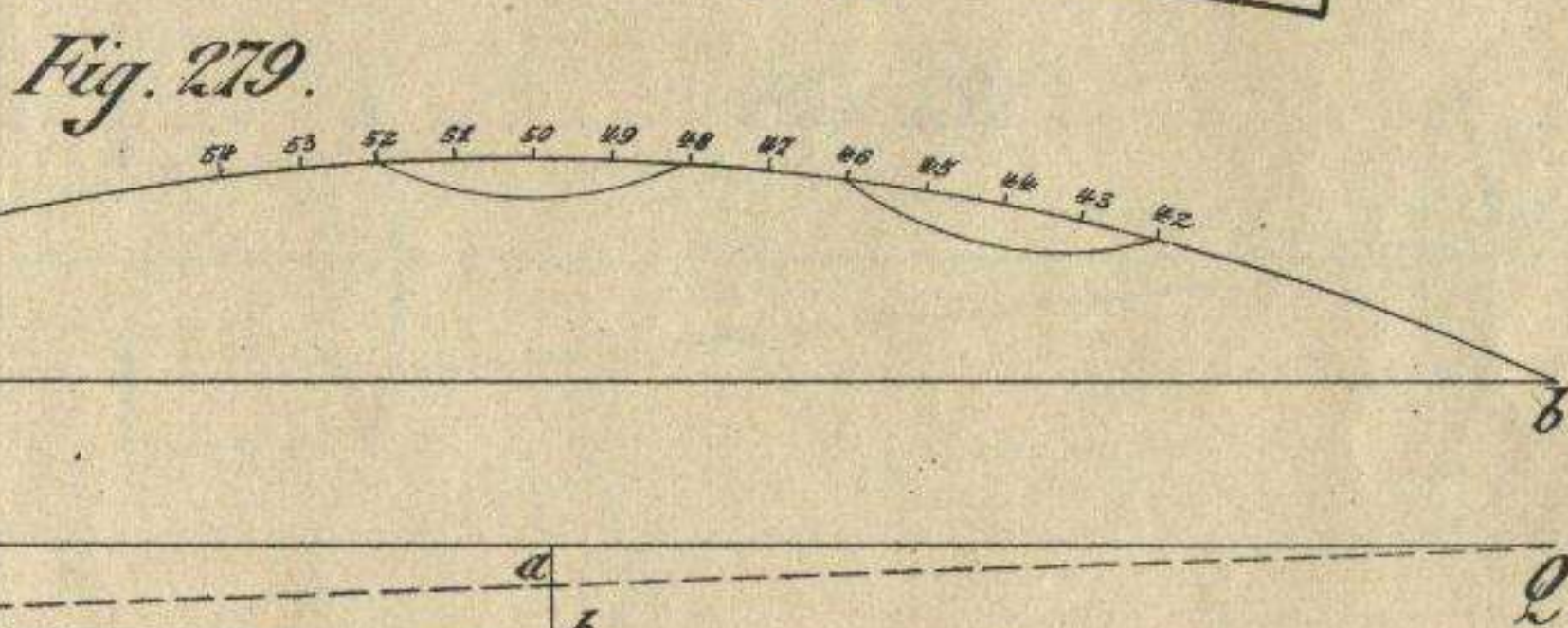
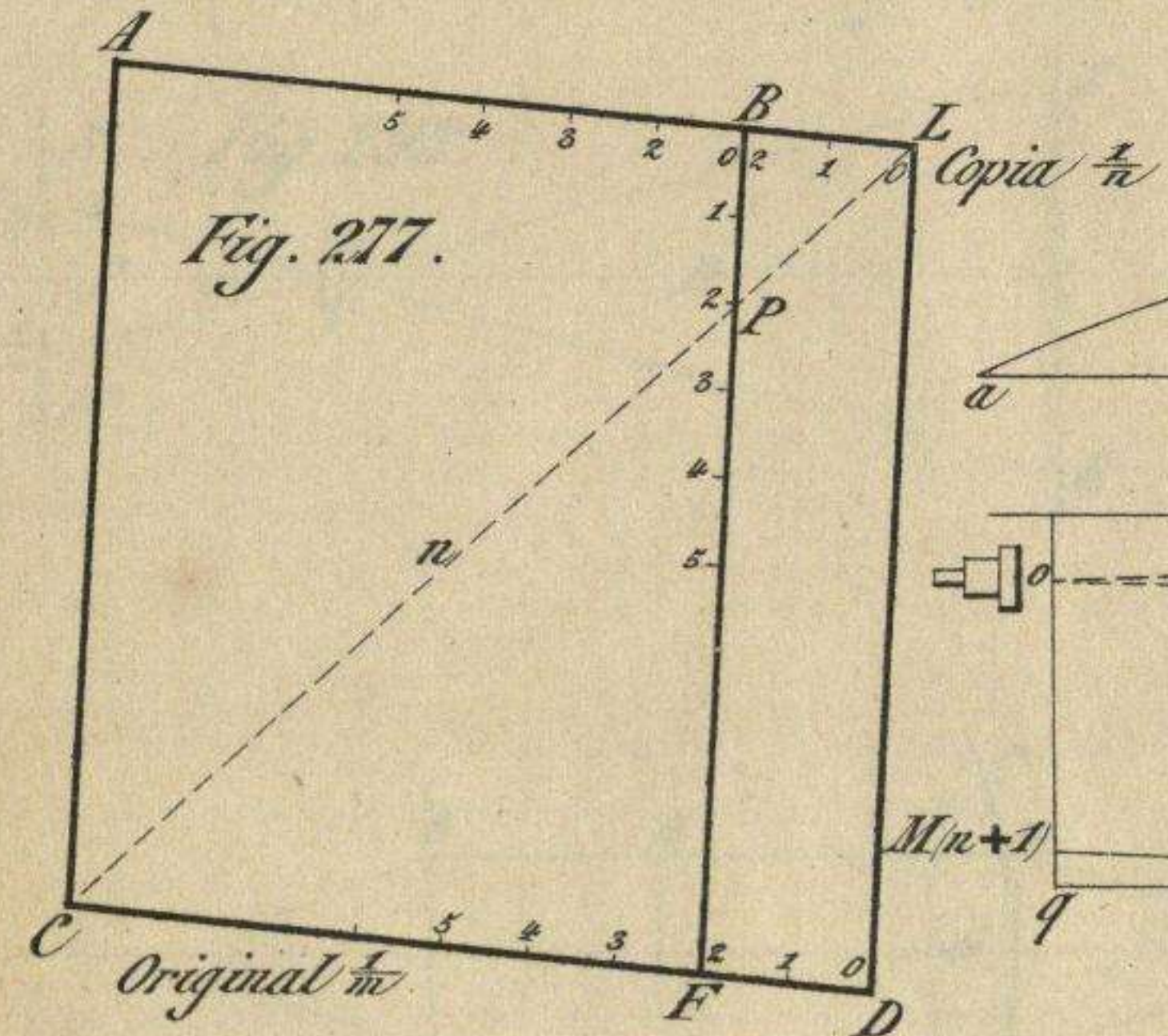
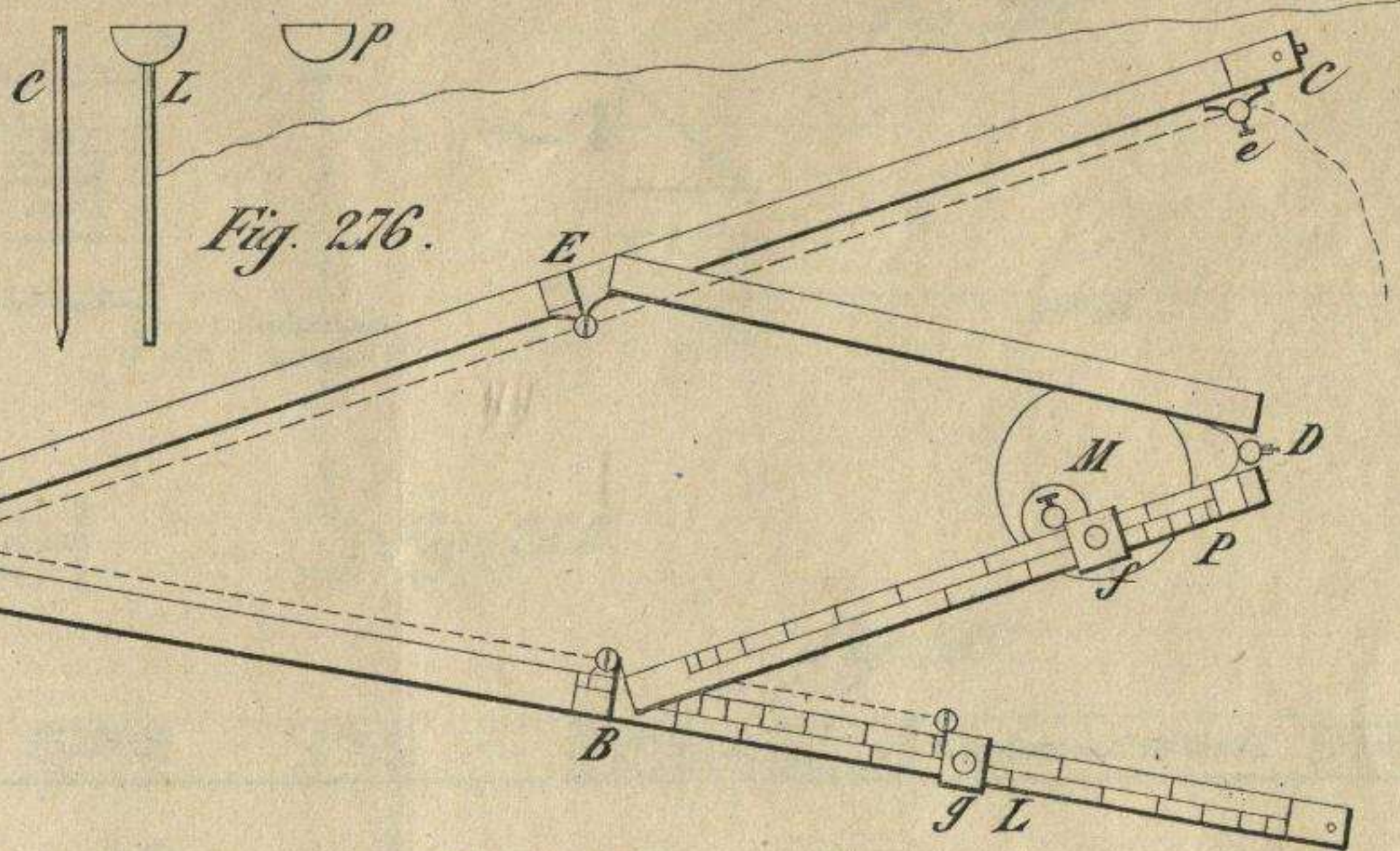
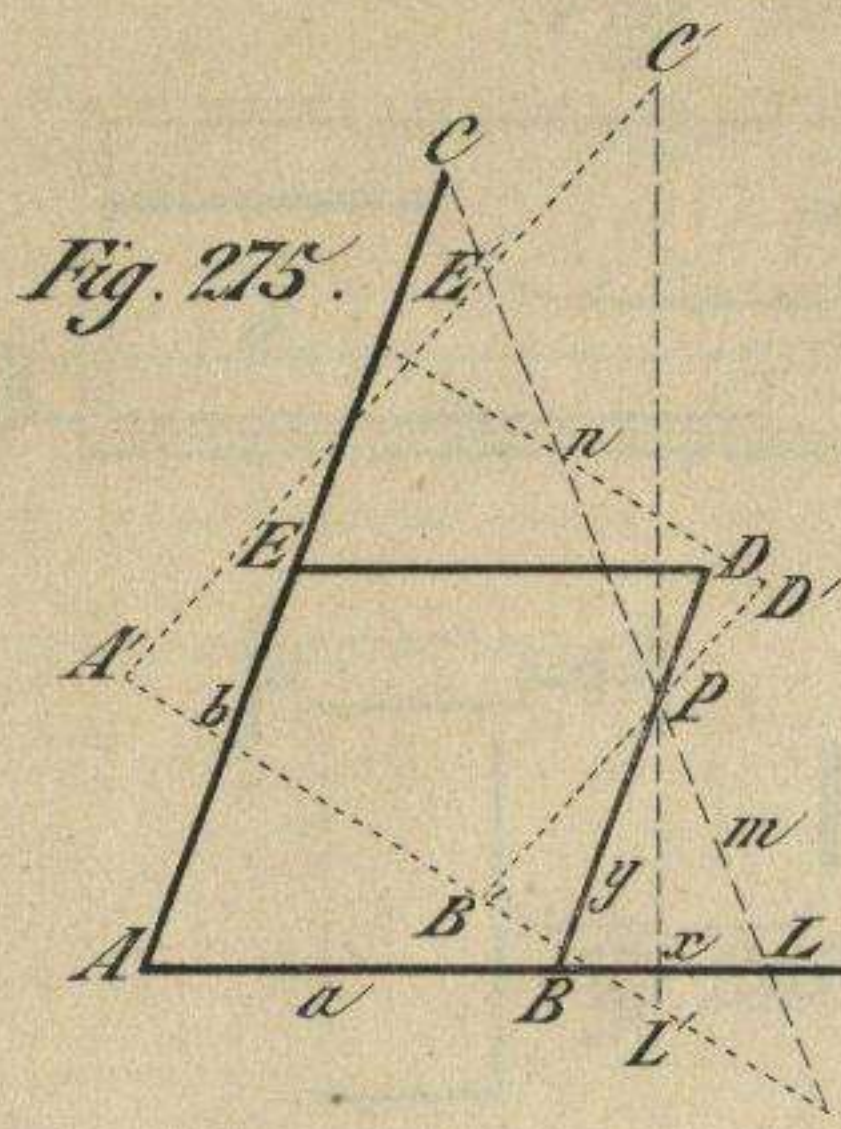

Fig. 274.







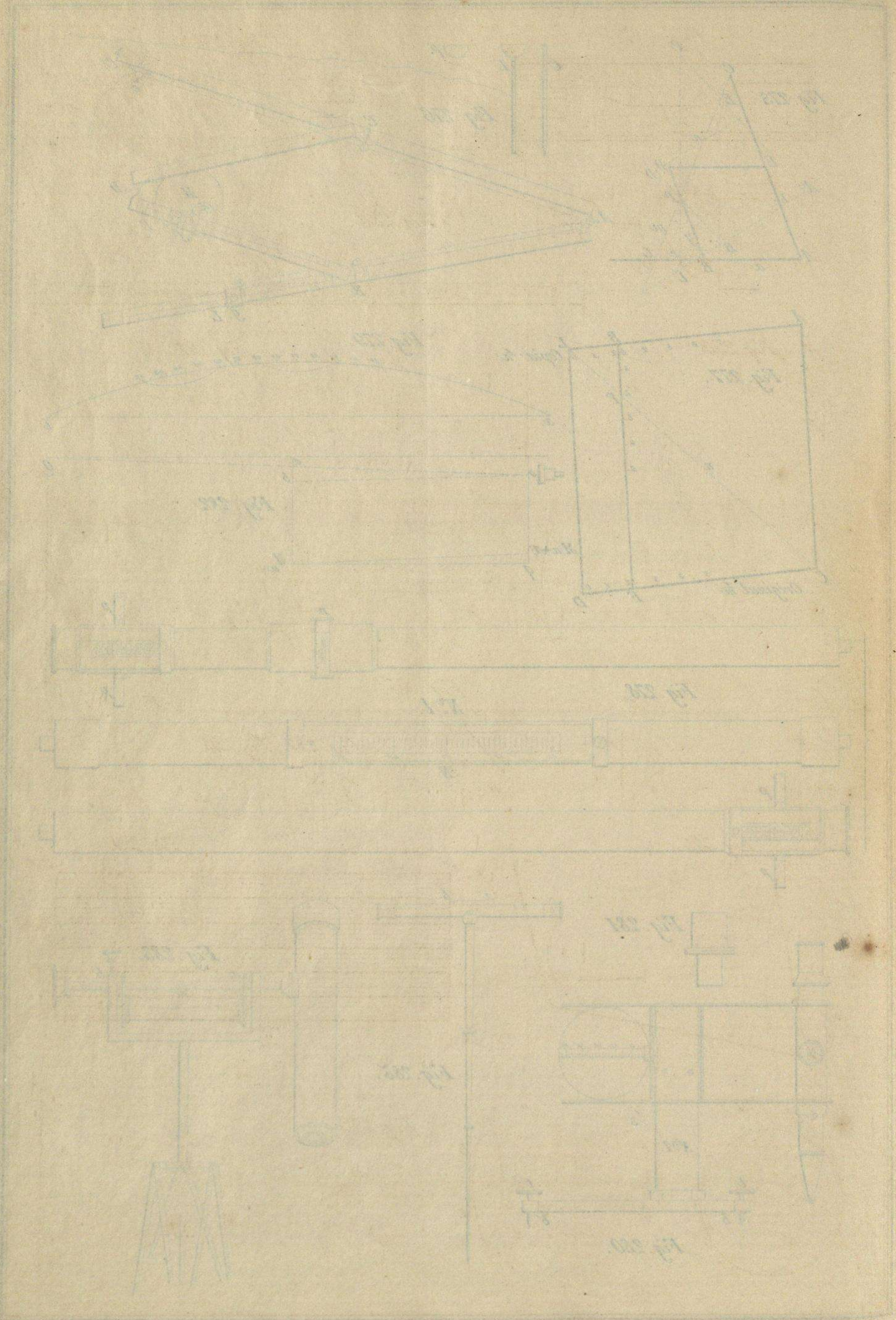

Fig. 287.

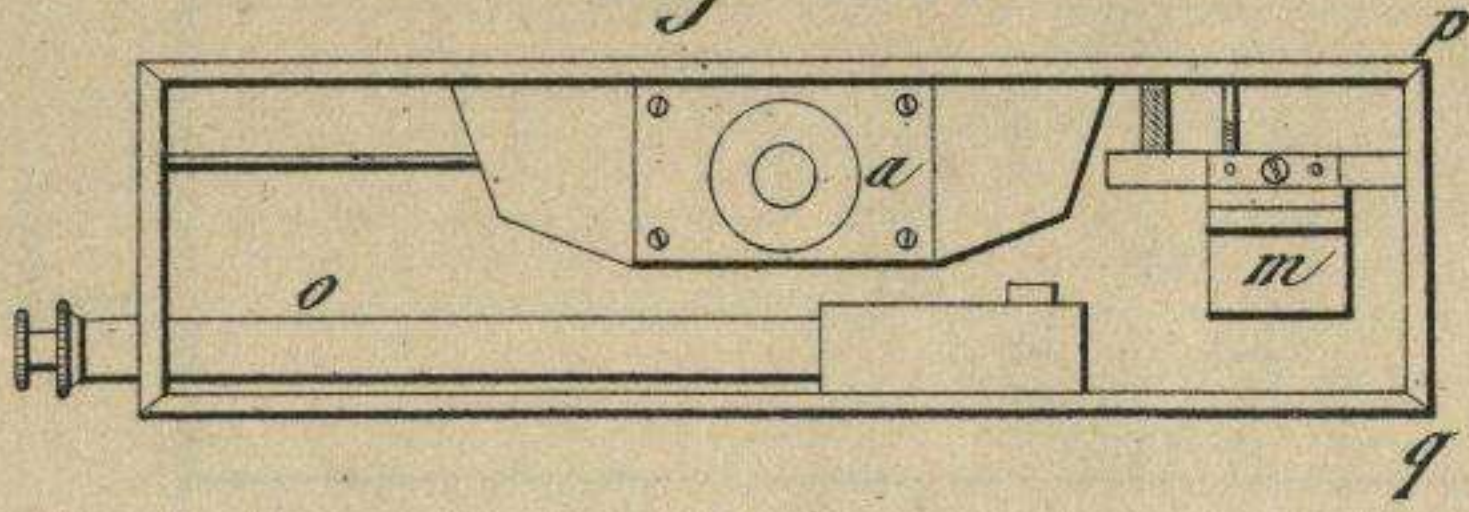

Fig. 288.

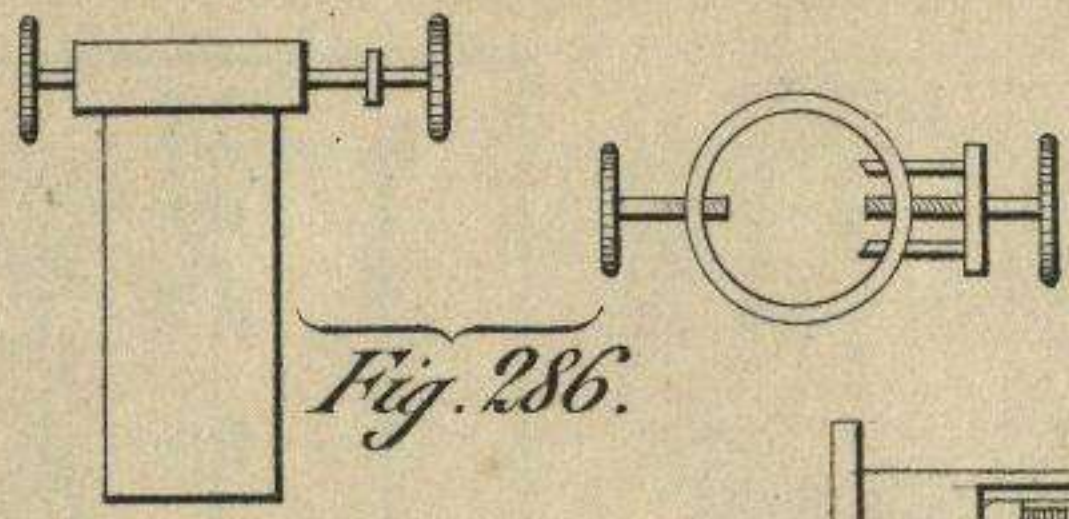
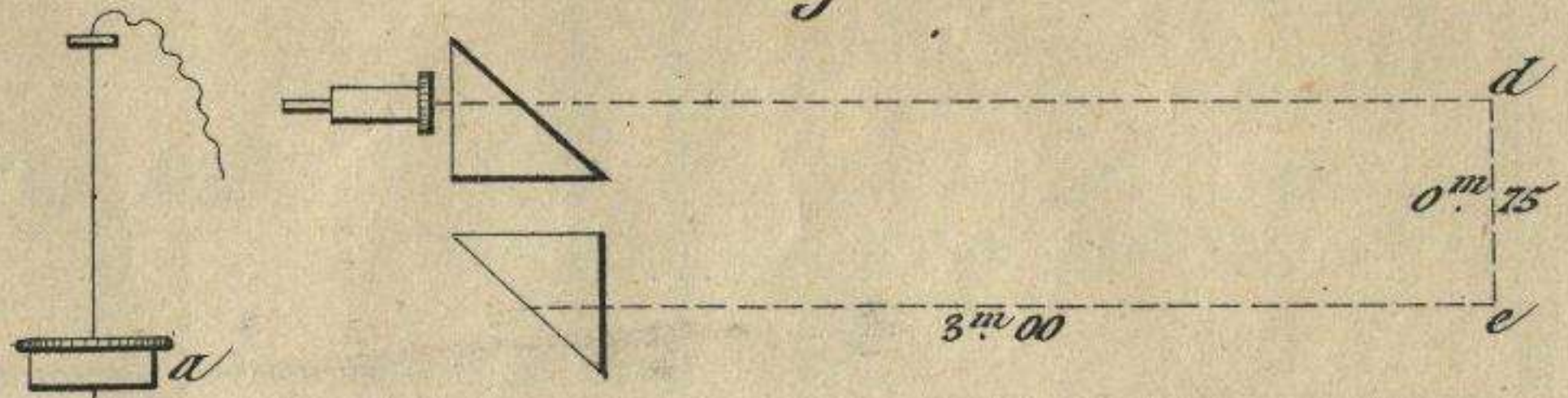

Fig. 286.

Fig. 284.



Fig. 289.

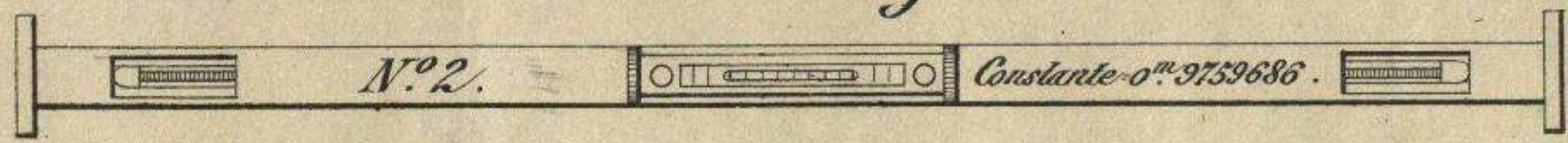

Fig. 290.

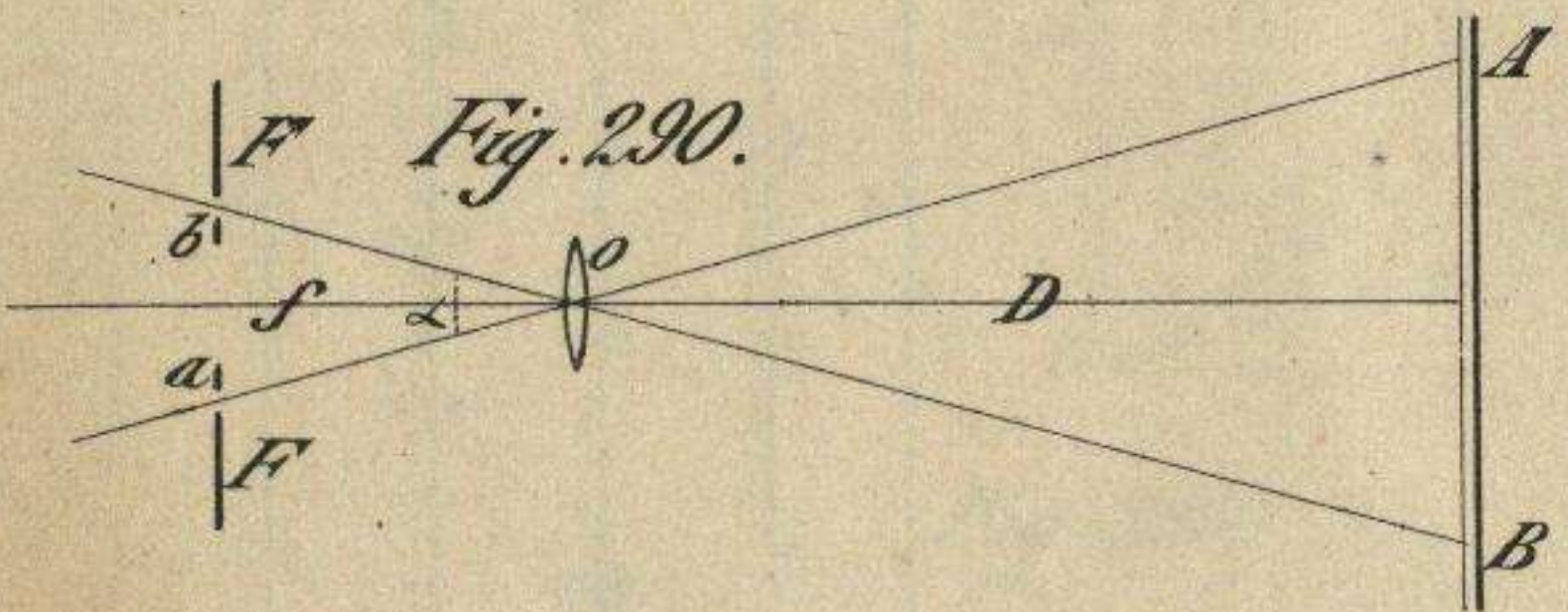

Fig. 291.

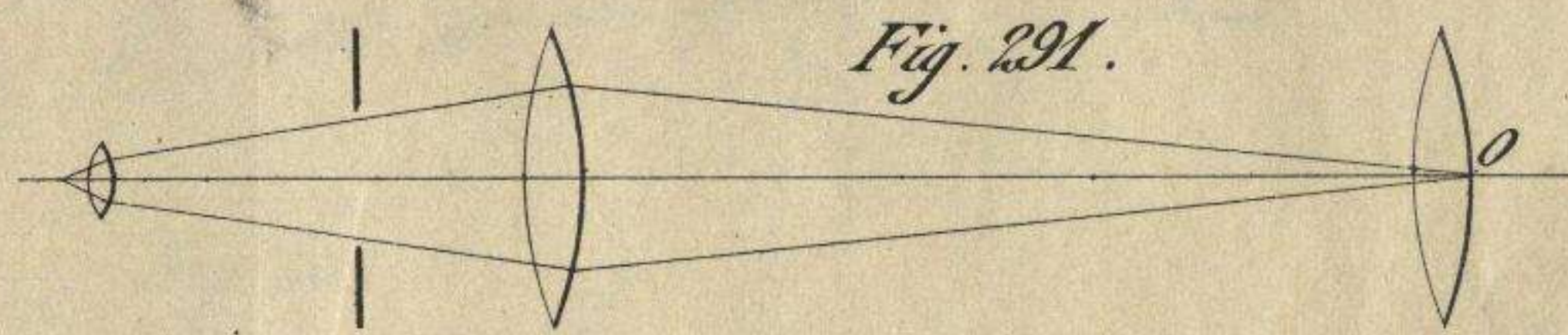

Fig. 293.

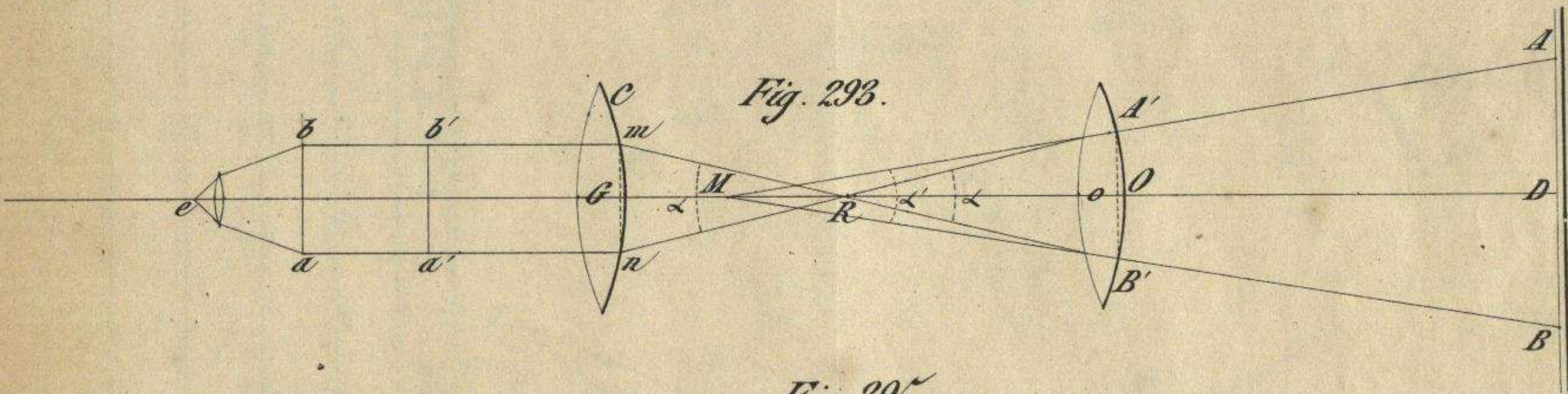

Fig. 295.

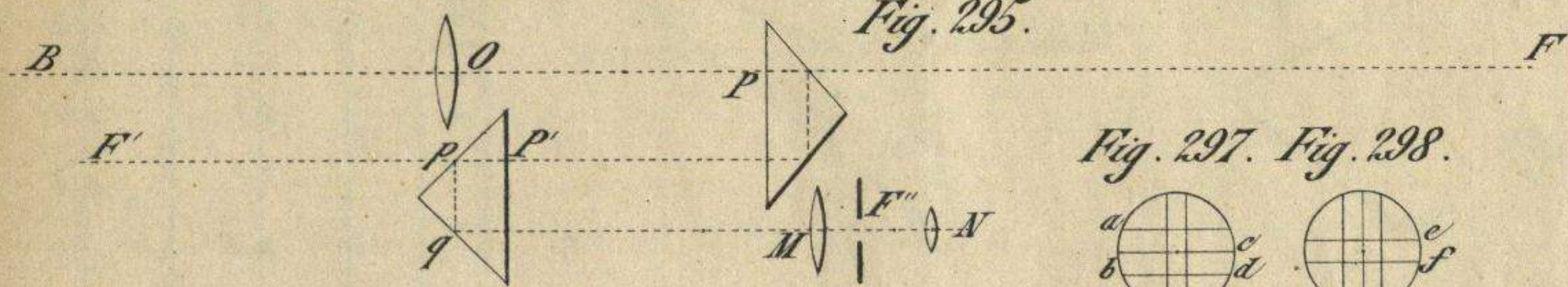

Fig. 297. Fig. 298.

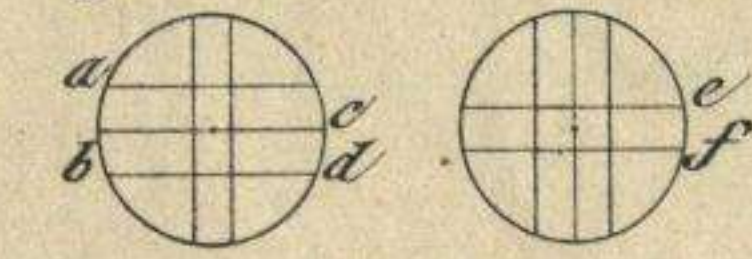

Fig. 296.

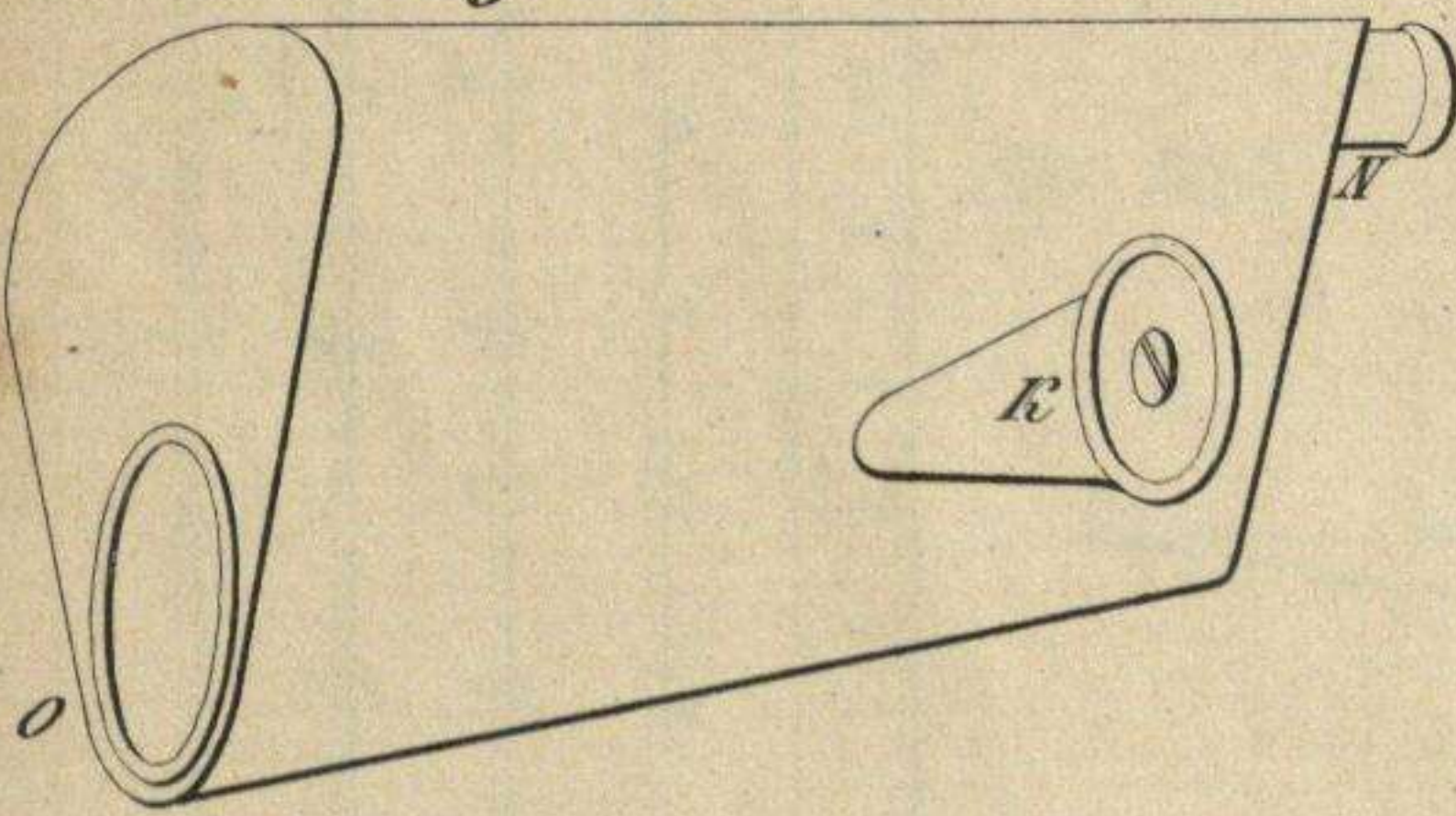

Fig. 299.

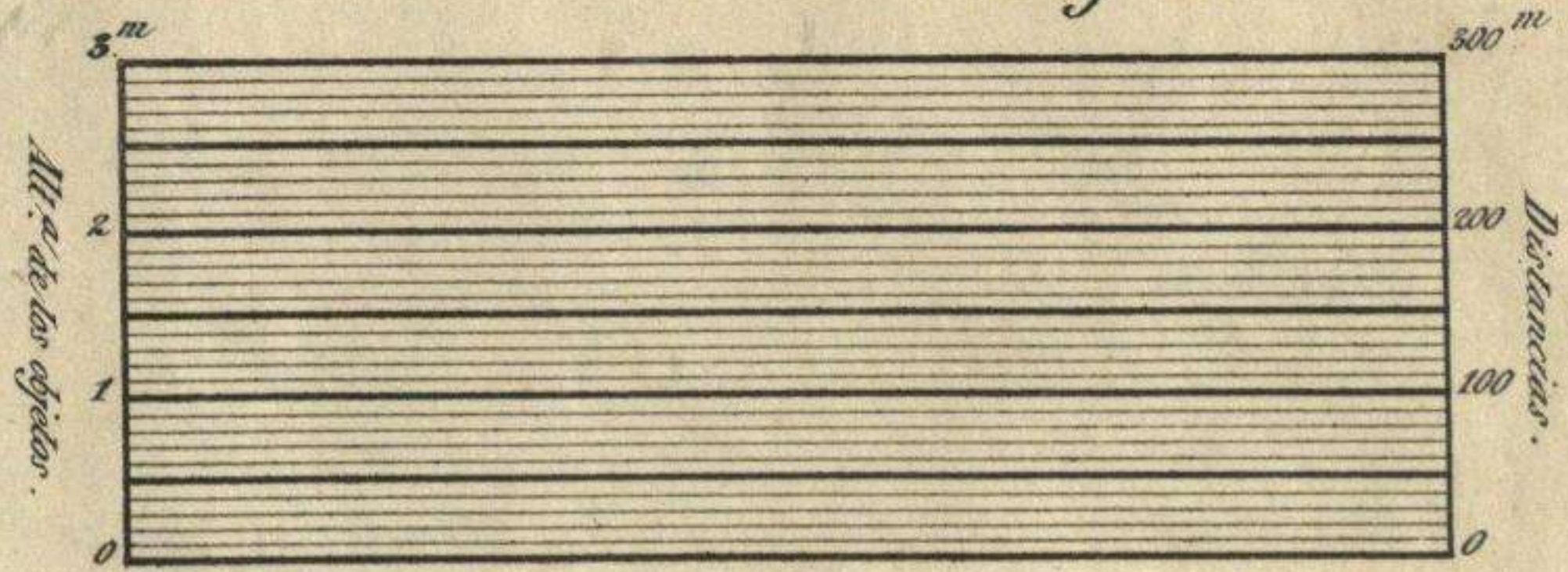

Fig. 294.

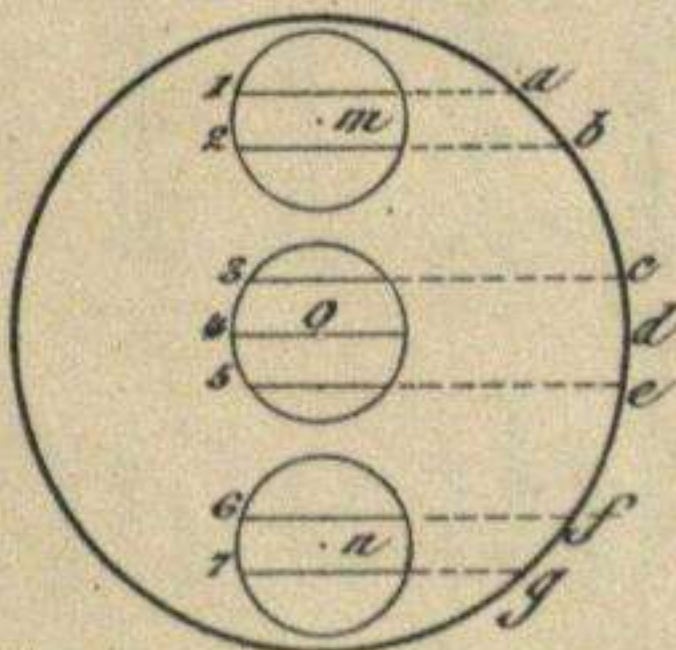
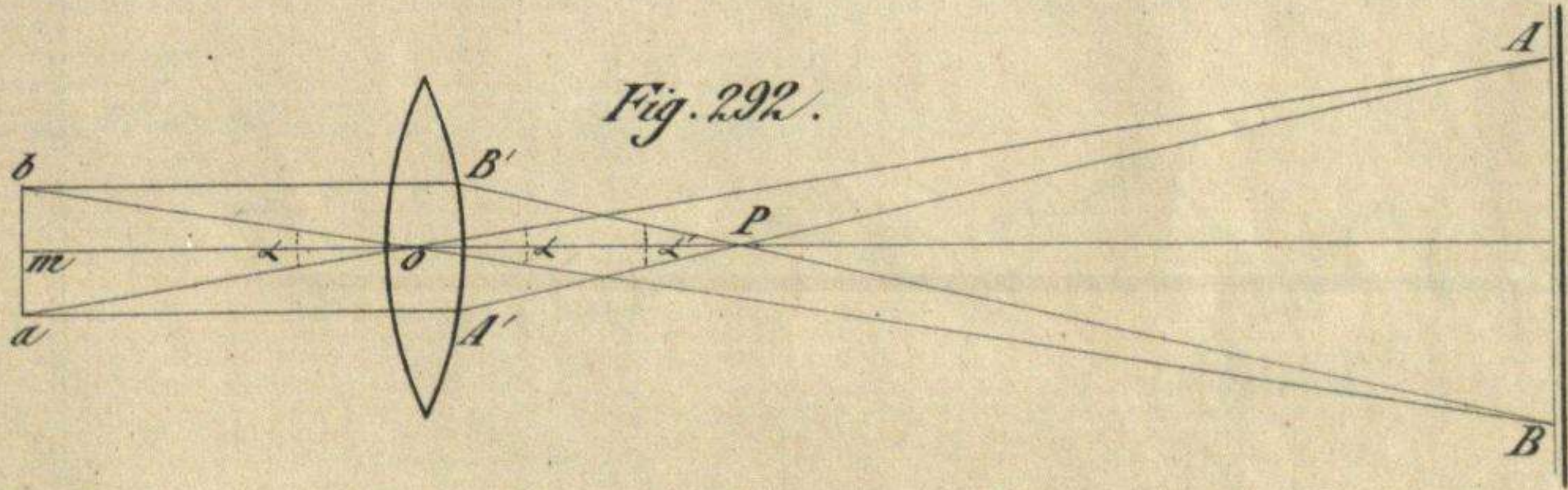
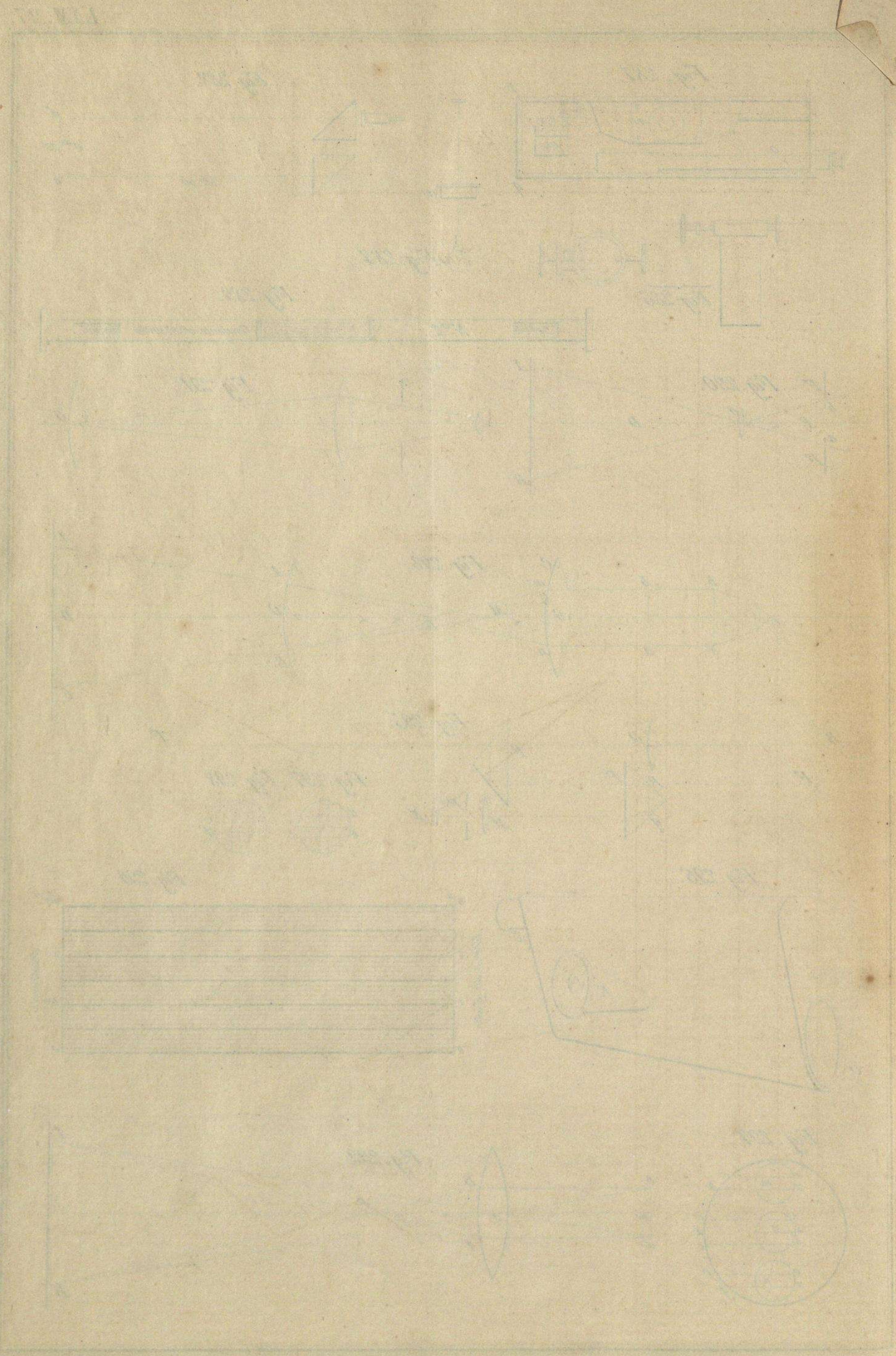

Fig. 292.





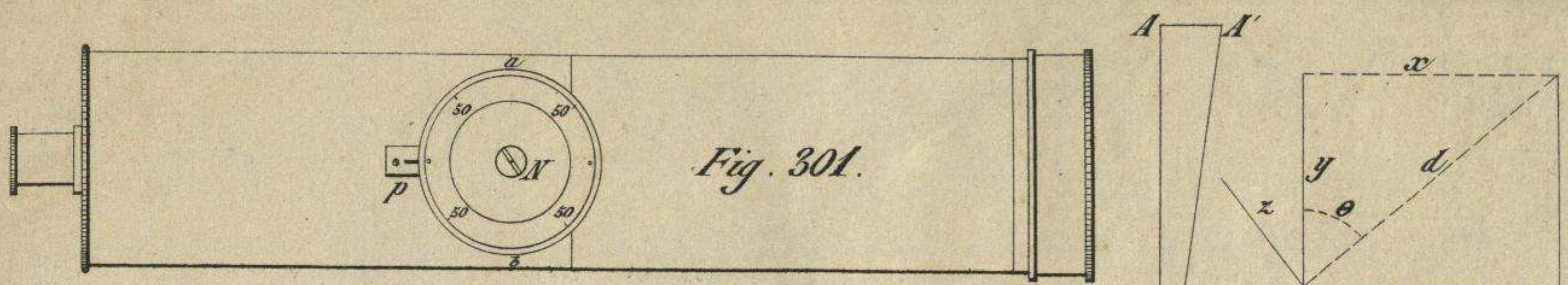

Fig. 301.

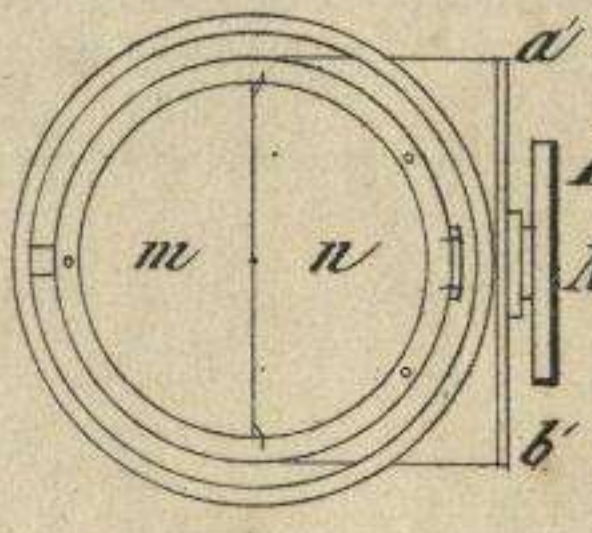

Fig. 300.

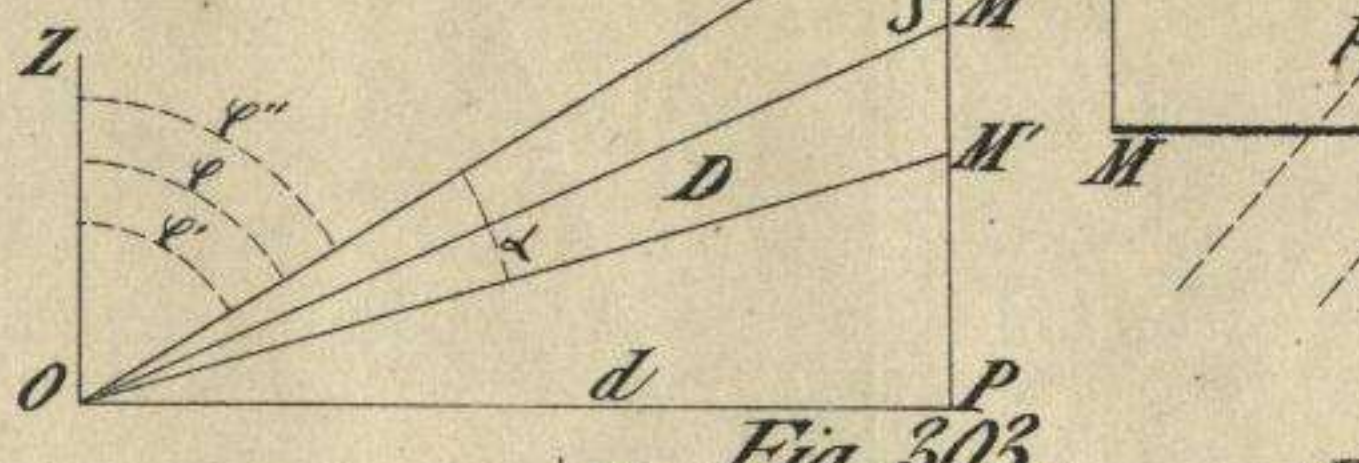

Fig. 303.

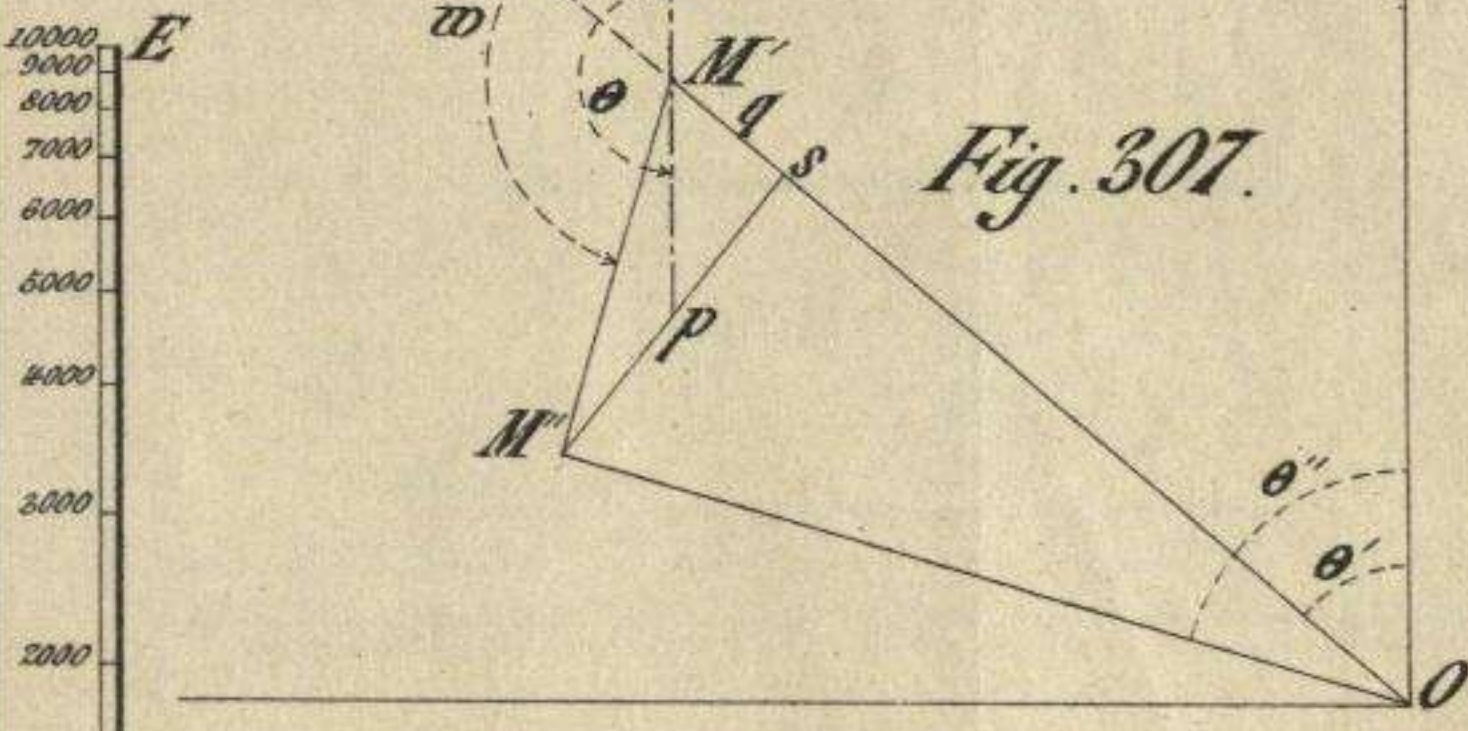

Fig. 307.

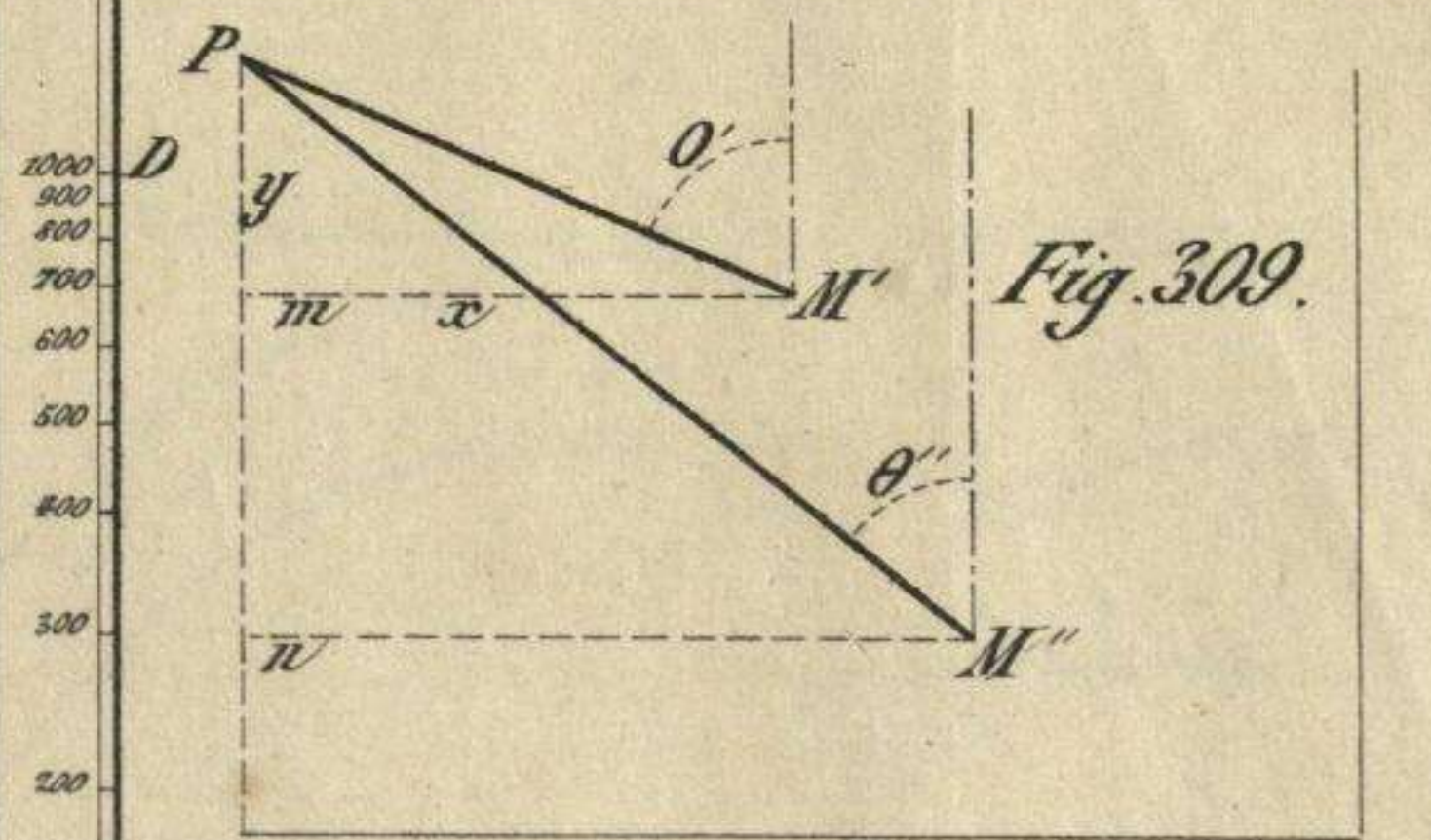

Fig. 309.

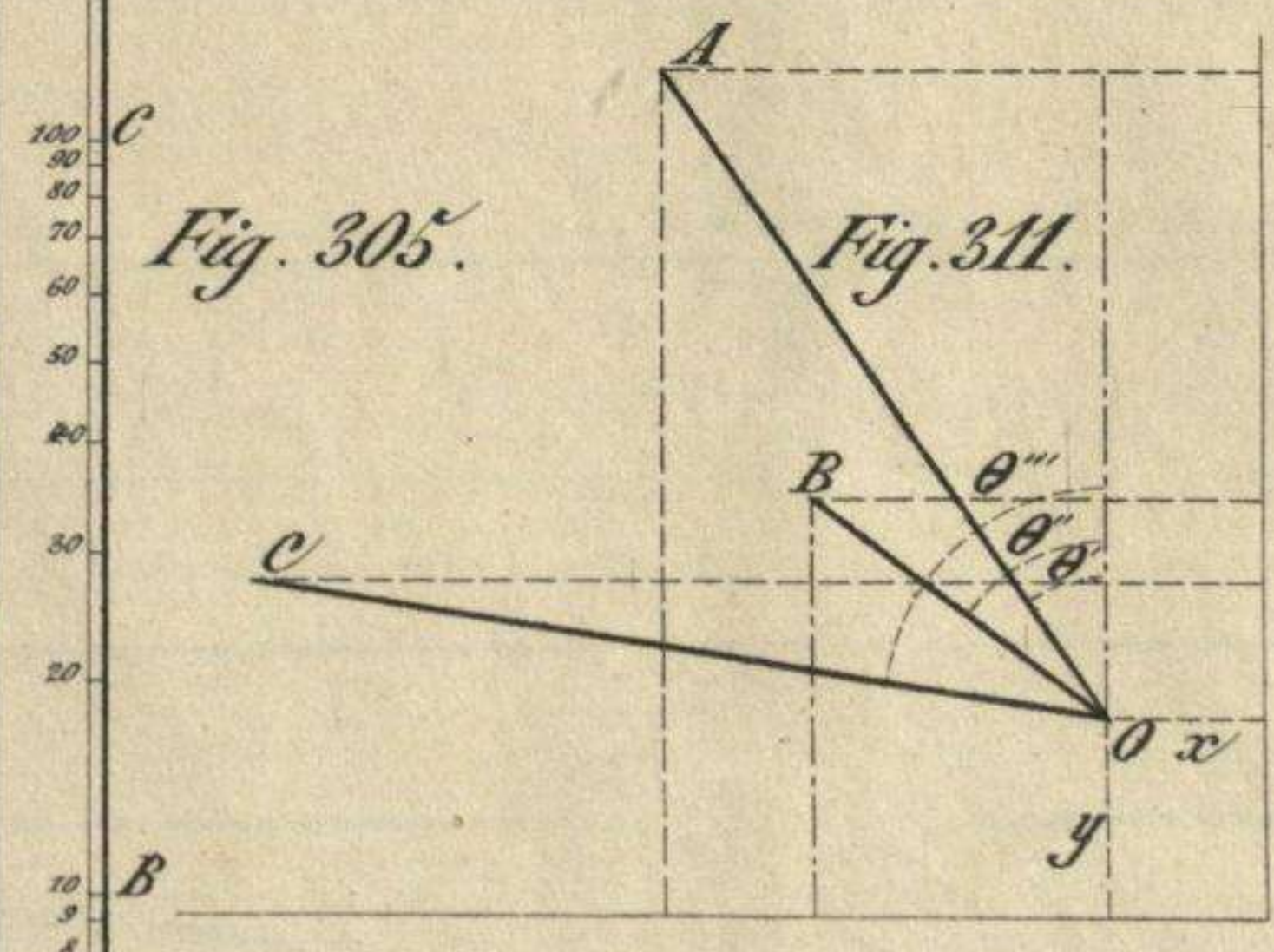

Fig. 311.

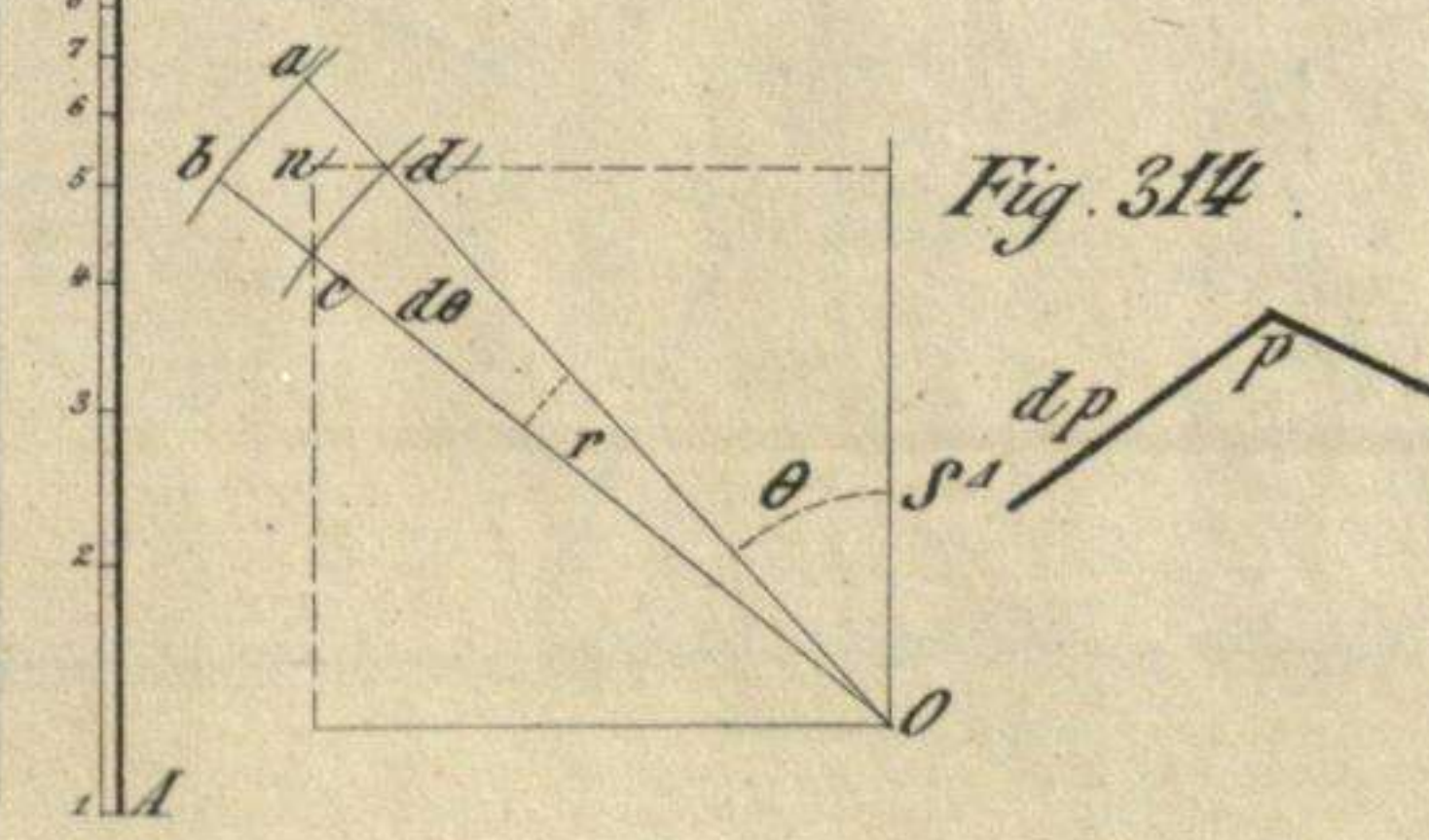

Fig. 314.

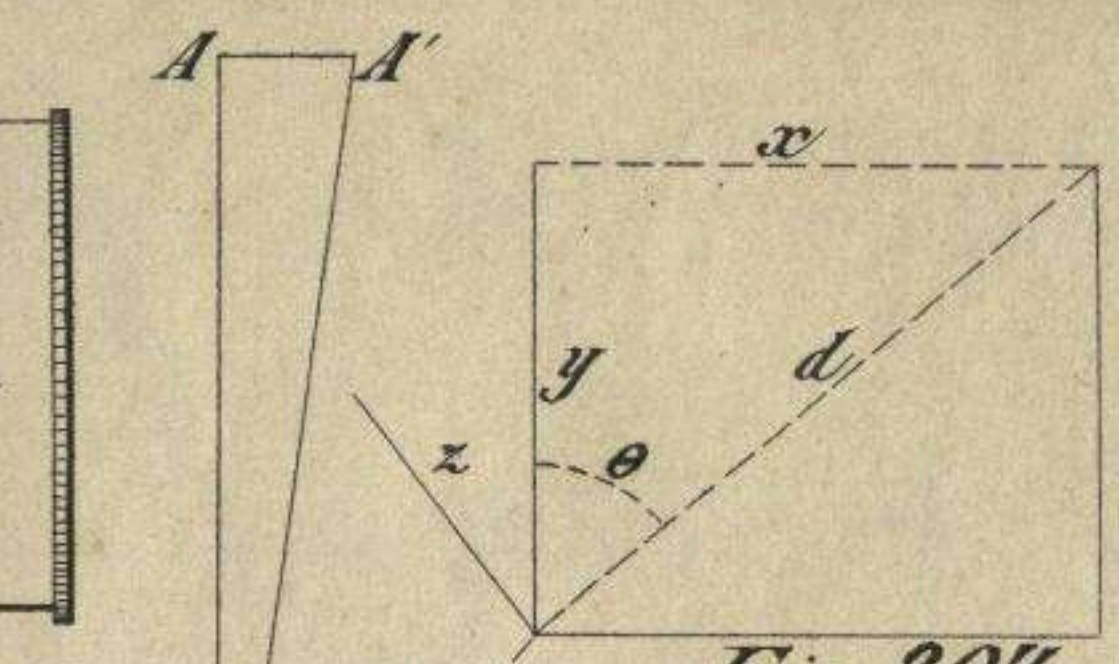

Fig. 304.

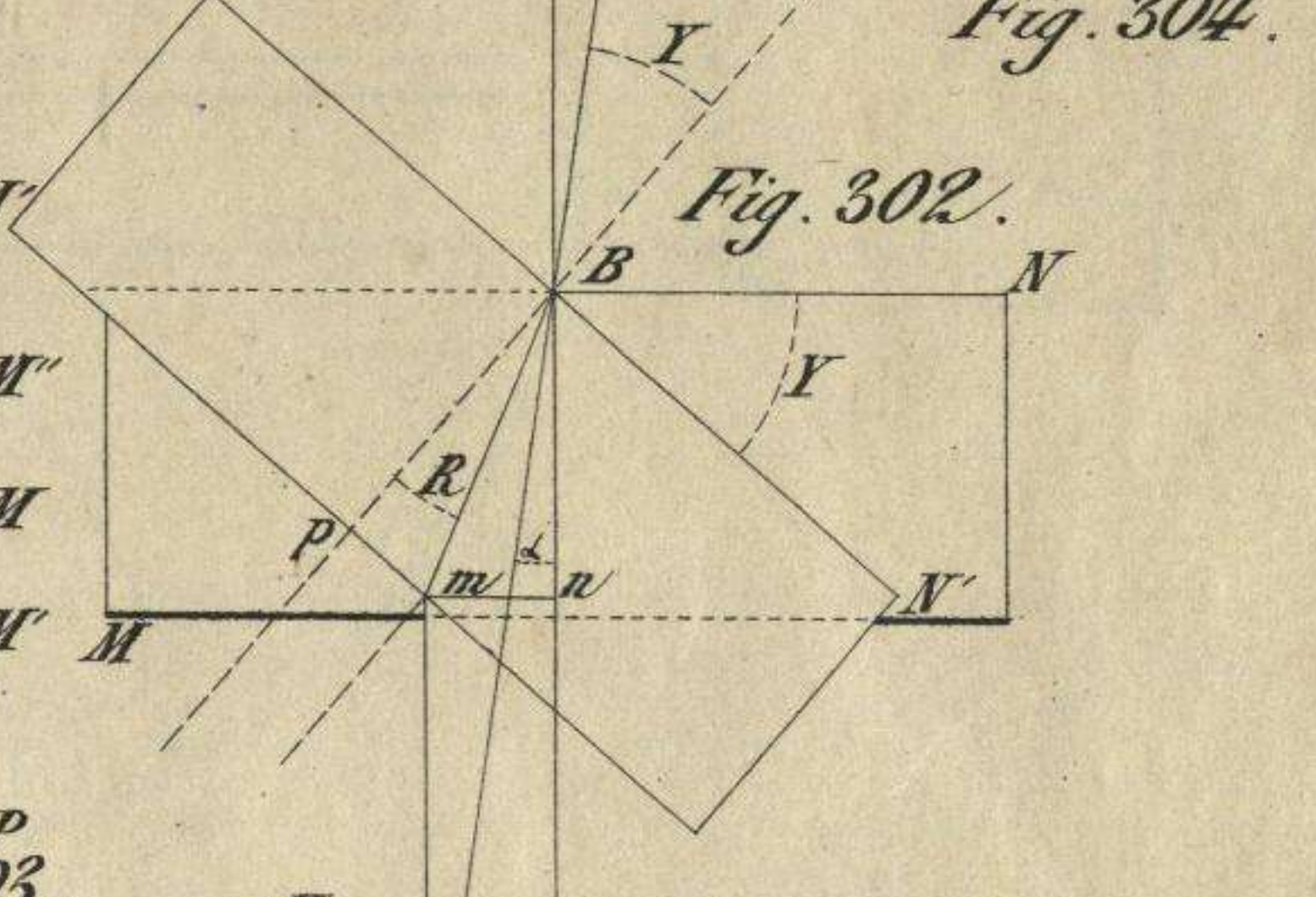

Fig. 302.

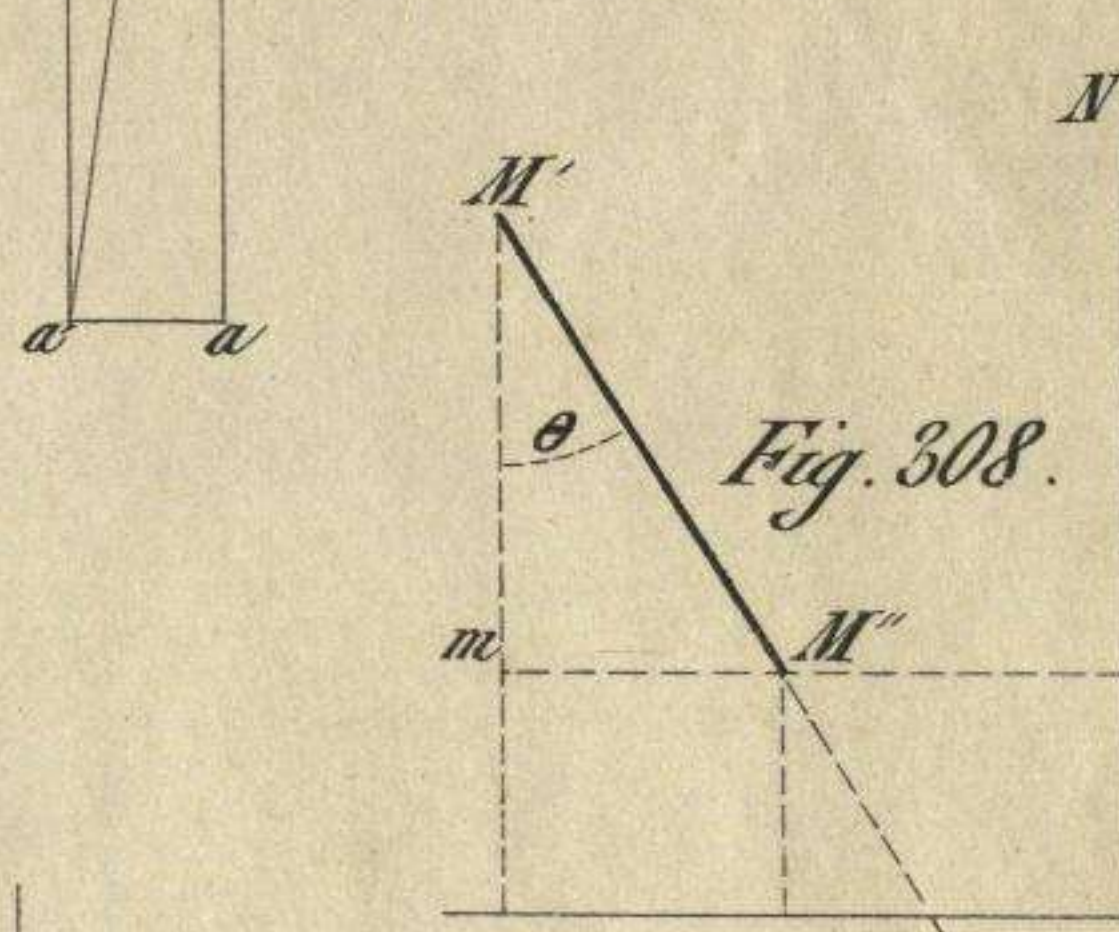

Fig. 308.

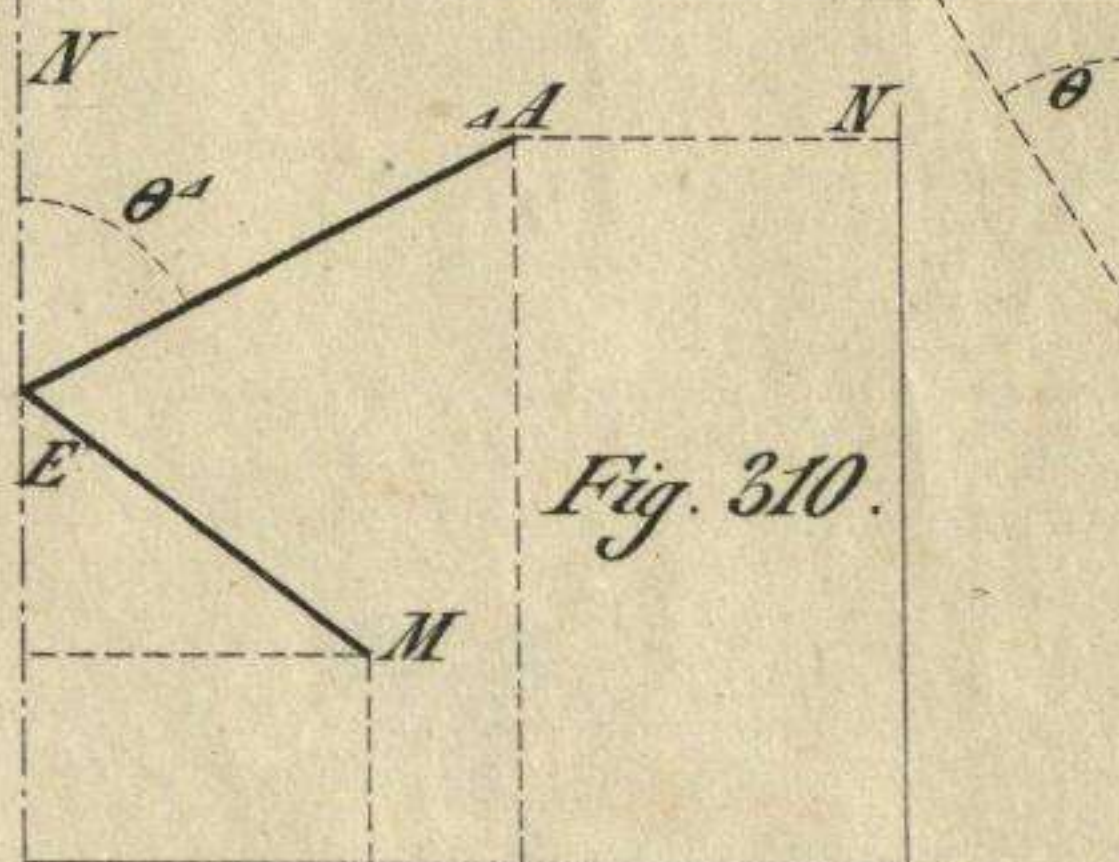

Fig. 310.

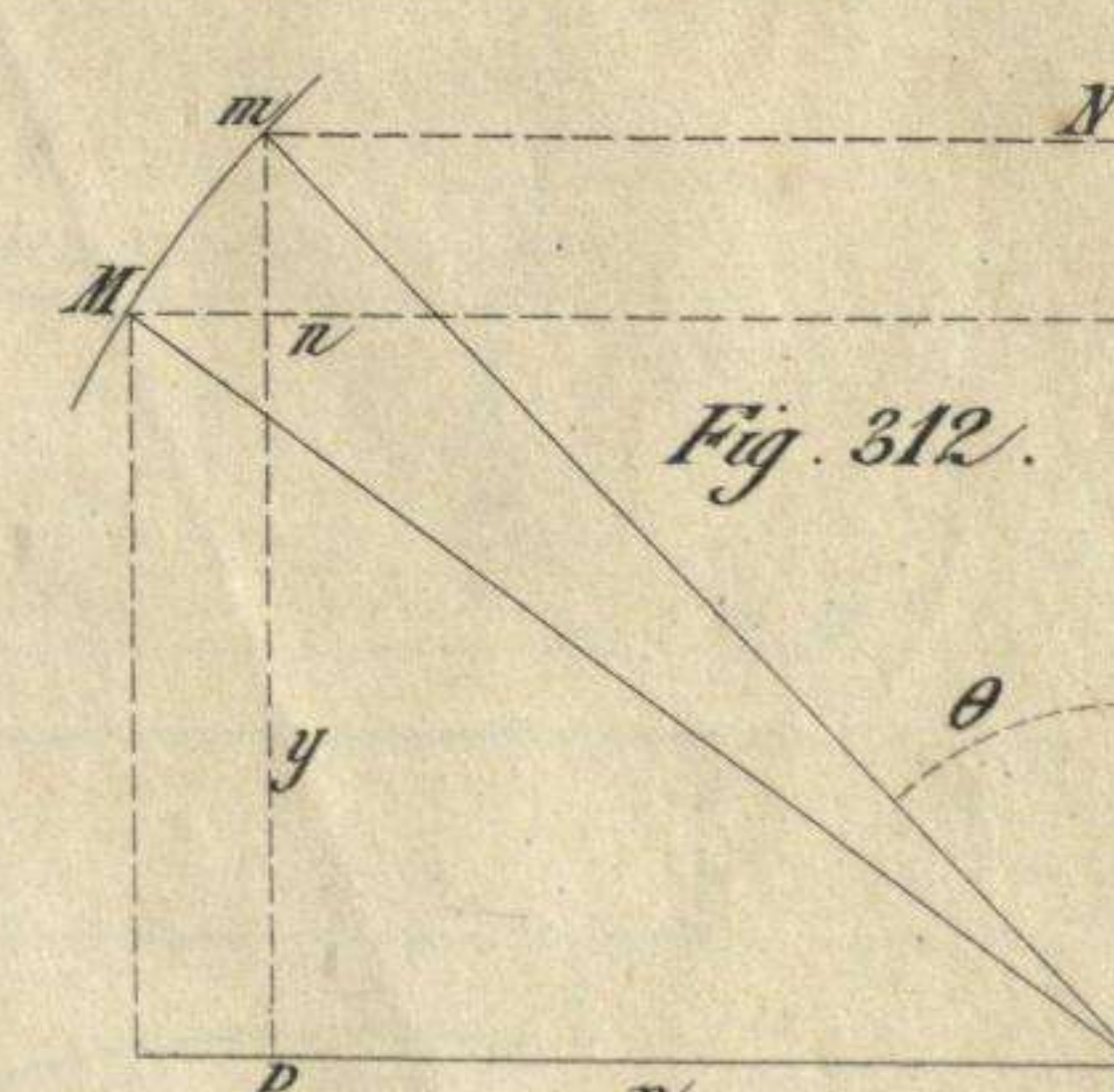

Fig. 312.

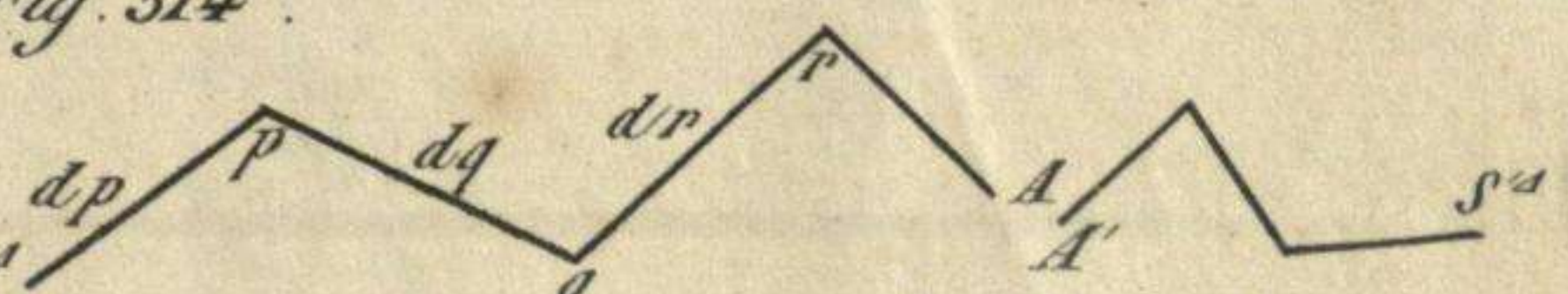

Fig. 315.

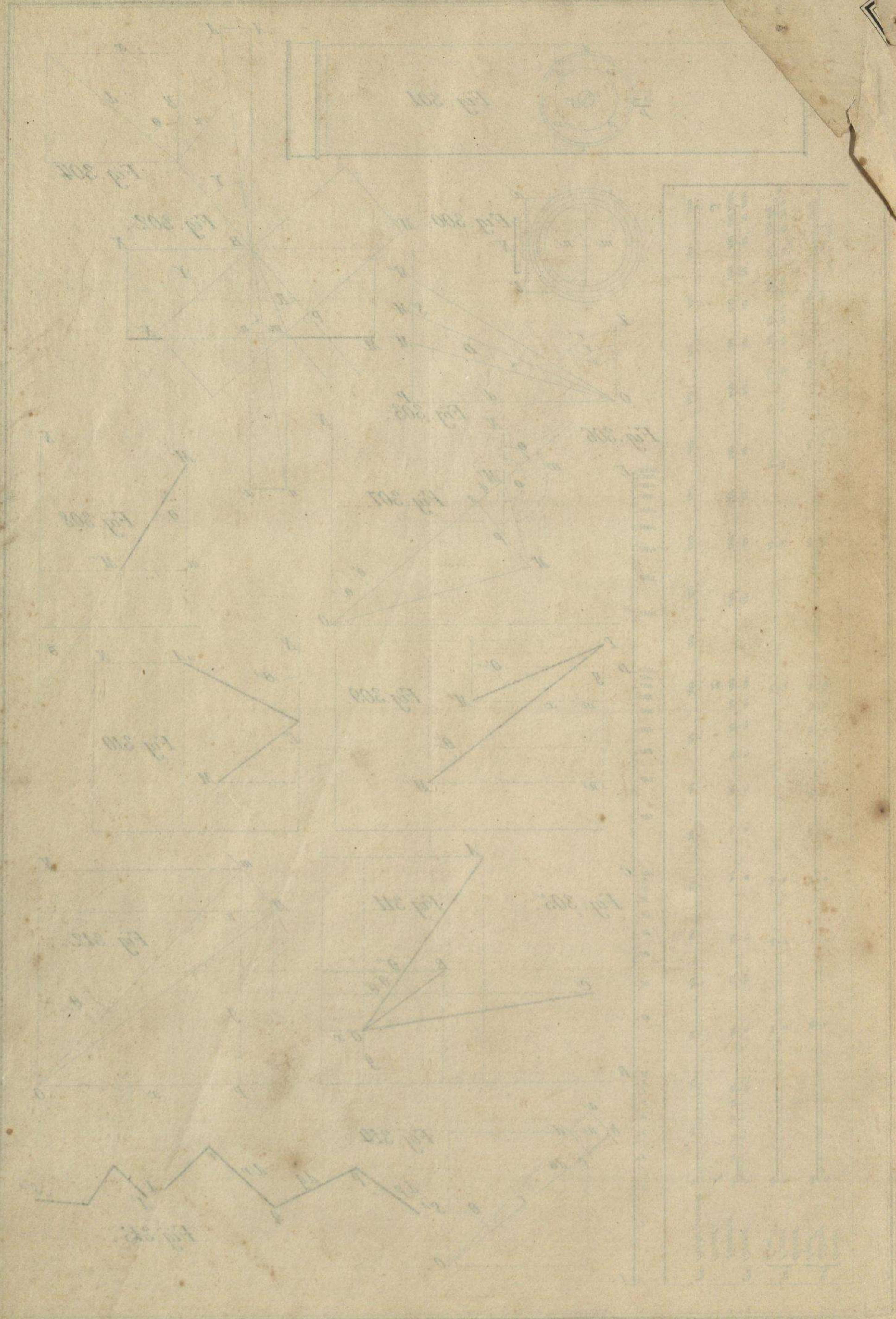
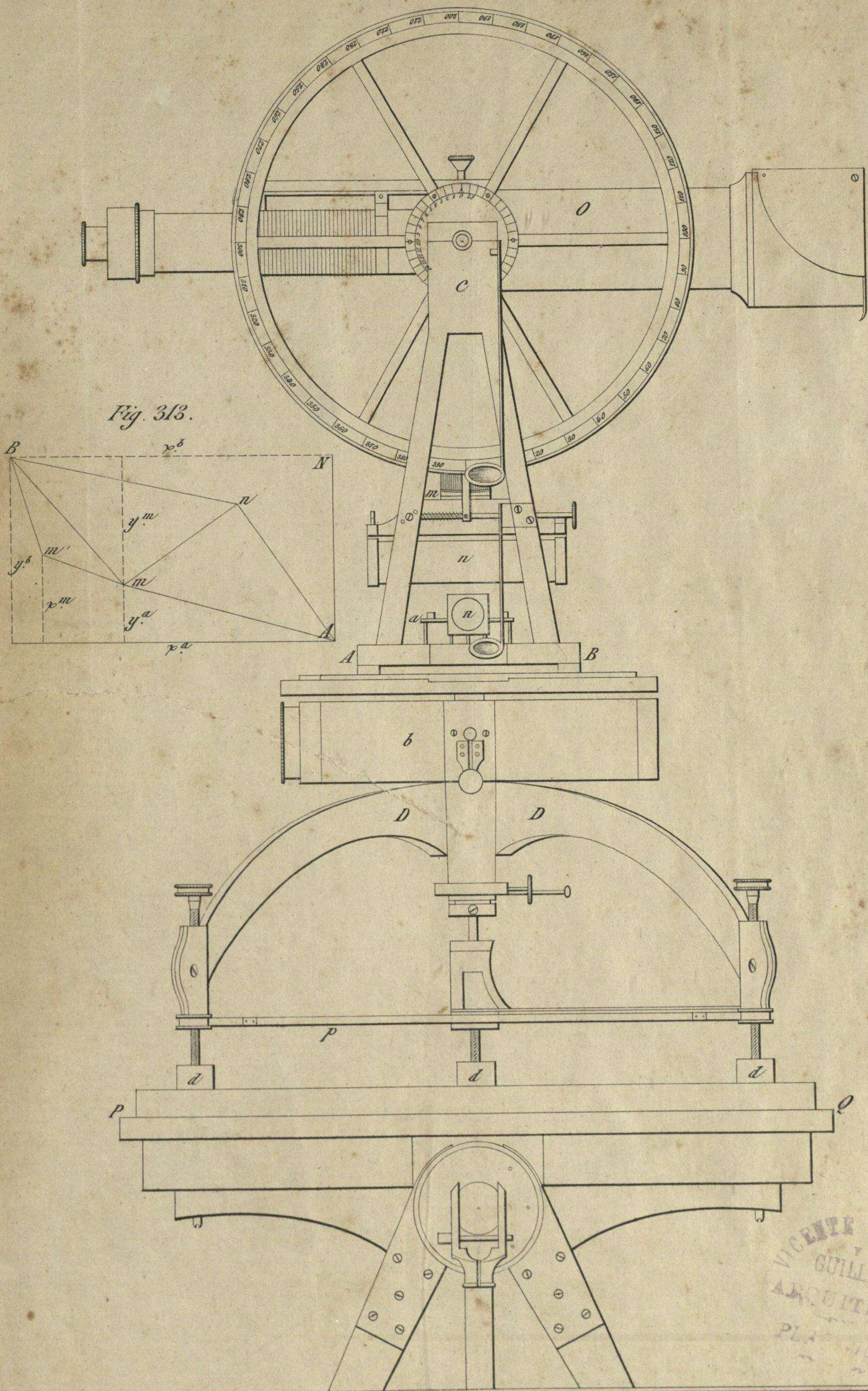

Fig. 313.



VICENTE TARRA
Y GUILLEM
ARQUITECTO
PLAZA DE
S. JACINTO

