

SOCIEDAD ANÓNIMA
FÁBRICA DE MIERES

—||—
HIERROS

—◇—
CONSTRUCCIONES METÁLICAS

—◇—
CARBONES Y COK

—⊙—
ÁLBUM
DE HIERROS ESPECIALES

Y
CONSTRUCCIONES METÁLICAS

—◇—
Abril de 1892

SOCIEDAD ANÓNIMA
FÁBRICA DE MIERES



HIERROS



CONSTRUCCIONES METÁLICAS



CARBONES Y COK



ÁLBUM

DE HIERROS ESPECIALES

Y

CONSTRUCCIONES METÁLICAS



Abril de 1892

SOCIEDAD ANÓNIMA

FÁBRICA DE MIERES

Domicilio social y Dirección: MIERES (Asturias)

FÁBRICA DE MIERES

HIERROS LAMINADOS de diversas formas y tamaños.

CONSTRUCCIONES METÁLICAS; puentes, calderas, vigas armadas, tinglados, mercados, vagones de hierro para minas y otros.

CARBONES GRASOS, gruesos y menudos lavados.

COK, muy superior para cubilotes y usos metalúrgicos y domésticos.

Para PEDIDOS, PROYECTOS y CONDICIONES, dirigirse al **Sr. Presidente de la Sociedad: MIERES (Asturias.)**

SOCIEDAD ANÓNIMA
FÁBRICA DE MIERES

CARBONERAS DE SIERO Y LANGREO

—=—
CARBONES SECOS

cribados y menudos para la producción de vapor

Puerto de embarque, **GIJÓN**

—◇—
Para PEDIDOS dirigirse al Representante
de la Sociedad: **GIJÓN (Asturias.)**

—=—
LA SOTERRAÑA

—=—
AZOGUE Y REJALGAR

Fabricación en **MUÑÓN CIMERO**

—◇—
Para PEDIDOS dirigirse al Sr. Director **D. Alejandro Vanstralen: POLA DE LENA**
(Asturias.)

FÁBRICA DE MIERES

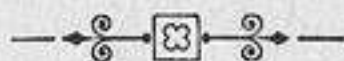

HIERROS DIVERSOS.—DIMENSIONES CORRIENTES

REDONDOS

de 6 á 69 m/m de m/m en m/m
de 70 á 162 m/m de 2 en 2 m/m



CUADRADOS

de 6 á 33 m/m de m/m en m/m
de 34 á 45 m/m de 2 en 2 m/m
de 45 á 70 m/m de 5 en 5 m/m
de 70 á 100 m/m de 5 en 5 m/m



FLEJES

de 12 á 16 m/m × n.^{os} 9 á 18
de 16 á 50 m/m × n.^{os} 9 á 20
de 52 á 75 m/m × n.^{os} 9 á 18
de 76 á 100 m/m × n.^{os} 9 á 17
de 105 × n.^{os} 9 á 16
de 107 × " "
de 110 × " "
de 116 × " "
de 126 × " "
de 130 y 136 × n.^{os} 9 á 15
de 140 y 150 × n.^{os} 9 á 14



PLETINAS, LLANTAS Y PLANOS

de 10 á 20 × 4 á 10 m/m por m/m
de 20 á 110 × 4 y más de 2 en
2 m/m
de 116—126—130—136—140—
150—160 × 6 á 30.
de 180—200—250—300 × 7 á
30 m/m
de 400—500 × 9 á 30 m/m

PLANCHAS

de 3 á 4 m/m . . . 3 × 1' m
de 4 á 13 m/m . . . 5 × 1'20 m
de 14 á 30 m/m . . . 5 × 1'10 m



CORTADILLOS

de todas dimensiones



CARRILES

de 4'50 kilogrs. por metro
de 8' " "
de 12' " "
de 16' " "



LLANTAS DE COCHE

de 36 m/m × 12 á 24 m/m
de 38 m/m × " "
de 40 m/m × " "
de 42 m/m × " "
de 45 m/m × " "
de 50 m/m × " "

Para otros hierros de formas especiales, véanse las láminas.







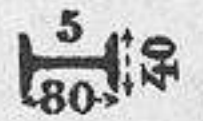

La fábrica puede laminar dimensiones distintas de las señaladas, con pedidos importantes.

Se construyen vigas armadas de formas

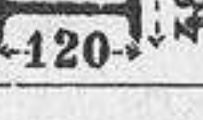
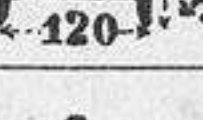
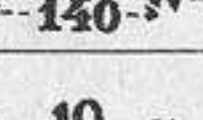

CUADRO

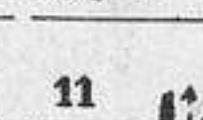

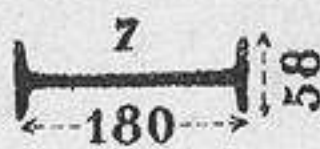
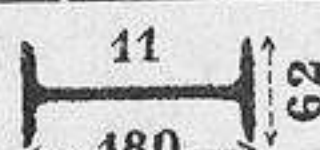
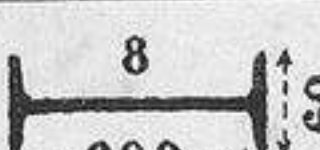
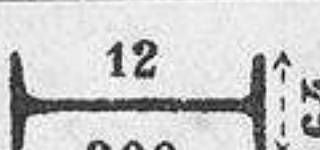
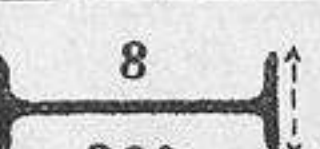
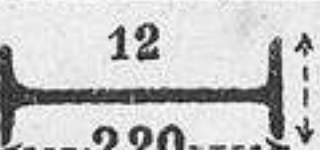
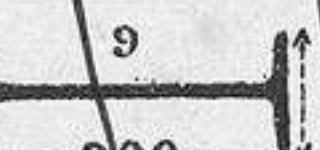
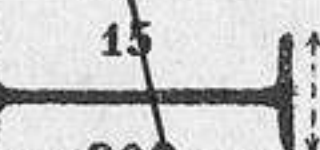
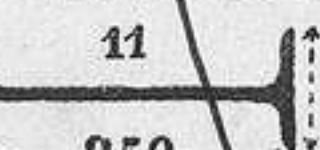
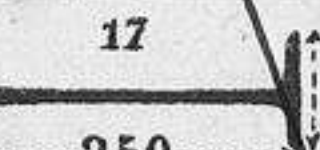

de perfiles de viguetas, pesos por metro y cargas máximas que pueden sostener descansando libremente sobre apoyos distantes de 2 á 8 metros para resistencias R de 8 y 10 kilogramos por milímetro cuadrado

PERFILES	PESO por metro — Kilogs.	VALORES DE - R. -	Cargas generales uniformemente repartidas en kilogs. para longitudes en metros de												
			2	2'50	3	3'50	4	4'50	5	5'50	6	6'50	7	7'50	8
Nº1 	7	8	675	540	450	386	337	300	270	245	225	208	193	180	169
		10	843	675	562	482	421	375	333	307	281	259	241	225	211
Nº2 	10	8	859	687	573	492	429	383	344	312	287	265	245	229	215
		10	1074	858	715	613	537	477	428	390	357	331	306	286	268
Nº3 	9	8	1028	823	687	588	514	457	412	375	342	316	294	274	257
		10	1285	1027	856	734	642	570	513	467	428	395	367	342	321
Nº4 	13	8	1342	1074	894	767	671	596	537	488	446	413	383	358	335
		10	1678	1344	1118	958	839	745	671	610	559	517	479	448	419
Nº5 	12	8	1616	1288	1076	924	808	712	644	588	536	495	460	430	404
		10	2020	1610	1345	1155	1010	890	805	735	670	618	575	537	505
Nº6 	16	8	1848	1472	1232	1054	924	816	736	672	616	565	525	490	460
		10	2310	1840	1540	1320	1155	1020	920	840	770	706	656	612	575
Nº7 	14	8	2096	1744	1252	1088	1048	968	872	792	724	670	624	580	545
		10	2620	2180	1565	1360	1310	1210	1090	990	905	837	780	725	681
Nº8 	18	8	2496	1992	1664	1424	1248	1108	996	908	832	765	710	665	620
		10	3120	2490	2080	1780	1560	1385	1245	1135	1040	956	852	798	744
Nº9 	16	8	3024	2416	2016	1728	1512	1344	1208	1100	1008	930	860	805	755
		10	3780	3020	2520	2160	1890	1680	1510	1375	1260	1162	1075	1006	944
Nº10 	24	8	3800	3028	2516	2152	1900	1676	1508	1372	1256	1160	1075	1005	940
		10	4750	3770	3145	2690	2375	2095	1885	1715	1570	1450	1344	1256	1175

PERFILES	PESO por metro — Kilogs.	VALORES DE - R. -	Cargas generales uniformemente repartidas en kilogs. para longitudes en metros de													
			2	2'50	3	3'50	4	4'50	5	5'50	6	6'50	7	7'50	8	
Nº11 	20	8 10	3802 4752	3041 3801	2535 3169	2172 2715	1901 2376	1690 2112	1520 1900	1382 1727	1267 1584	1170 1462	1086 1357	1014 1267	950 1187	
Nº12 	28	8 10	5042 6302	4032 5040	3360 4200	2880 3600	2521 3151	2222 2777	2016 2520	1832 2290	1680 2100	1552 1940	1440 1800	1344 1680	1260 1575	
Nº13 	22	8 10	4920 6150	3936 4920	3280 4100	2811 3514	2460 3075	2186 2730	1970 2459	1790 2235	1640 2050	1514 1892	1408 1758	1313 1641	1230 1537	
Nº14 	33	8 10	6396 7995	5116 6396	4264 5330	3654 4568	3198 3997	2840 3553	2560 3198	2326 2910	2132 2665	1868 2460	1830 2285	1707 2132	1599 1999	
Nº15 	25	8 10	6261 7820	5000 6260	4170 5220	3570 4470	3130 3910	2780 3470	2500 3130	2270 2840	2080 2600	1920 2410	1790 2230	1670 2080	1560 1950	
Nº16 	36	8 10	8340 10430	6670 8340	5560 6950	4770 5960	4170 5210	3700 4630	3330 4170	3030 3790	2780 3470	2570 3210	2380 2980	2220 2780	2080 2600	
Nº17 	32	8 10	8704 10880	6952 8690	5792 7240	4964 6205	4352 5440	3856 4820	3476 4345	3160 3950	2896 3620	2670 3337	2440 3050	2315 2894	2170 2712	
Nº18 	45	8 10	9752 12190	7800 9750	6504 8130	5576 6970	4878 6090	4336 5420	3896 4870	3544 4430	3248 4060	3000 3750	2780 3475	2600 3250	2430 3037	
Nº19 	45	8 10	14056 17570	11240 14050	9368 11710	8032 10040	7024 8780	6328 7910	5616 7020	5112 6390	4672 5840	4320 5400	4010 5012	3740 4675	3510 4387	
Nº20 	62	8 10	16056 20070	12840 16050	10704 13380	9176 11470	8028 10035	7256 8920	6416 8020	5832 7290	5352 6690	4930 6162	4580 5725	4280 5350	4010 5010	

CUADRO

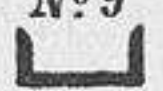
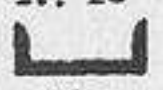
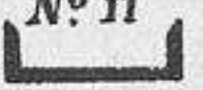
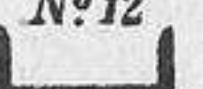
de perfiles en U, peso por metro y cargas máximas que pueden sostener descansando libremente sobre apoyos distantes de 2 á 8 metros para resistencias de 8 y 10 kilogramos por milímetro cuadrado

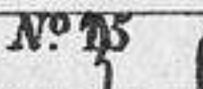
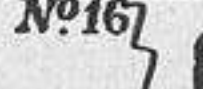
PERFILES	PESO por metro — Kilogs.	VALORES DE - R. -	Cargas generales uniformemente repartidas en kilogs. para longitudes en metros de														
			2	2'50	3	3'50	4	4'50	5	5'50	6	6'50	7	7'50	8		
 N° 7 <80>	11	8	872	698	581	498	436	387	348								
		10	1090	872	726	677	545	484	435								
 N° 8 <80>	14	8	974	587	649	558	487	437	389								
		10	1217	734	811	697	609	546	486								
 N° 9 <120>	15	8	2050	1640	1366	1171	1025	911	820	745	683						
		10	2562	2050	1707	1464	1281	1139	1025	931	854						
 N° 10 <120>	18	8	2300	1849	1532	1357	1150	1023	920	837	766						
		10	2975	2311	1915	1696	1437	1279	1150	1646	957						
 N° 11 <160>	18	8	3435	2748	2290	1963	1718	1527	1374	1249	1145	1057	981				
		10	4294	3435	2862	2454	2147	1908	1717	1561	1431	1321	1226				
 N° 12 <160>	29	8	3835	3081	2556	2196	1918	1707	1534	1395	1278	1180	1095				
		10	4793	3851	3195	2745	2397	2134	1917	1743	1597	1475	1369				
 N° 13 <200>	29	8	6890	5110	4593	3930	3445	3060	2756	2500	2297	2120	1970	1830	1722		
		10	8612	6387	5741	4912	4306	3825	3445	3125	2871	2650	2462	2187	2152		
 N° 16 <200>	36	8	7530	6026	5013	4302	3765	3348	3012	2734	2510	2328	2152	2000	1882		
		10	9412	7532	6266	5377	4706	4185	3765	3417	3137	2897	2690	2500	2352		
 N° 15 <250>	35	8	9880	7900	6590	5640	4940	4390	3950	3590	3290	3040	2820	2630	2470		
		10	12350	9875	8237	7050	6175	5487	4937	4487	4112	3800	3525	3287	3088		
 N° 16 <250>	42	8	11480	9230	7650	6570	5740	5110	4590	4170	3820	3530	3270	3050	2870		
		10	14350	11537	9562	8212	7175	6387	5737	5212	4775	4412	4087	3812	3588		

Observación.

Los hierros señalados con letra a no se hacen aun en esta Fábrica. Se van construyendo los cilindros para laminarlos a medida que pedidos importantes lo requirieren.

FÁBRICA DE MIERES

LLANTAS DE RANURA, DE BISEL Y DE COCHE

NOTA.—El peso por metro es aproximado

De ranura

De coche

De coche

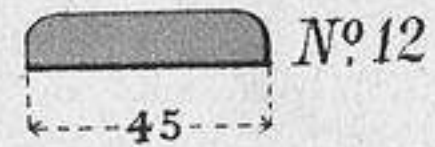
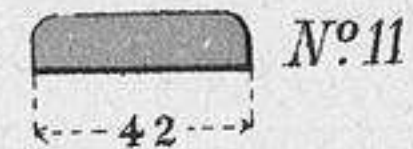
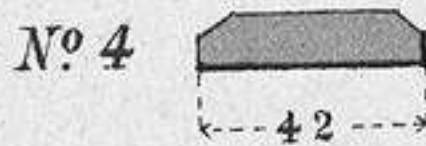
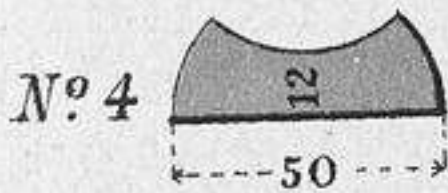
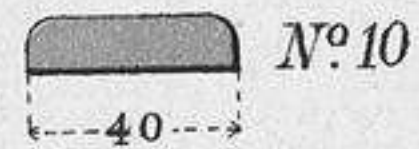
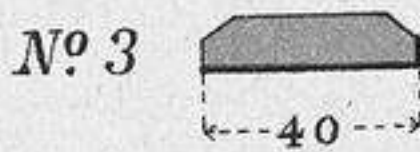
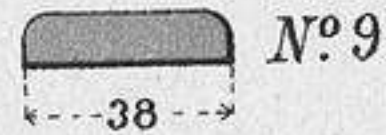
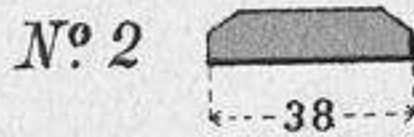
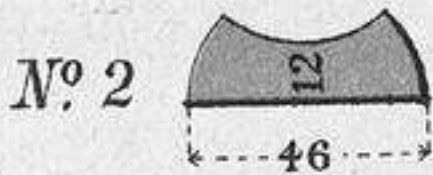

De bisel

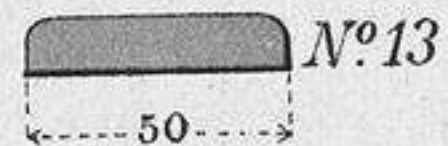
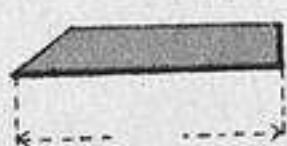

Gruesos comprendidos entre 12 y 24 m/m.

FÁBRICA DE MIERES

HIERROS ESPECIALES

NOTA.—El peso por metro es aproximado

Para fondos de frascos

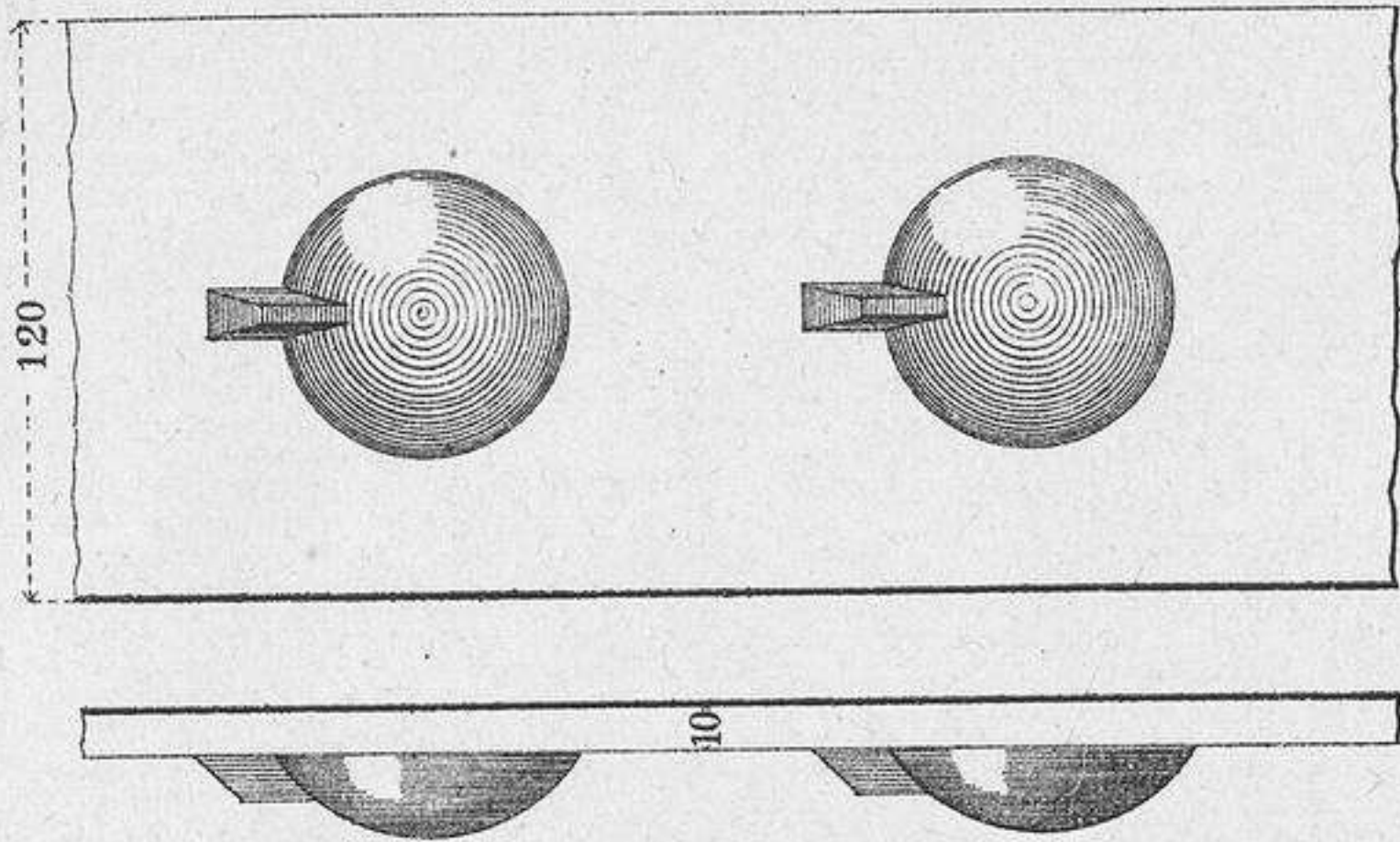

Parrillas

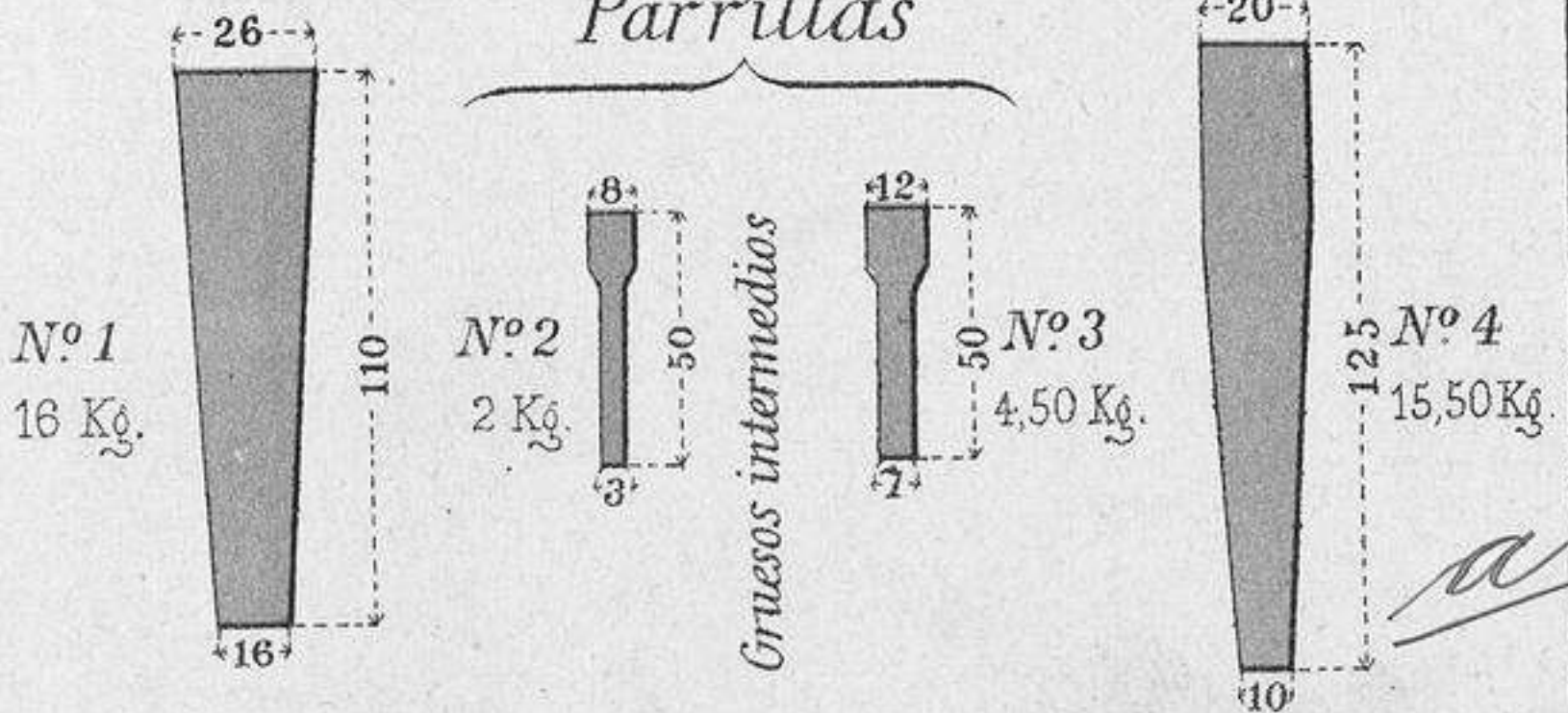

FÁBRICA DE MIERES

CARRILES

NOTA.—Los pesos son aproximados.—Las cotas en m/m

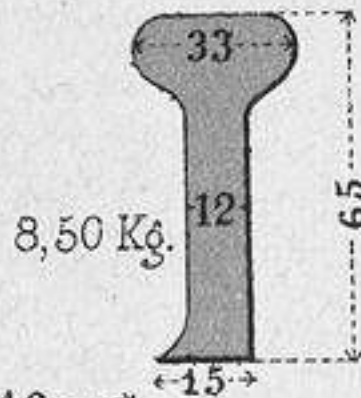

Nº 1

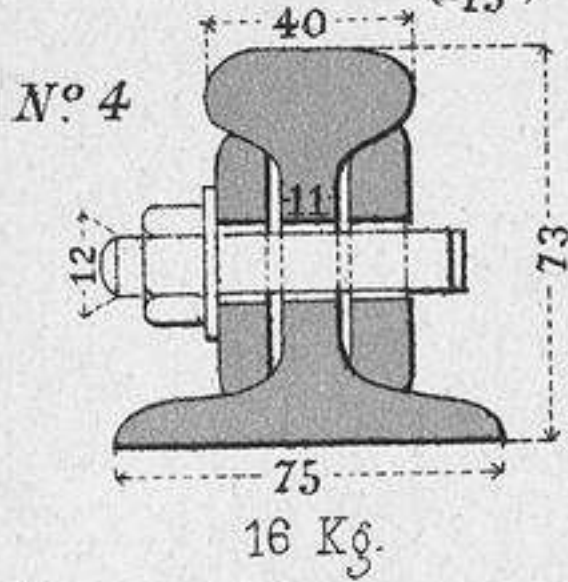
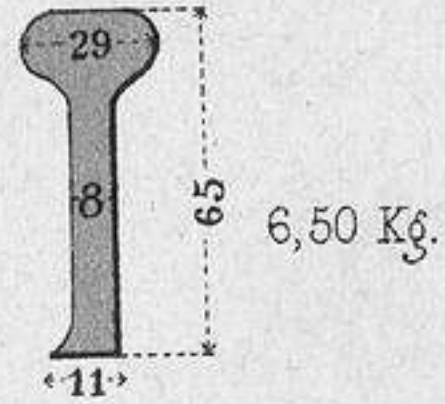

Nº 2

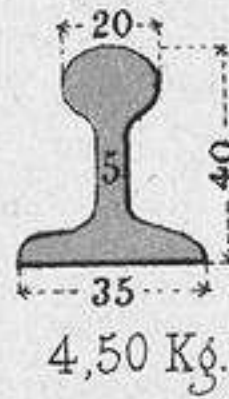

Nº 3

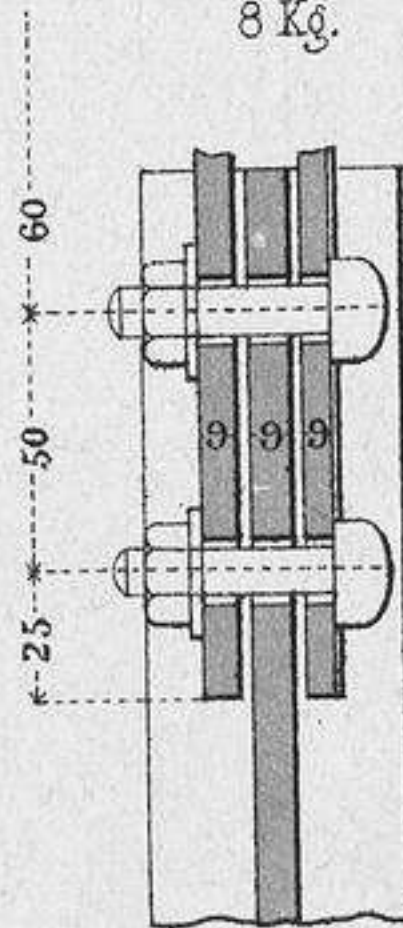
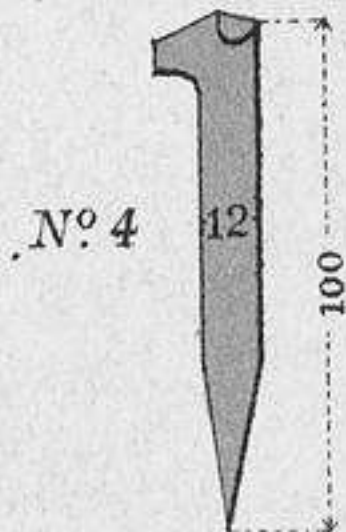
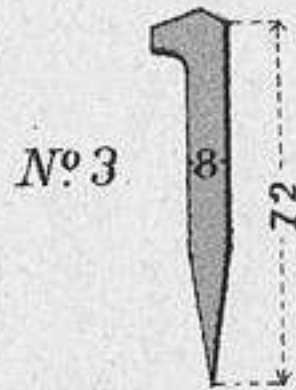
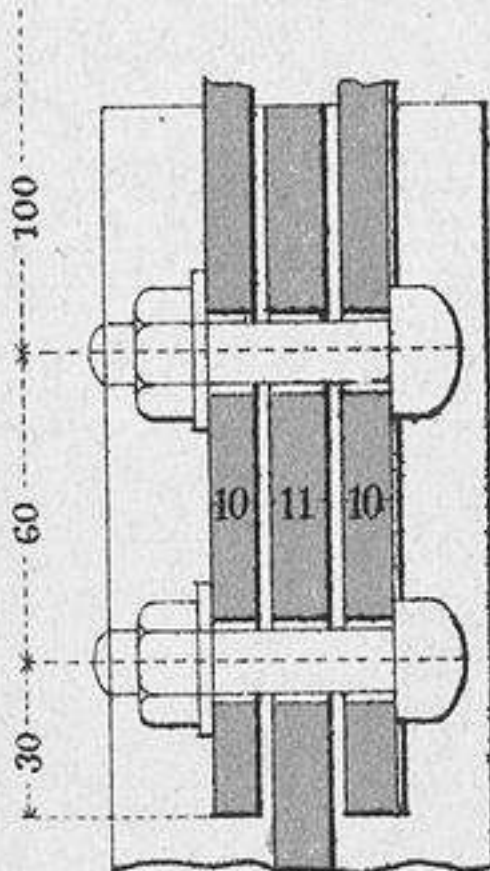
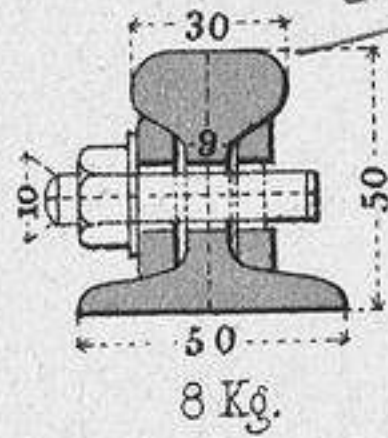

FÁBRICA DE MIERES

Es 1/4

CARRILES

NOTA.—Los pesos son aproximados.—Las cotas en m/m

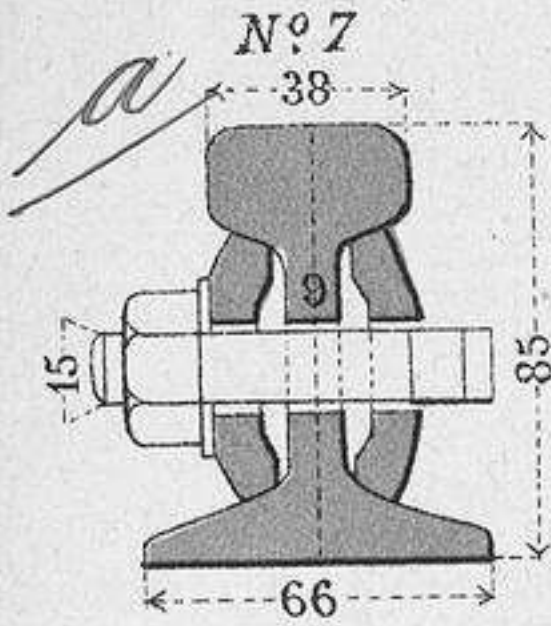

16 Kg.

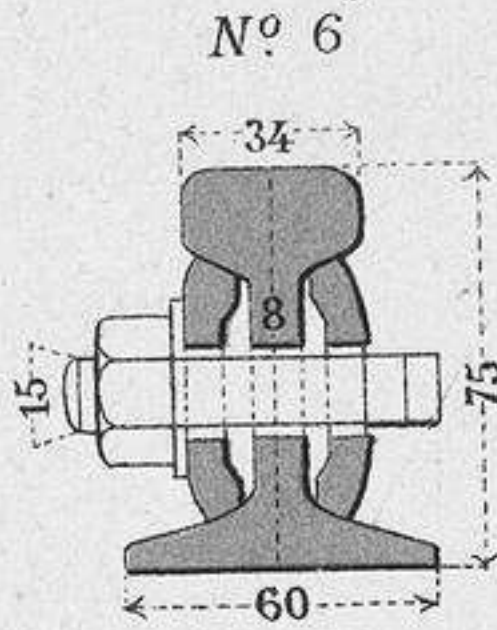

12 Kg.

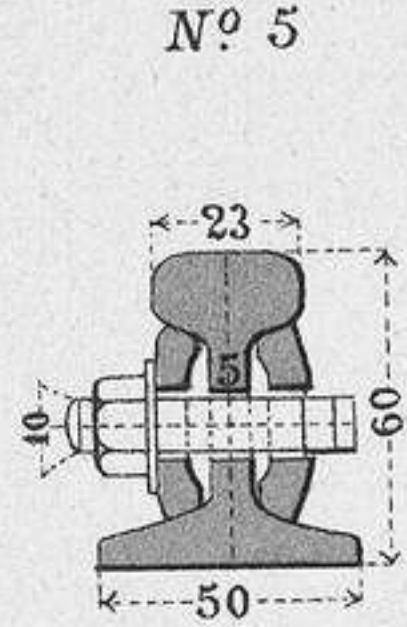

8 Kg.

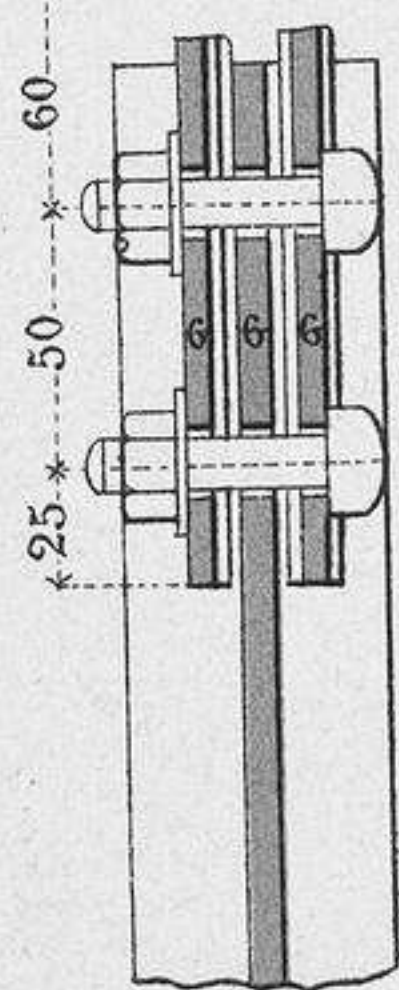
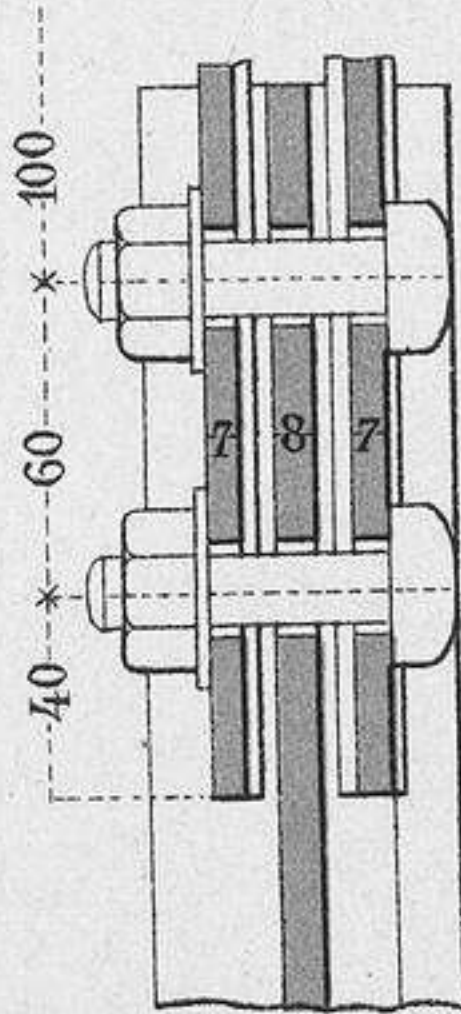
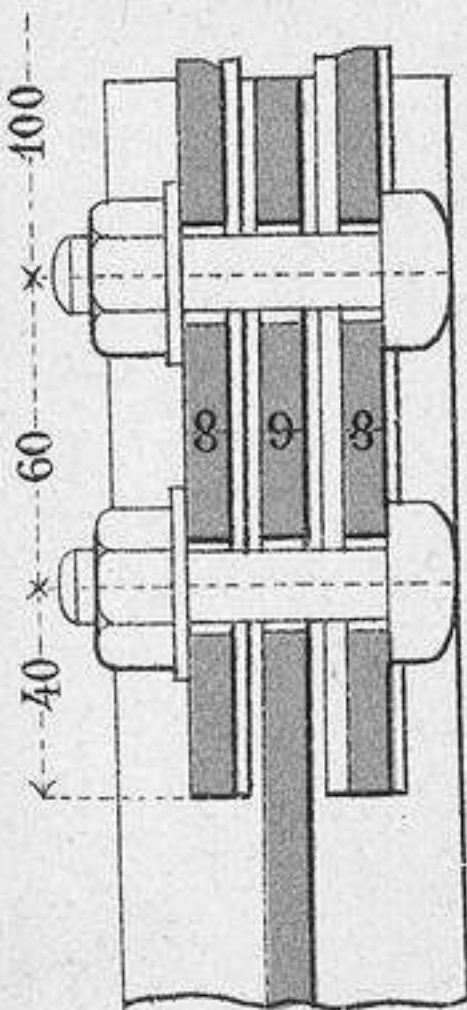

FÁBRICA DE MIERES

VIGUETAS

NOTA - Las cotas en mm .
Los pesos son aproximados.

Nota - Se laminan gruesos intermedios entre los de la Lámina 6 y 5.

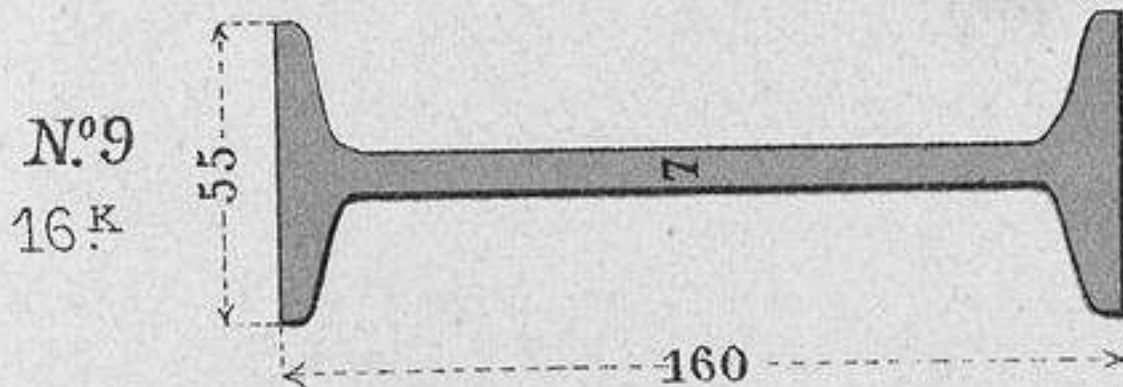
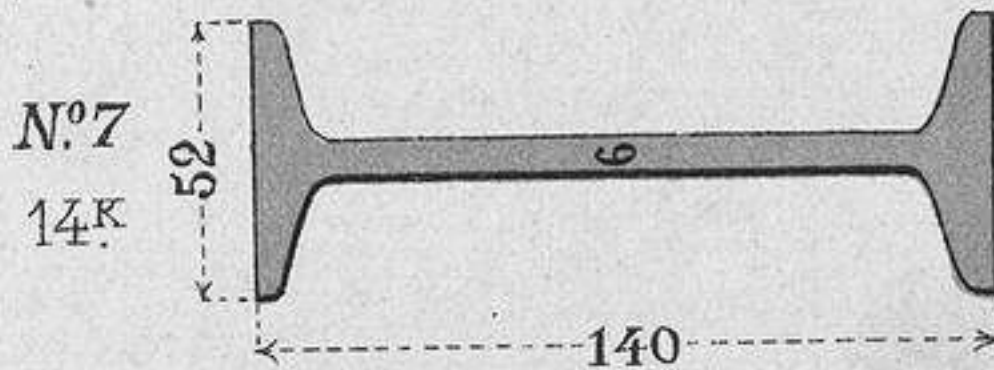
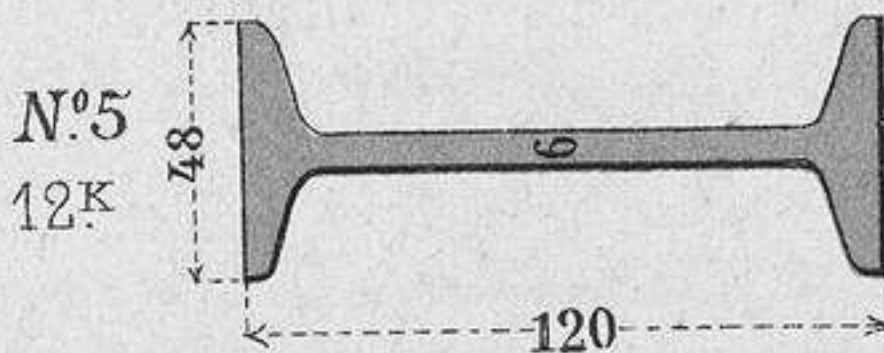
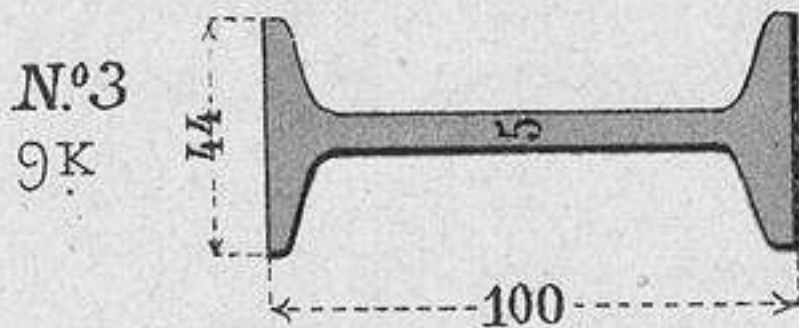
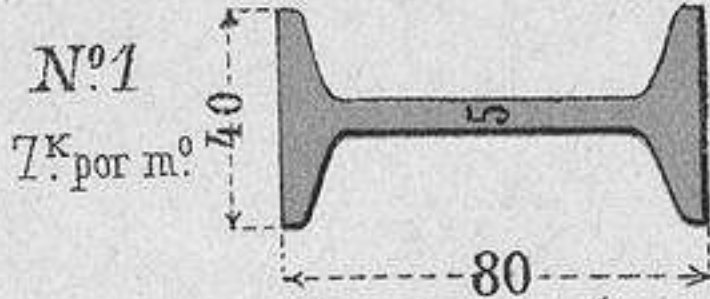

FÁBRICA DE MIERES

Es 1/4

VIGUETAS

Nota - Las cotas en m/m .
Los pesos son aproximados.

Nota - Se laminan gruesos intermedios entre los de las laminas 6 y 5.

Nº2
10^K

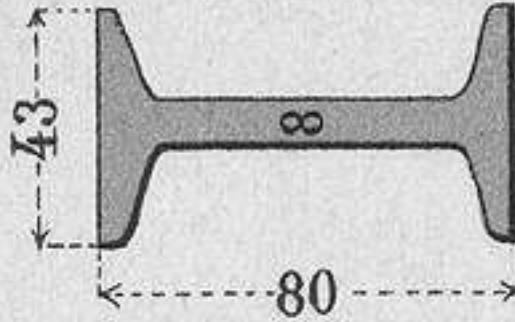

Nº4
13^K

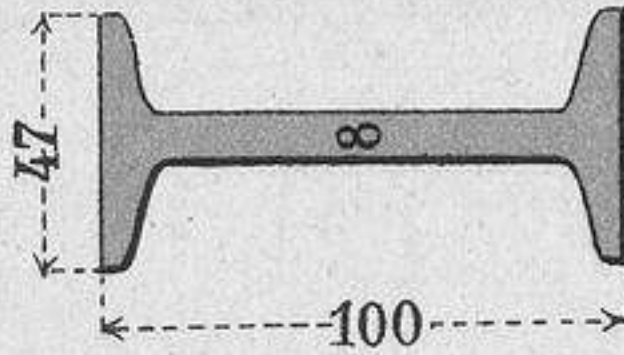

Nº6
16^K

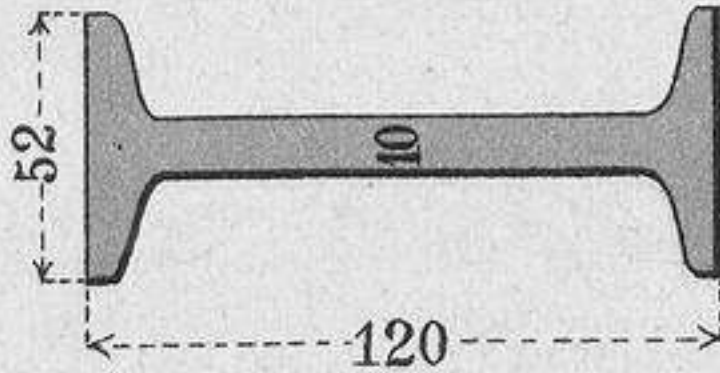

Nº8
18^K

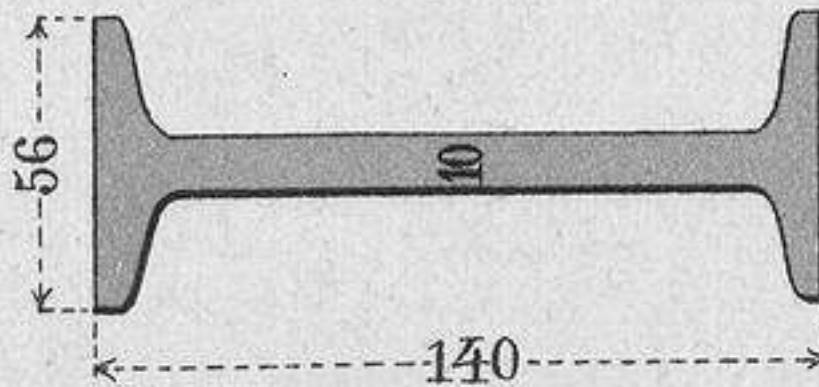

Nº10
24^K

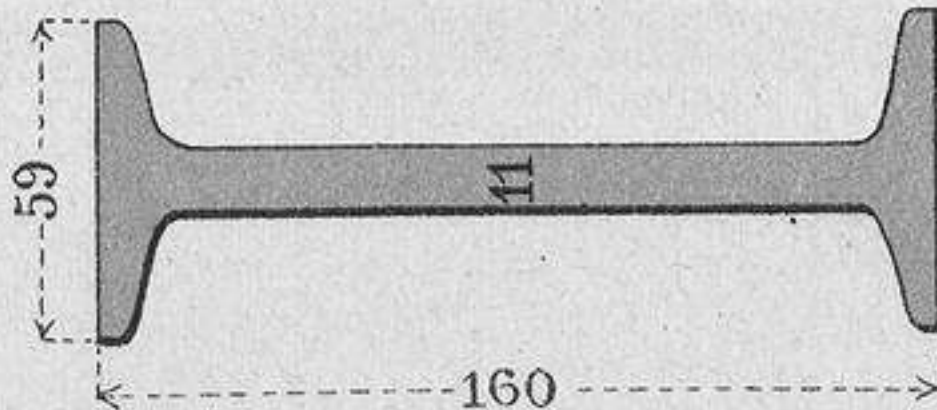

FÁBRICA DE MIERES

VIGUETAS

*Nota - Las cotas en m/m.
Los pesos aproximados.*

*Nota - Espesores y pesos
Intermedios. Lám. 7 y 8.*

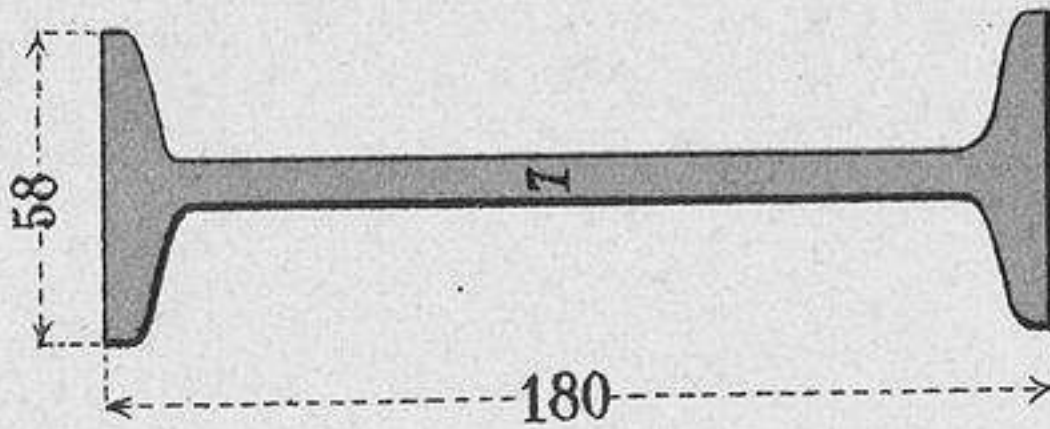

Nº 11
20^K p.m.

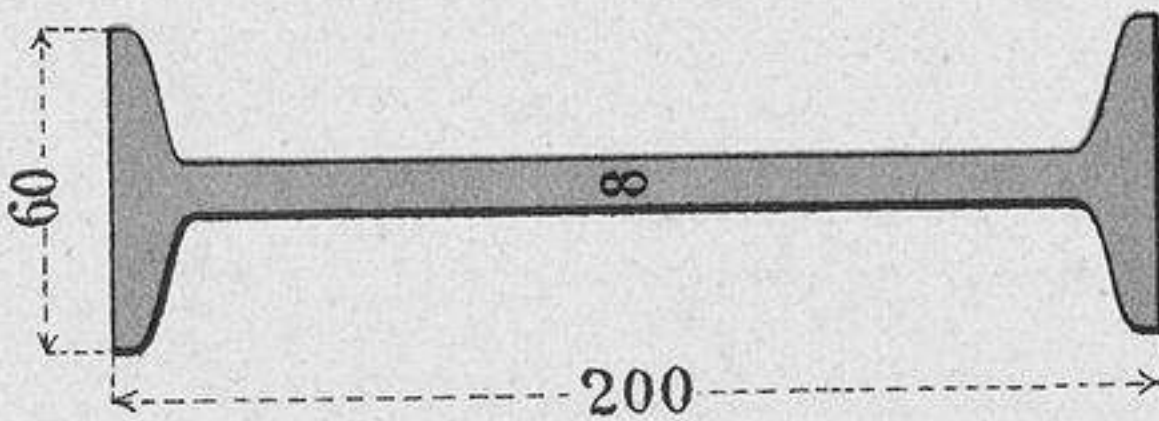

Nº 13
22^K p.m.

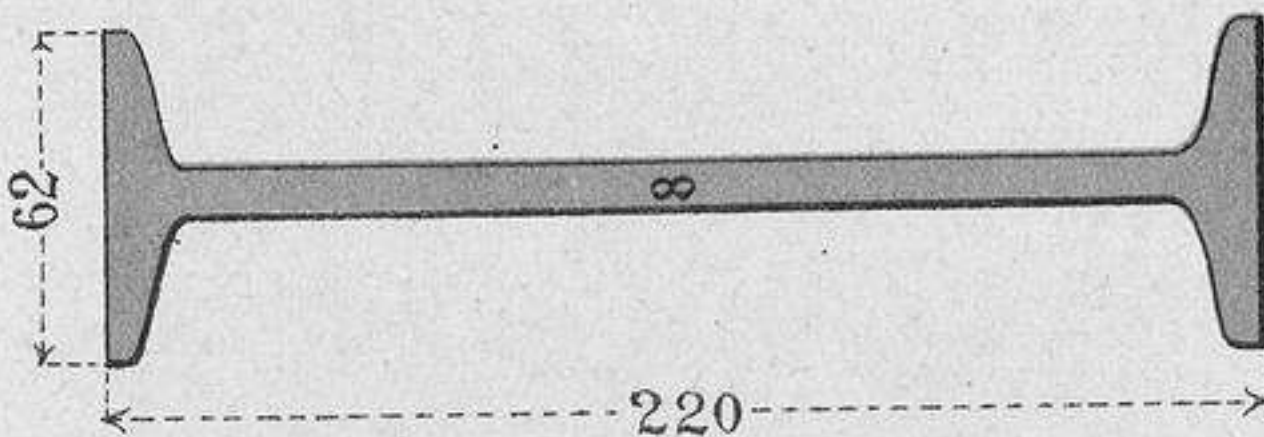

Nº 15
25^K p.m.

FÁBRICA DE MIERES

VIGUETAS

Nota. Las cotas en $\frac{m}{m}$
Los pesos aproximados

Nota. Espesores y pesos
intermedios Lam. 7 y 8

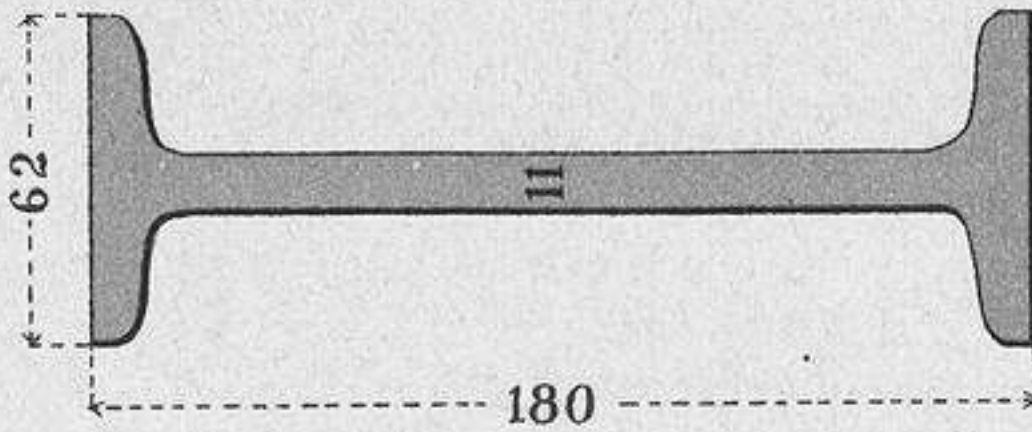

Nº 12

28 K p.m.

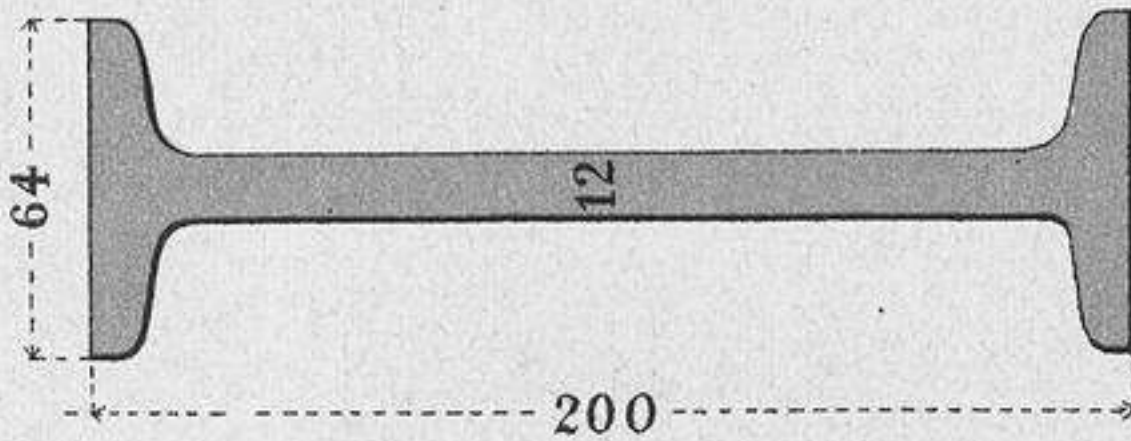

Nº 14

33 K p.m.

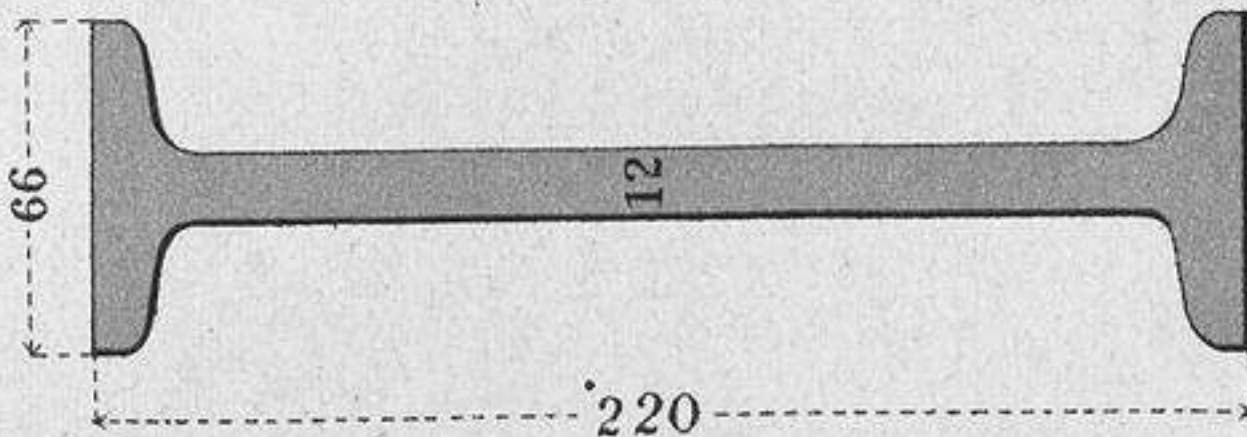

Nº 16

36 K p.m.

FÁBRICA DE MIERES

VIGUETAS ALAS ANCHAS

*Nota. Las cotas en m/m
Los pesos aproximados*

*Nota. Espesores y pesos
intermedios Lam. 9 y 10*

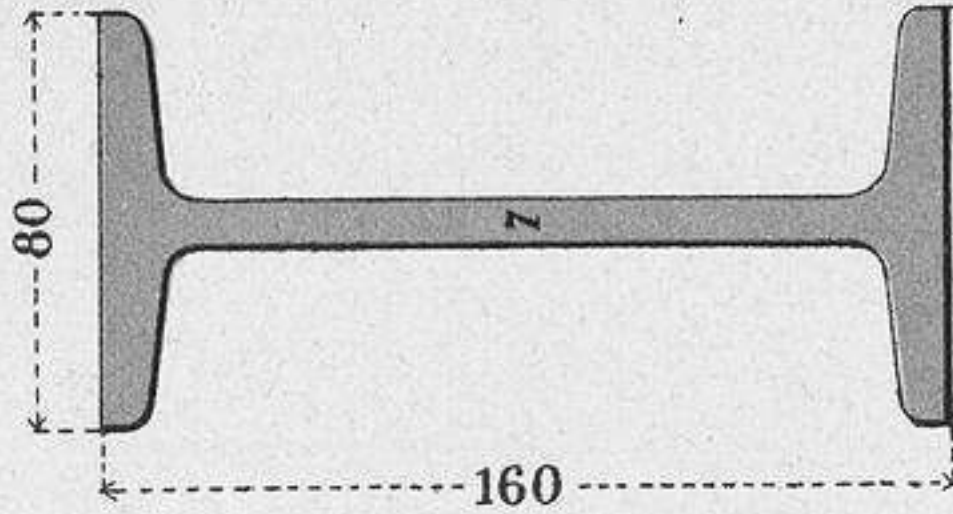

Nº 17

17 K p.m.

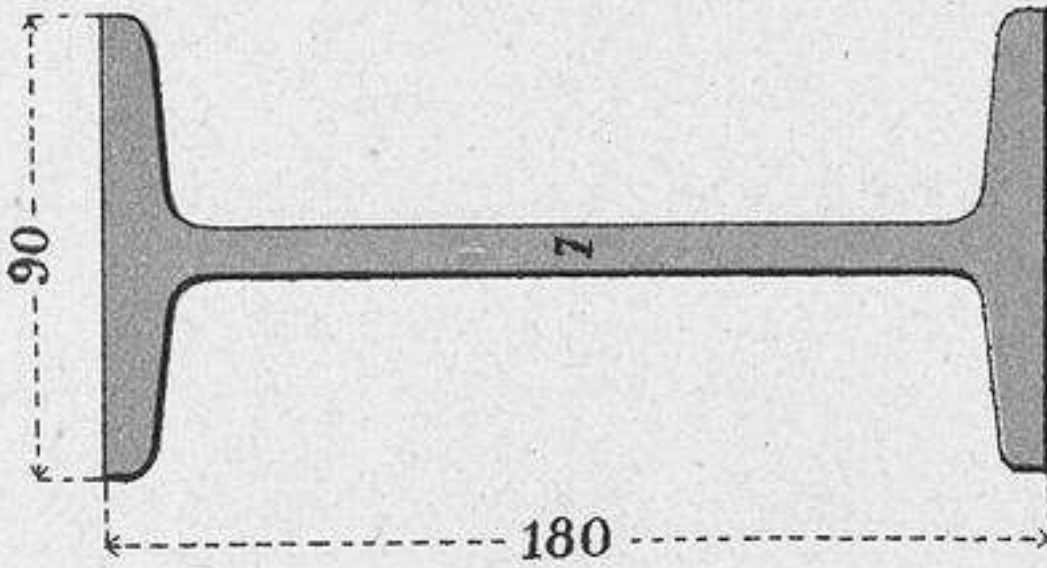

Nº 19

19 K p.m.

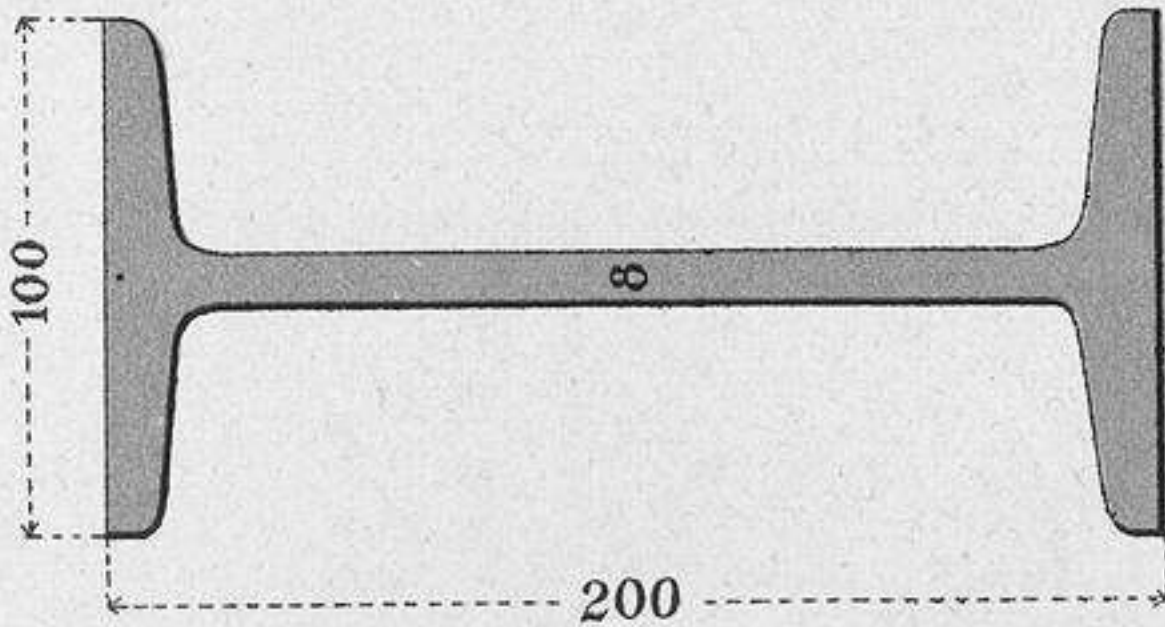

Nº 21

24 K p.m.

FÁBRICA DE MIERES

Es. 1/4

VIGUETAS ALAS ANCHAS

*Nota. Las cotas en m/m
Los pesos aproximados*

*Nota Espesores y pesos
intermedios. Lam. 9 y 10*

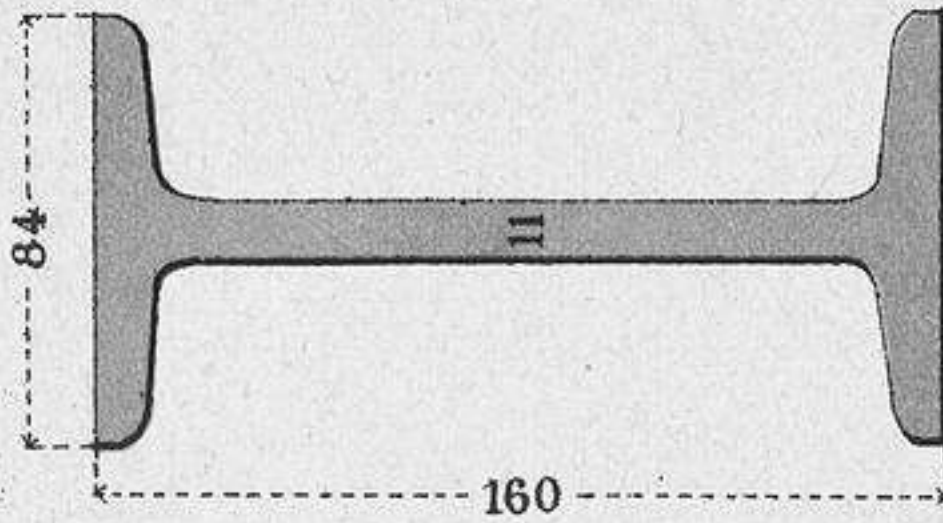

Nº 18

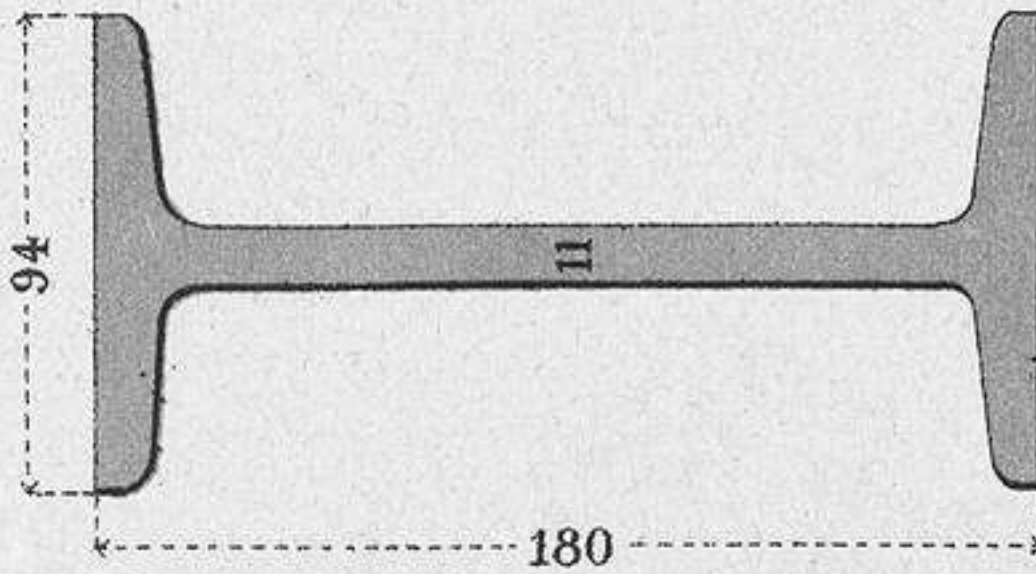
25^K p.m.

Nº 20

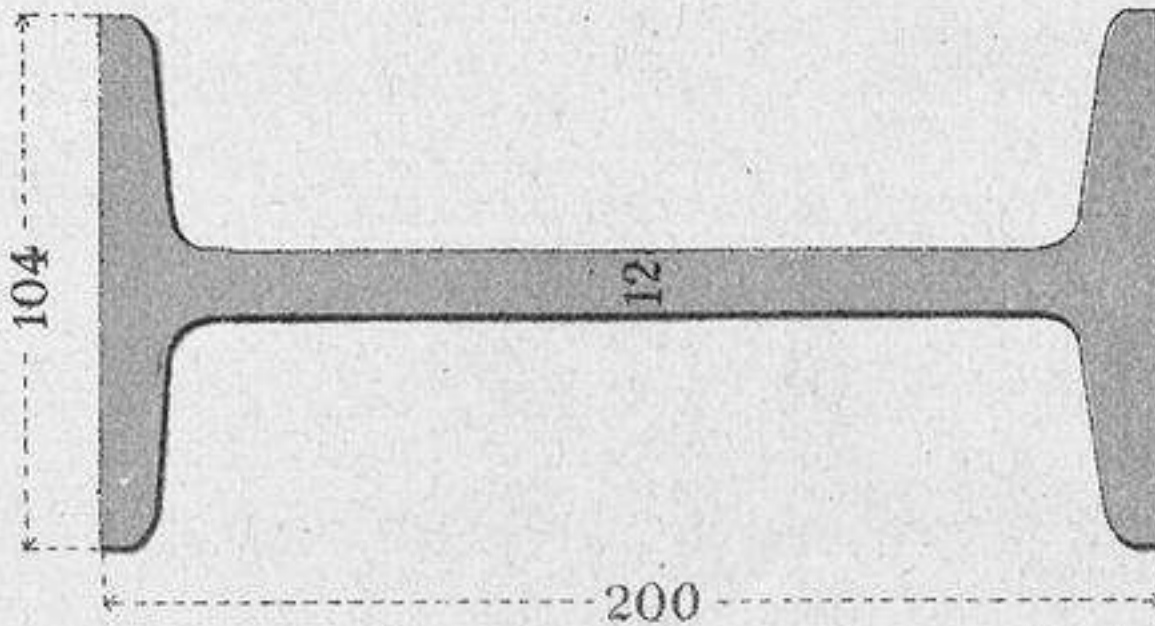
30^K p.m.

Nº 22

34^K p.m.

FÁBRICA DE MIERES

HIERROS EN U

Pesos por metro aproximados.—Cotas en m/m

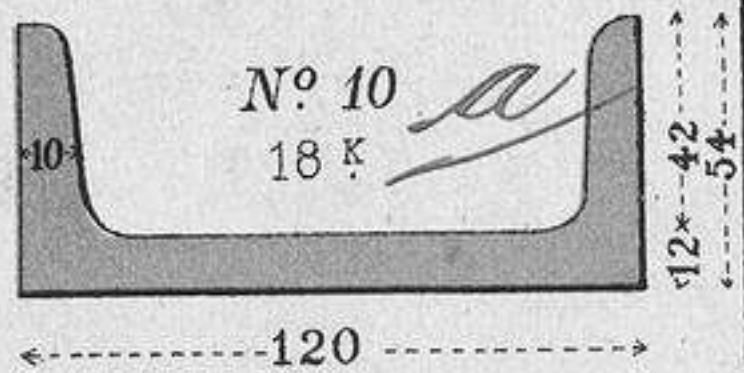
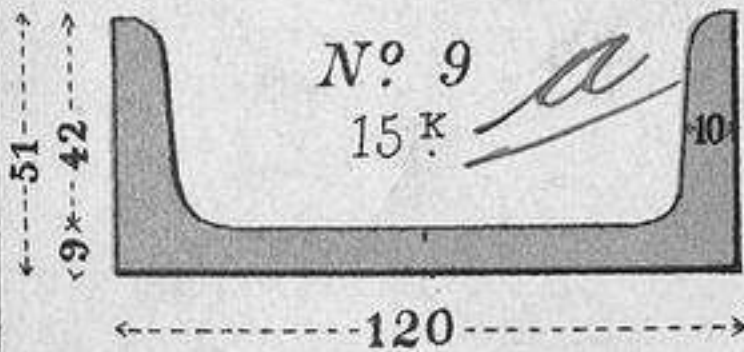
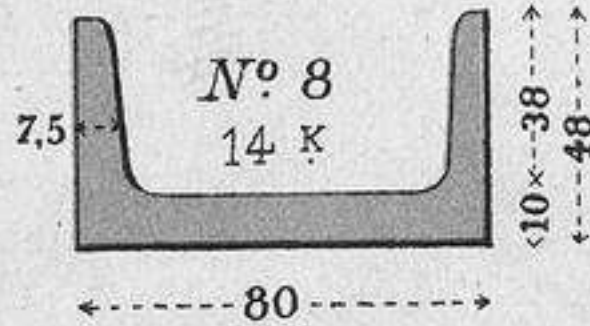
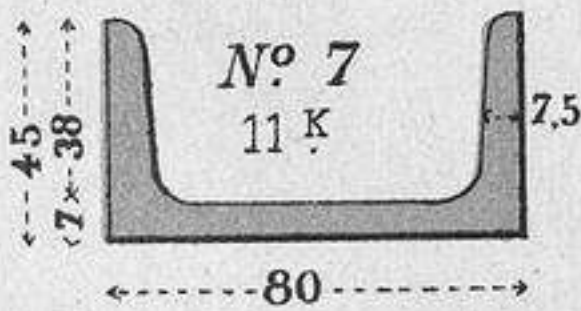
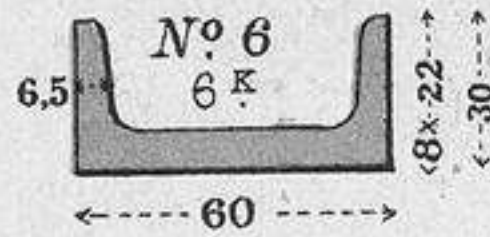
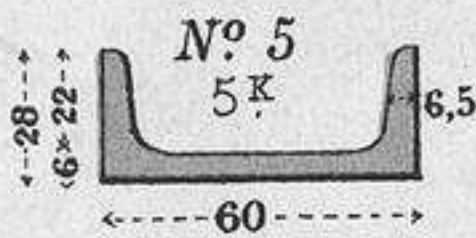
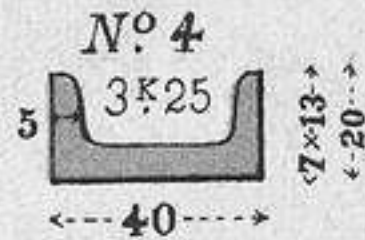
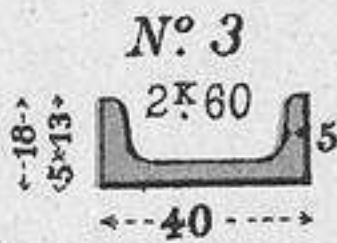
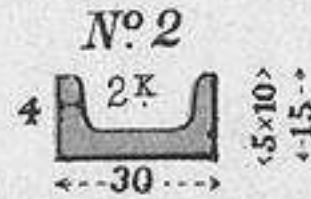
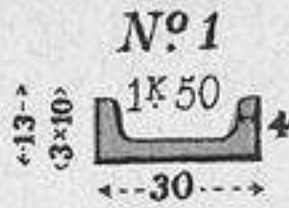

Se laminan gruesos intermedios.

FABRICA DE MIERES

Es $\frac{1}{4}$

HIERROS EN U

NOTA.—El peso por metro es aproximado.—Las cotas en m/m

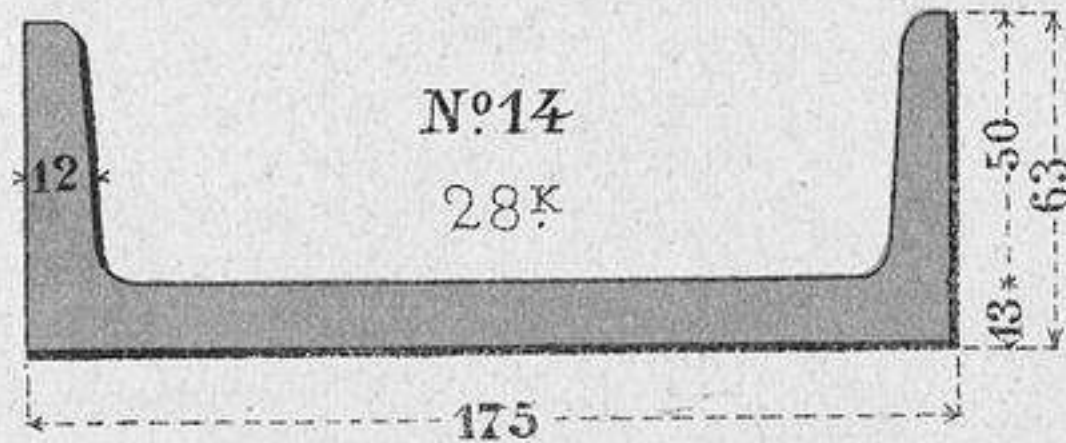
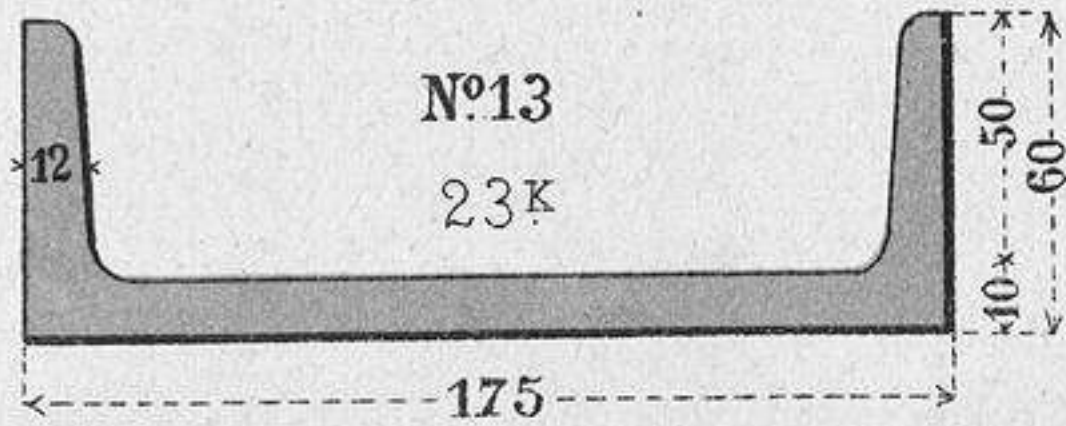
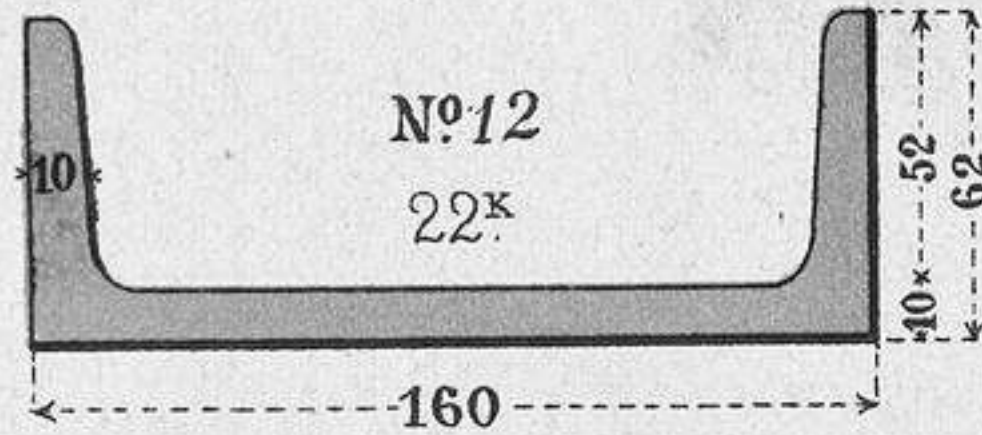
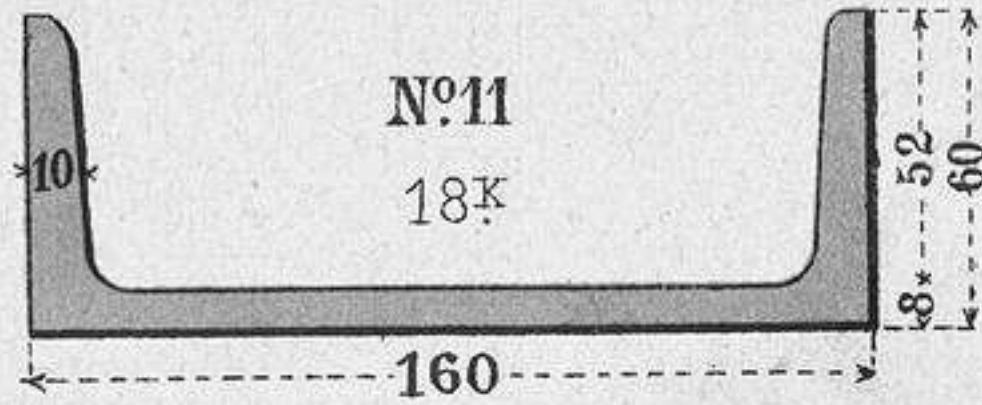

FÁBRICA DE MIERES

Es $\frac{3}{4}$

HIERROS EN U

NOTA.—Los pesos son aproximados.—Las cotas en m/m

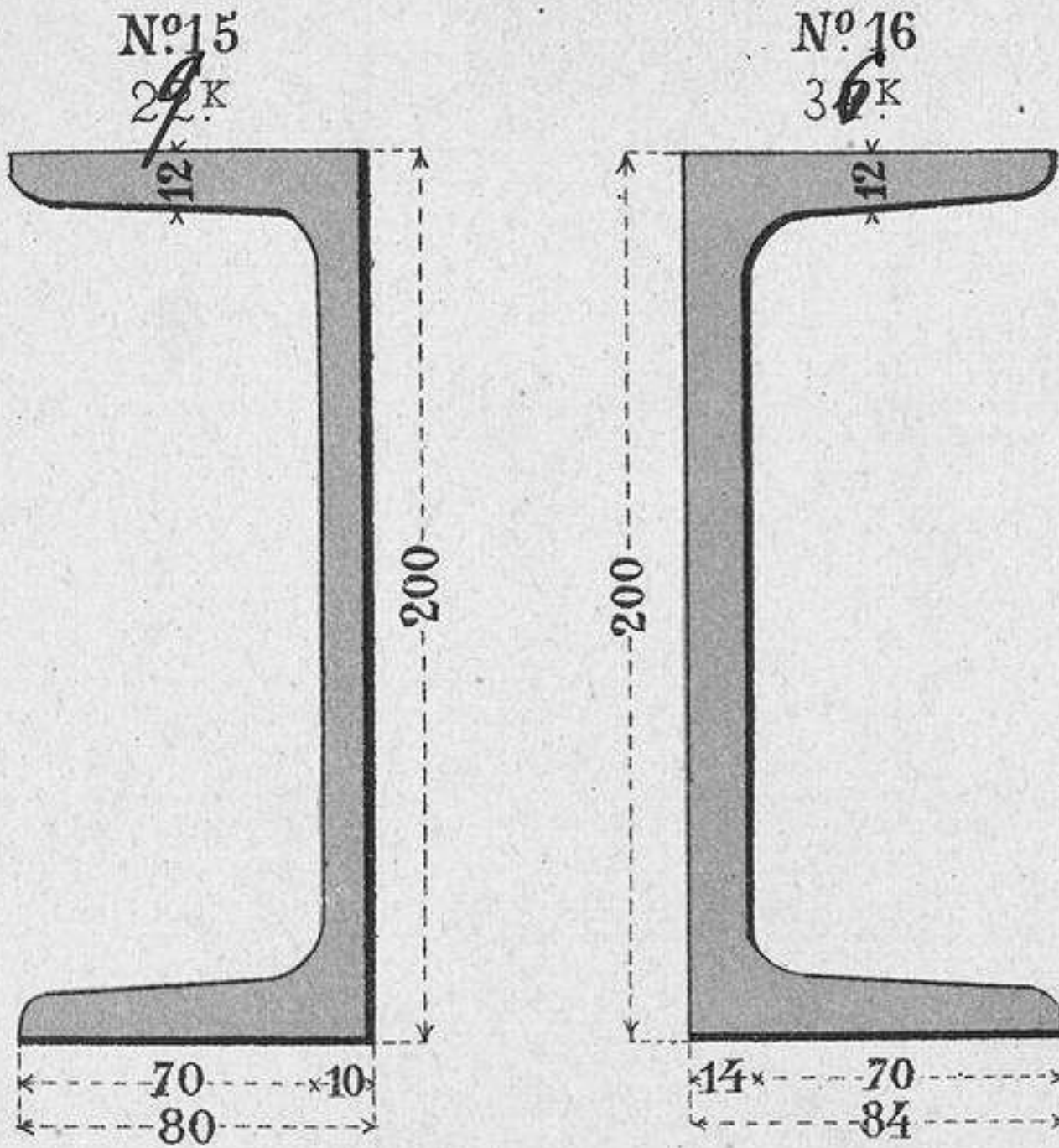

FÁBRICA DE MIERES

Es ¼

HIERROS DOBLE ESCUADRA Ó T

NOTA.—El peso por metro es aproximado.—Las cotas en m/m

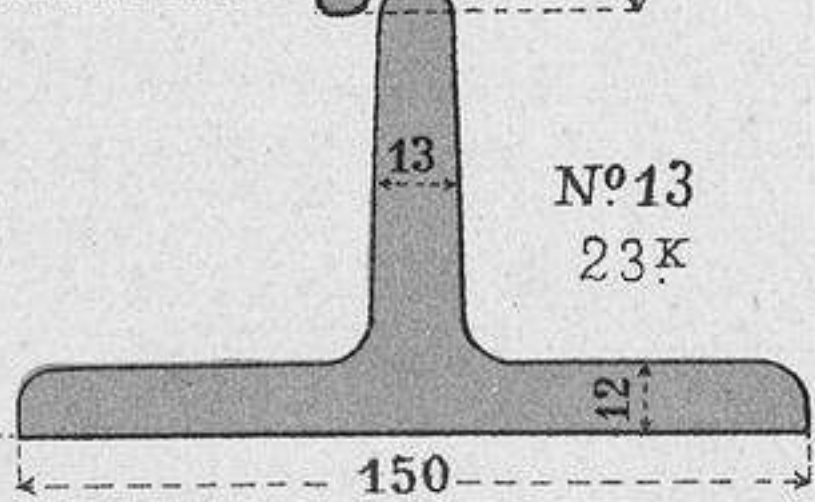
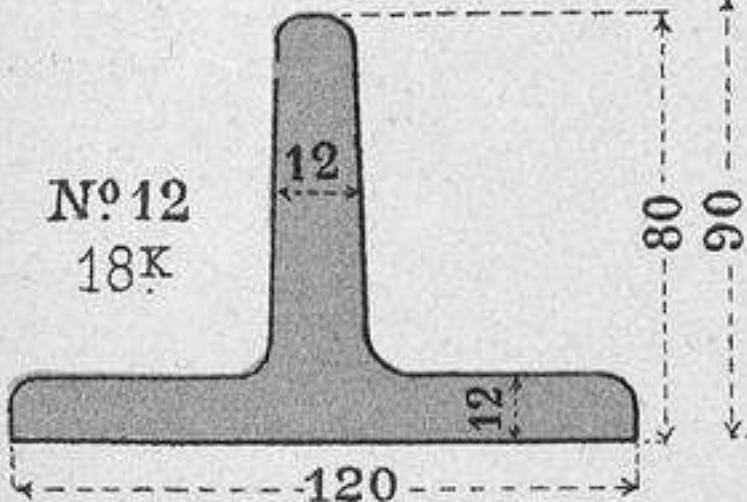
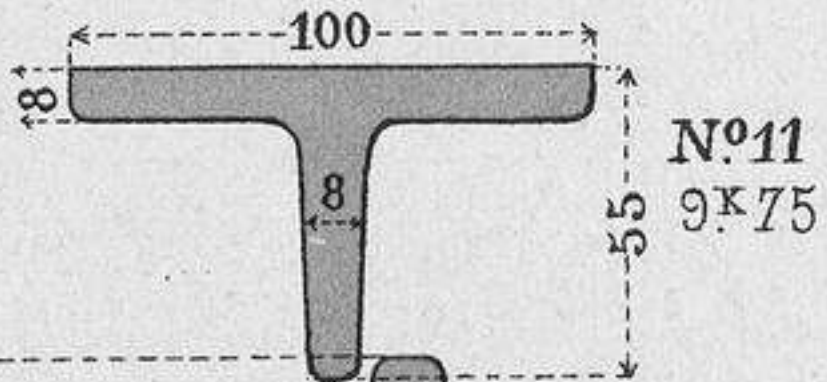
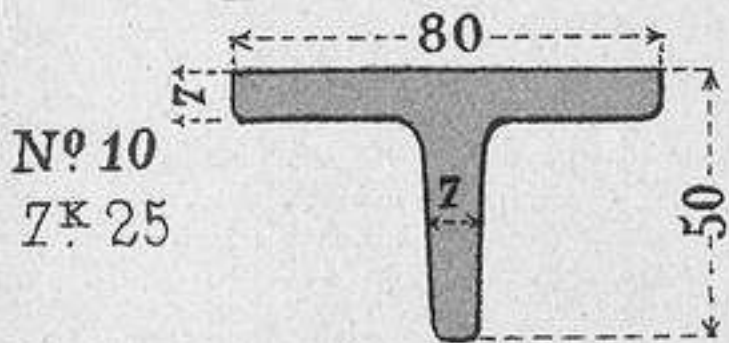
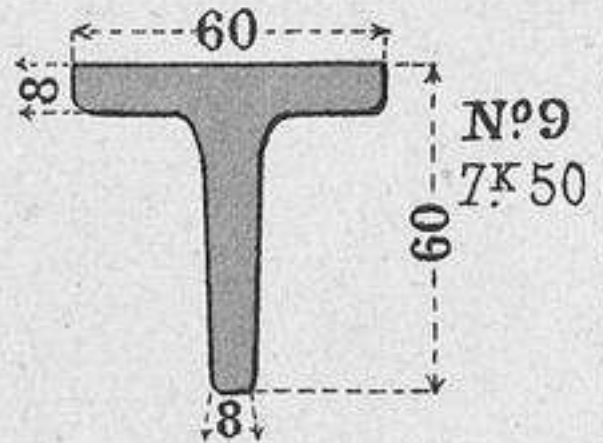
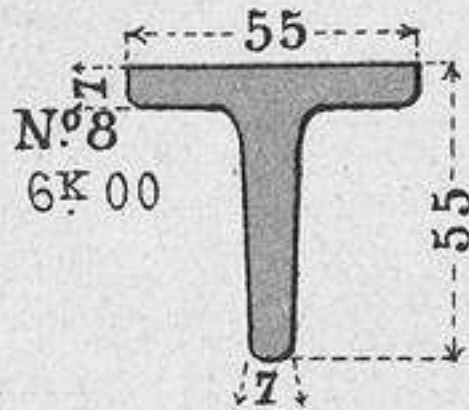
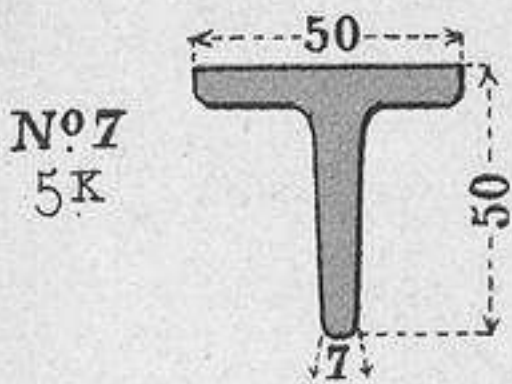
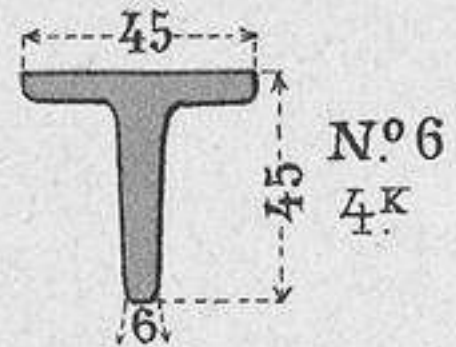
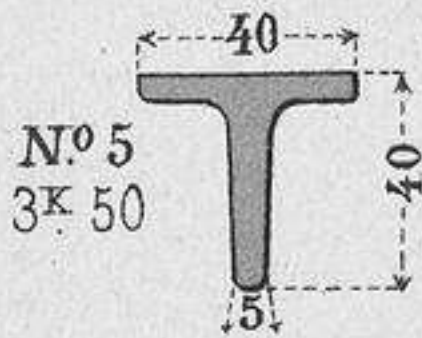
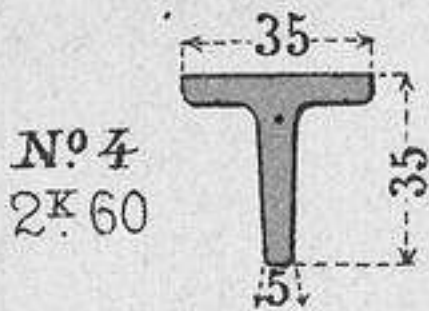
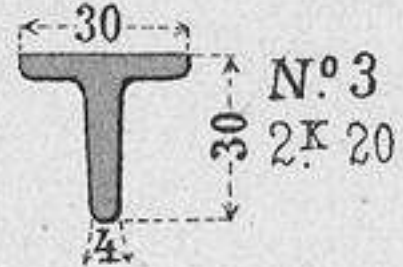
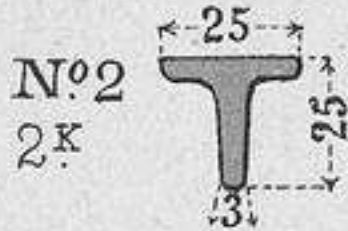
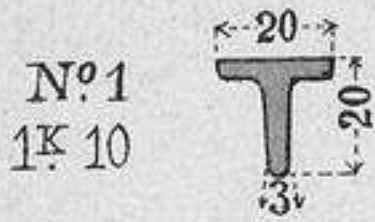

FÁBRICA DE MIERES

Es 1/4

ANGULARES DE LADOS IGUALES

NOTA.—Los pesos por metro son aproximados.—Las cotas en m/m

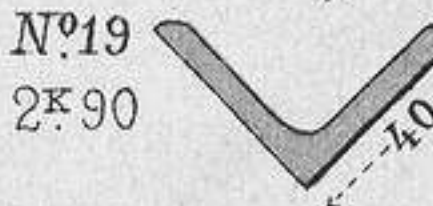
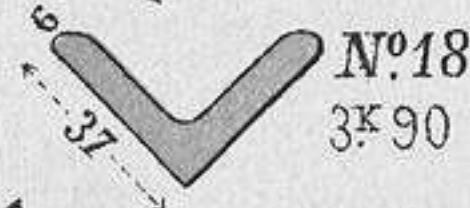
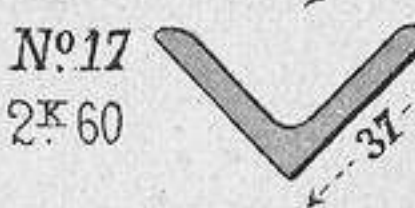
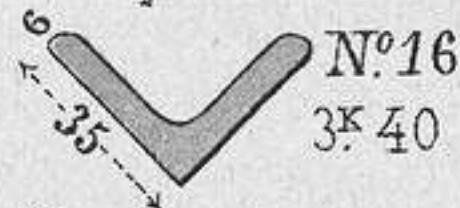
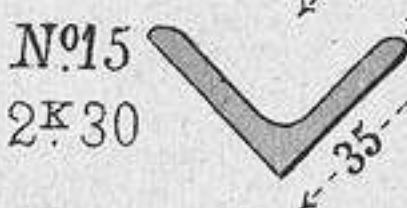
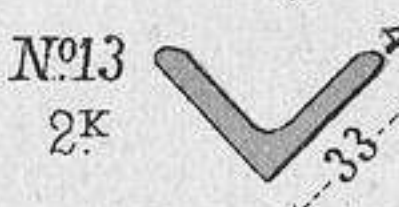
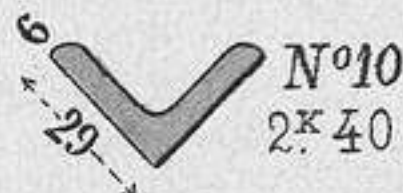
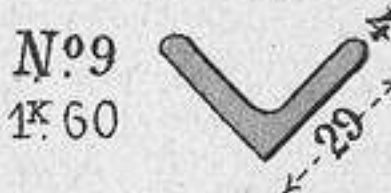
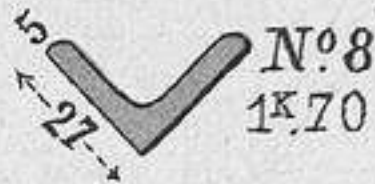
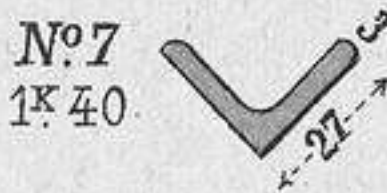
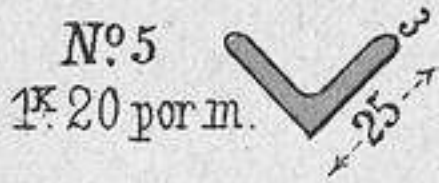
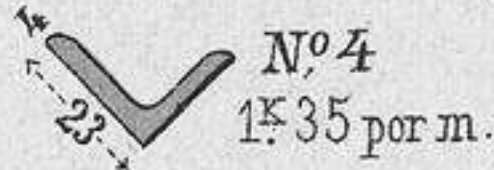
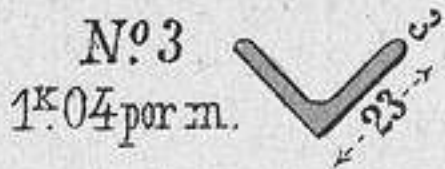
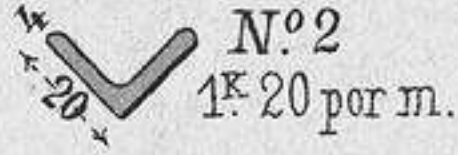
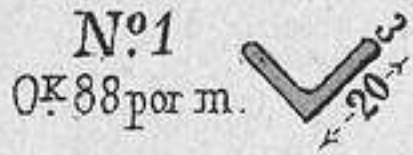

Nota-Se laminan gruesos intermedios.

FÁBRICA DE MIERES

ANGULARES DE LADOS IGUALES

Nº 21

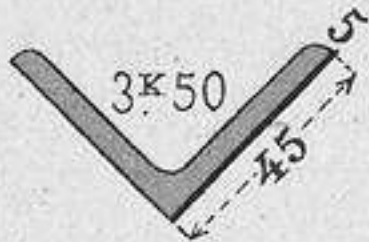

Nº 22

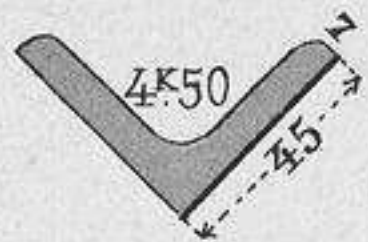

Nº 23

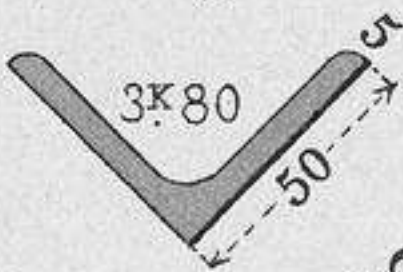

Nº 24

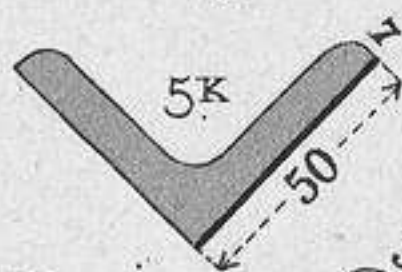

Nº 25

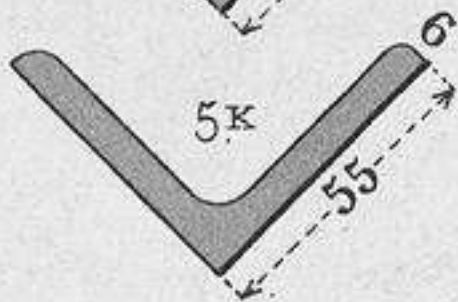

Nº 26

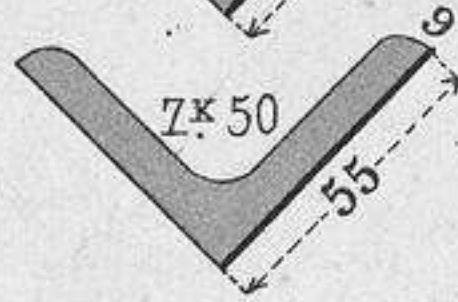

Nº 27

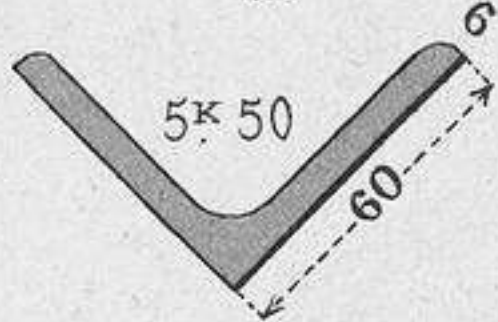

Nº 28

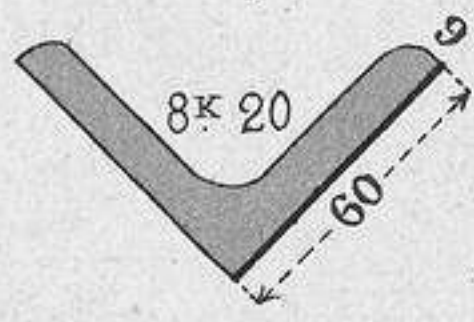

Nº 29

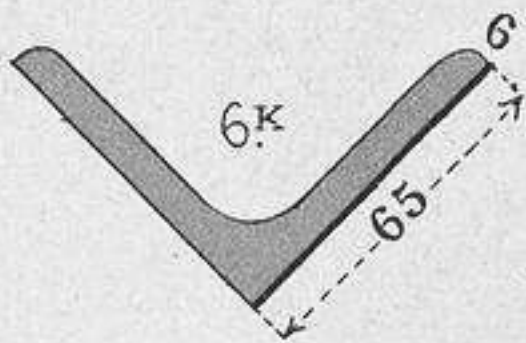

Nº 30

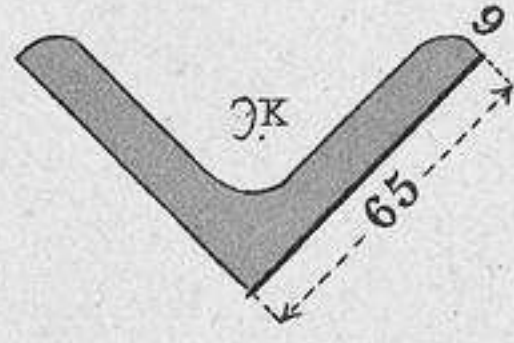

Nº 31

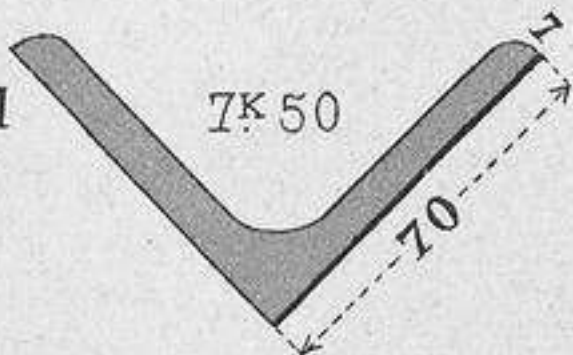

Nº 32

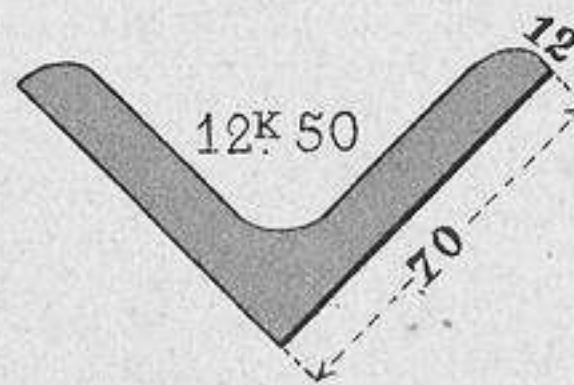

Nota - Se laminan gruesos intermedios - Cotas en m/m.

FÁBRICA DE MIERES

ANGULARES DE LADOS IGUALES

NOTA.—Los pesos por metro son aproximados.—Las cotas en m/m

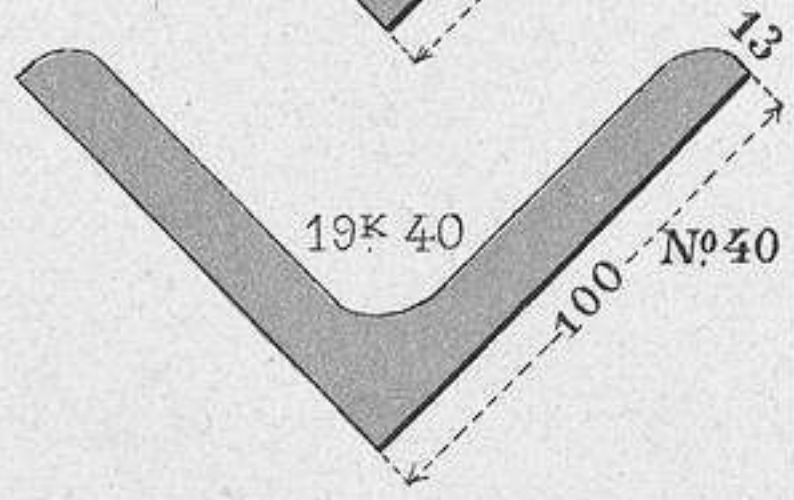
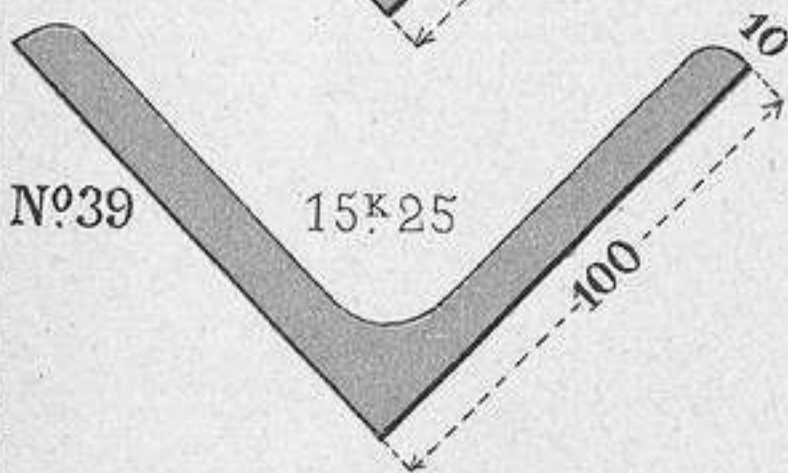
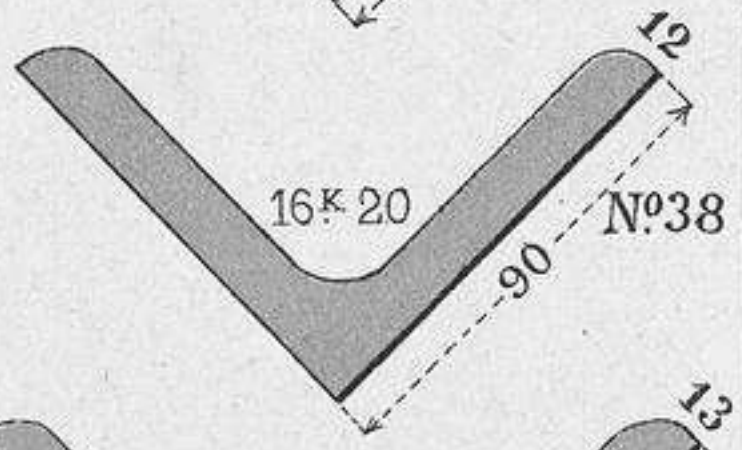
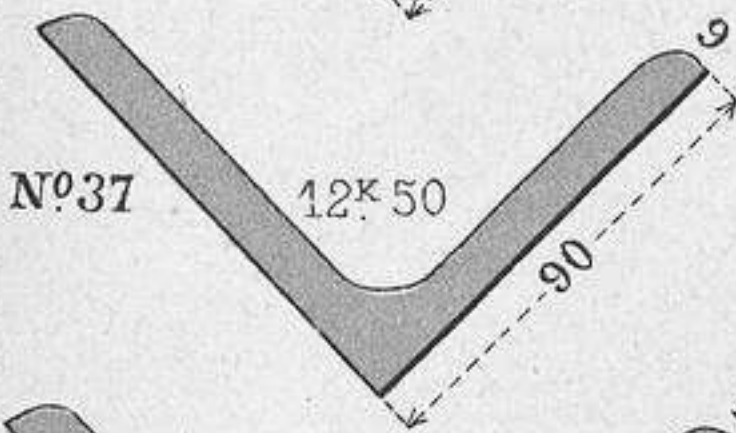
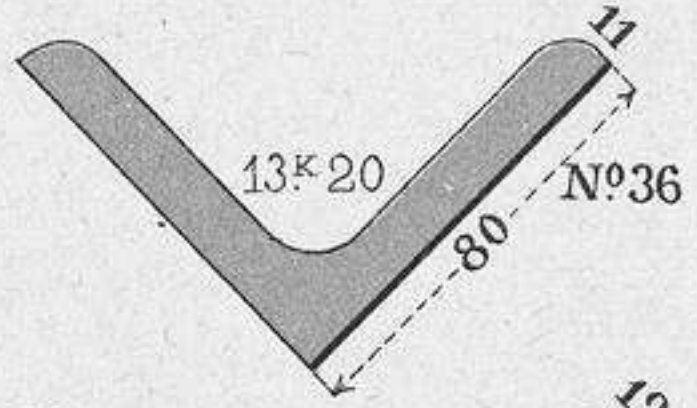
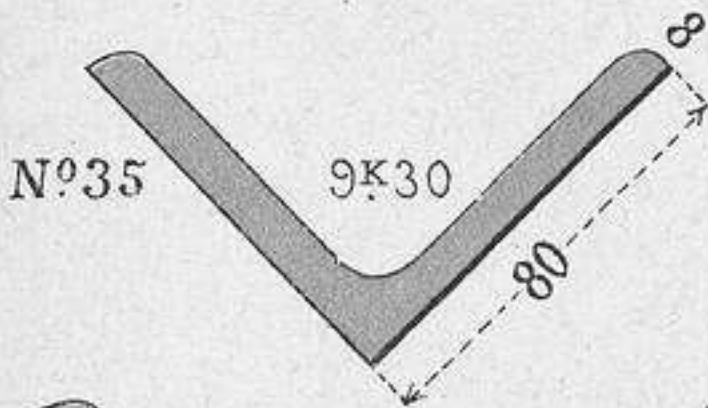
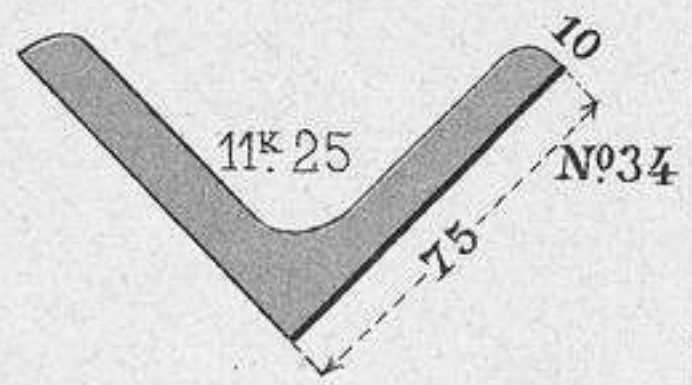
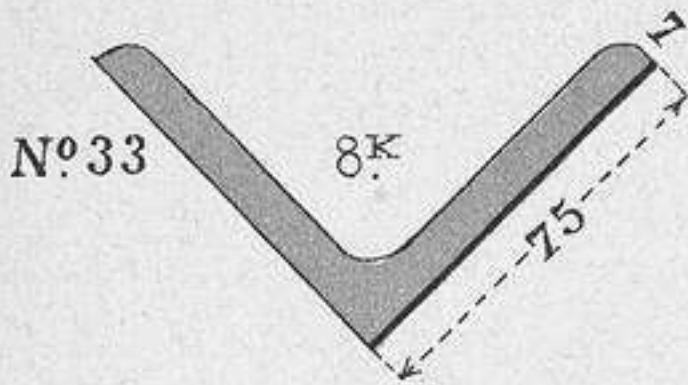

Gruesos intermedios.

FÁBRICA DE MIERES

Es $\frac{1}{4}$

ANGULARES DE RAMAS IGUALES

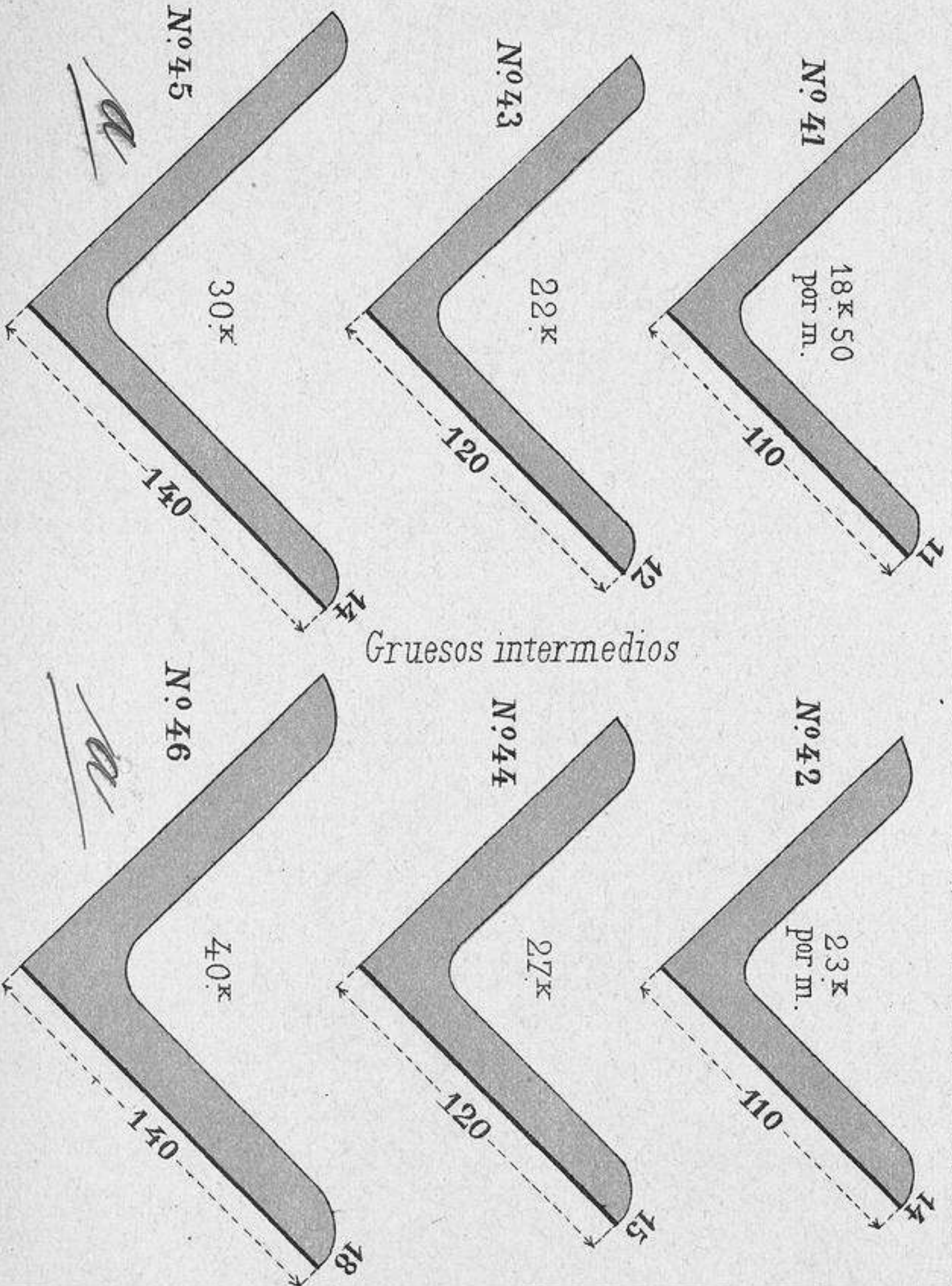

FÁBRICA DE MIERES

Es 1/4

ANGULARES DE RAMAS DESIGUALES

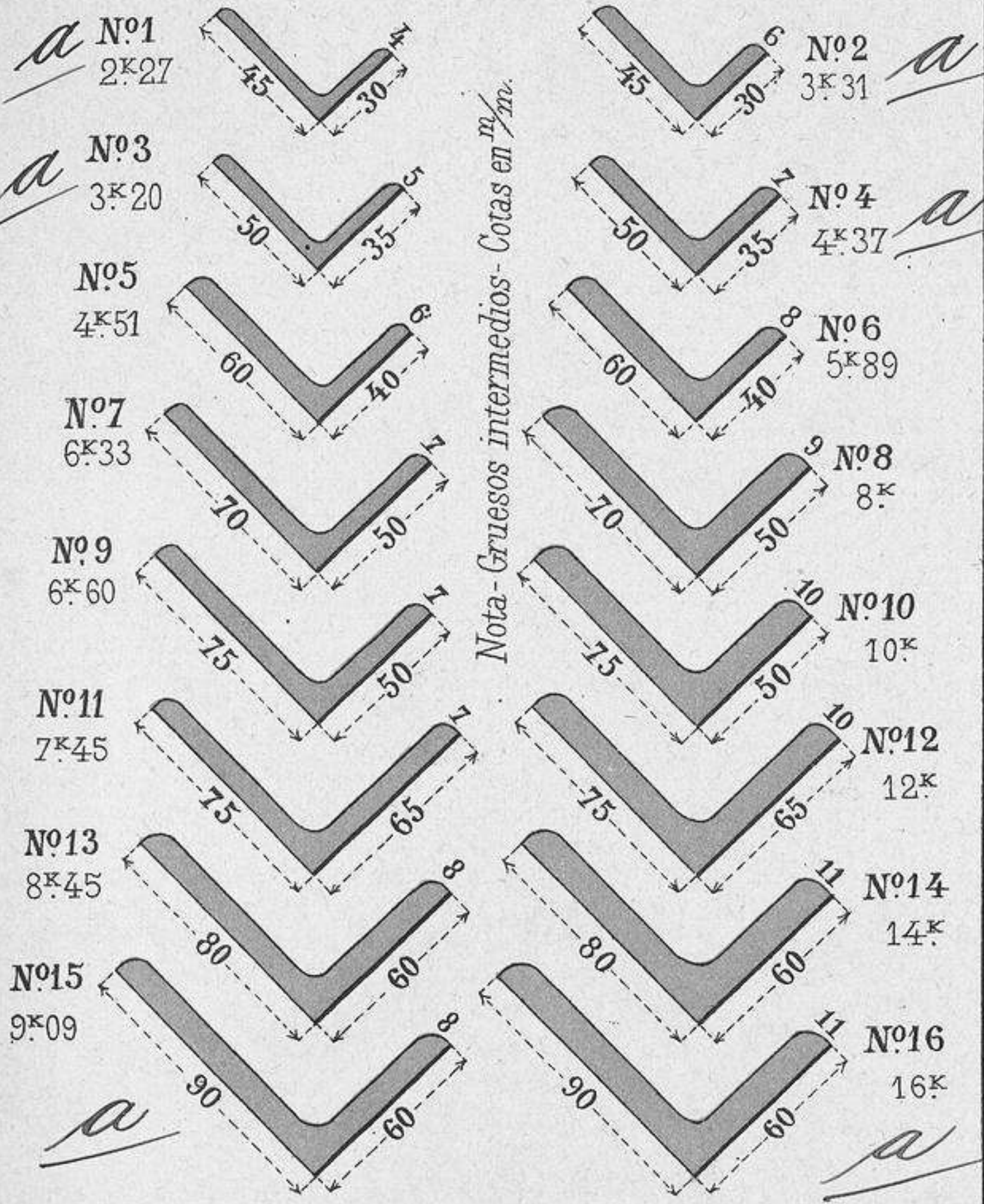

FÁBRICA DE MIERES

Es $\frac{1}{4}$

ANGULARES DE RAMAS DESIGUALES

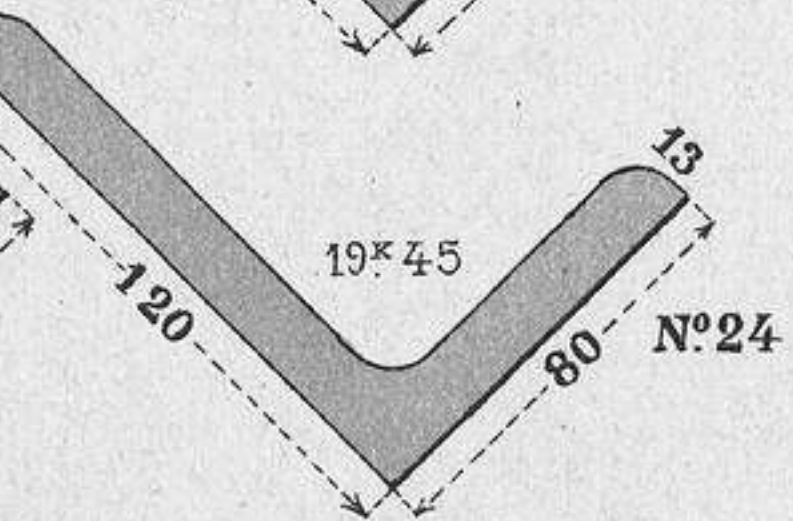
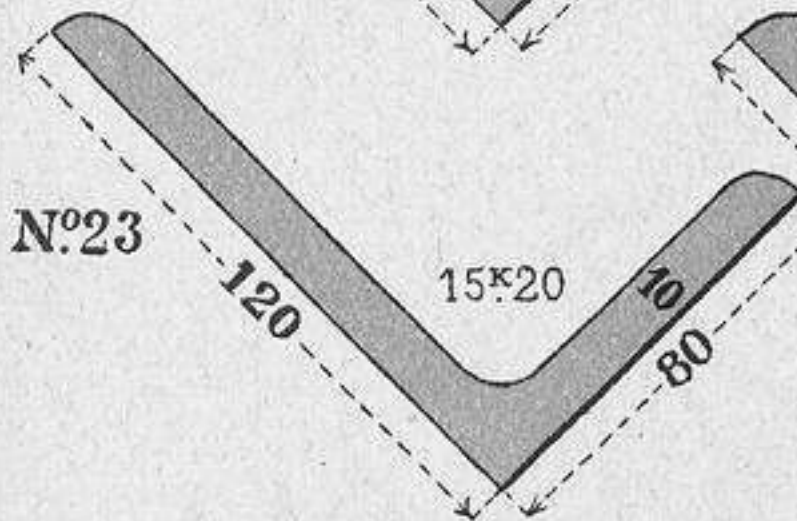
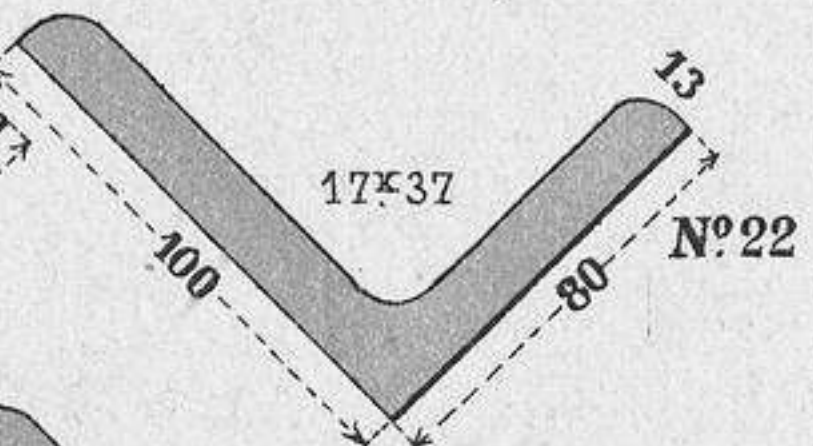
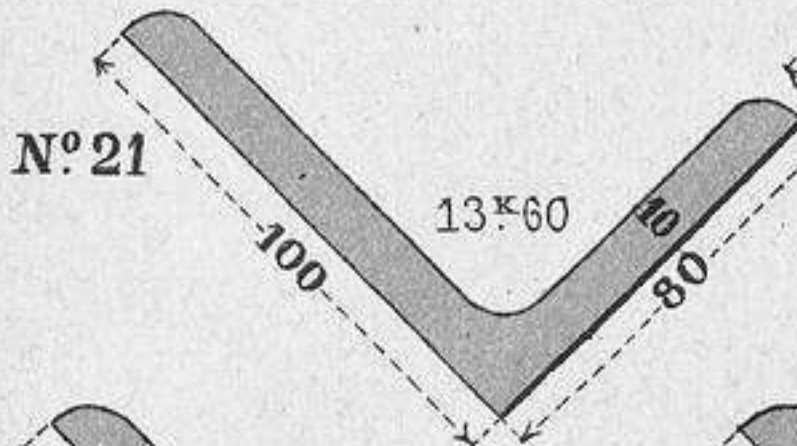
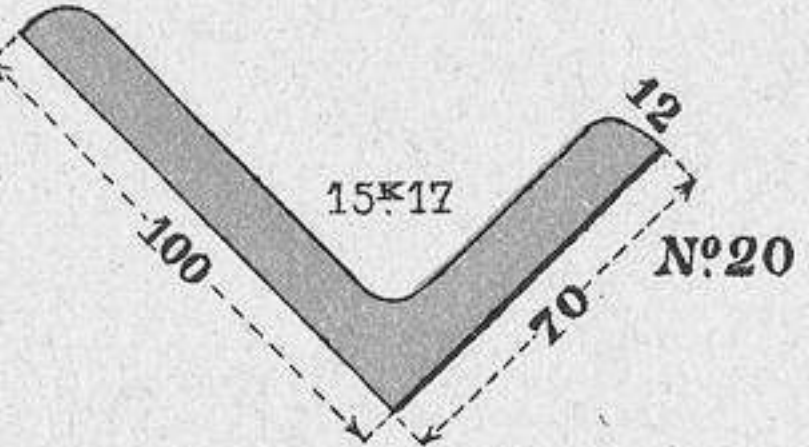
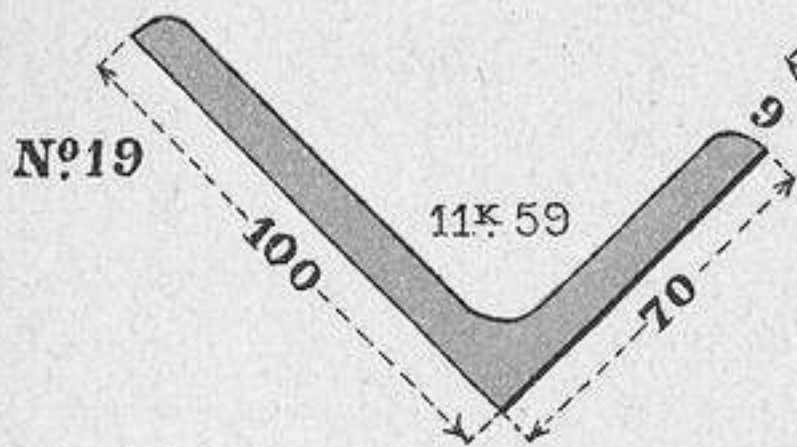
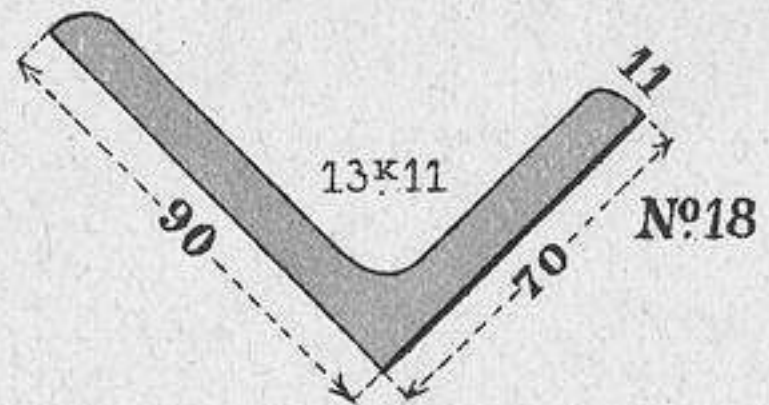
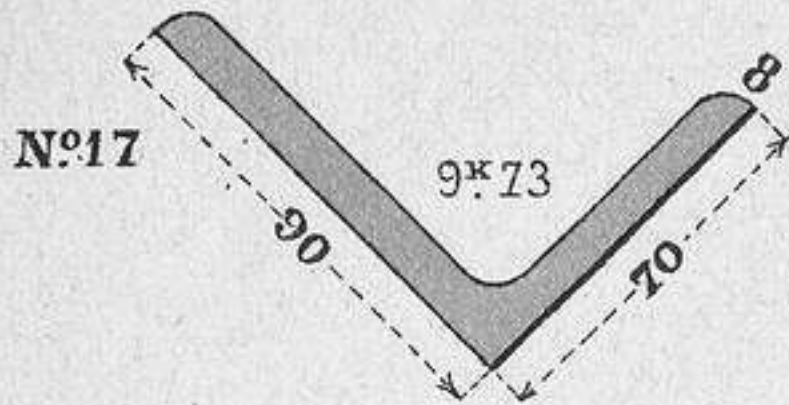

Nota - Gruesos intermedios.

FÁBRICA DE MIERES

Es $\frac{1}{4}$

ANGULARES DE LADOS DESIGUALES

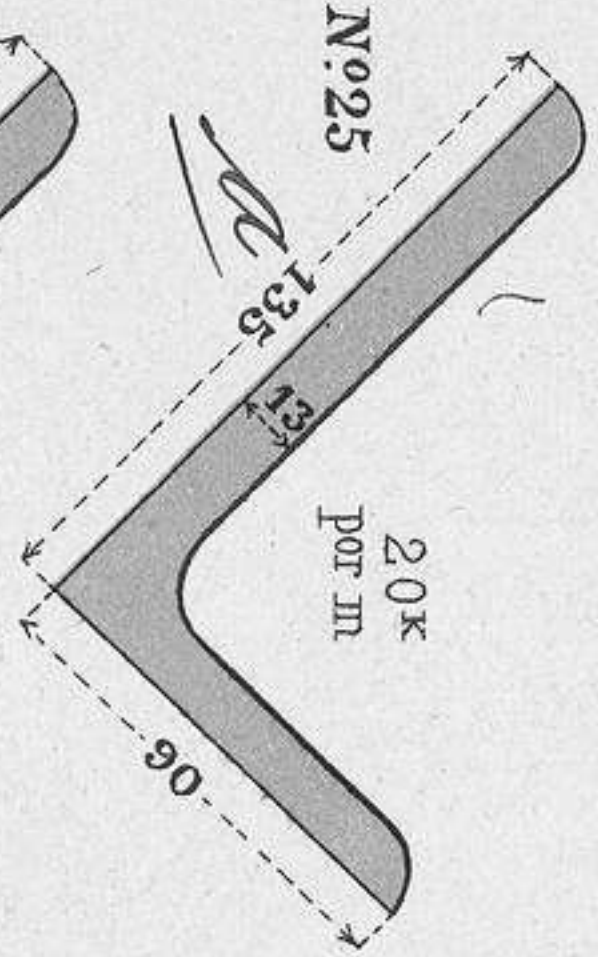
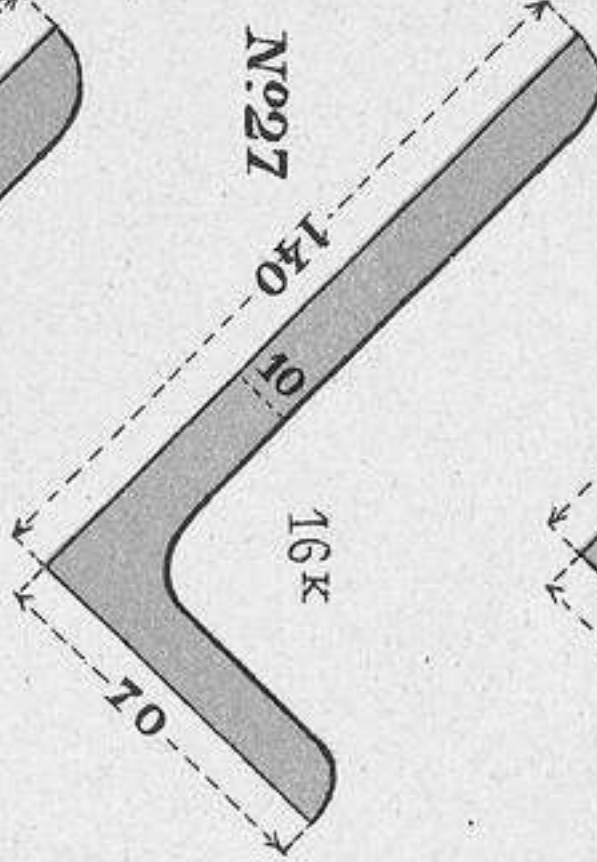
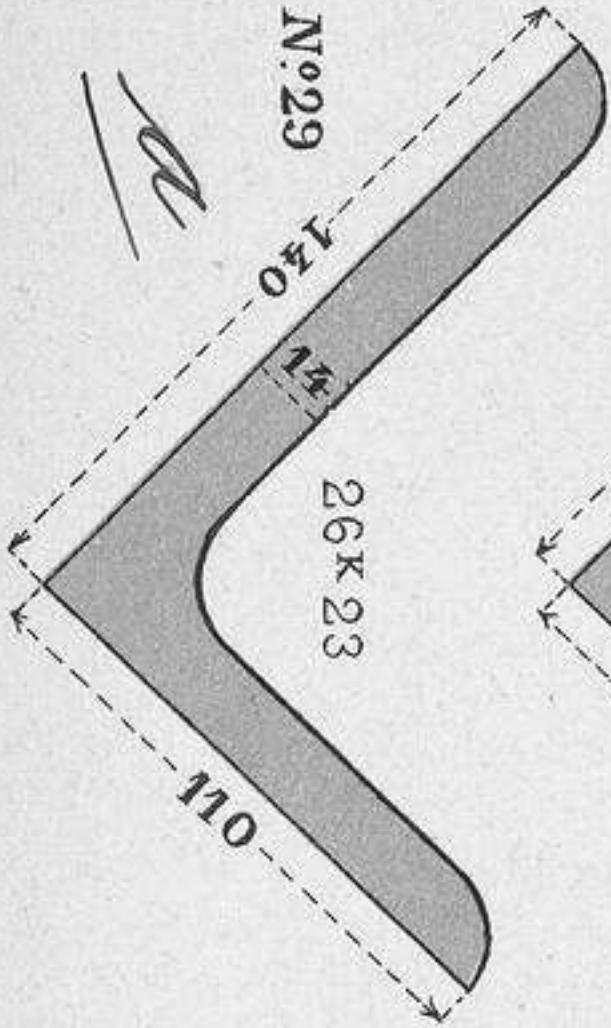

Gruesos intermedios.

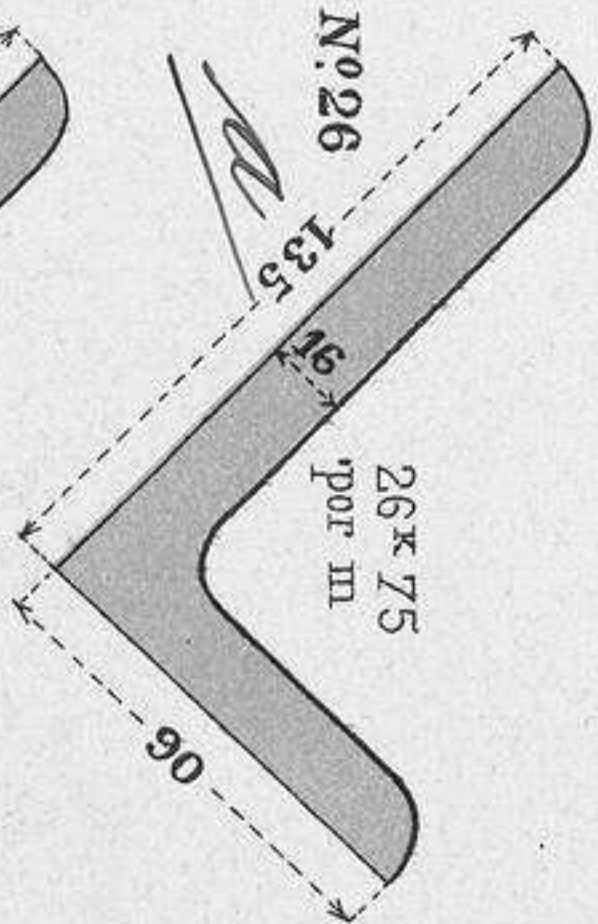
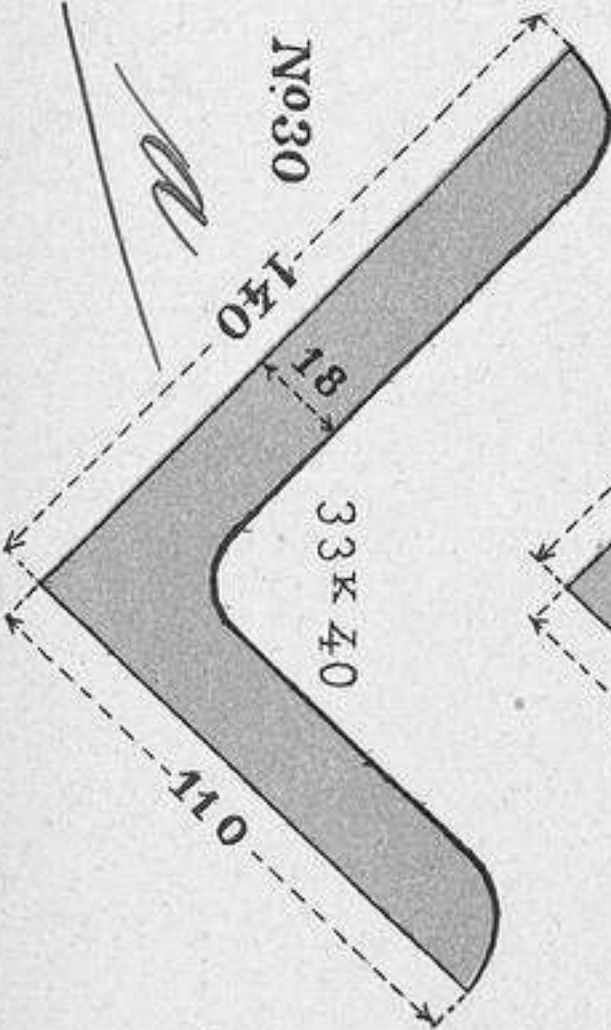

FÁBRICA DE MIERES

Es 1/4

ANGULARES DE RAMAS DESIGUALES

Nota-Pesos aproximados-Cotas en m/m .

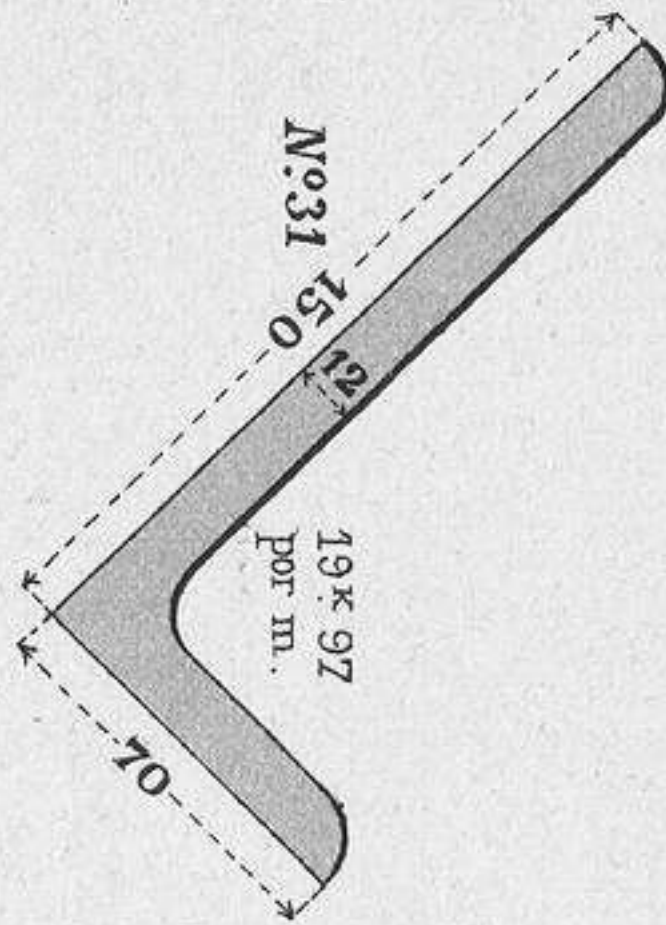
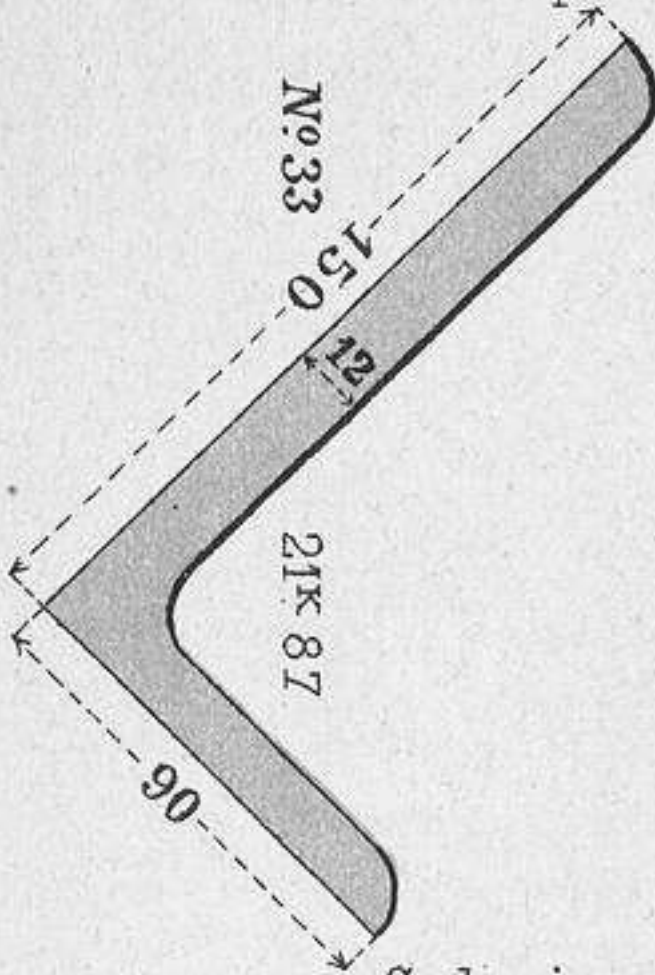

Se laminan gruesos intermedios.

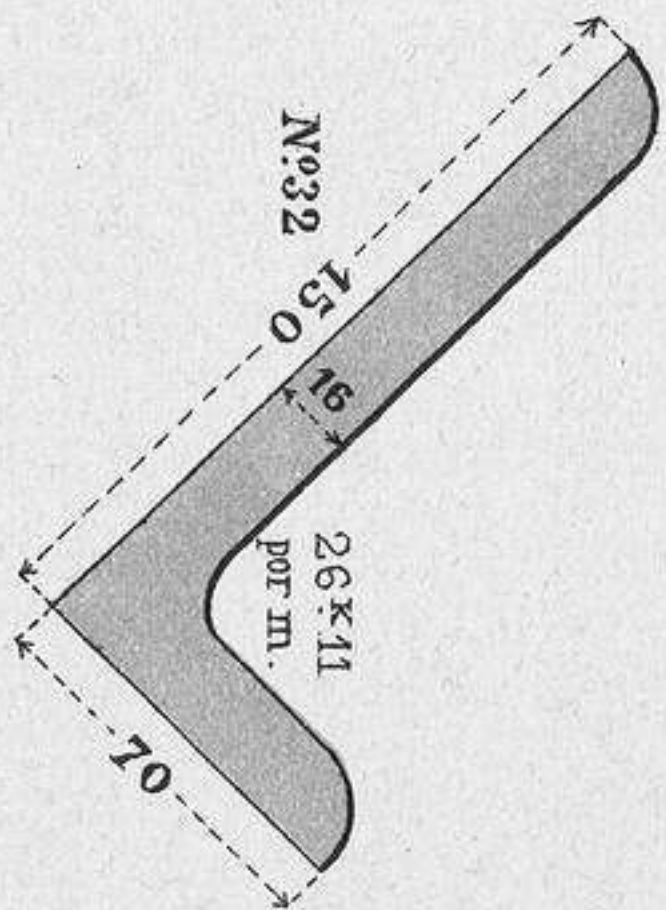
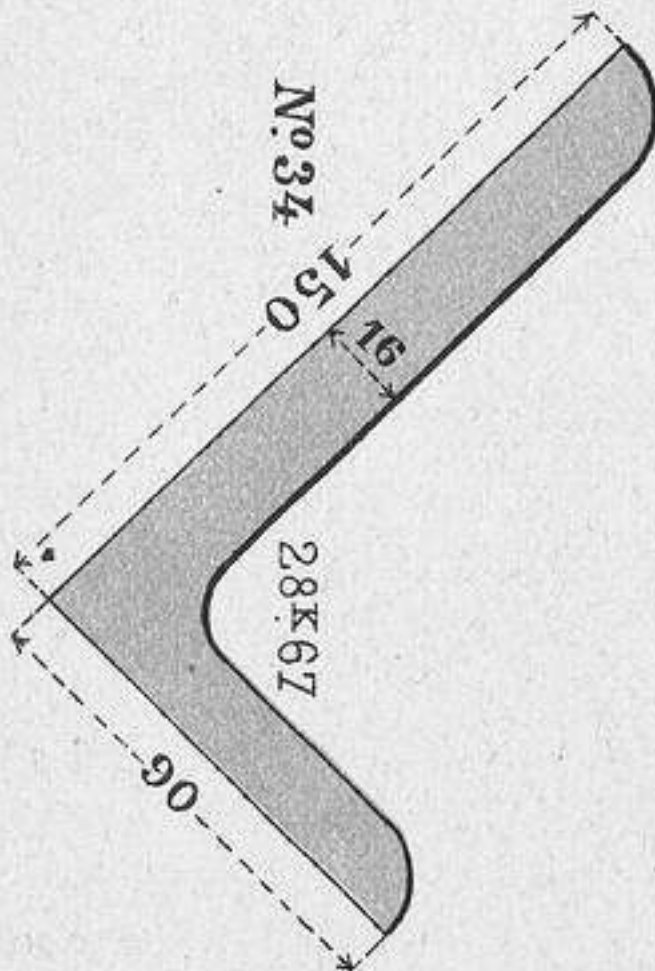

FÁBRICA DE MIERES

ES 1/4

BASTIDORES PARA VIDRIERAS Y ALMENDRADOS

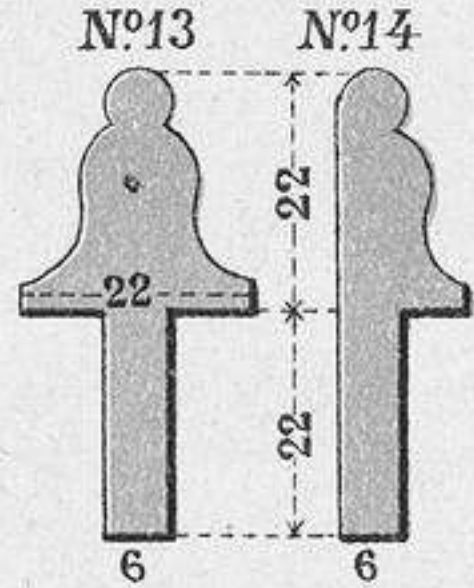
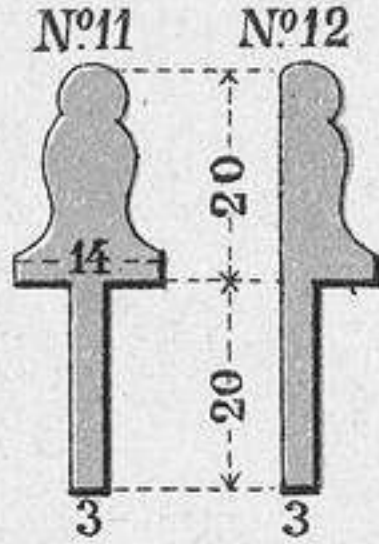
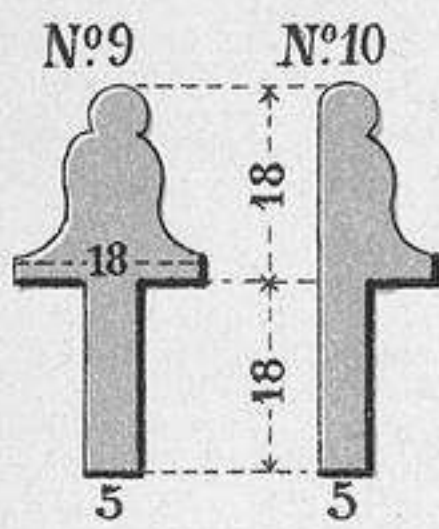
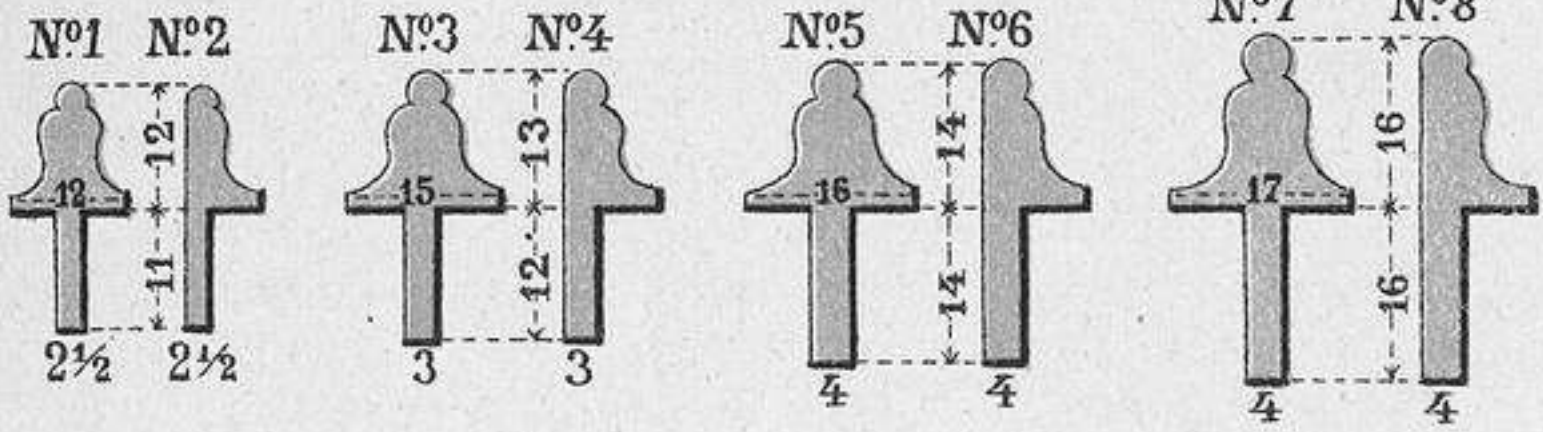

N°1
10x4



N°2
10x5



N°3
10x6



N°4
22x4



N°5
22x5



N°6
12x6



N°7
13x5



N°8
13x6



N°9
13x7



N°10
15x5



N°15

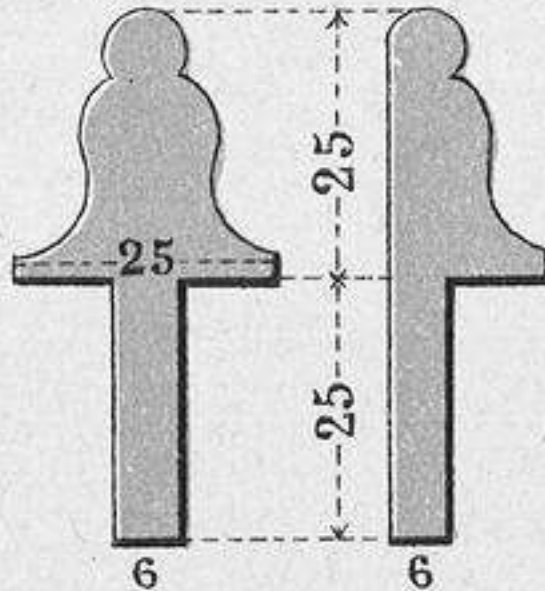

N°16

N°11
15x6



N°12
15x7



N°13
15x8



N°14
17x7



N°15
17x8



N°16
17x9



N°17
19x8



N°18
19x10



Nota - Cotas en $\frac{m}{m}$.

FÁBRICA DE MIERES

Es. 1/4

PASAMANOS LISOS Y MEDIOS REDONDOS

Nota-Cotas en $\frac{m}{m}$.

Nº1		Nº2	Nº3		Nº4		
Nº5			Nº6	Nº7		Nº8	
Nº9			Nº10	Nº11		Nº12	
Nº13			Nº14	Nº15		Nº16	
Nº17			Nº18	Nº19		Nº20	
Nº21			Nº22	Nº23		Nº24	
Nº25			Nº26	Nº27		Nº28	
Nº29			Nº30	Nº31		Nº32	
Nº33			Nº34	Nº35		Nº36	
Nº37			Nº38	Nº39		Nº40	

Nota-Gruesos intermedios

Nota-Cotas en $\frac{m}{m}$.

FÁBRICA DE MIERES

Es $\frac{1}{4}$

PASAMANOS LISOS Y MEDIOS REDONDOS

Nota-Cotas en $\frac{m}{m}$.

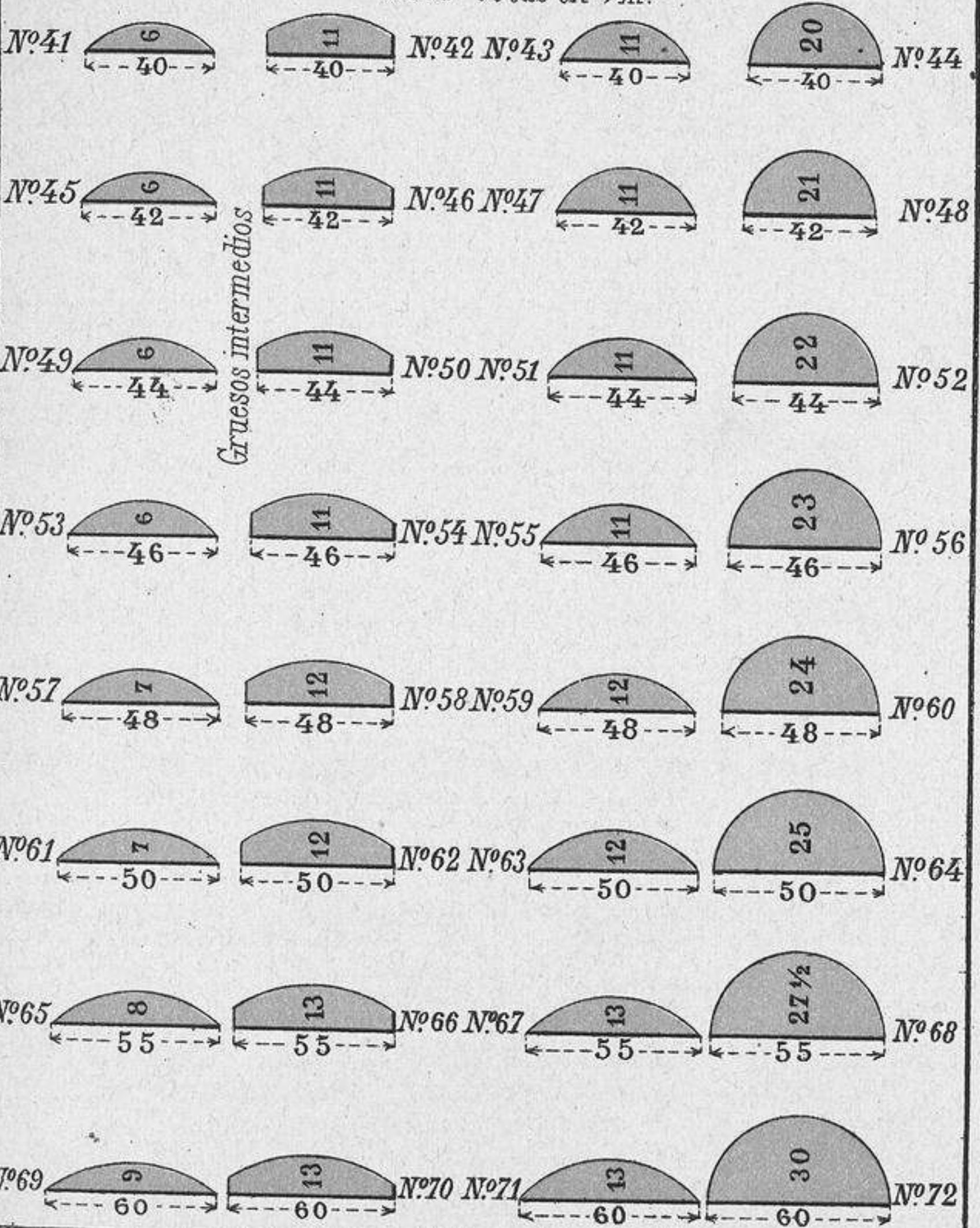









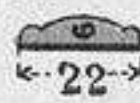

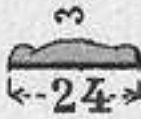
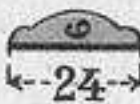

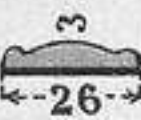
FÁBRICA DE MIERES

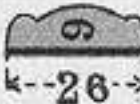
Es. 1/4

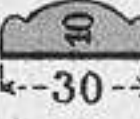
PASAMANOS CON FILETE

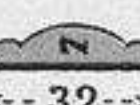
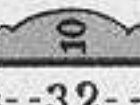
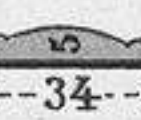
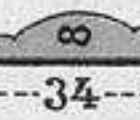
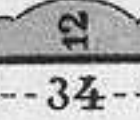
Nota-Cotas en m/m .

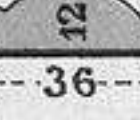
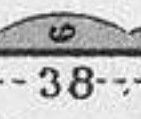
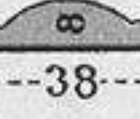
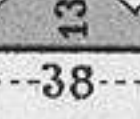
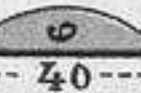
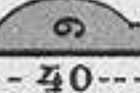
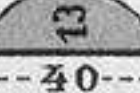
Nº 1		Nº 2	Nº 3		Nº 4	
Nº 4		Nº 6	Nº 7		Nº 8	
Nº 9		Nº 10	Nº 11		Nº 12	
Nº 13		Nº 14	Nº 15		Nº 16	
Nº 17		Nº 18	Nº 19		Nº 20	
Nº 21		Nº 22	Nº 23		Nº 24	
Nº 25		Nº 26	Nº 27		Nº 28	
Nº 29		Nº 30	Nº 31		Nº 32	
Nº 33		Nº 34	Nº 35		Nº 36	

Gruesos intermedios

Gruesos intermedios.

FÁBRICA DE MIERES

Es. ¼

PASAMANOS CON FILETE

Nota-Cotas en $\frac{m}{m}$.

Nº 37

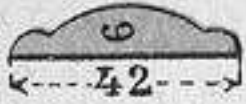

Nº 38



Nº 39

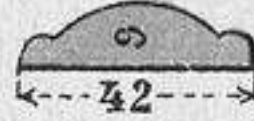

Nº 40



Nº 41

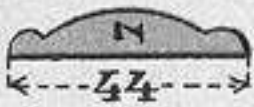

Nº 42



Nº 43



Nº 44

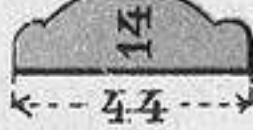

Nº 45

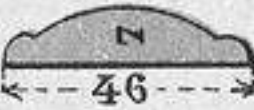

Nº 46

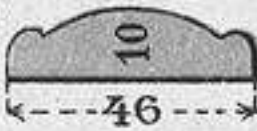

Nº 47

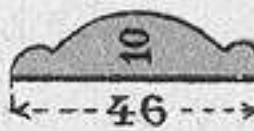

Nº 48

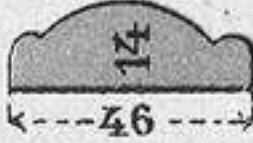

Nº 49

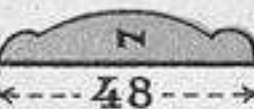

Nº 50

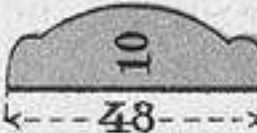

Nº 51

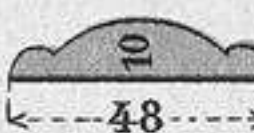

Nº 52

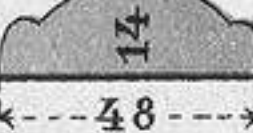

Nº 53

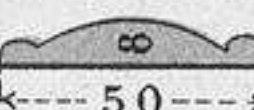

Nº 54

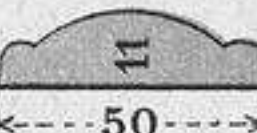

Nº 55

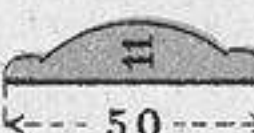

Nº 56

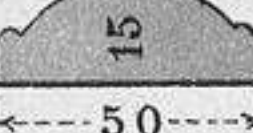

Nº 57

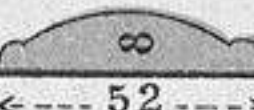

Nº 58

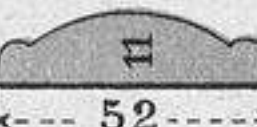

Nº 59

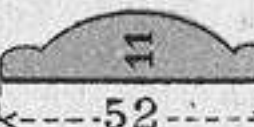

Nº 60

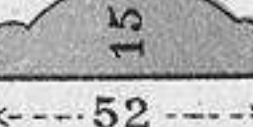

Nº 61

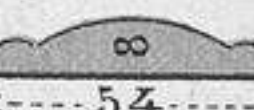

Nº 62

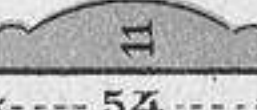

Nº 63

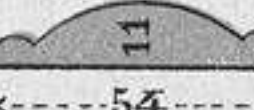

Nº 64

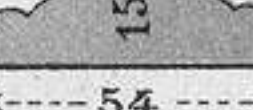

Se laminan gruesos intermedios

Se laminan gruesos intermedios

FÁBRICA DE MIERES

Es $\frac{1}{40}$

PLANCHAS COMBADAS PARA PISOS

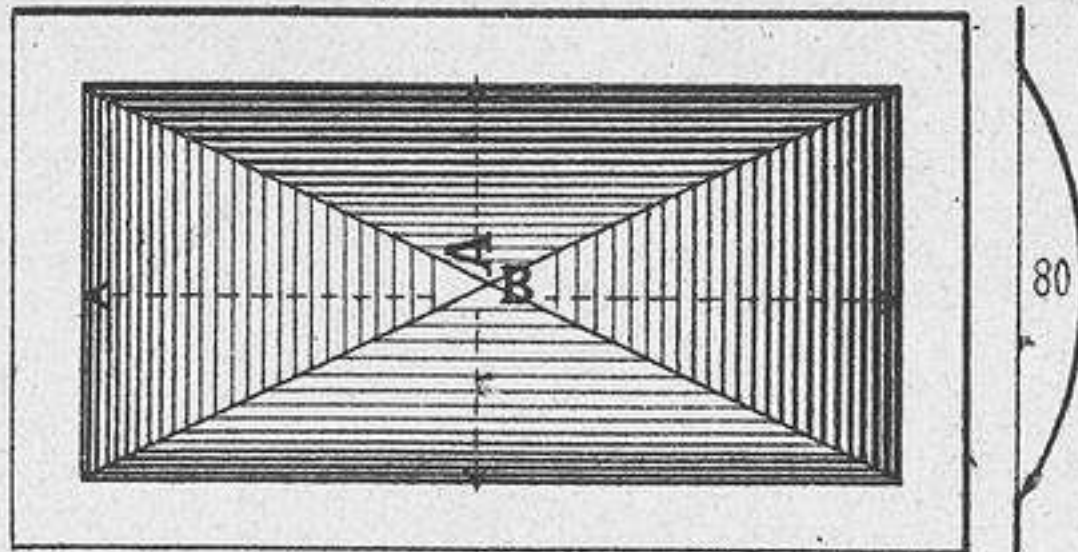
Nota - Cotas en m.^s Gruesos de 3 à 12 m/m.

Nº1. A = 0,50. B = 0,63.

Nº2. A = 0,65. B = 0,90.

Nº3. A = 0,79. B = 1,07.

Nº4. A = 0,95. B = 1,17.

Nº5. A = 0,86. B = 1,20.

Nº6. A = 0,77. B = 1,58.

Nº7. A = 0,90. B = 1,60.

Nº8. A = 0,95. B = 1,78.

Nº9. A = 0,85. B = 1,85.

Nº10. A = 1,09. B = 1,23.

Nº11. A = 1,35. B = 1,35.

Nota - Todos los bordes planos pueden variar de 20 à 200 m/m

FÁBRICA DE MIERES

Ejes concluidos

Ejes forjados

Nº1

Nº2

Nº1

Nº2

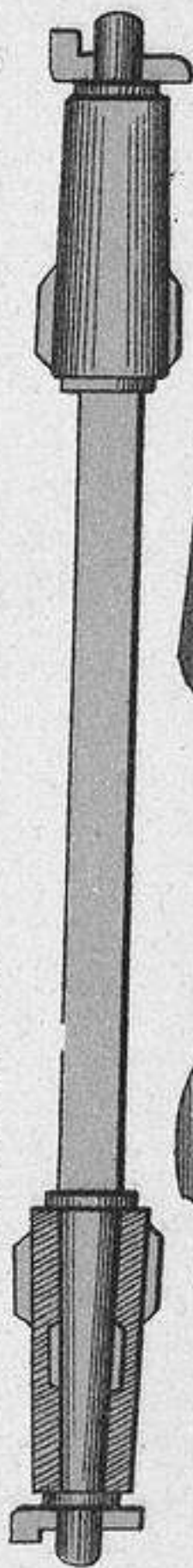
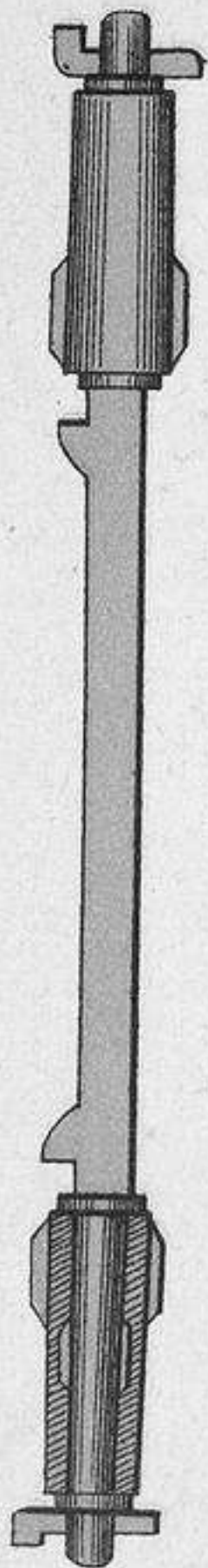

Palanca lisa

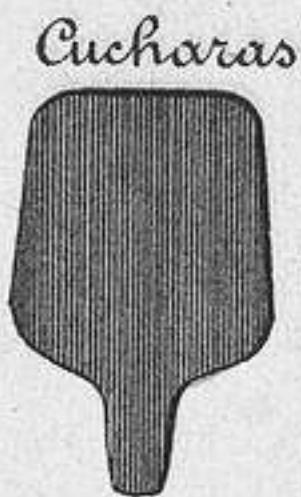

Cucharas

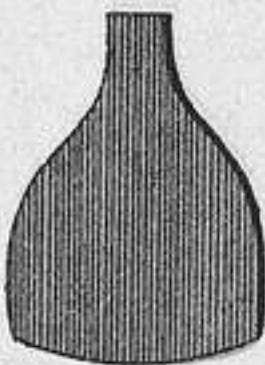

Cabras

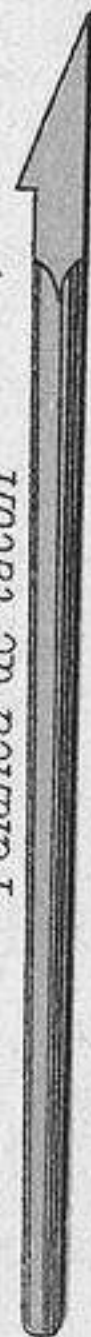

Palanca de tacon

FÁBRICA DE MIERES



BALAUSTRÉS ESTAMPADOS

Nº1



Nº2



Nº3



Nº4



Nº5



Nº6

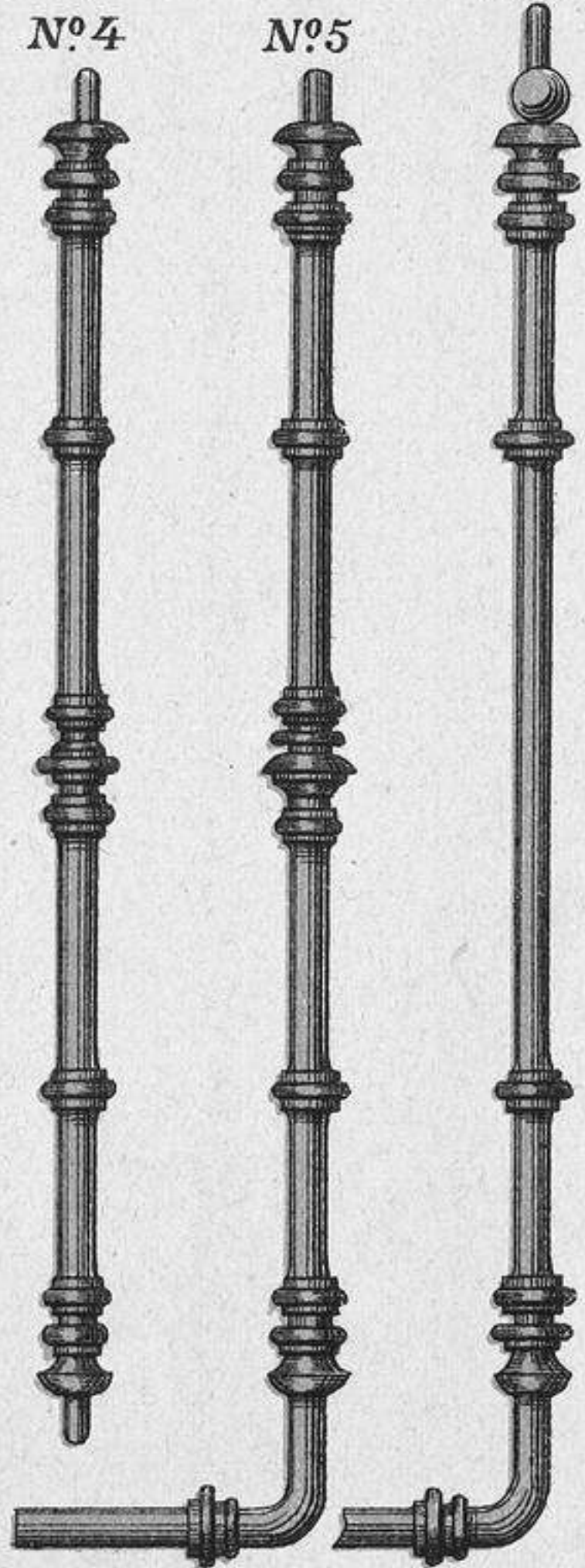

FÁBRICA DE MIERES
COLUMNAS DE HIERRO FUNDIDO

Nº 5

Nº 1

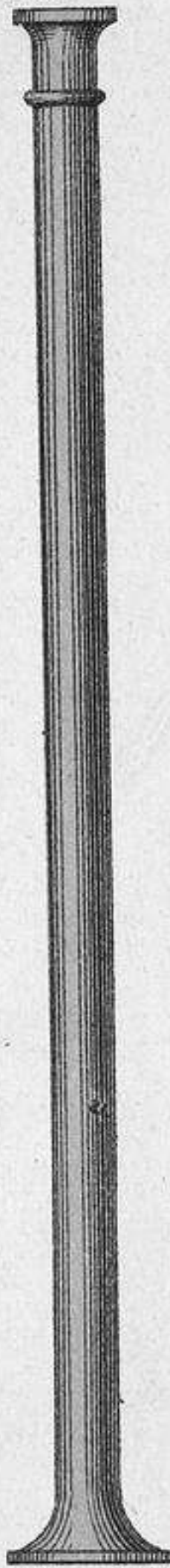

Nº 3

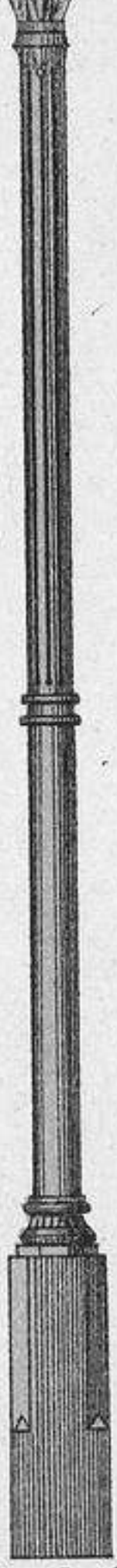
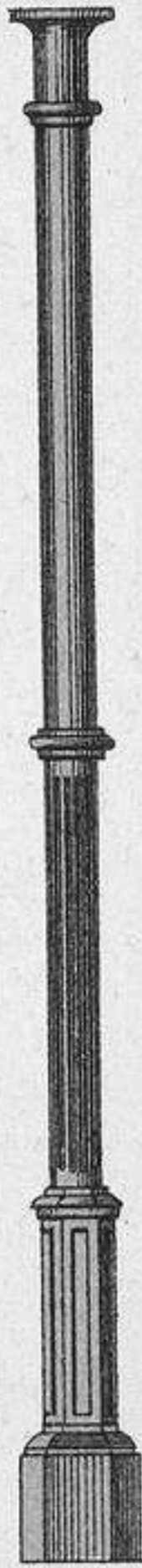

Nº 4

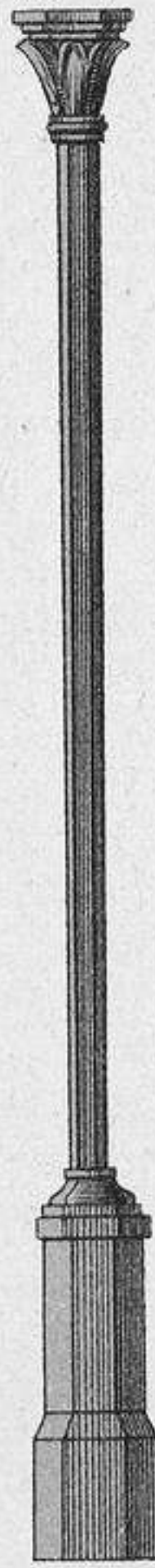

Nº 2

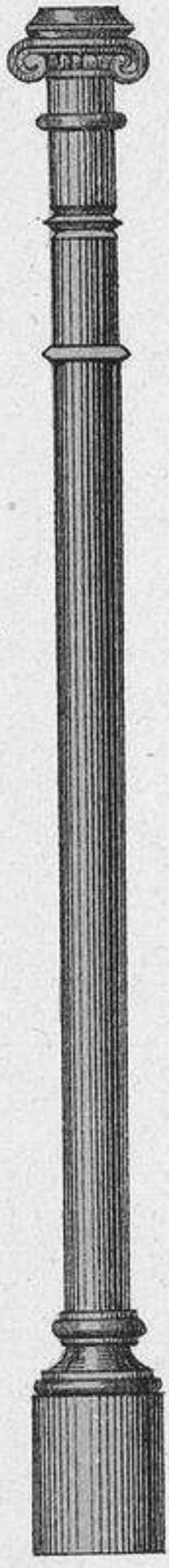

Escala 1/50

FÁBRICA DE MIERES

COLUMNAS DE HIERRO FUNDIDO

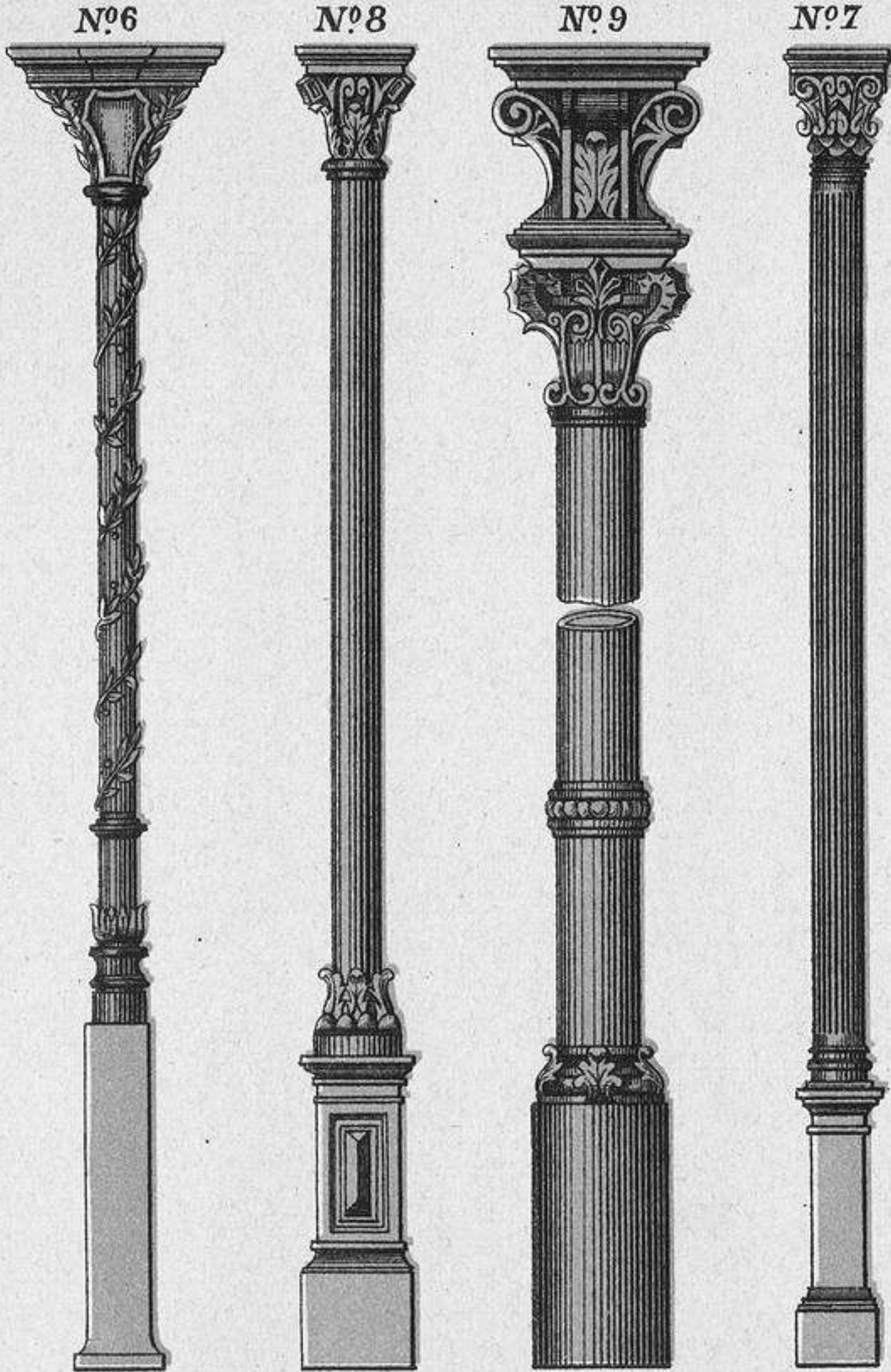

Escala 1/50

FABRICA DE MIERES



COLUMNAS DE HIERRO FUNDIDO

Nº 11

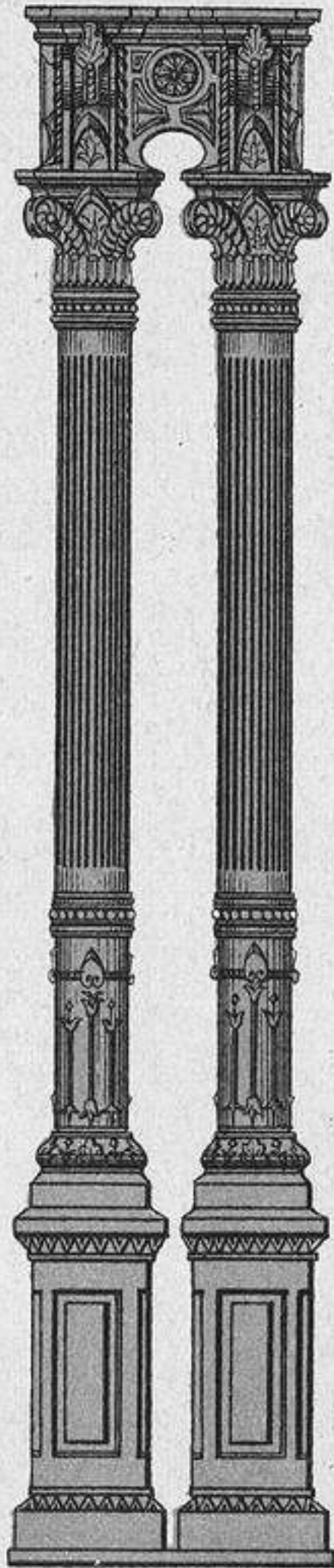

Nº 10

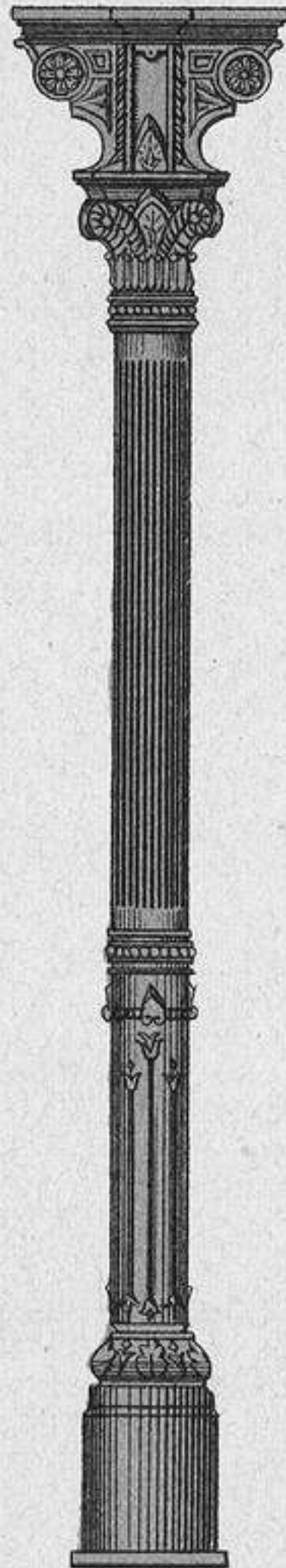

Escala 1/50

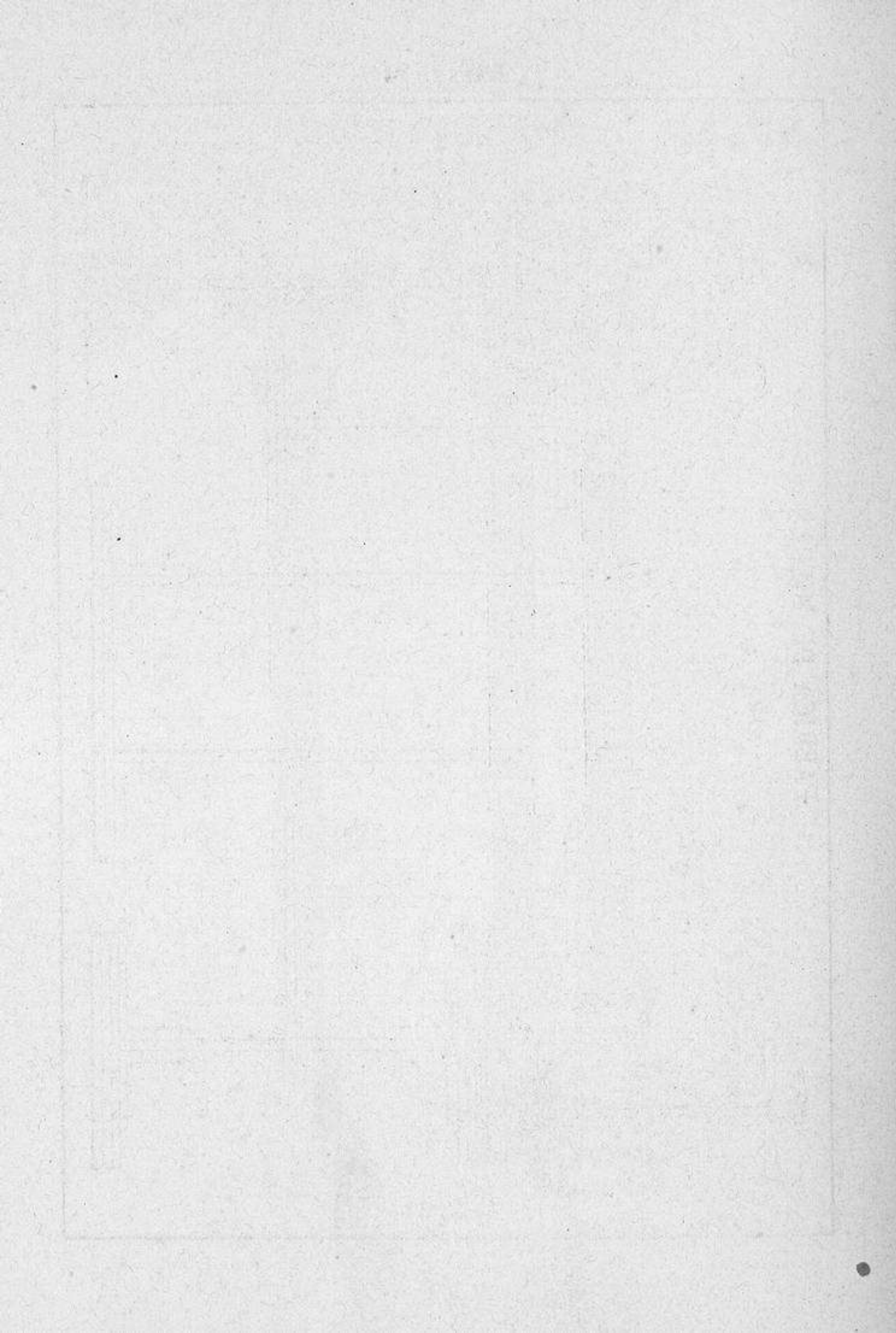

FABRICA DE MIERES

VIGAS ARMADAS

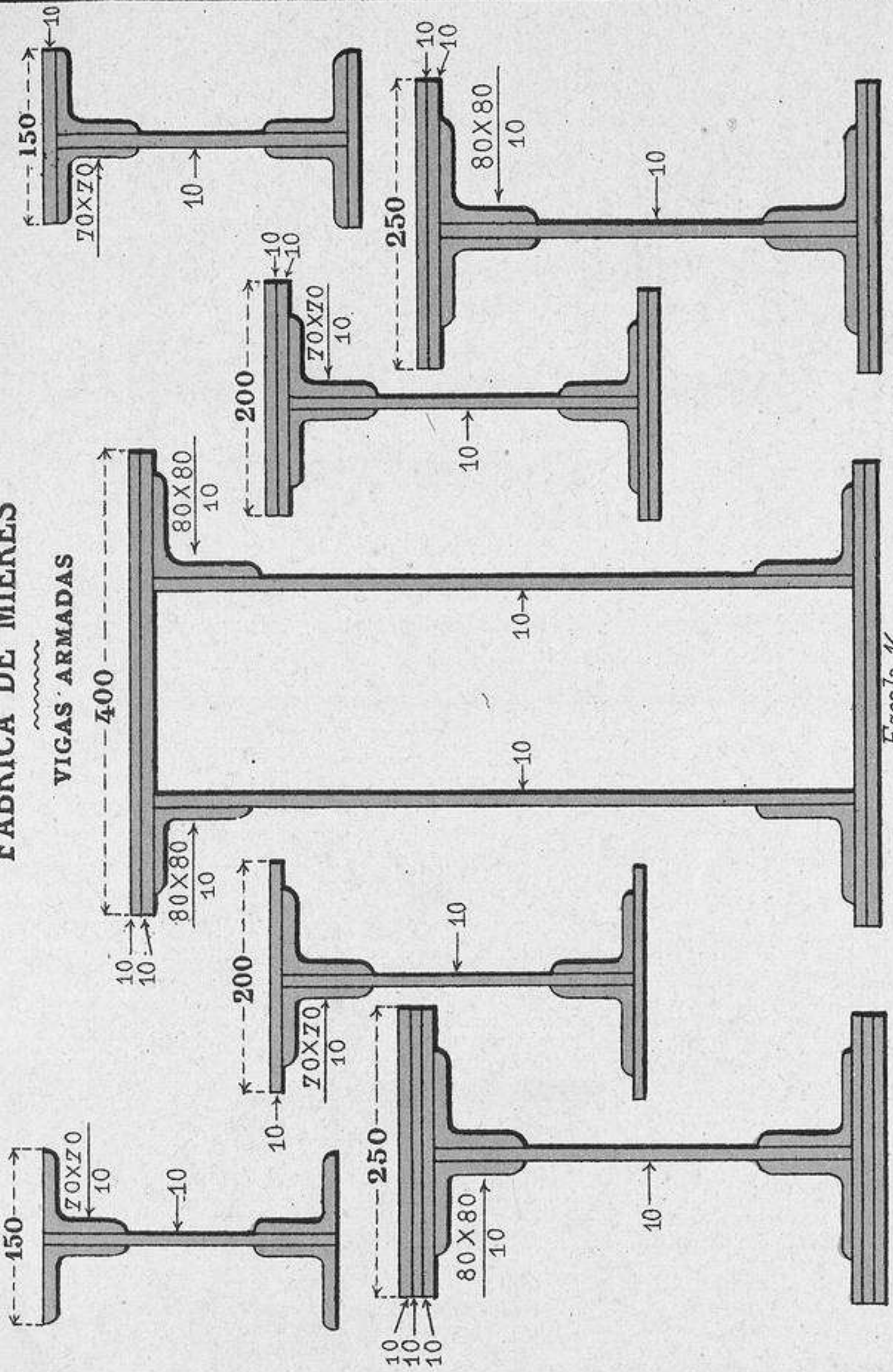

Escala 1/10

FÁBRICA DE MIERES

CONSTRUCCIONES METÁLICAS

Marquesinas y vigas armadas

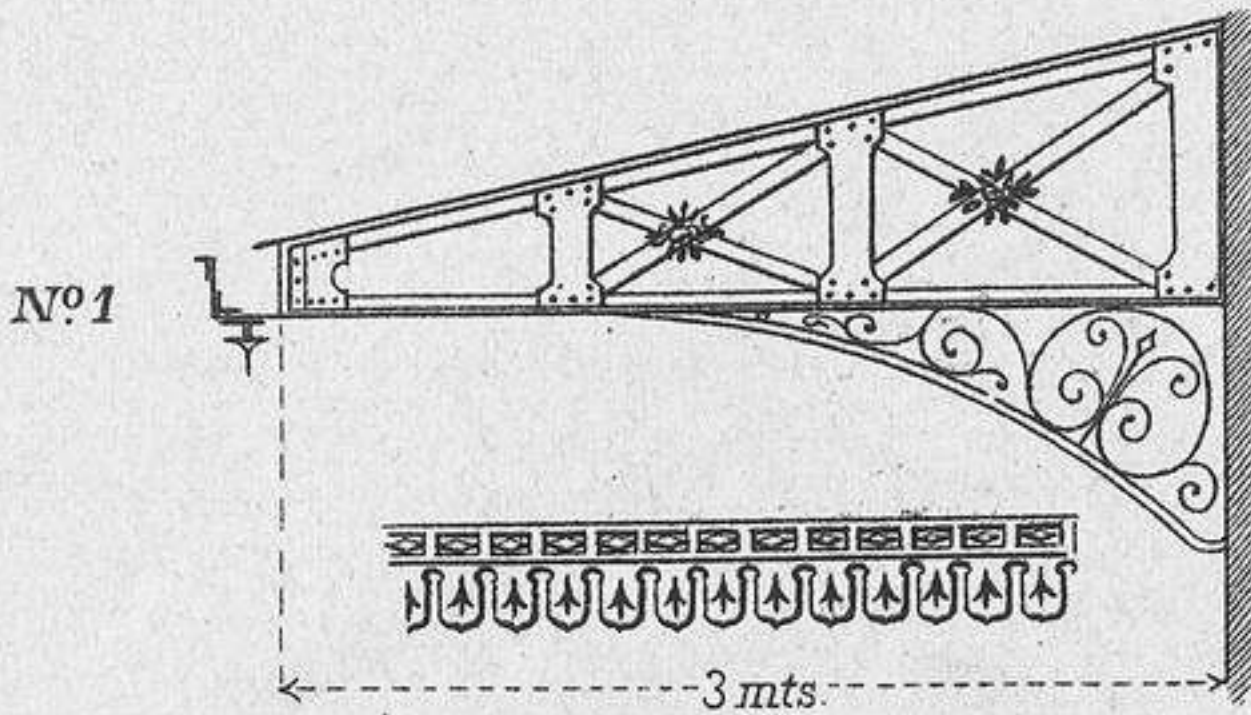
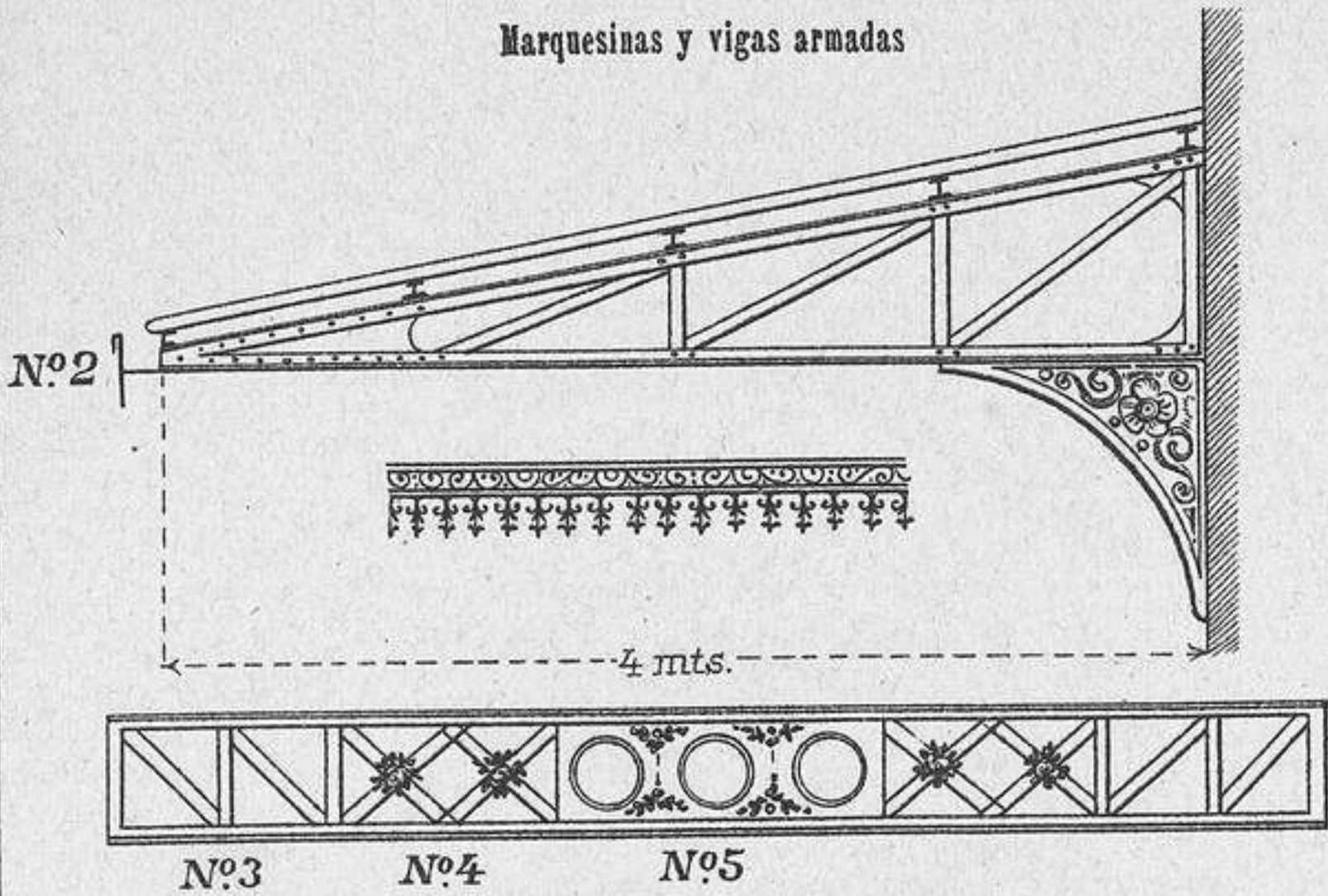

Escala $\frac{1}{66}$

FÁBRICA DE MIERES

ARMADURAS

Sección AB

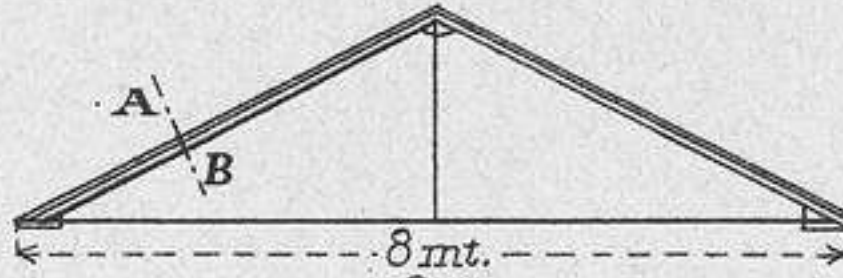

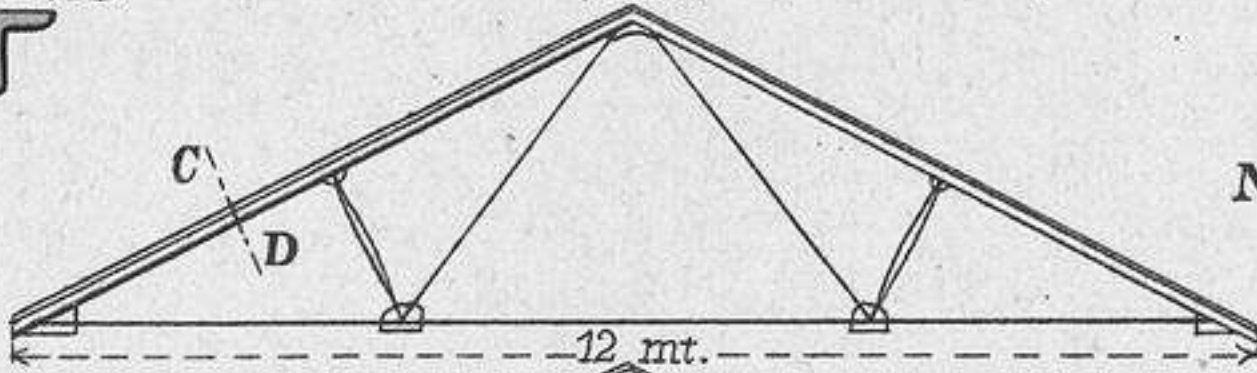

Nº 1

Sección CD

Nº 2

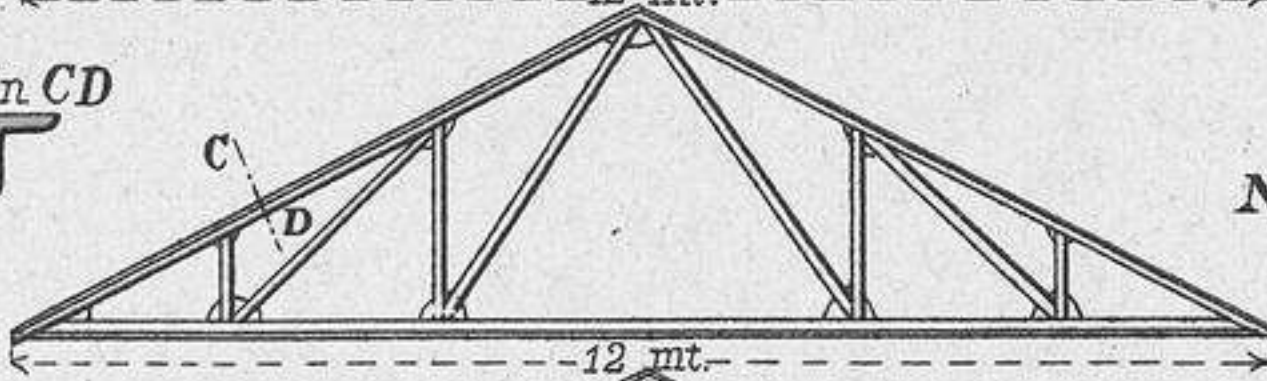

Nº 3

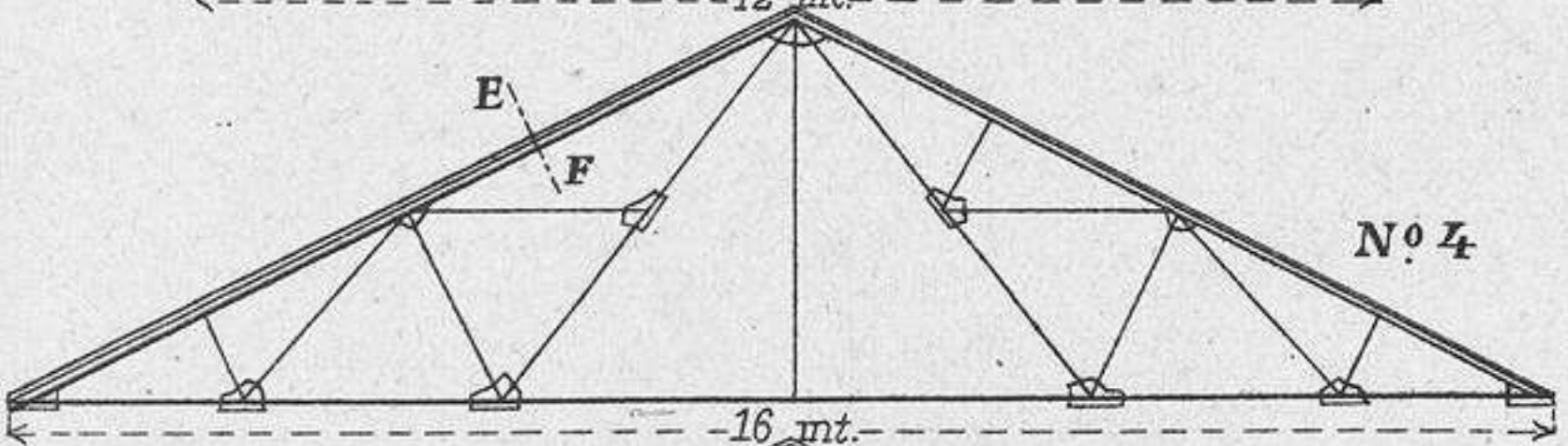

Nº 4

Sección EF

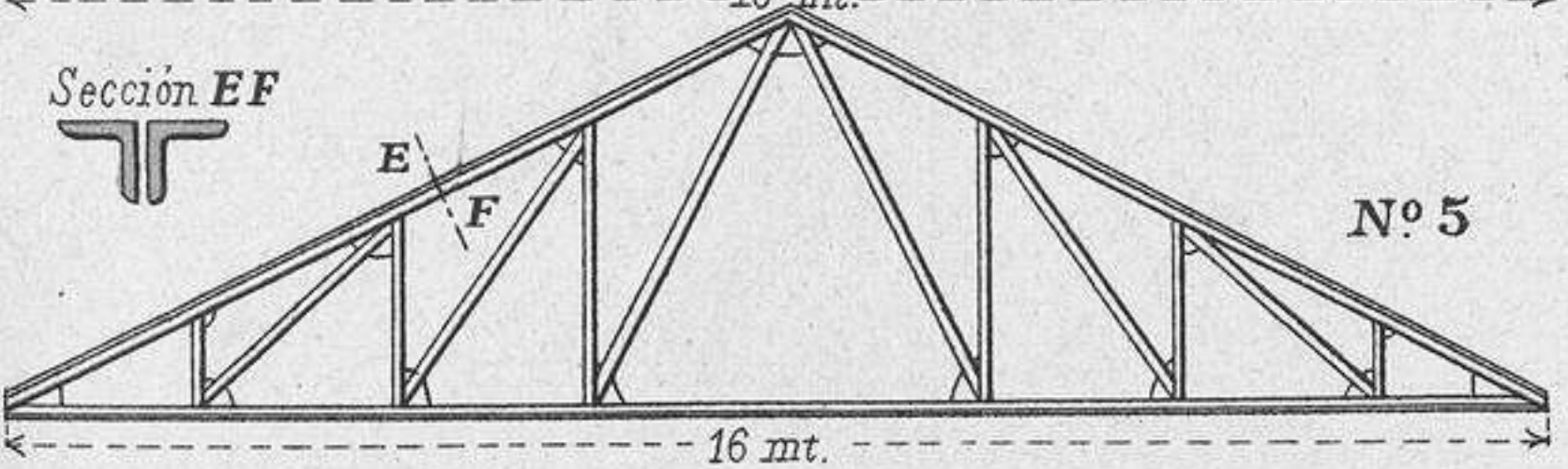
Nº 5

Escala $\frac{1}{200}$

Escala secciones $\frac{1}{20}$

FÁBRICA DE MIERES

TORRE PARA UN MOLINO

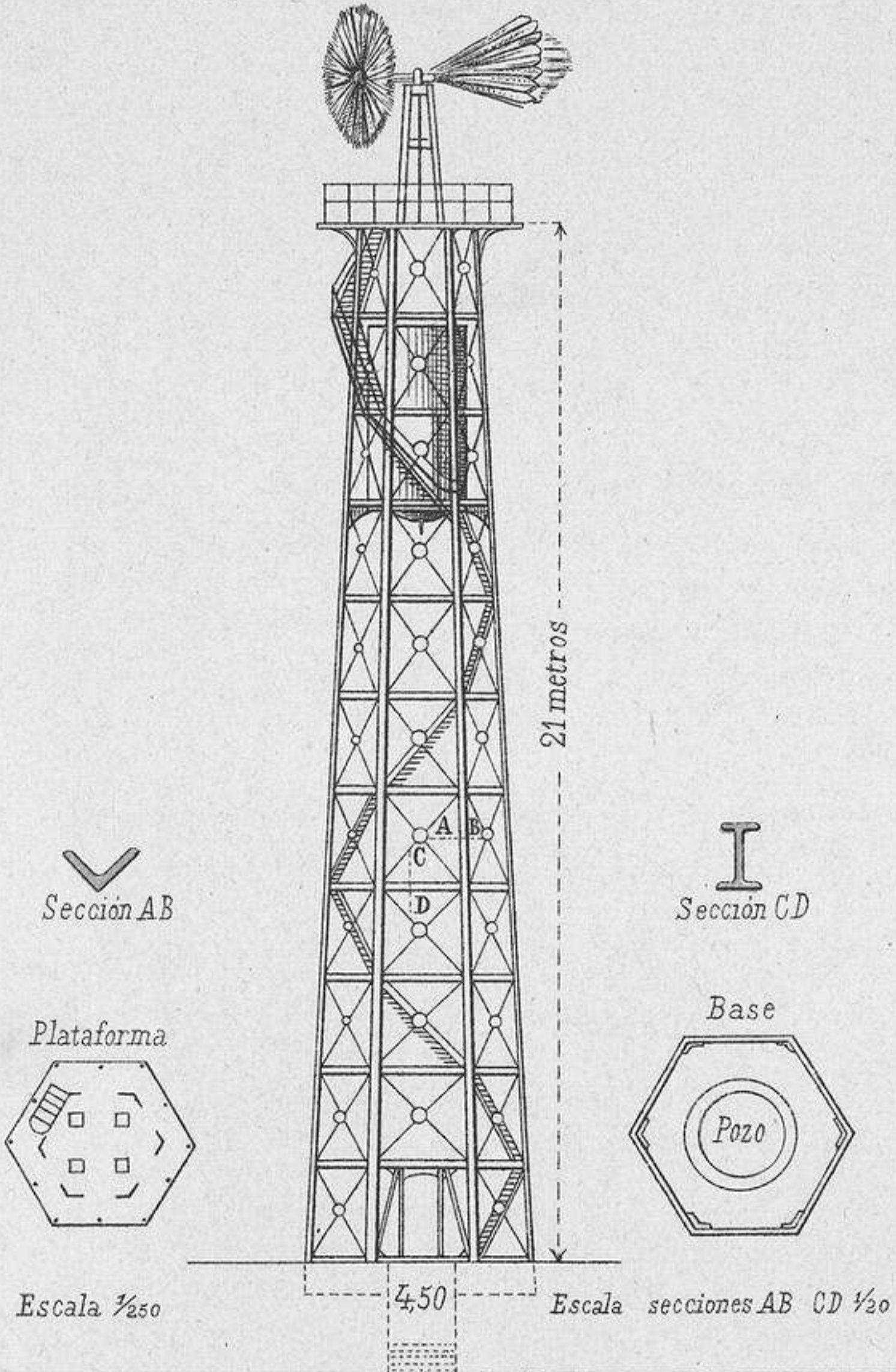

Sección AB

Sección CD

Plataforma

Base

Escala $\frac{1}{250}$

4,50

Escala secciones AB CD $\frac{1}{20}$

FÁBRICA DE MIERES

MERCADO DE OVIEDO

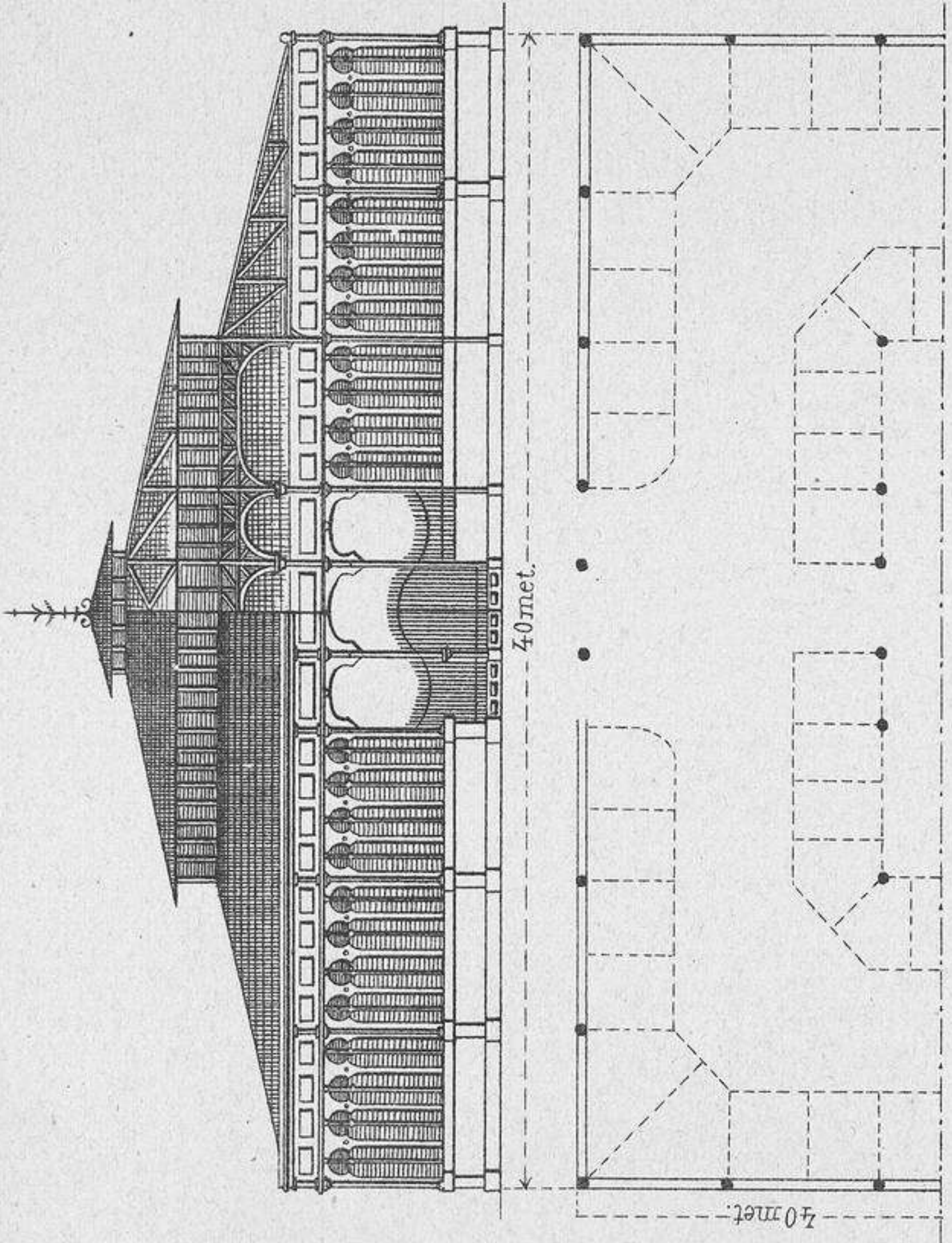

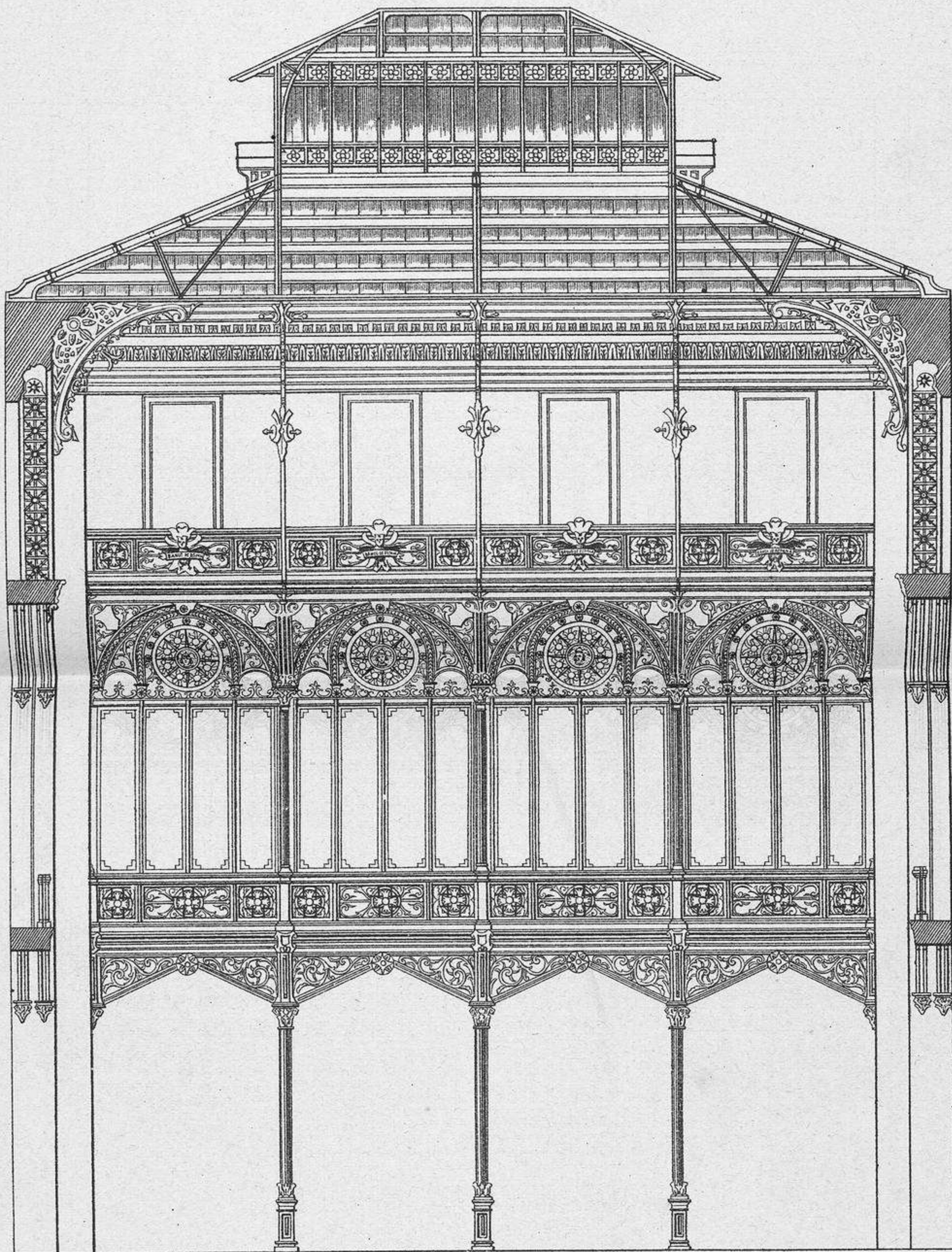

FÁBRICA DE MIERES

PATIO DEL BANCO DE ESPAÑA

FÁBRICA DE MIERES

PONTONES PARA CARRETERAS

Alzado

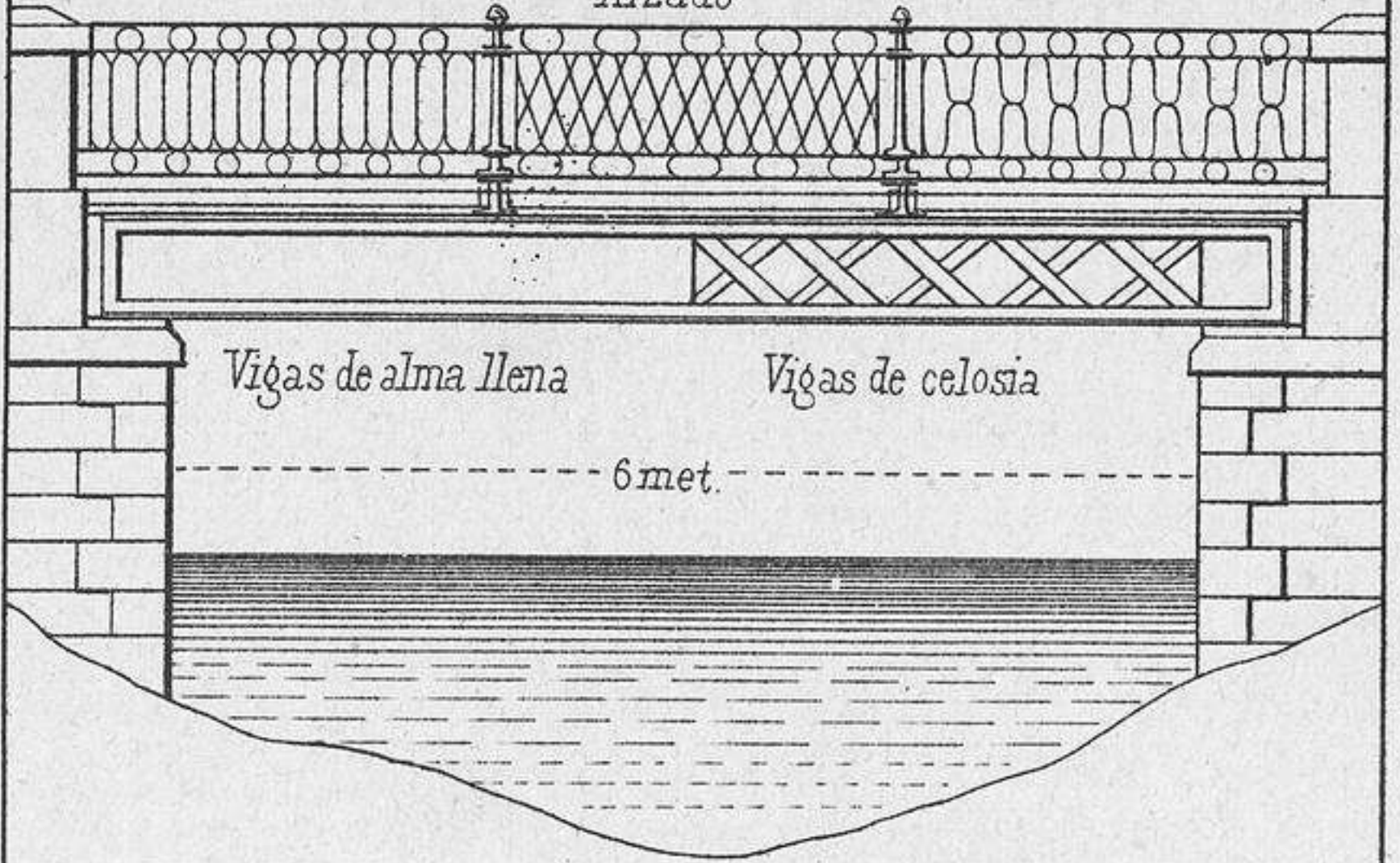

Sección trasversal

6 met.

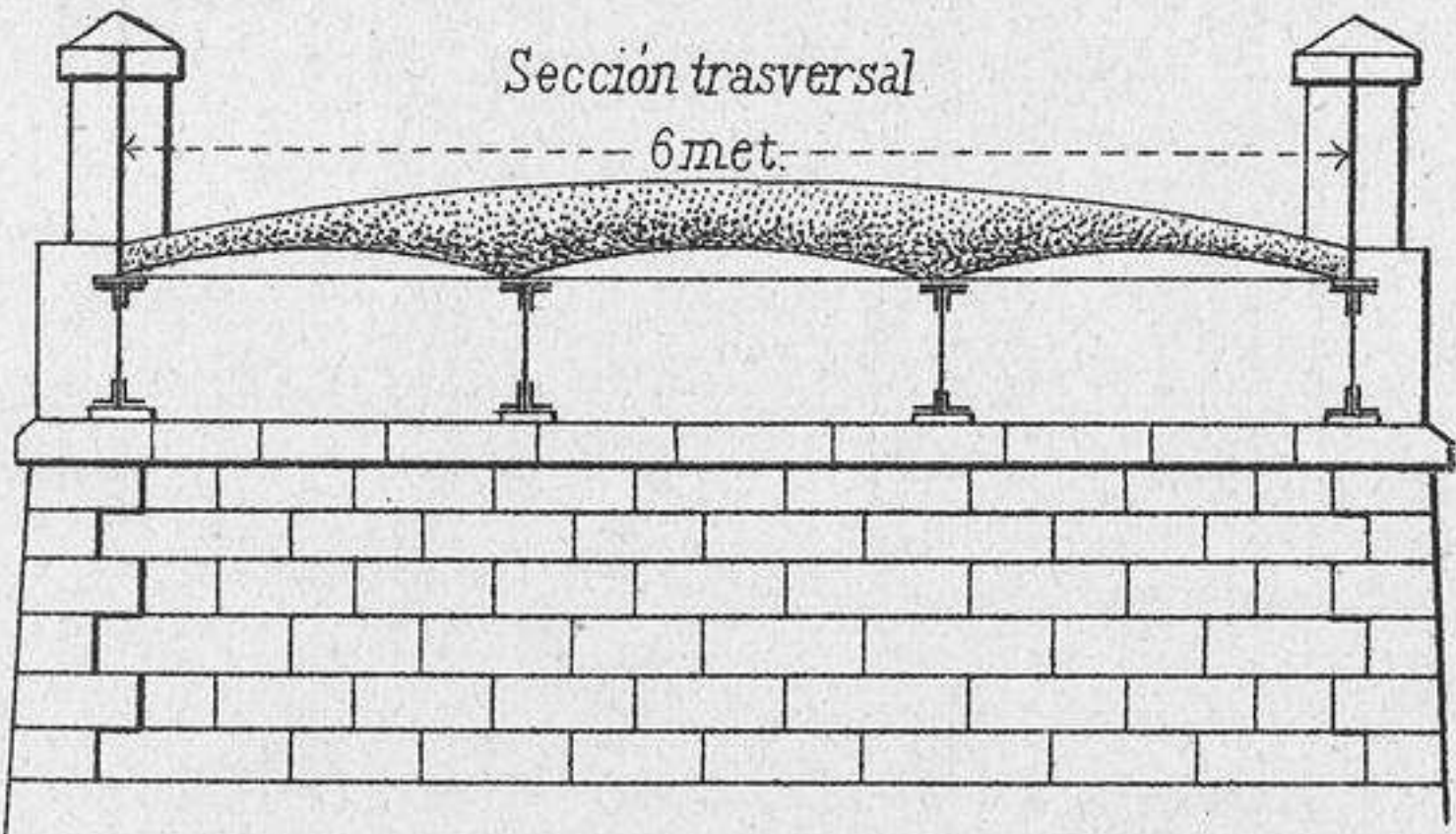

FÁBRICA DE MIERES

PUENTES PARA CARRETERAS

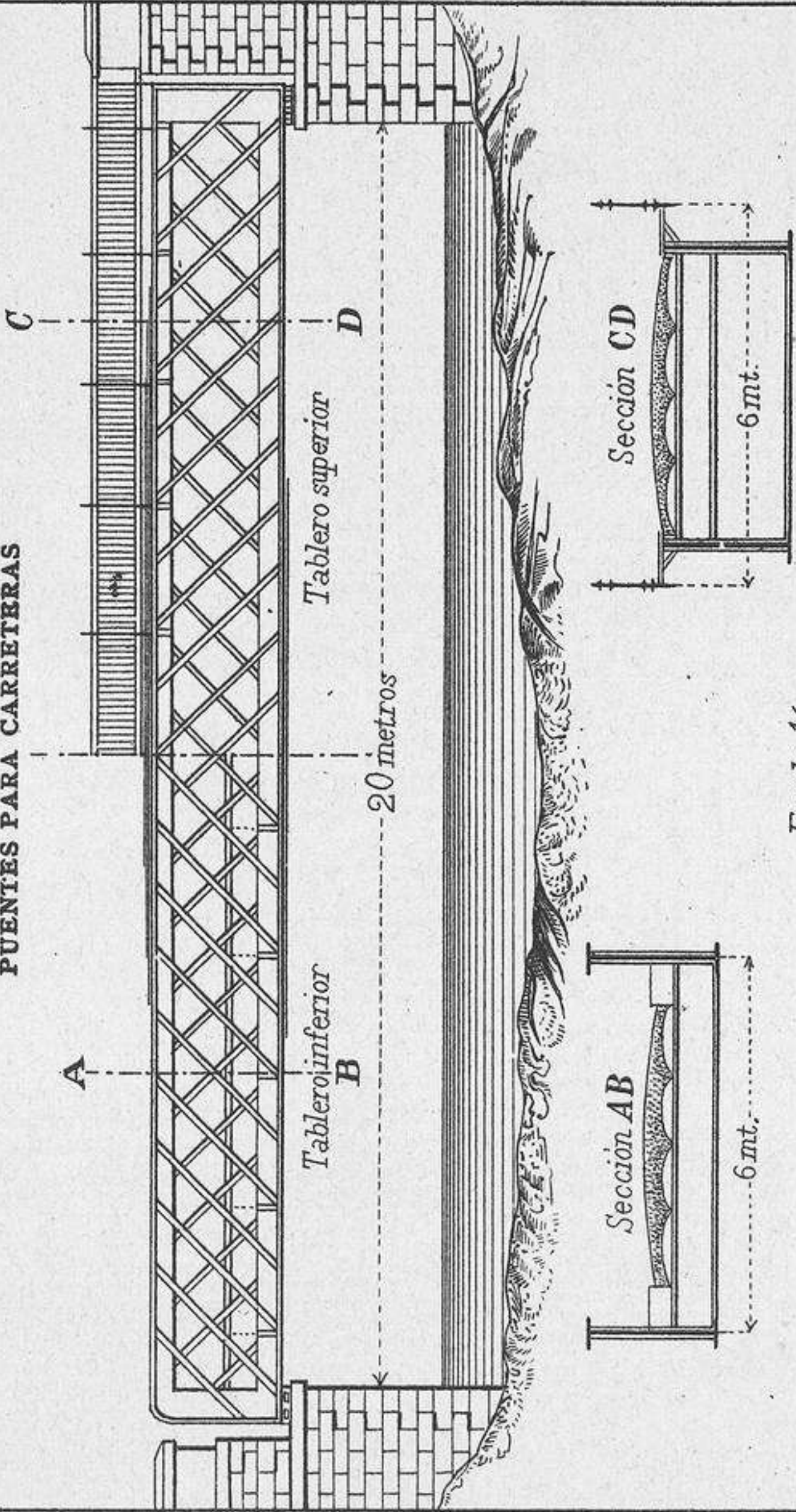

Escala 1/200

FABRICA DE MIERES

PUENTES PARA FERROCARRILES

Elevacion

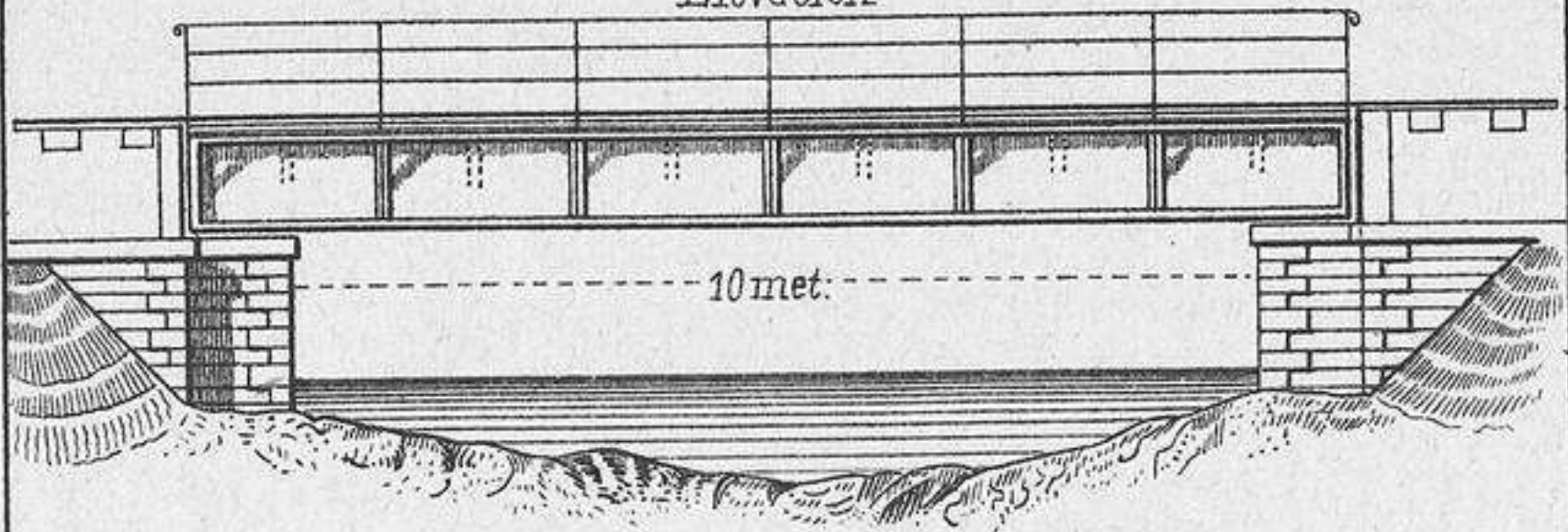

450
Seccion trasversal

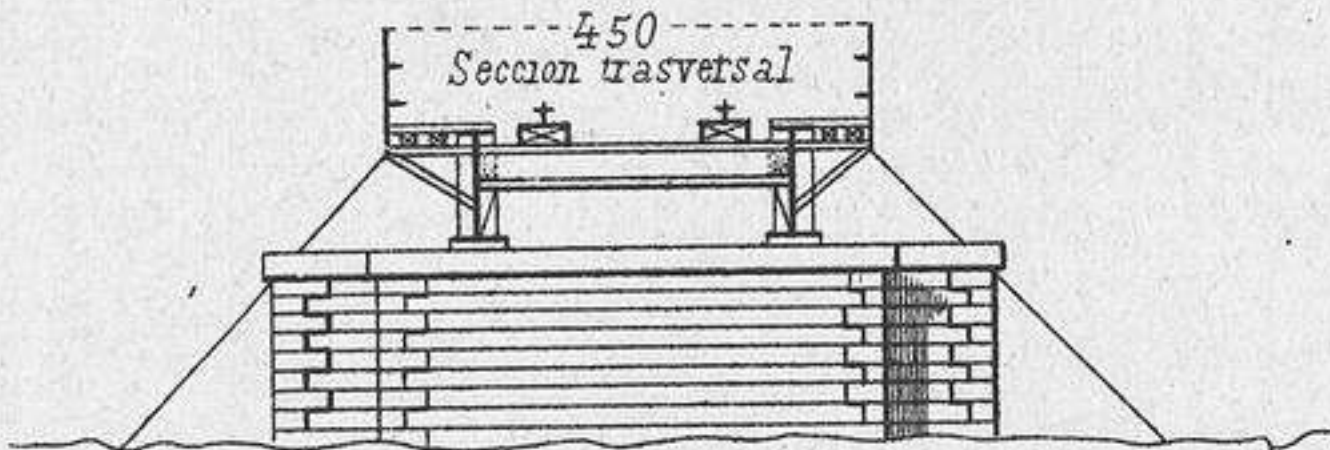

Planta

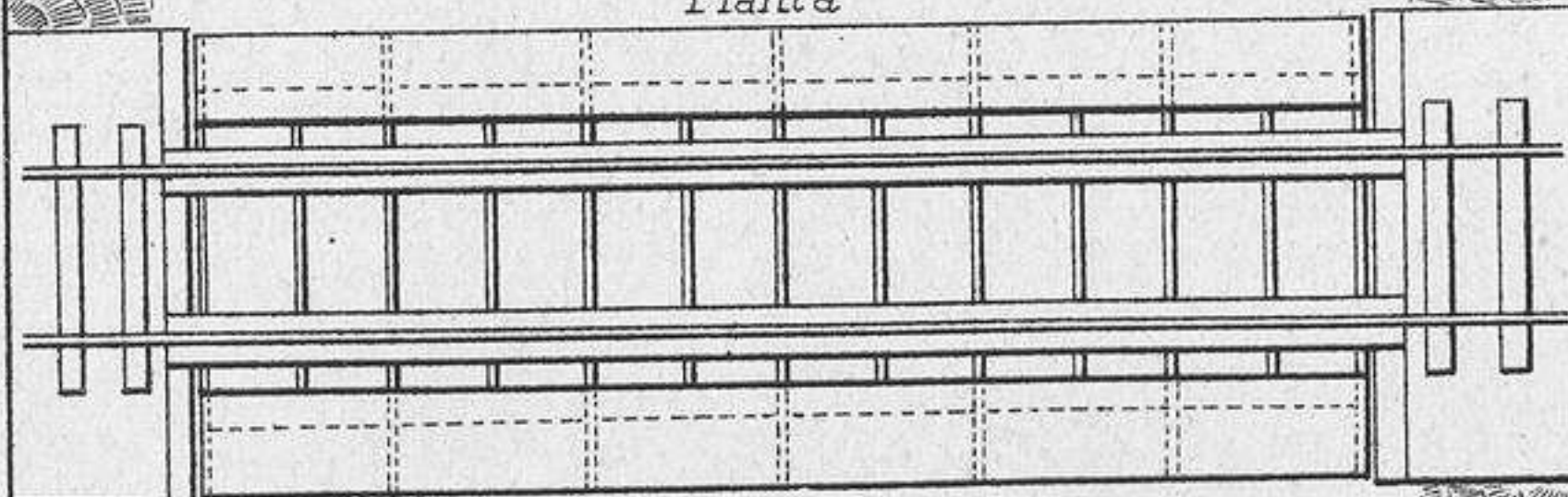

Escala 1/200

FABRICA DE MIERES

PUENTE SOBRE EL RÍO SIL EN SEQUEIRCS

Ferrocarril de A. G. L., línea de Galicia

Longitud total 150 met.^s

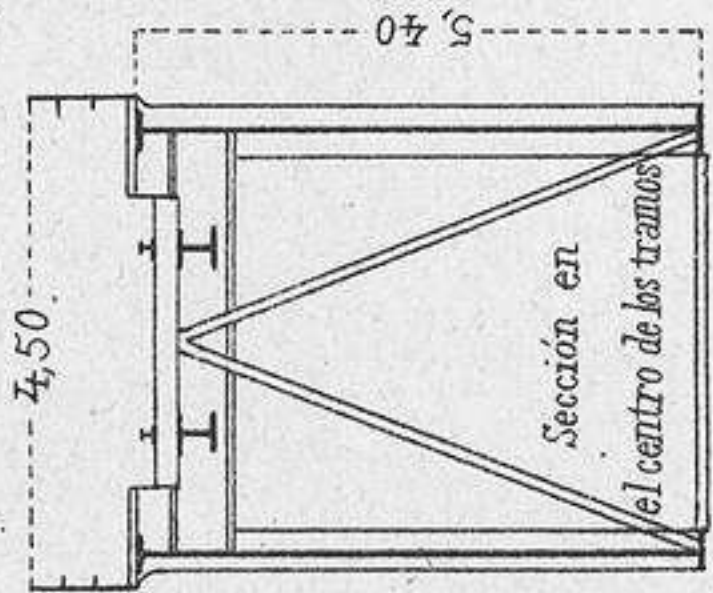
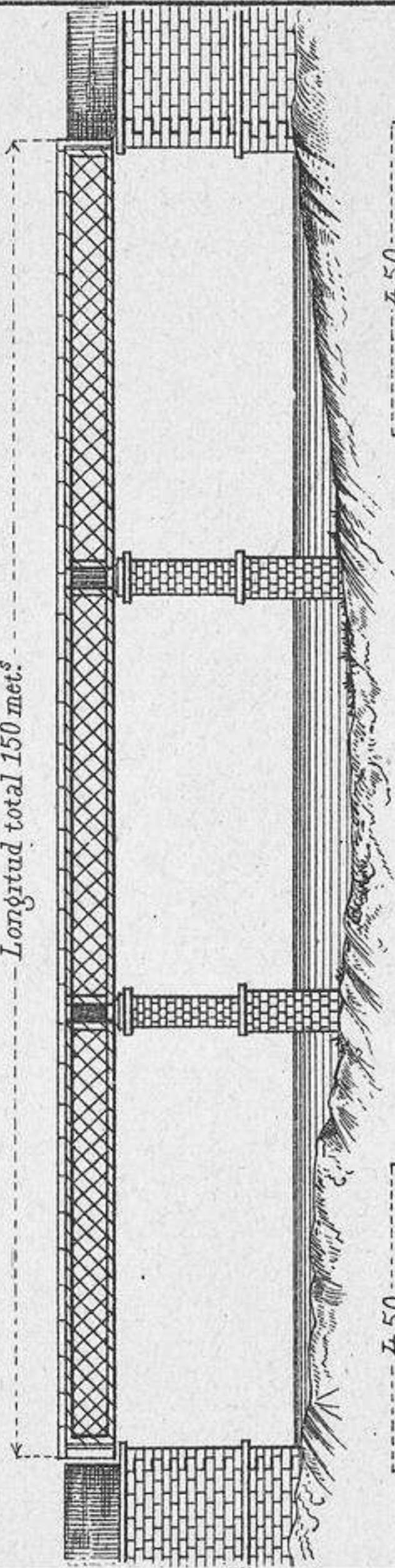

Escala del conjunto $\frac{1}{600}$
Escala de las secciones $\frac{1}{200}$

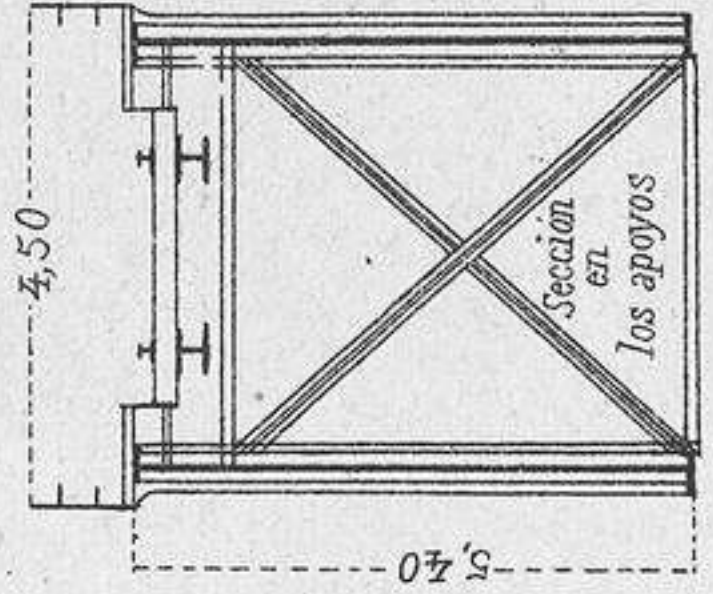

FÁBRICA DE MIERES

~
CALDERAS DE HOGAR INTERIOR

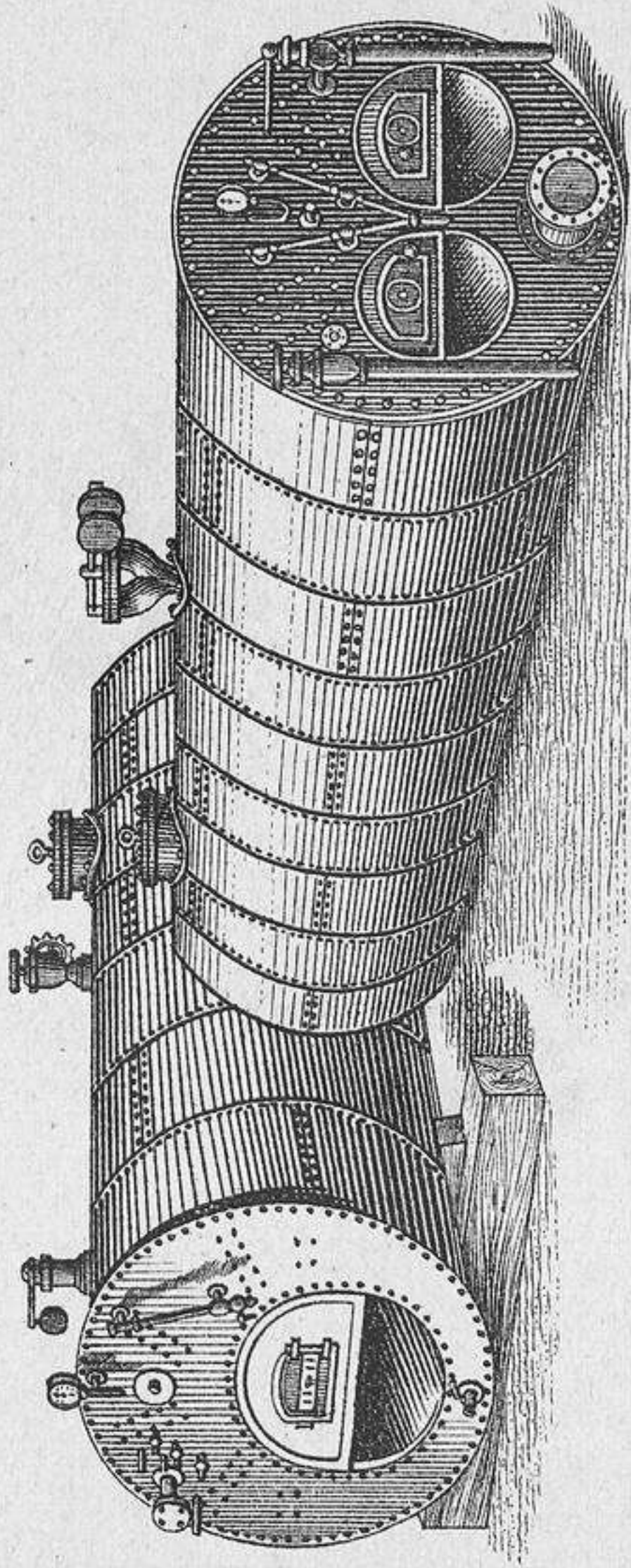

Es. 1/25

FABRICA DE MIERES

VAGÓN DE PALASTRO PARA EL INTERIOR DE LAS MINAS

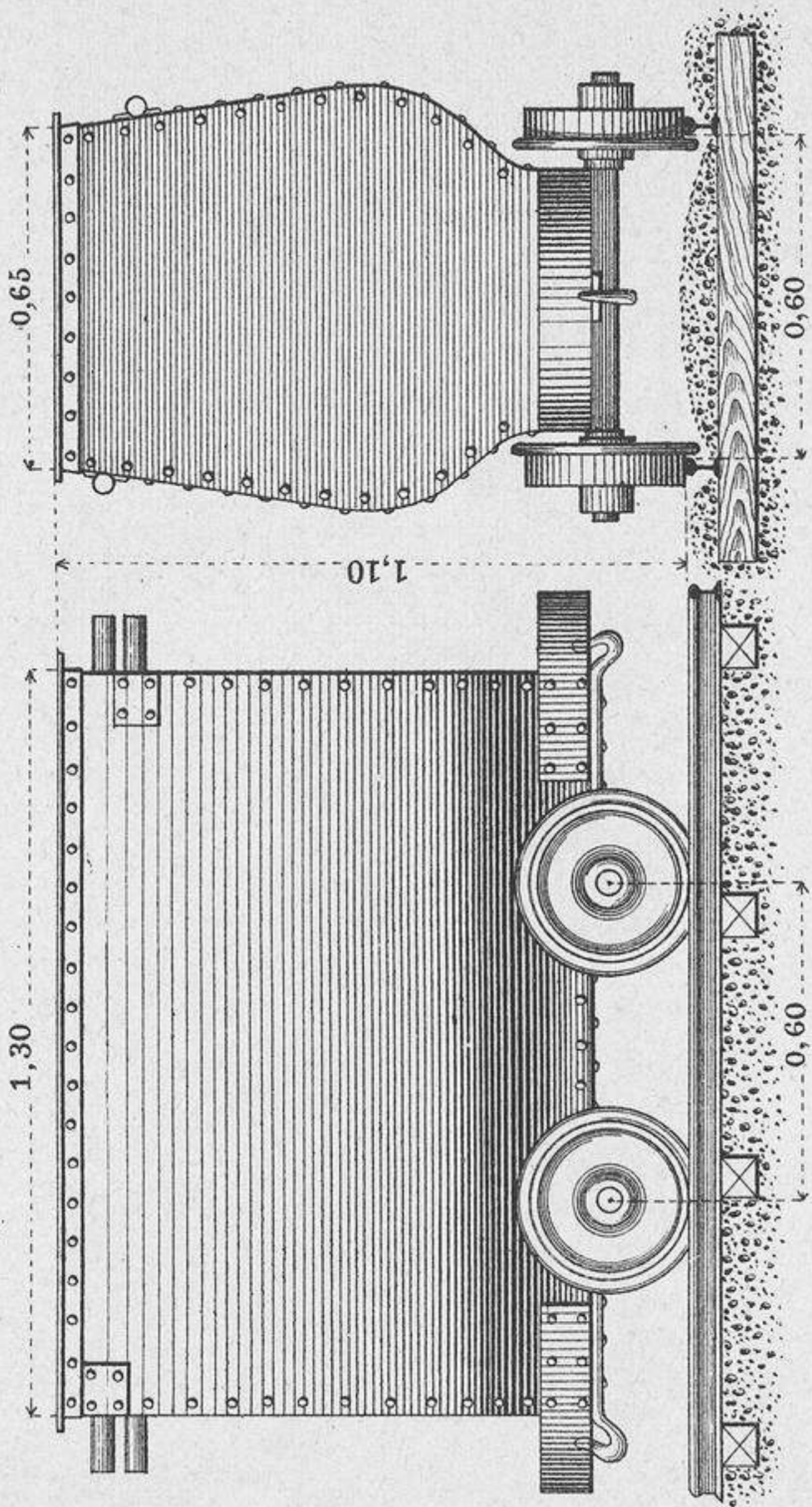

Es. 1/30

FÁBRICA DE MIERES

VAGONES BASCULADORES DE TODAS CAPACIDADES

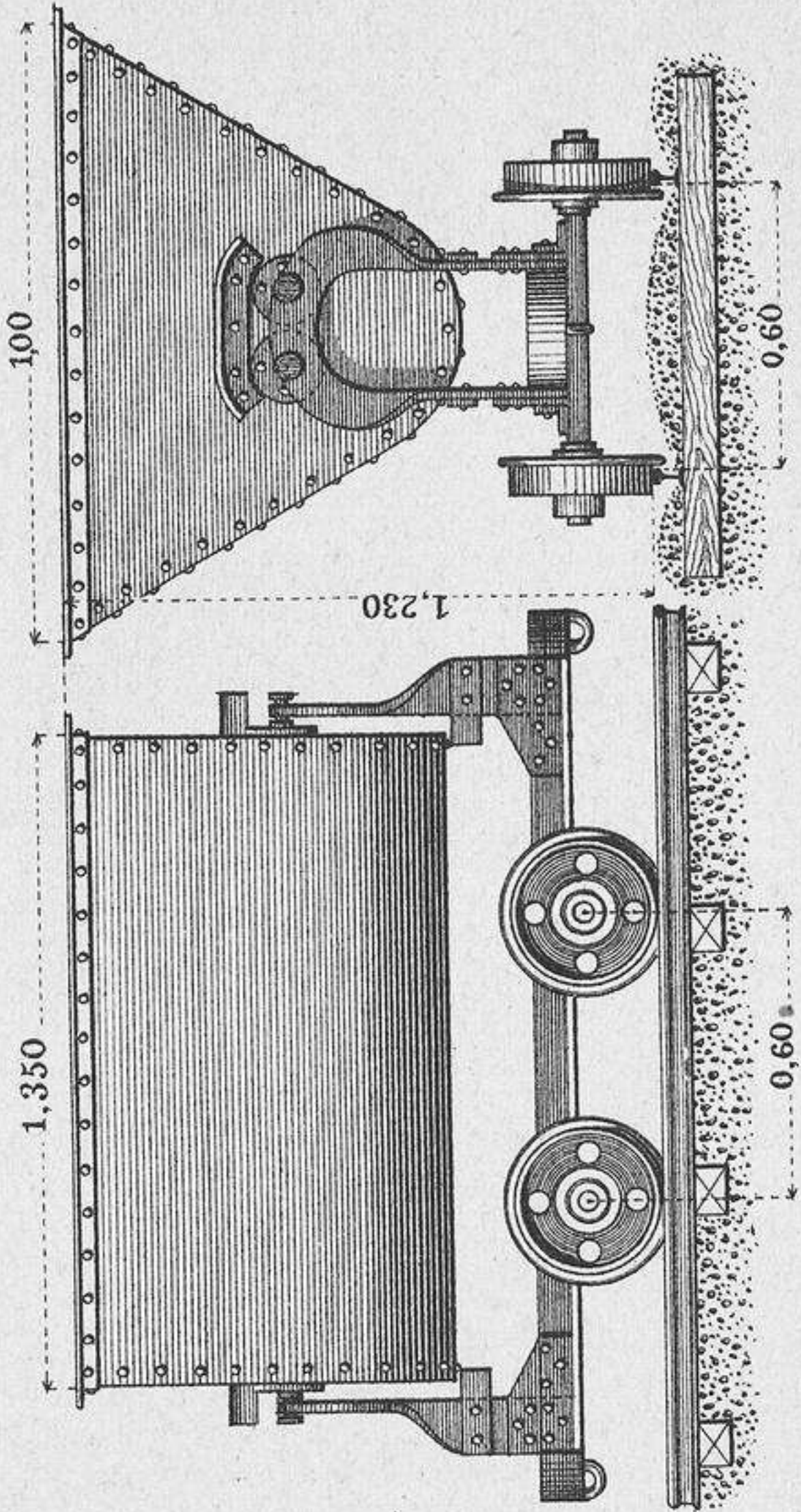

FÁBRICA DE MIERES

VAGONES BASCULADORES DE TODAS CAPACIDADES

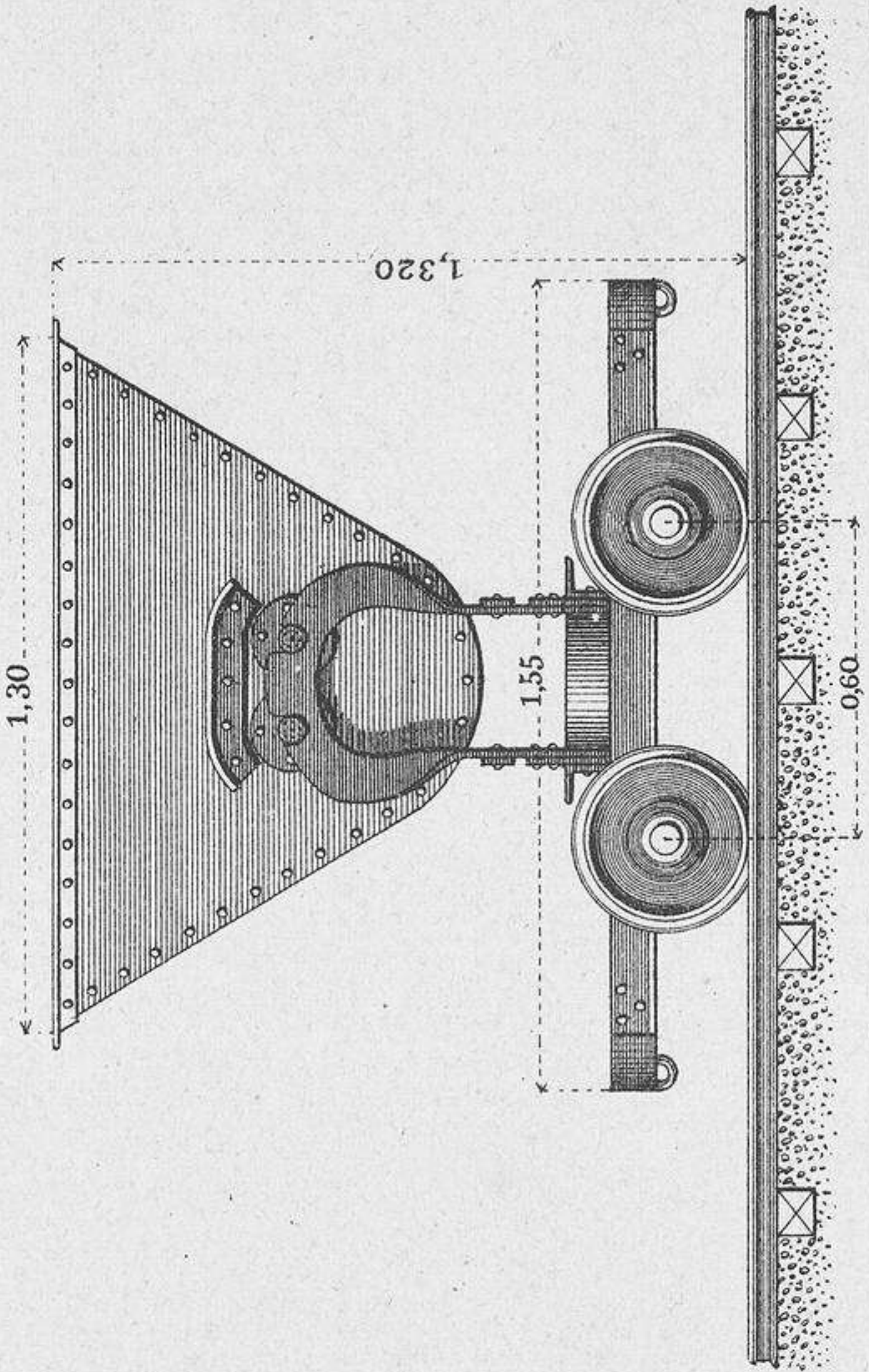

FÁBRICA DE MIERES

VAGÓN BASCULADOR

Es 1/30

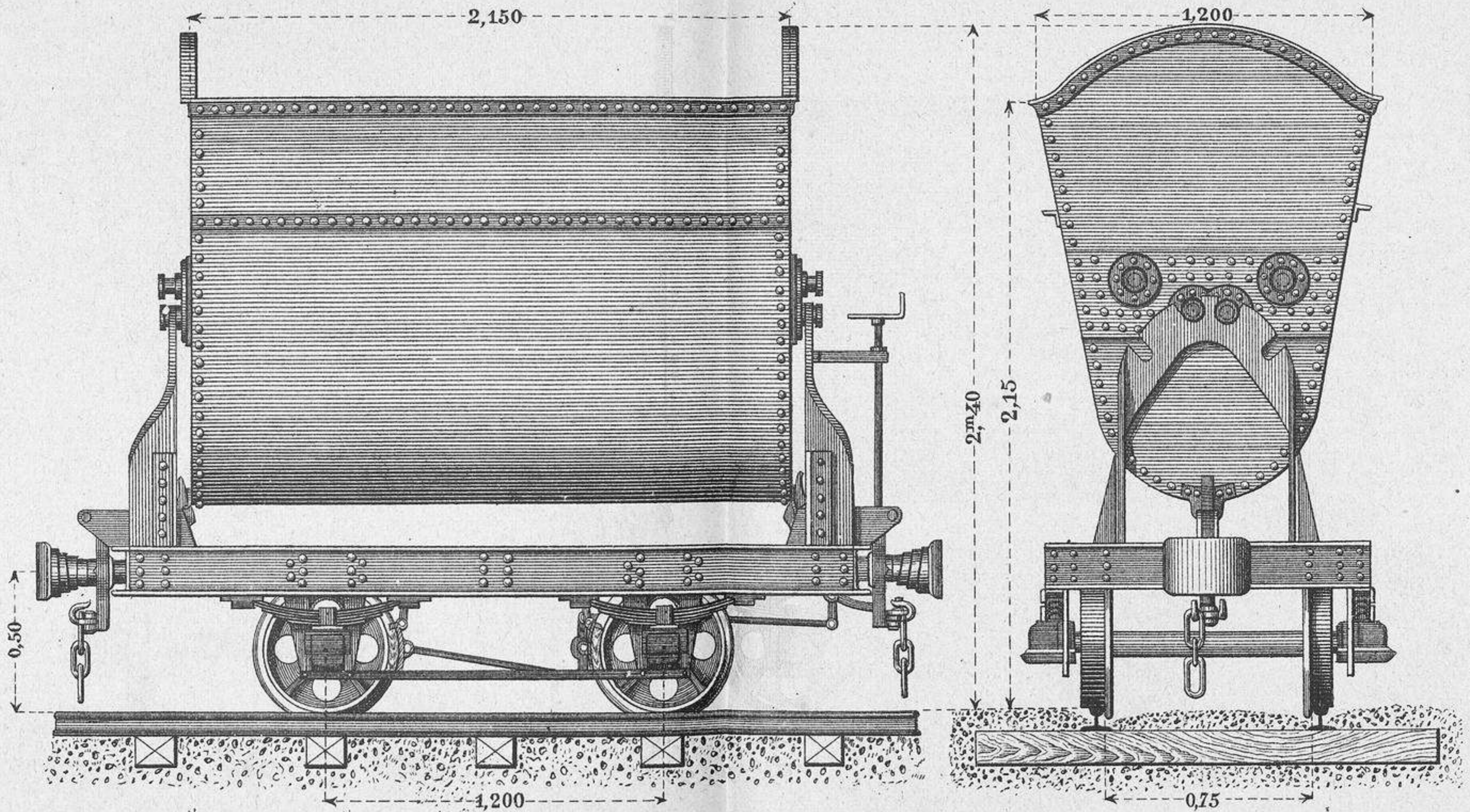

FÁBRICA DE MIERES

VAGÓN BORDE

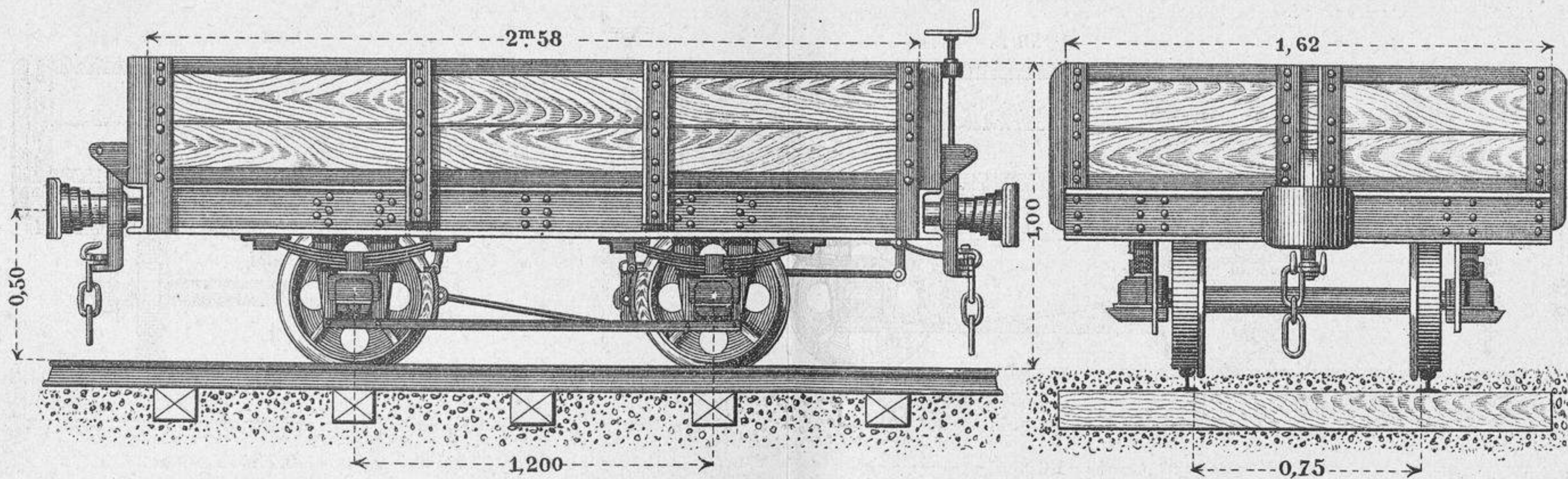

FÁBRICA DE MIERES

VAGÓN DE DESCARGAR POR EL FONDO

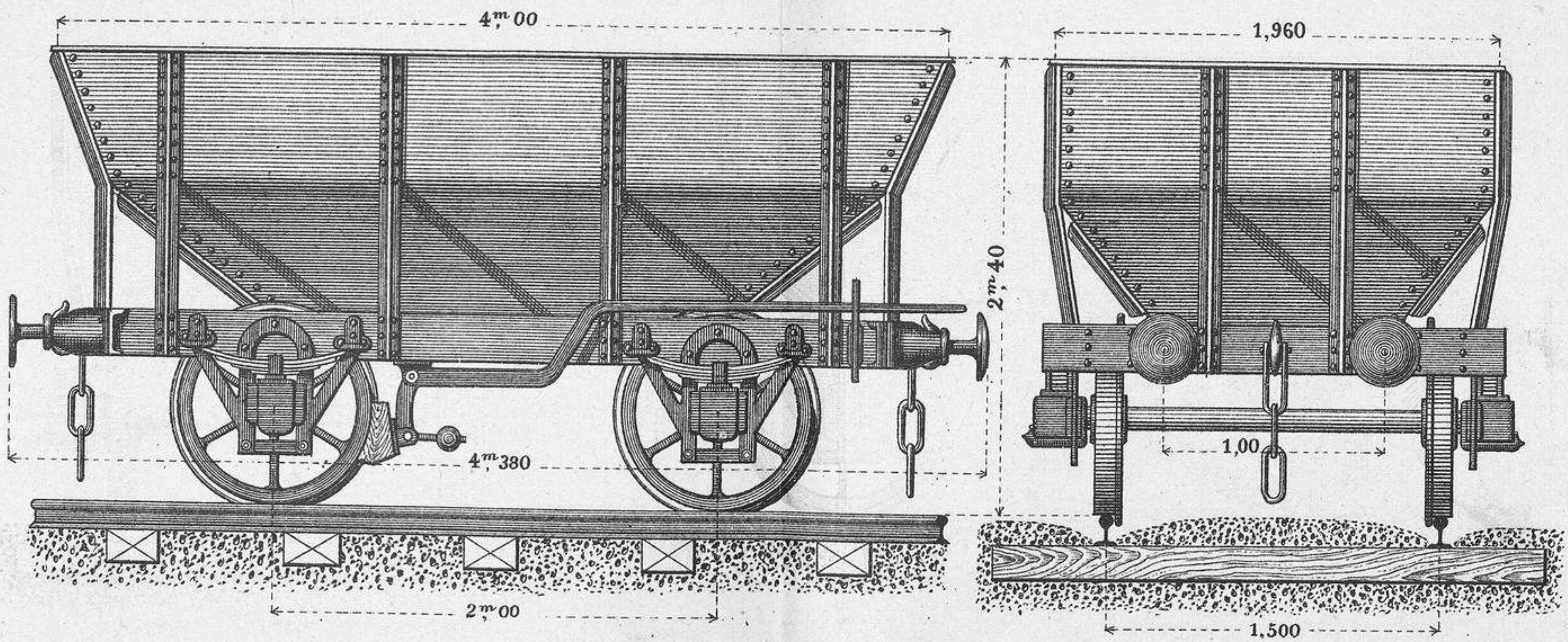



TIPOLITOGRAFÍA
DE

RAMÓN MOLINAS

Plaza Tetuán, 50

BARCELONA