

BIBLIOTECA PUBLICA MURCIA
Dep. 1-
I-31

R. 10. 101

Dep. 1-I-31

LAMINA 1

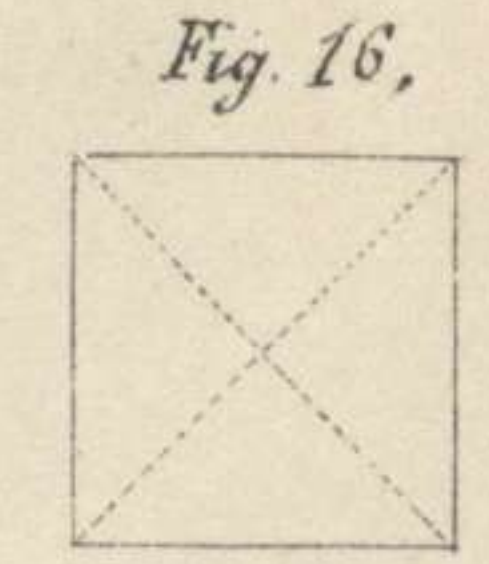
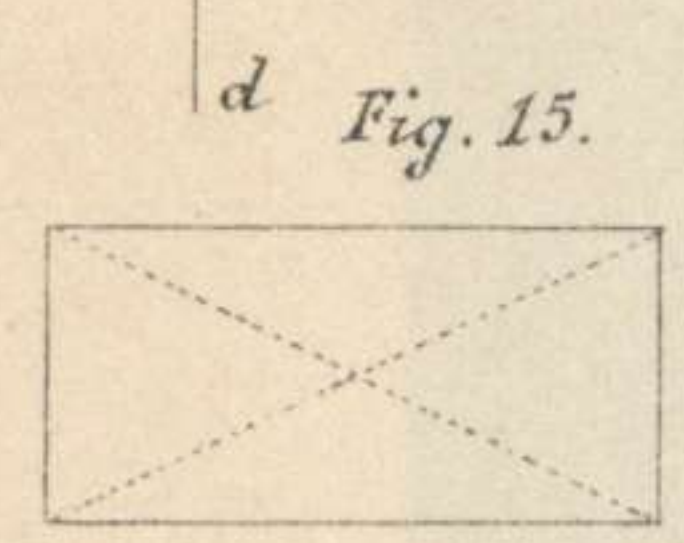
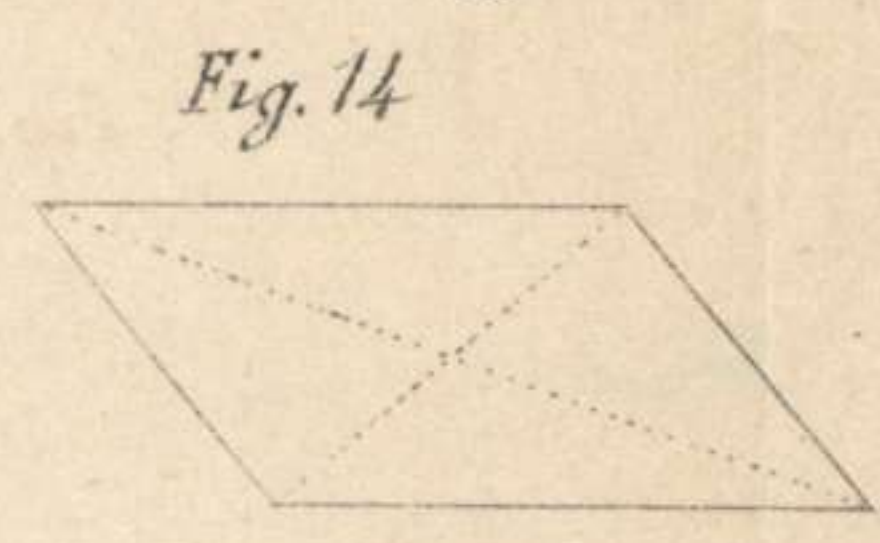
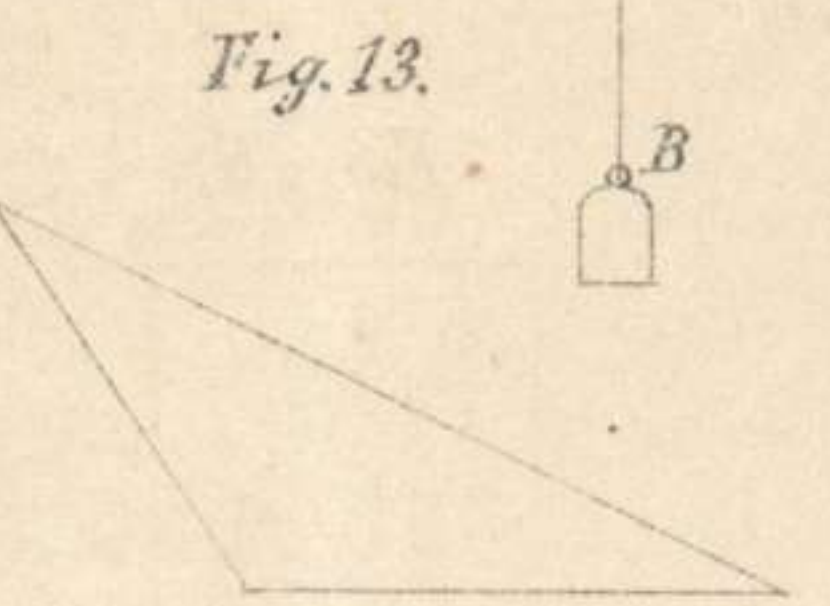
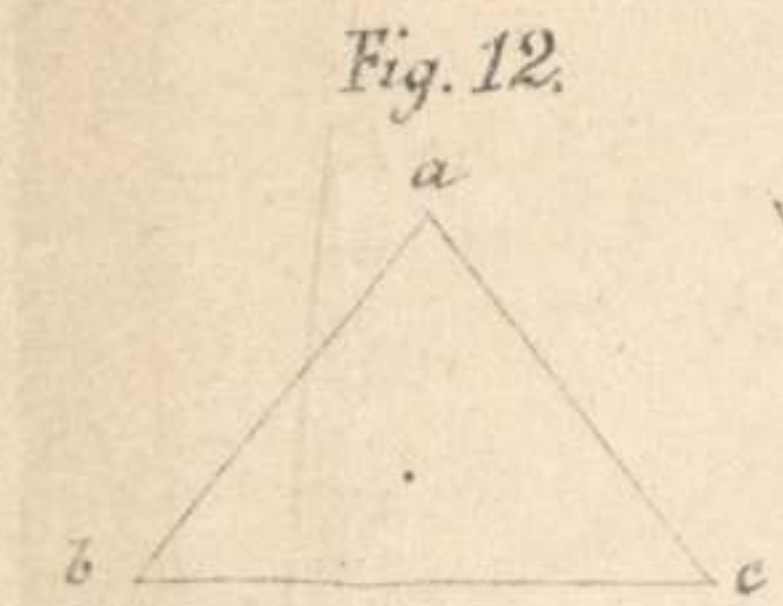
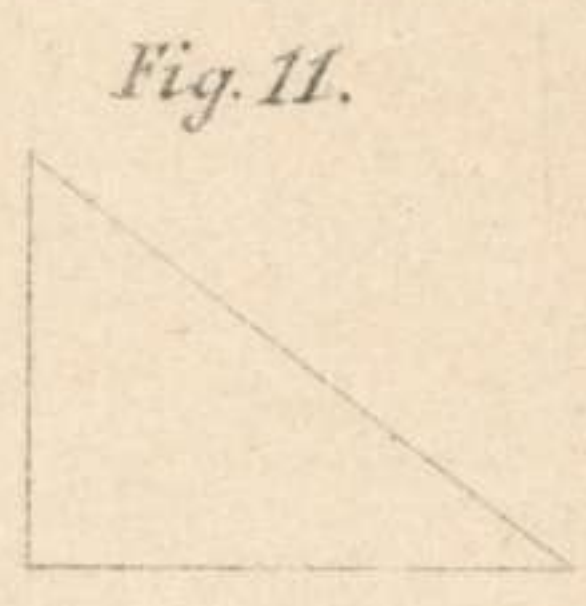
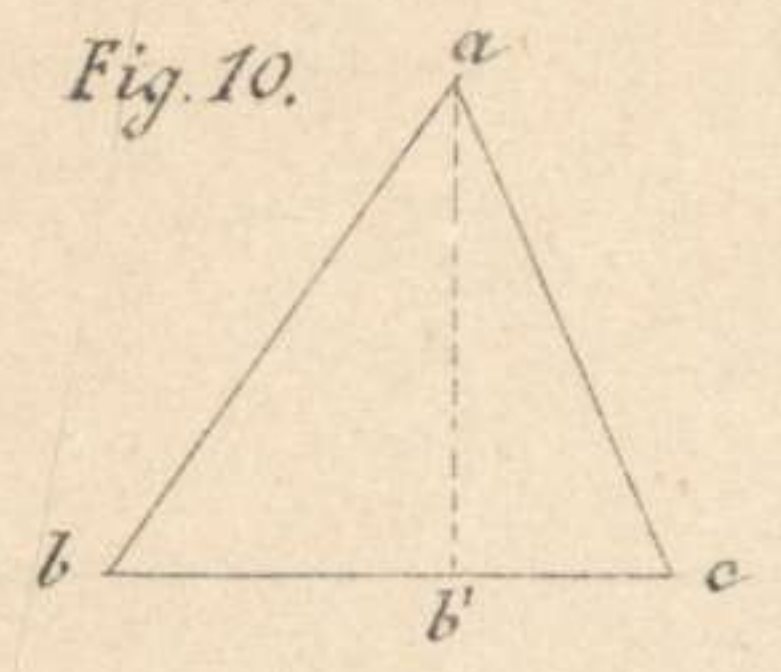
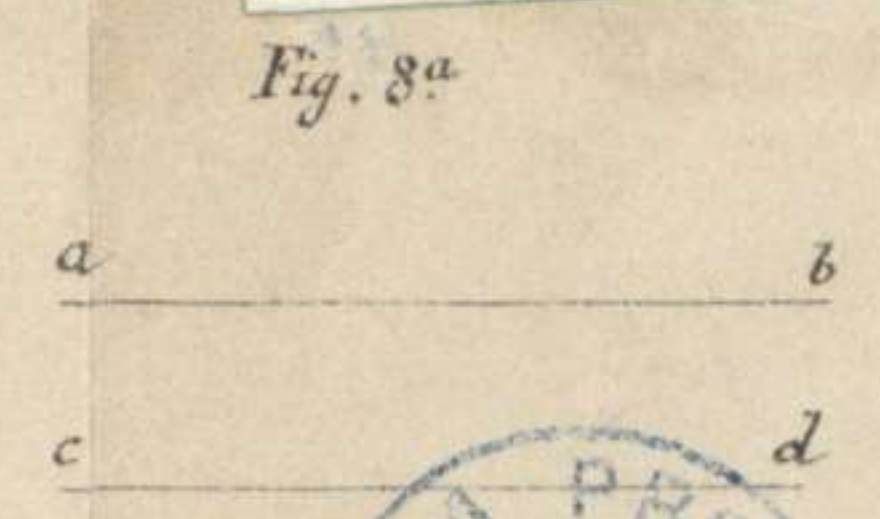
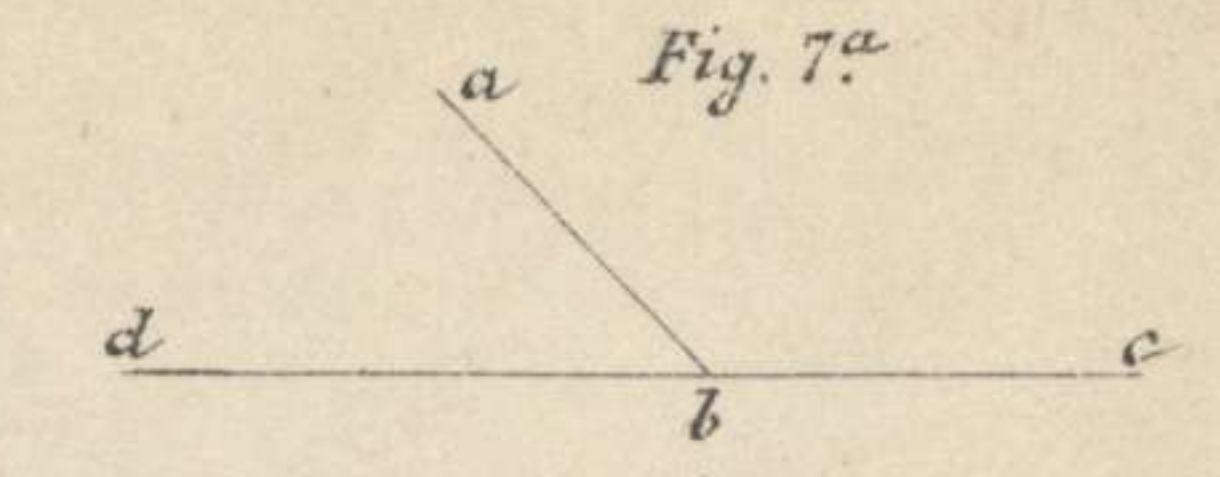
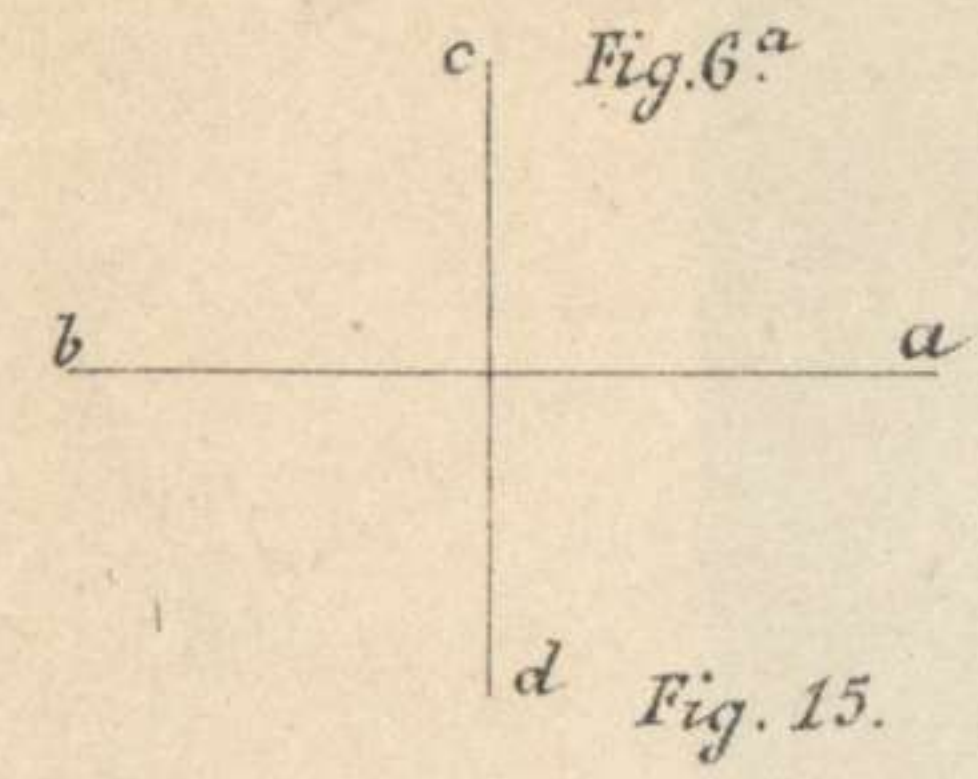
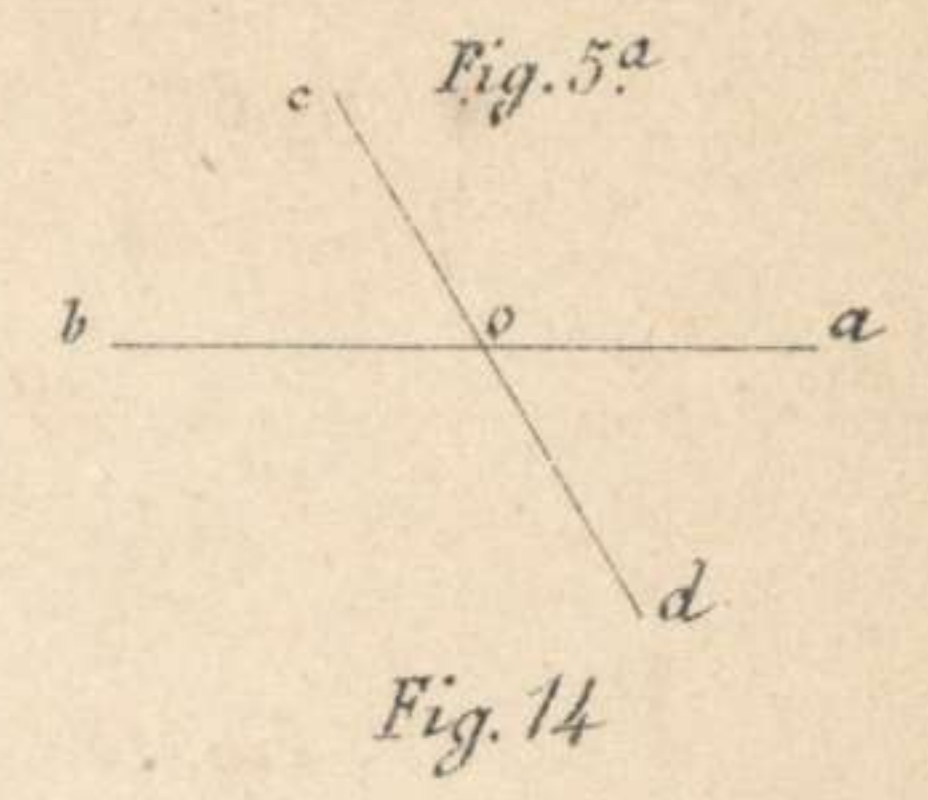
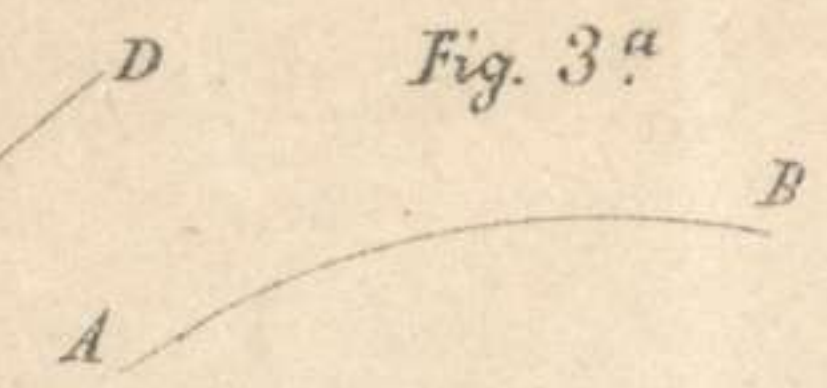
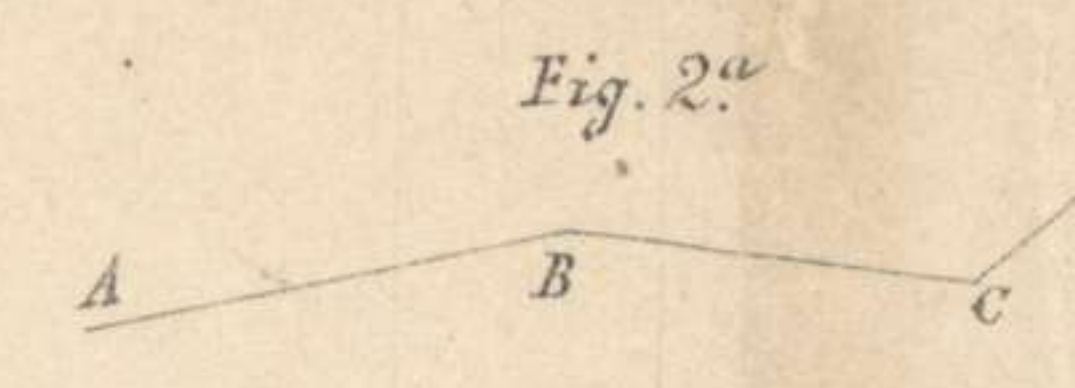
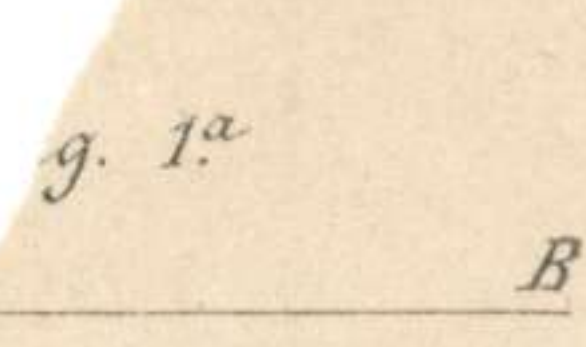

Fig. 17.

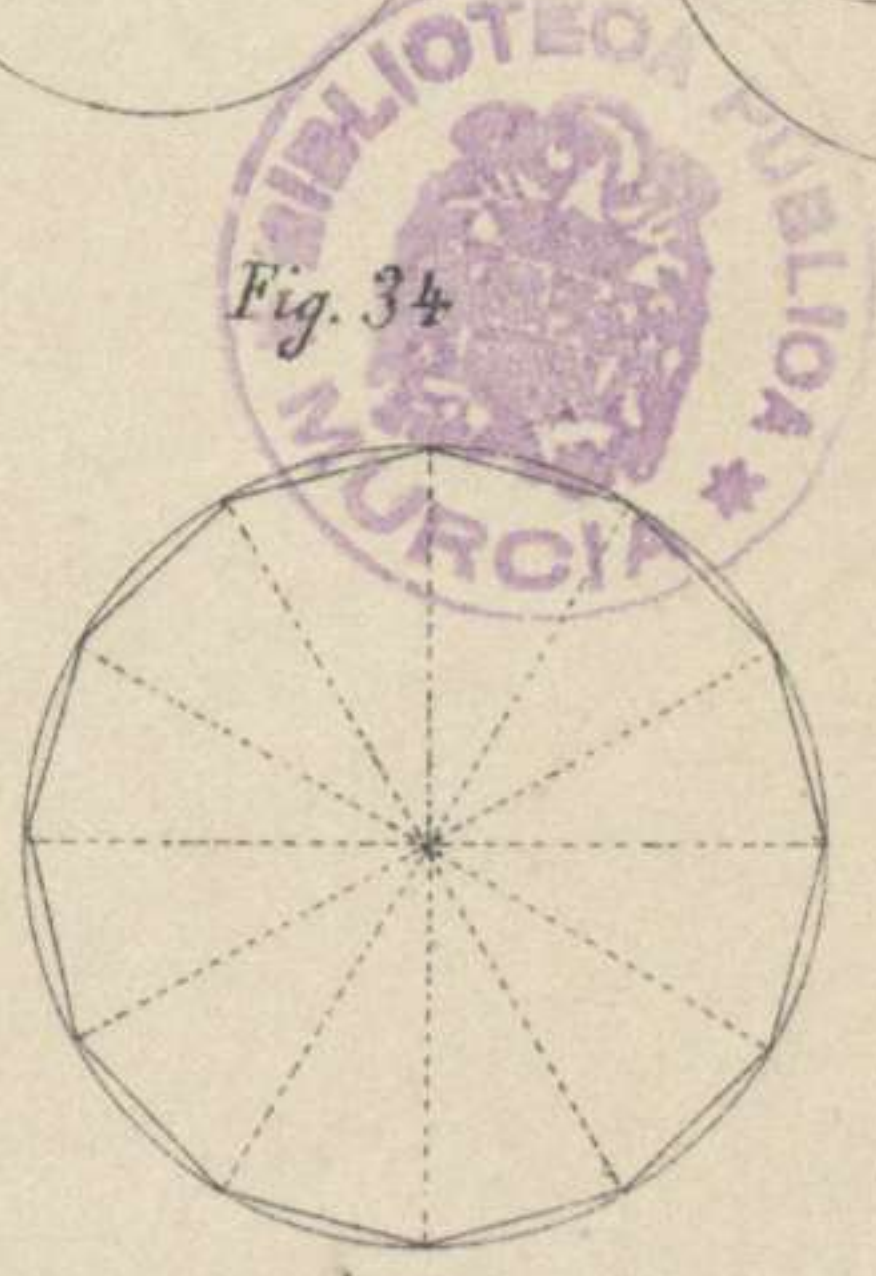
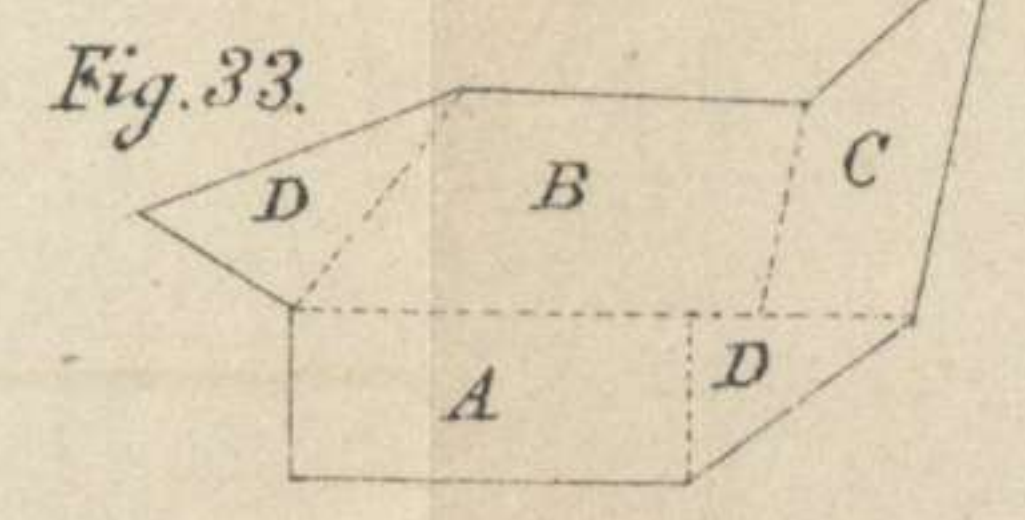
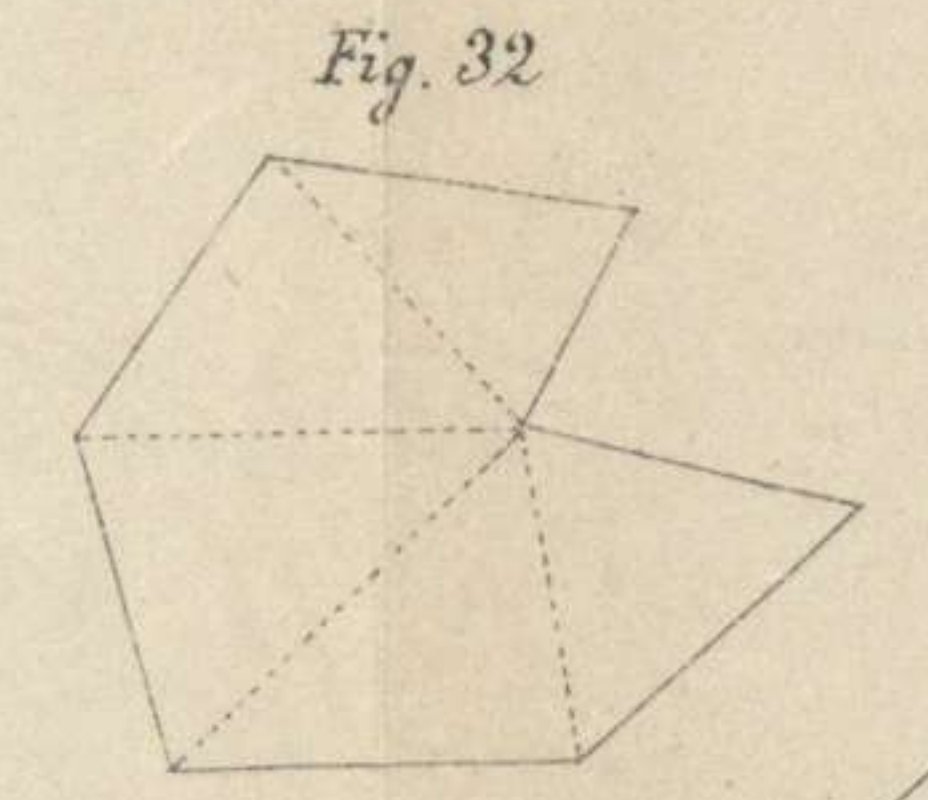
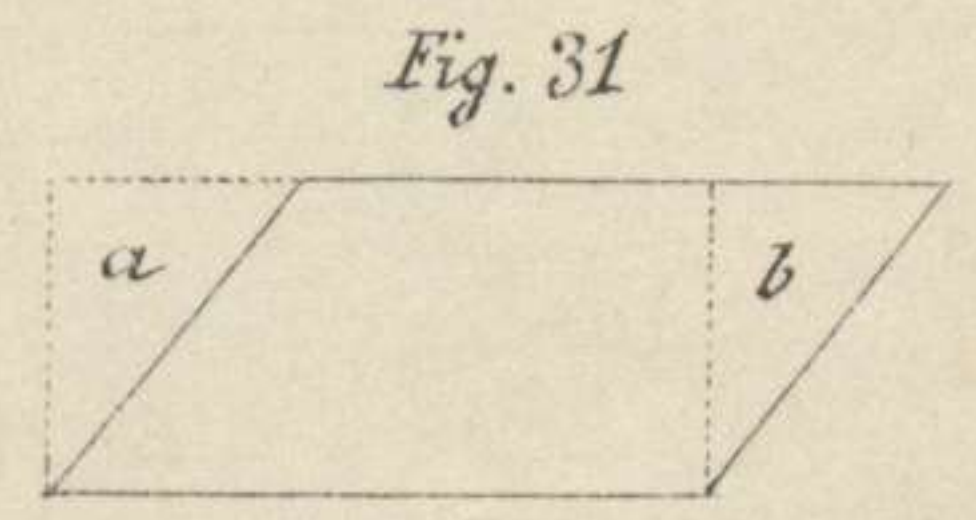
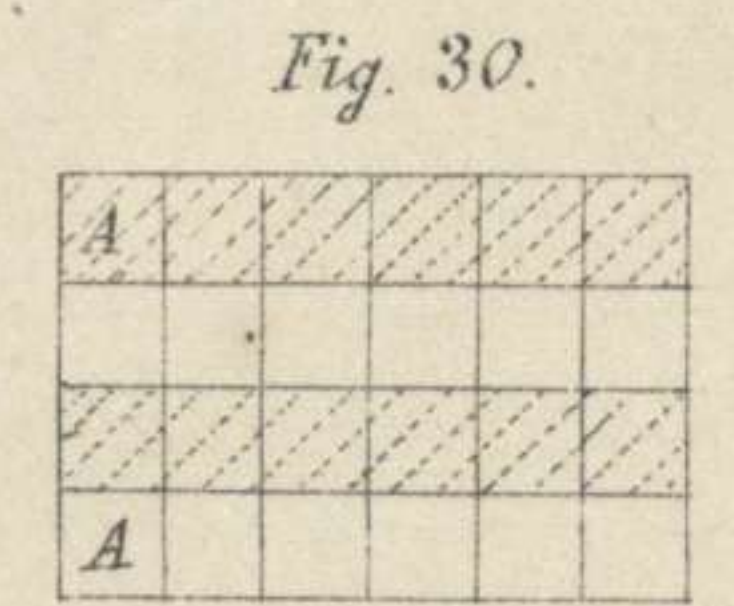
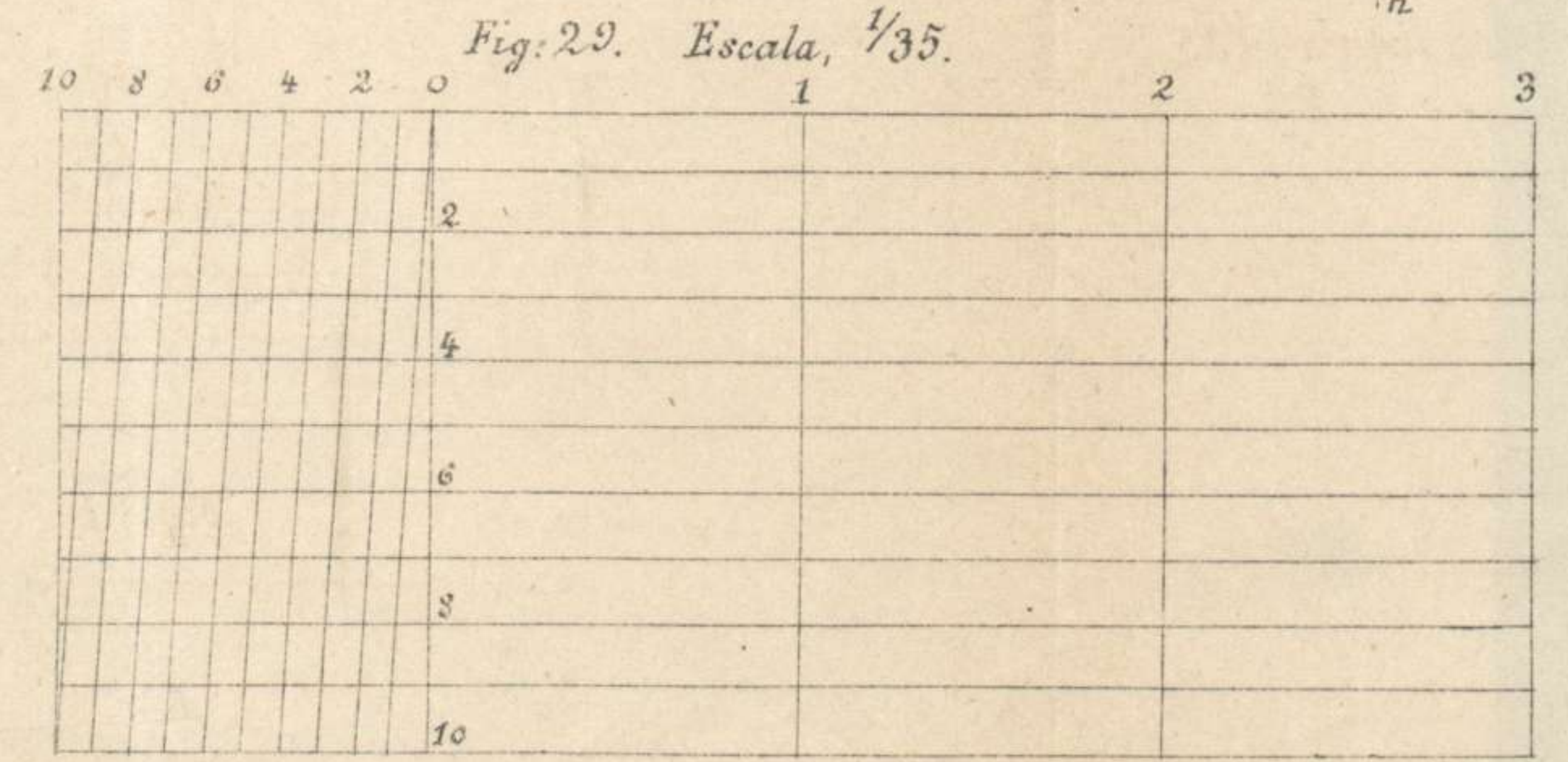
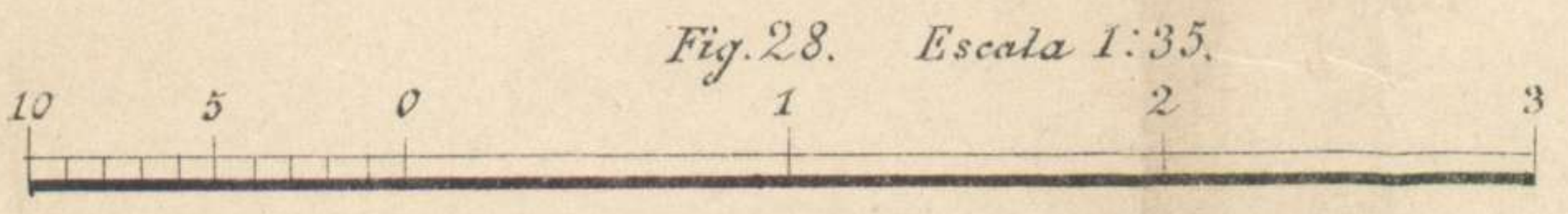
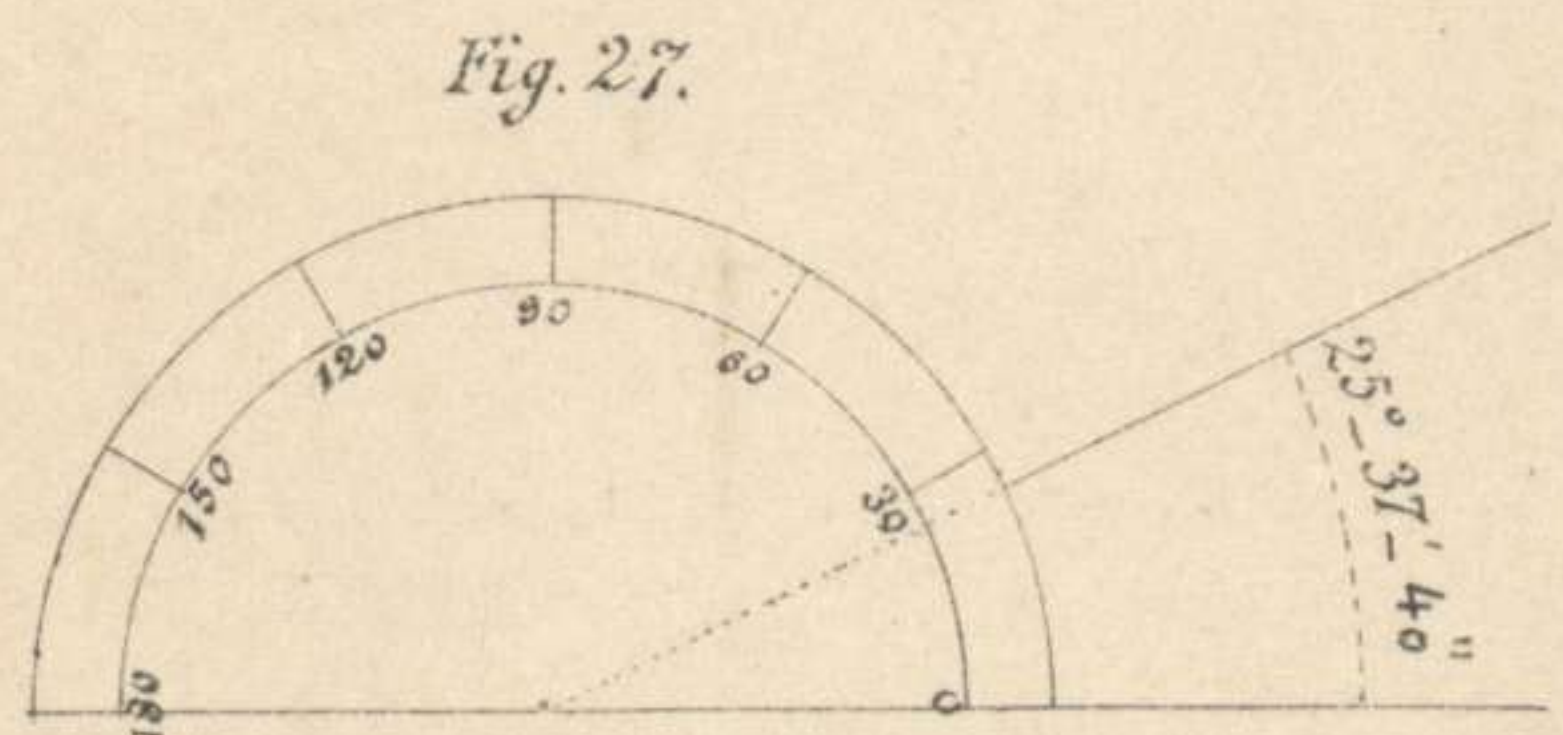
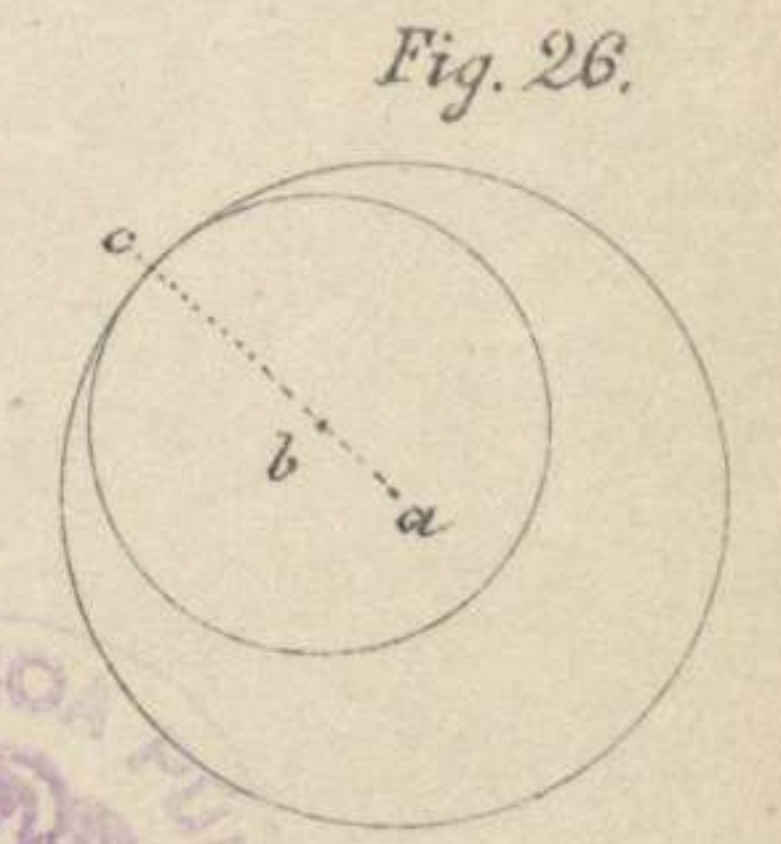
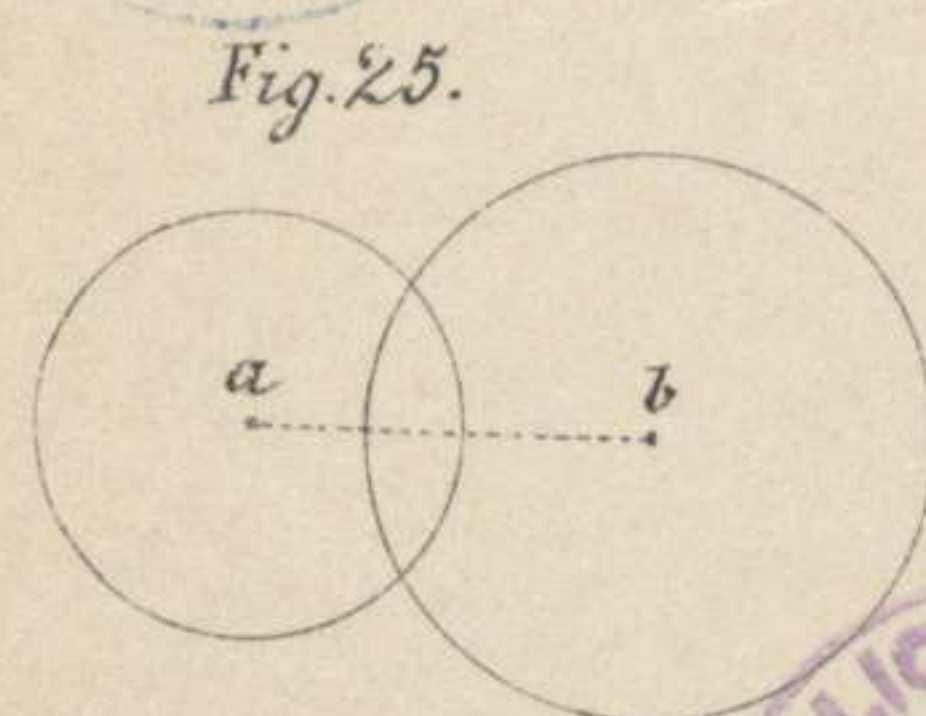
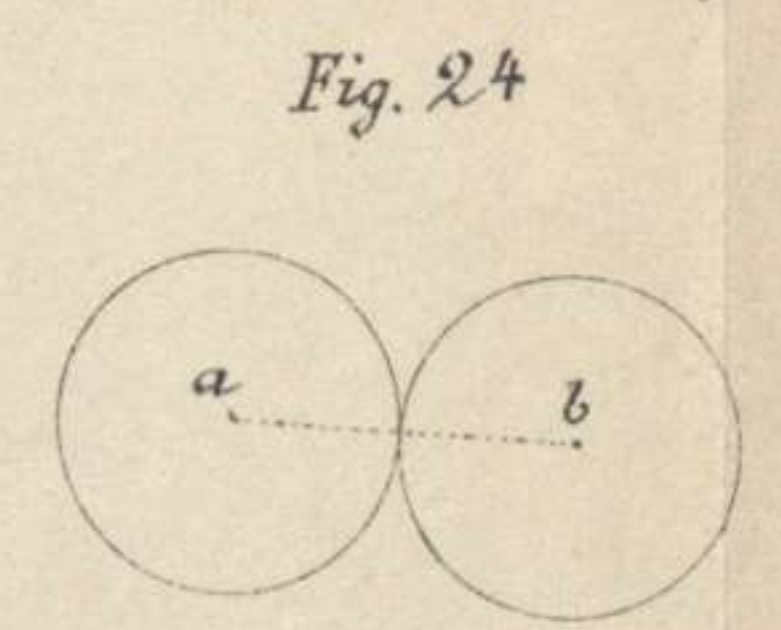
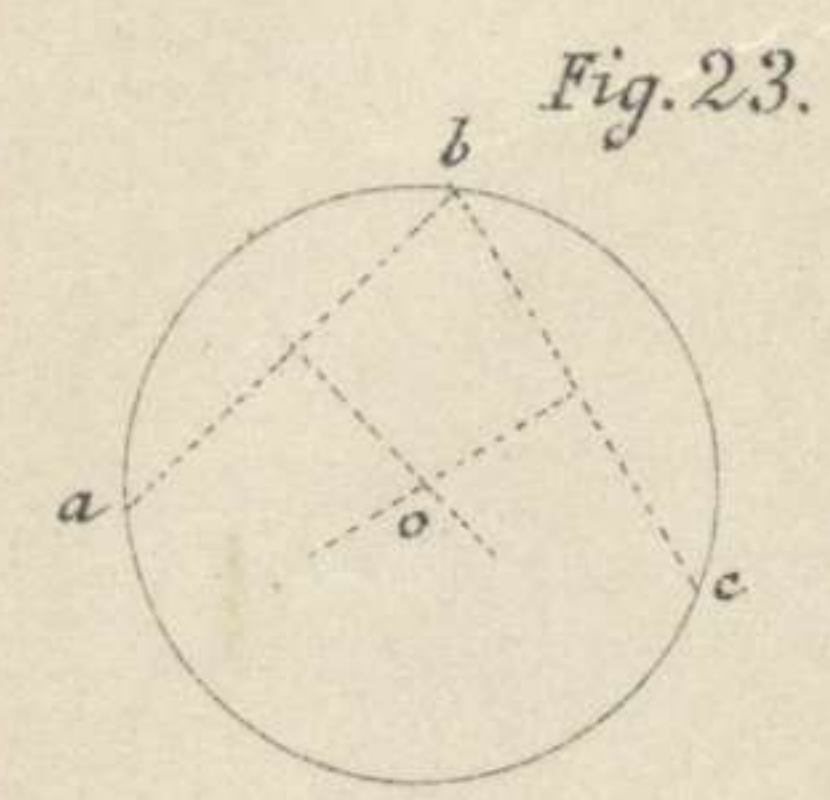
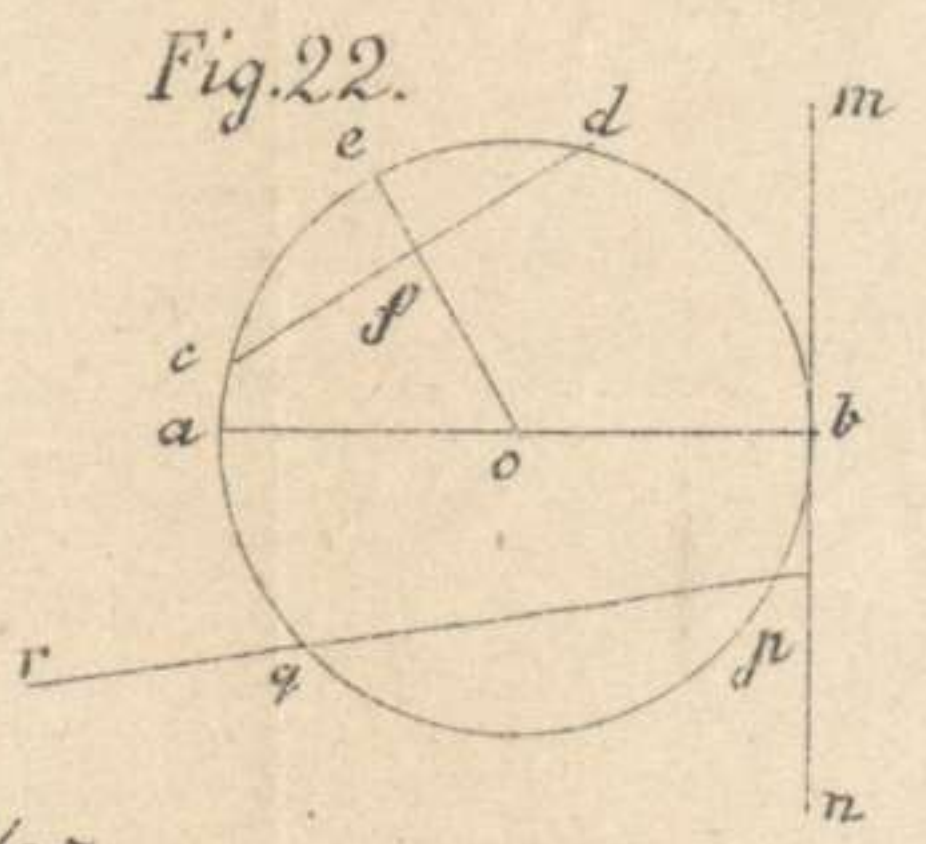
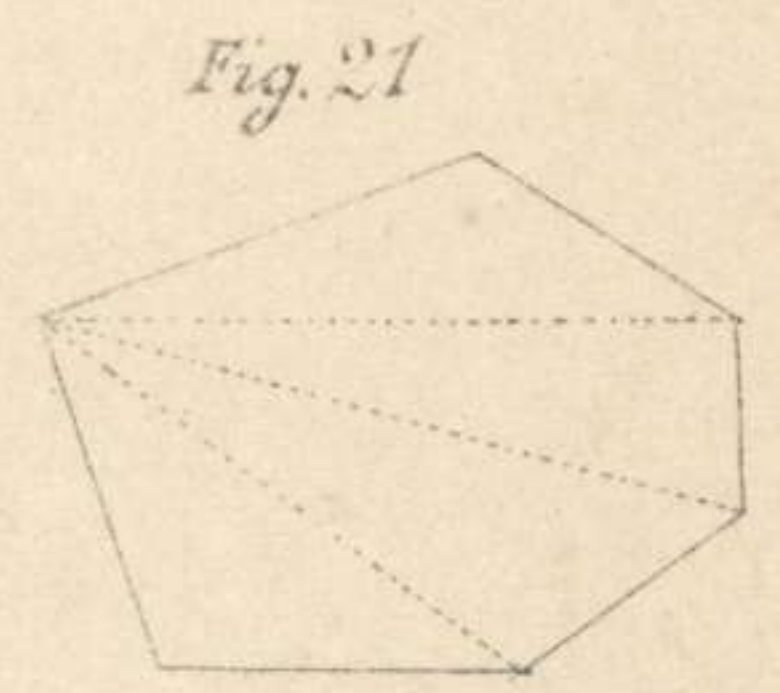
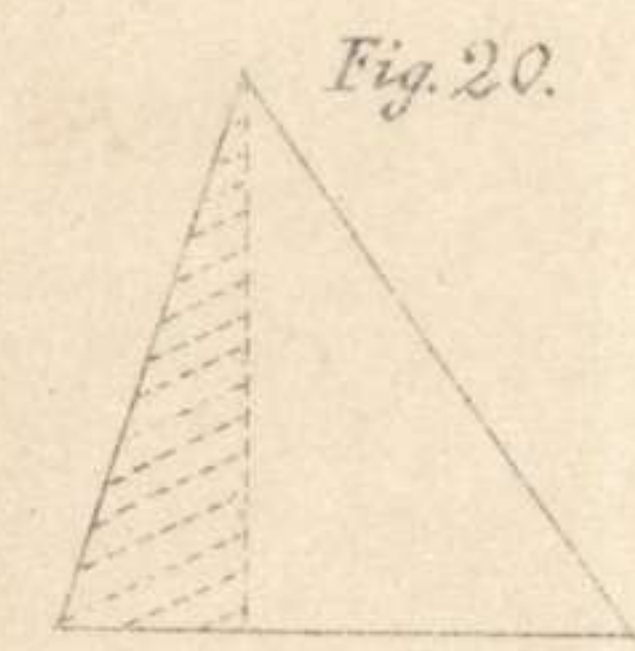
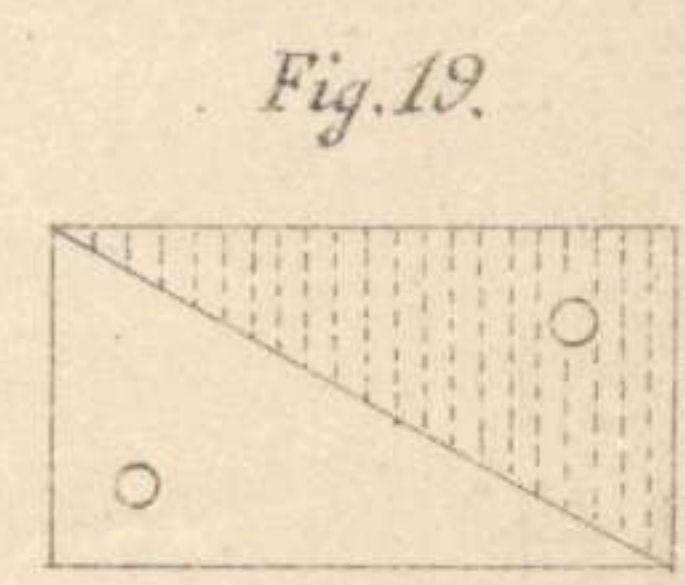
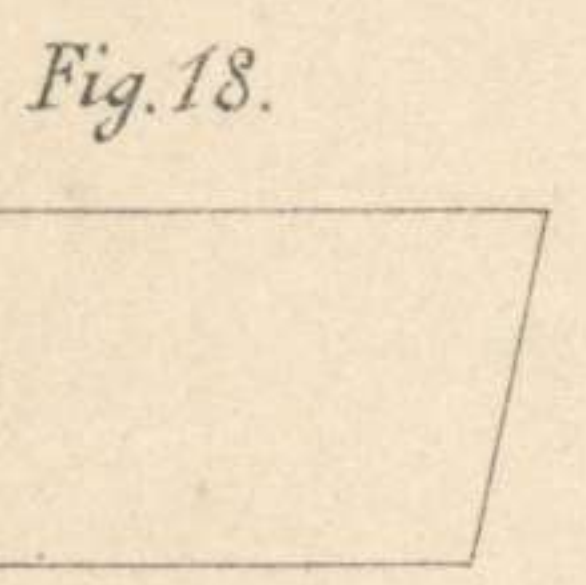
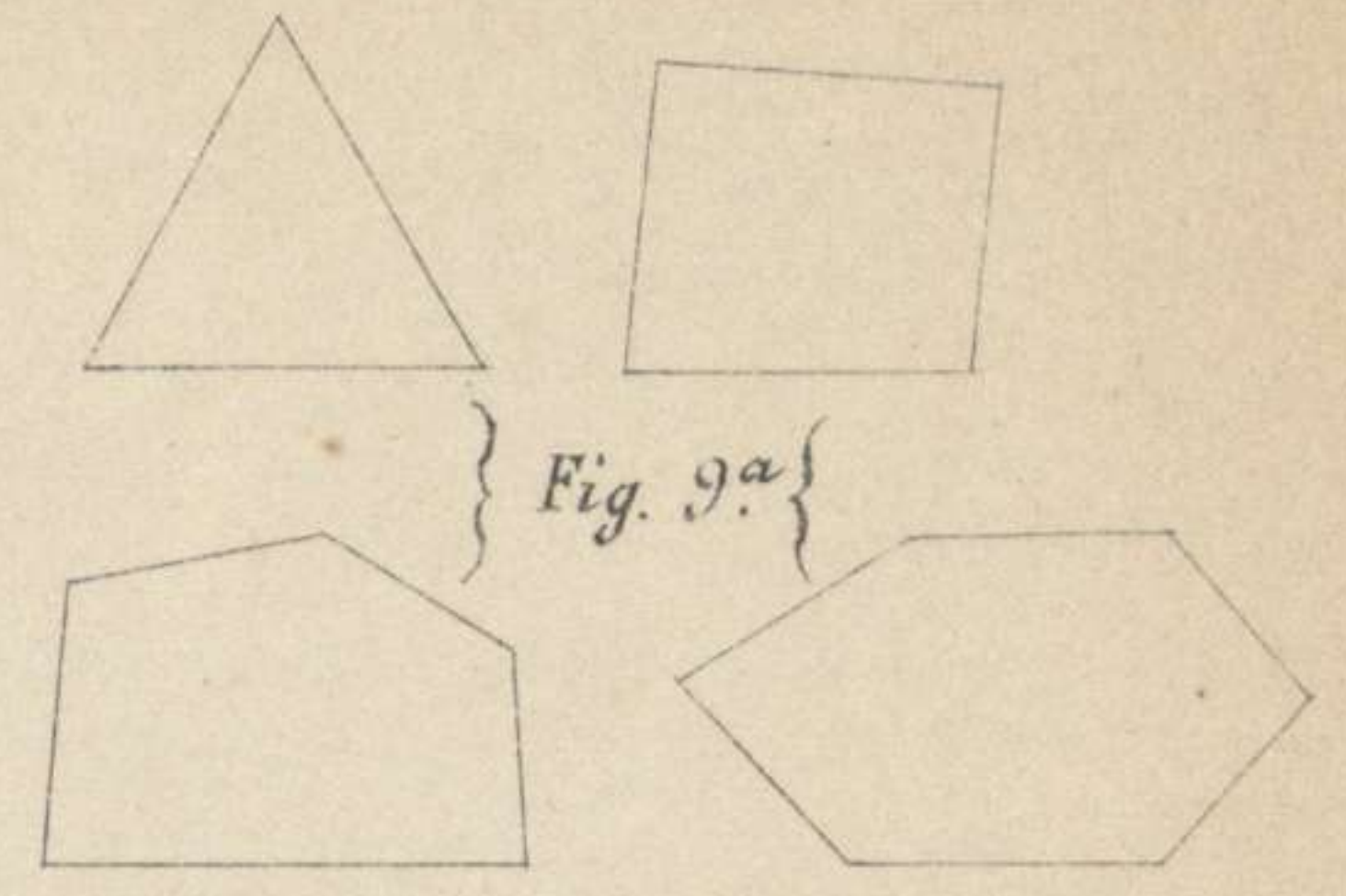
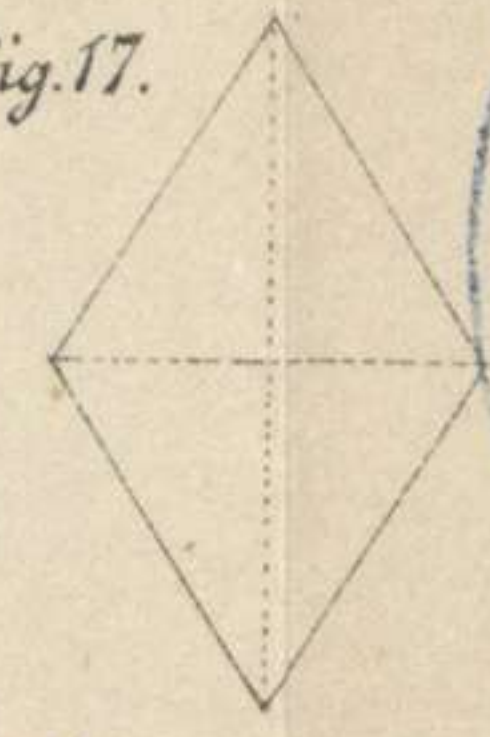

Fig. 34

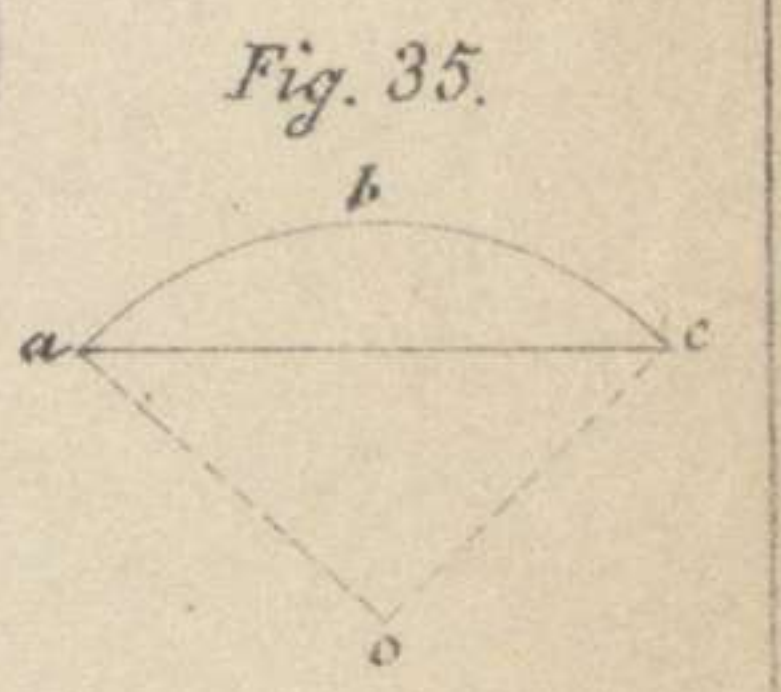
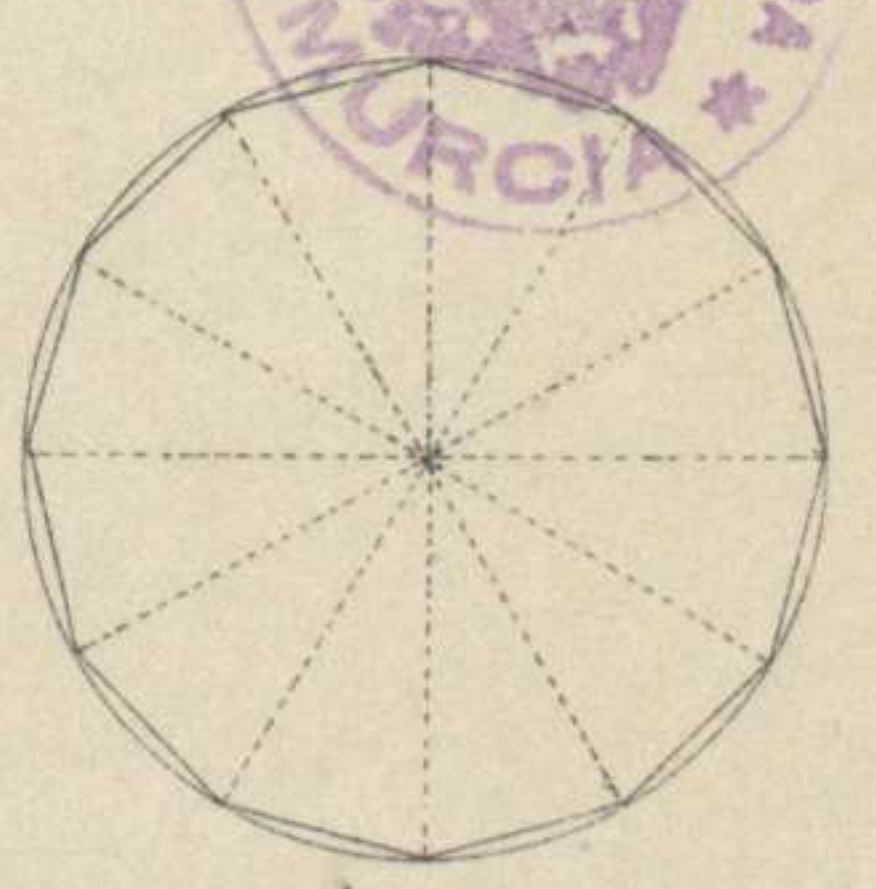

Fig. 36

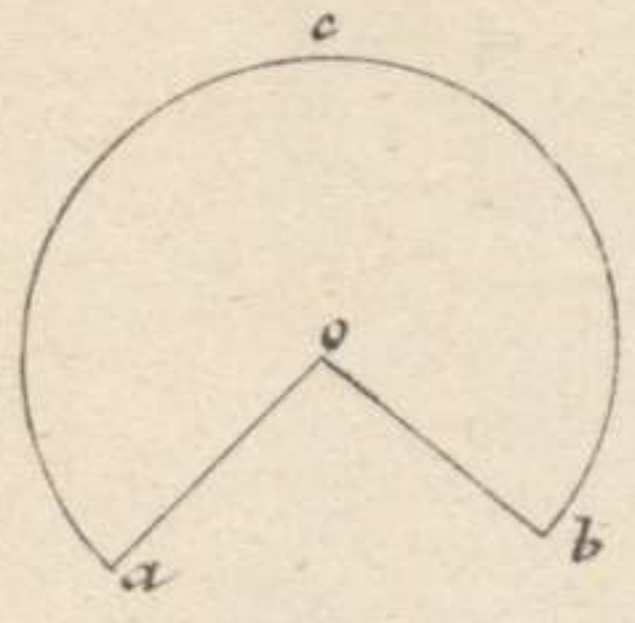

Fig. 37.

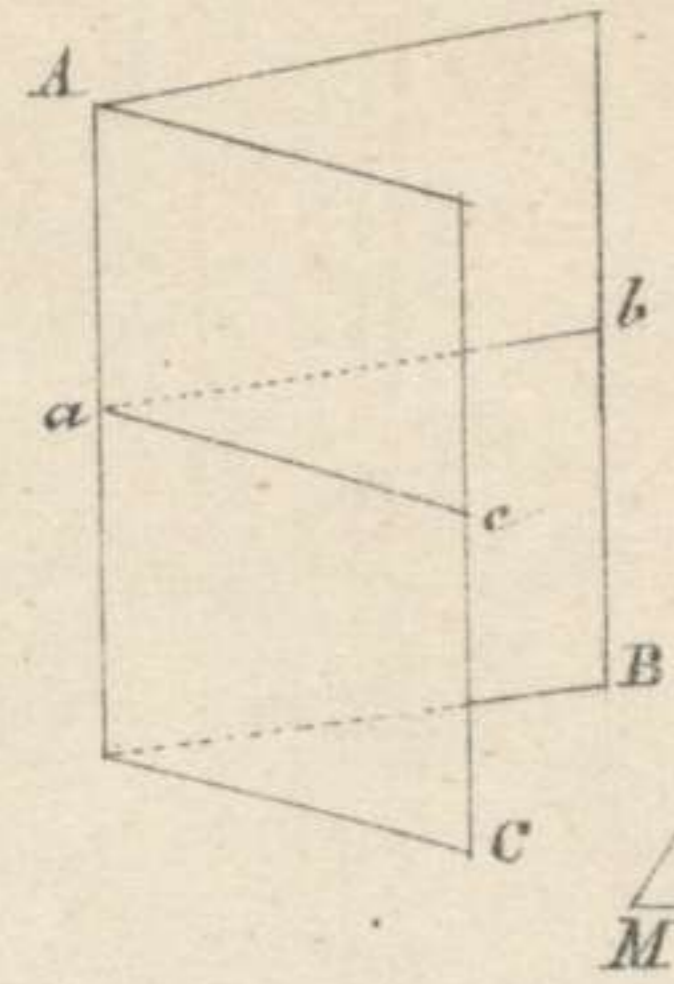

Fig. 38.

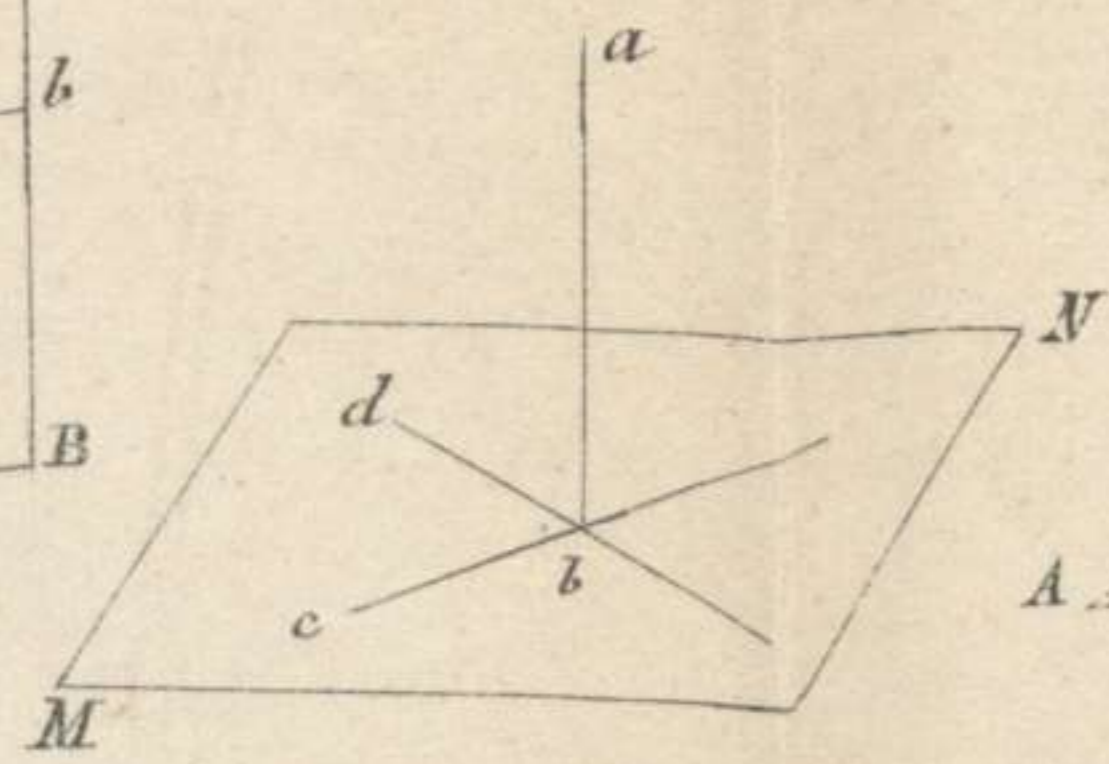

Fig. 39.

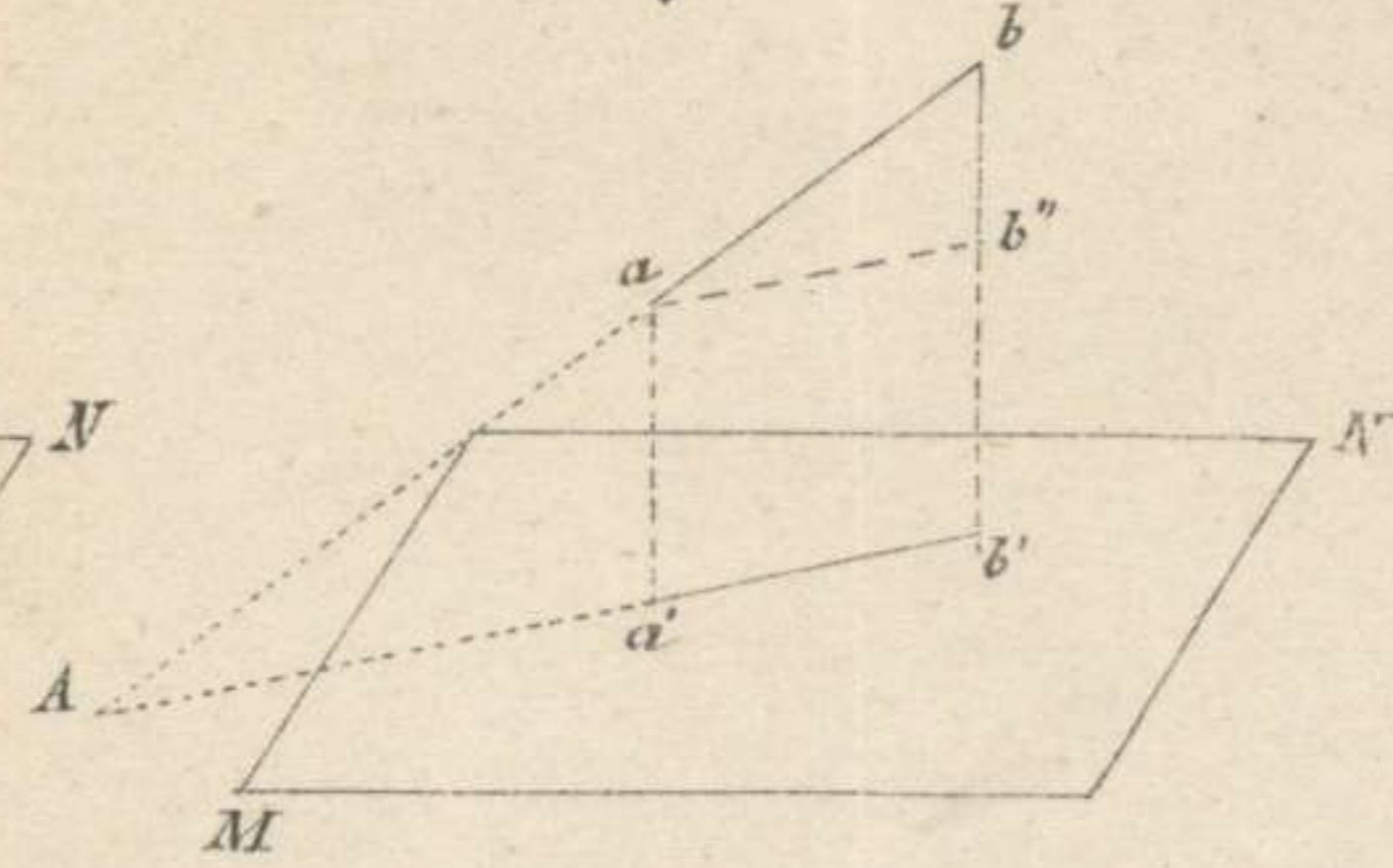

Fig. 39.

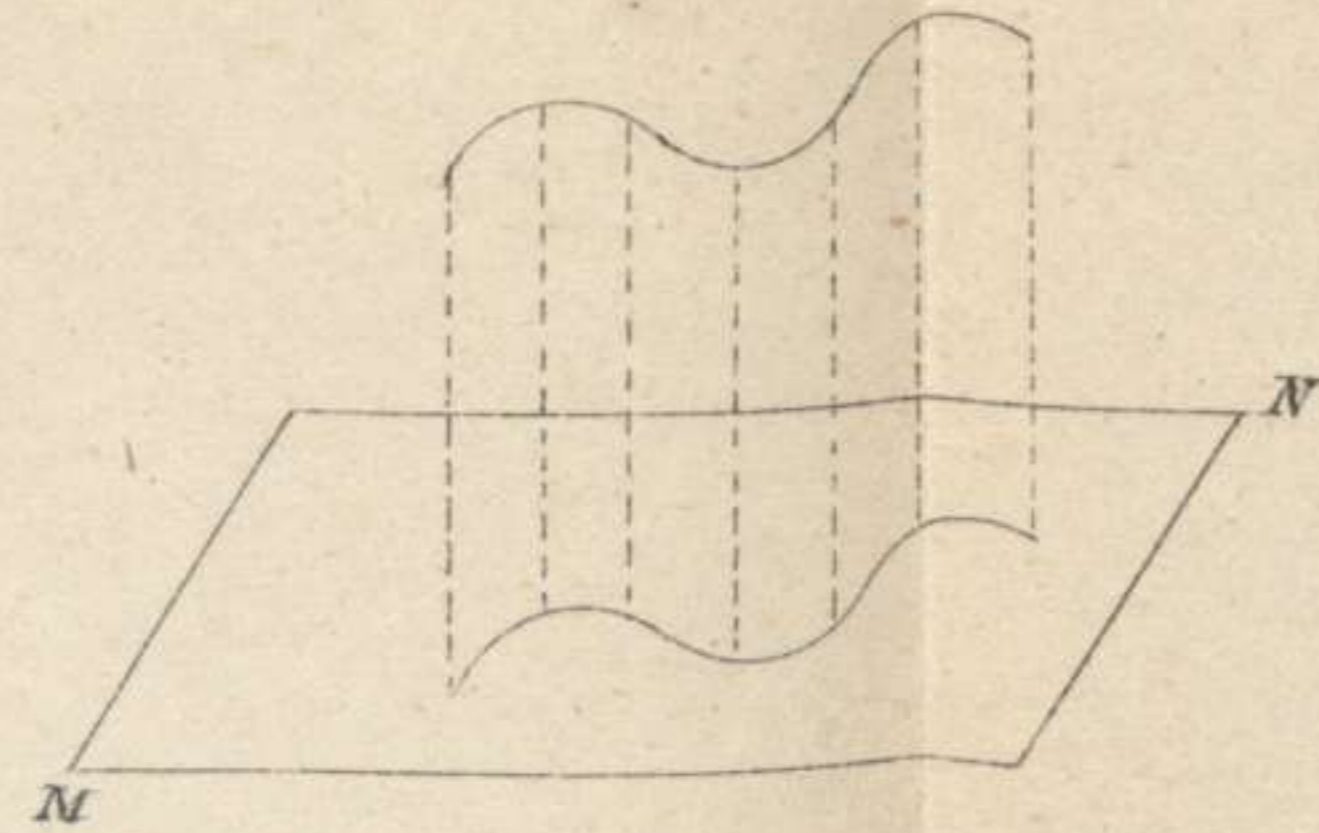

Fig. 40.

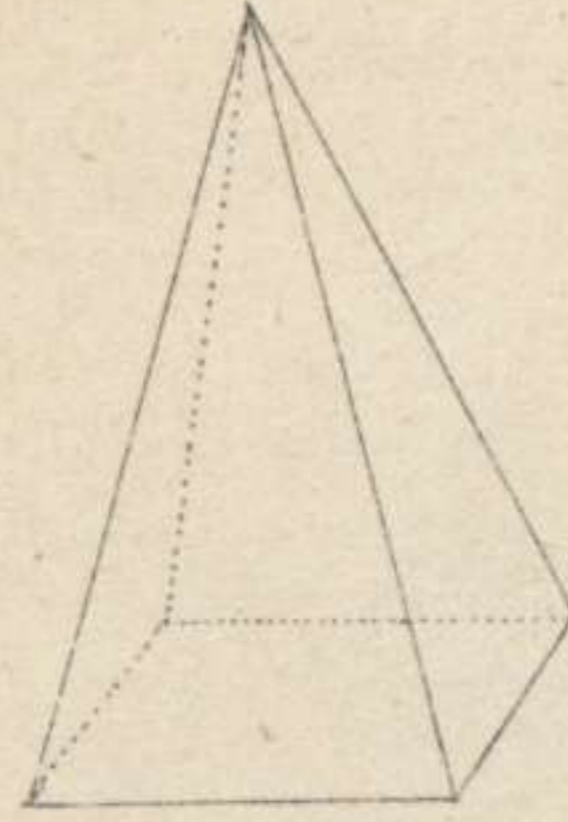

Fig. 41

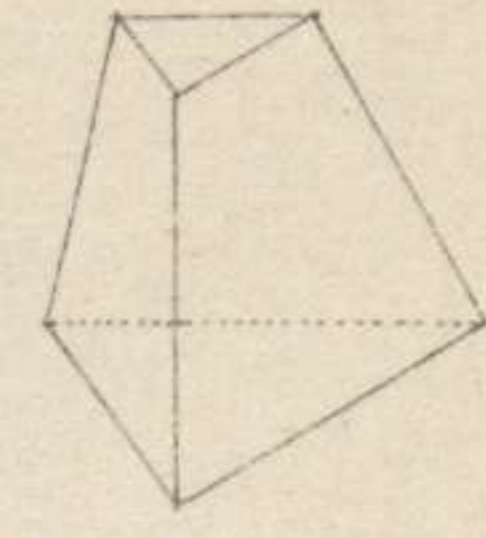

Fig. 42.

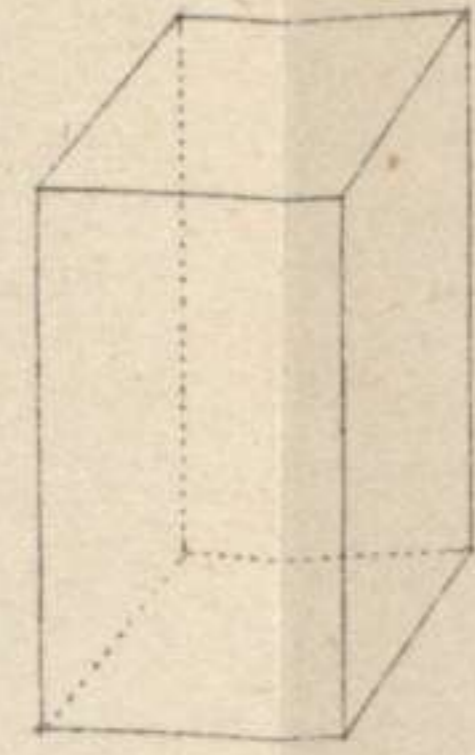

Fig. 43.

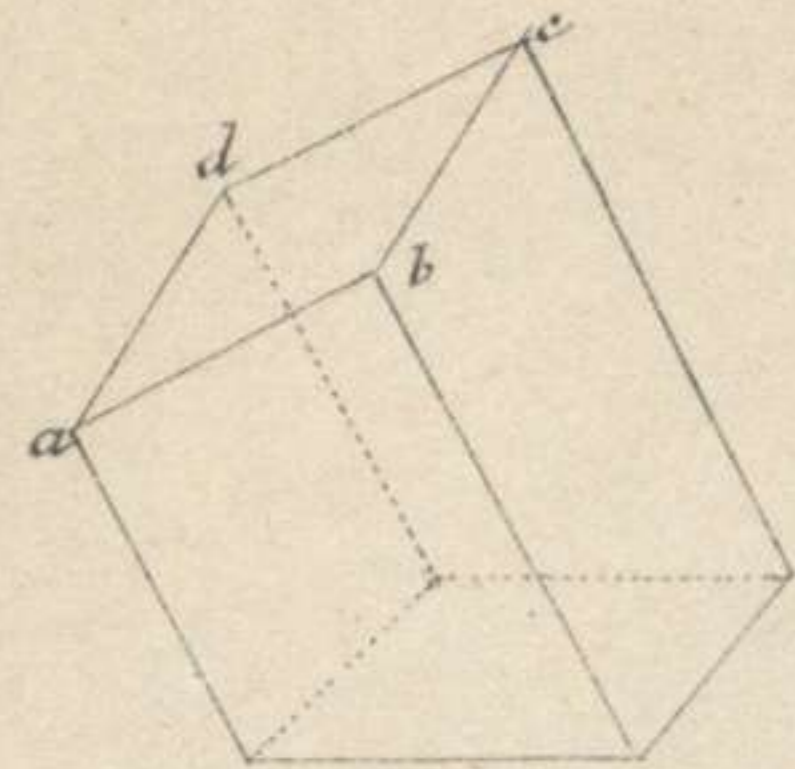

Fig. 44.

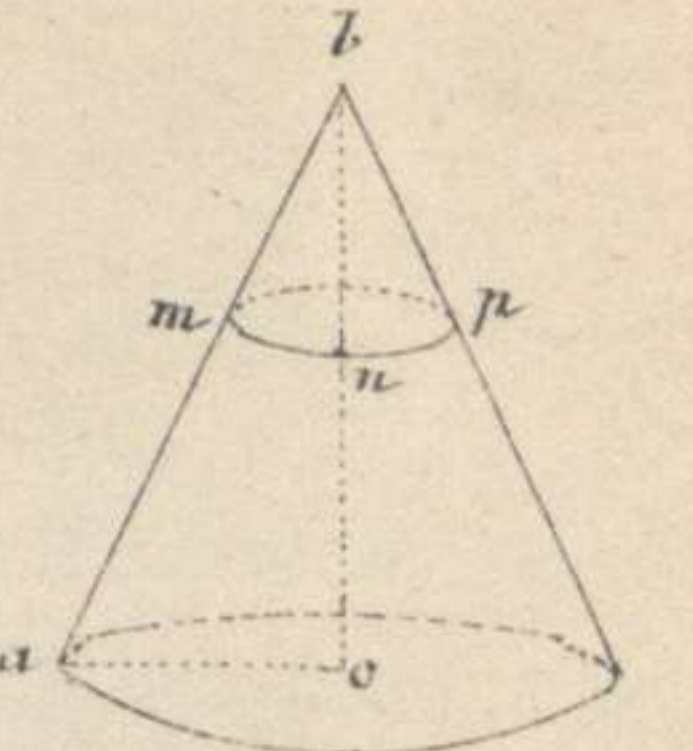

Fig. 46.

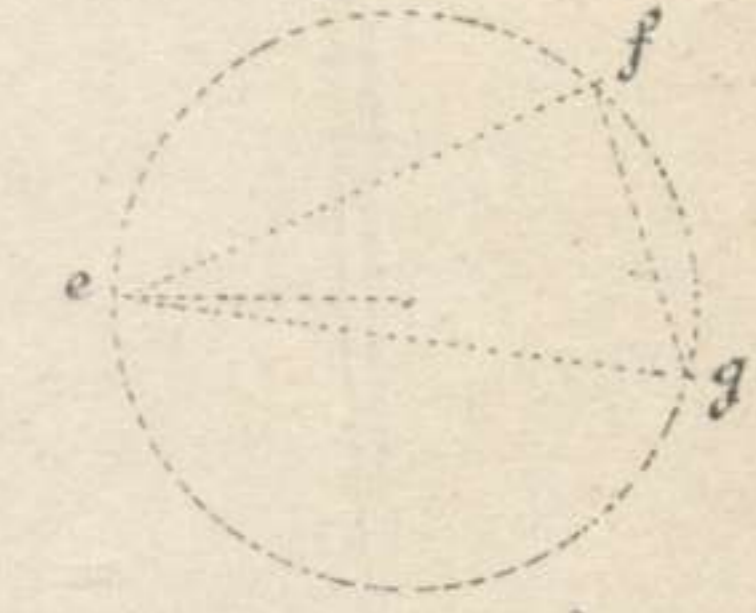
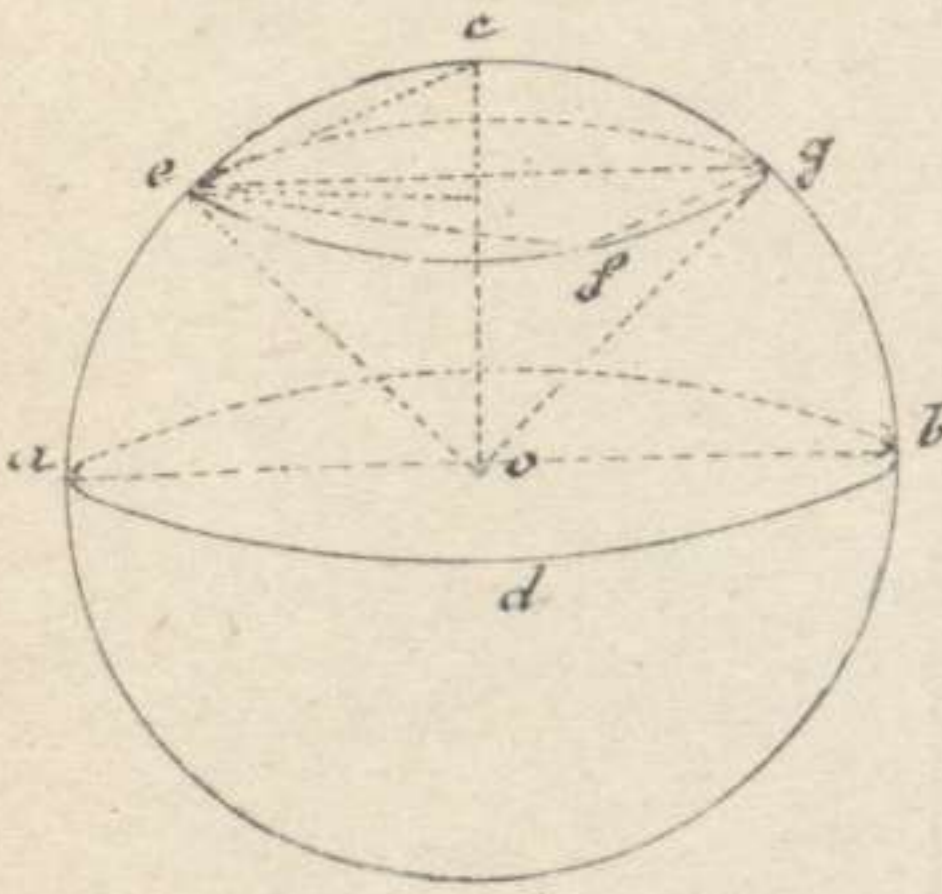

Fig. 47

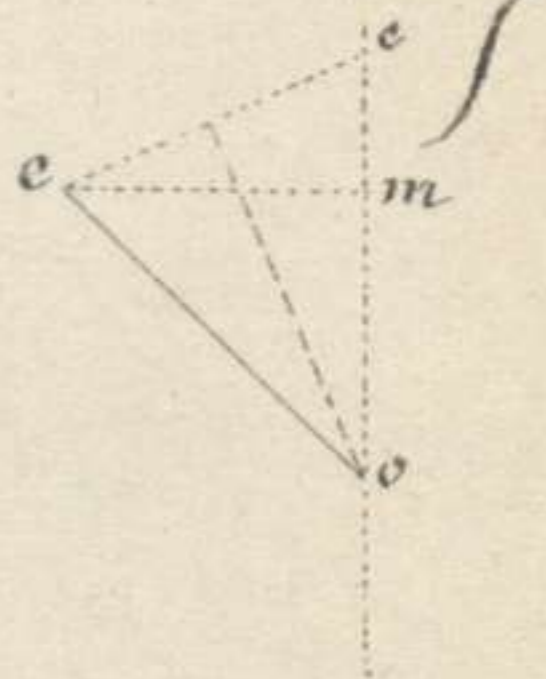

Fig. 48.

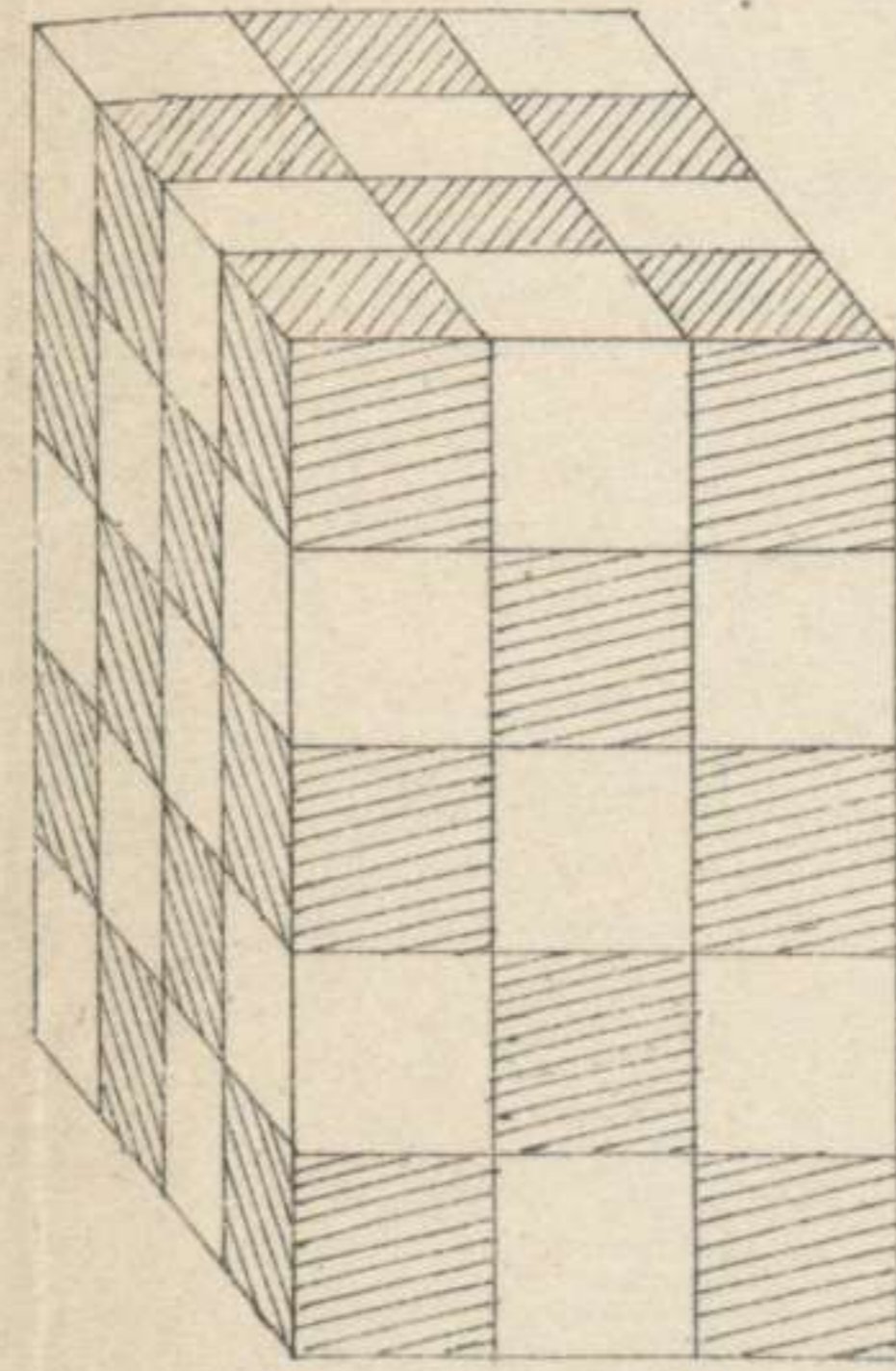

Fig. 50

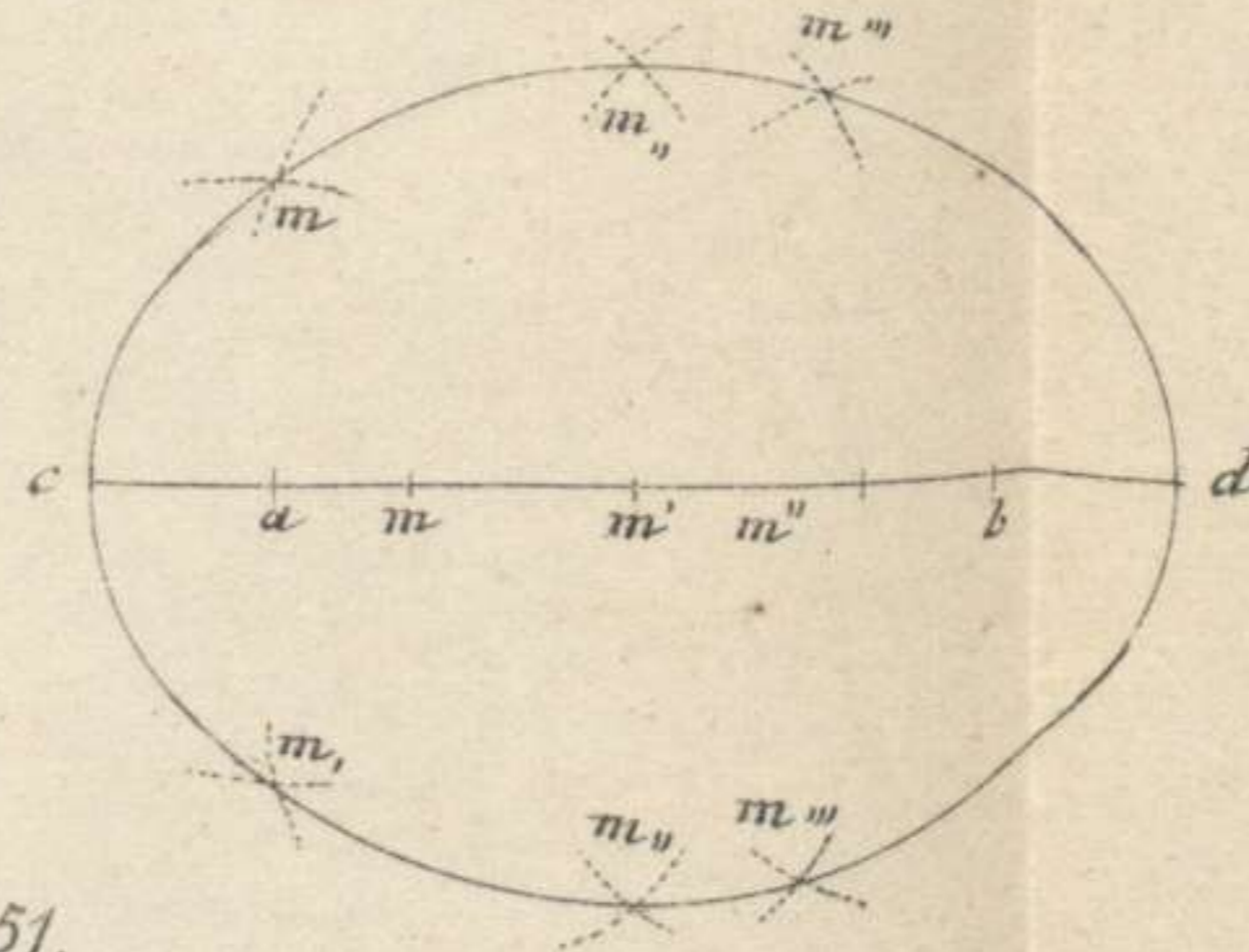

Fig. 52.

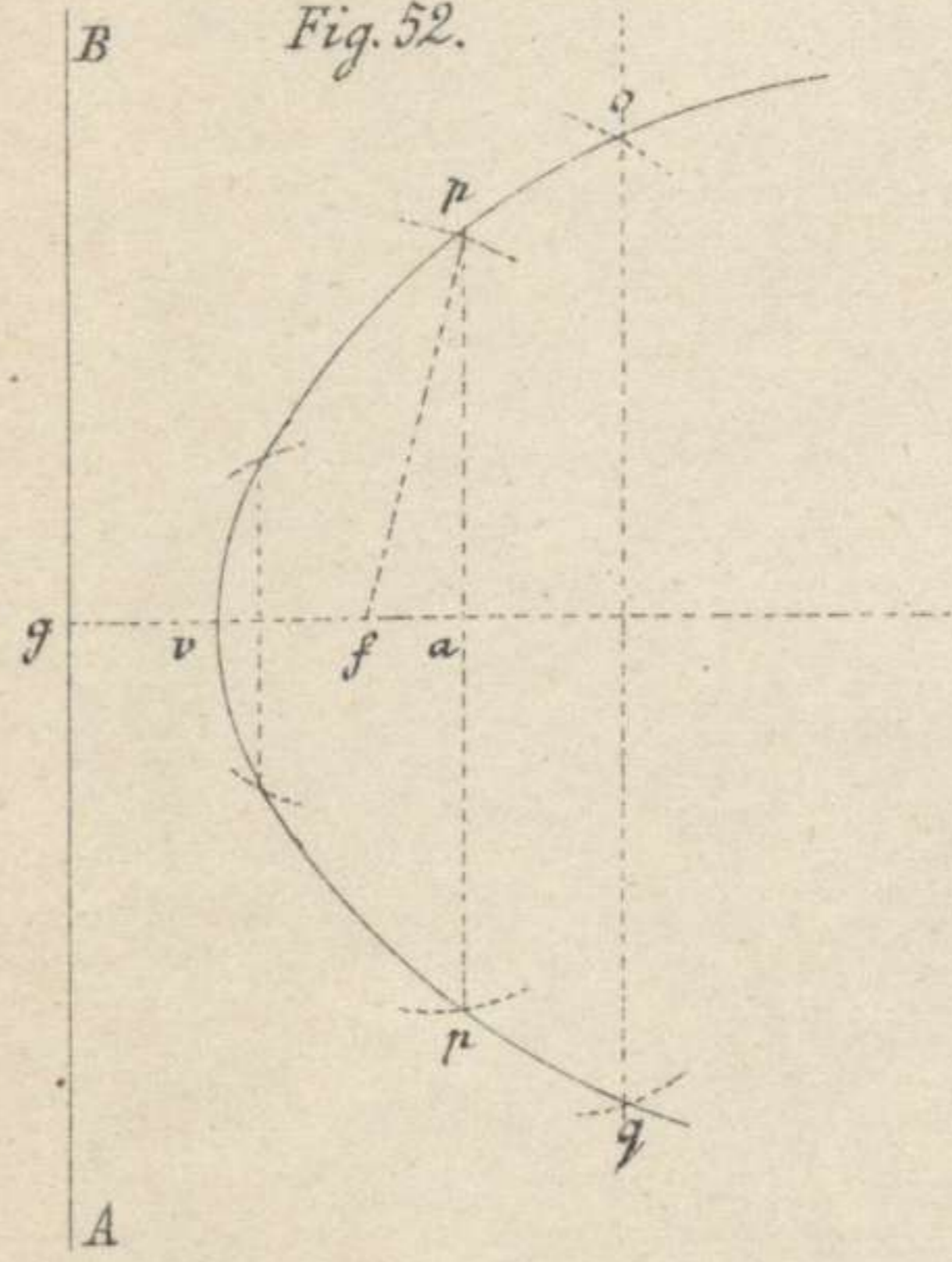

Fig. 53.

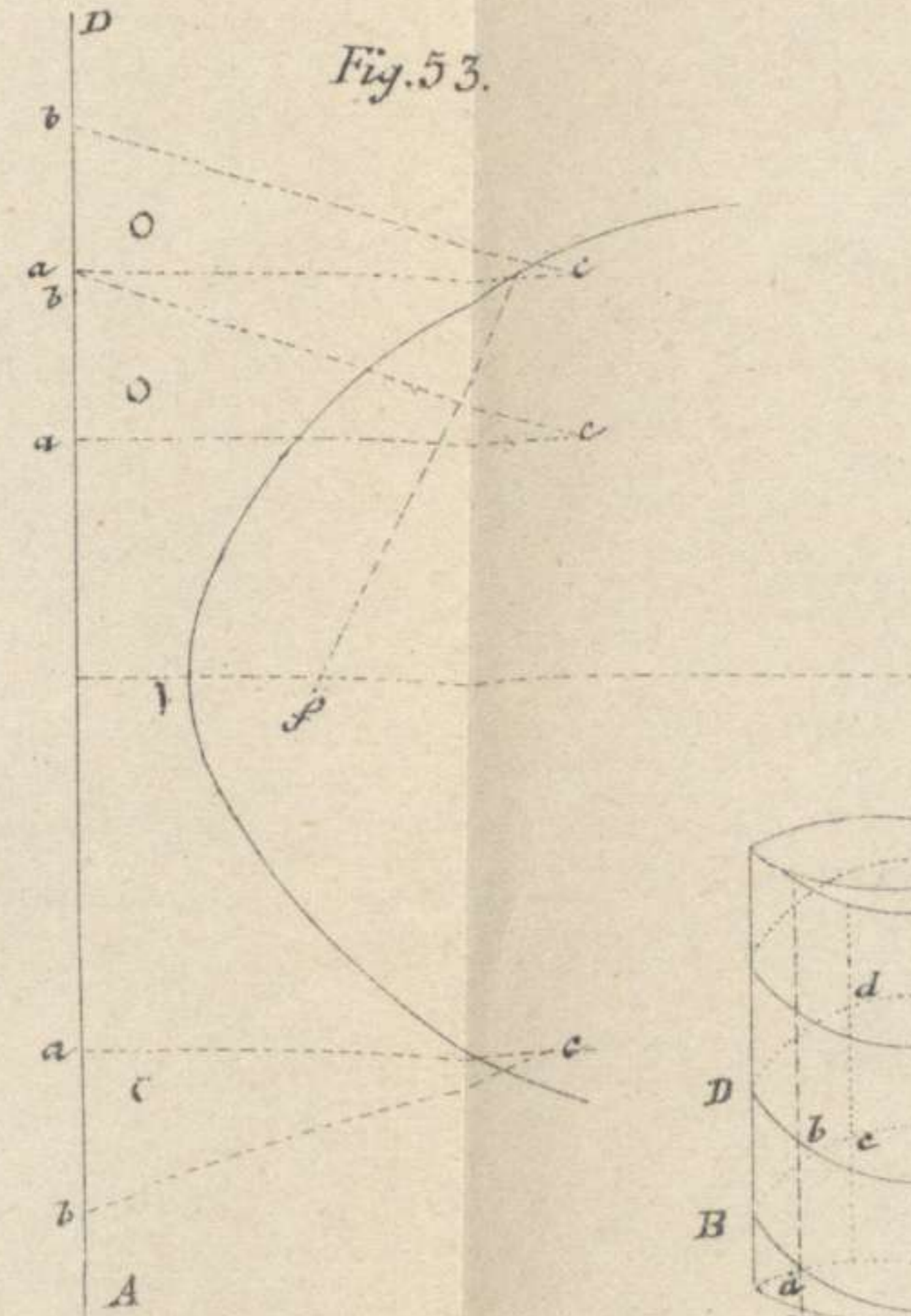

Fig. 45.

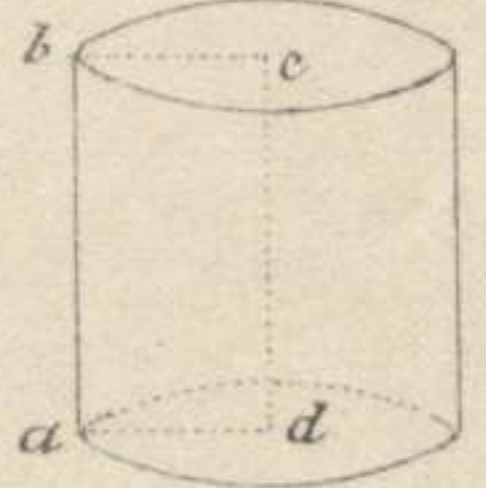

Fig. 51.

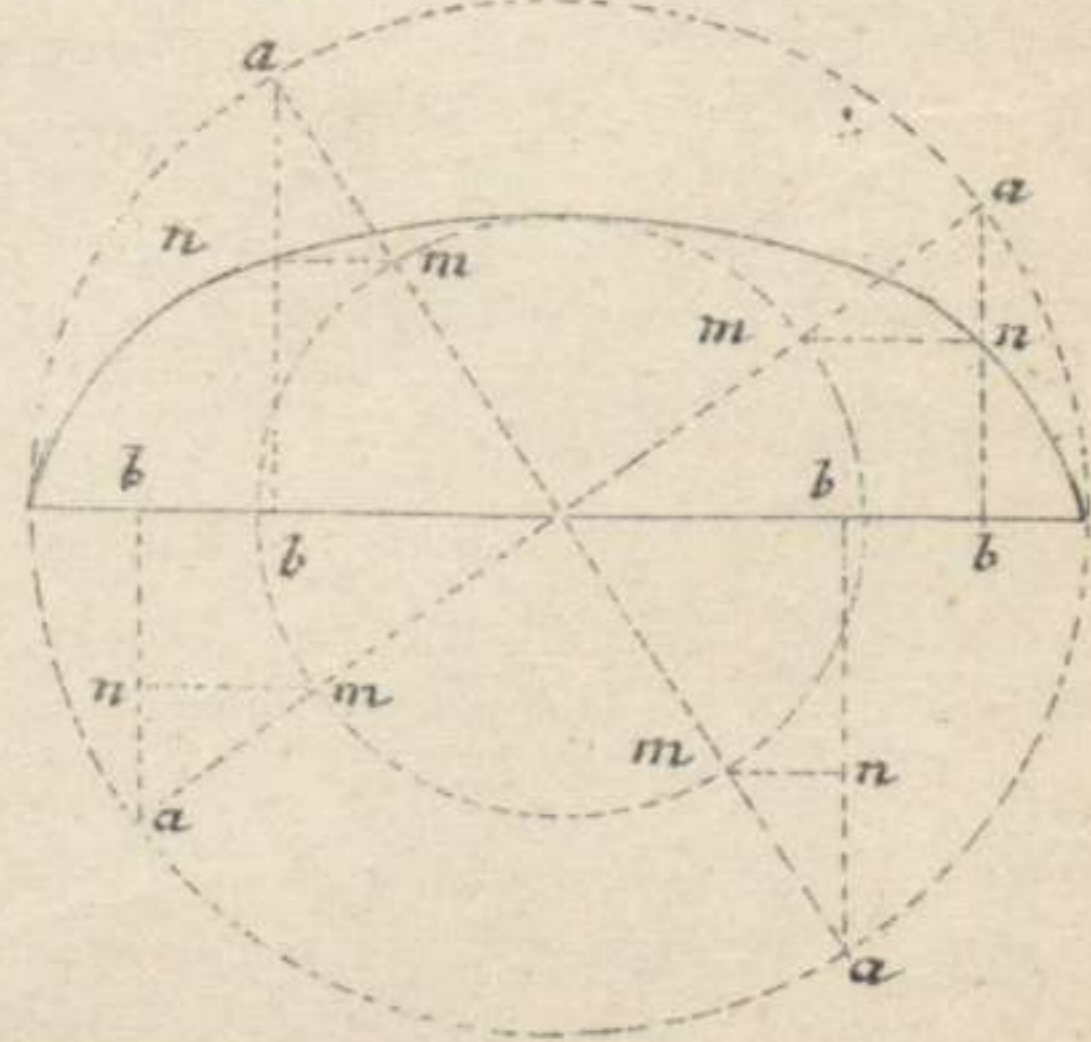
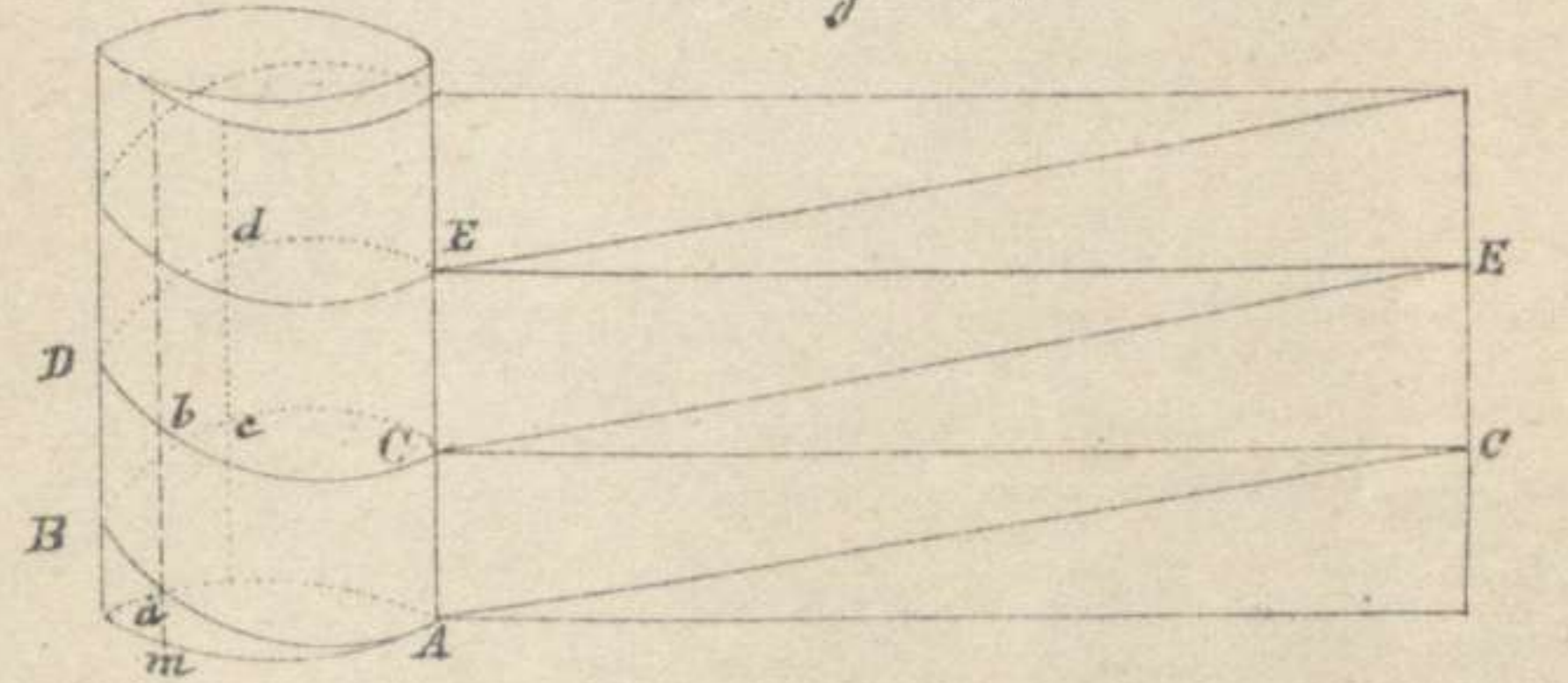
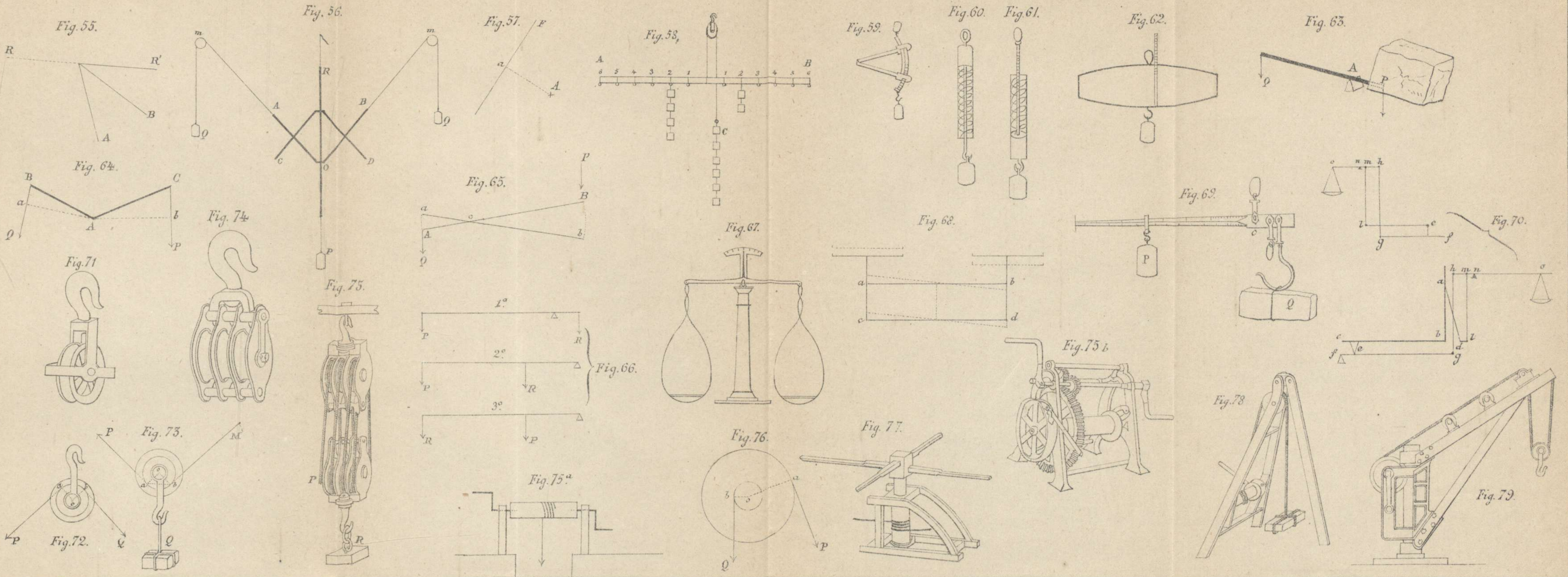

Fig. 54.





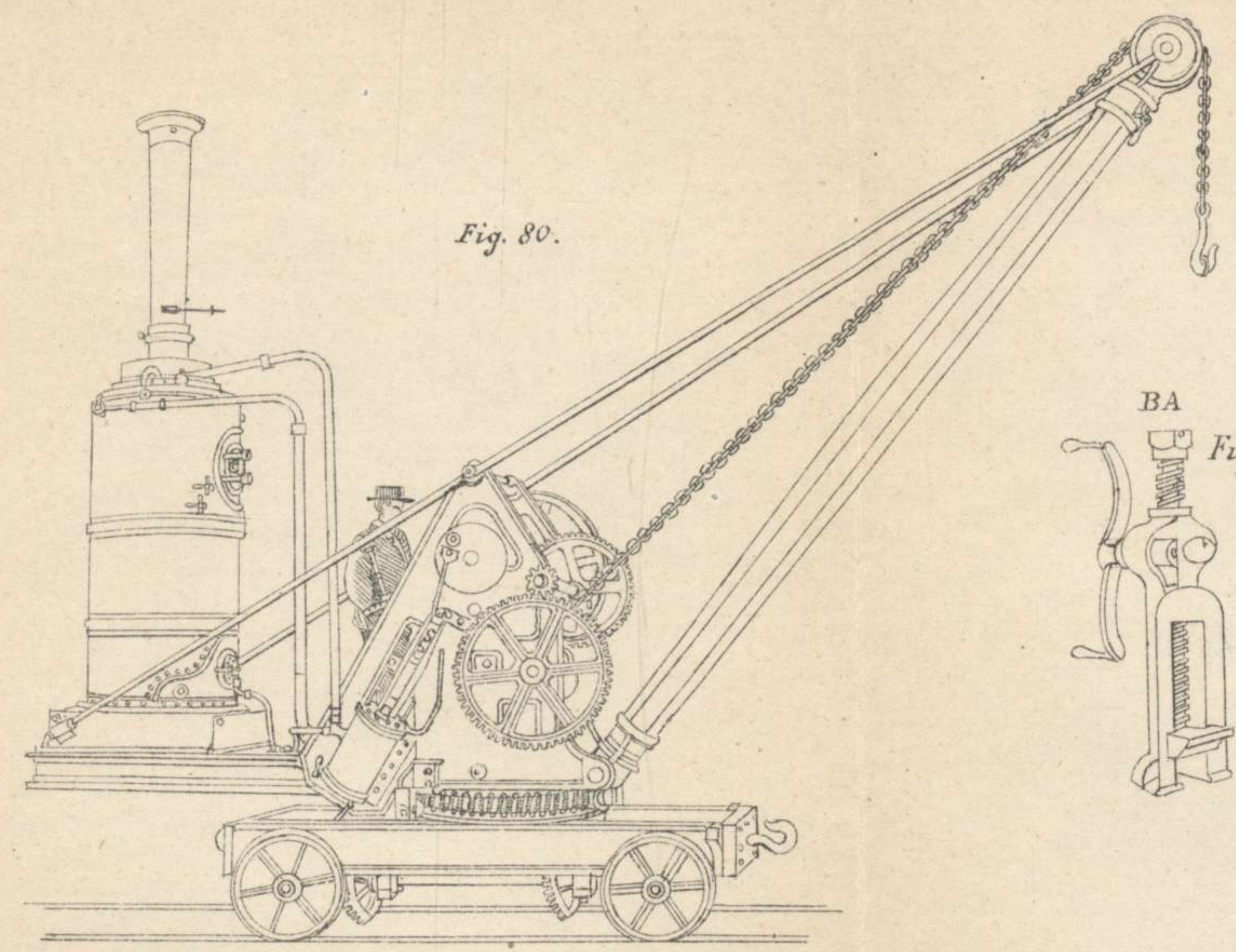

Fig. 80.

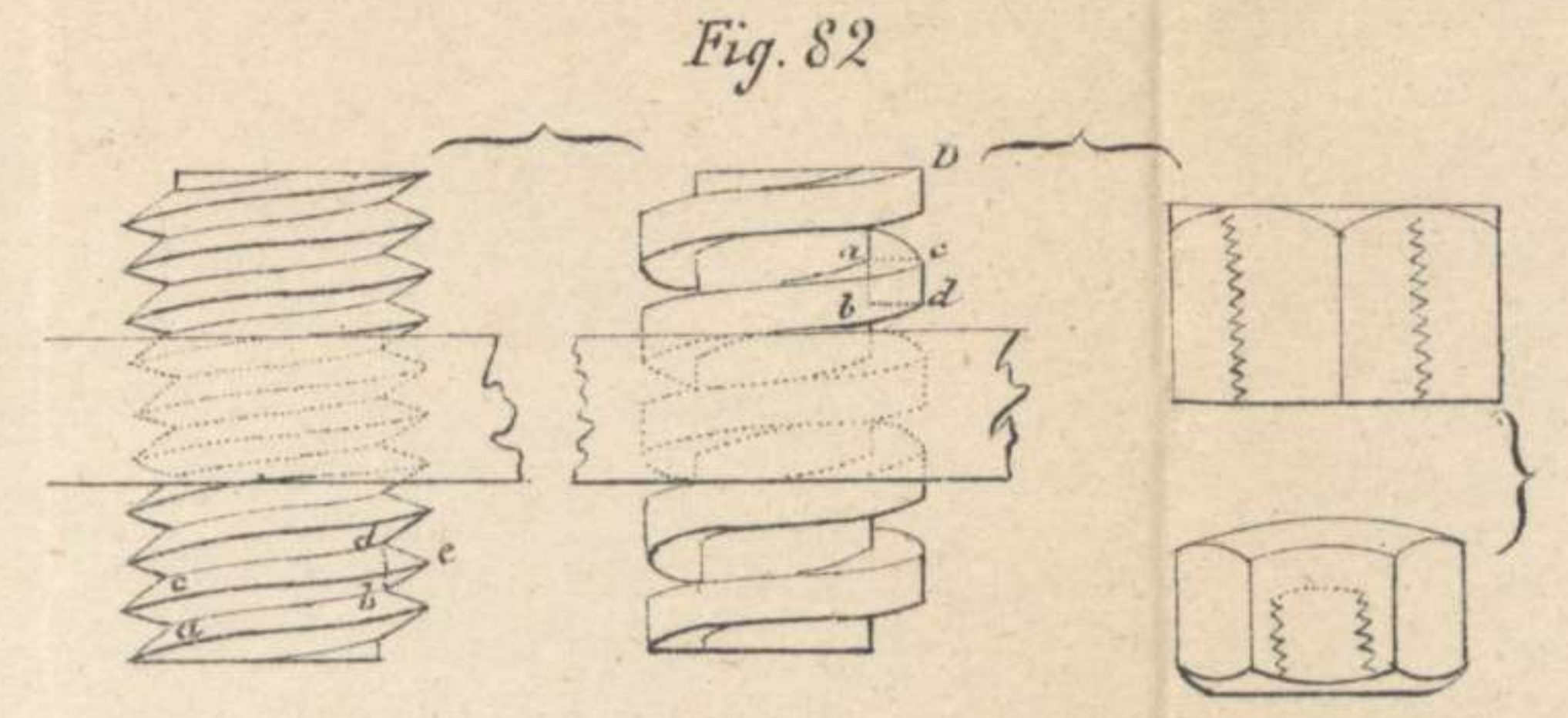

Fig. 82.

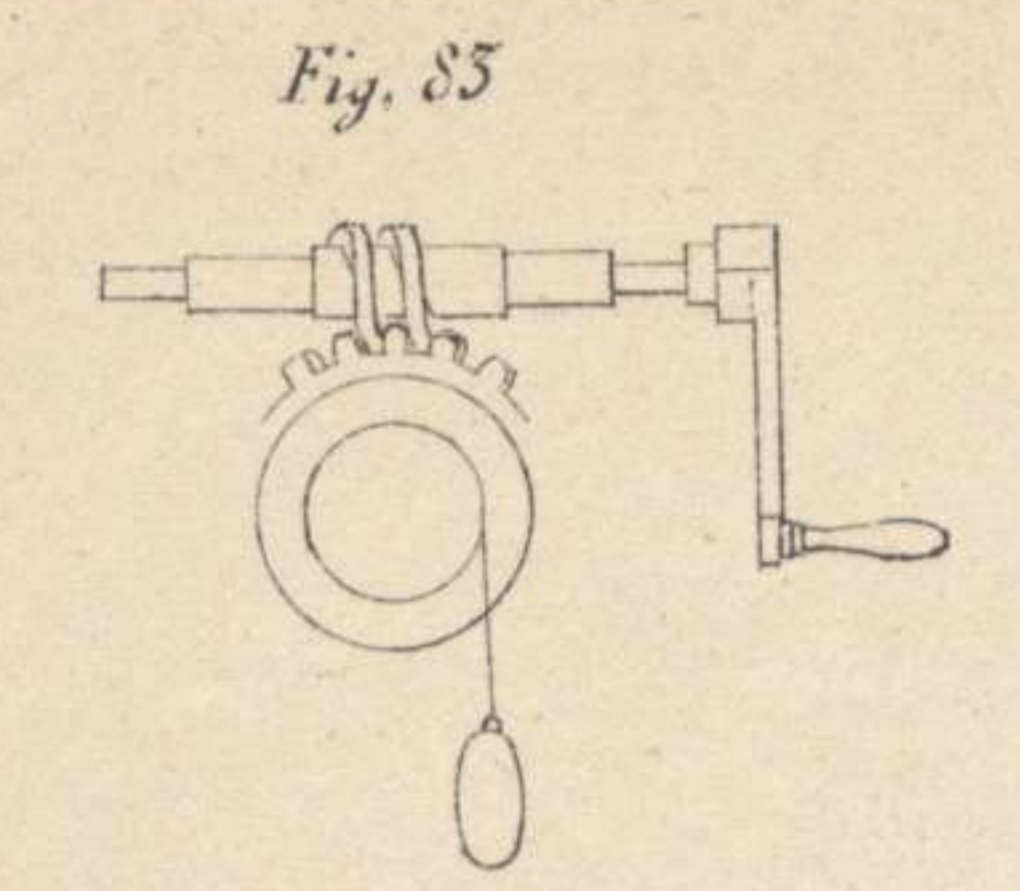

Fig. 85.

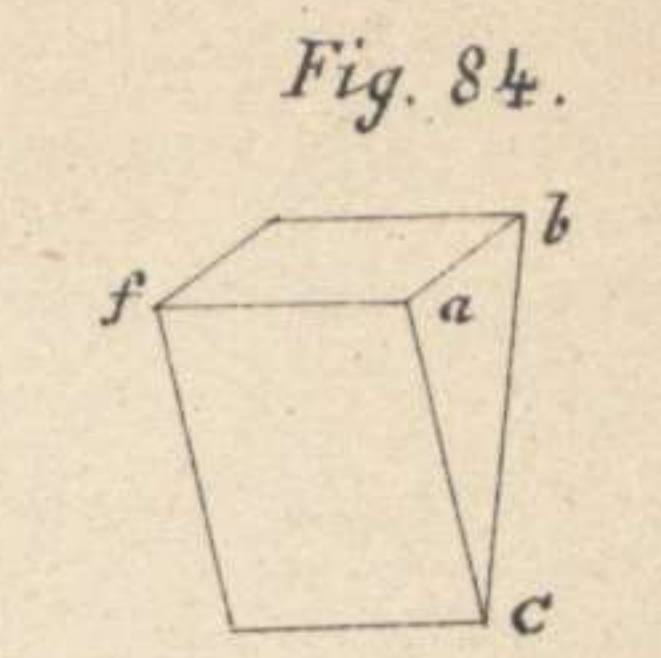

Fig. 84.

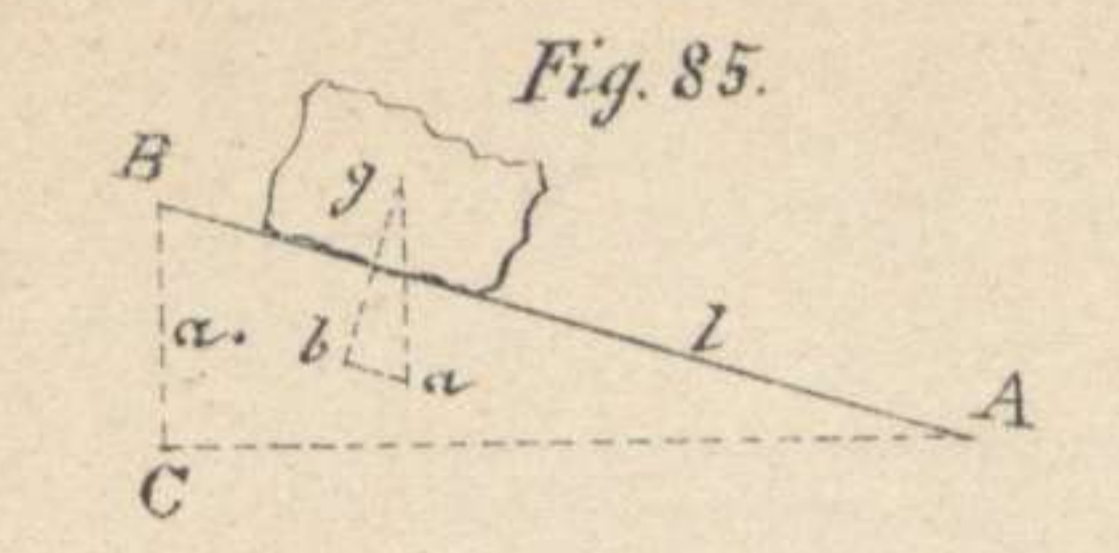

Fig. 85.

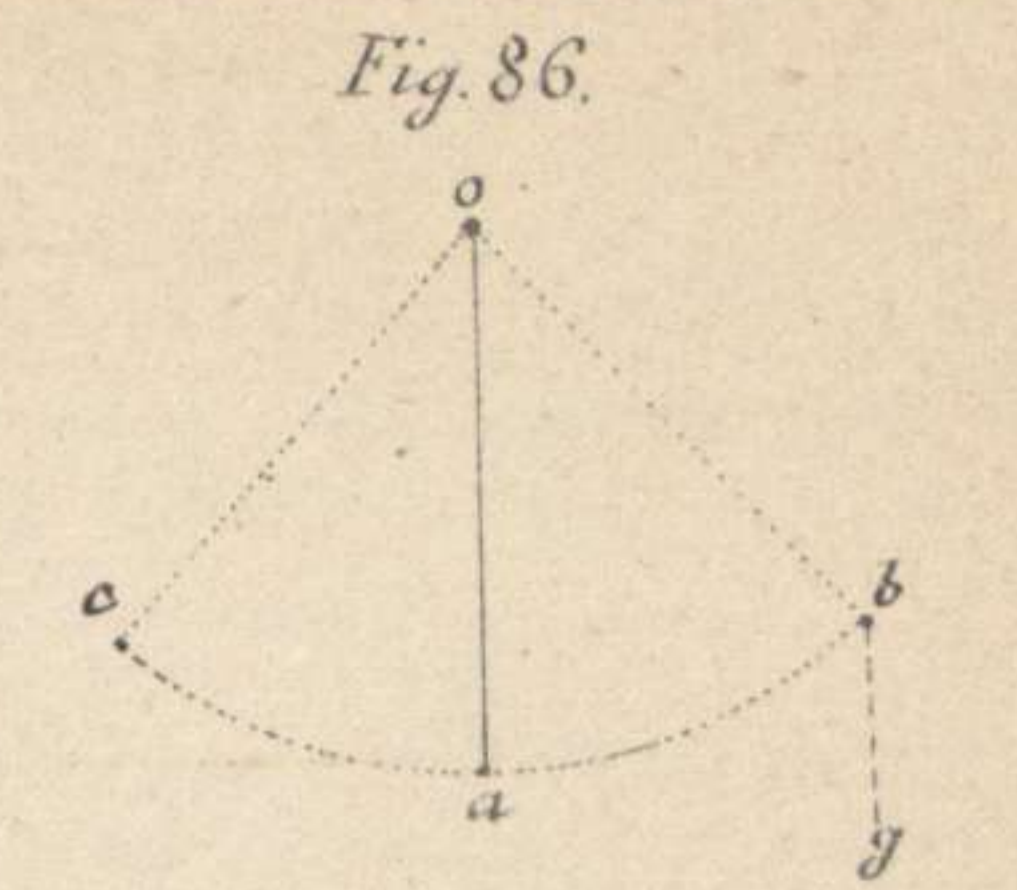

Fig. 86.

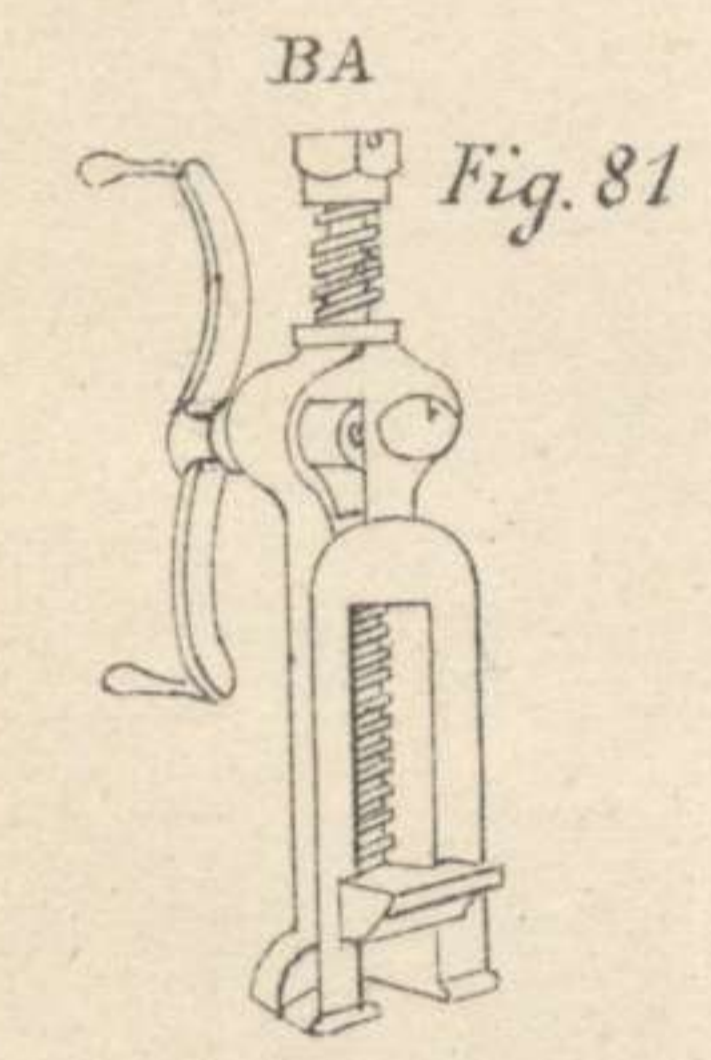

Fig. 81.

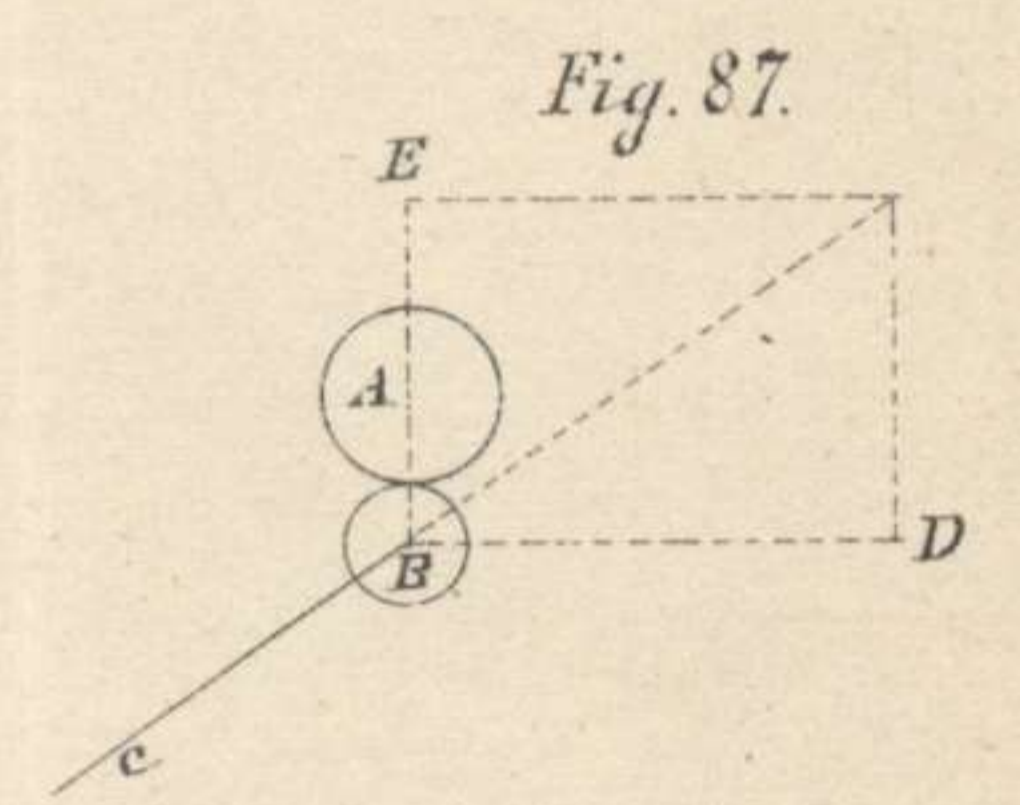

Fig. 87.

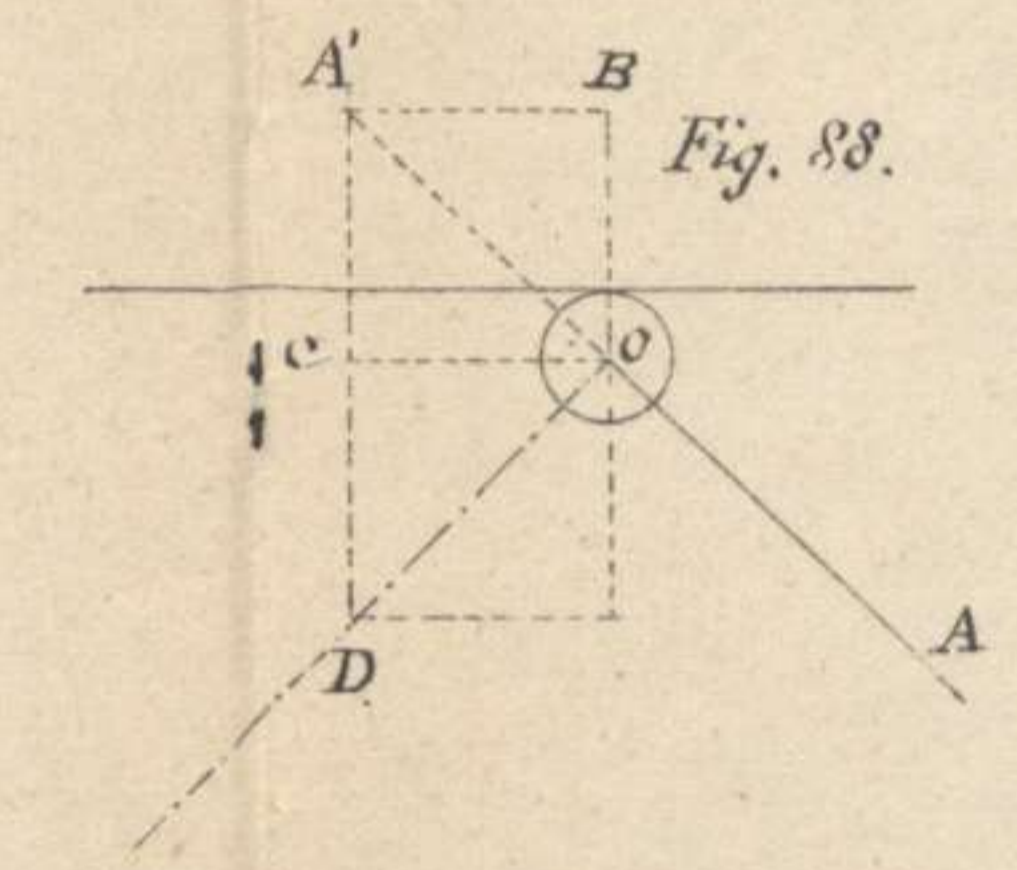

Fig. 88.

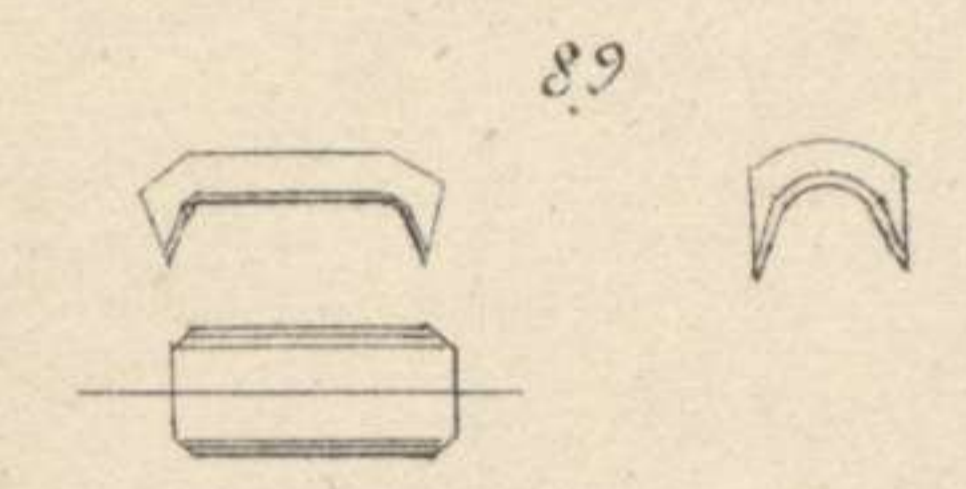

Fig. 89.

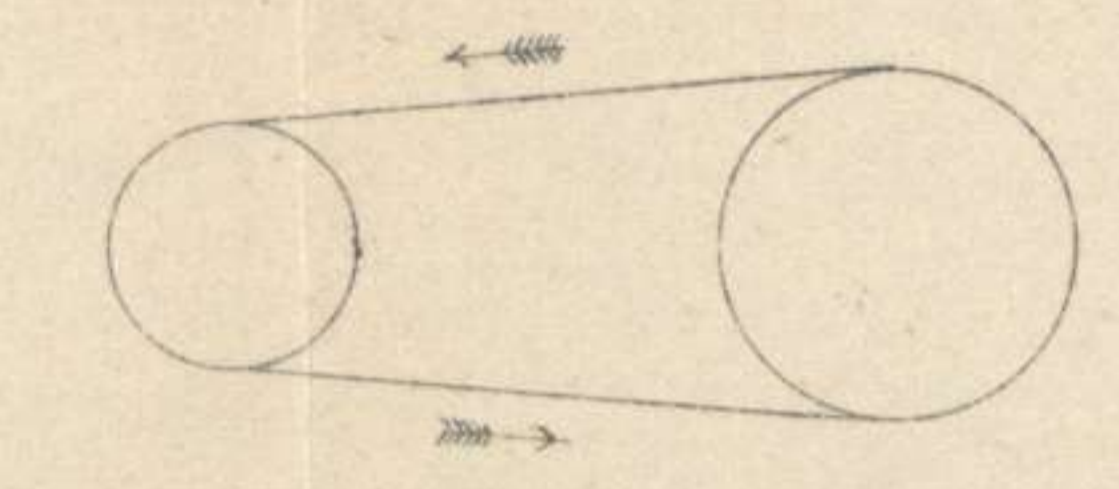

Fig. 90.

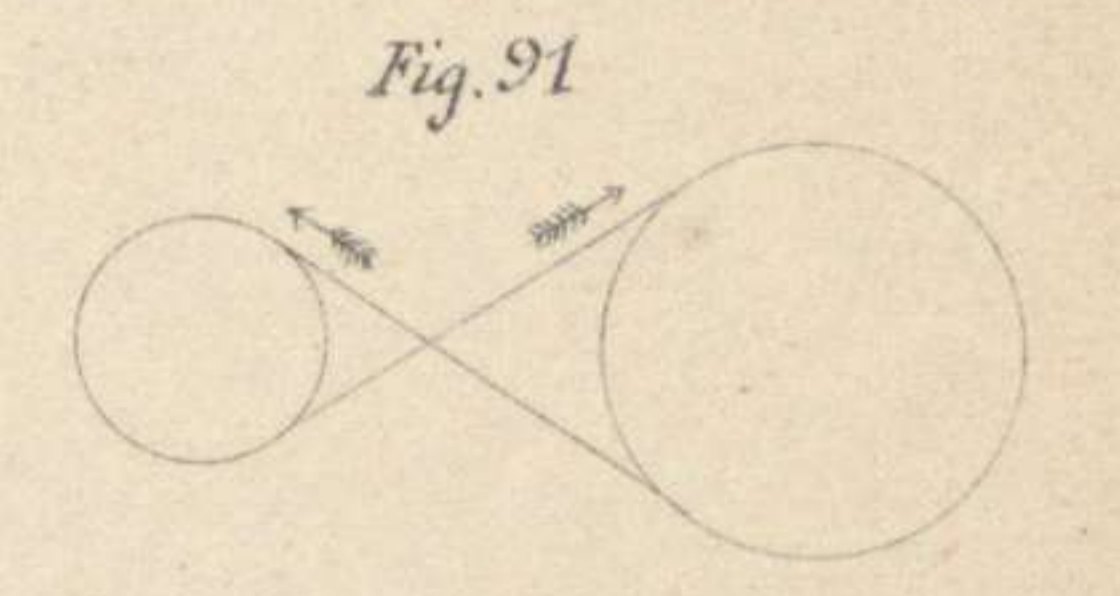

Fig. 91.

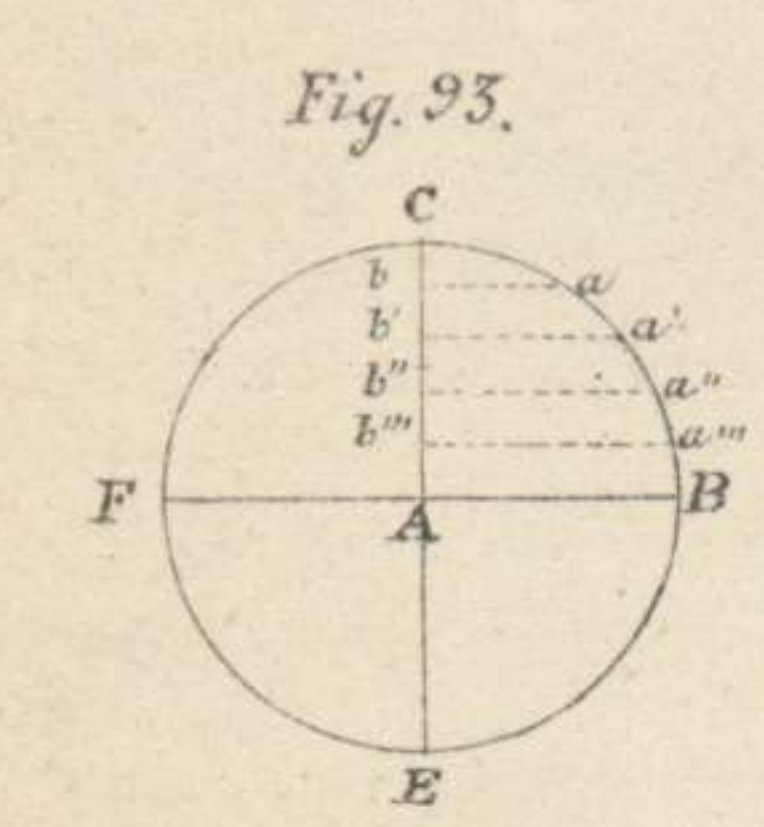

Fig. 93.

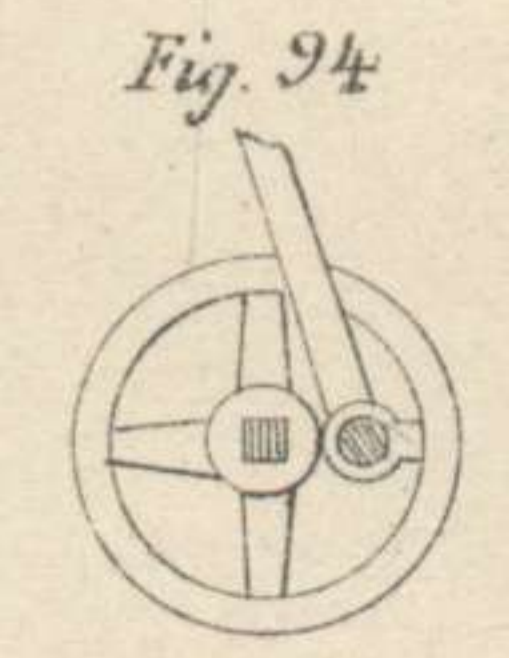

Fig. 94.

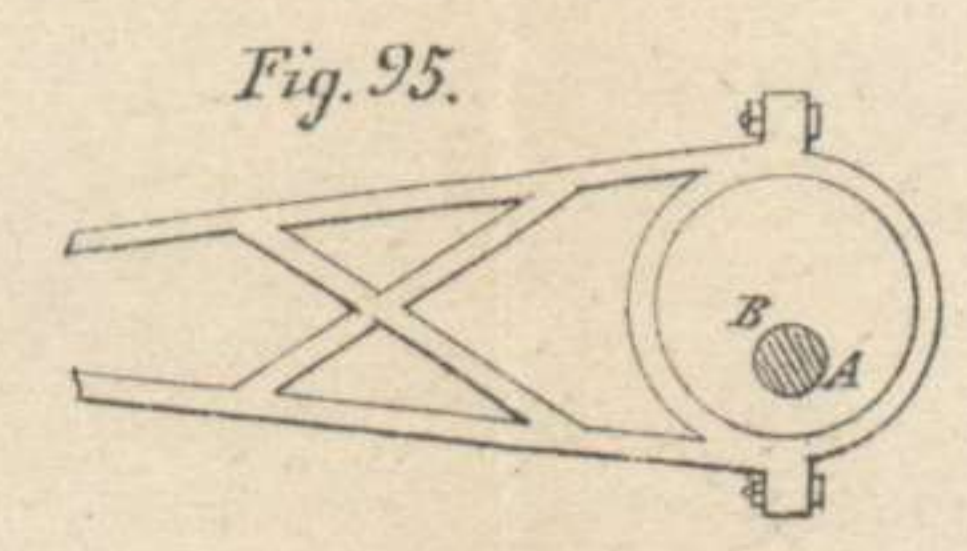

Fig. 95.

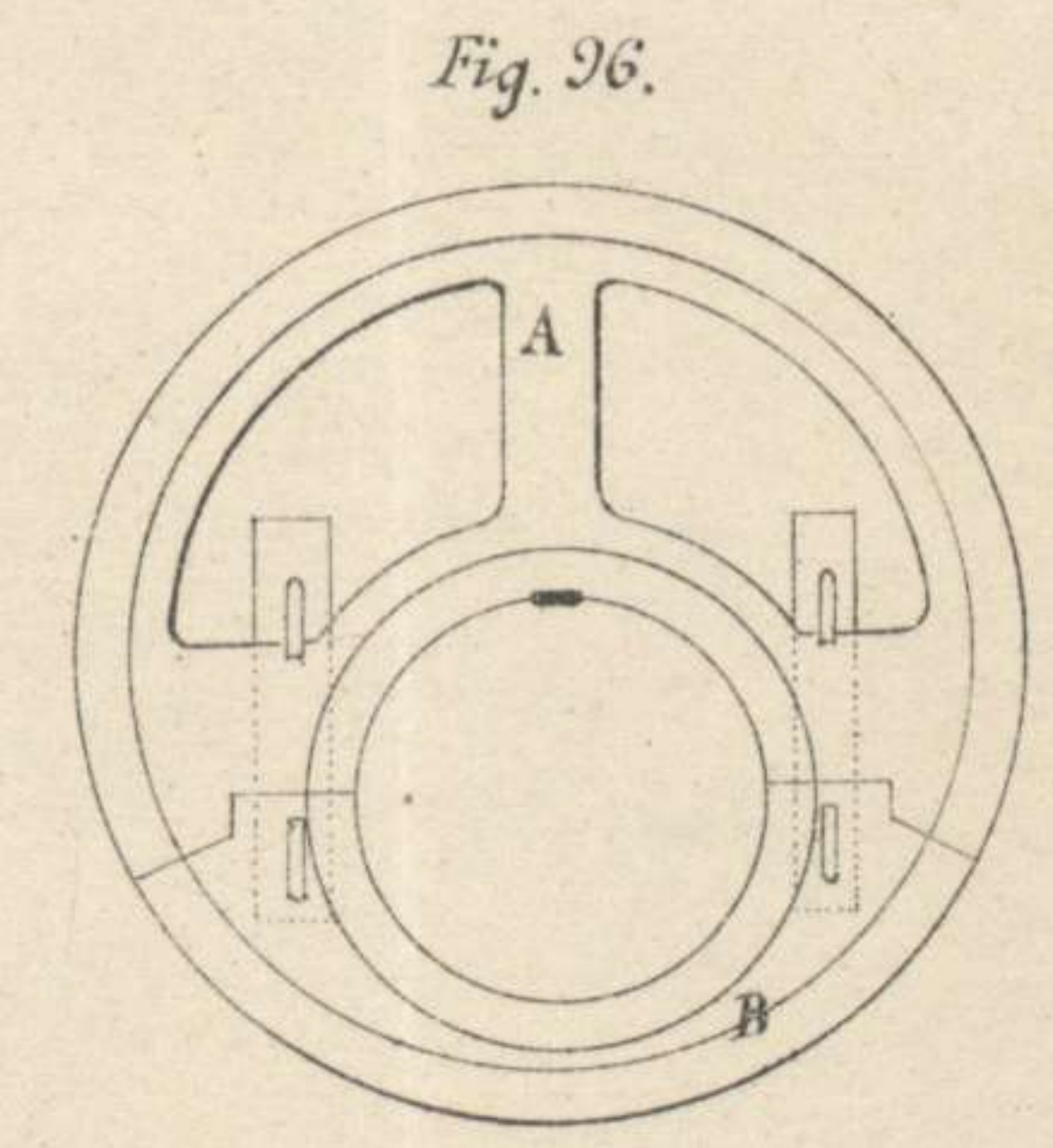

Fig. 96.

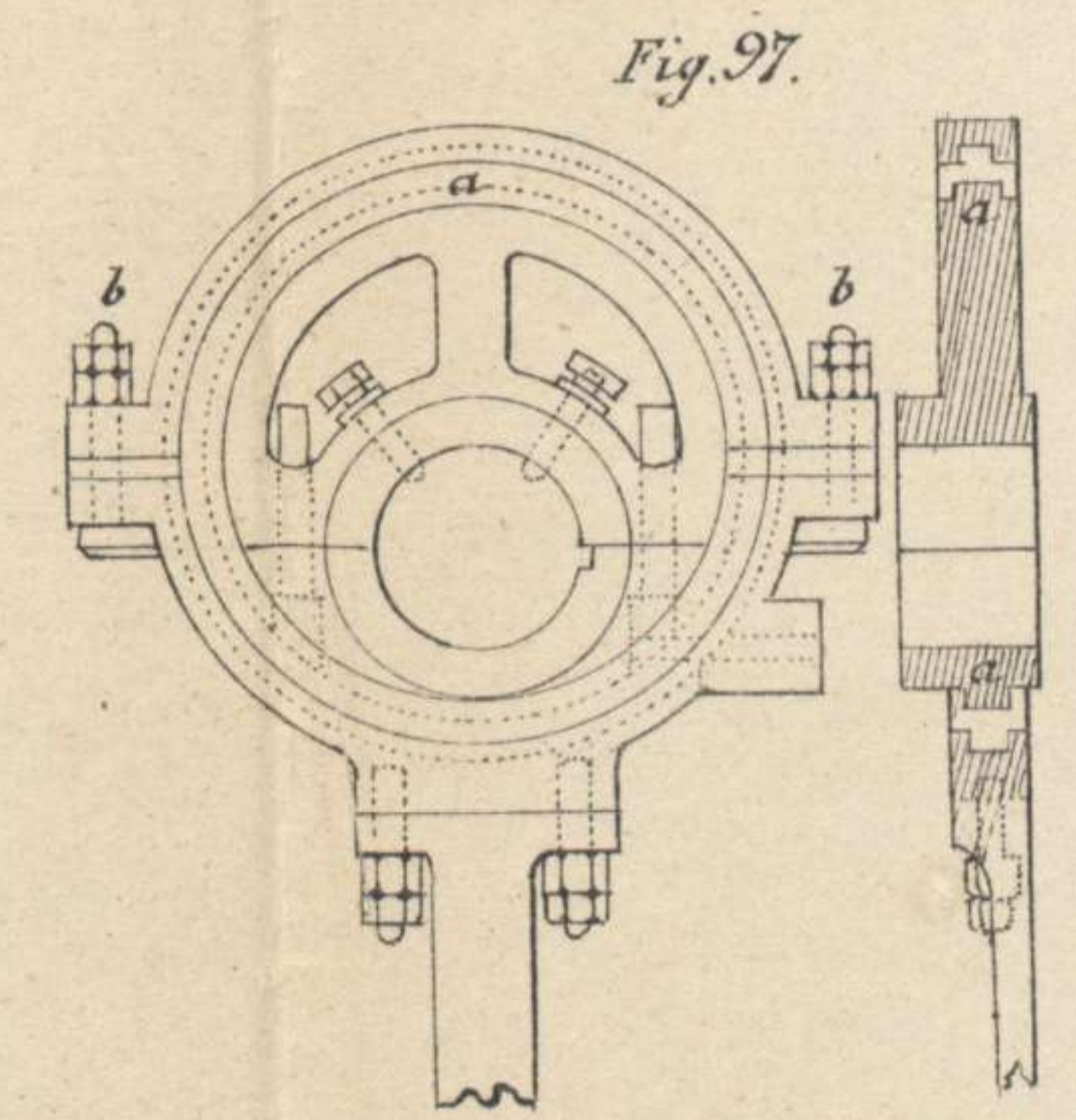

Fig. 97.

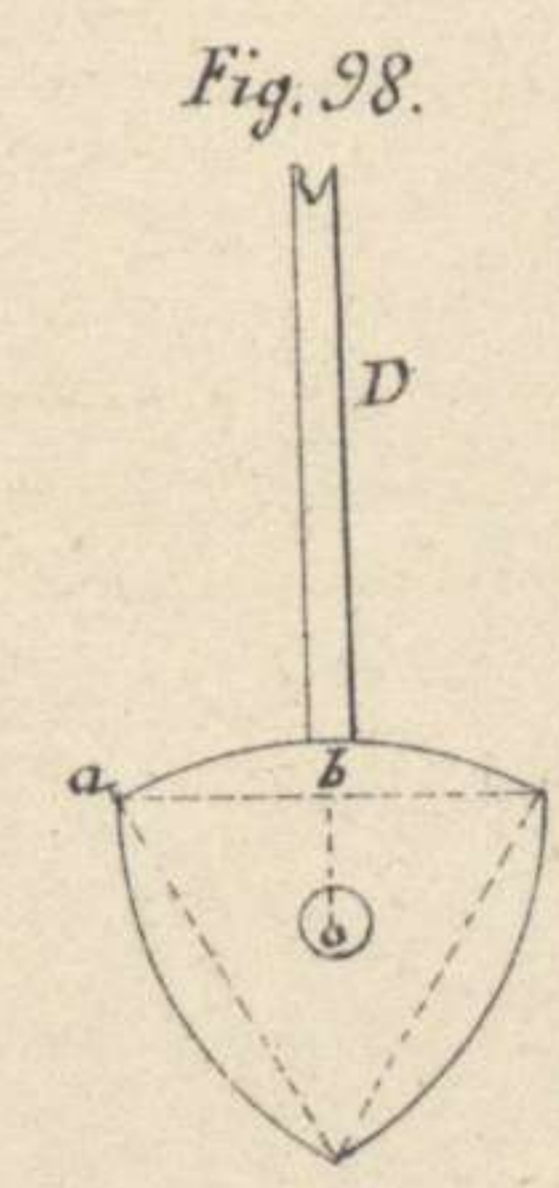

Fig. 98.

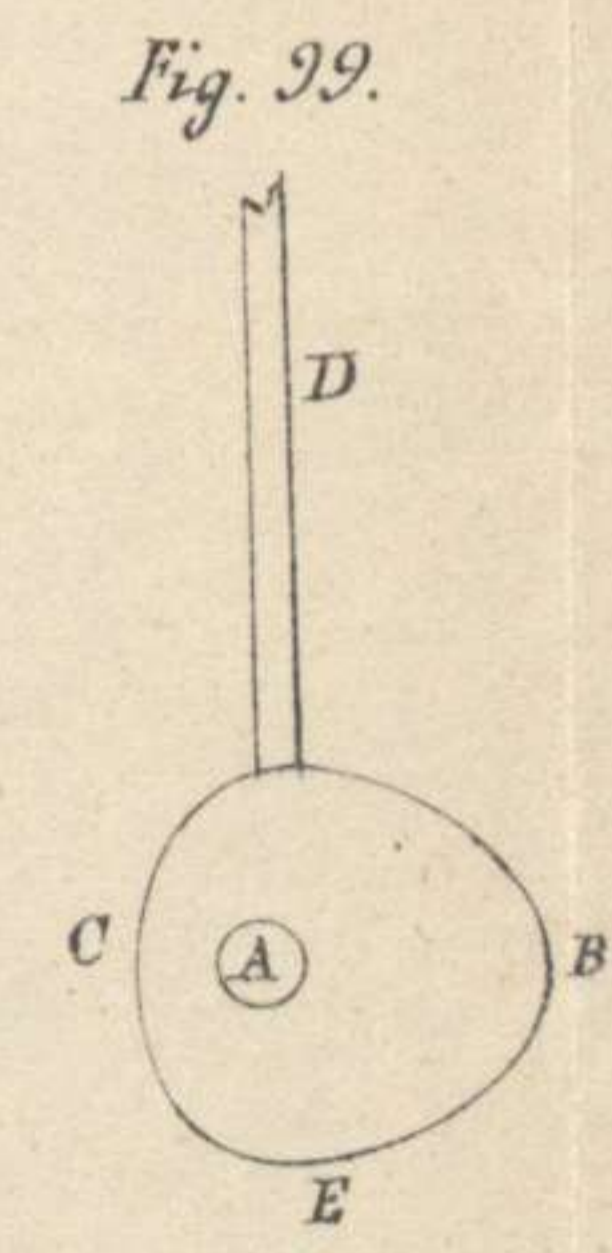

Fig. 99.

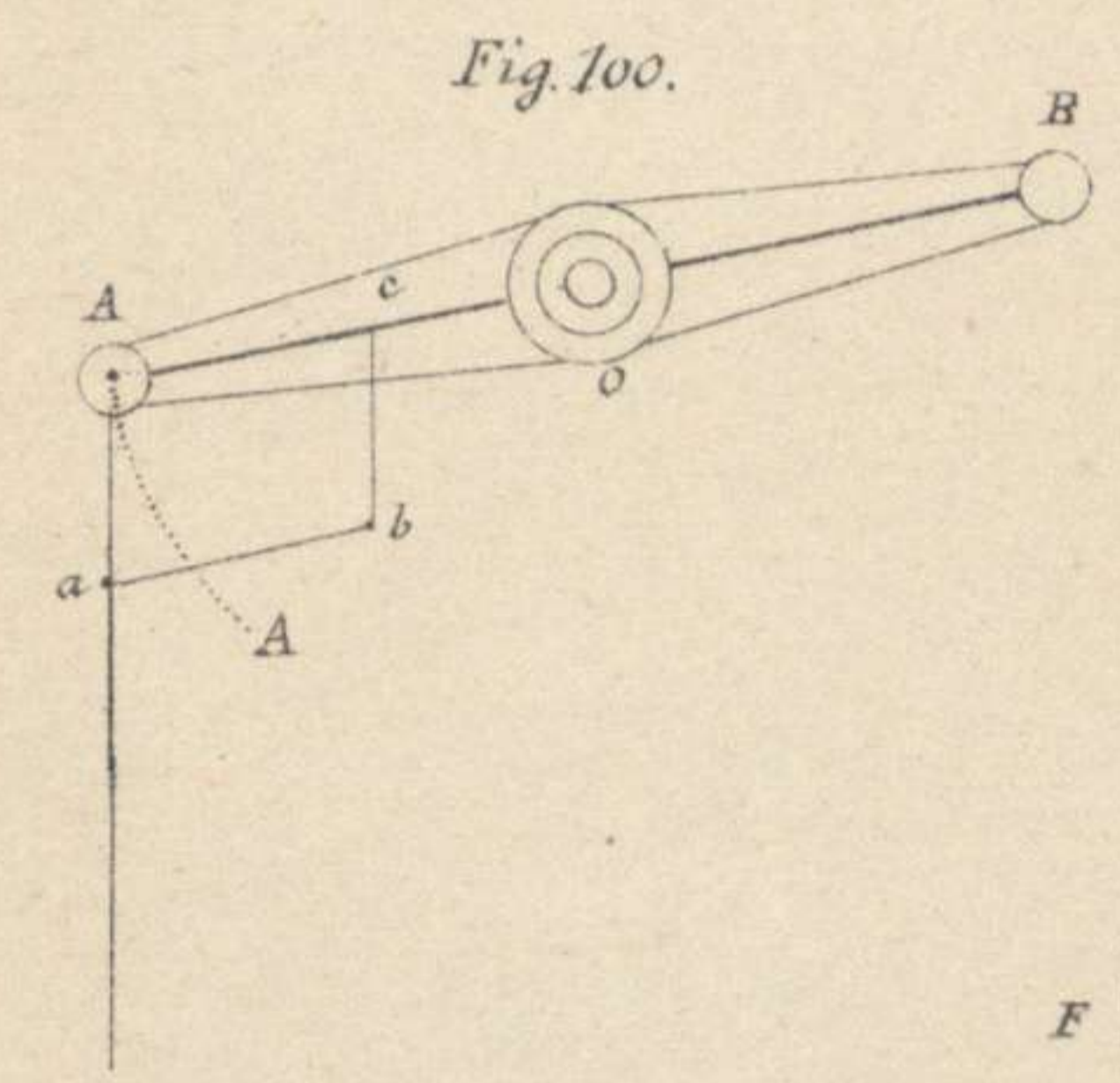

Fig. 100.

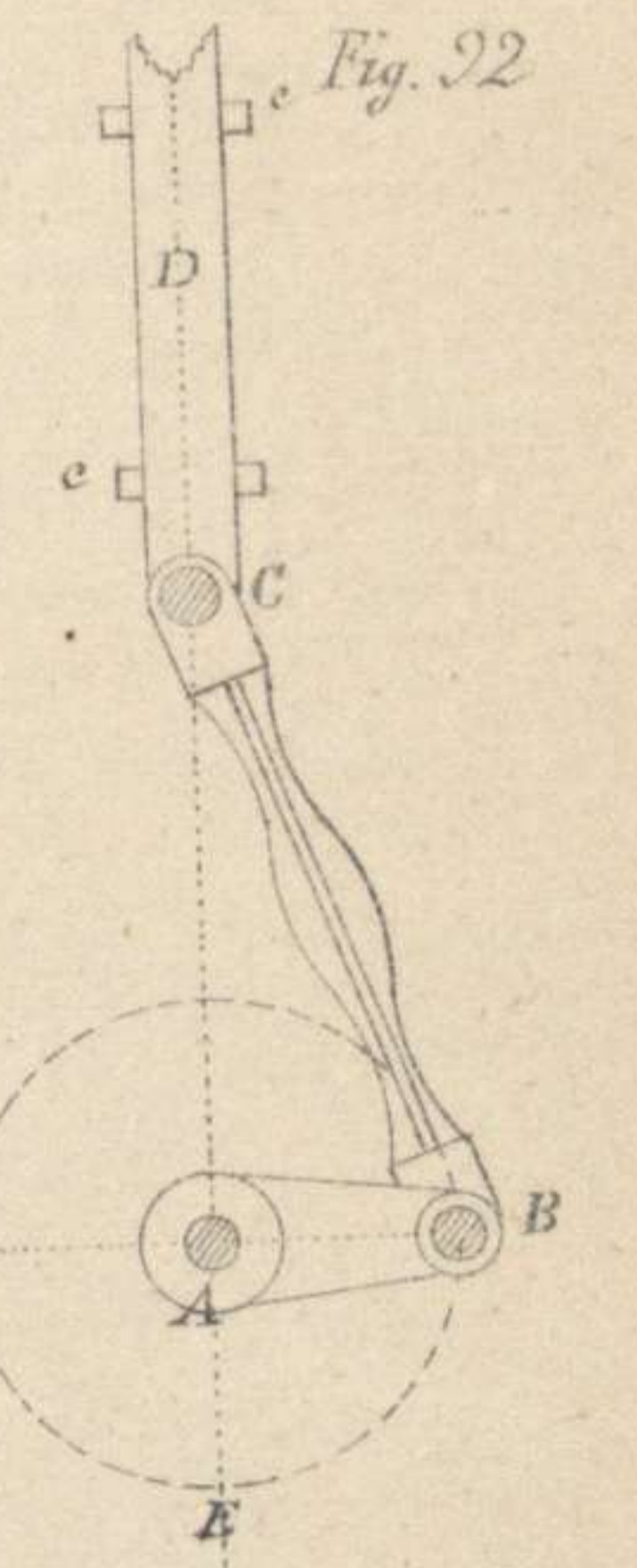
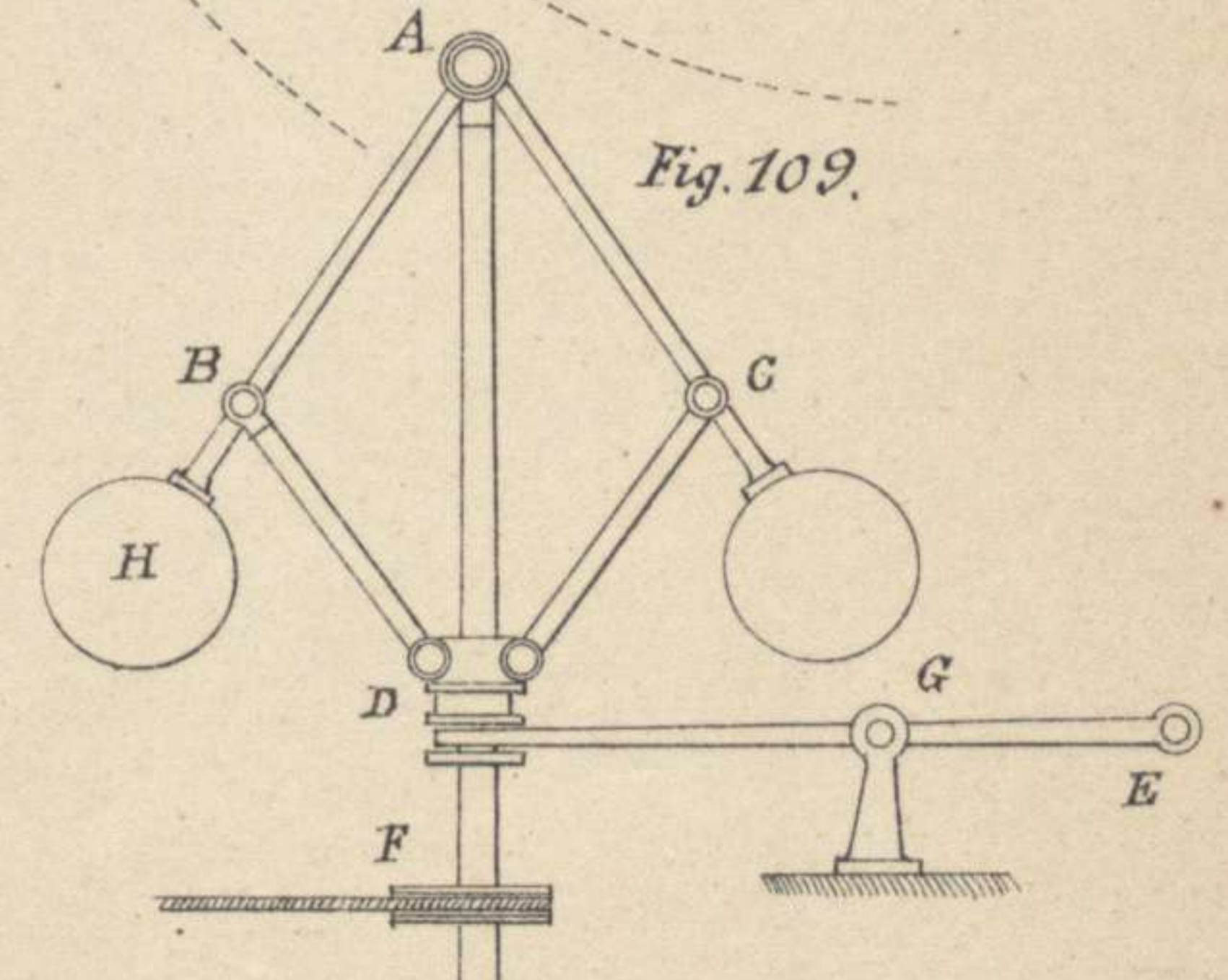
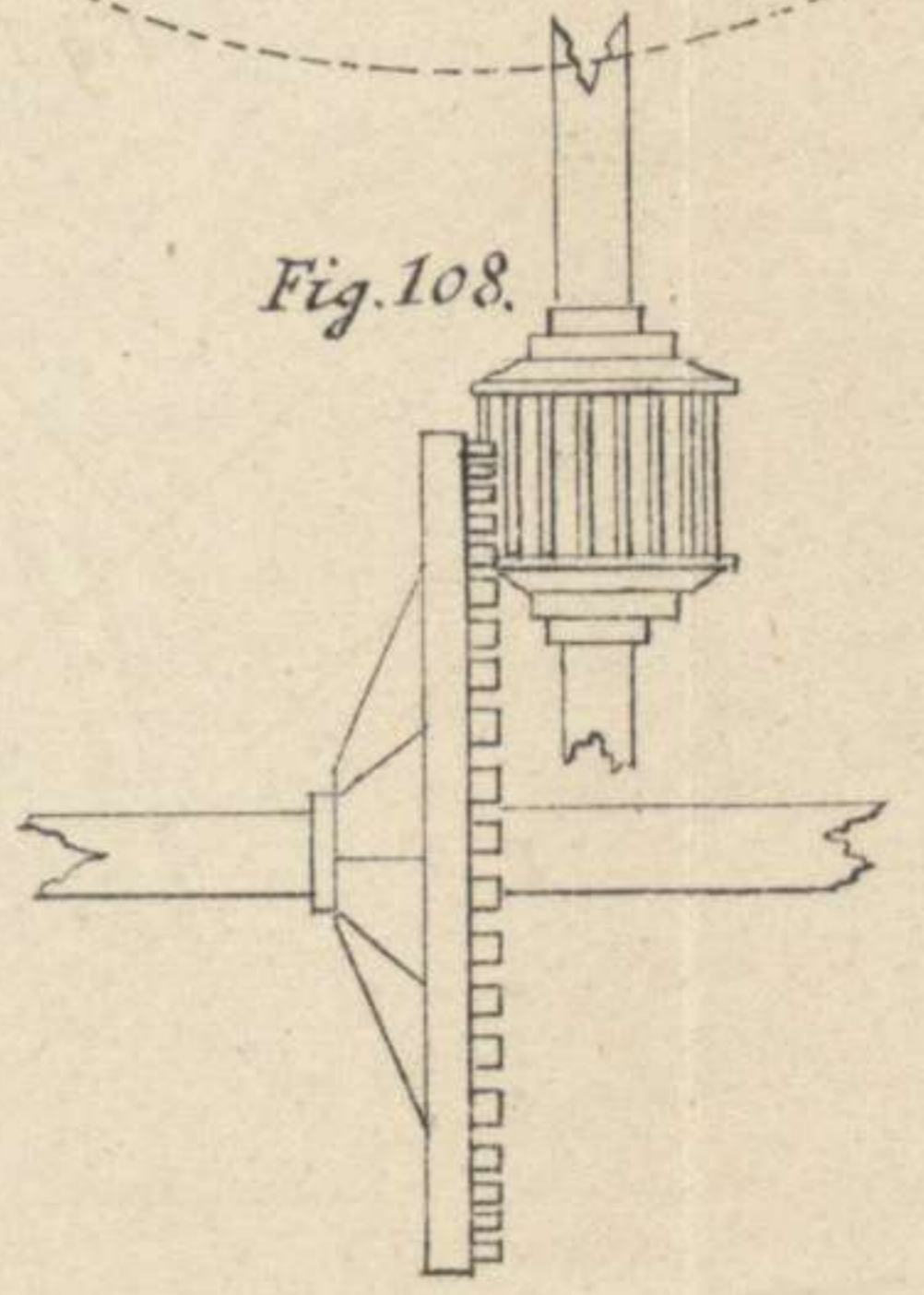
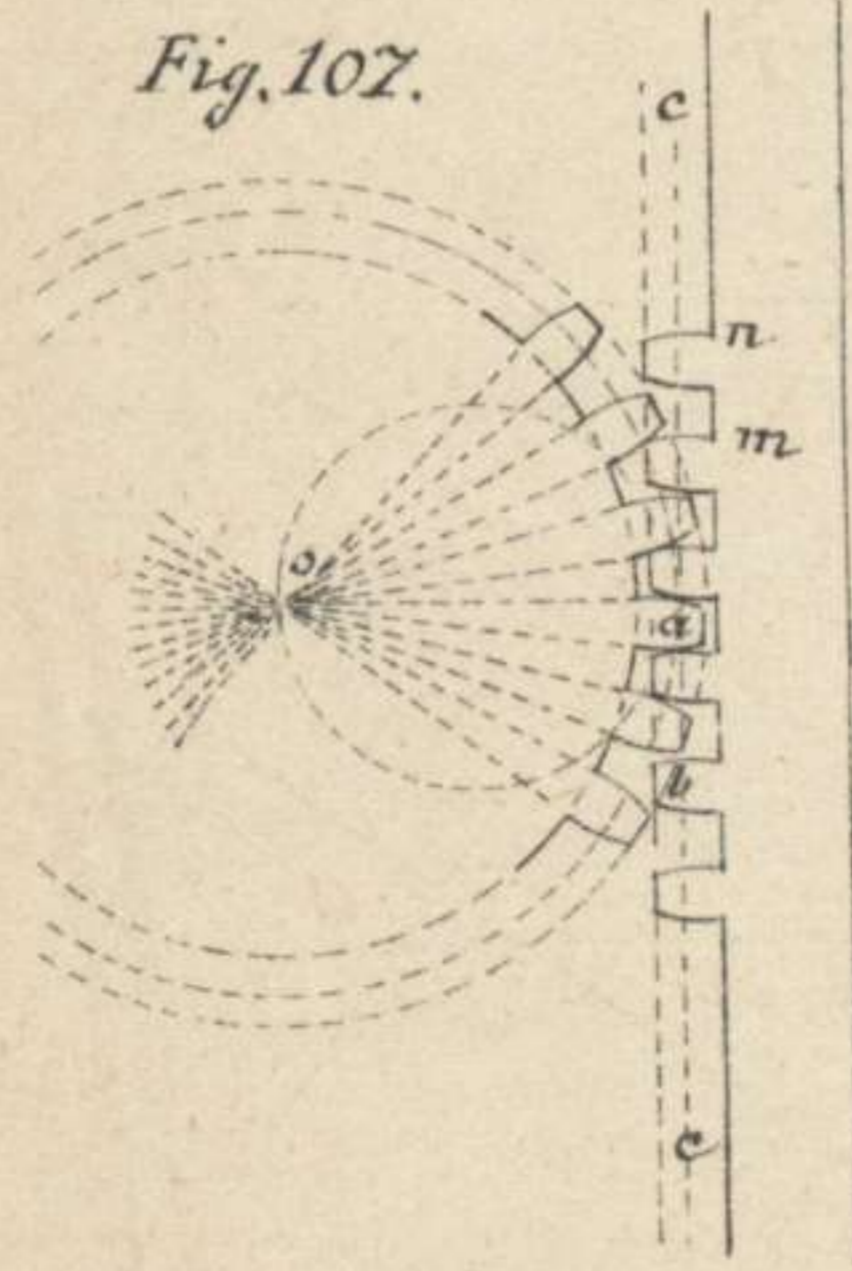
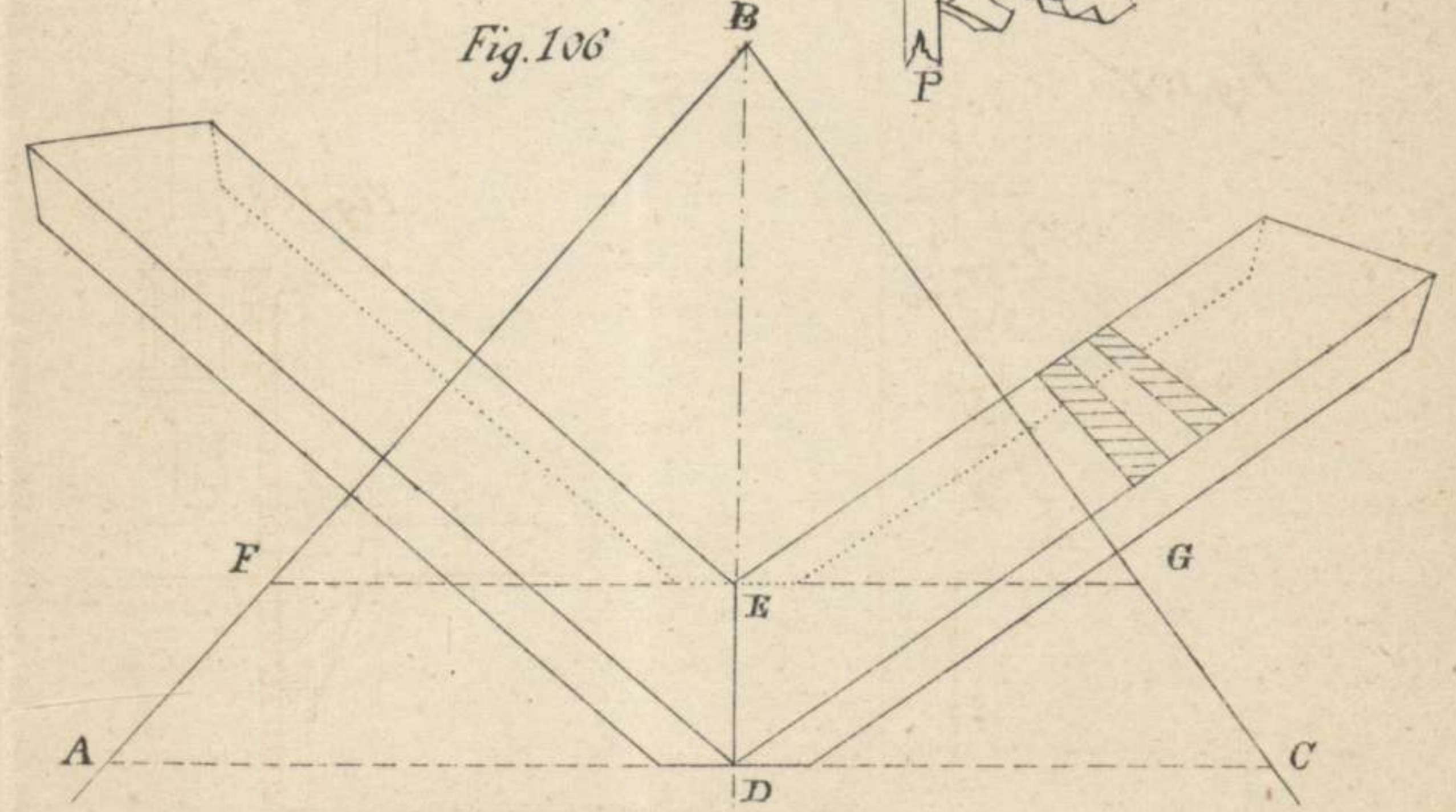
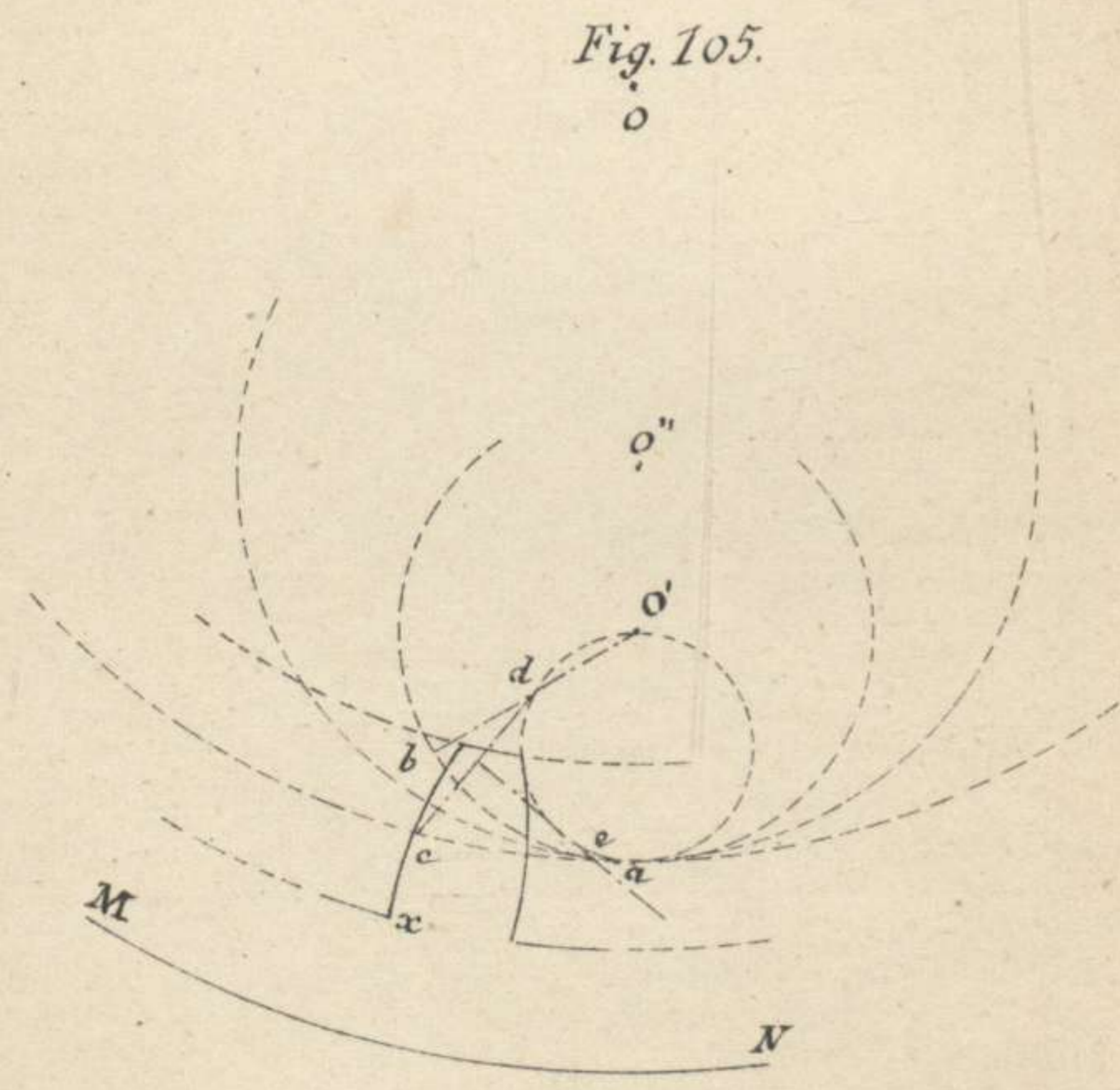
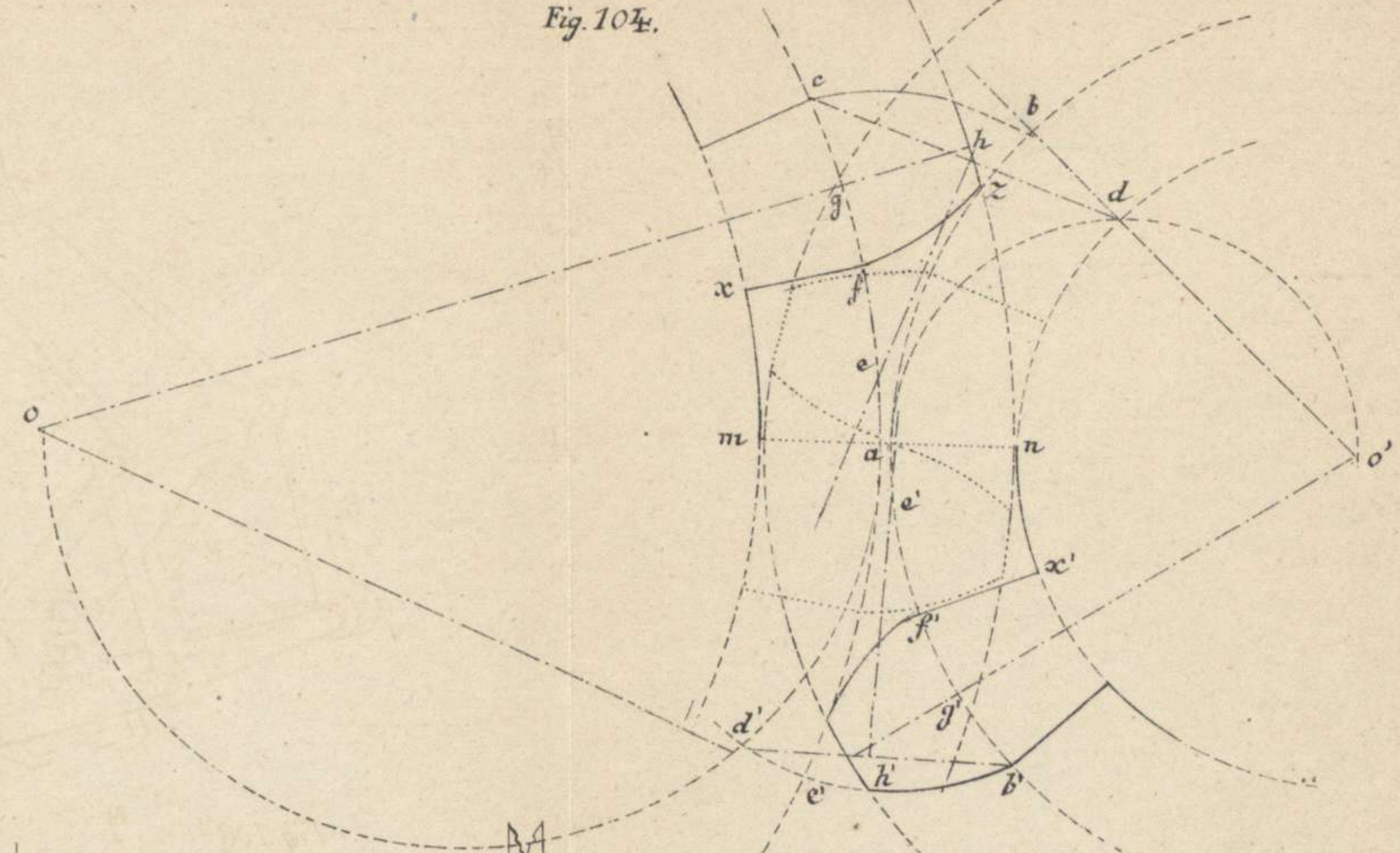
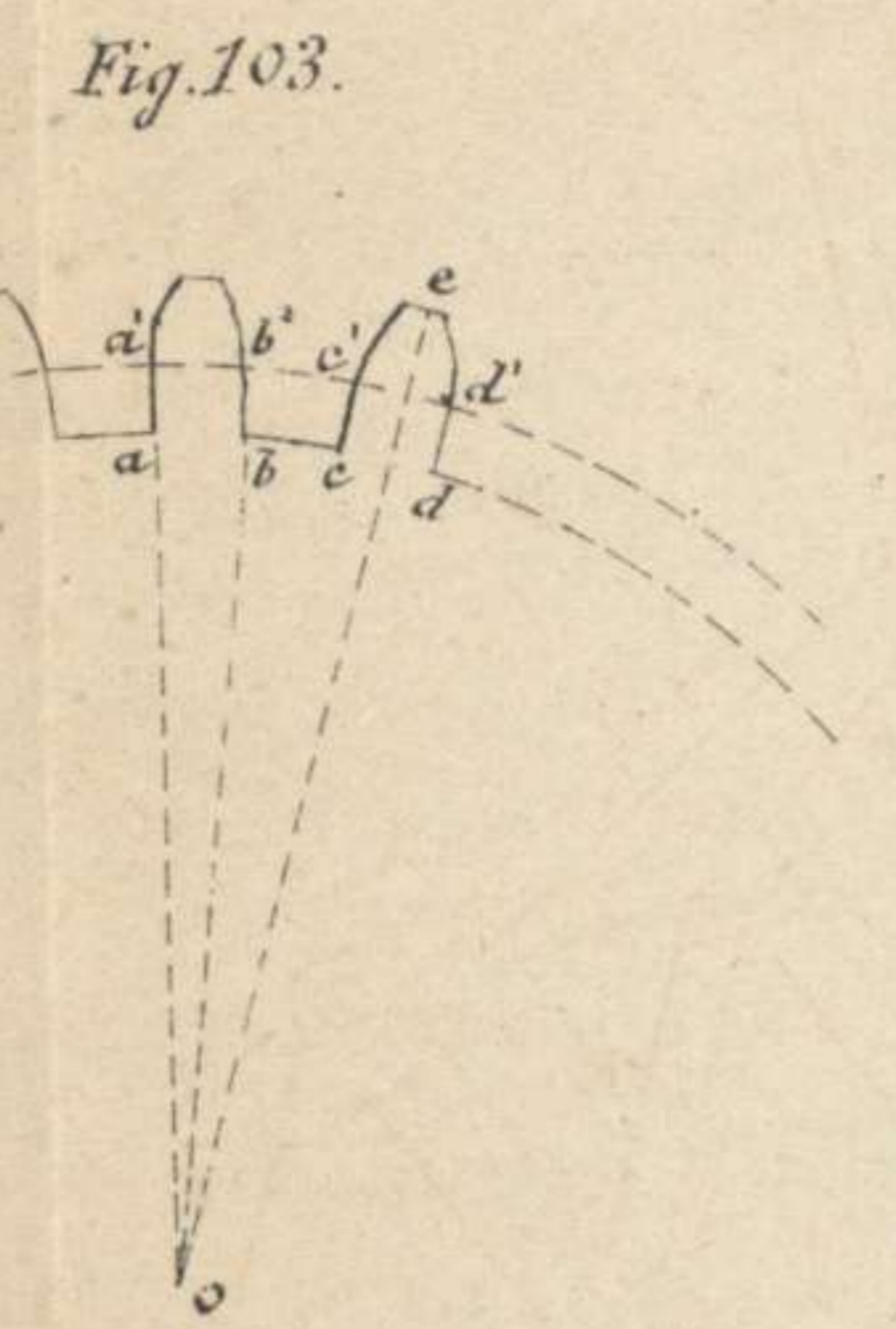
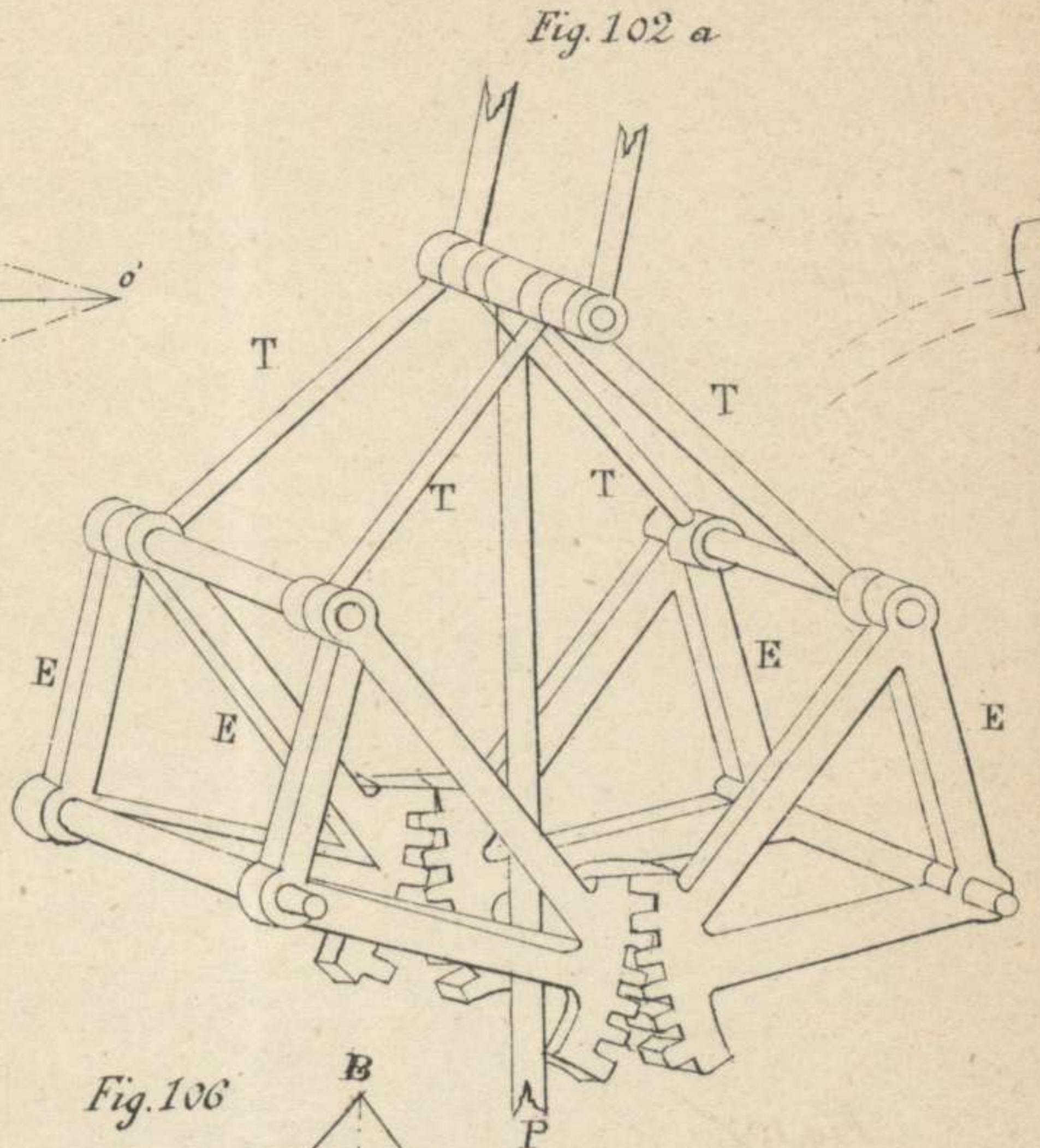
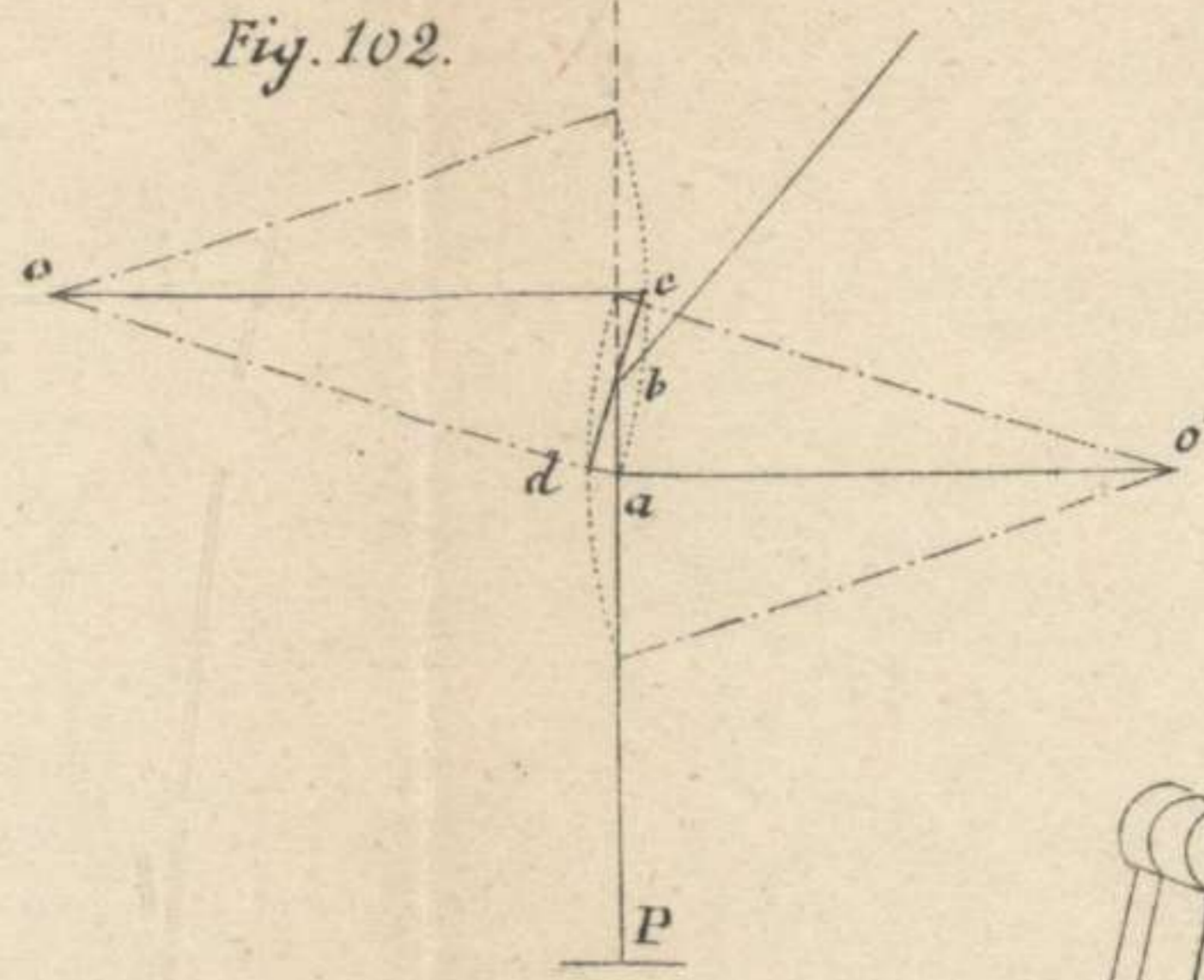
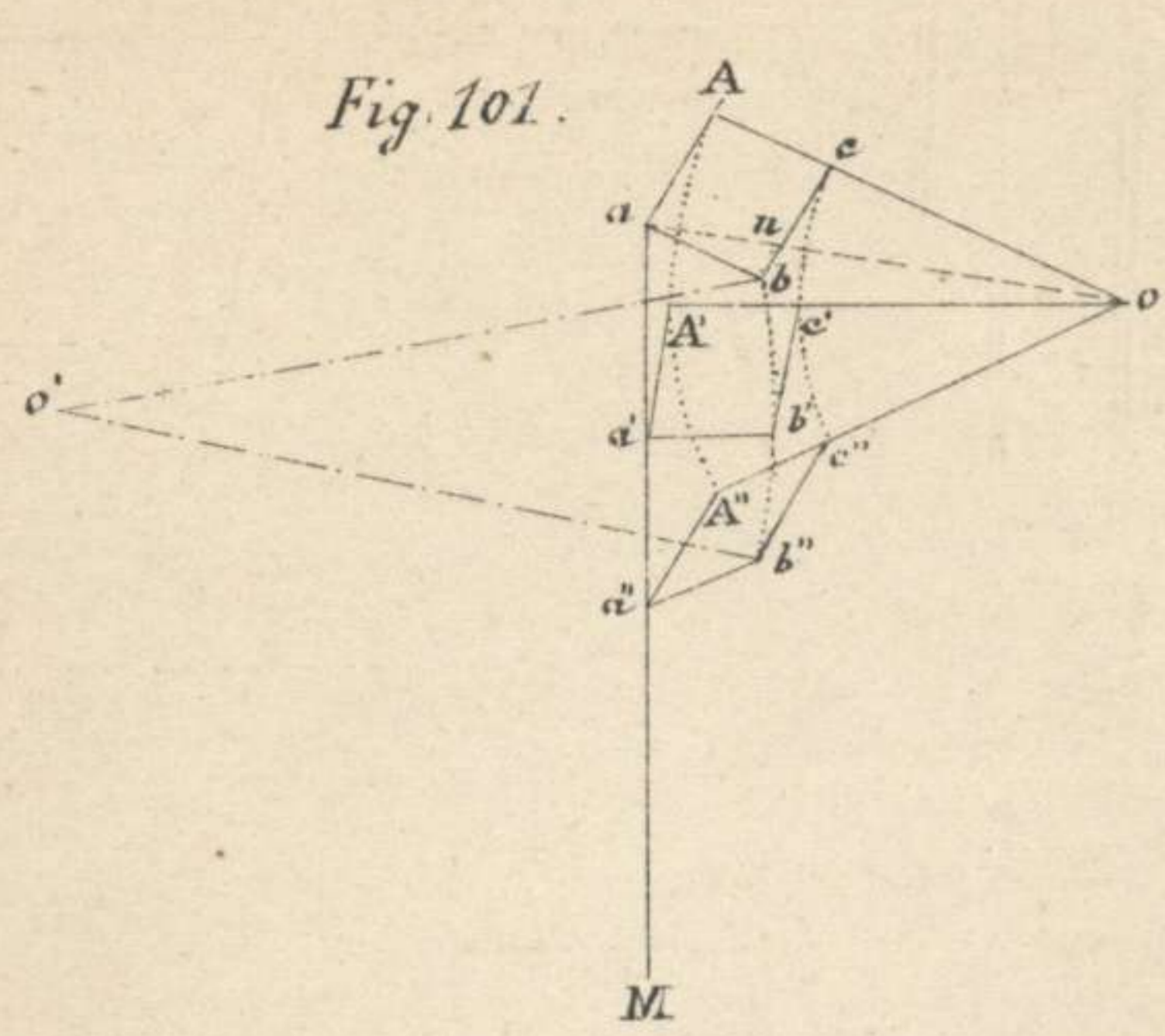
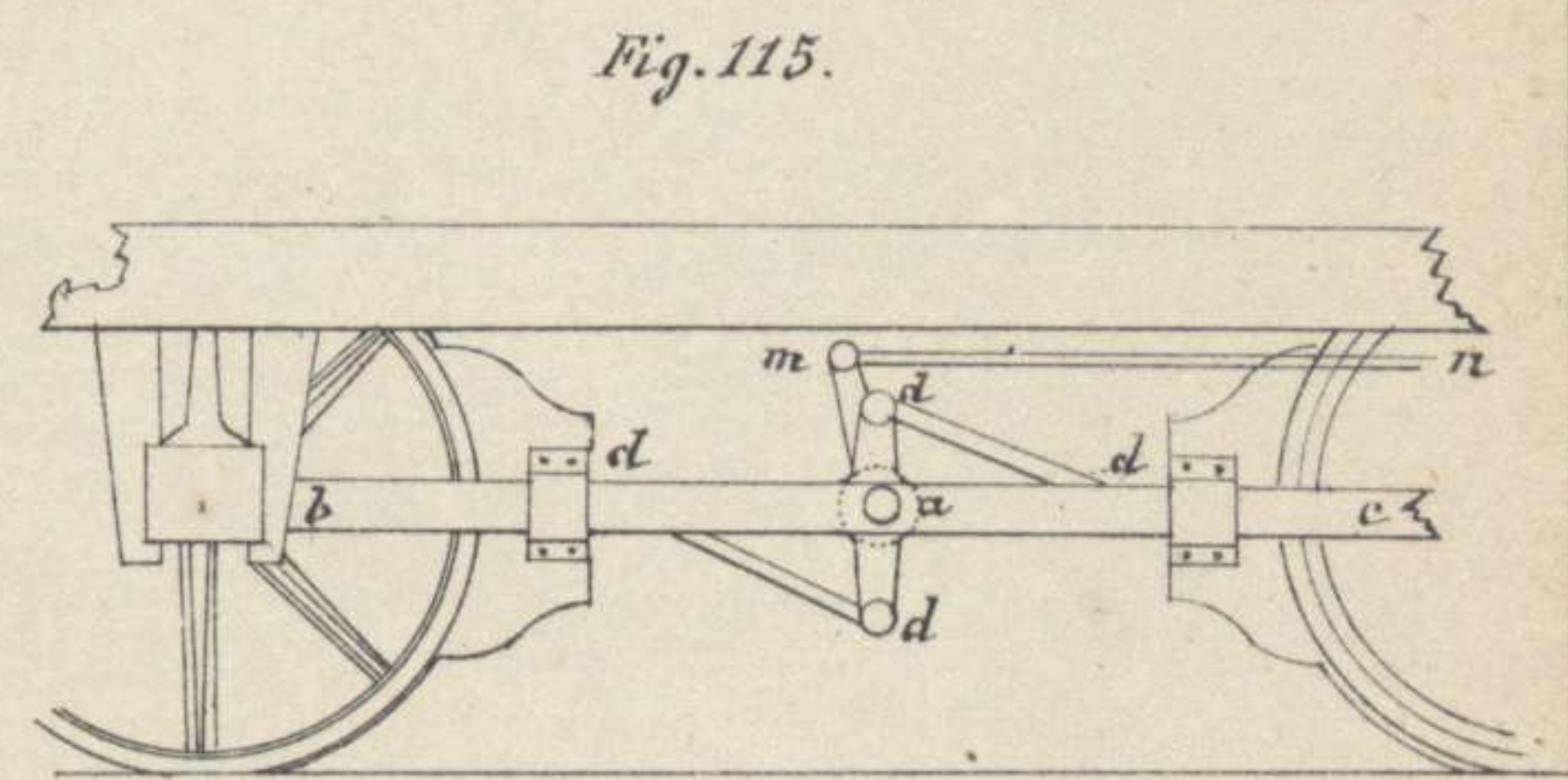
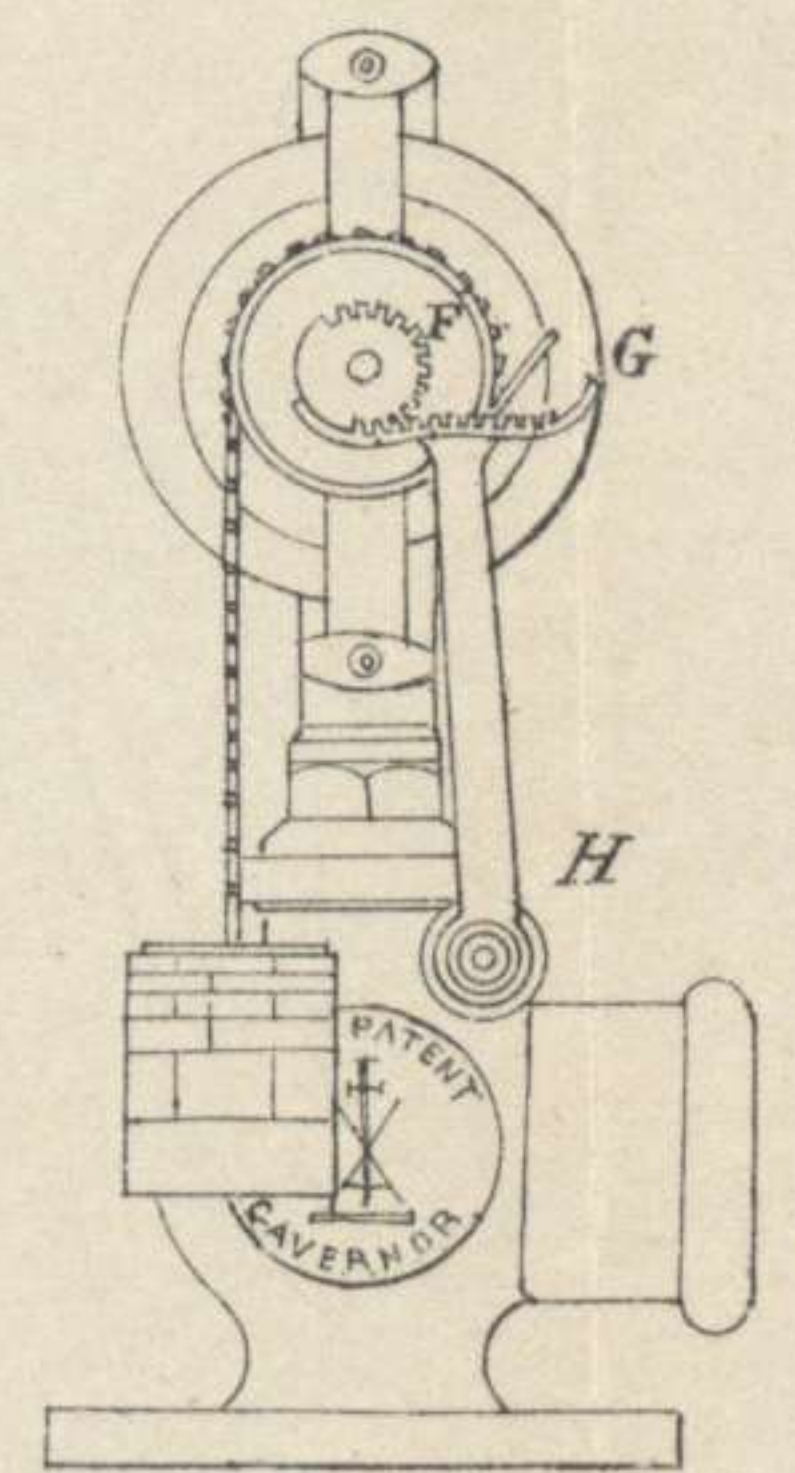
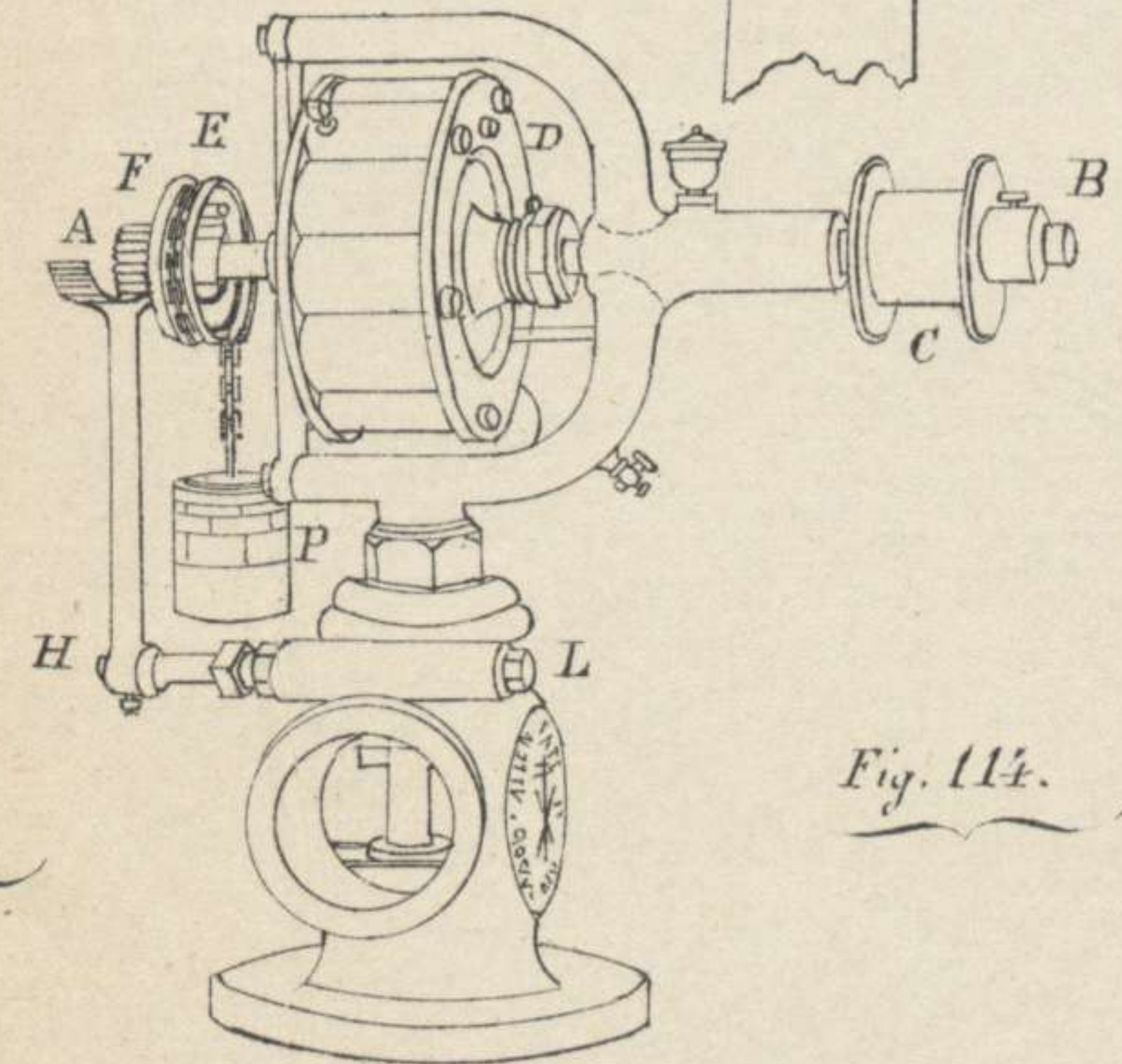
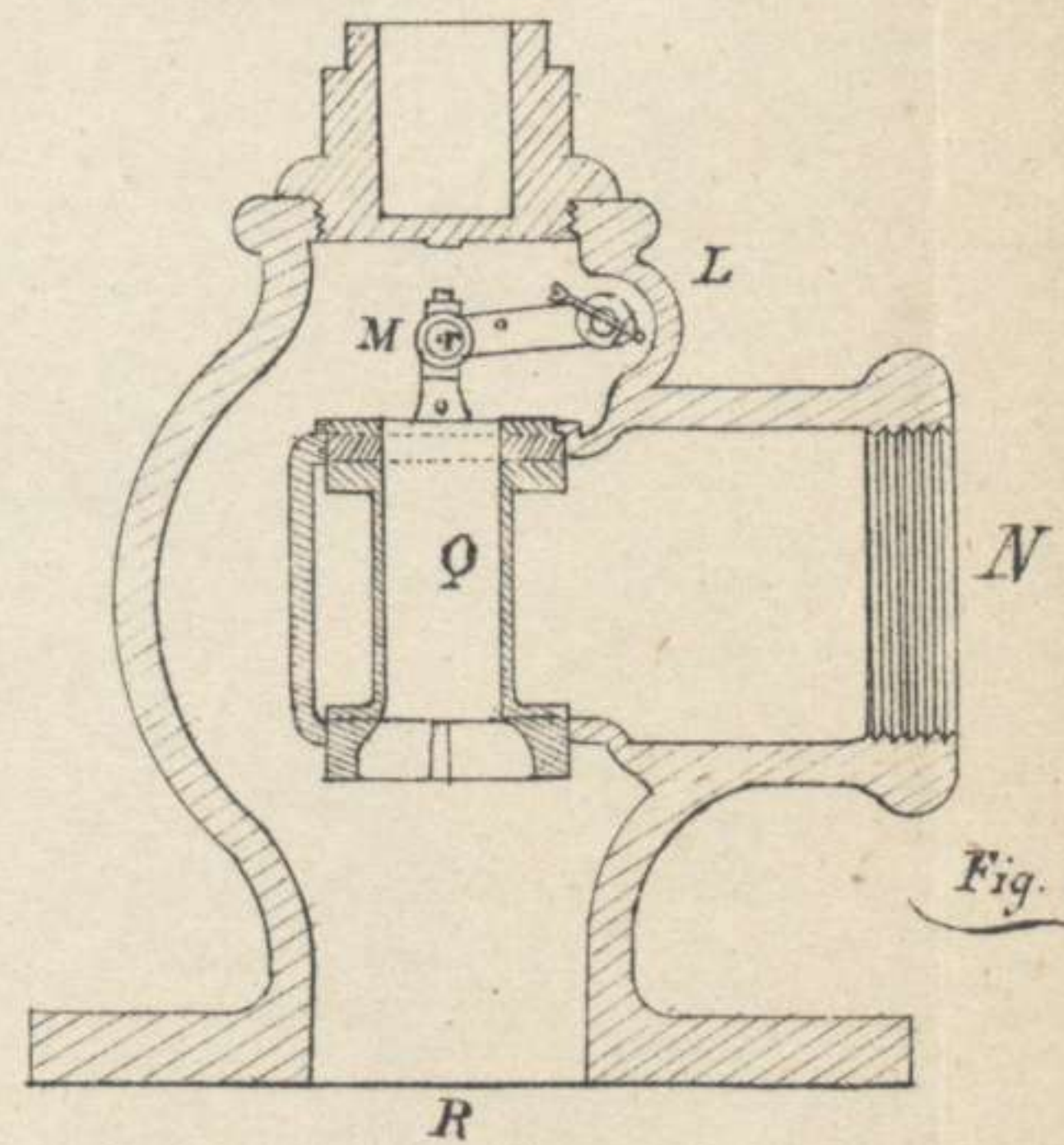
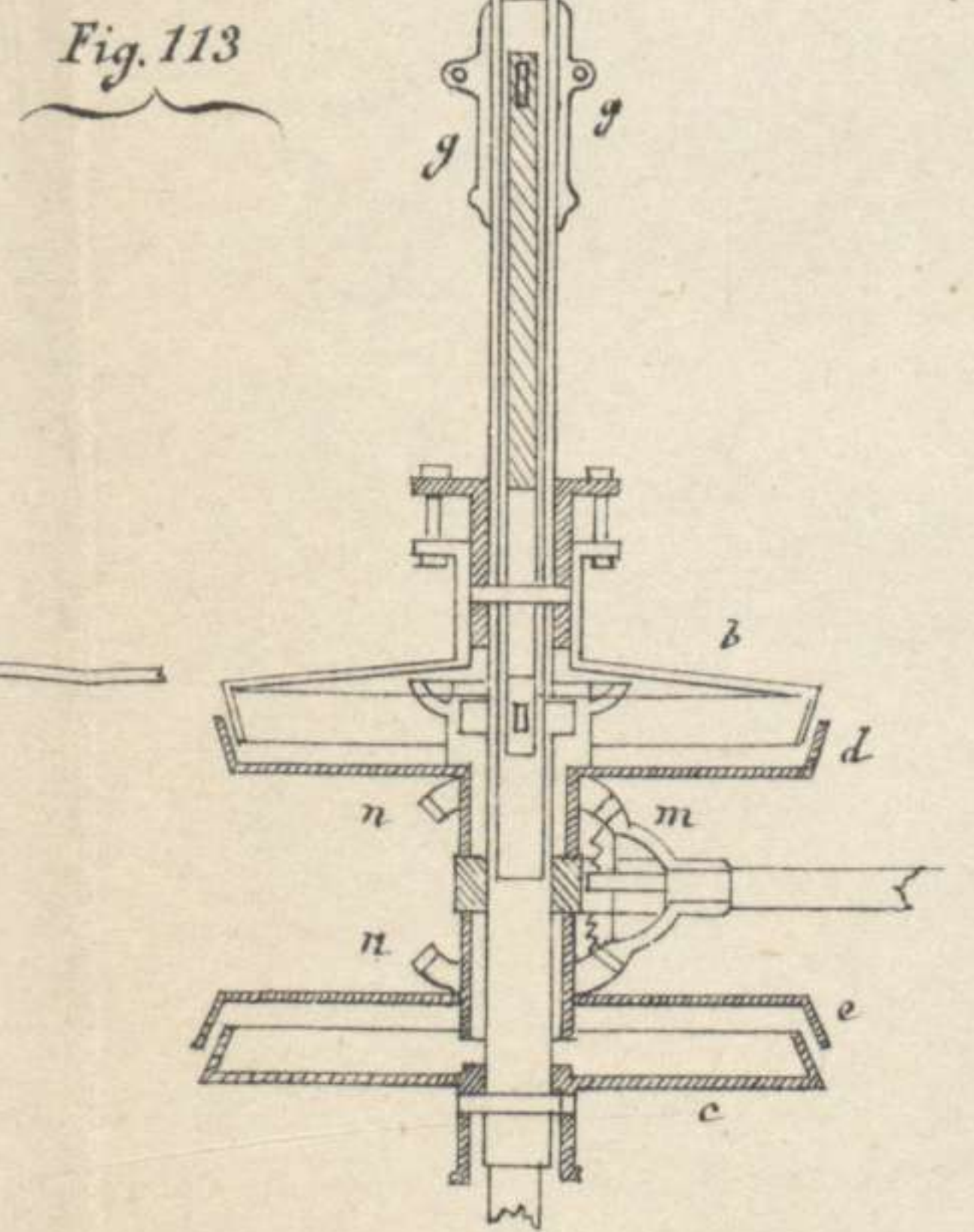
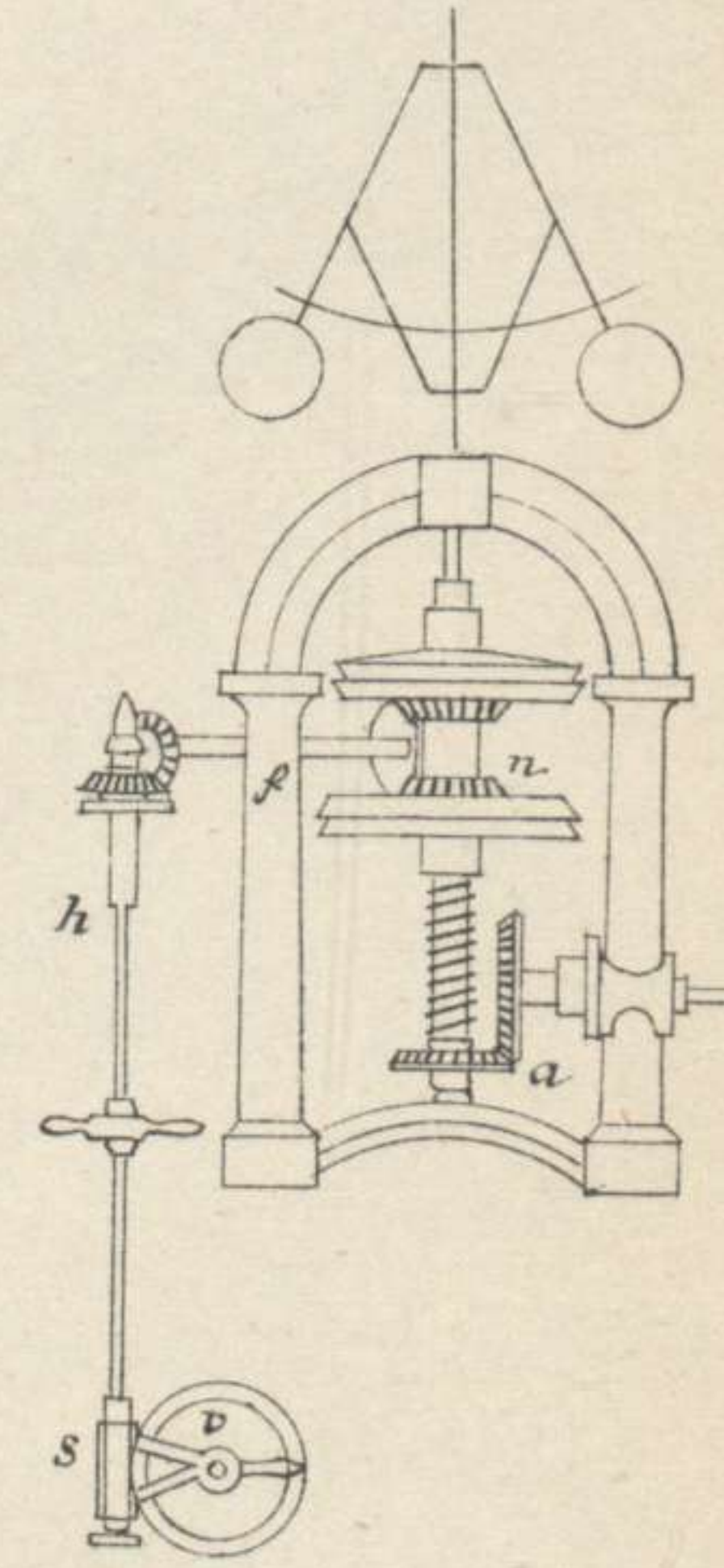
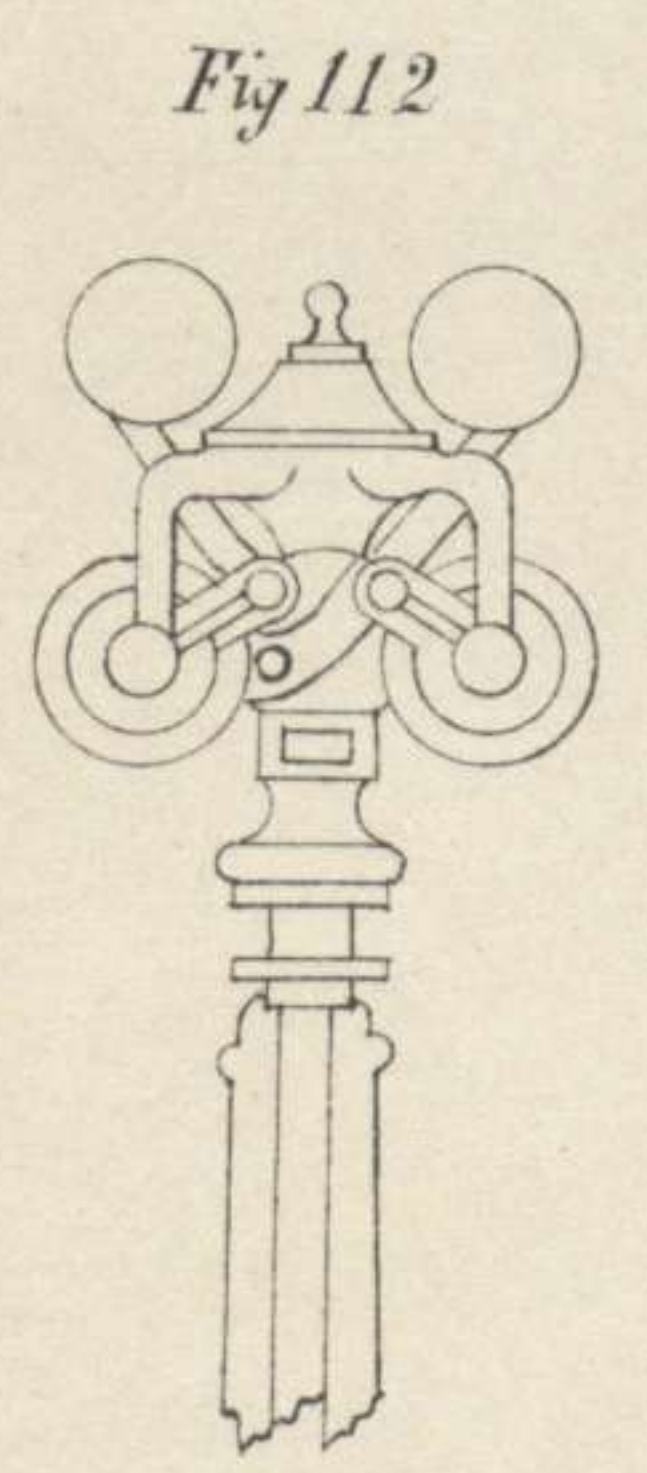
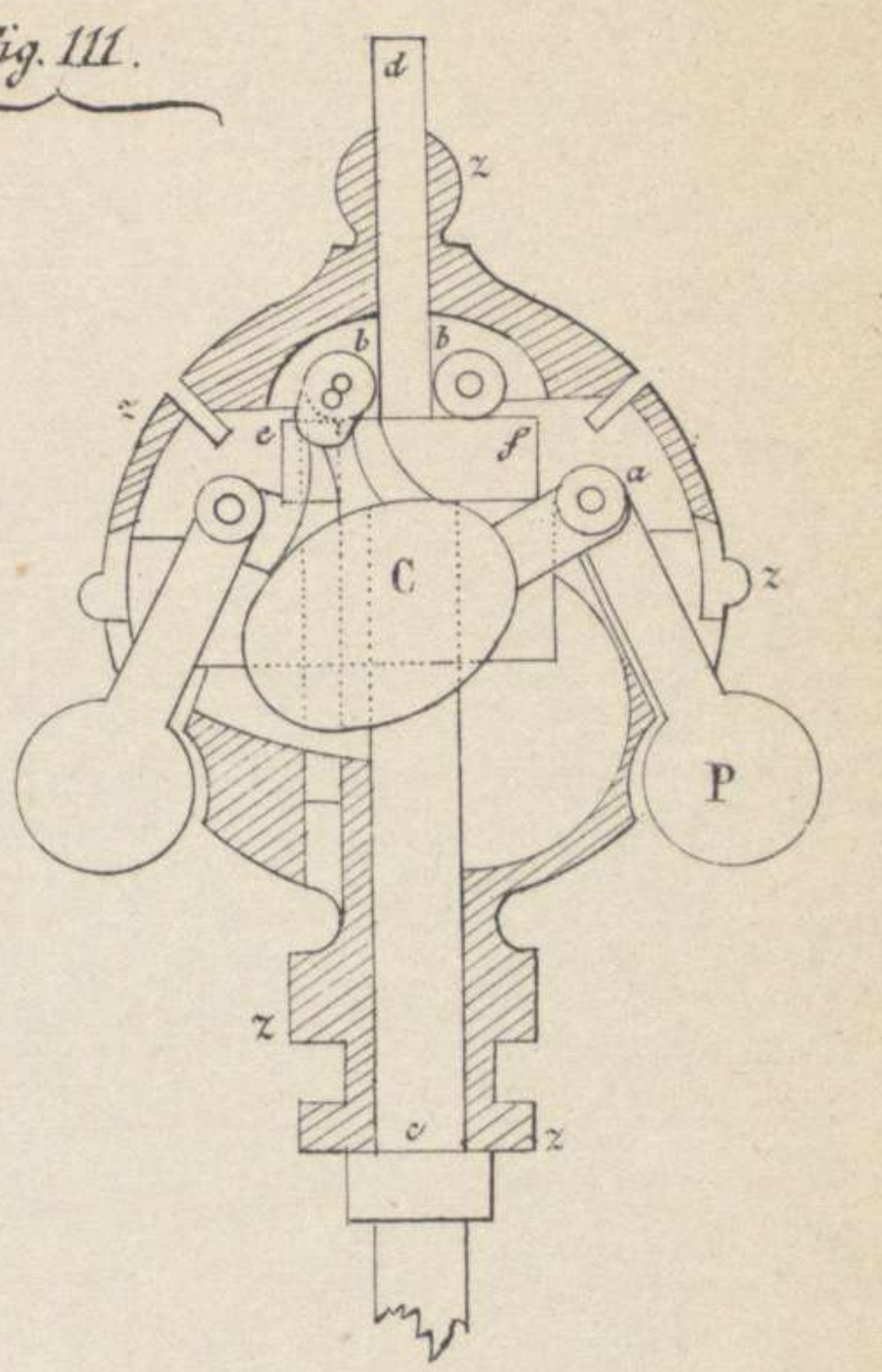
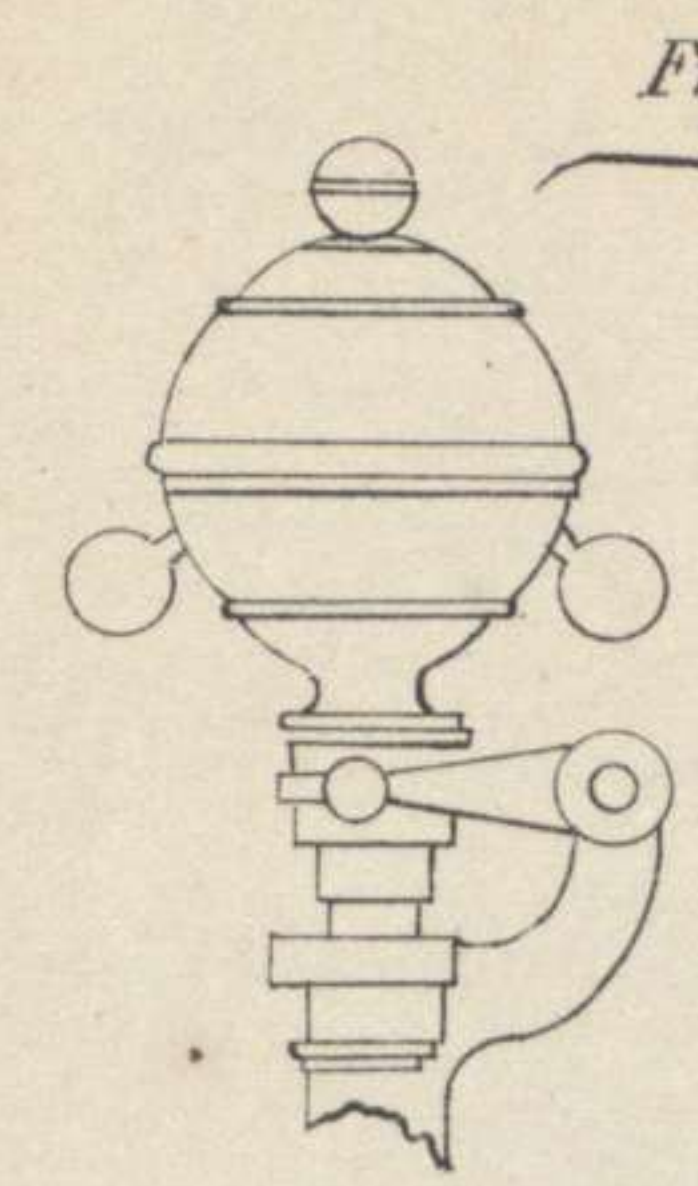
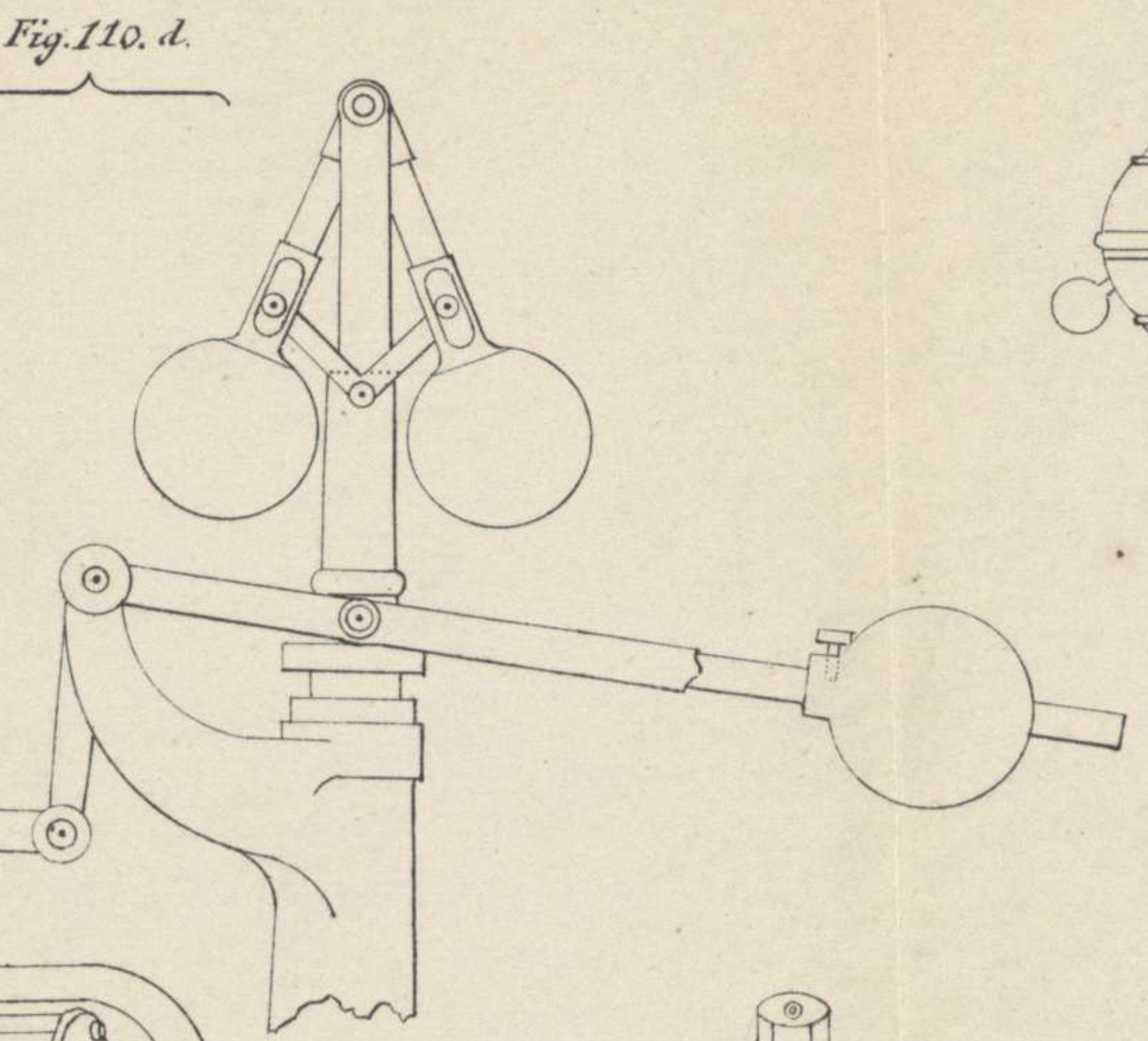
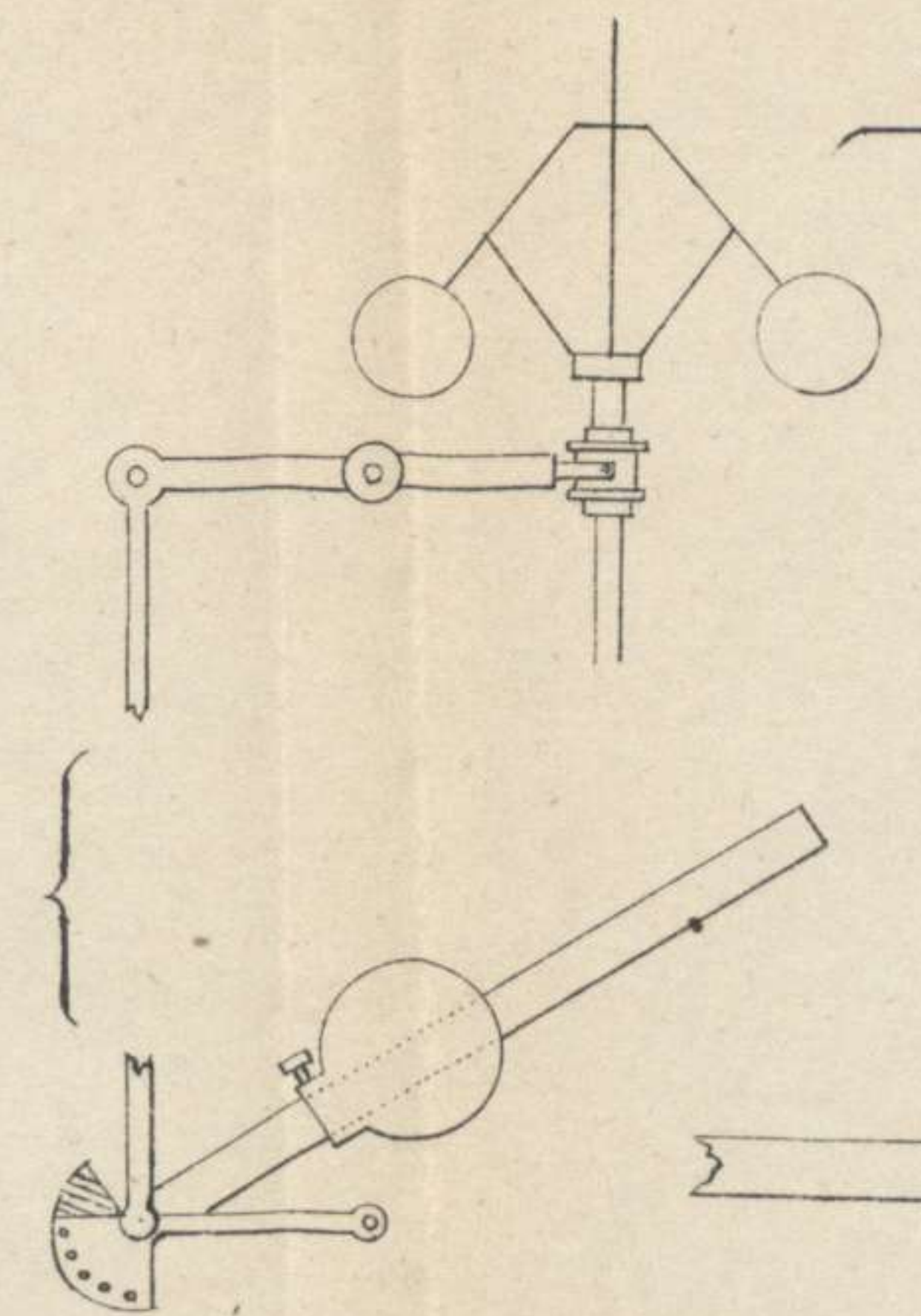
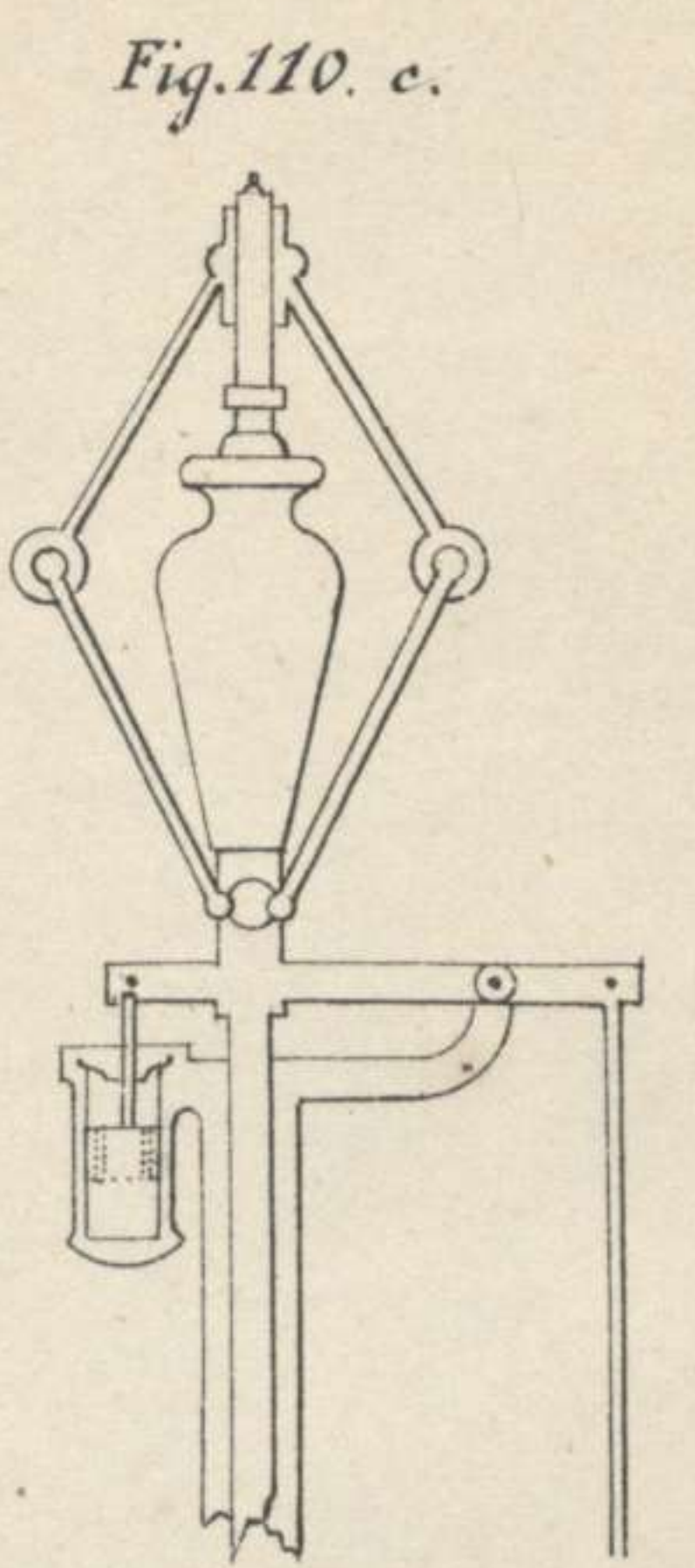
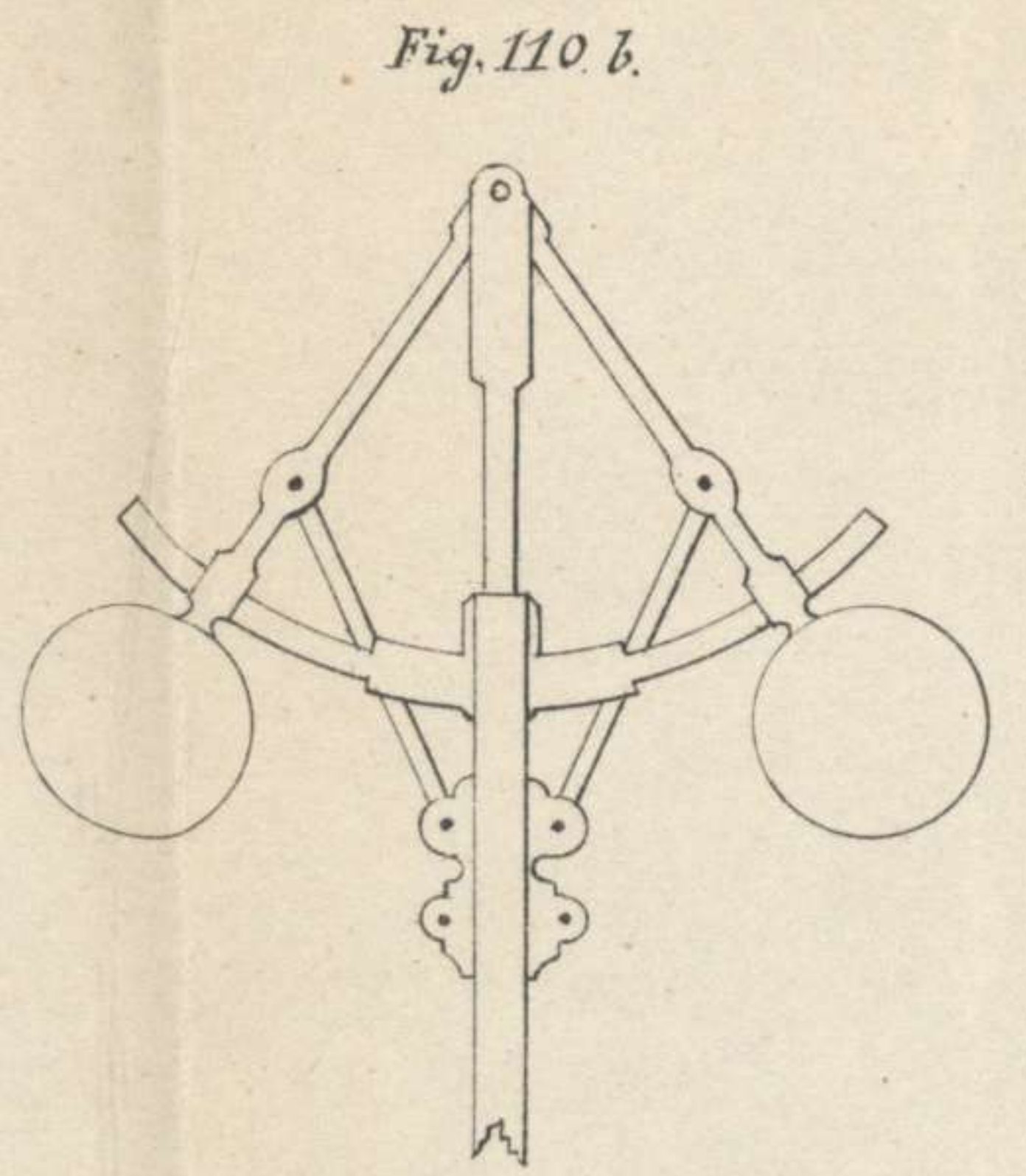
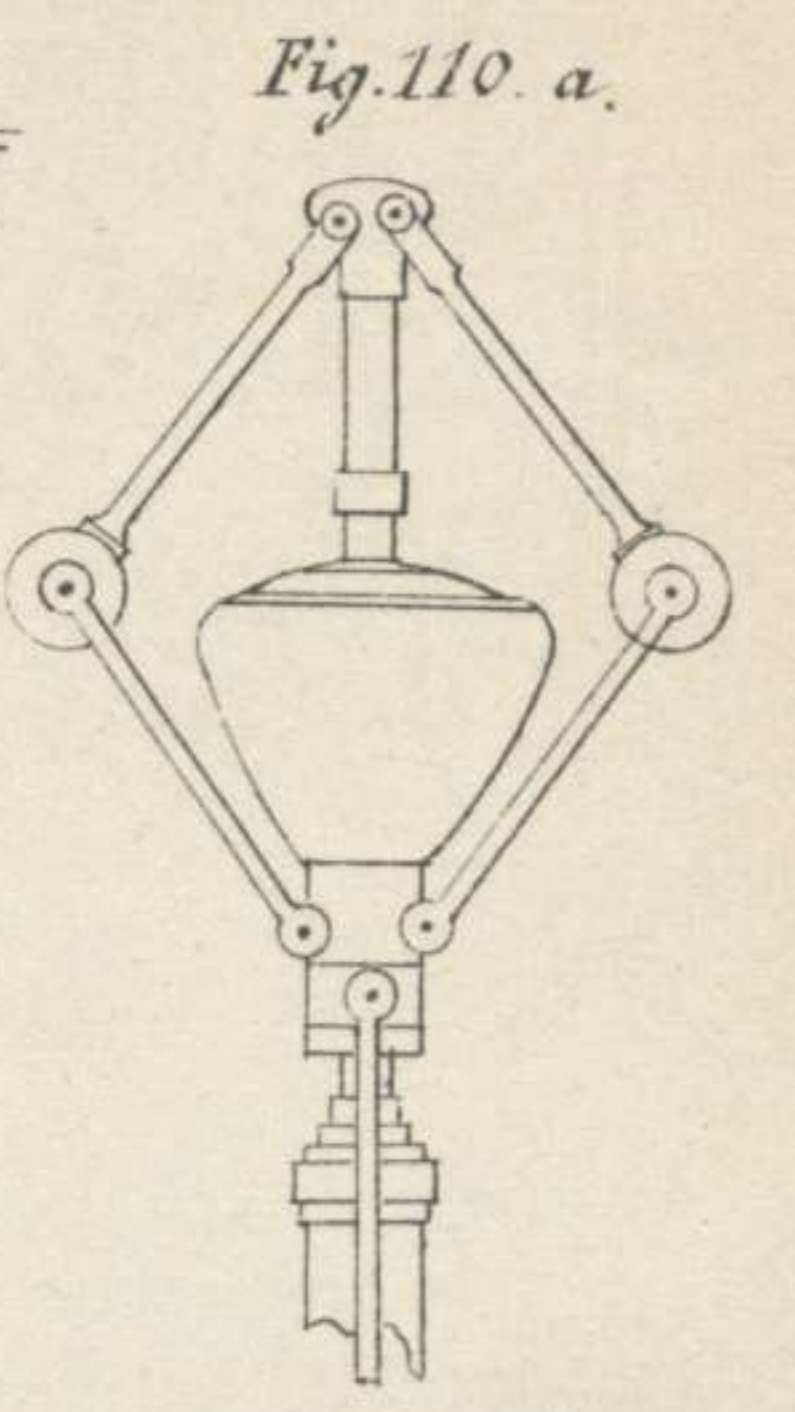
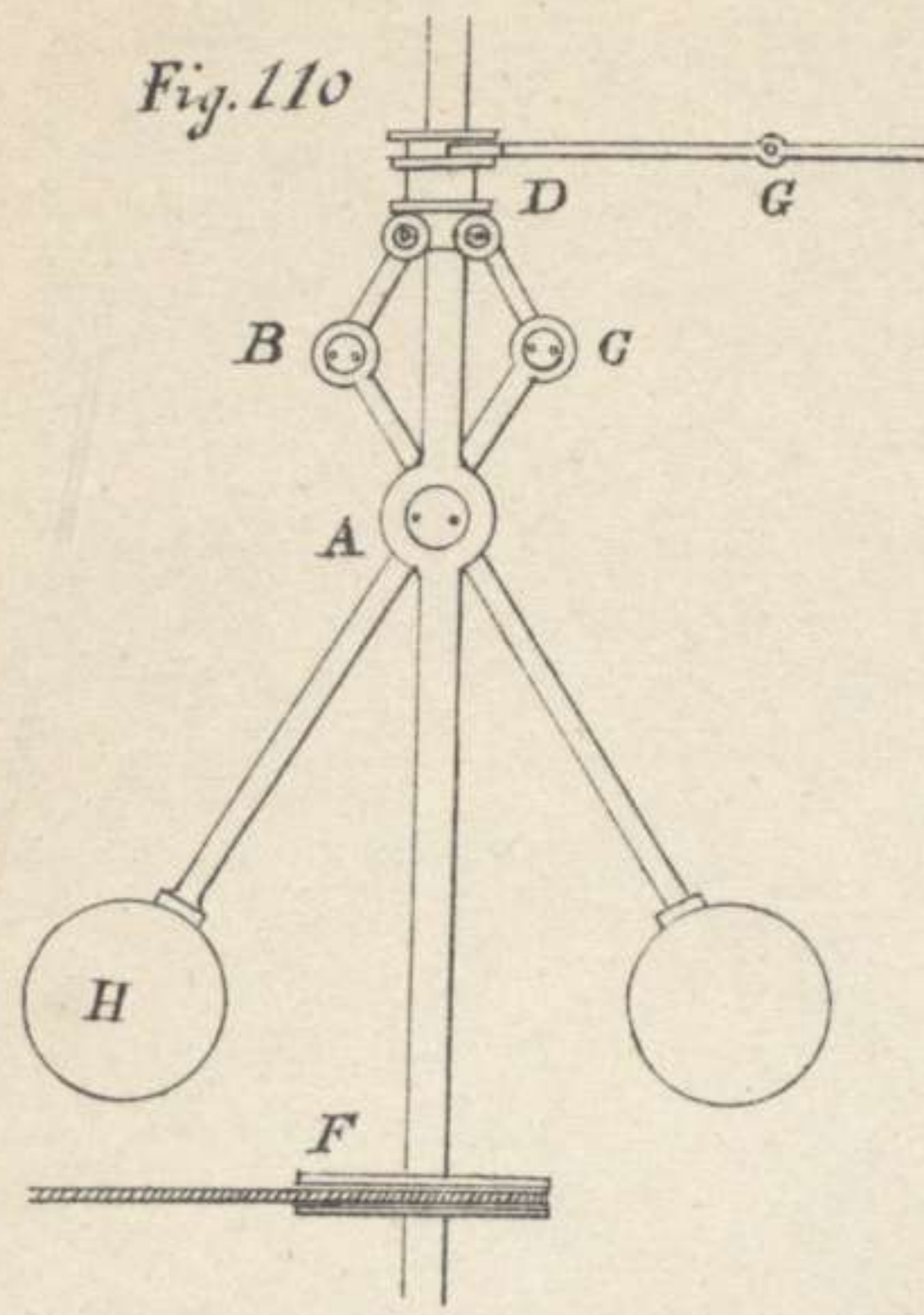

Fig. 92.





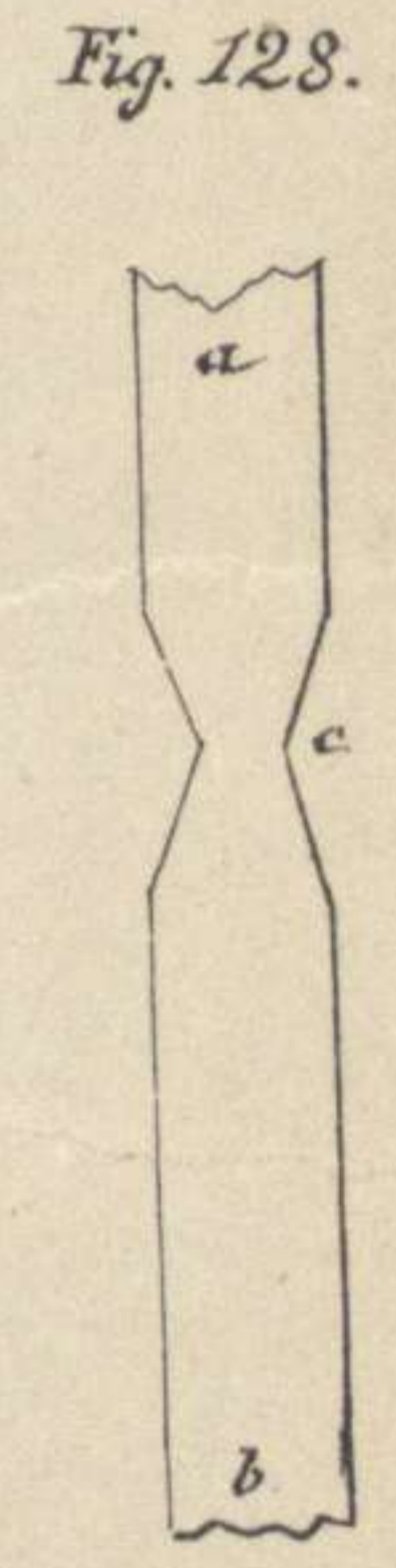
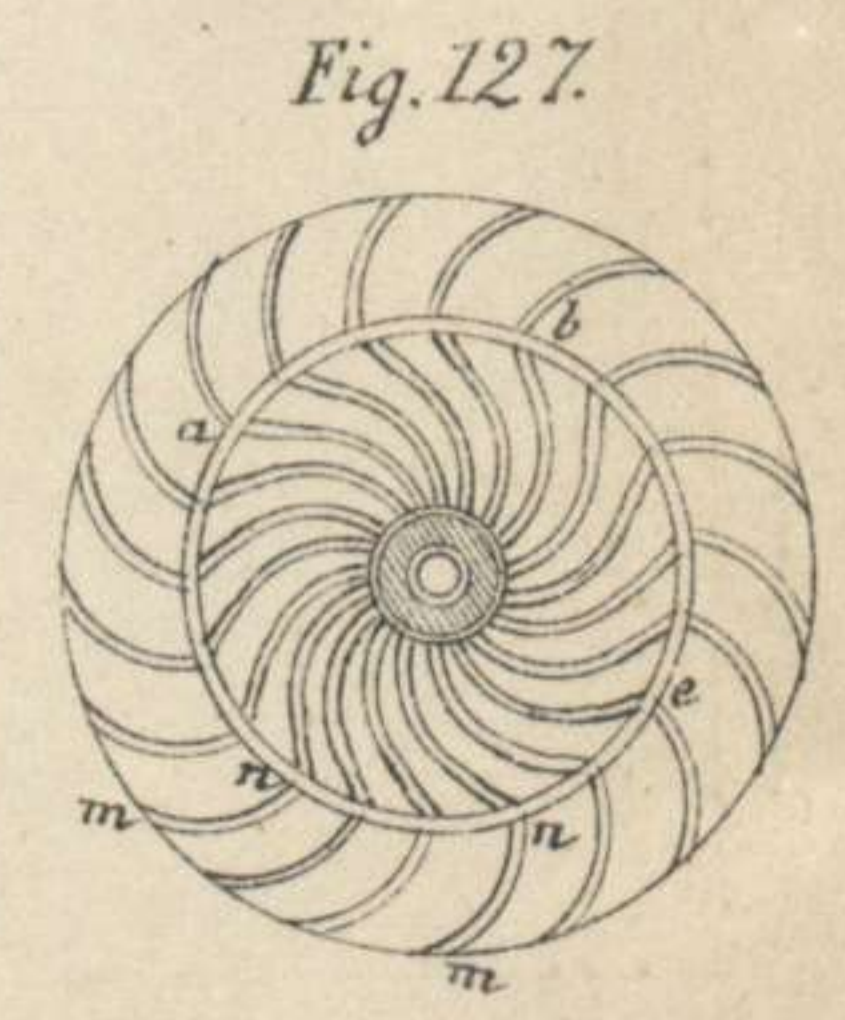
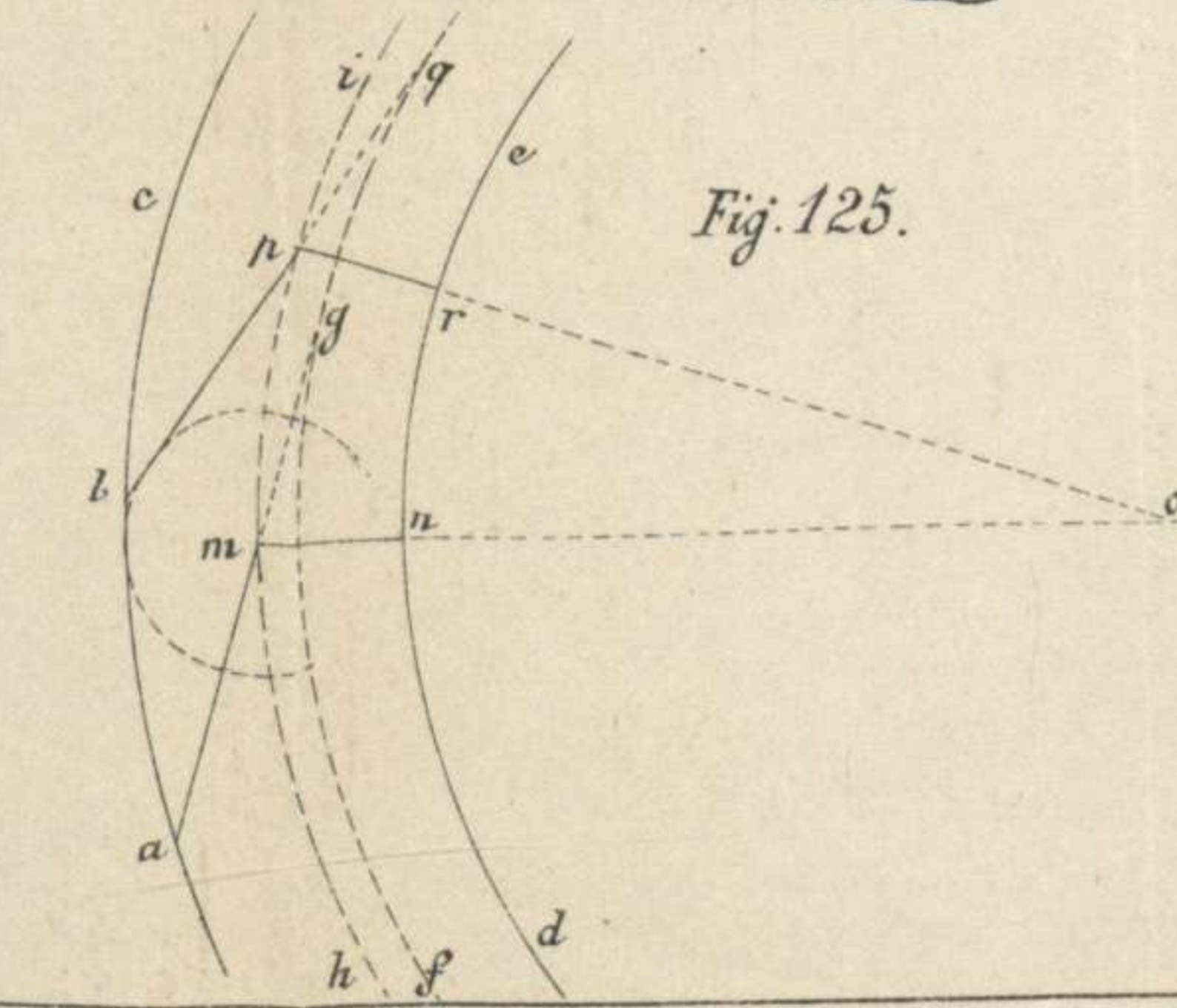
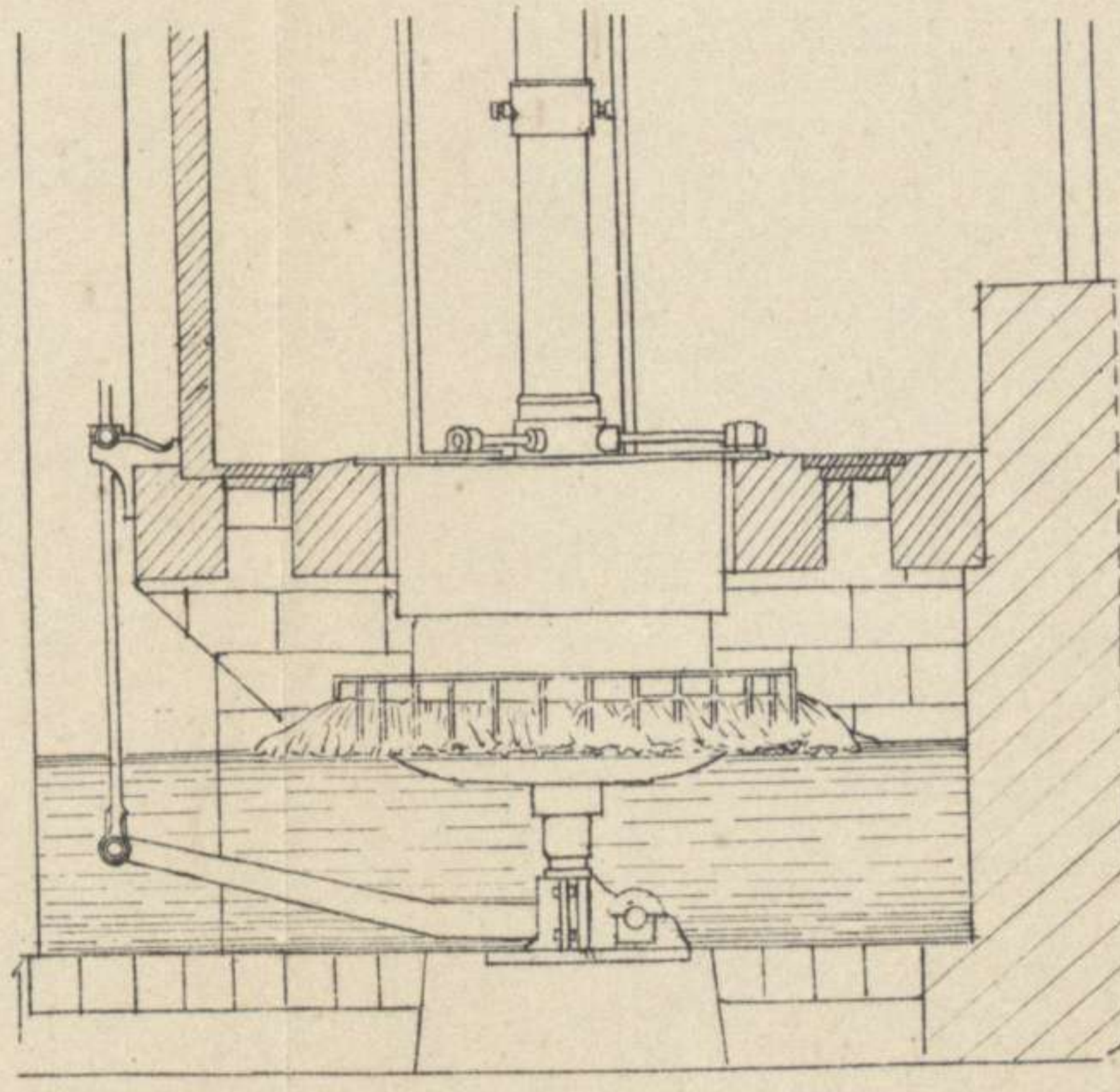
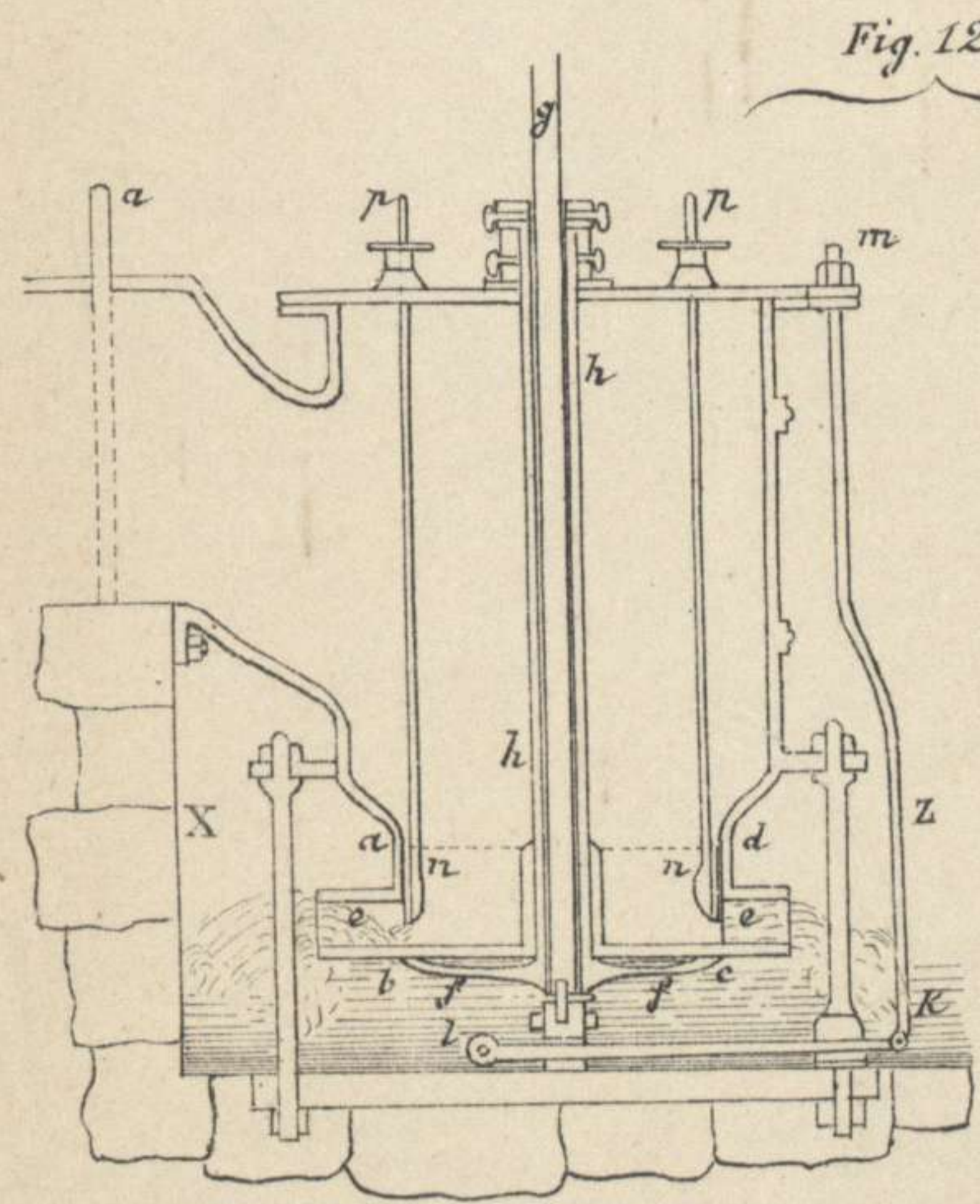
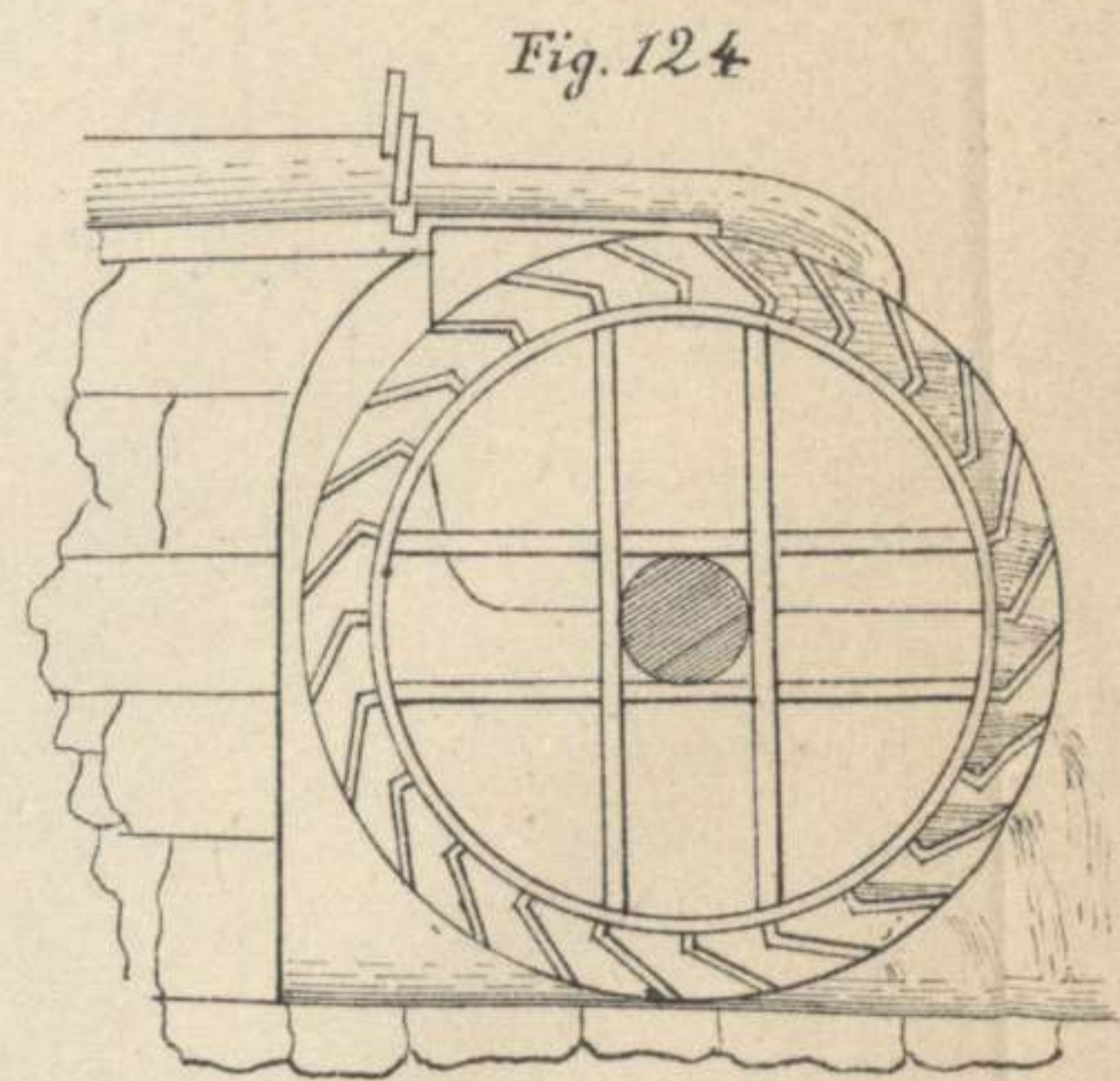
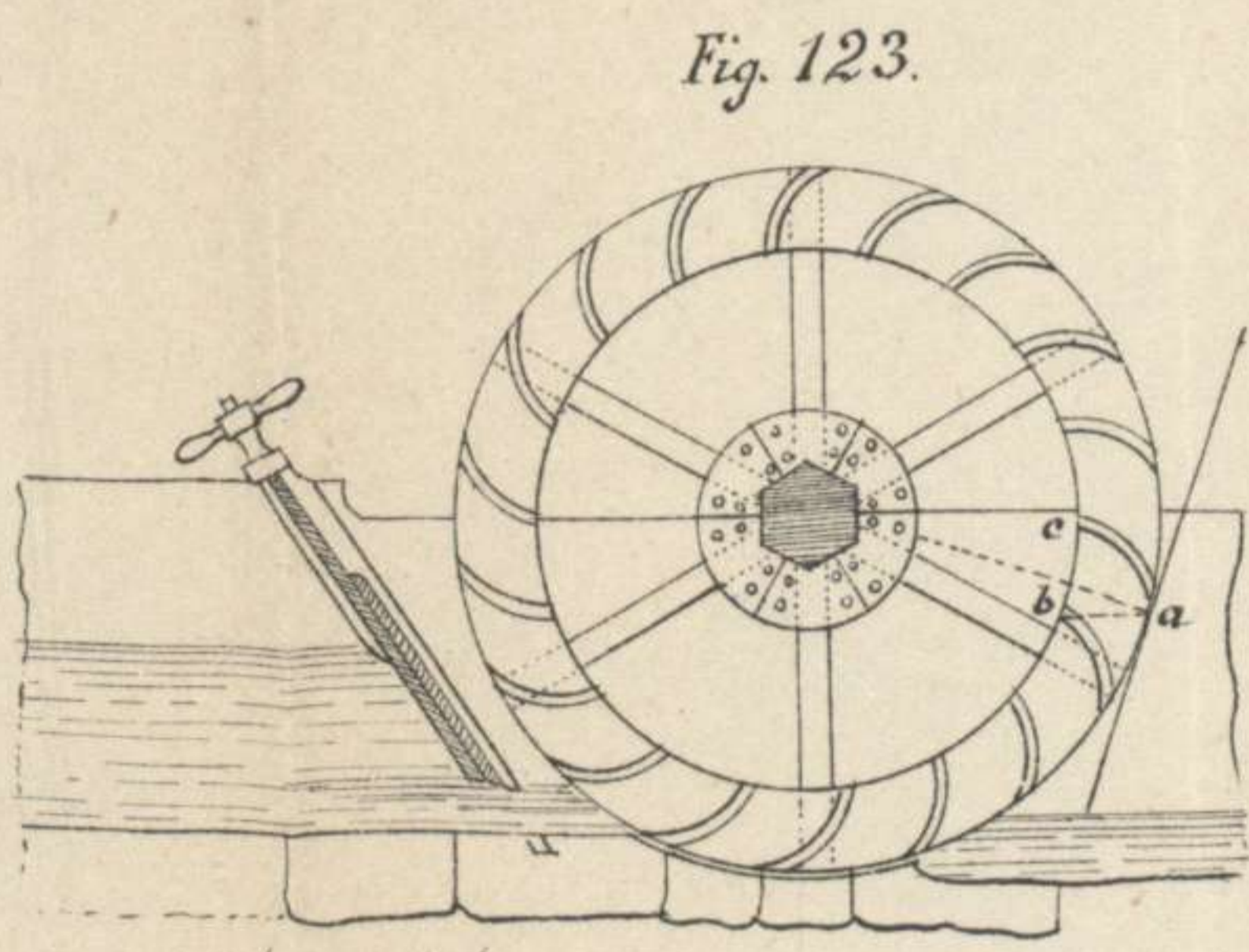
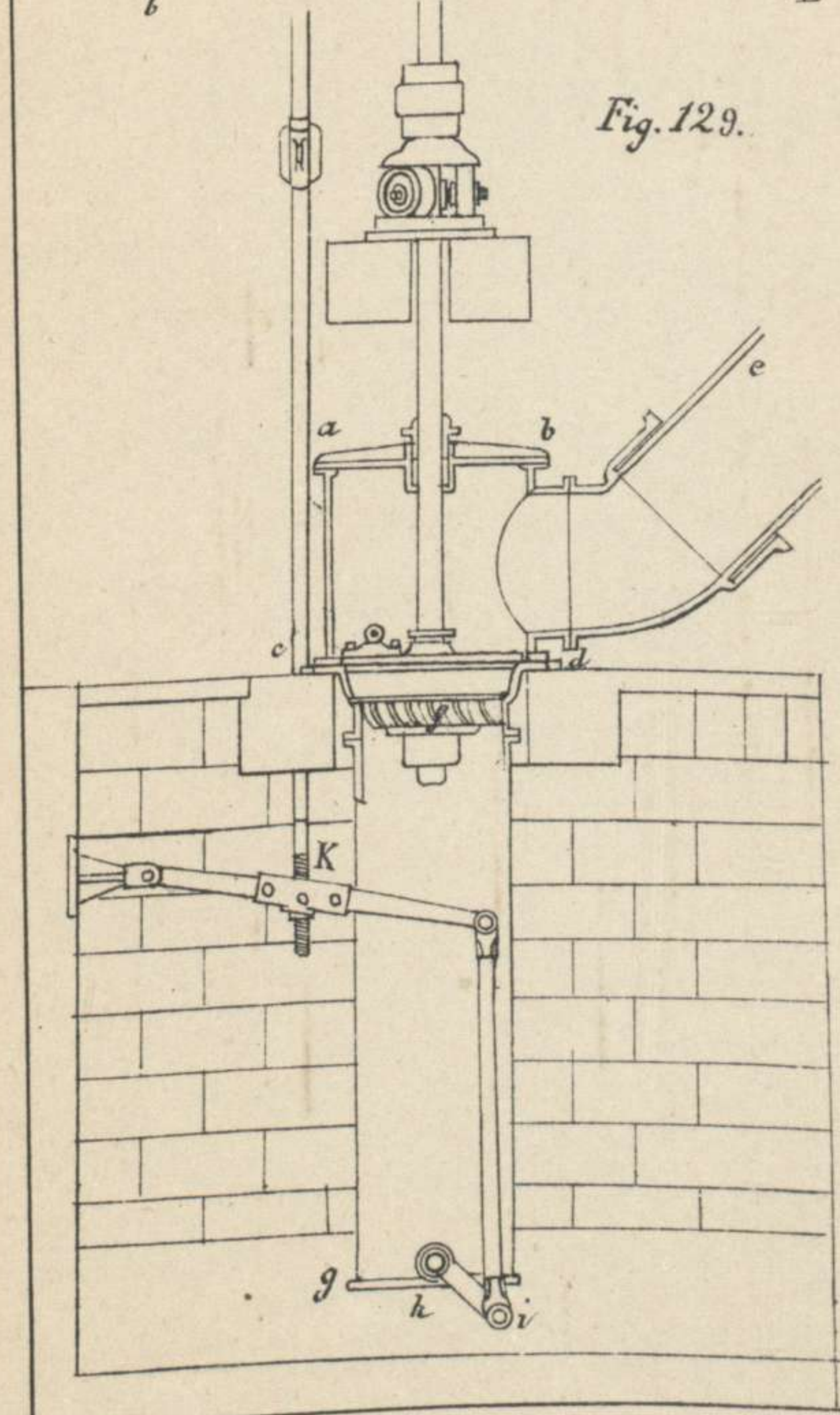
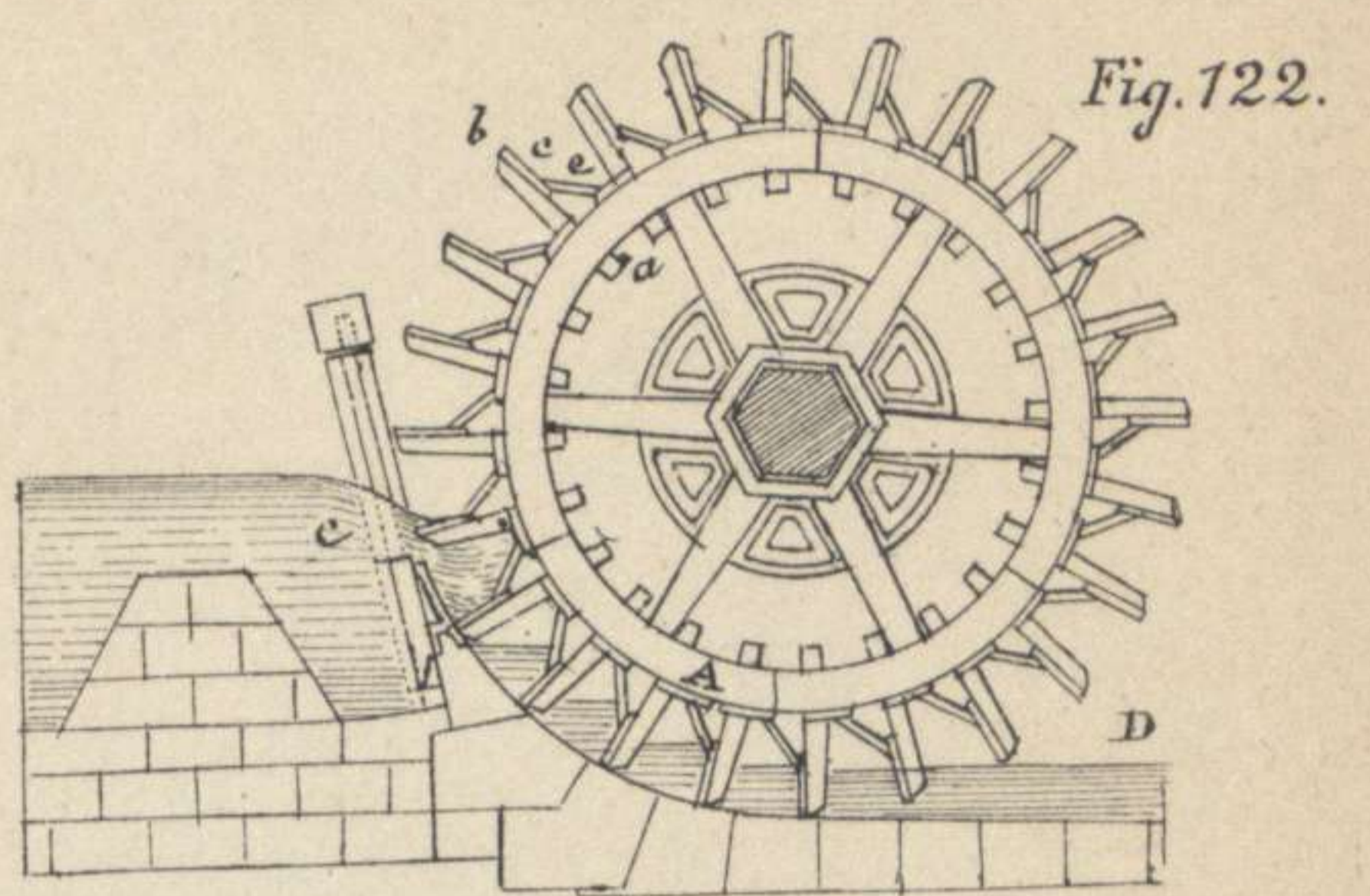
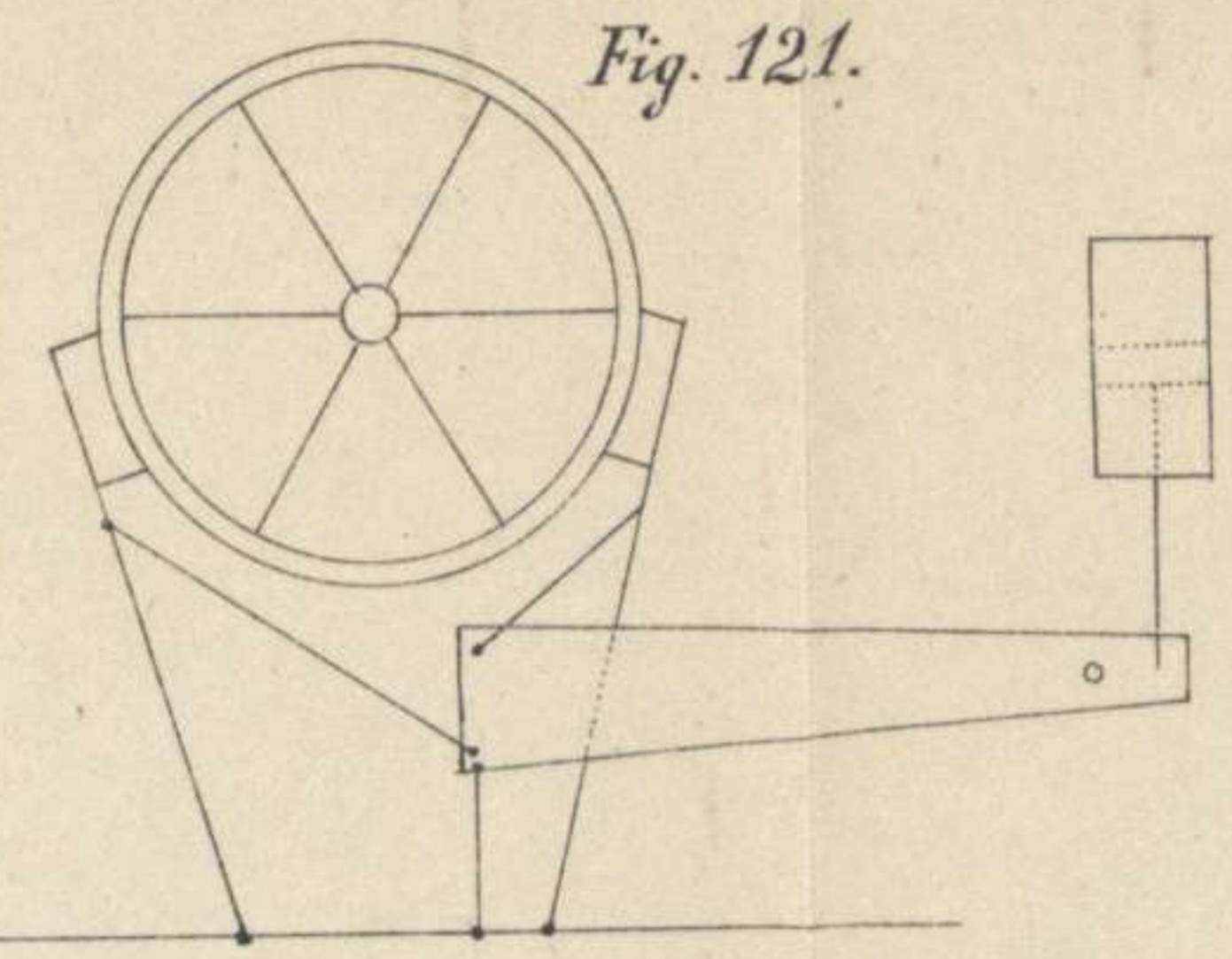
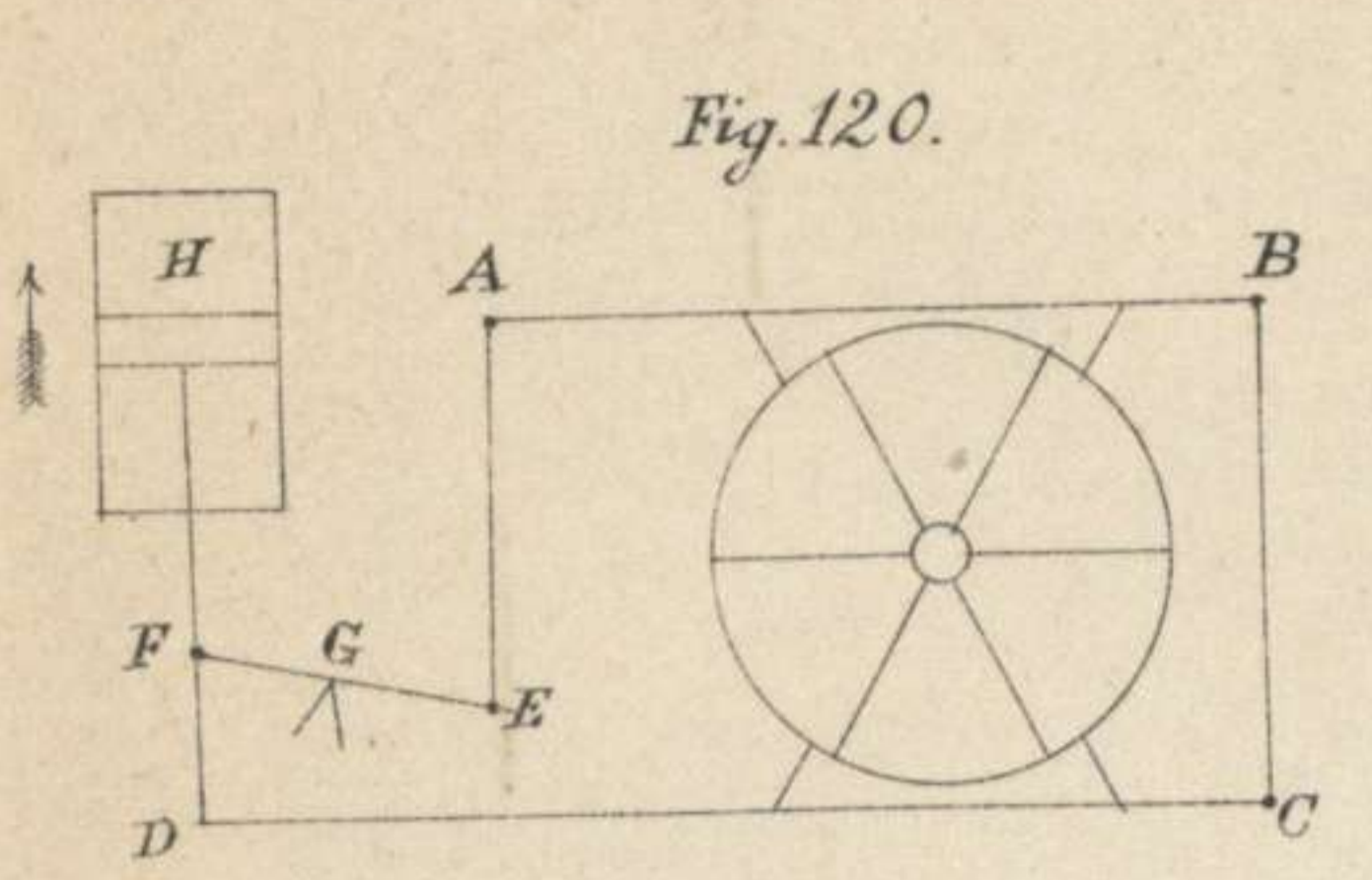
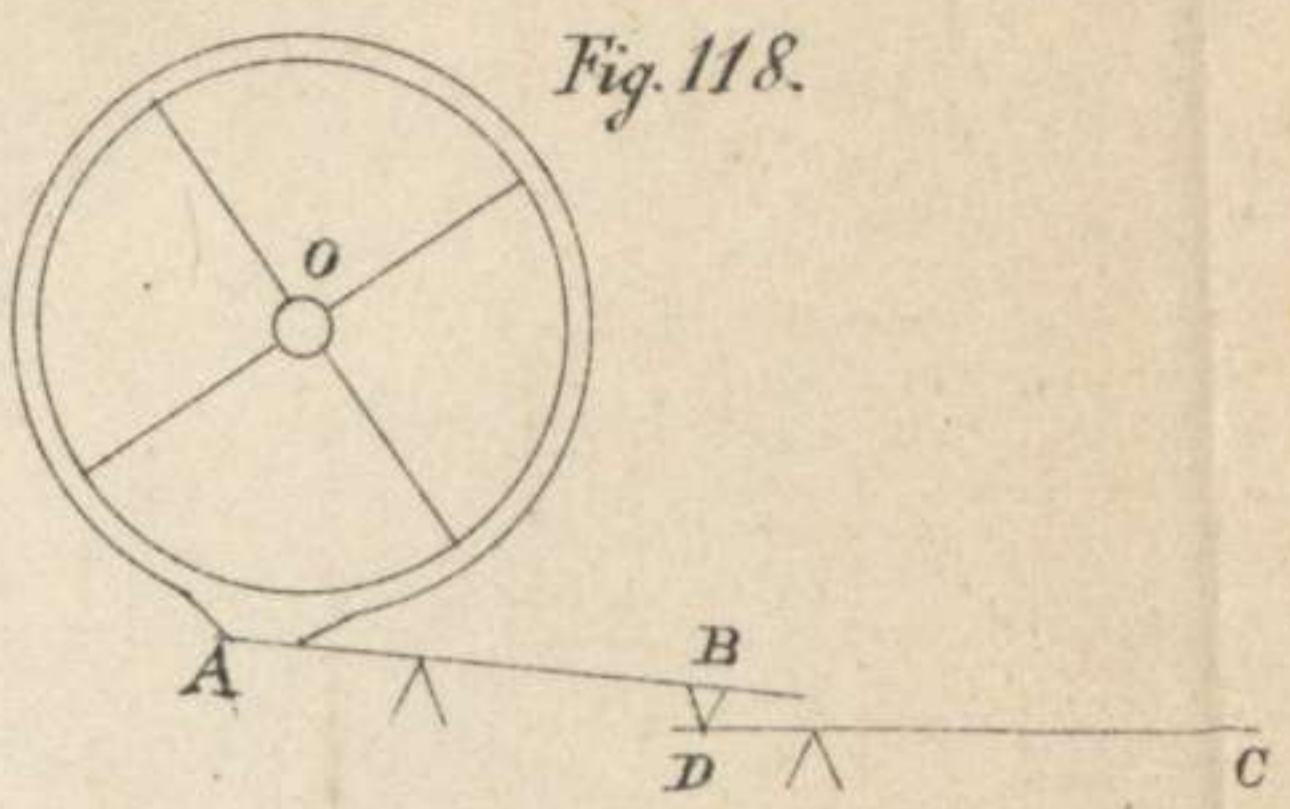
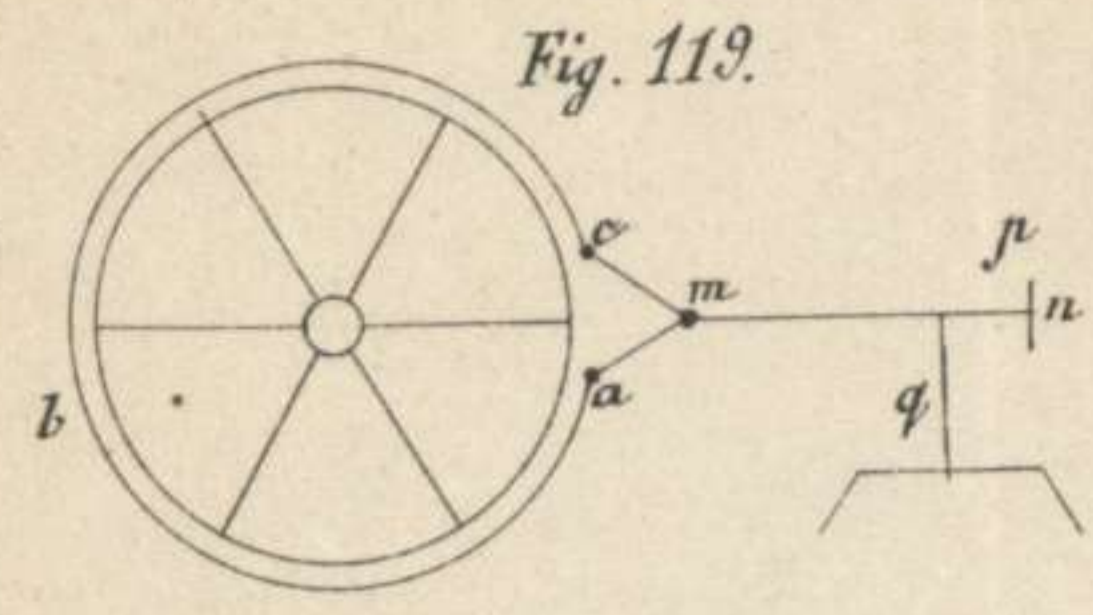
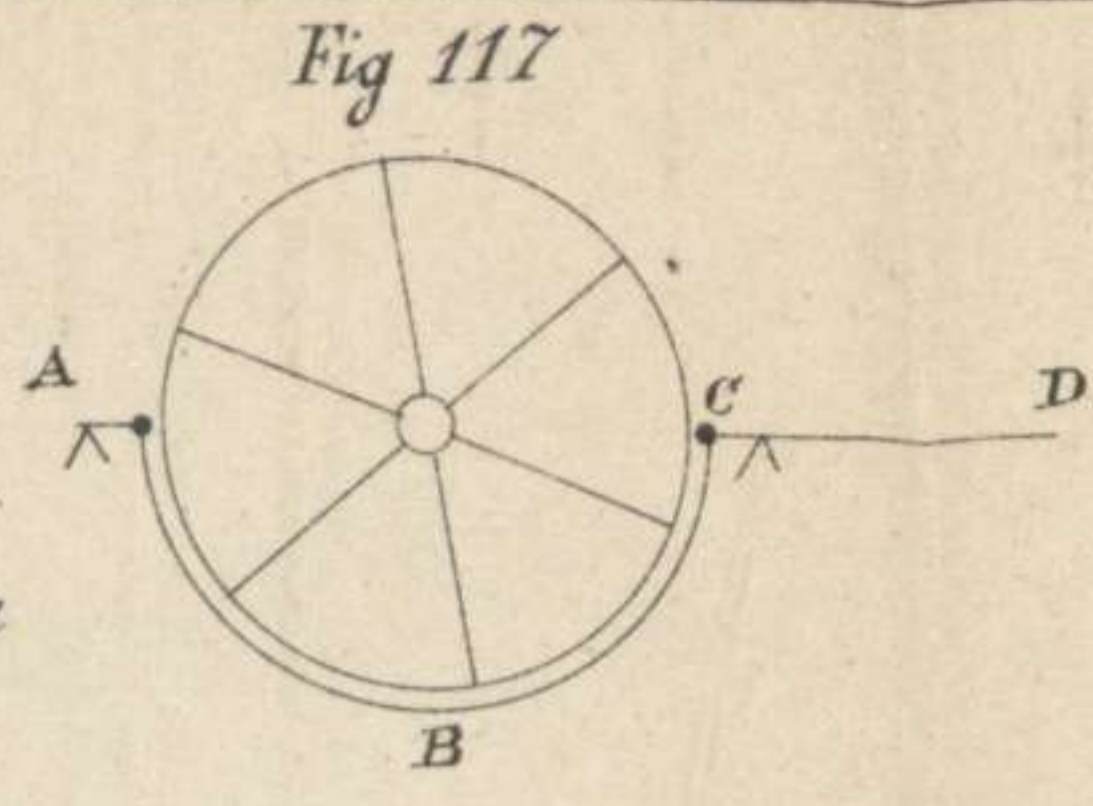
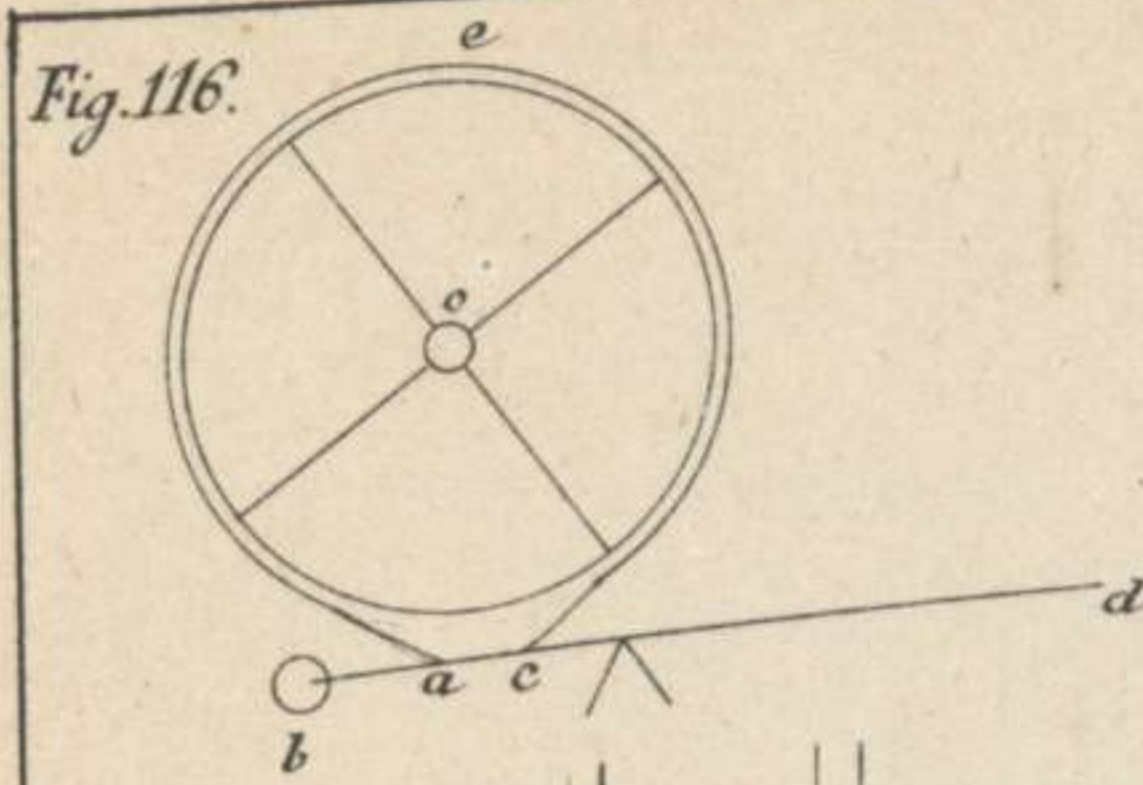

Fig. 130.

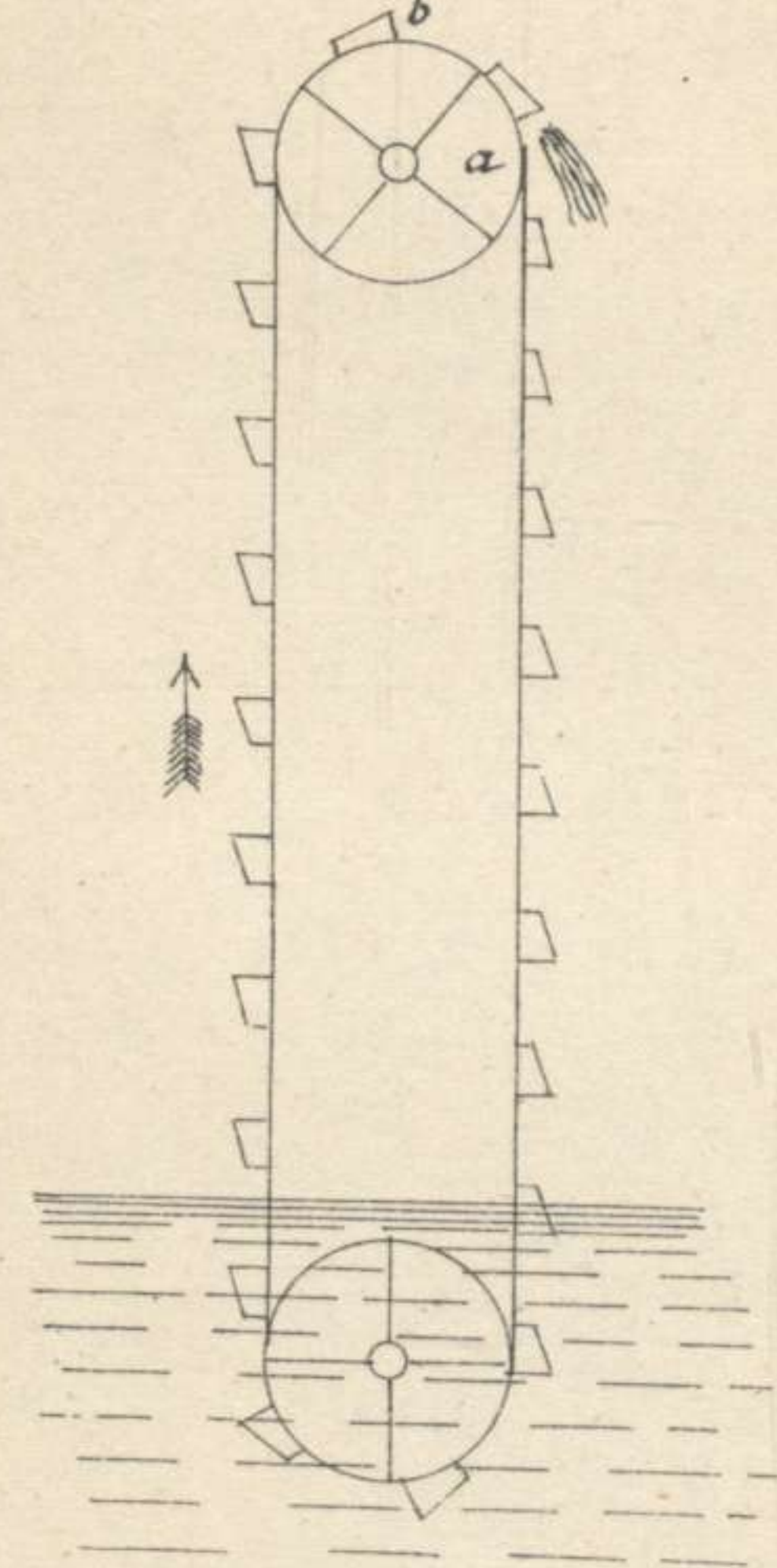

Fig. 131.

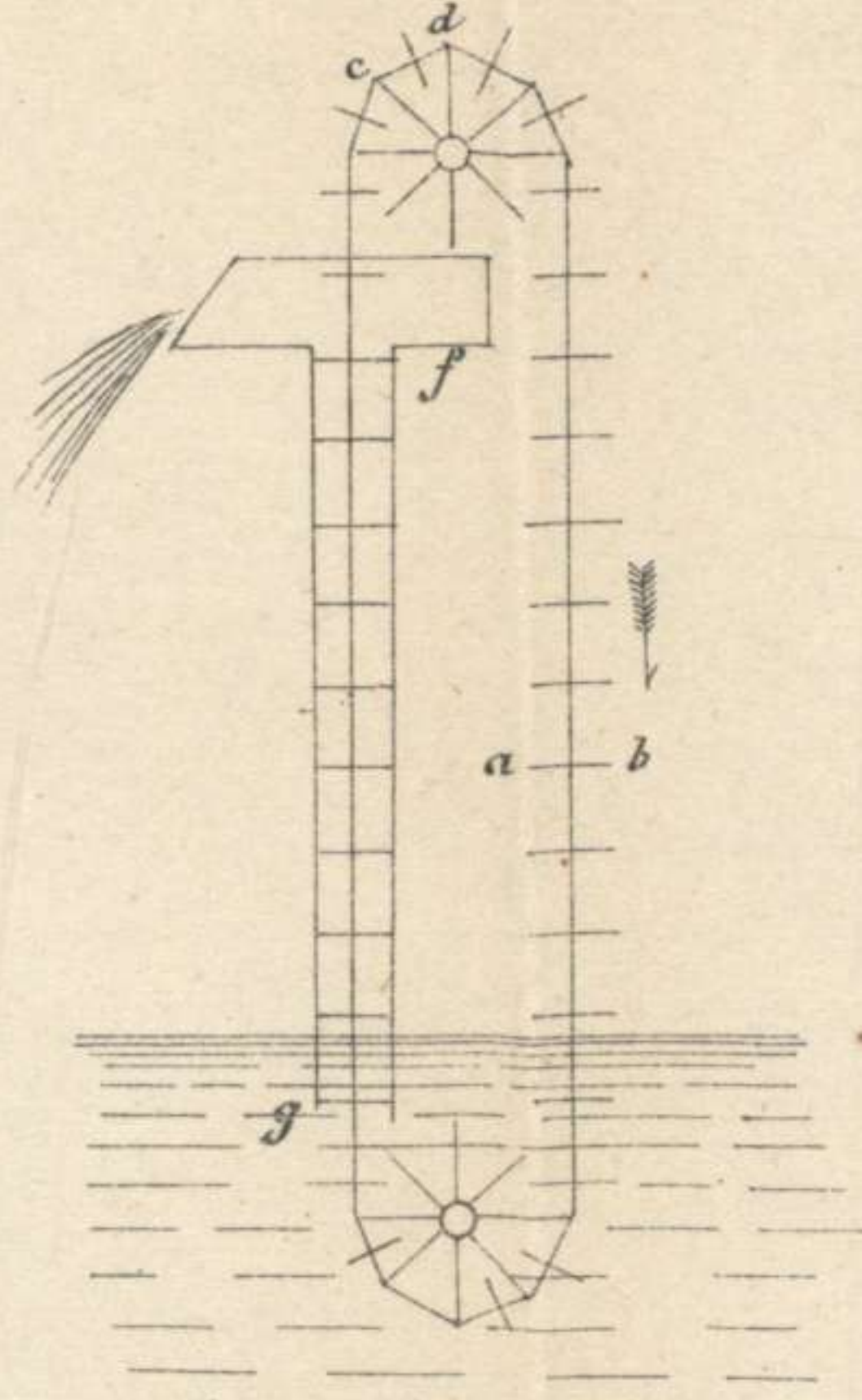

Fig. 132.

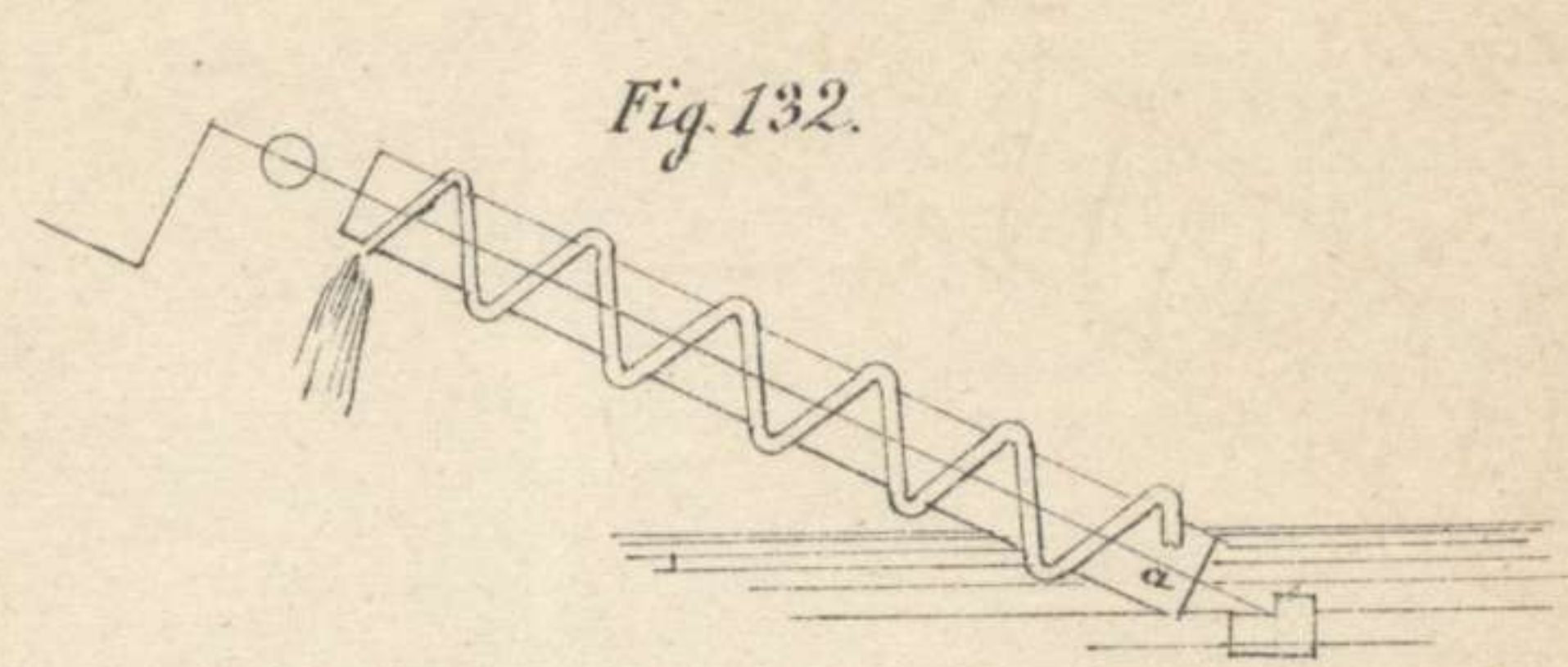

Fig. 133.

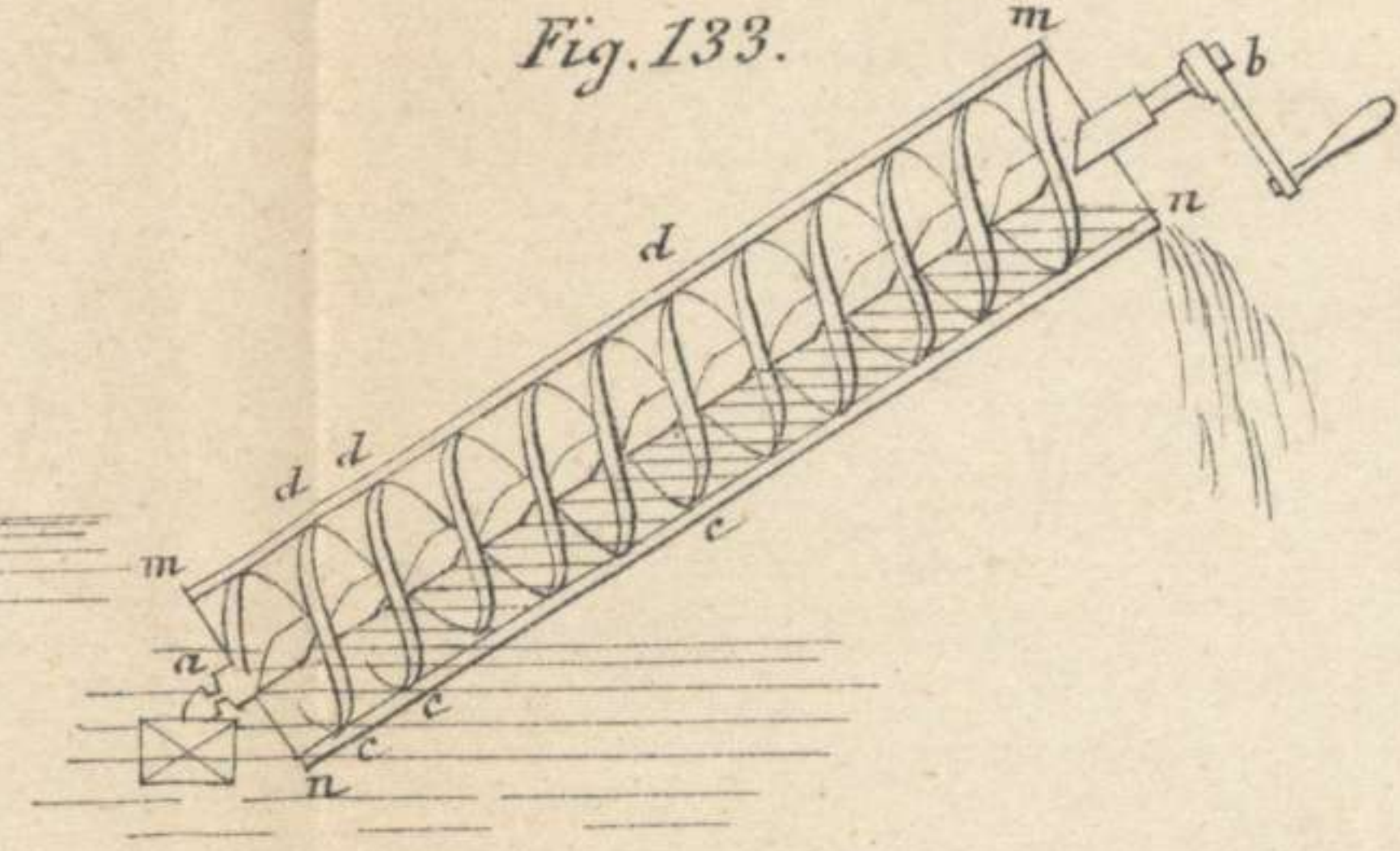

Fig. 134.

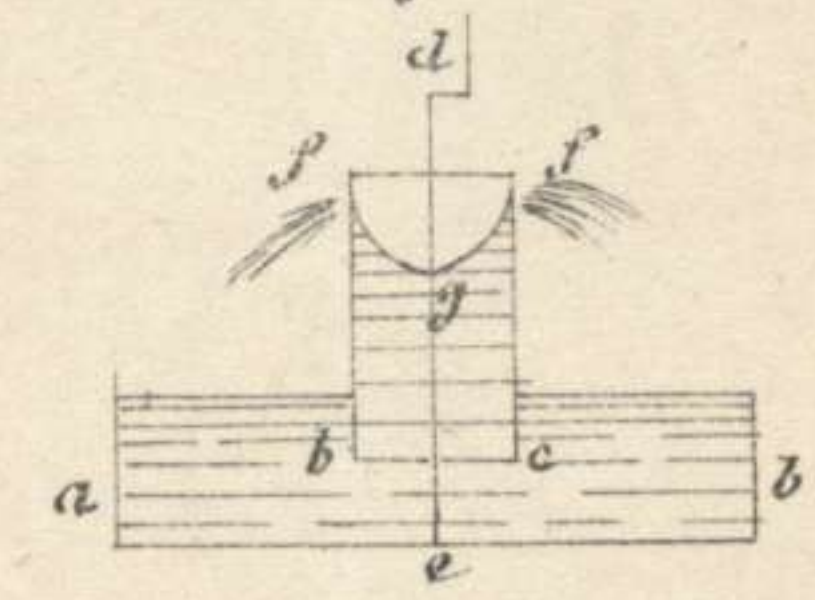

Fig. 139.

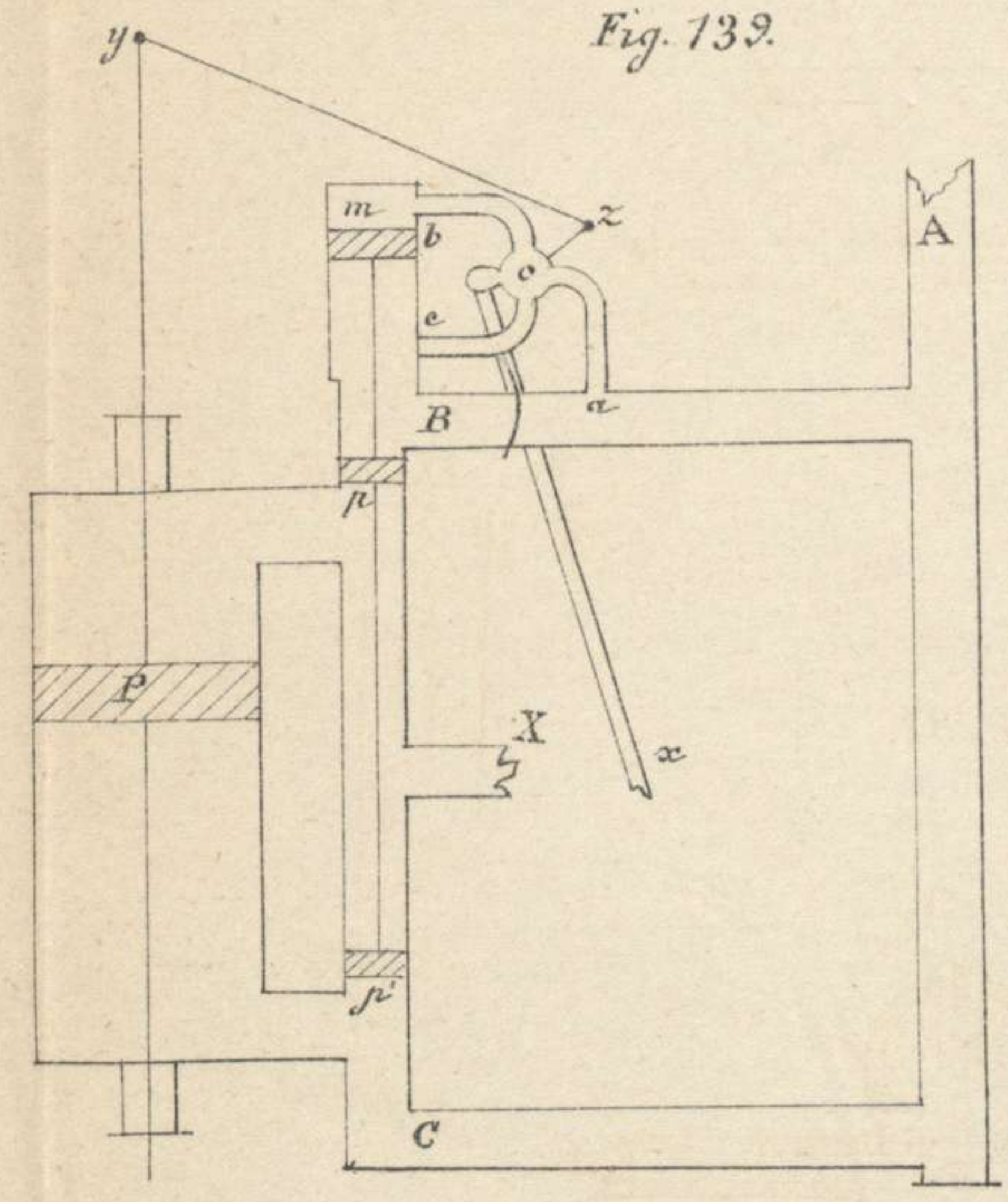

Fig. 138.

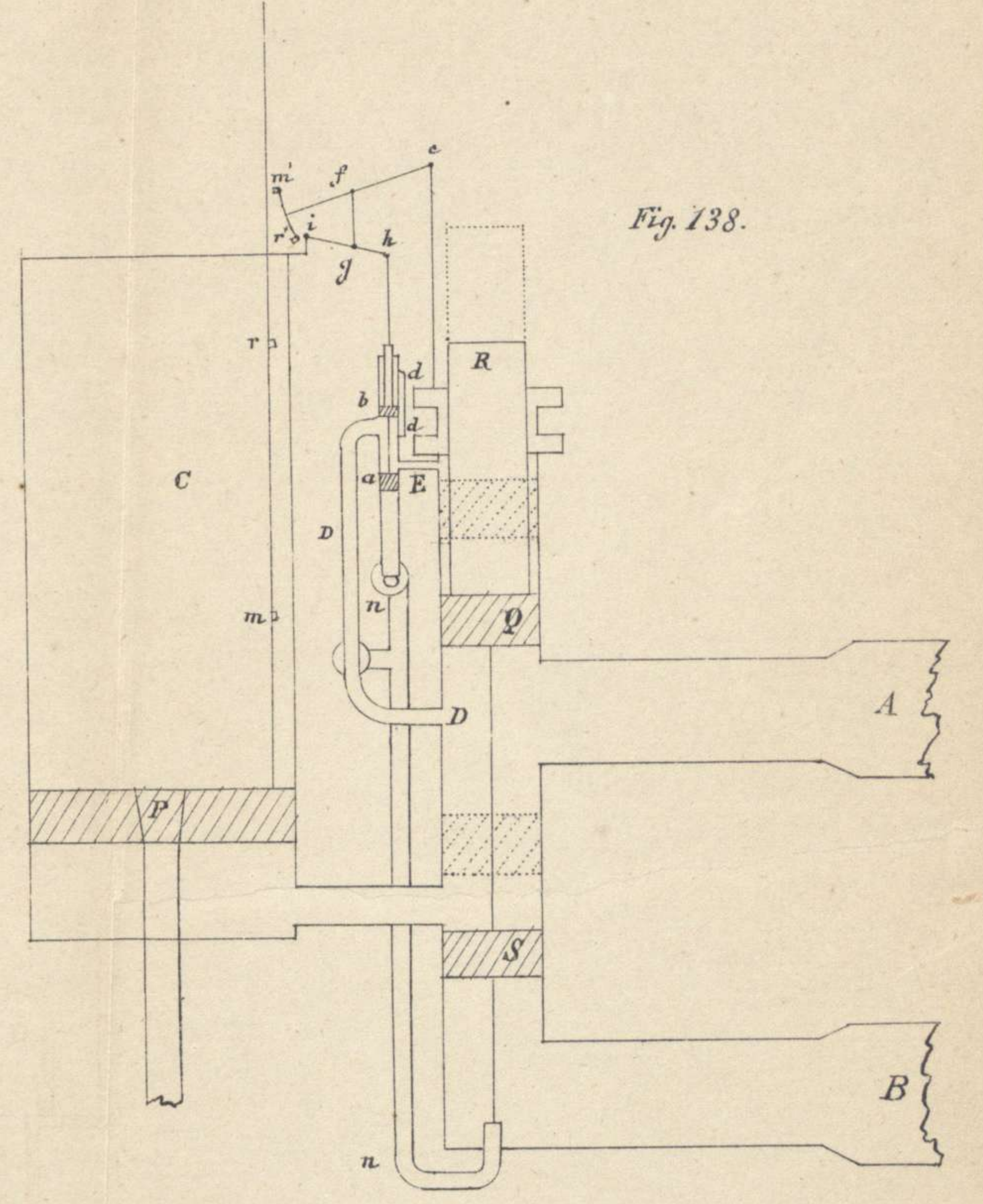

Fig. 135.

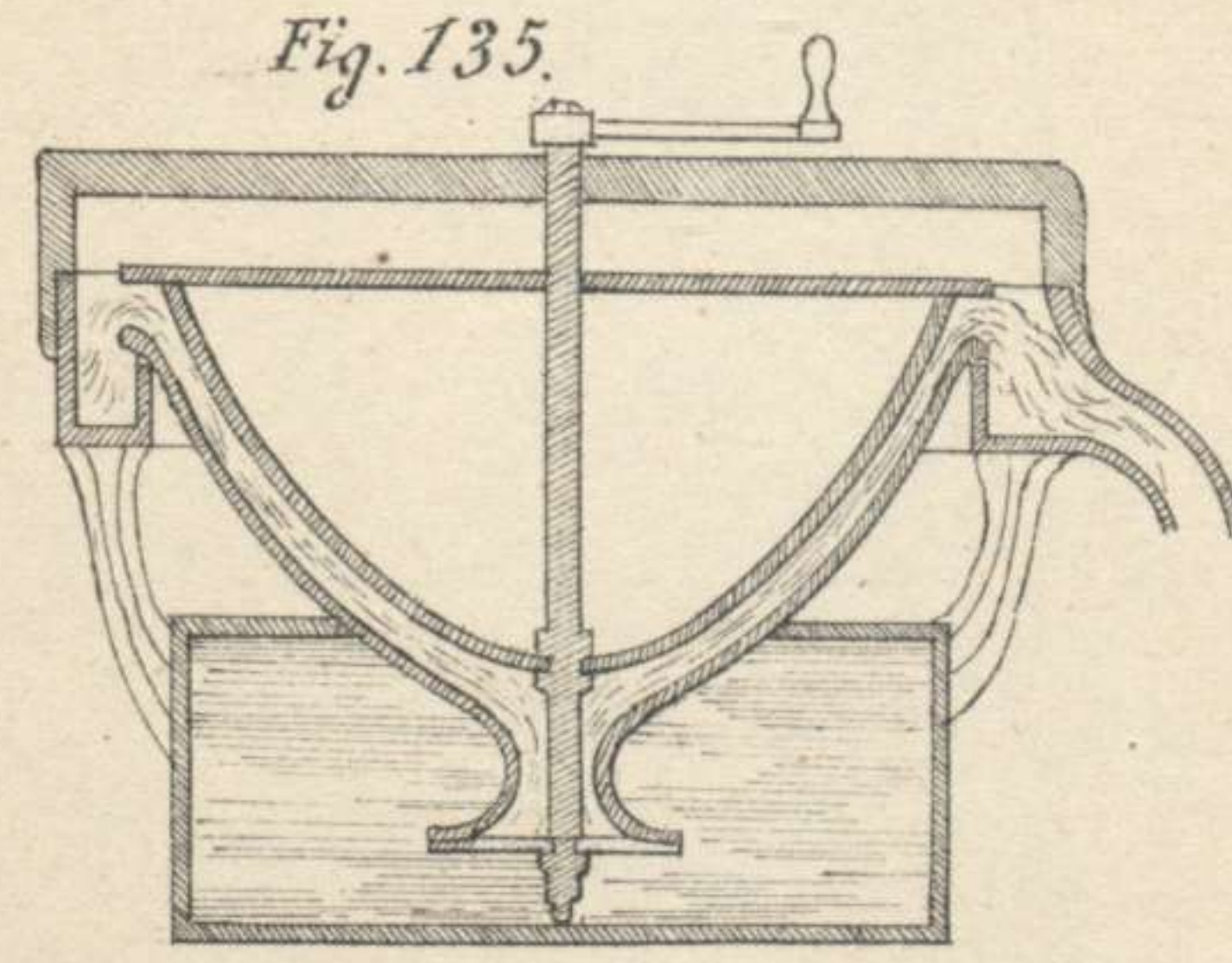

Fig. 137.

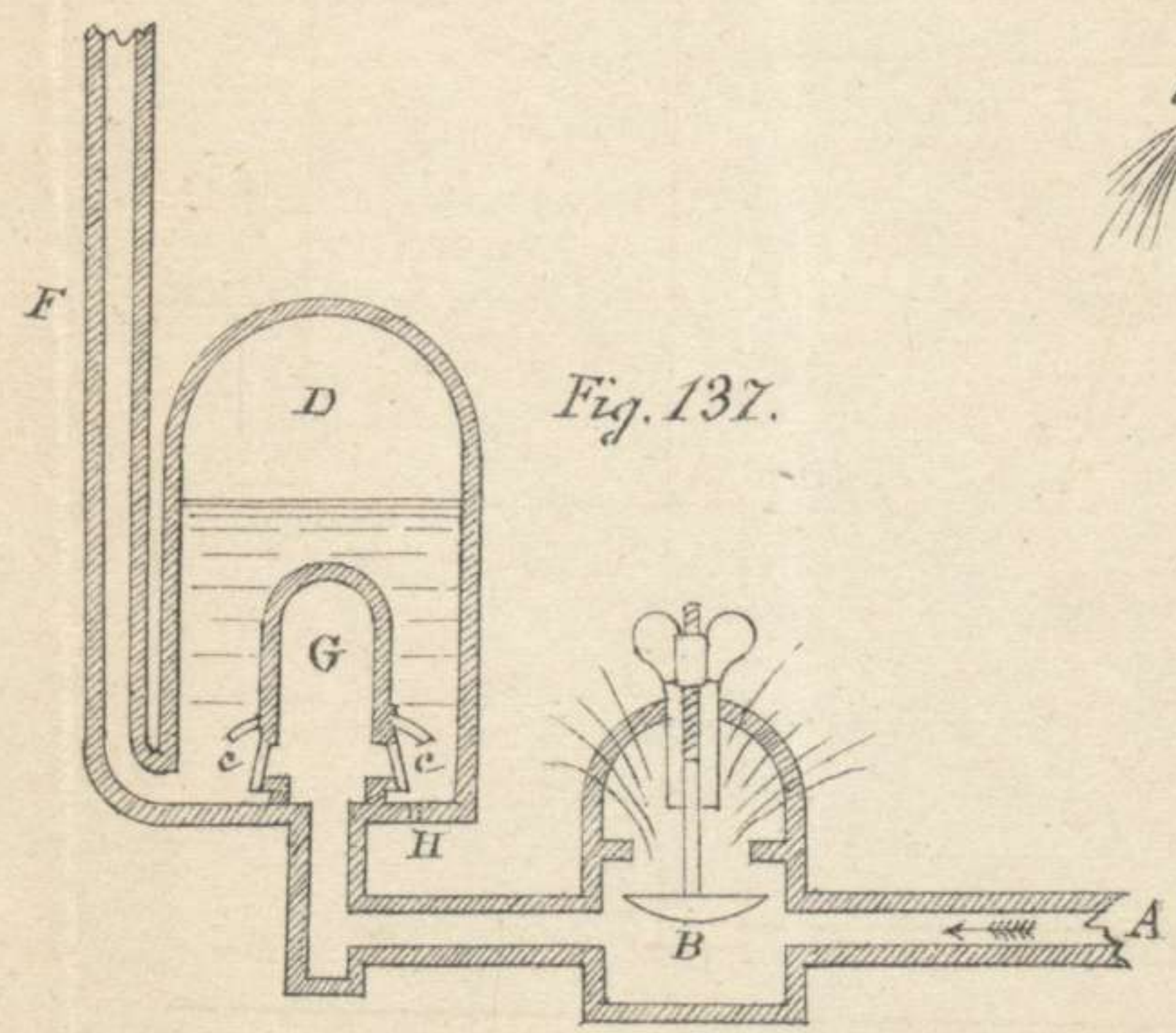

Fig. 136.

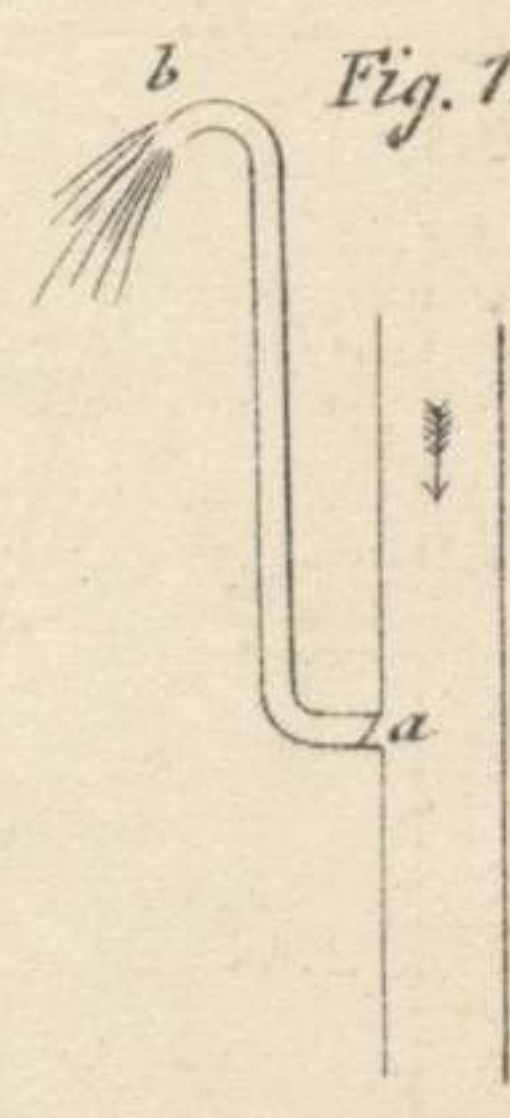

Fig. 140.

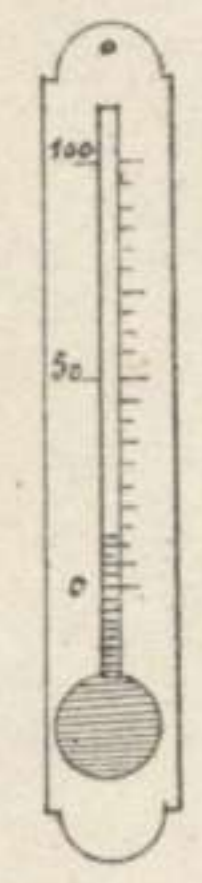

Fig.

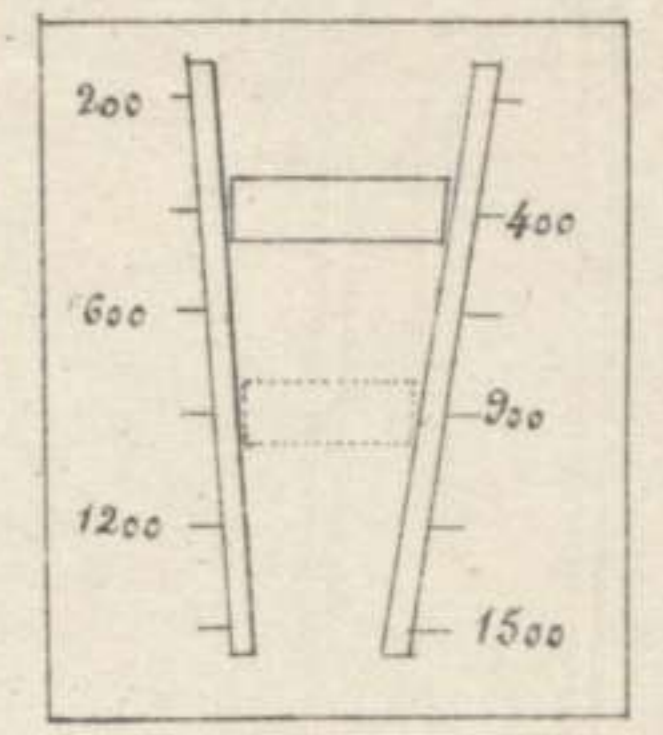

Fig. 142.

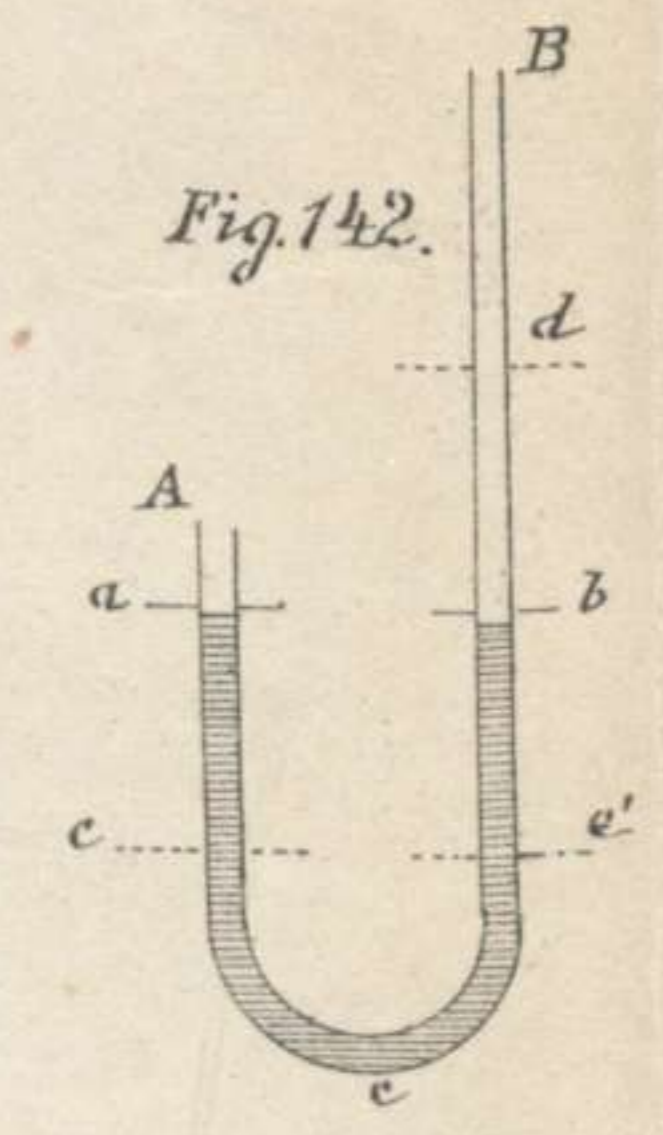

Fig. 143.

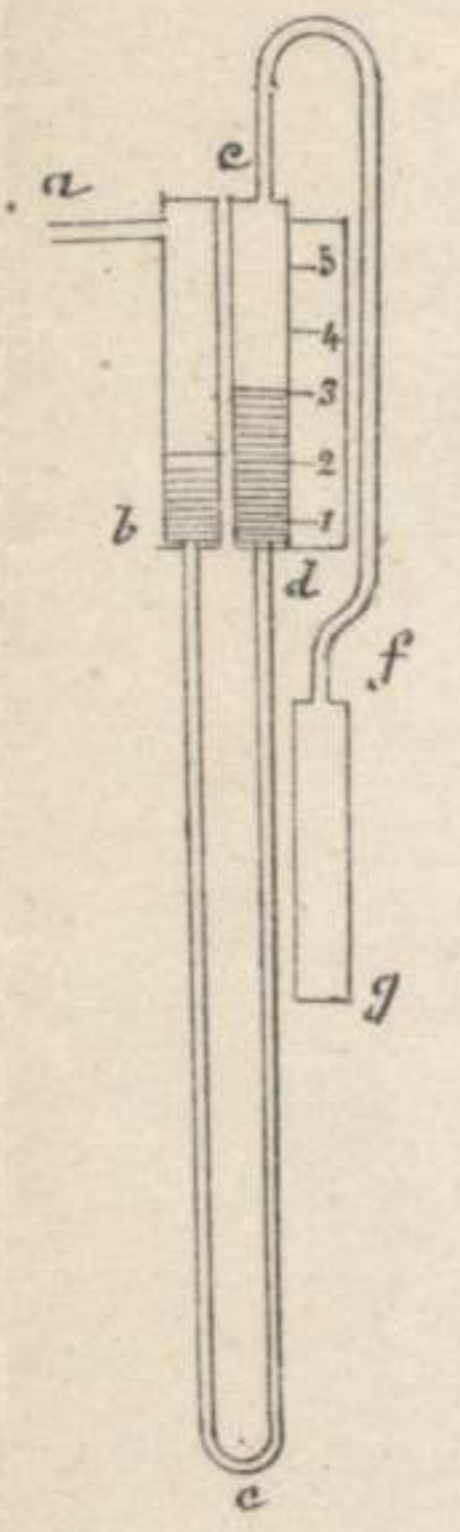

Fig. 144.

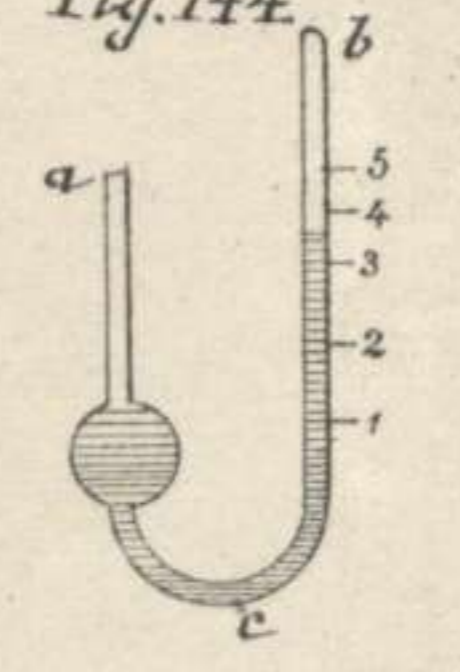

Fig. 145.

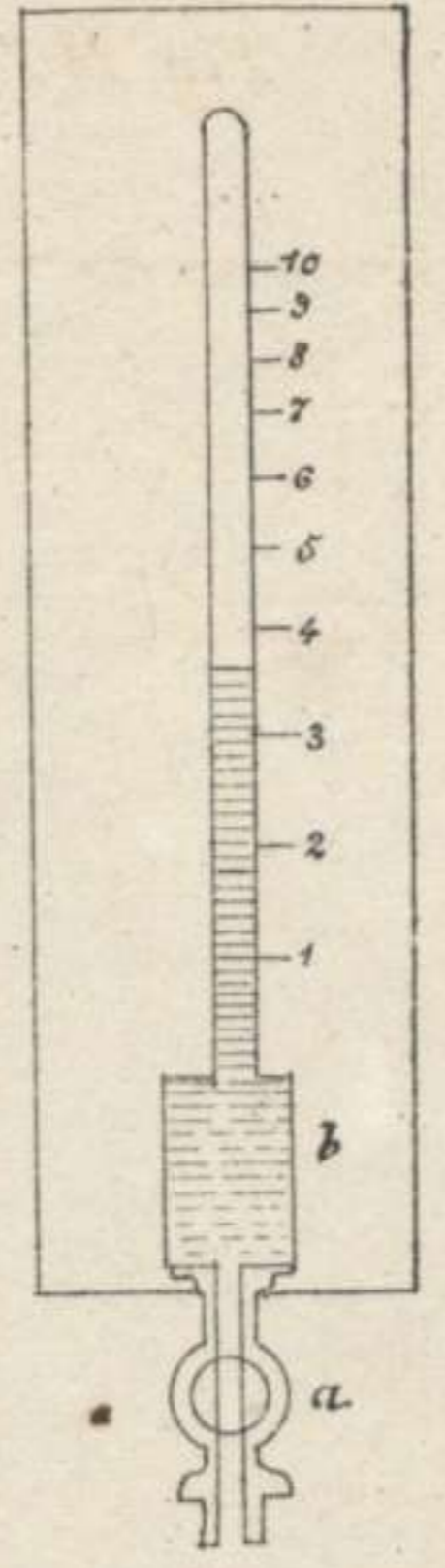

Fig. 146.

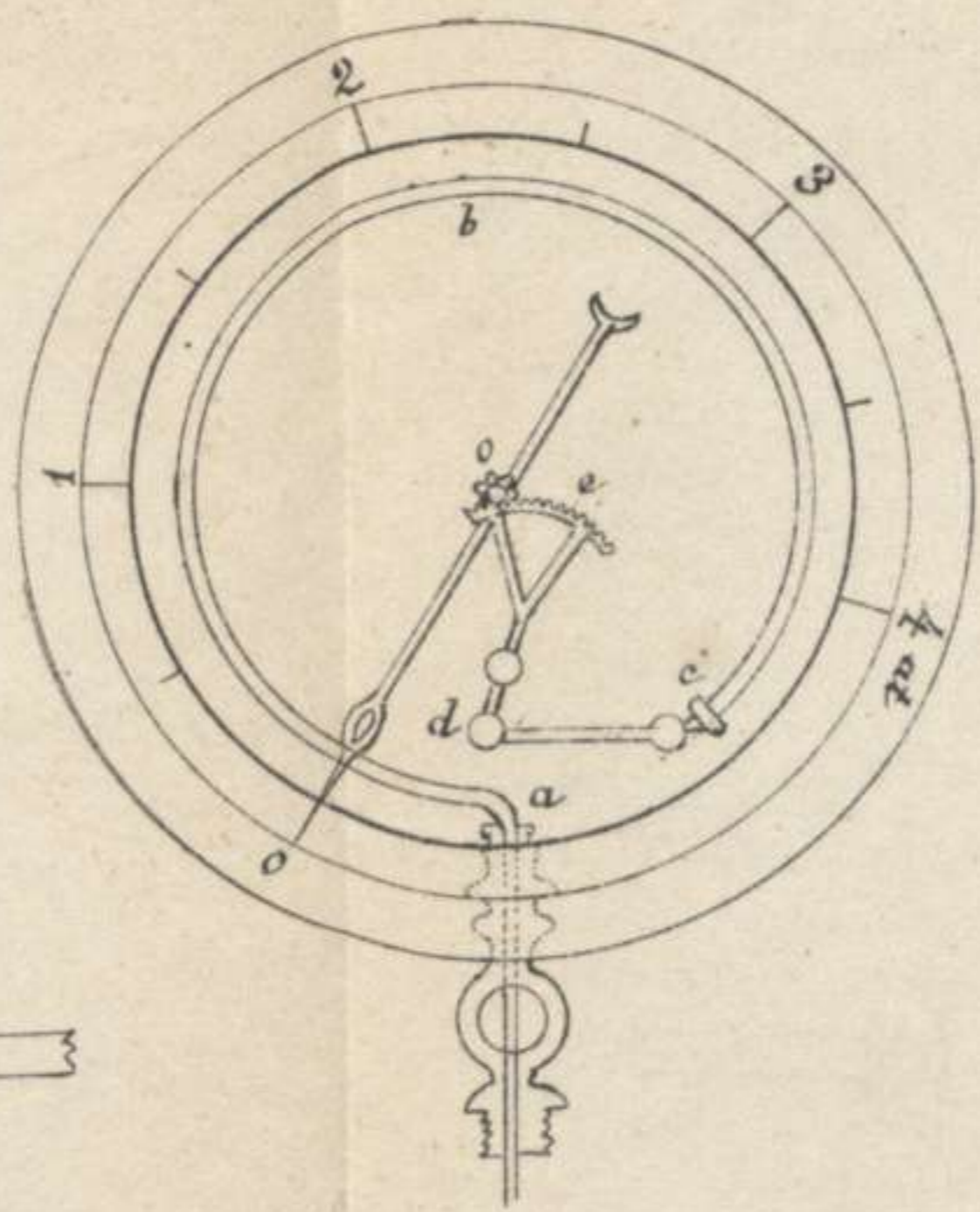

Fig. 147.

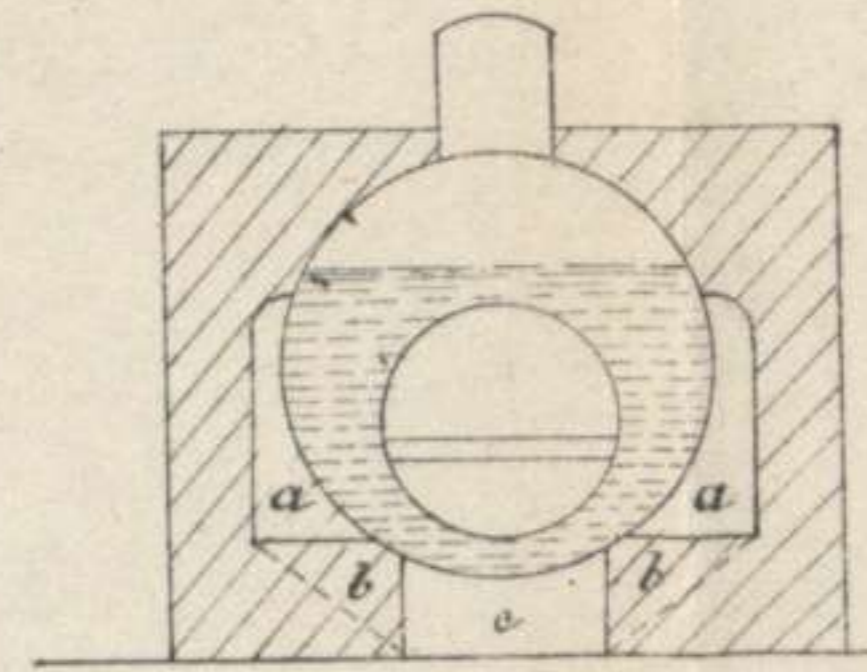
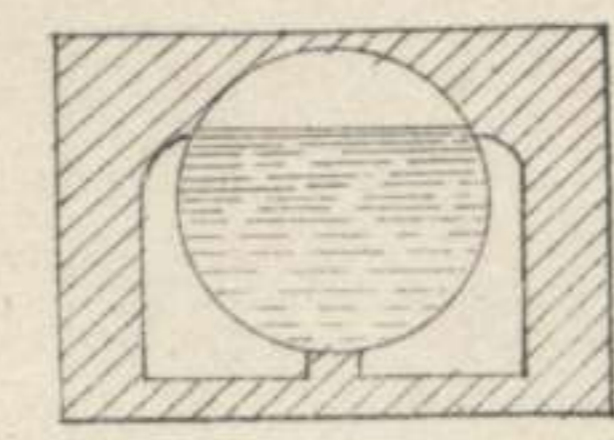

Fig. 149.

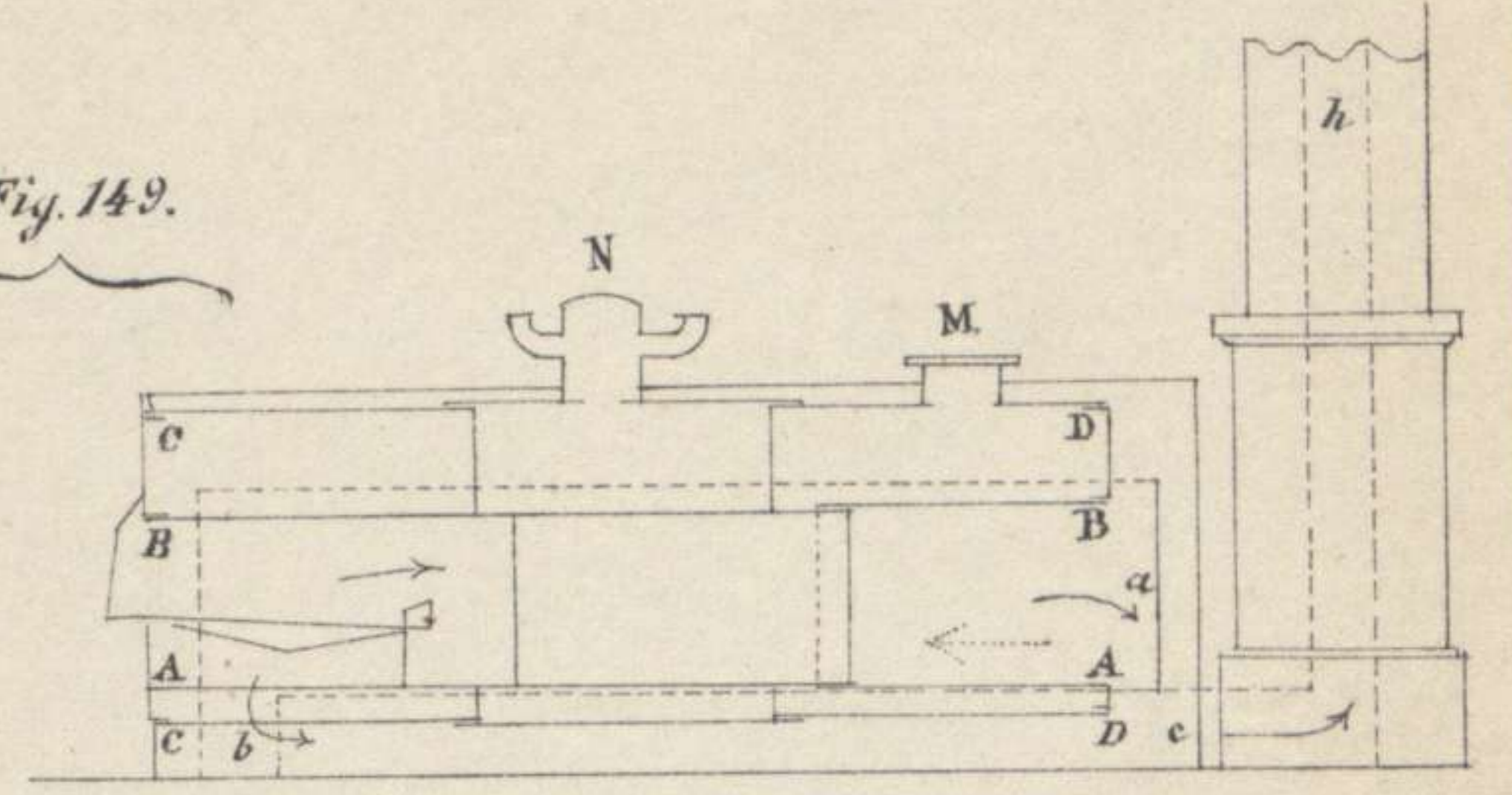

Fig. 148.

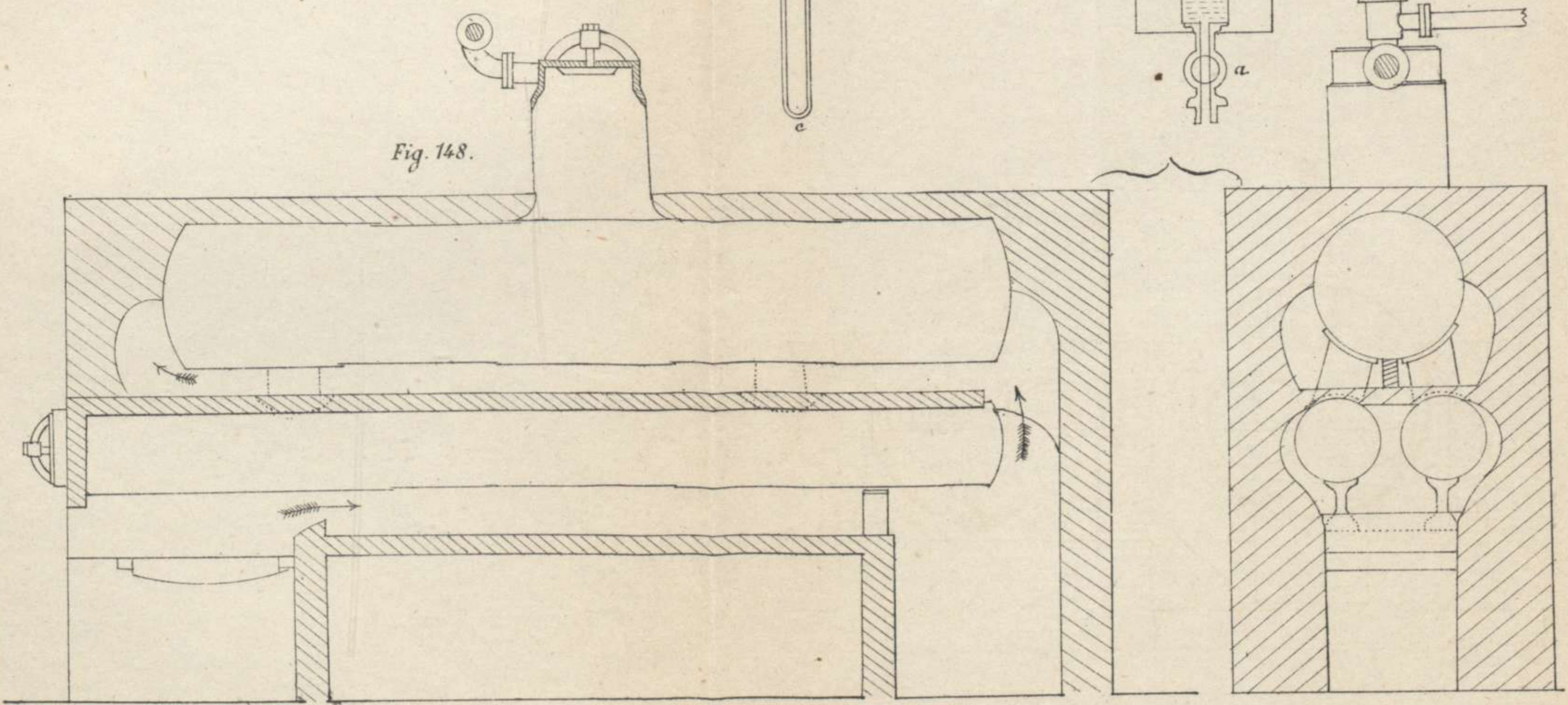
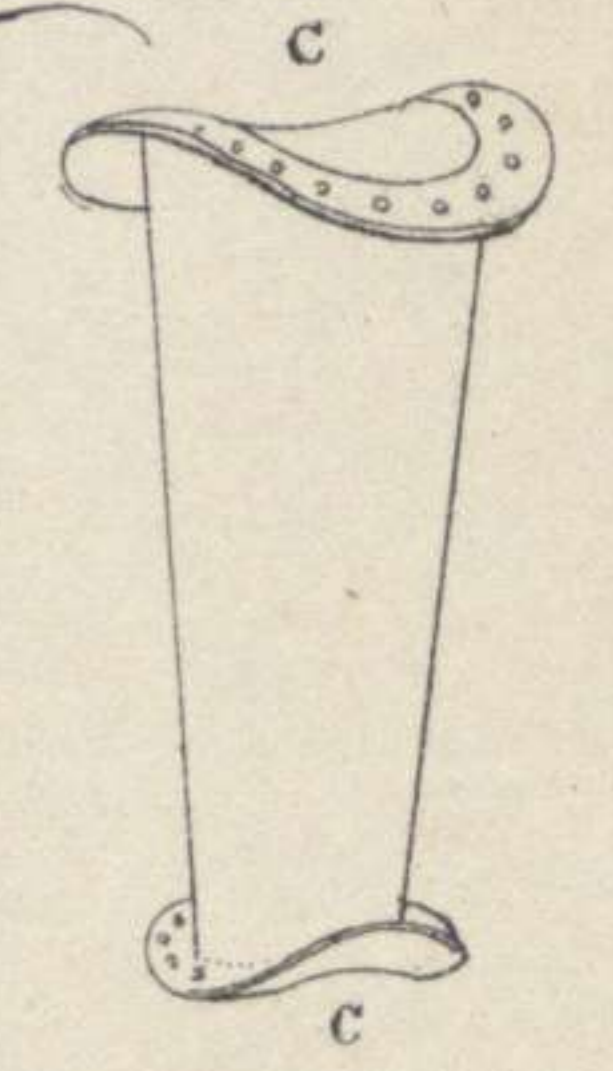
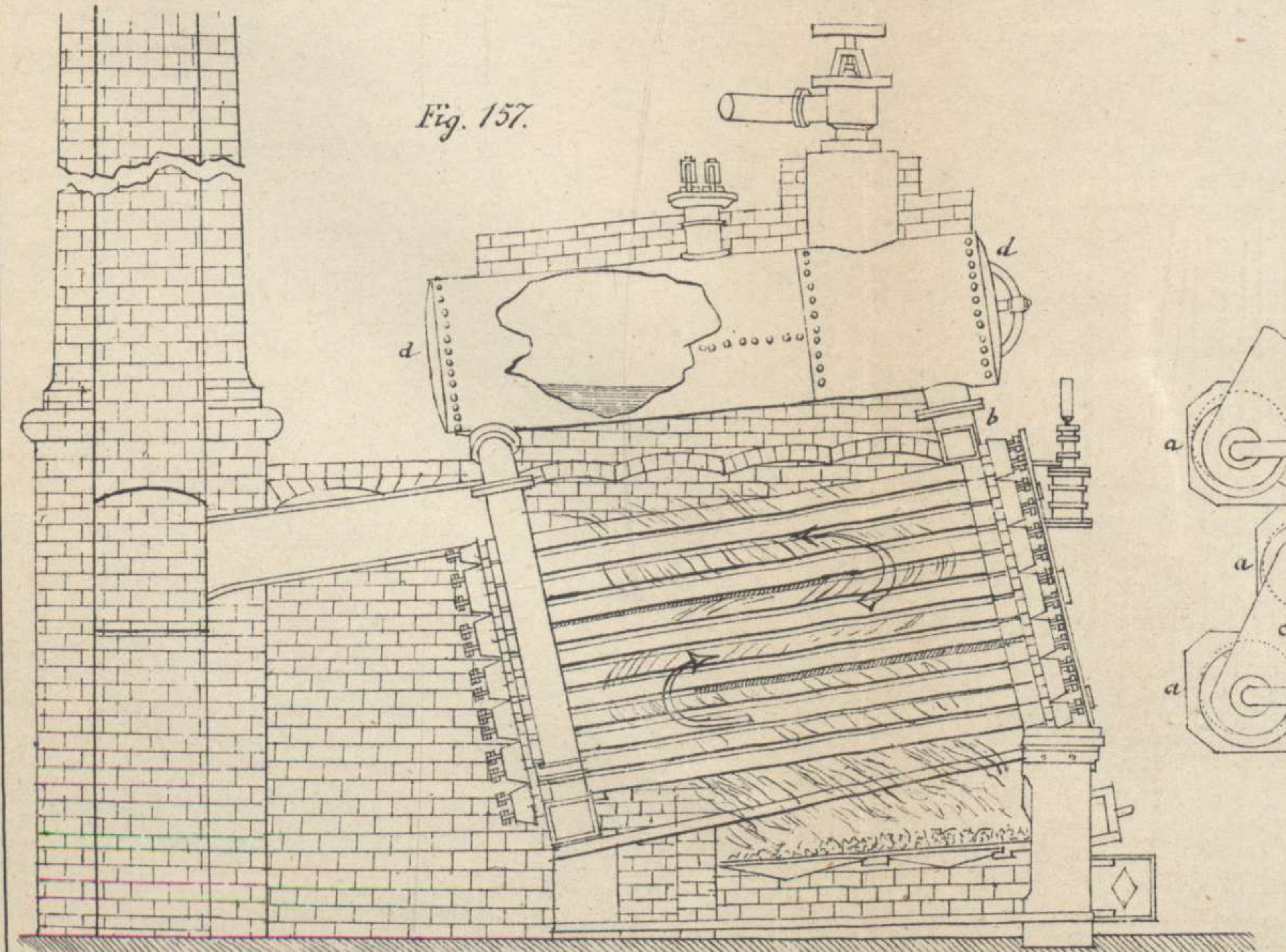
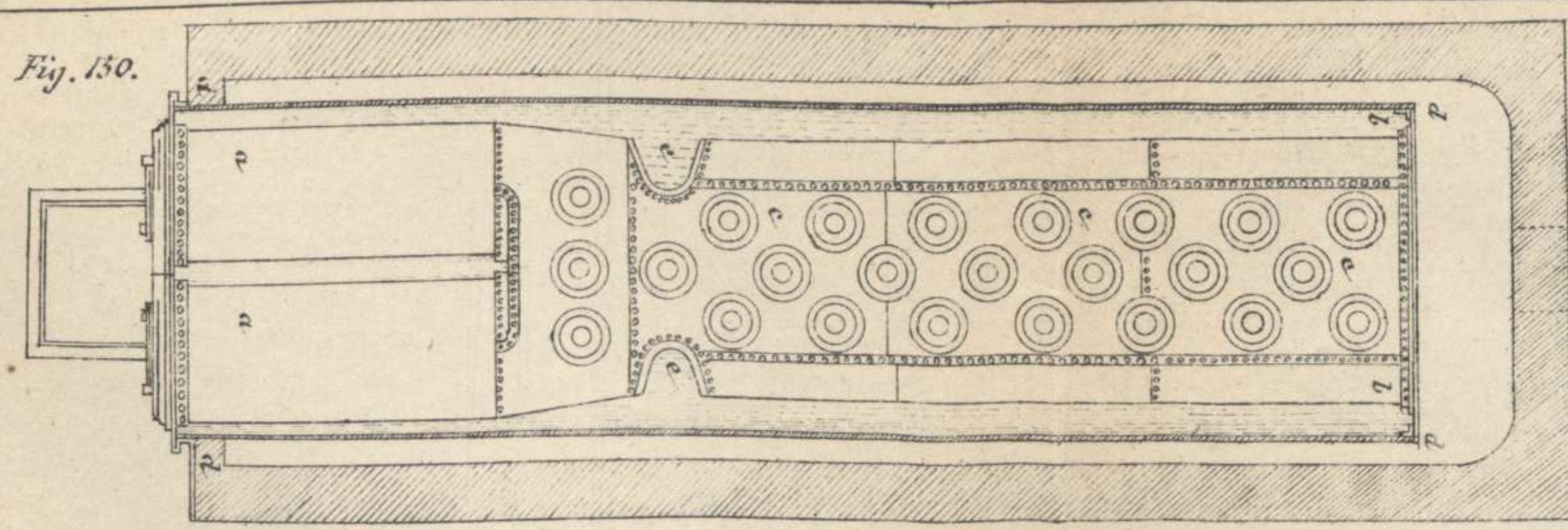

Fig. 150.





Lit. de M. Ventura.

Fig. 151.

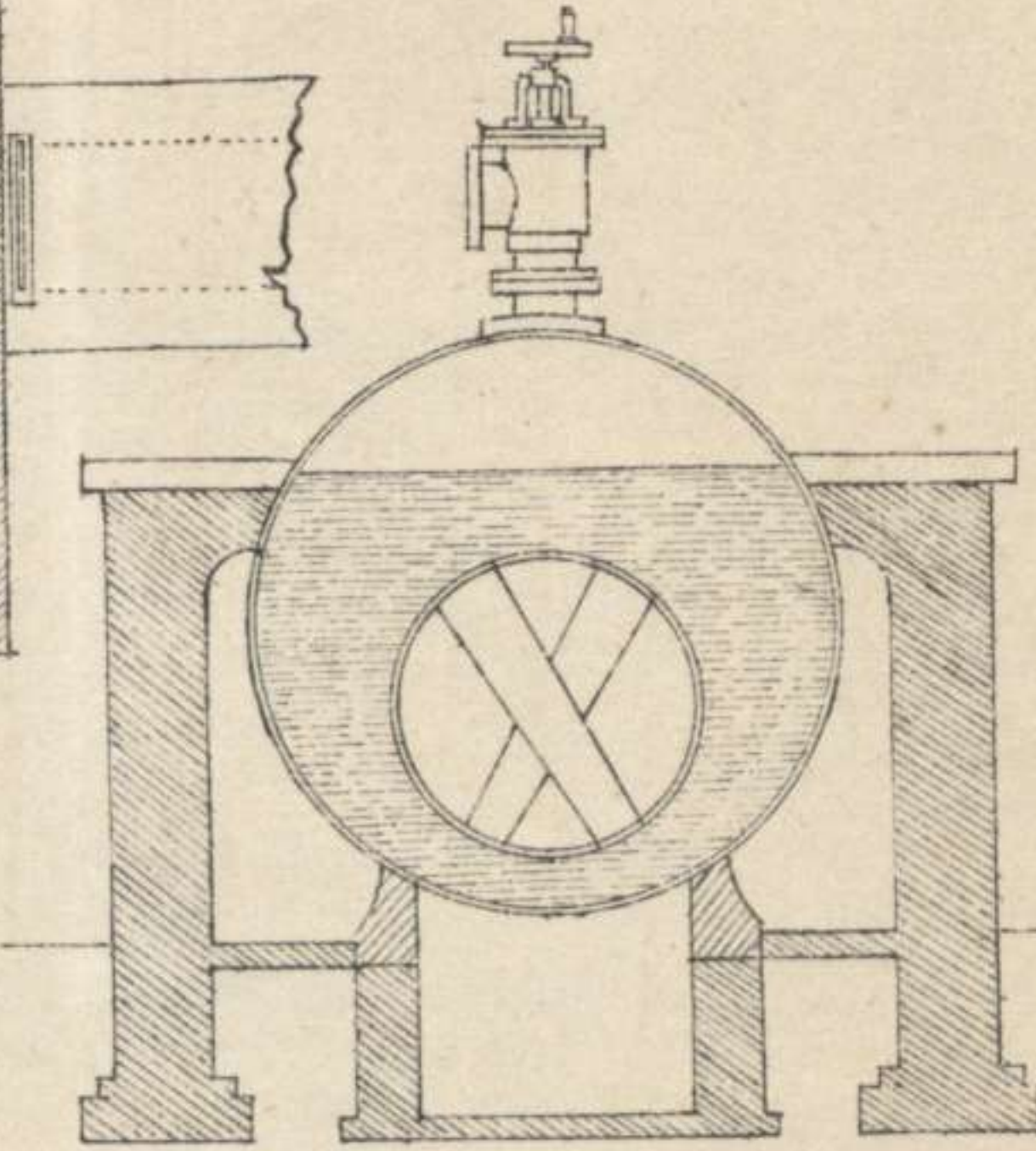

Fig. 152.

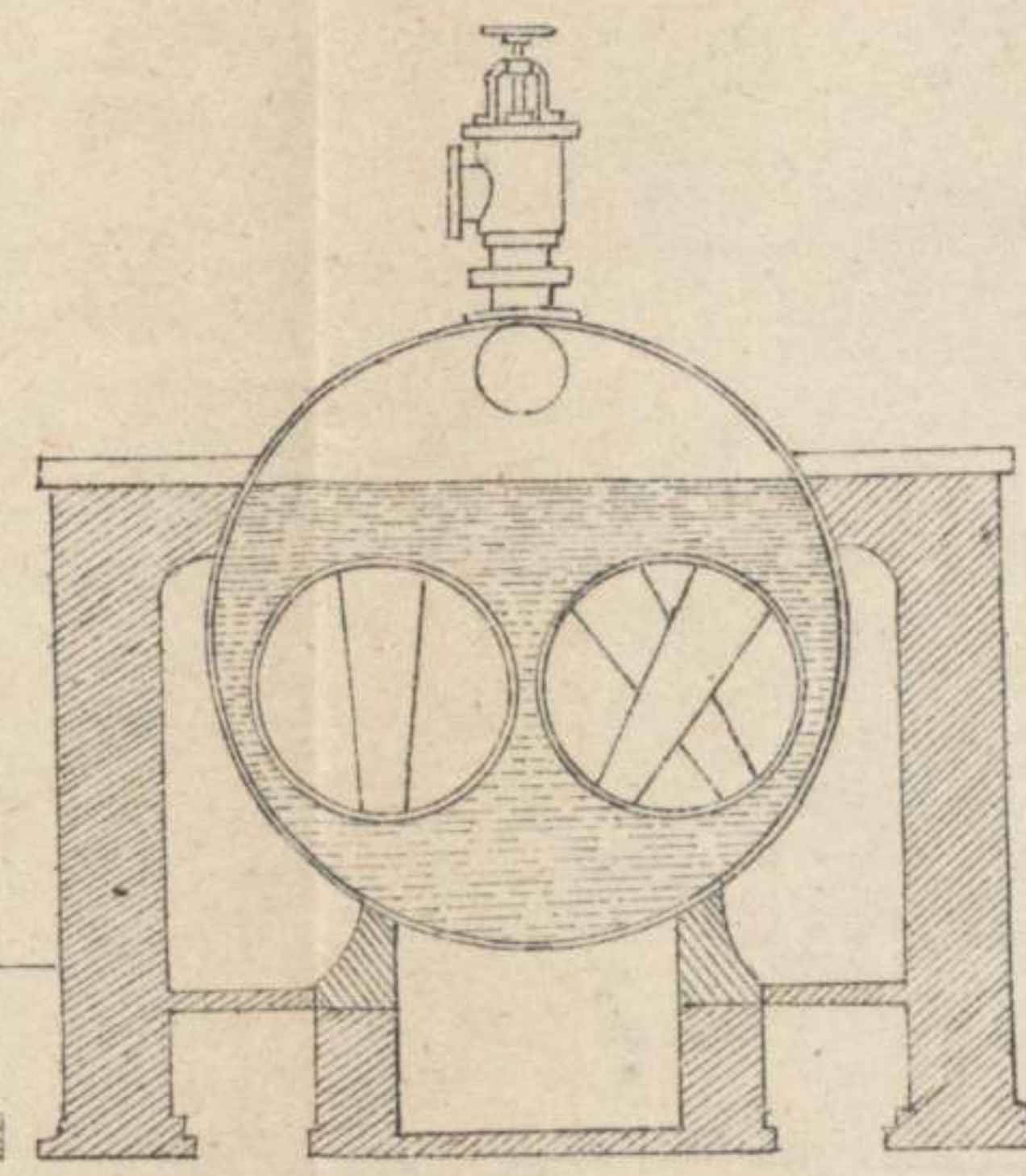

Fig. 153.

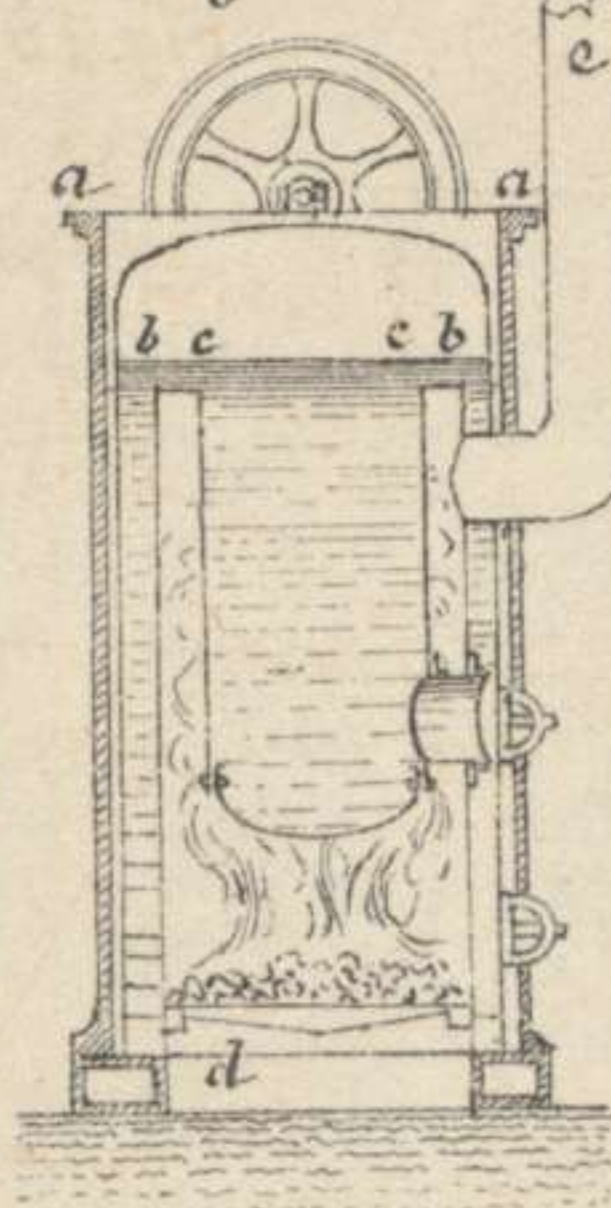

Fig. 154.

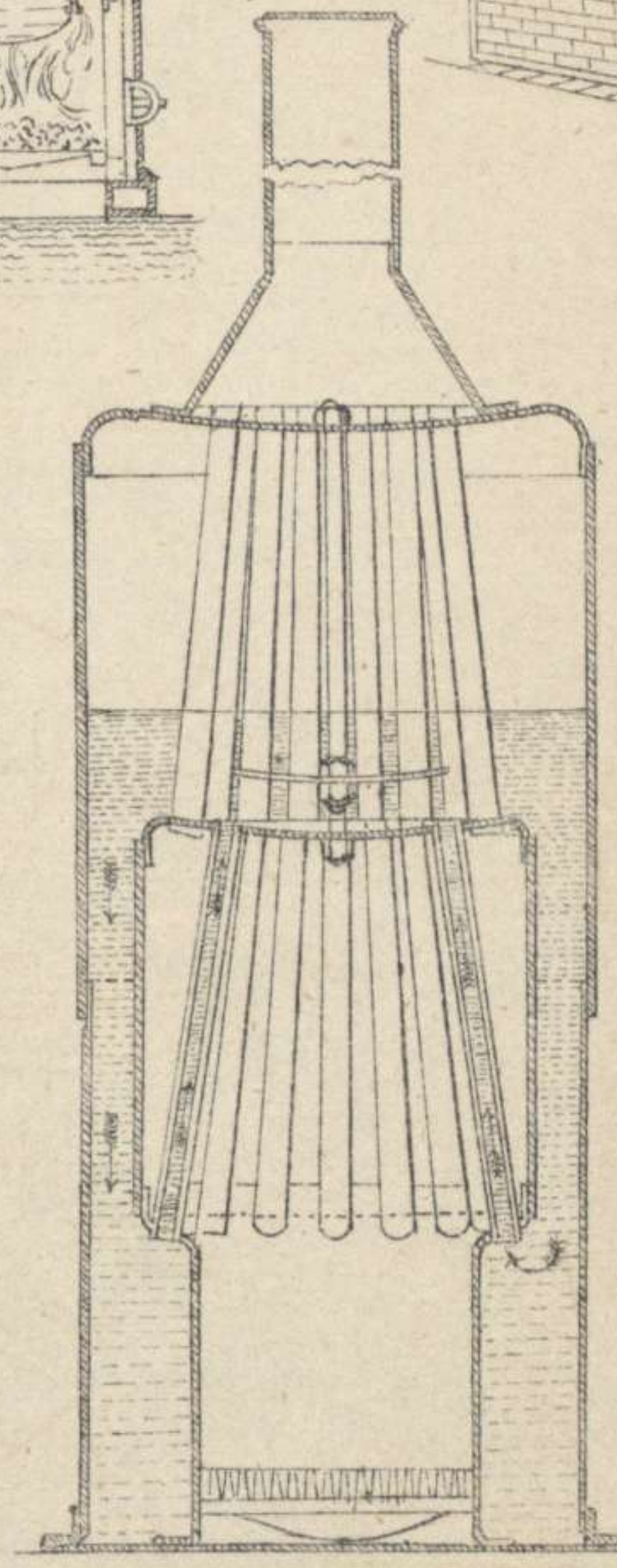

Fig. 156.

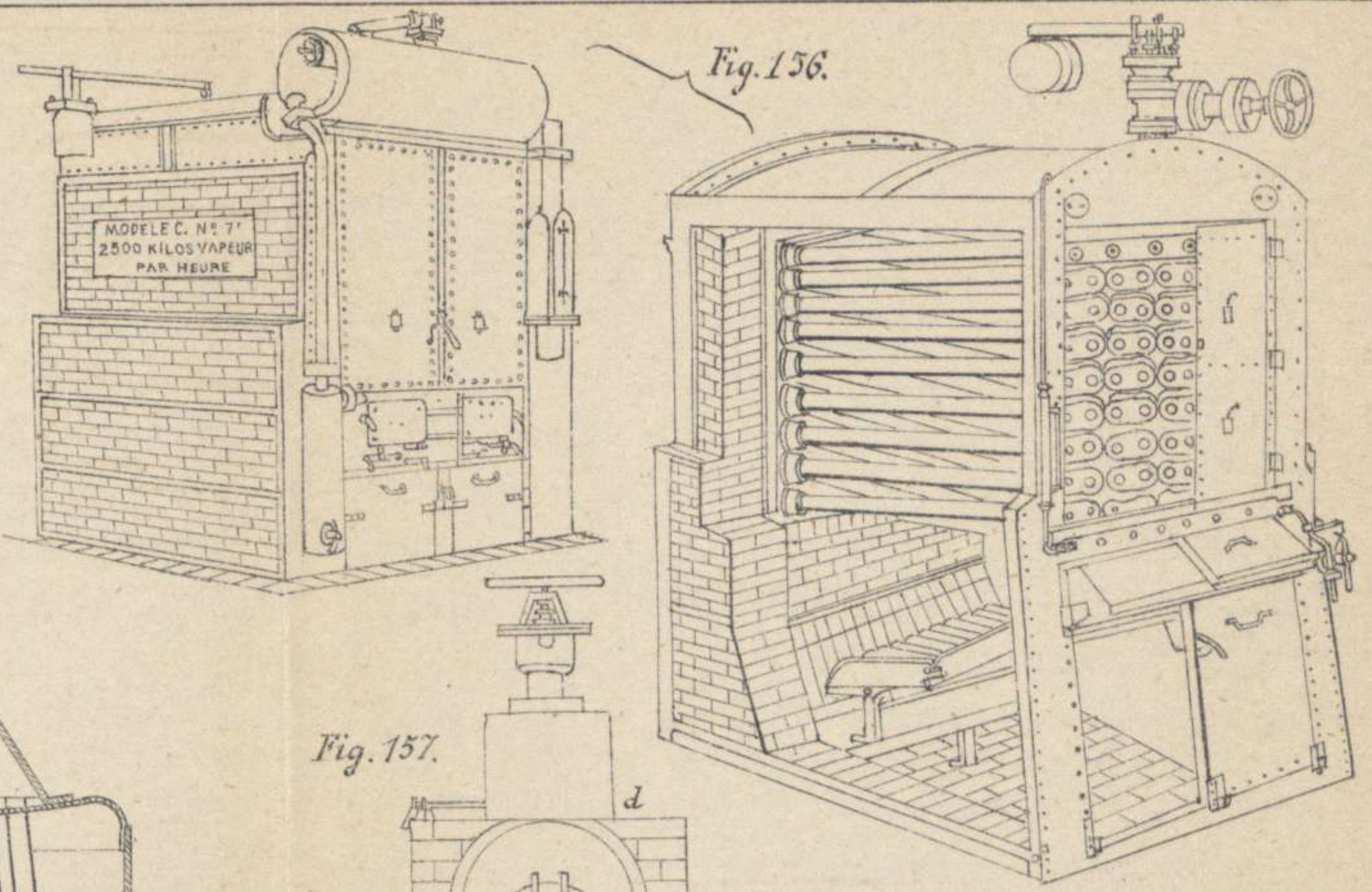

Fig. 157.

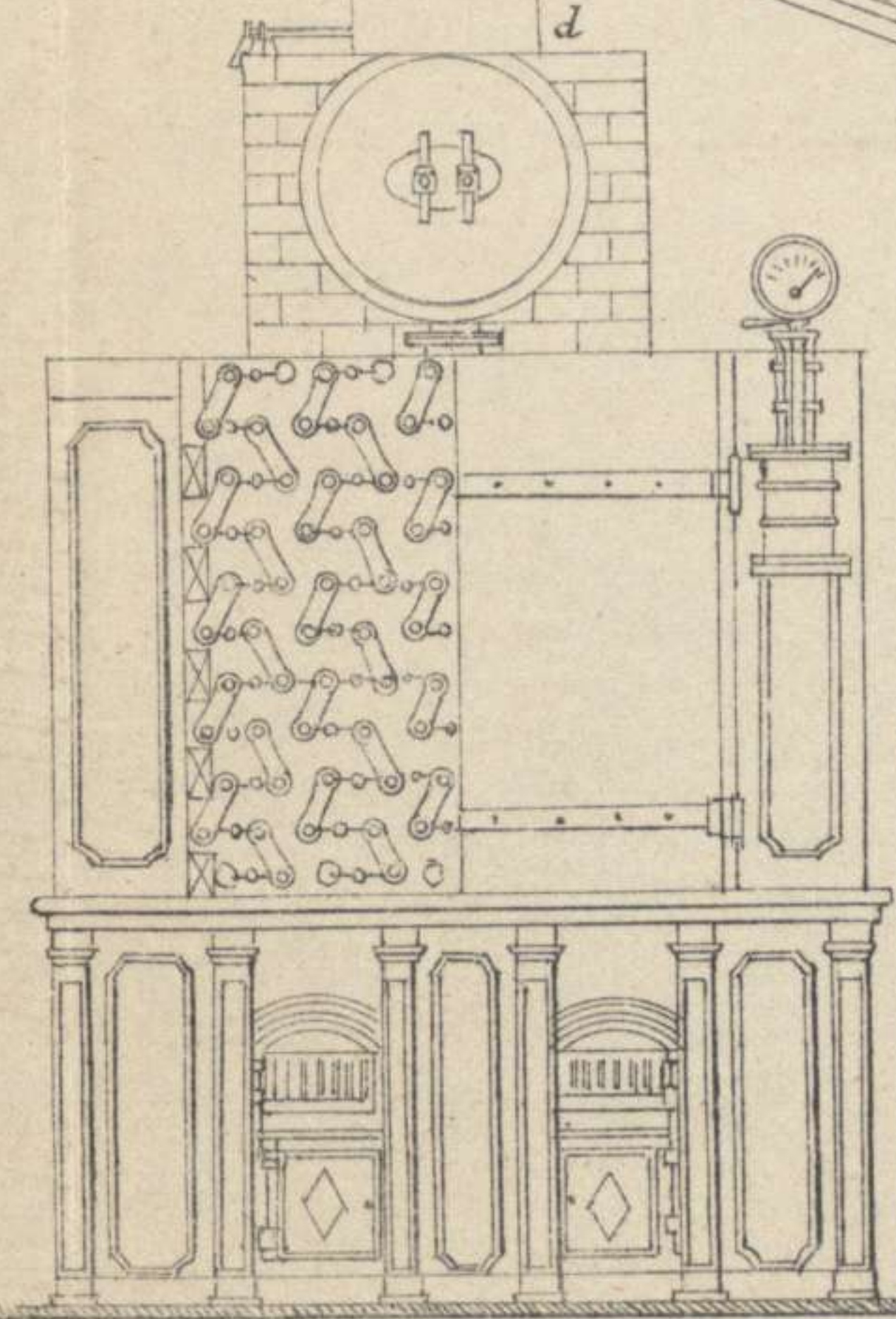
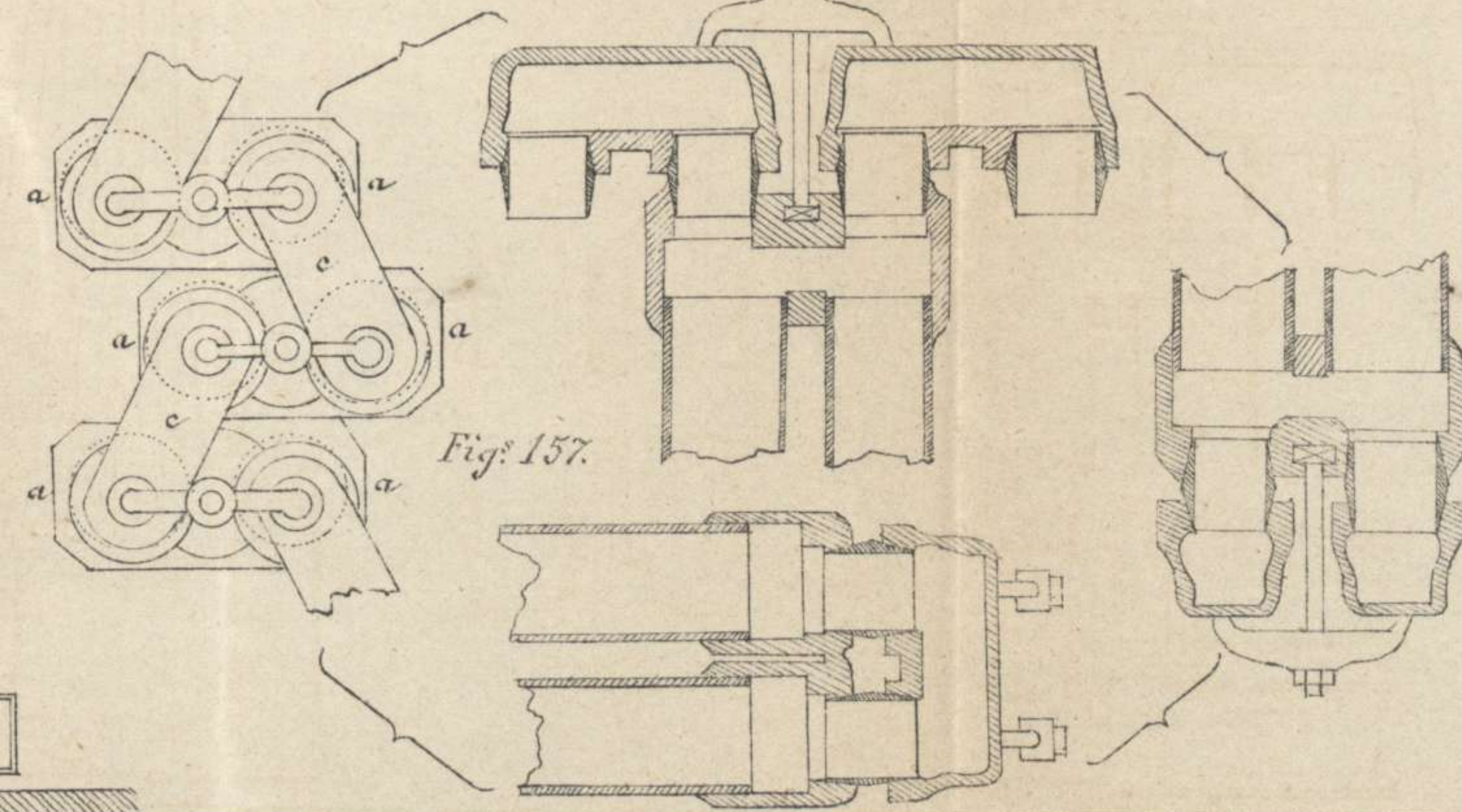
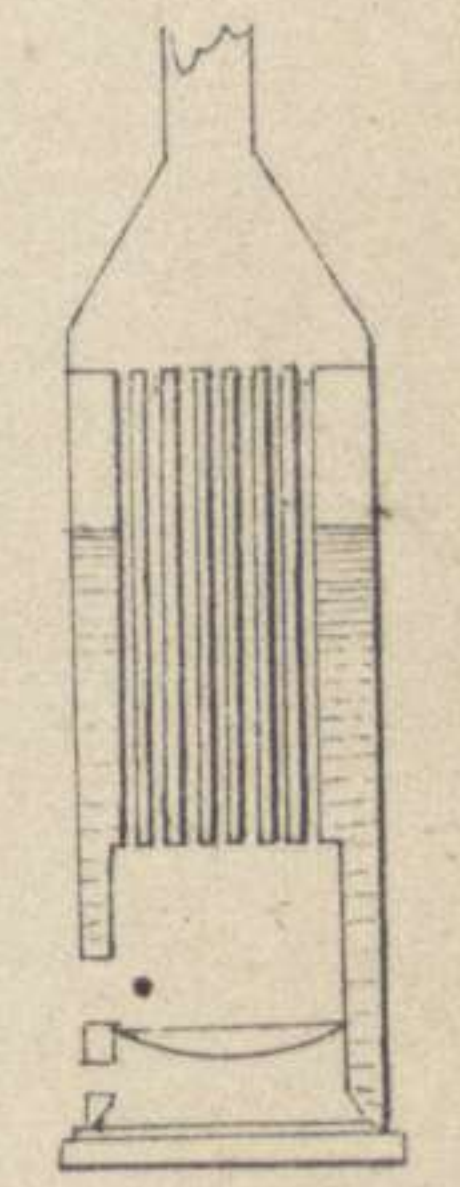

Fig. 155.



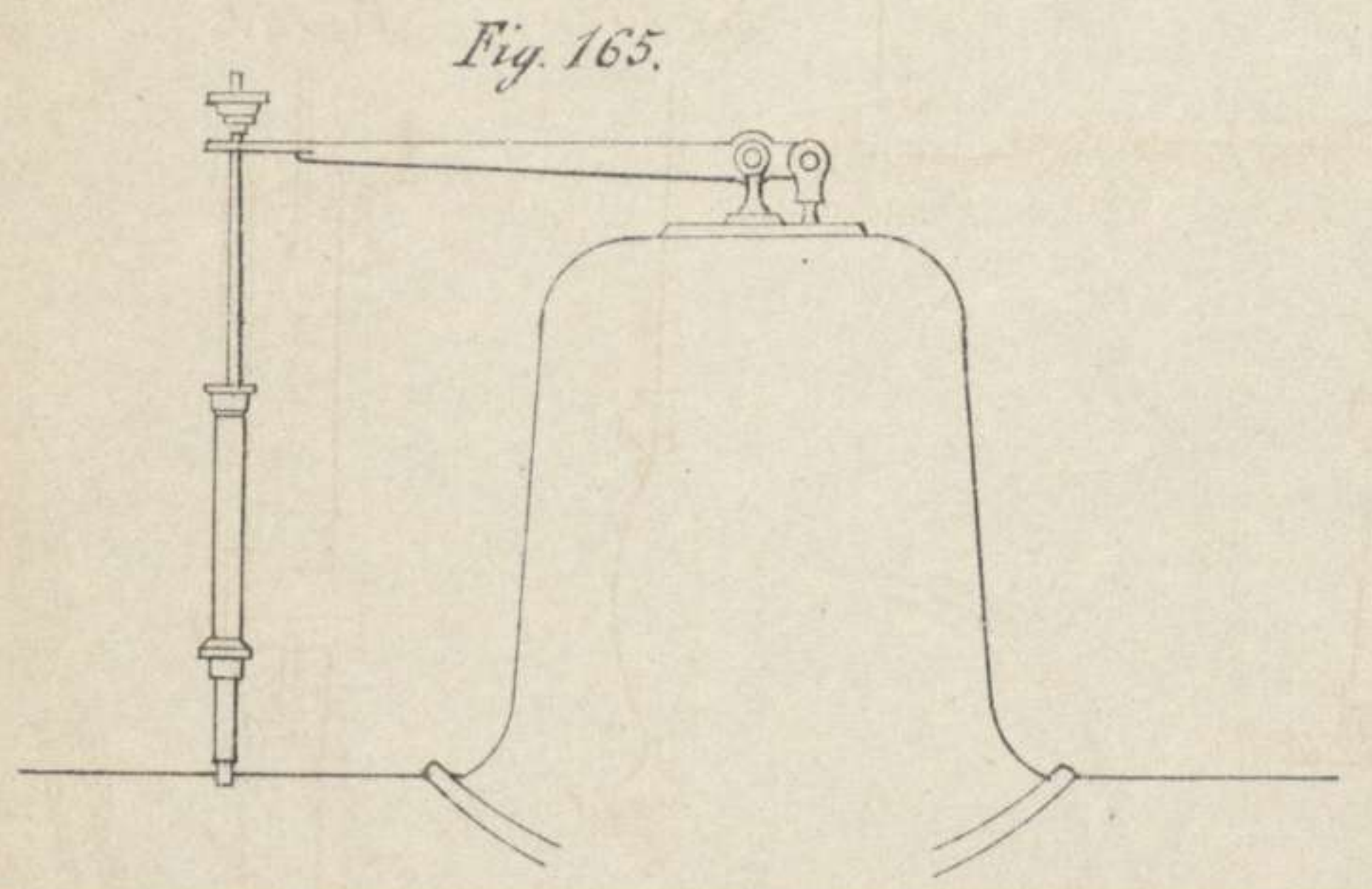
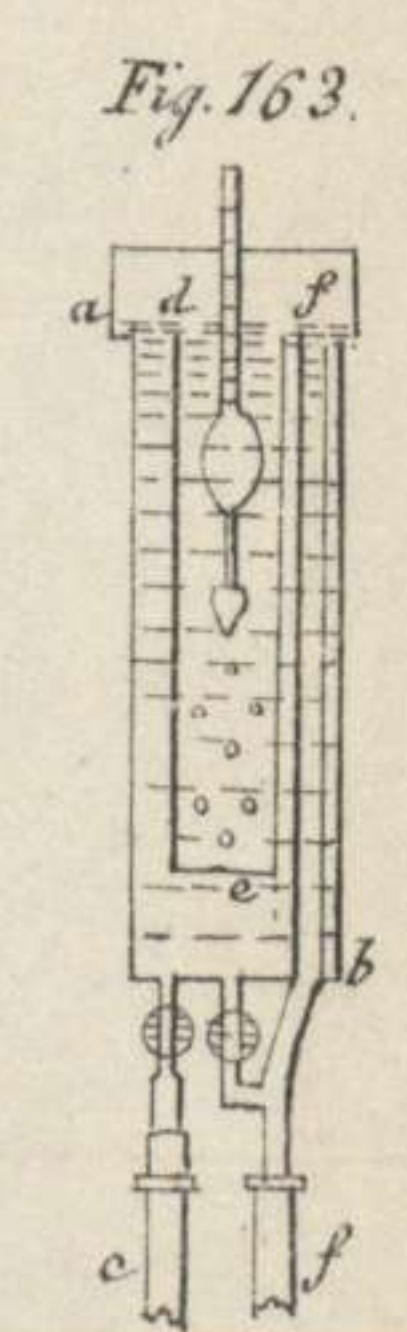
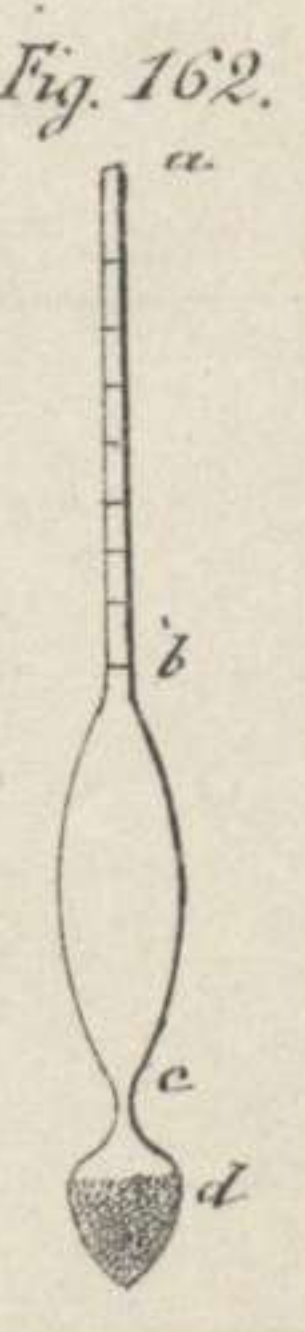
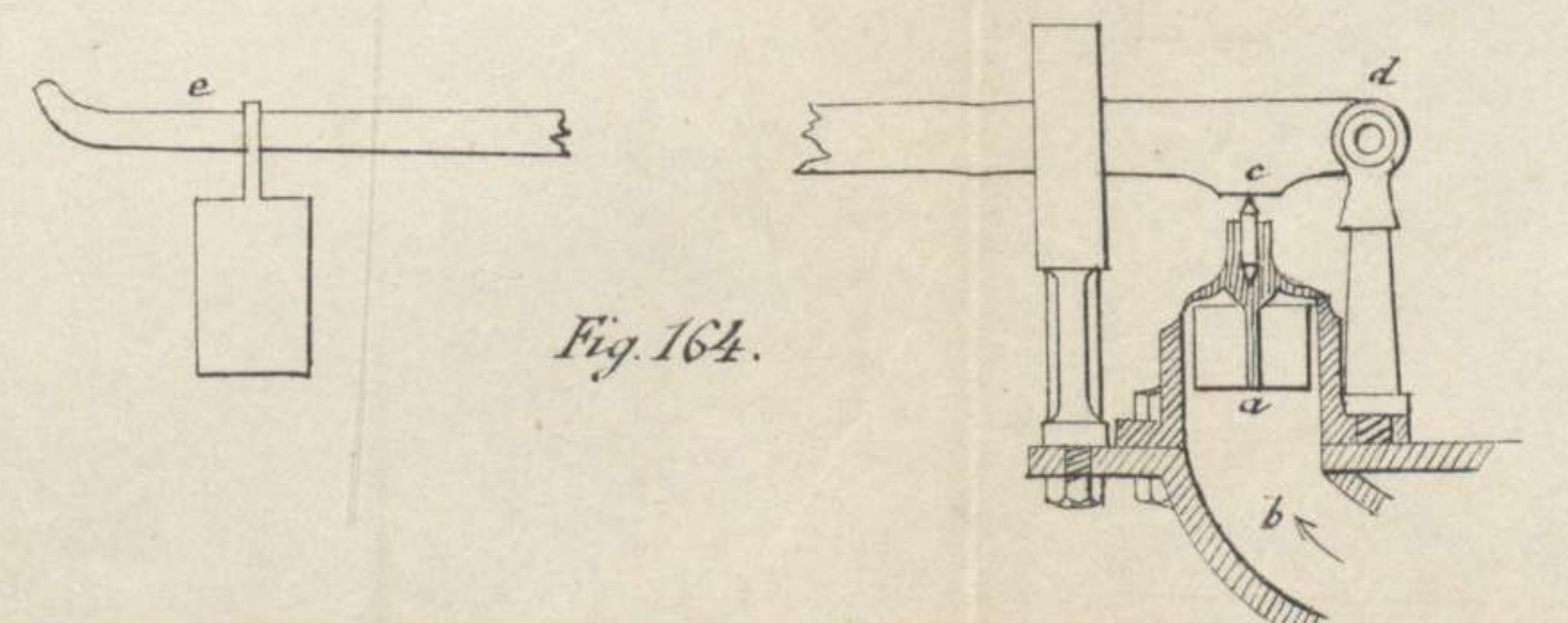
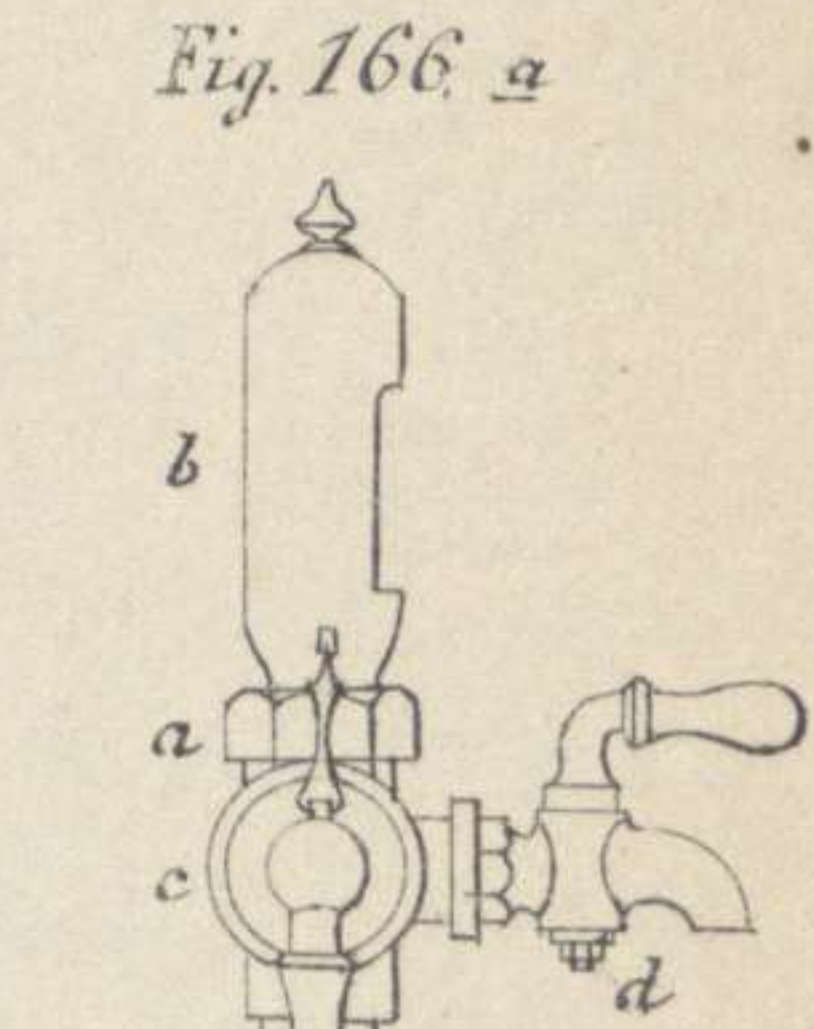
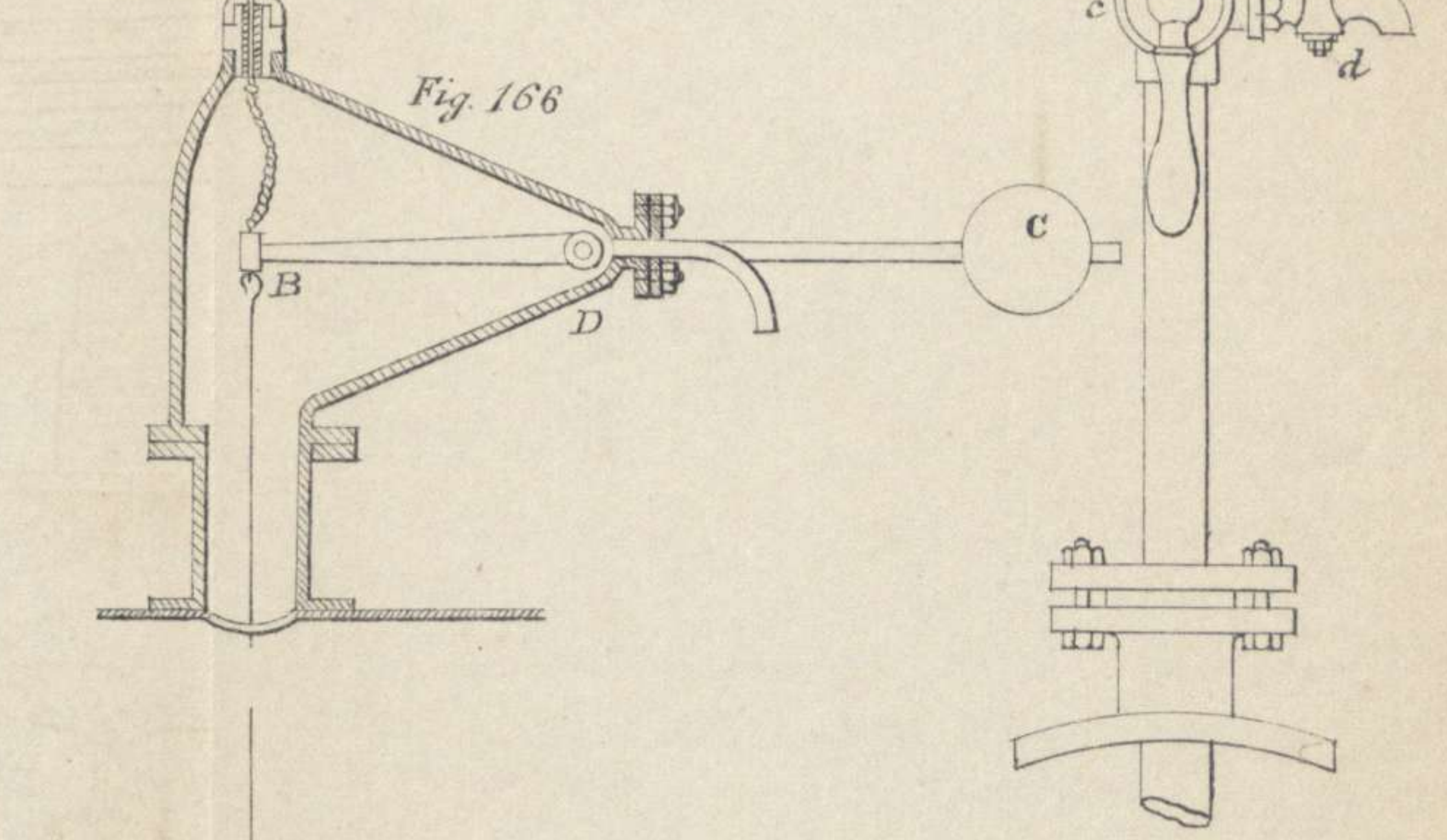
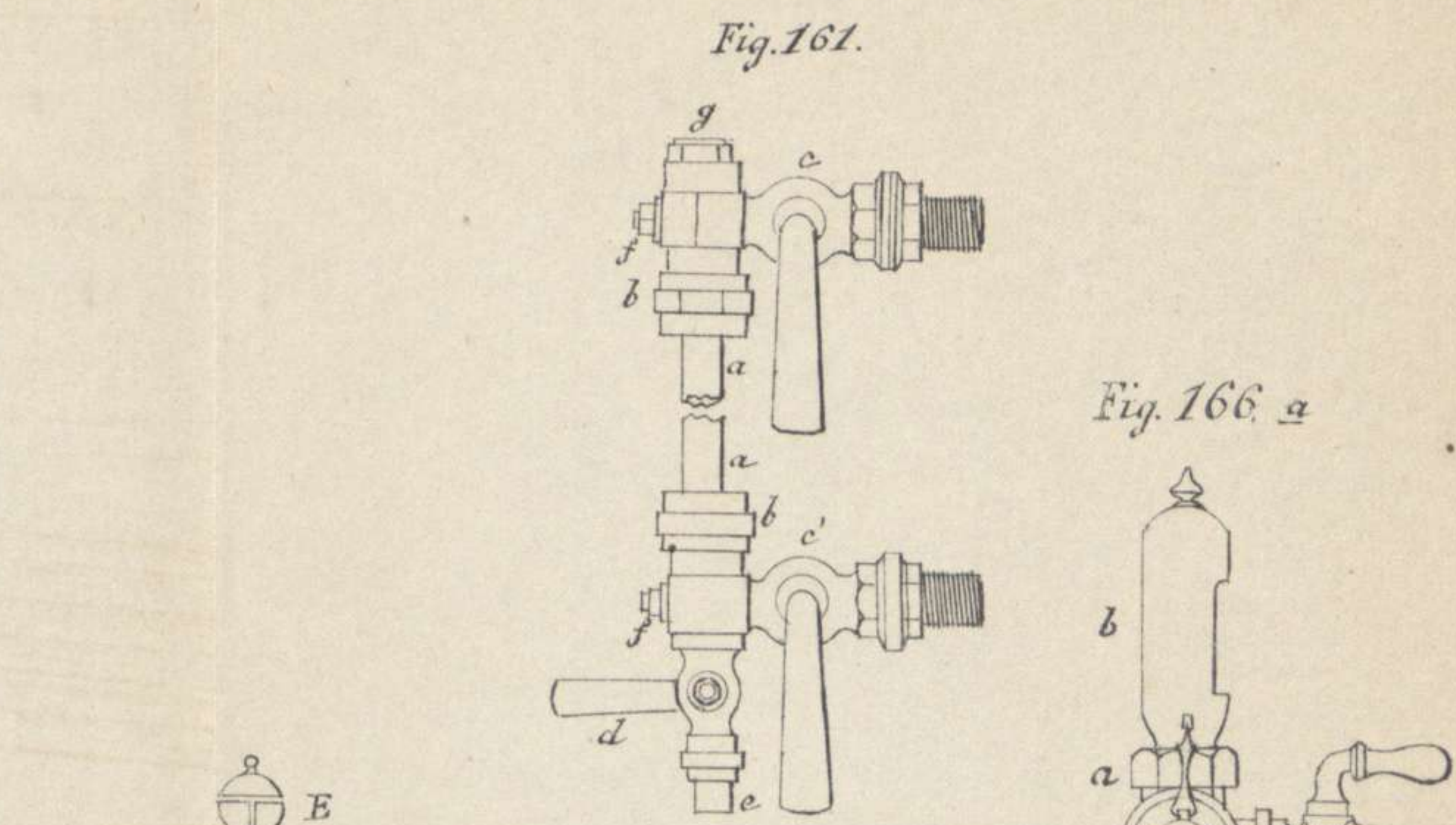
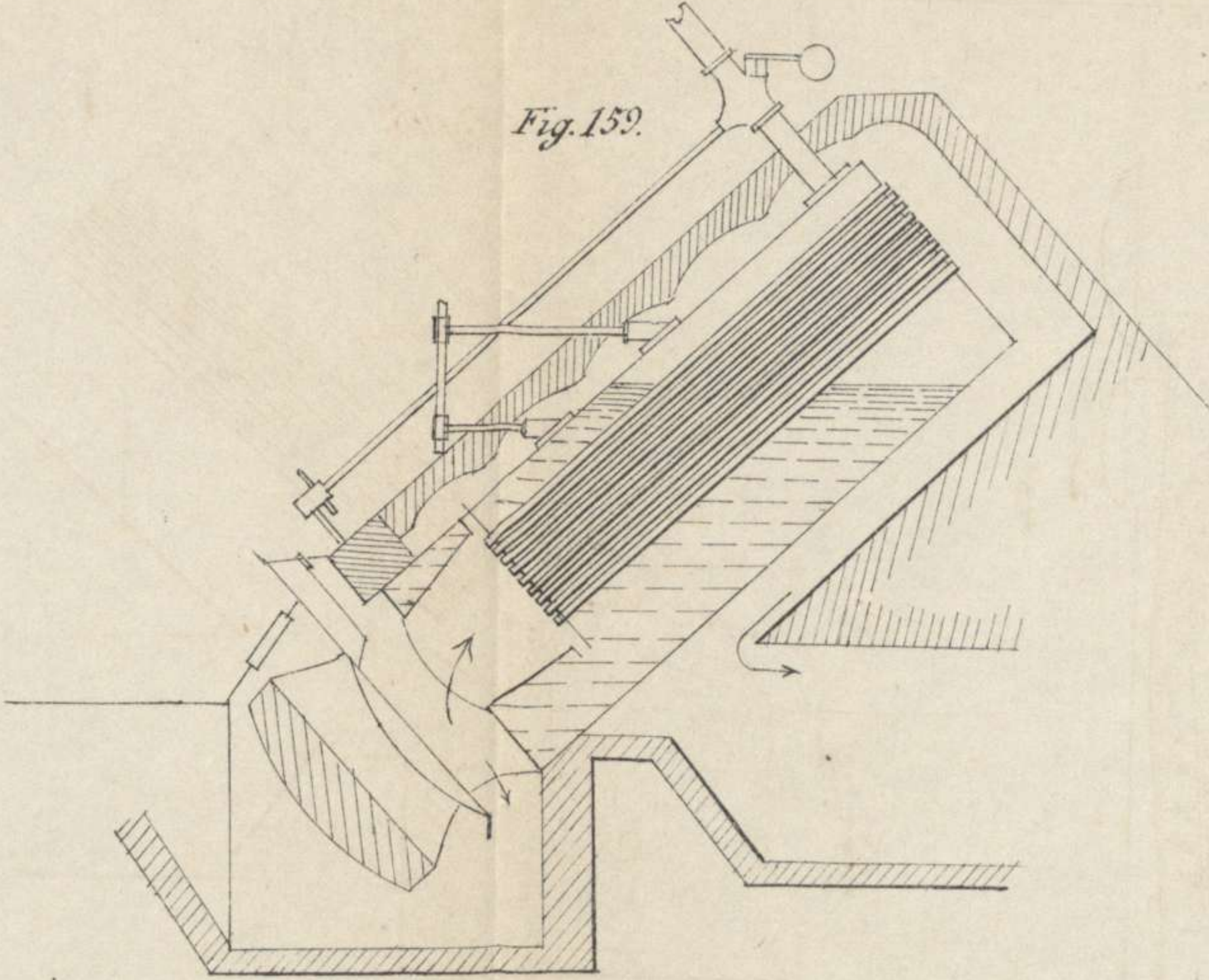
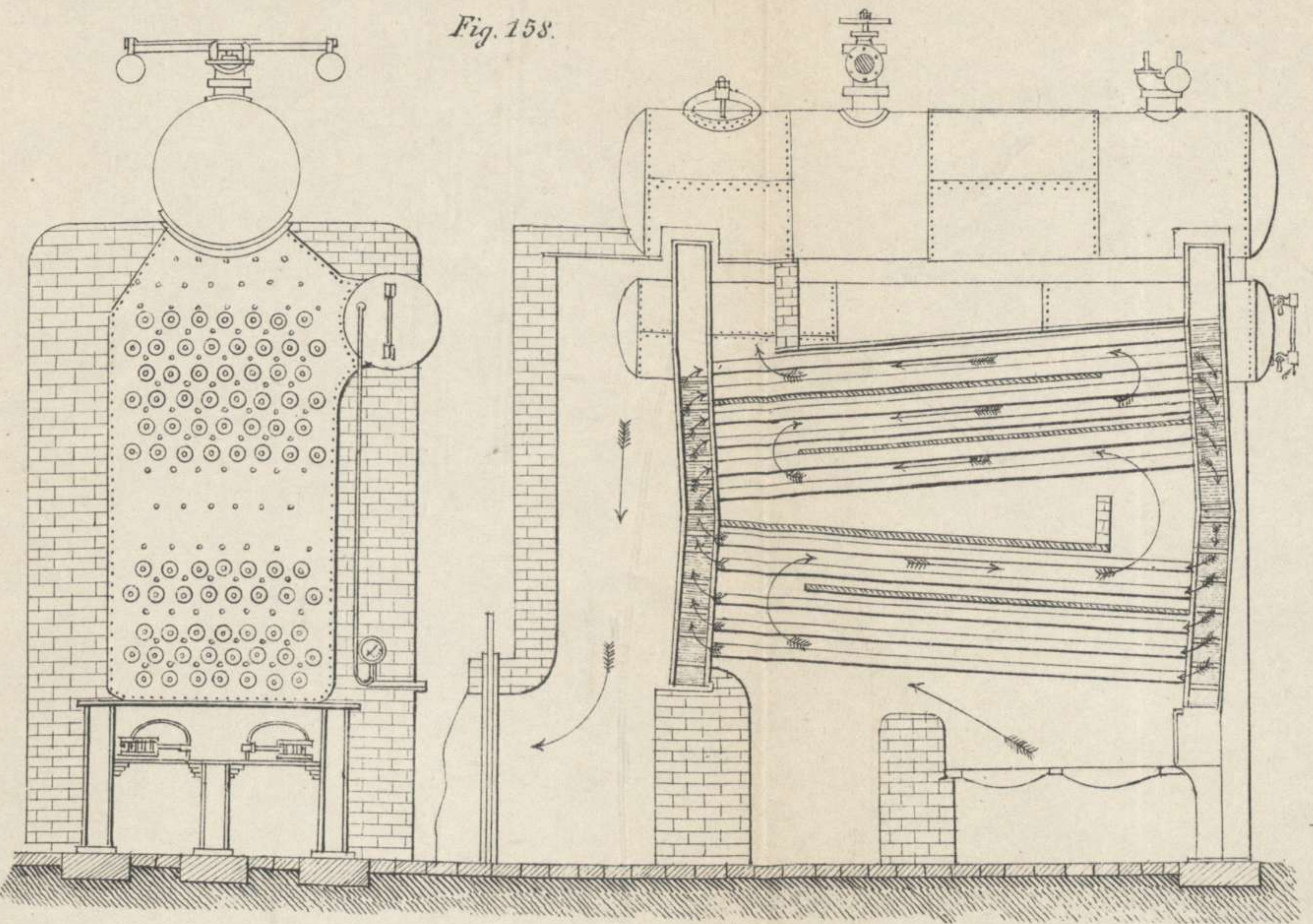
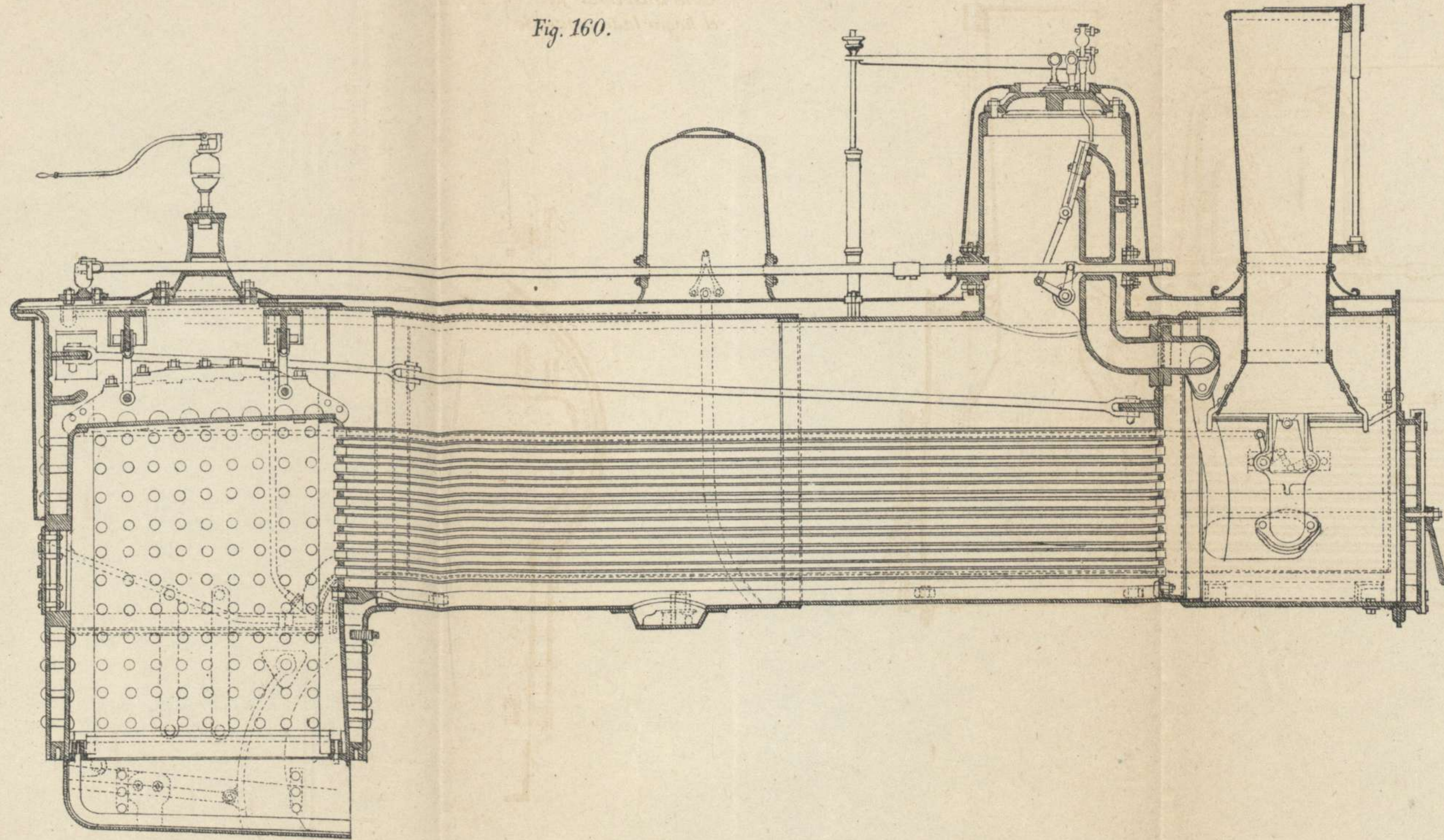
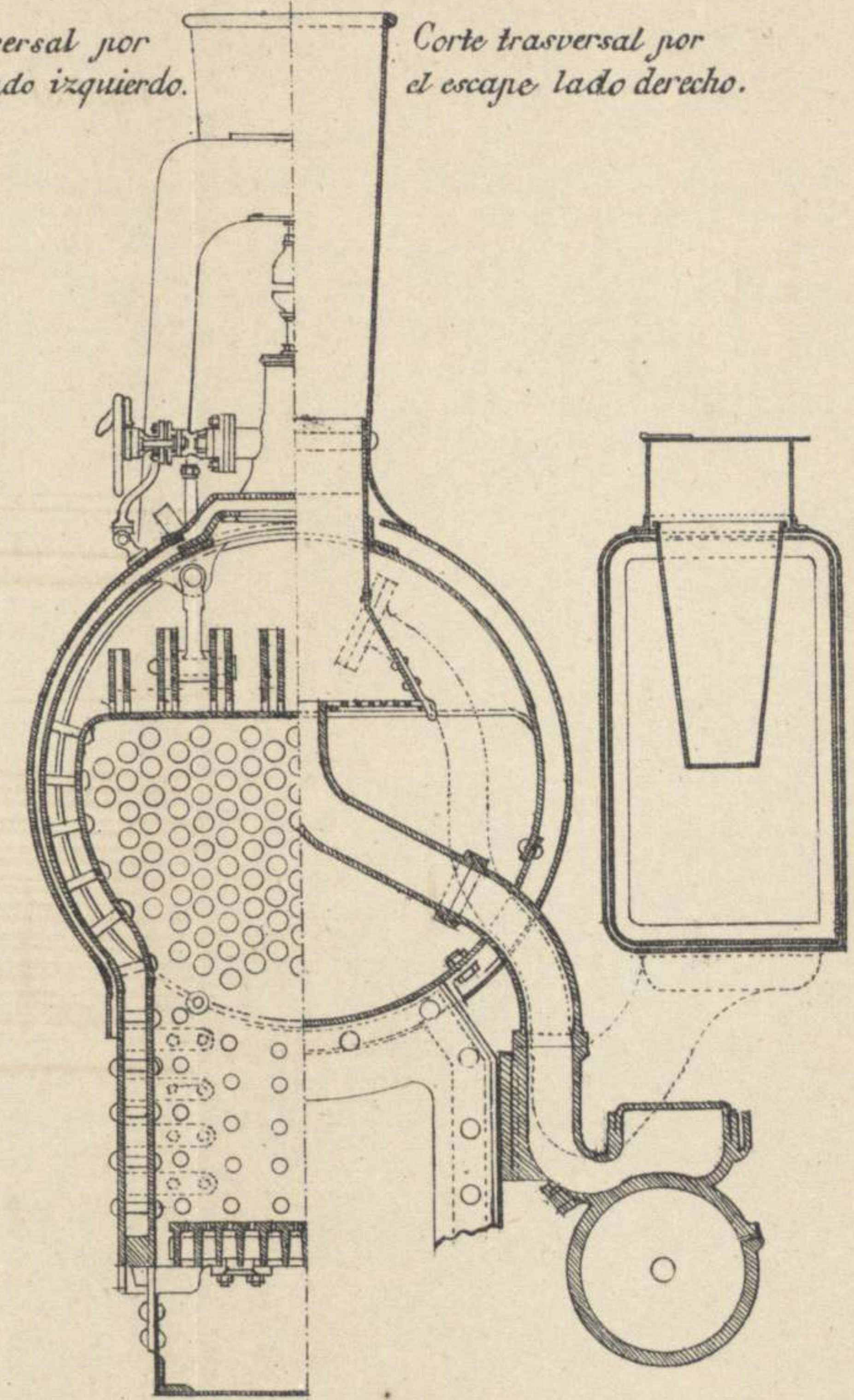

Fig. 160.



Corte trasversal por el hogar lado izquierdo.

Corte trasversal por el escape lado derecho.



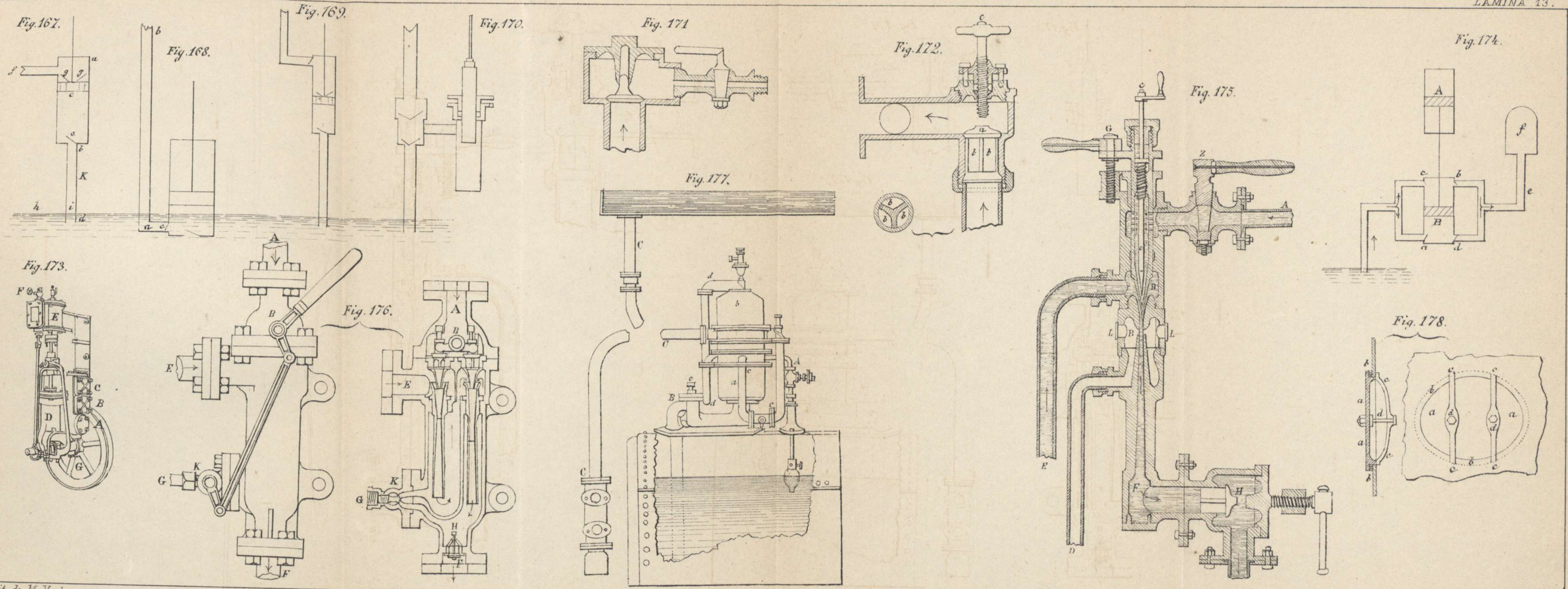

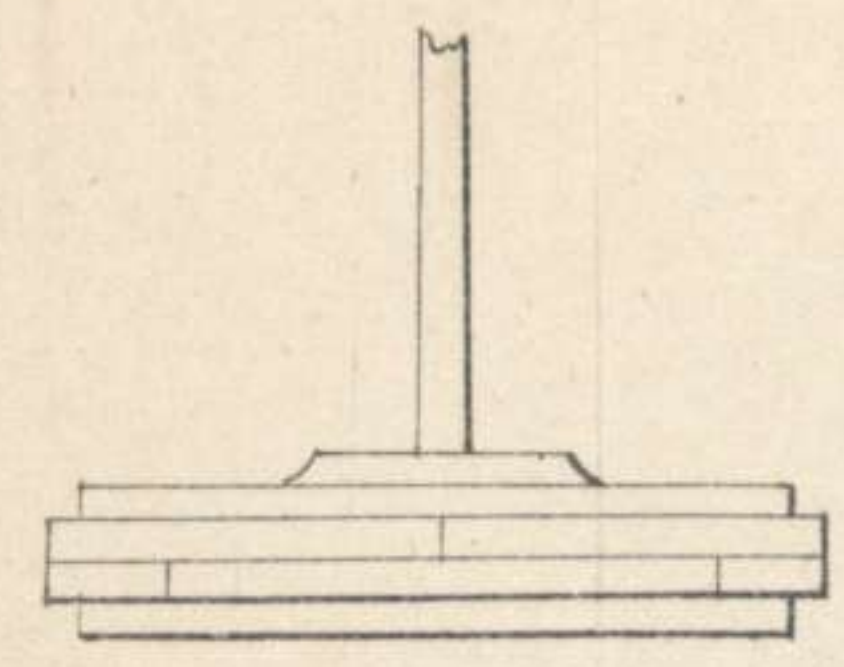

Fig. 179.

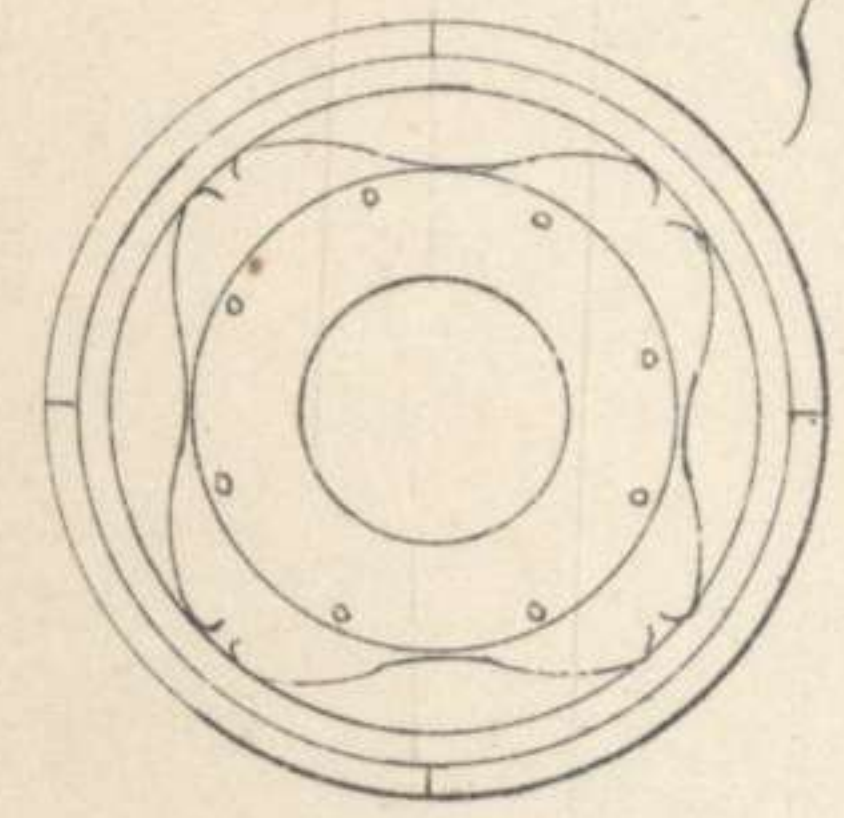

Fig. 182.

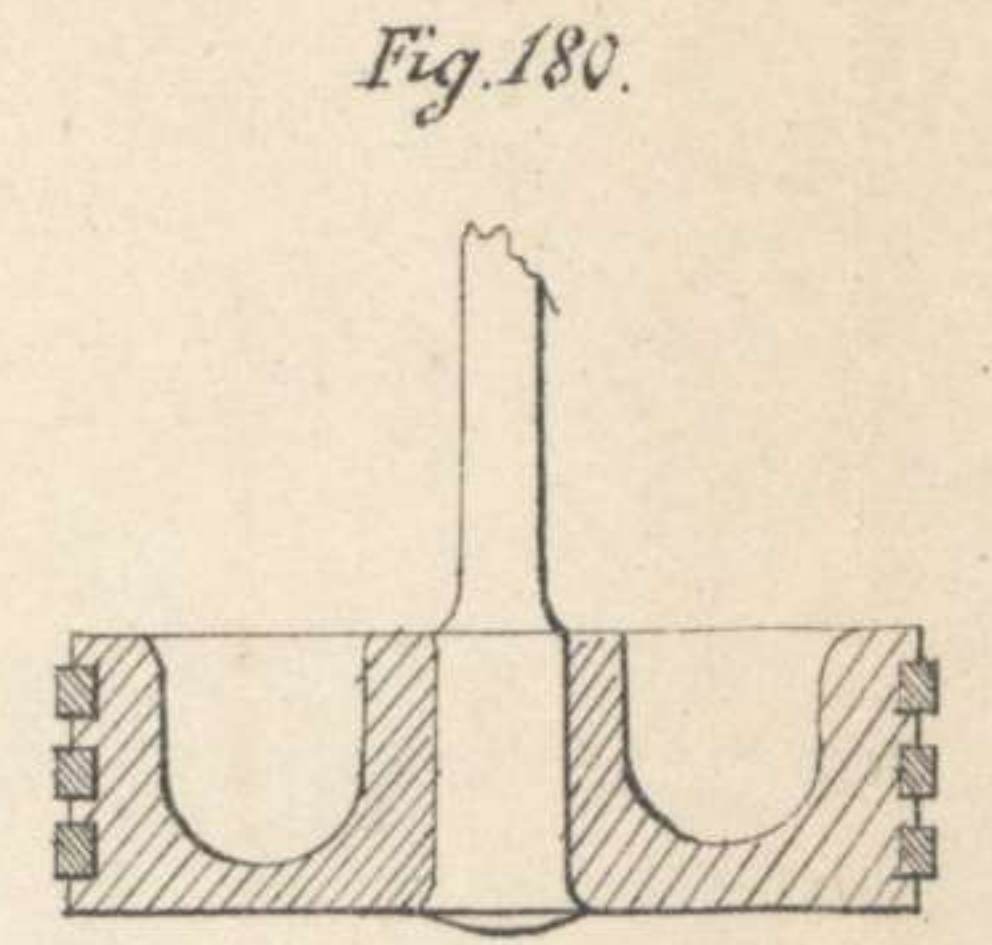
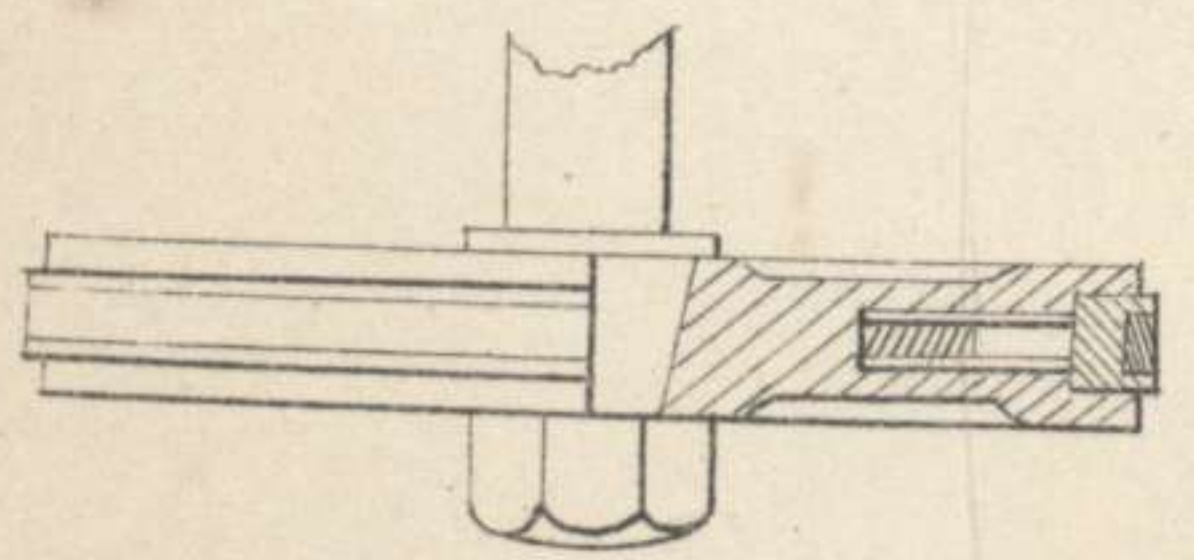

Fig. 183.

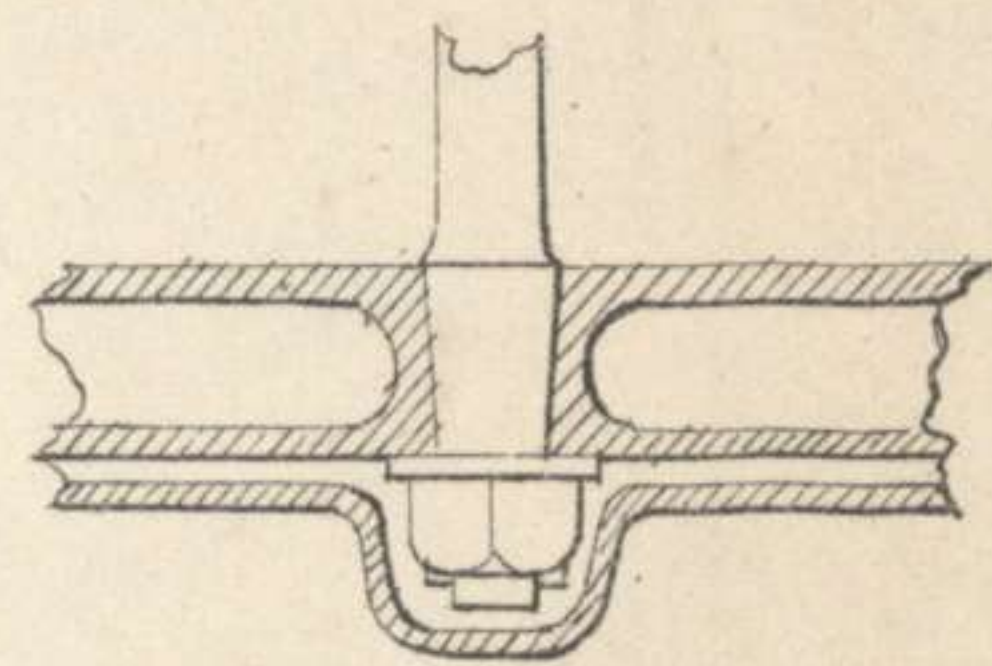
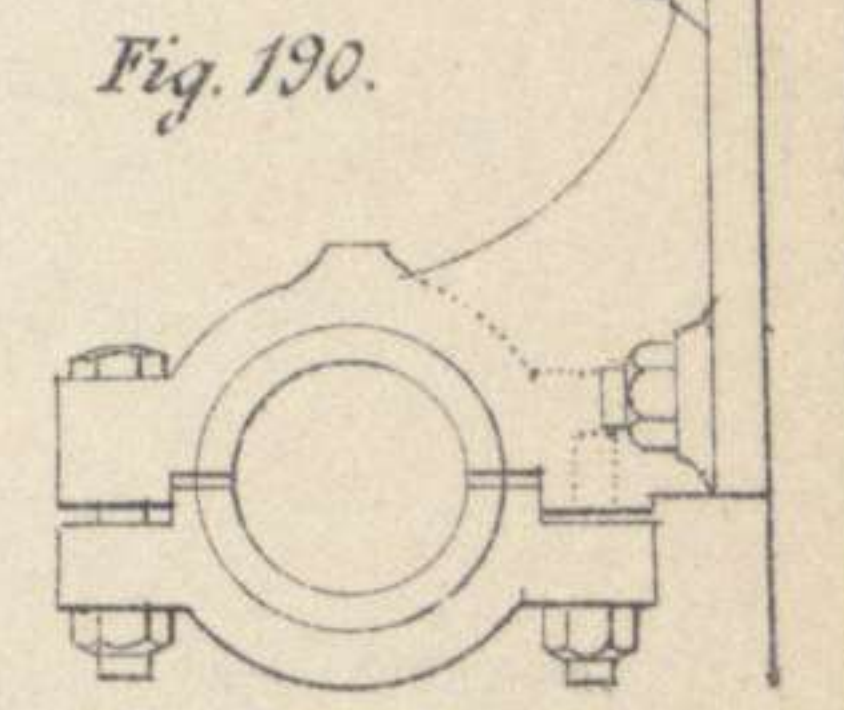
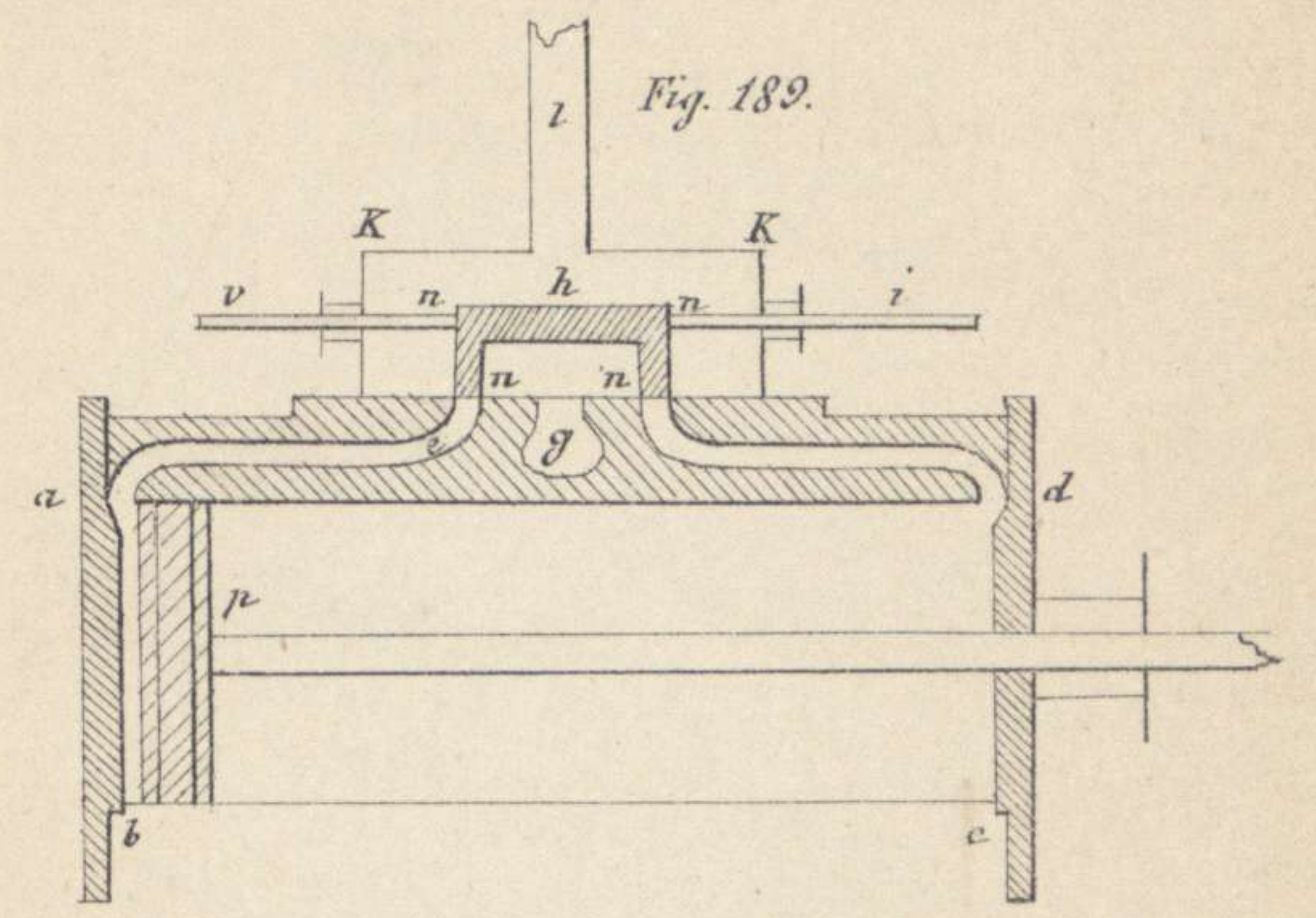
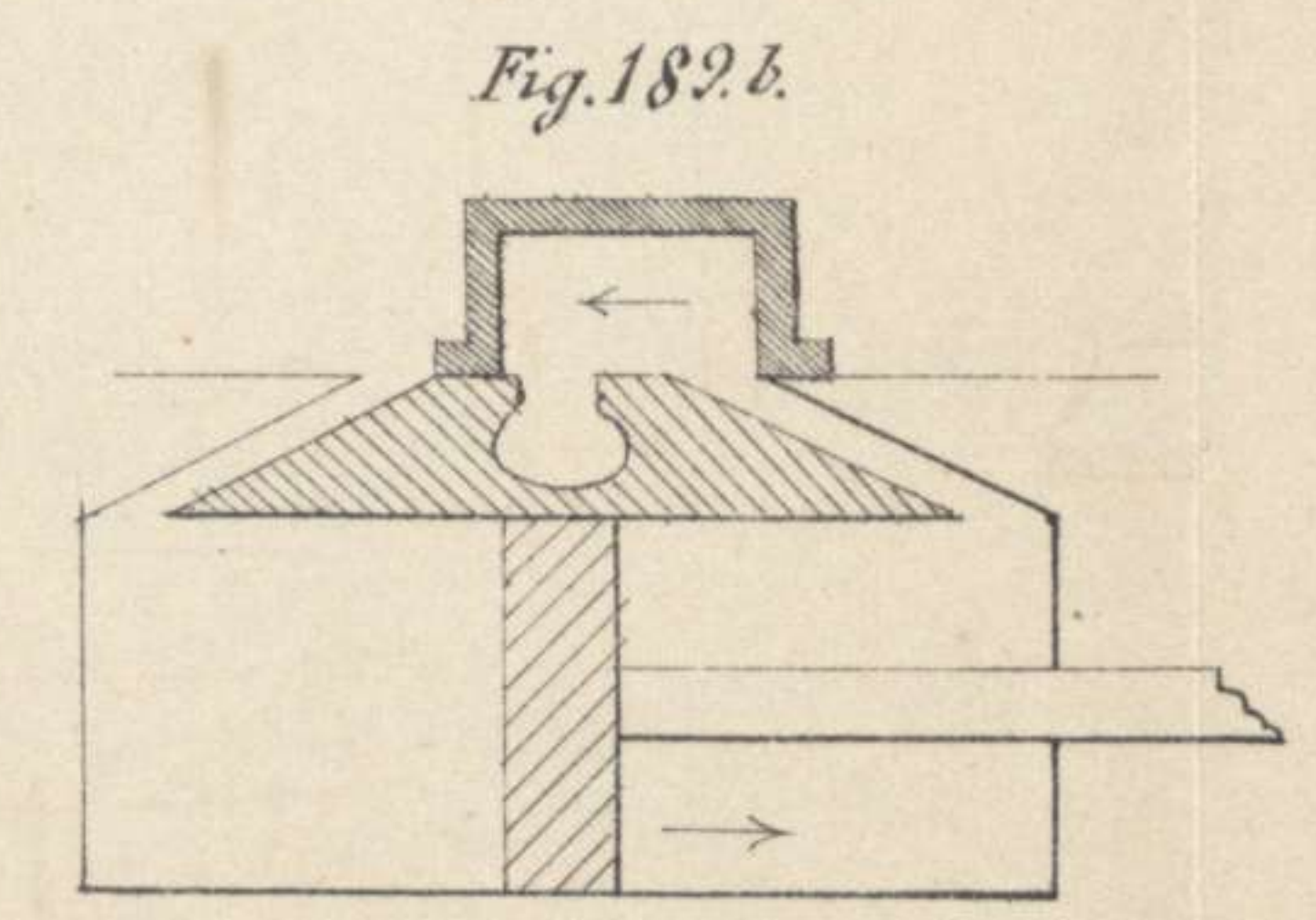
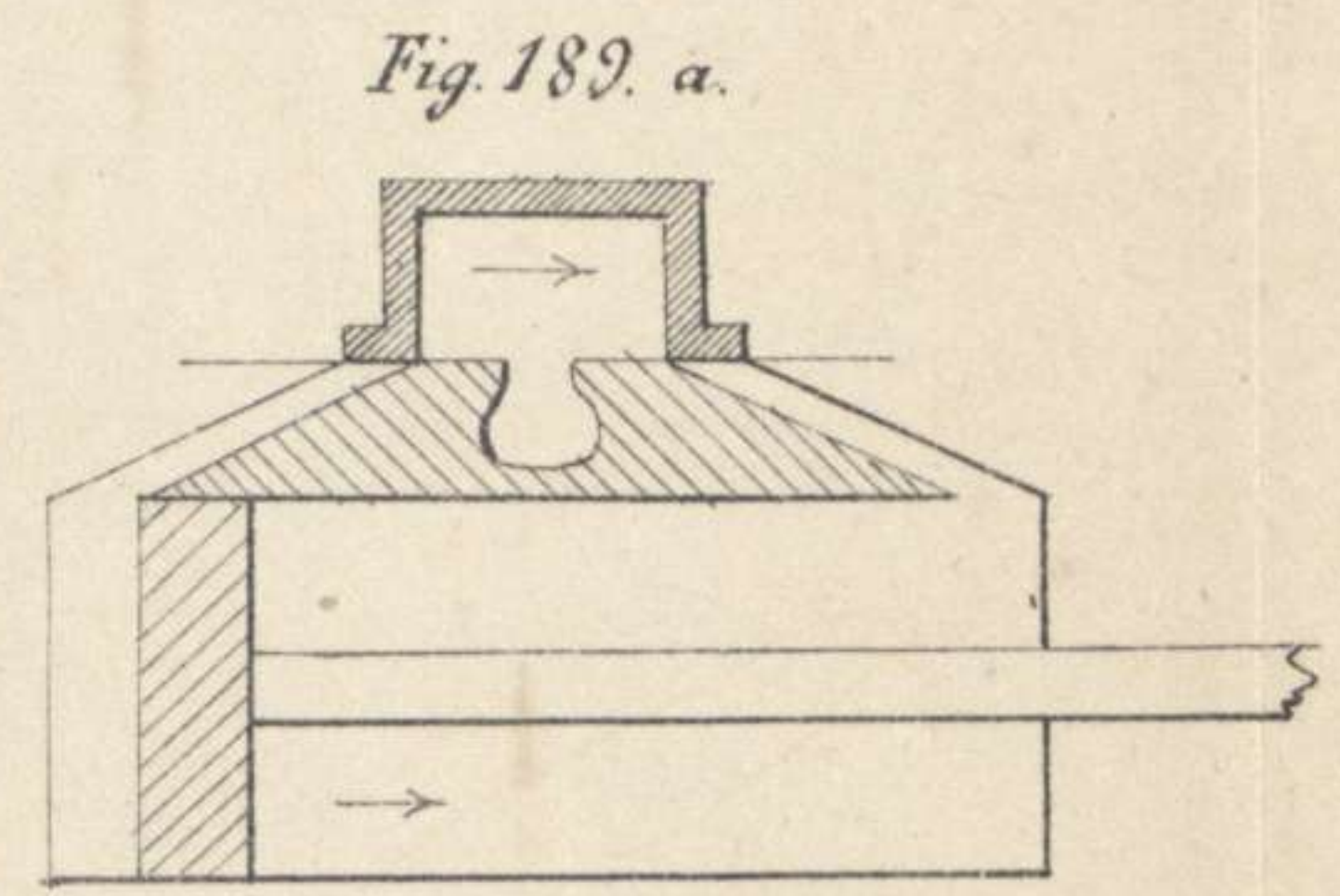
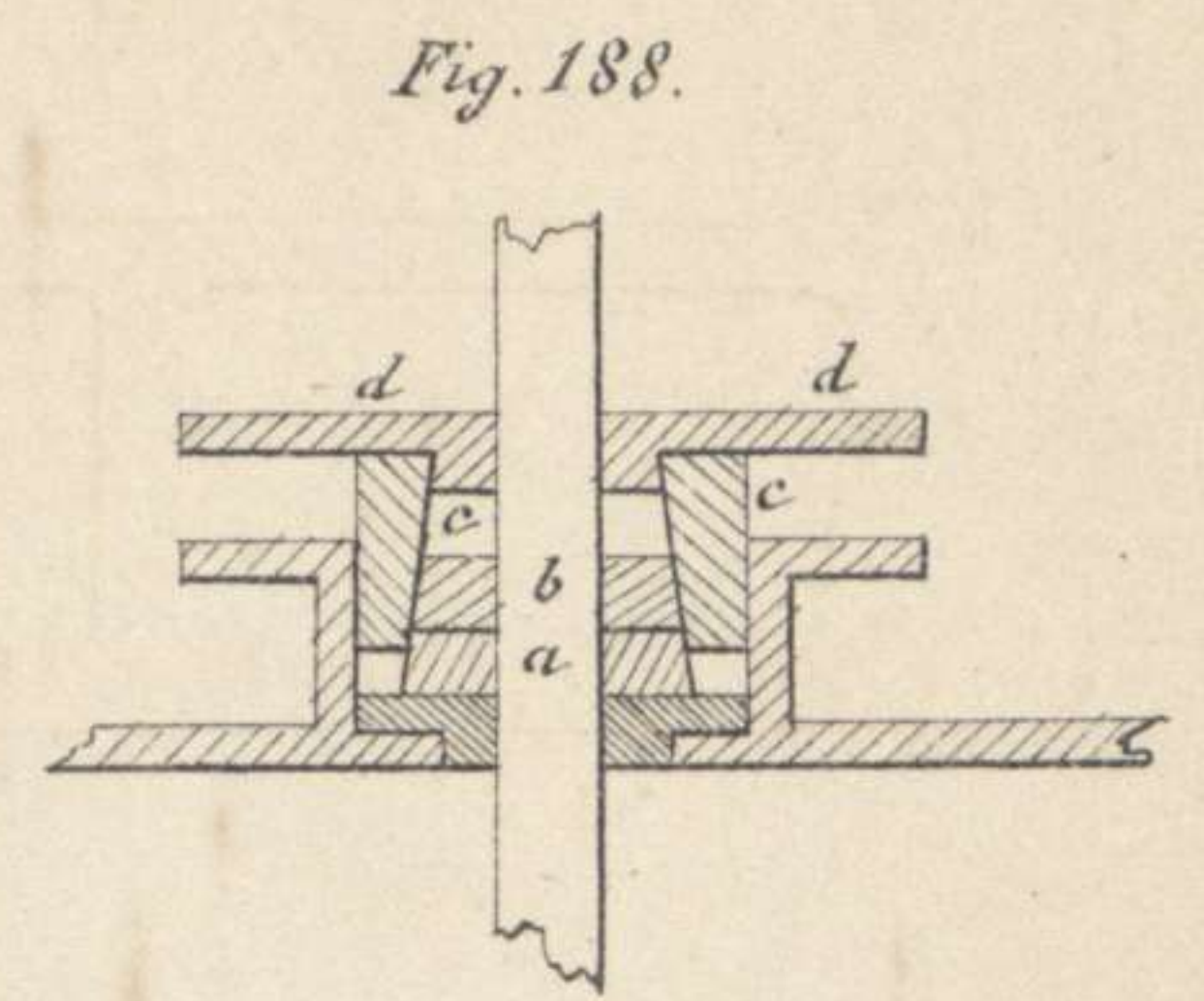
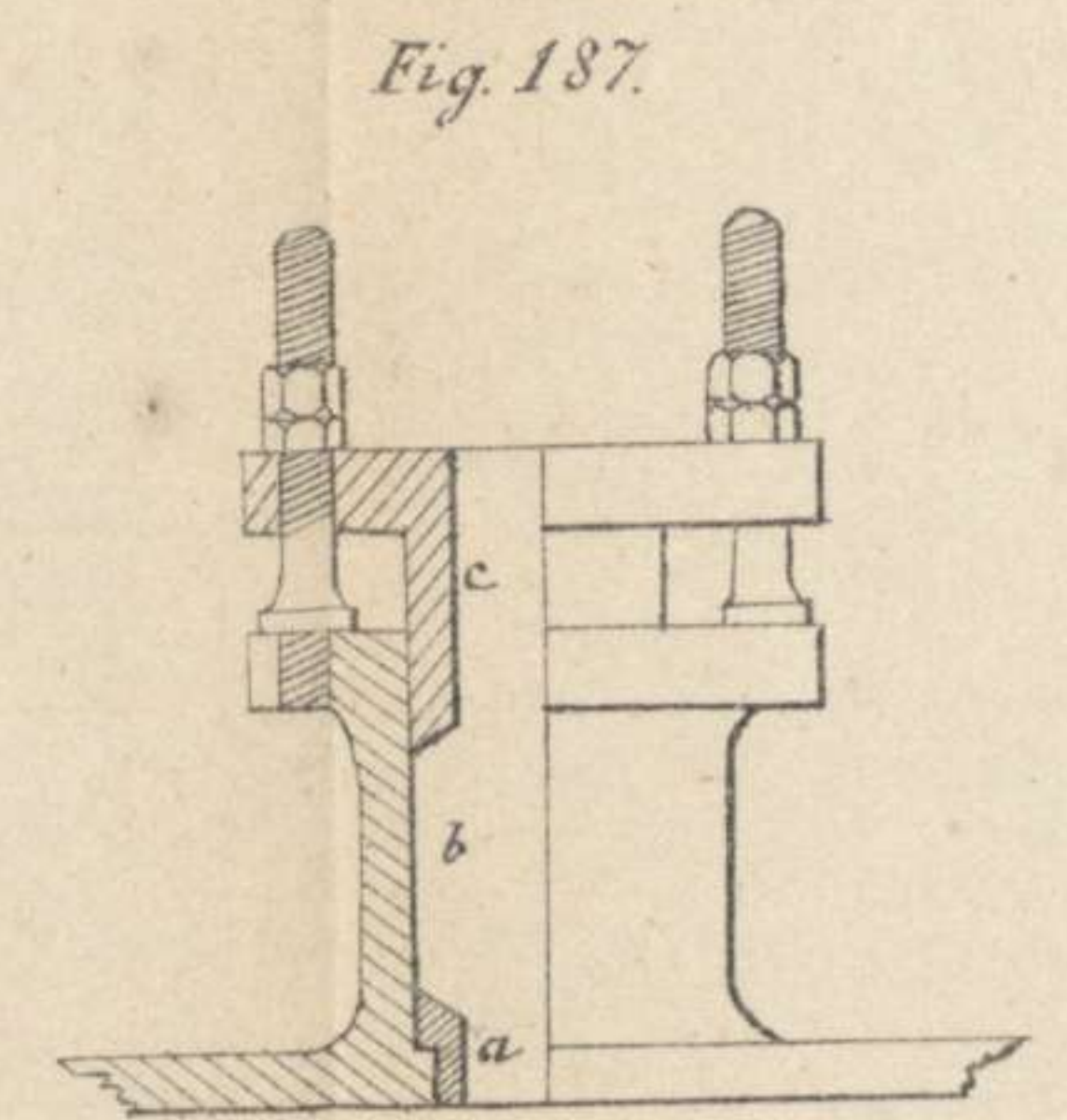
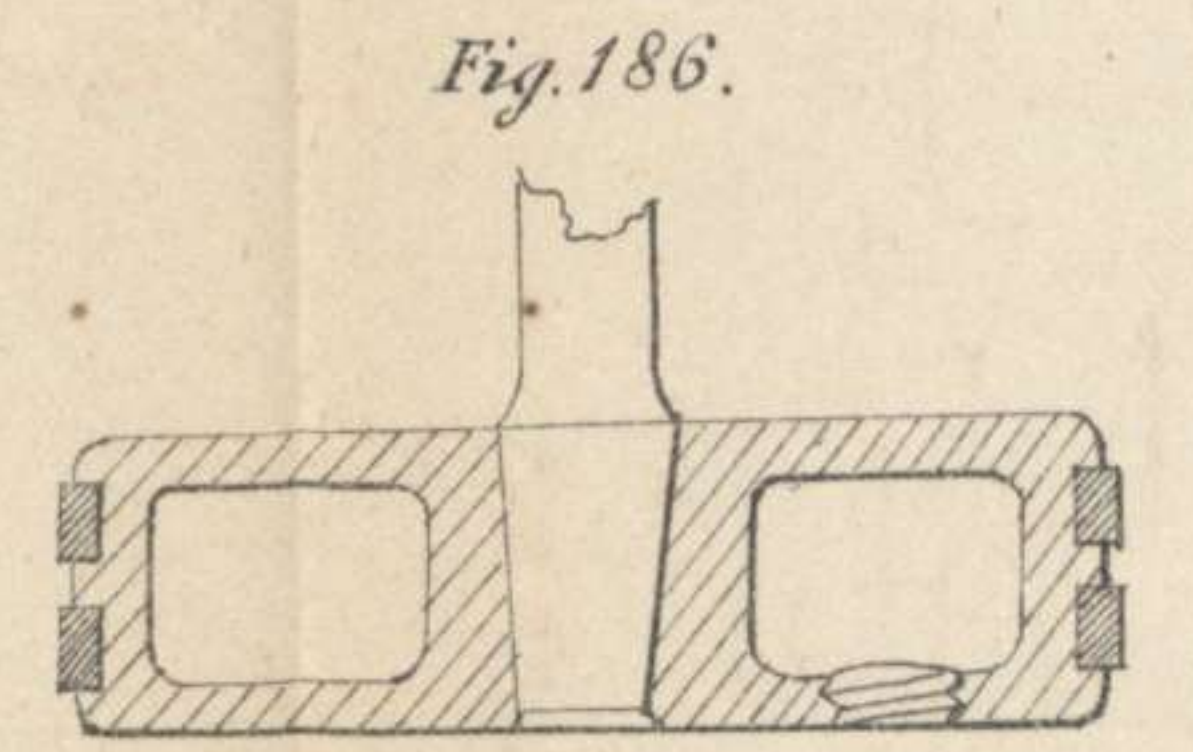
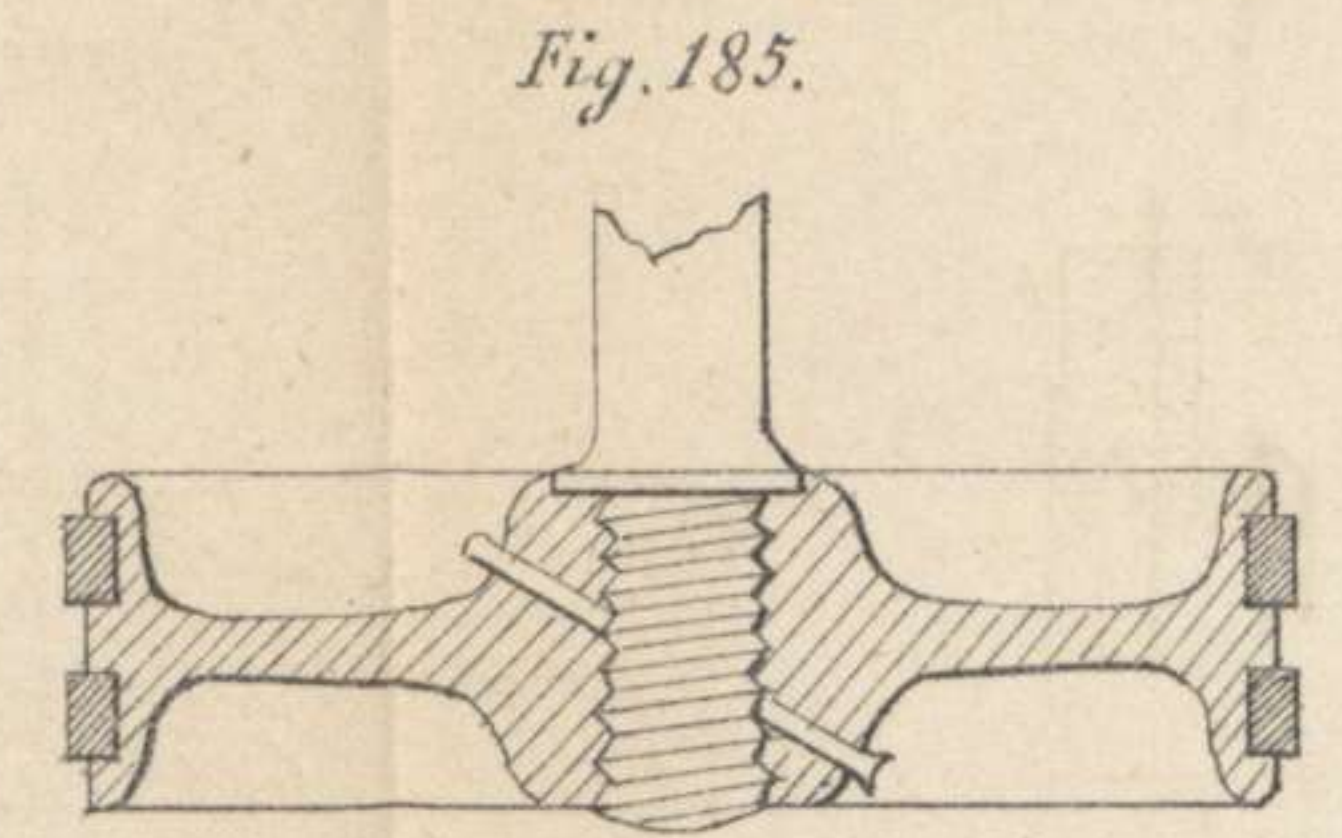
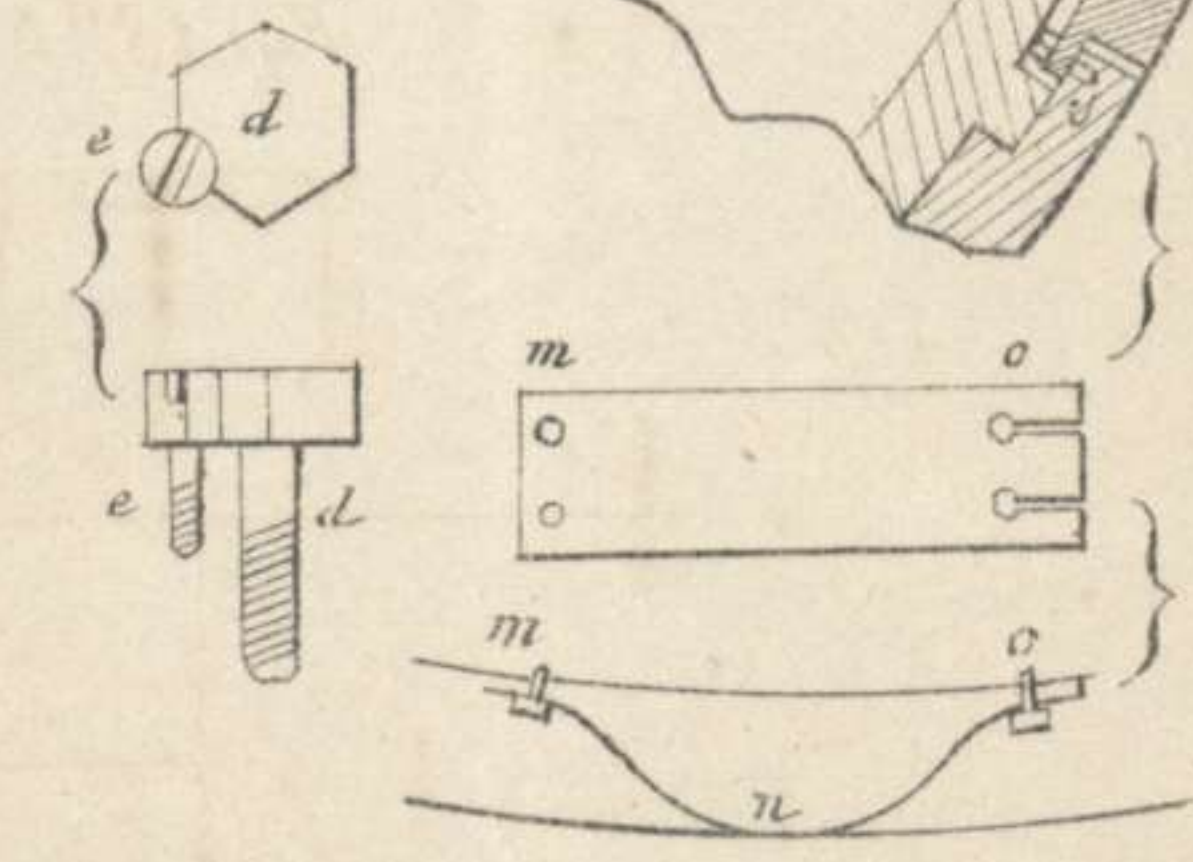
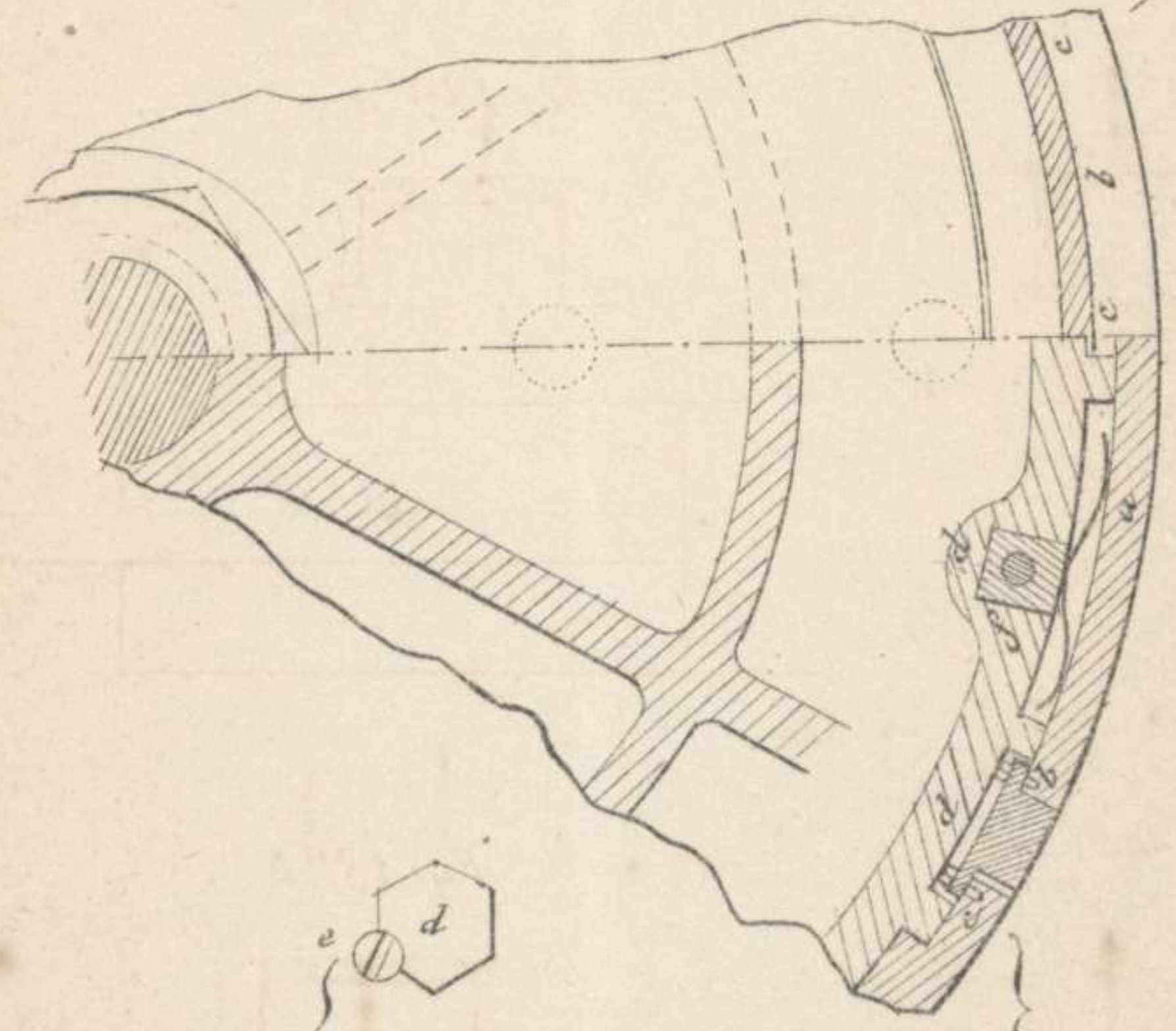
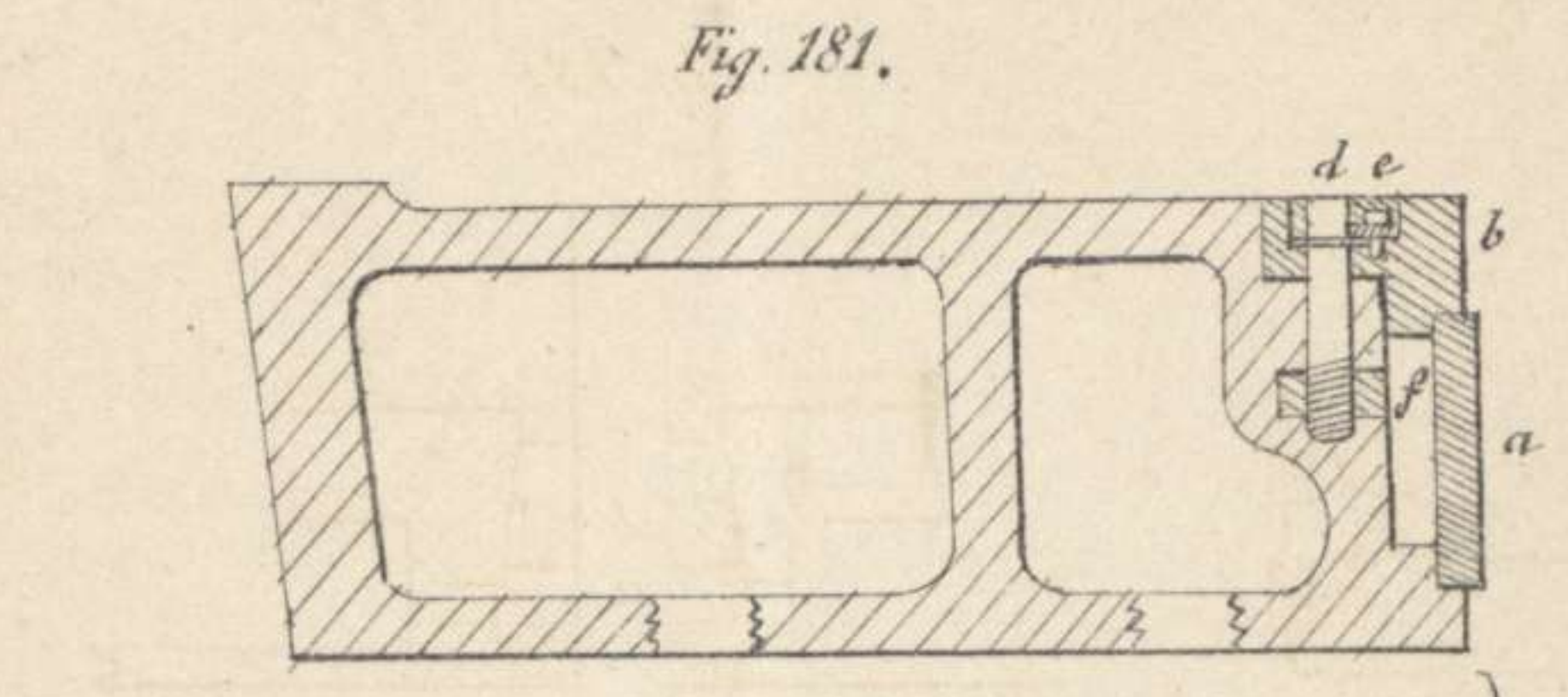
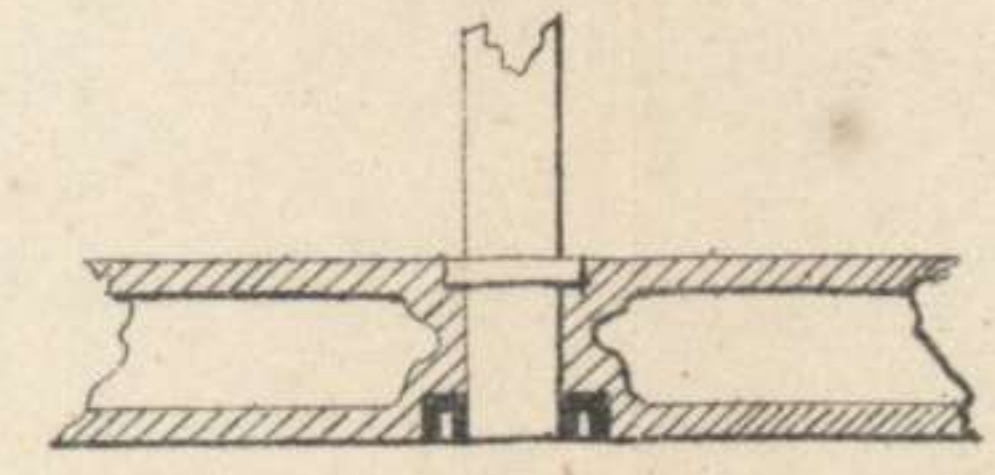

Fig. 184.



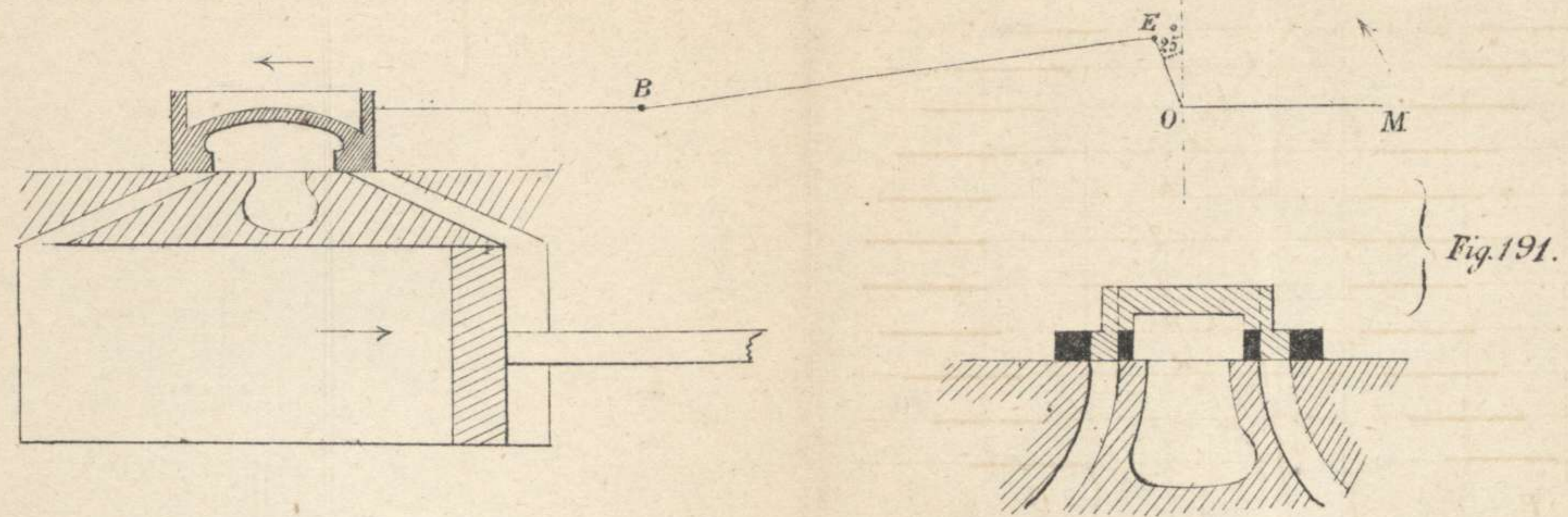

Fig. 191.

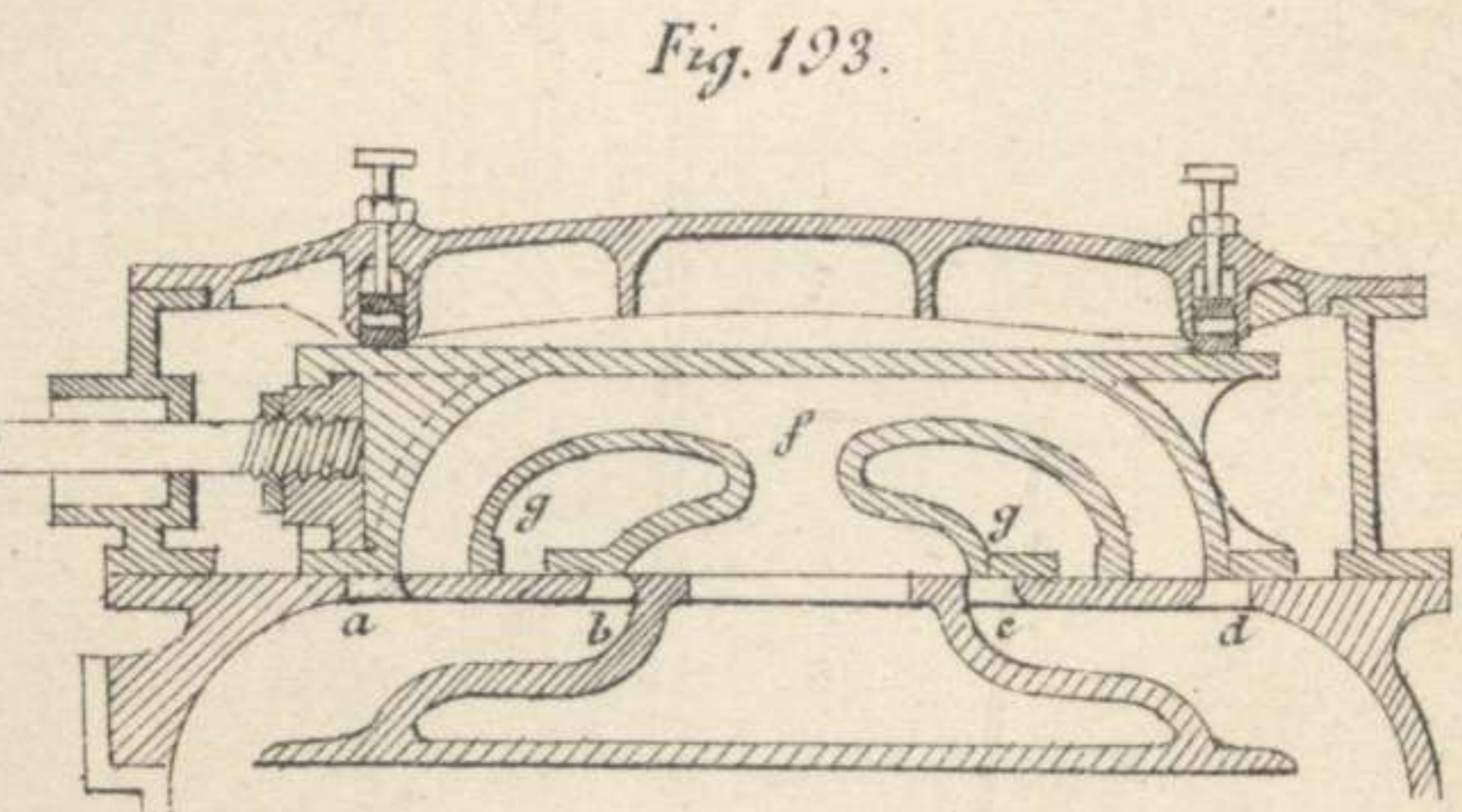

Fig. 193.

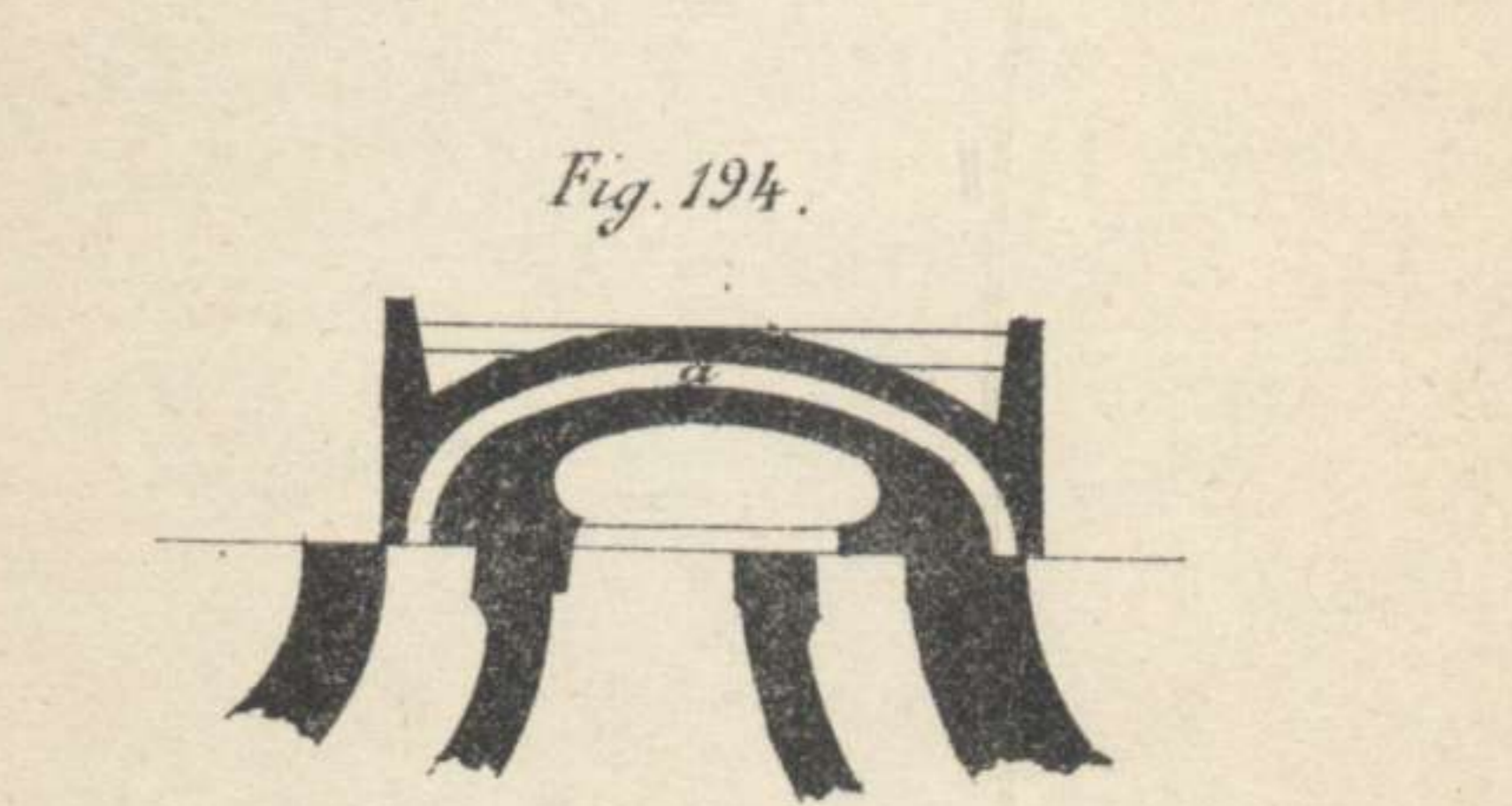

Fig. 194.

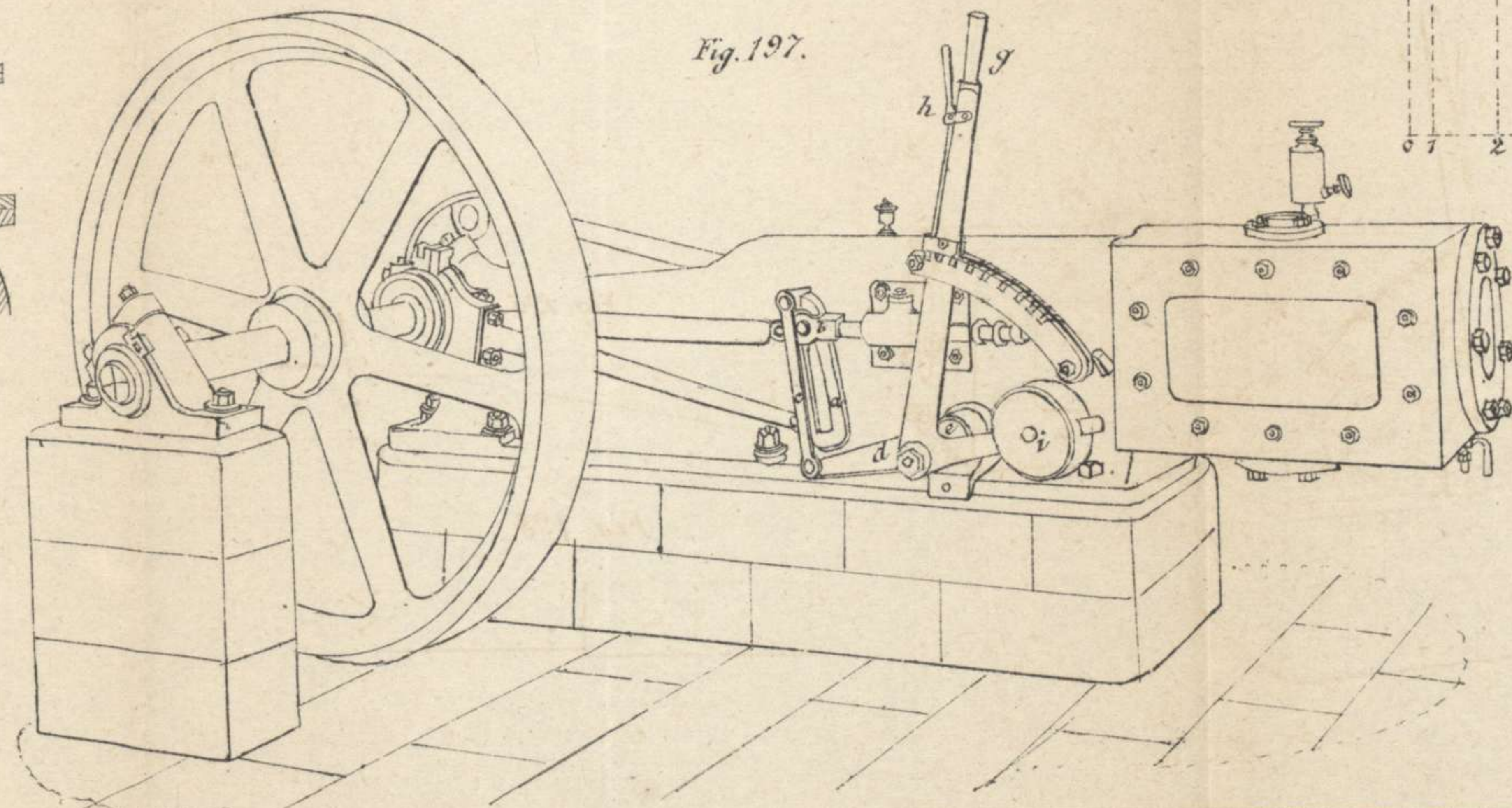

Fig. 197.

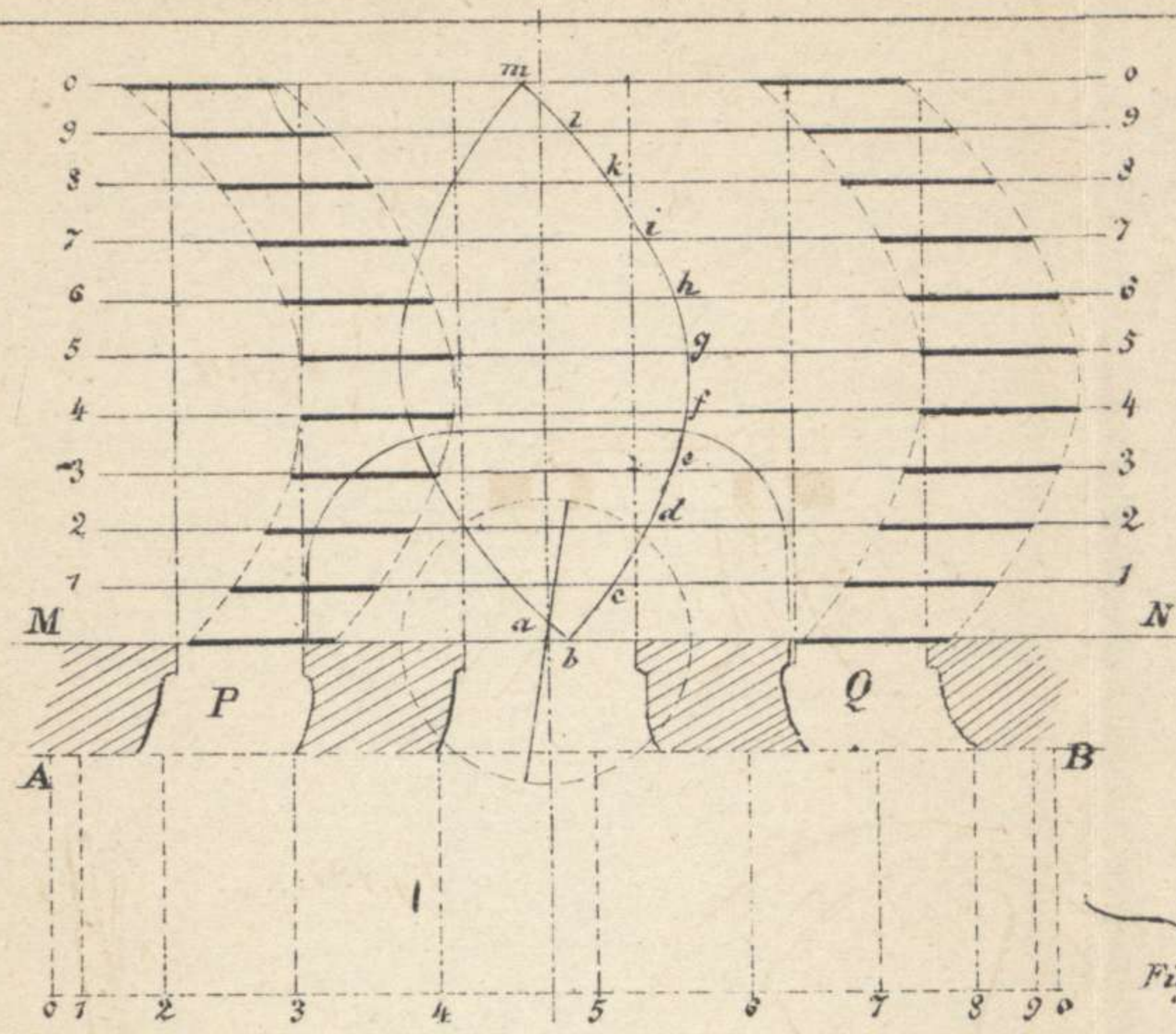

Fig. 192.

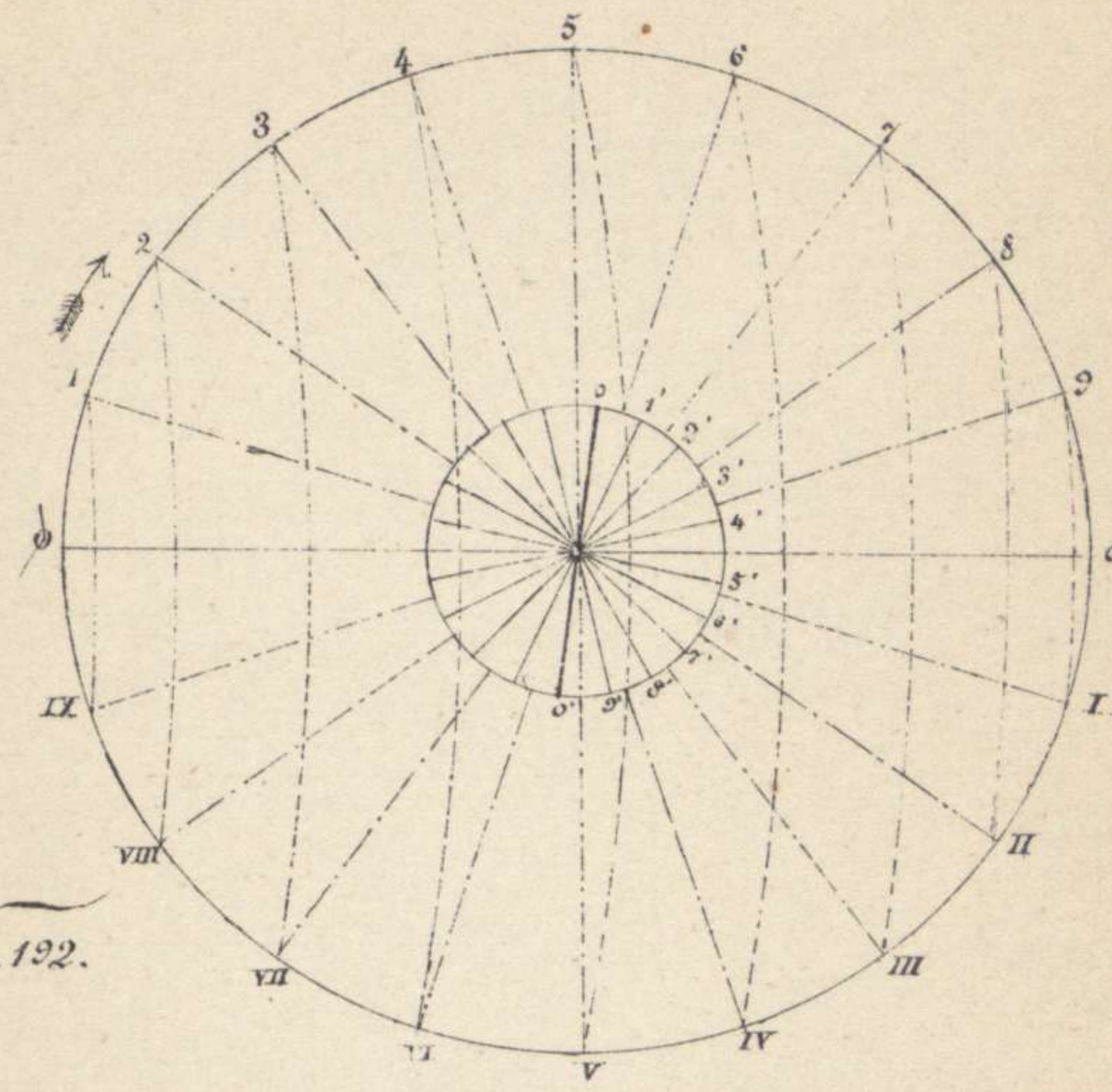

Fig. 199.

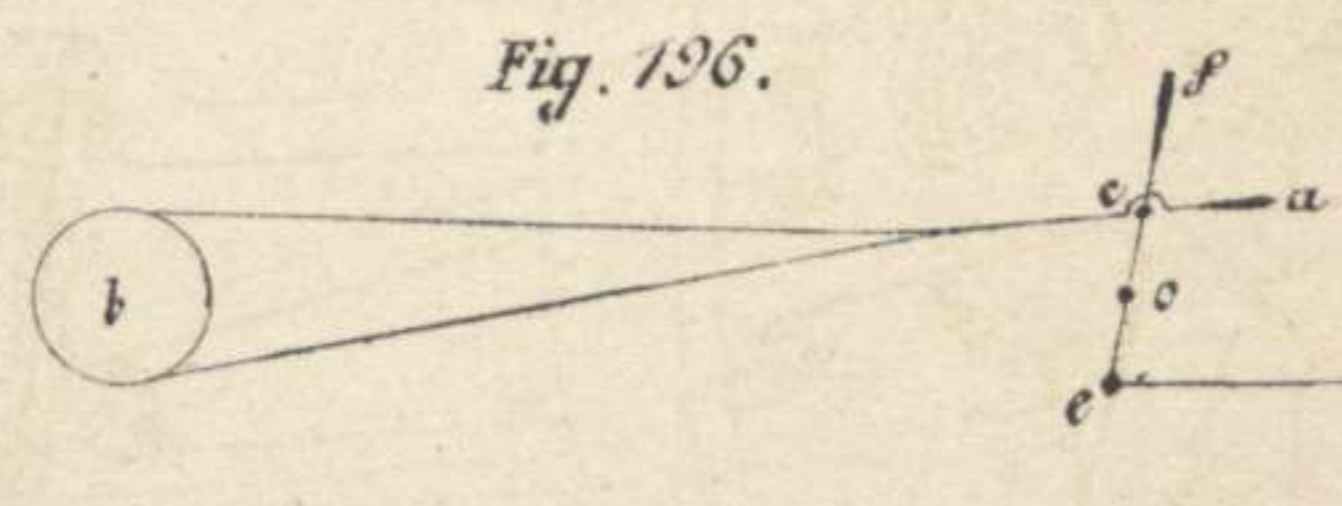

Fig. 196.

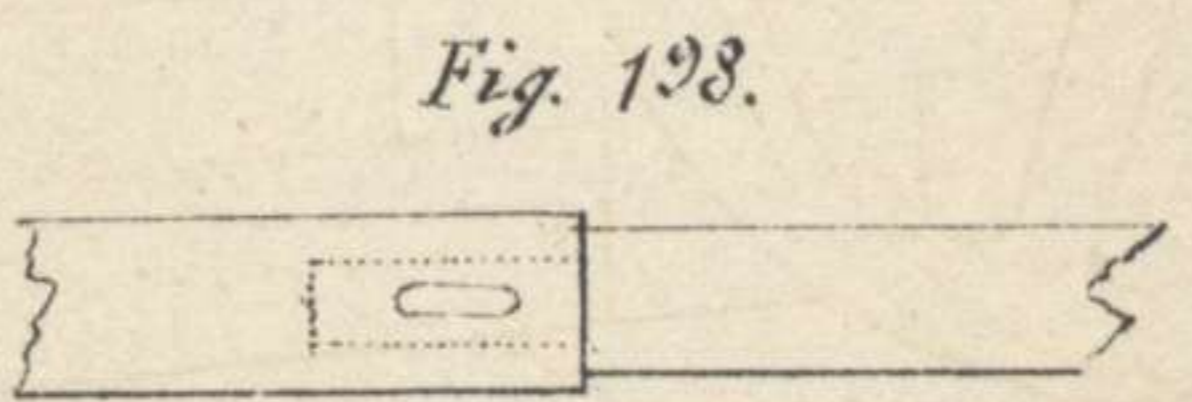
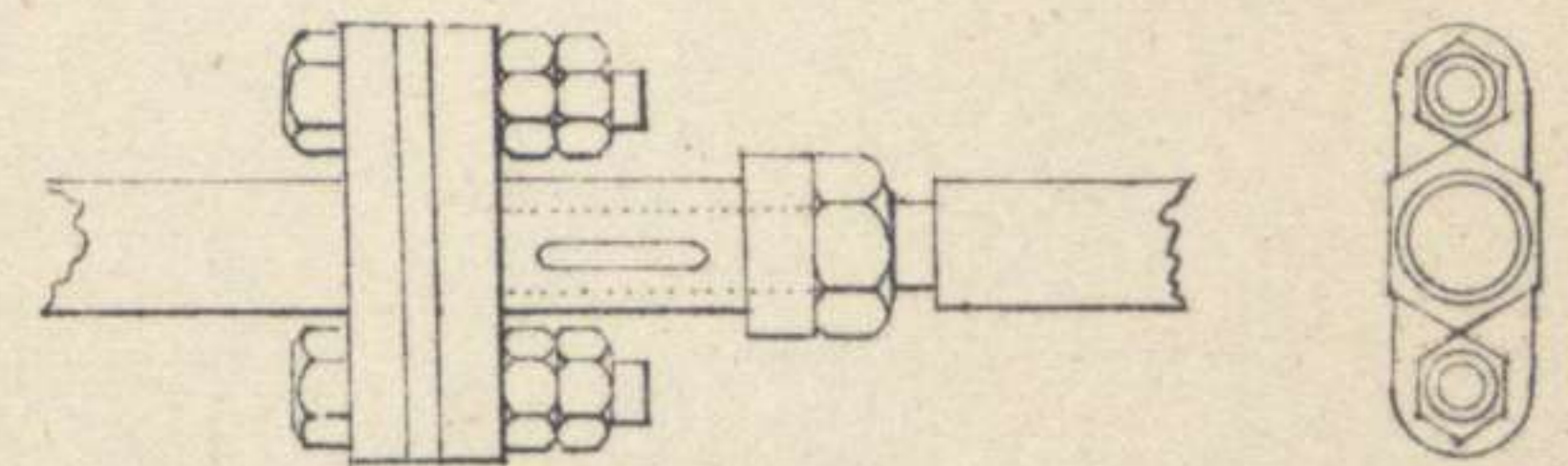
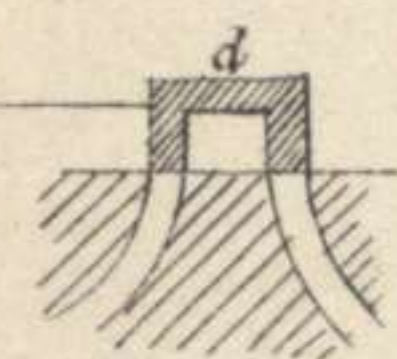
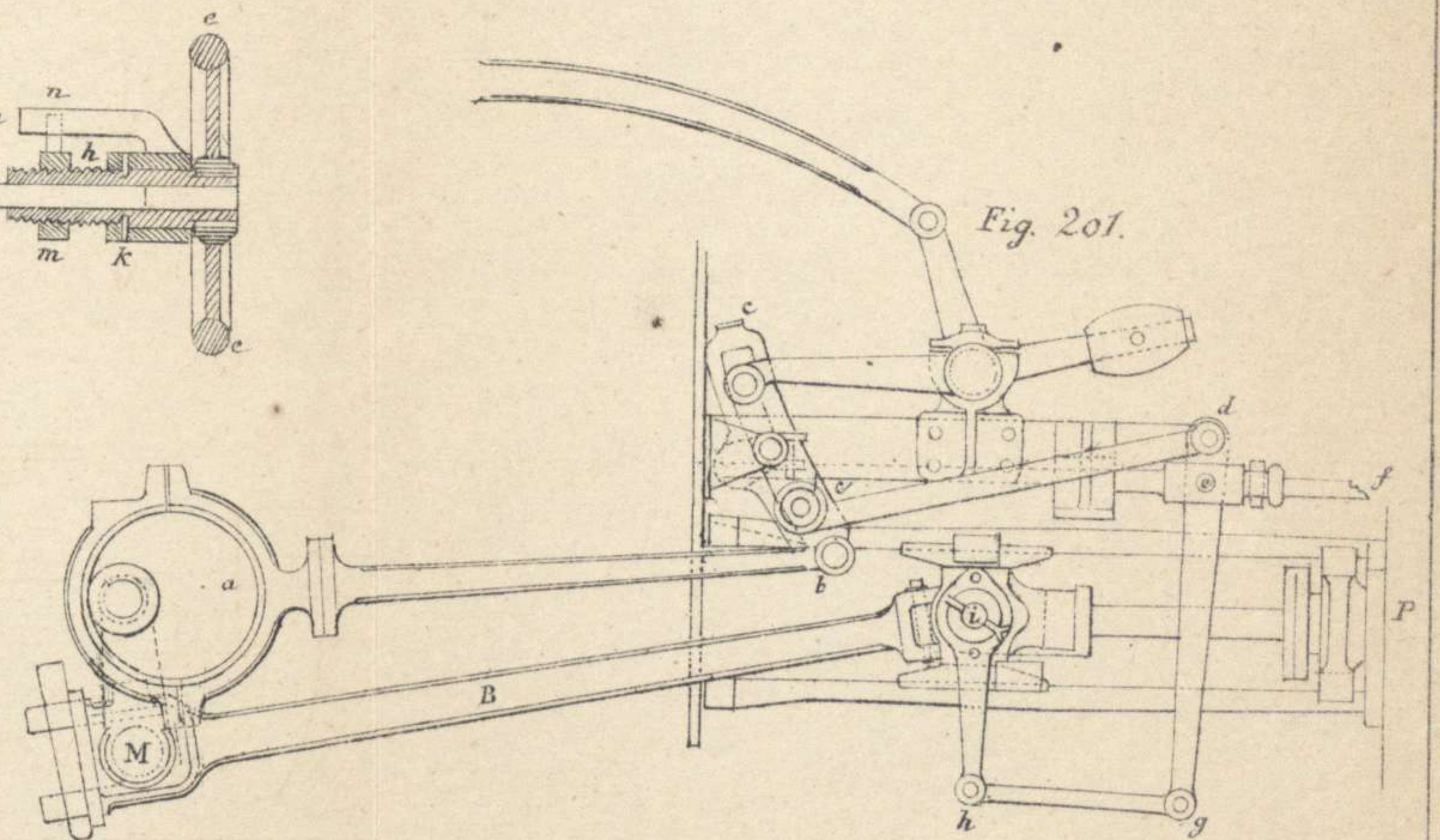
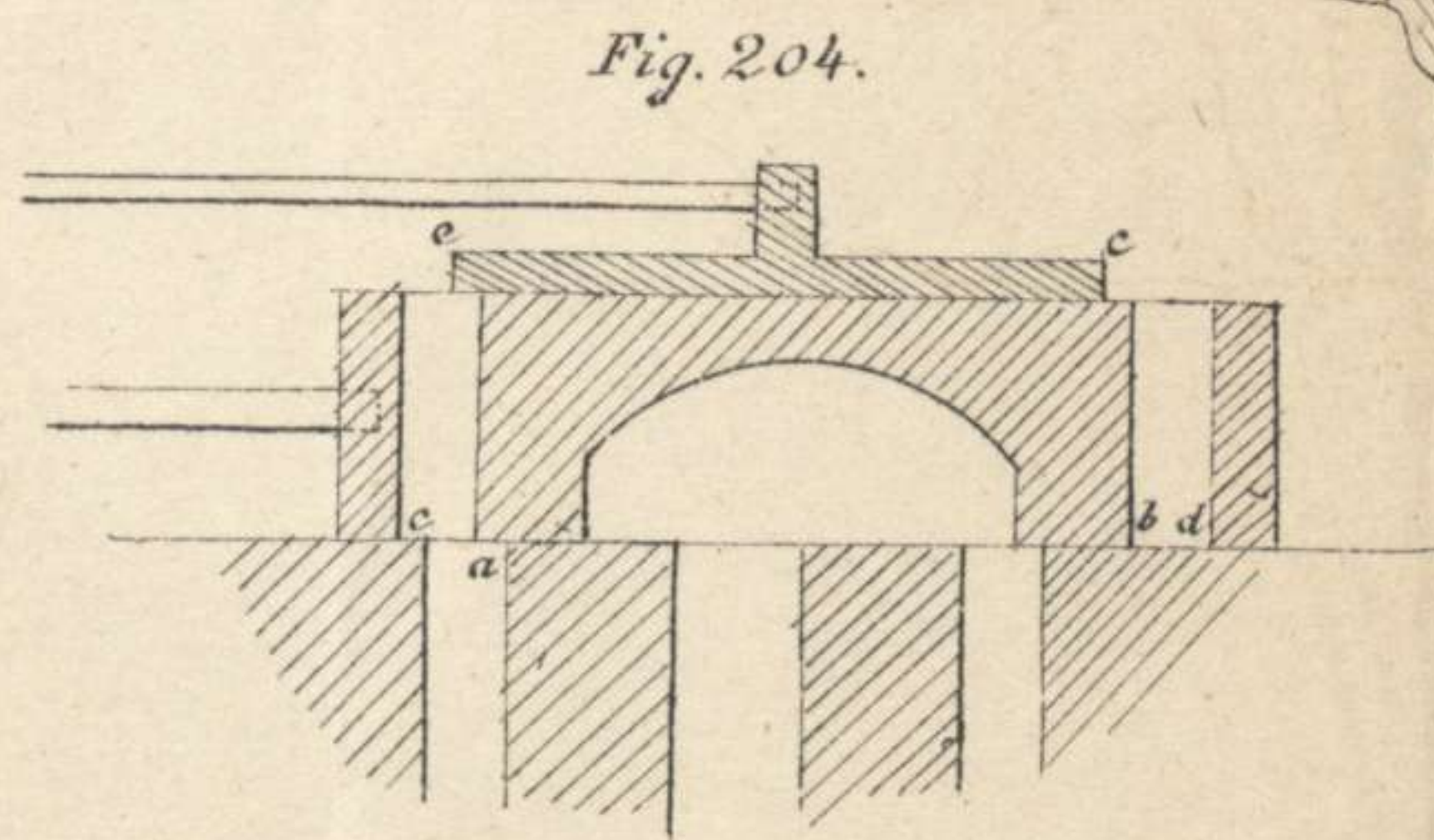
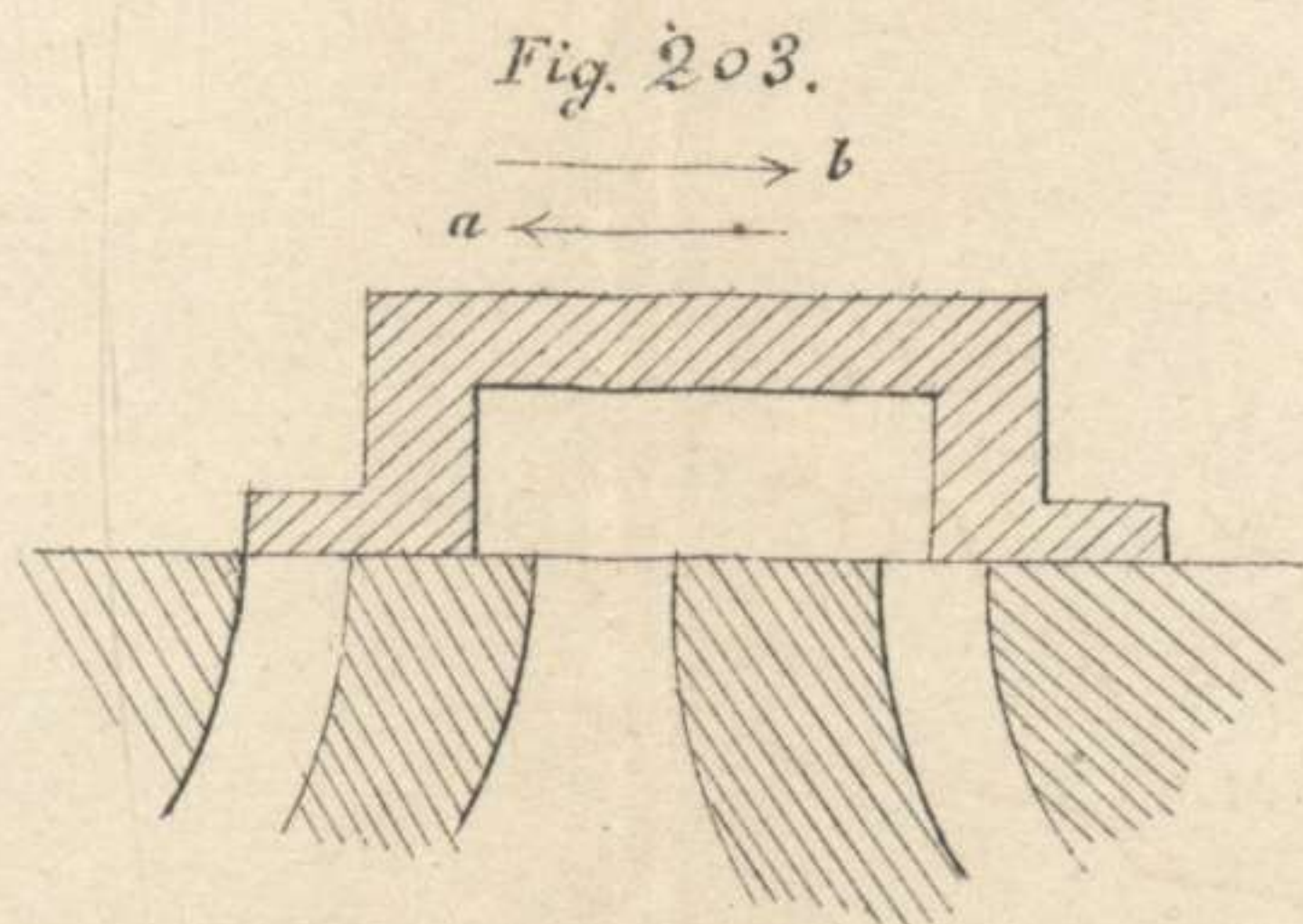
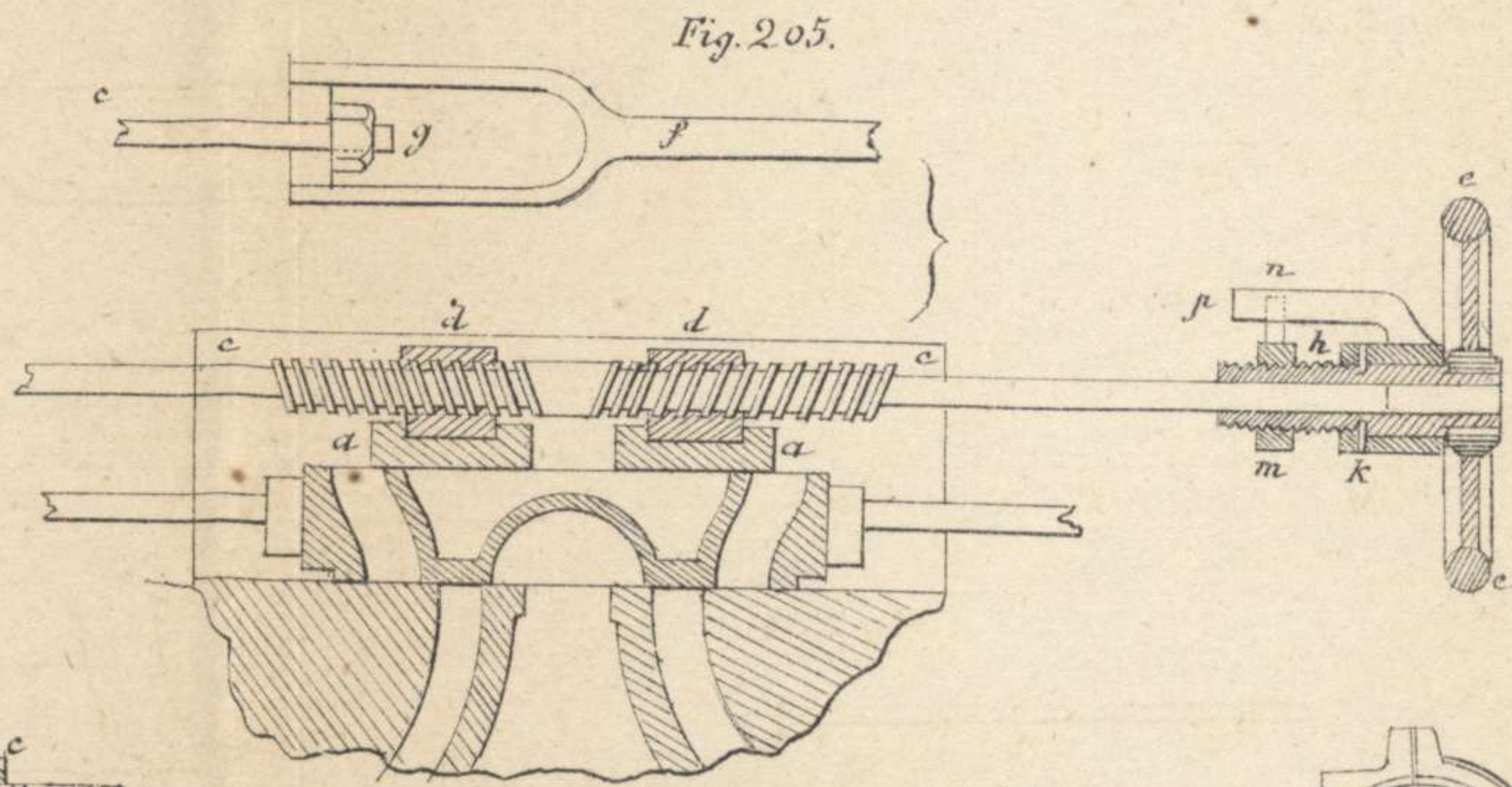
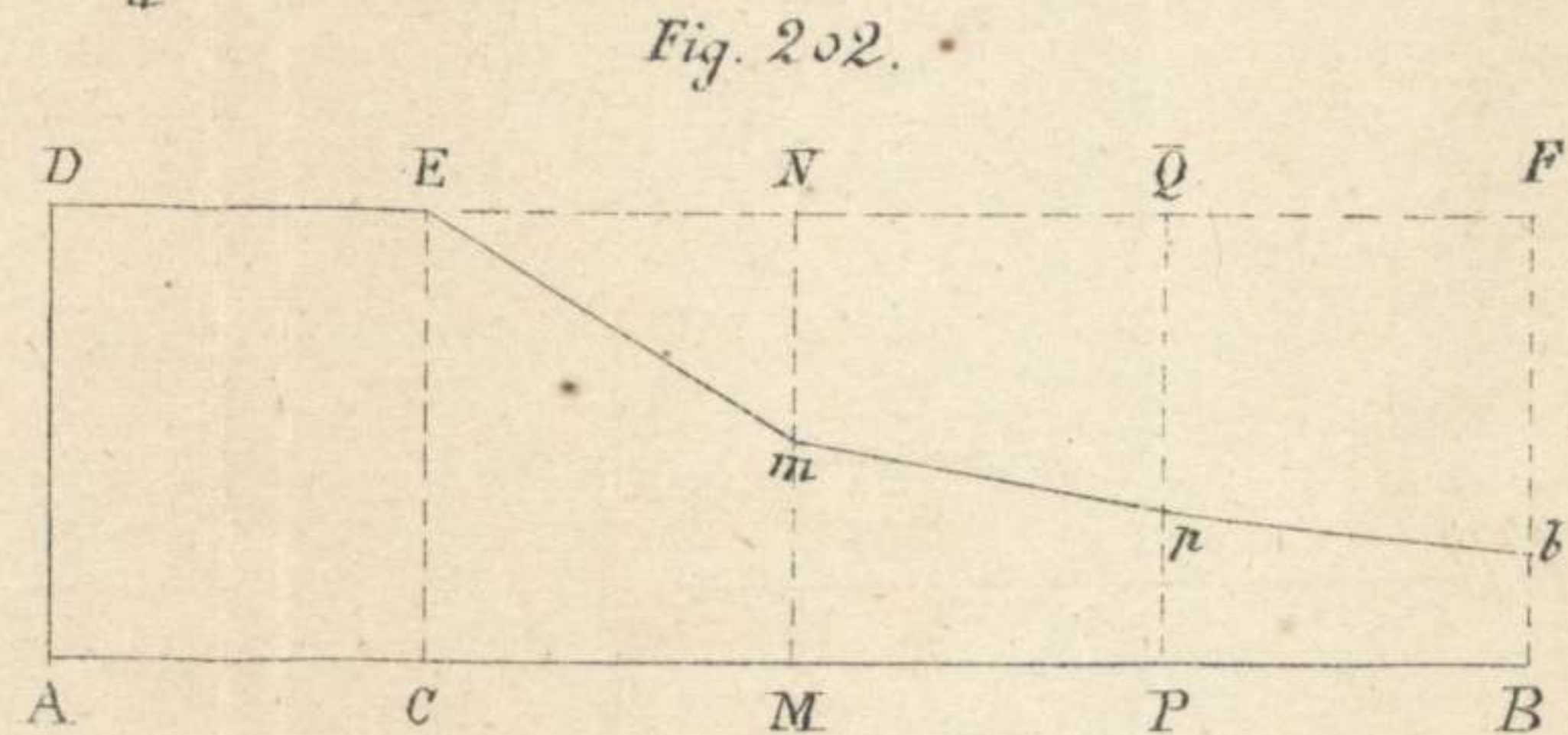
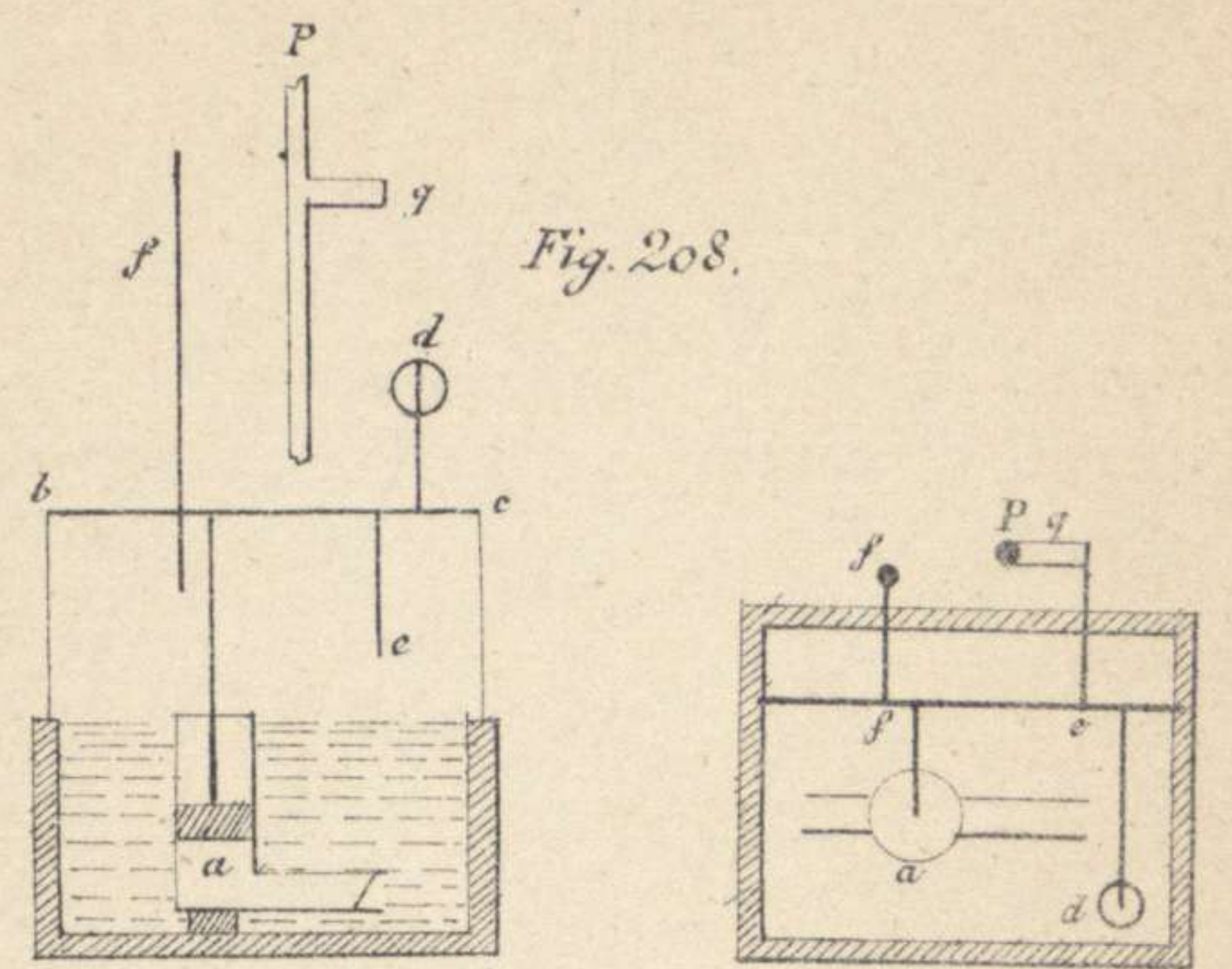
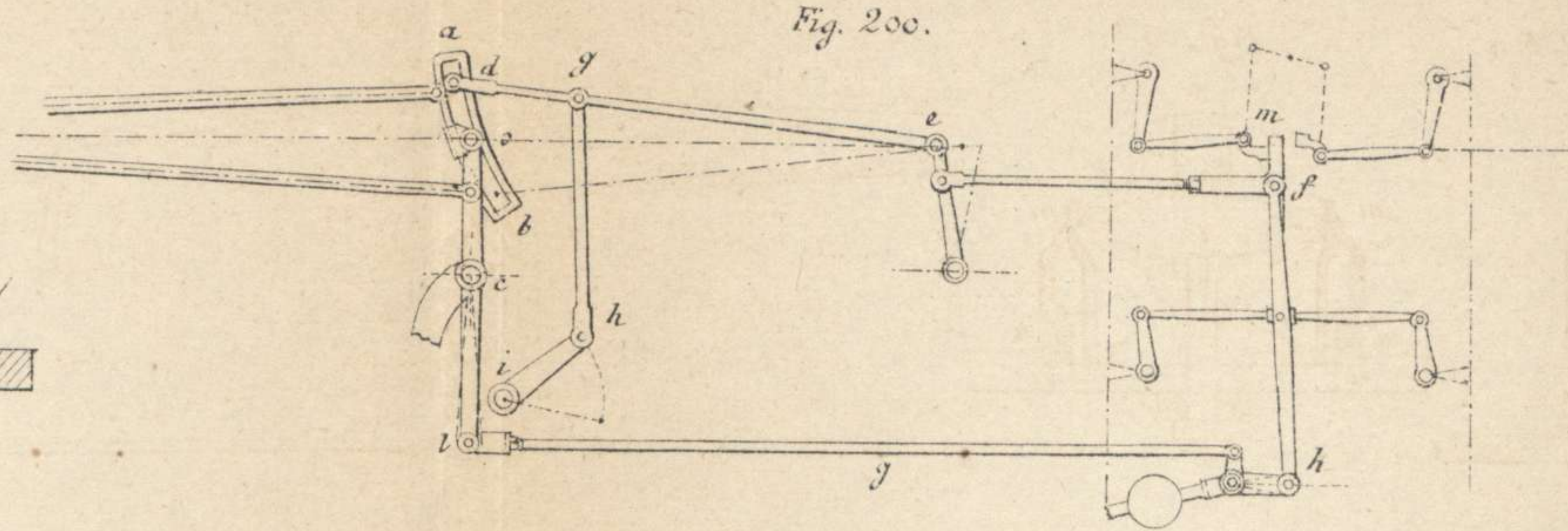
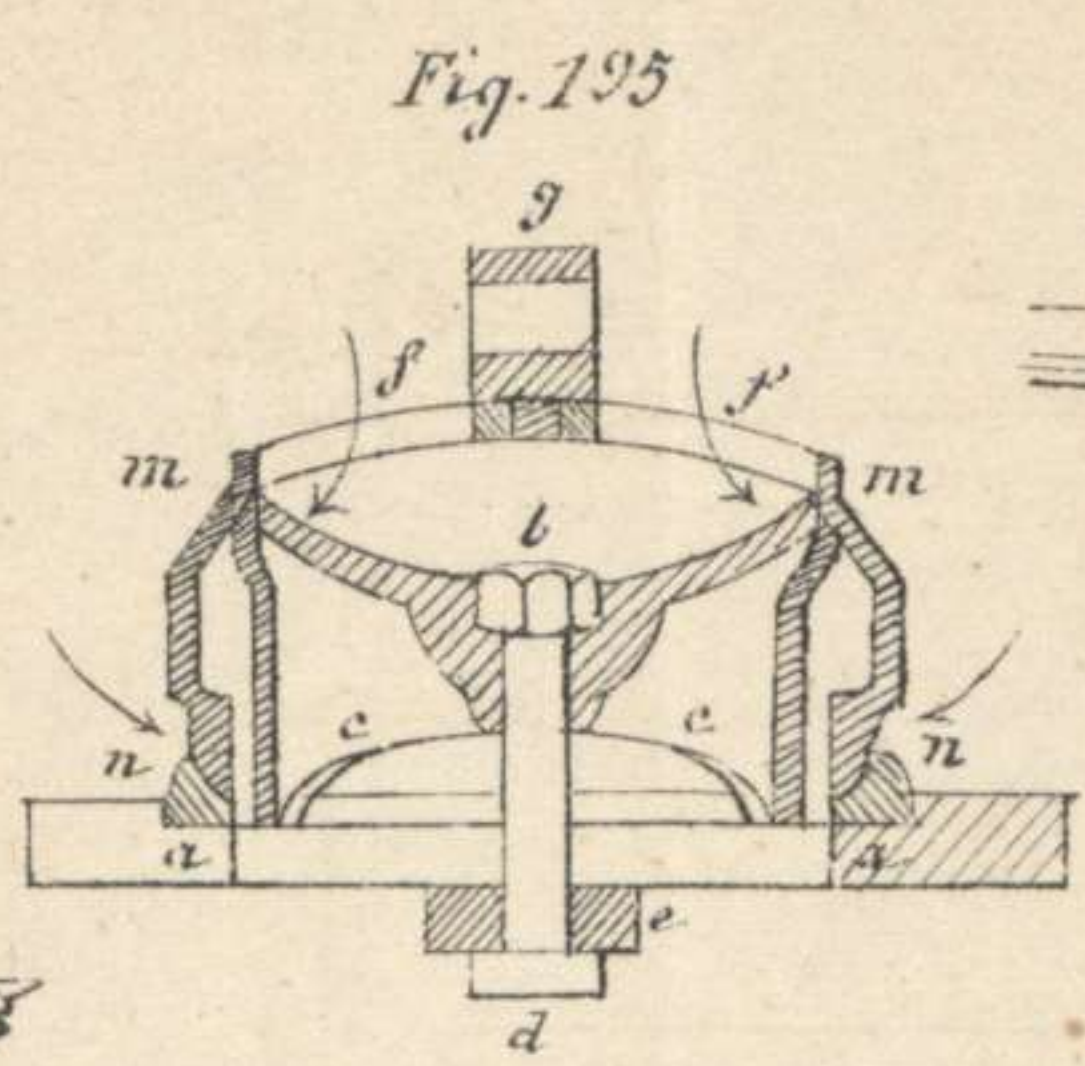
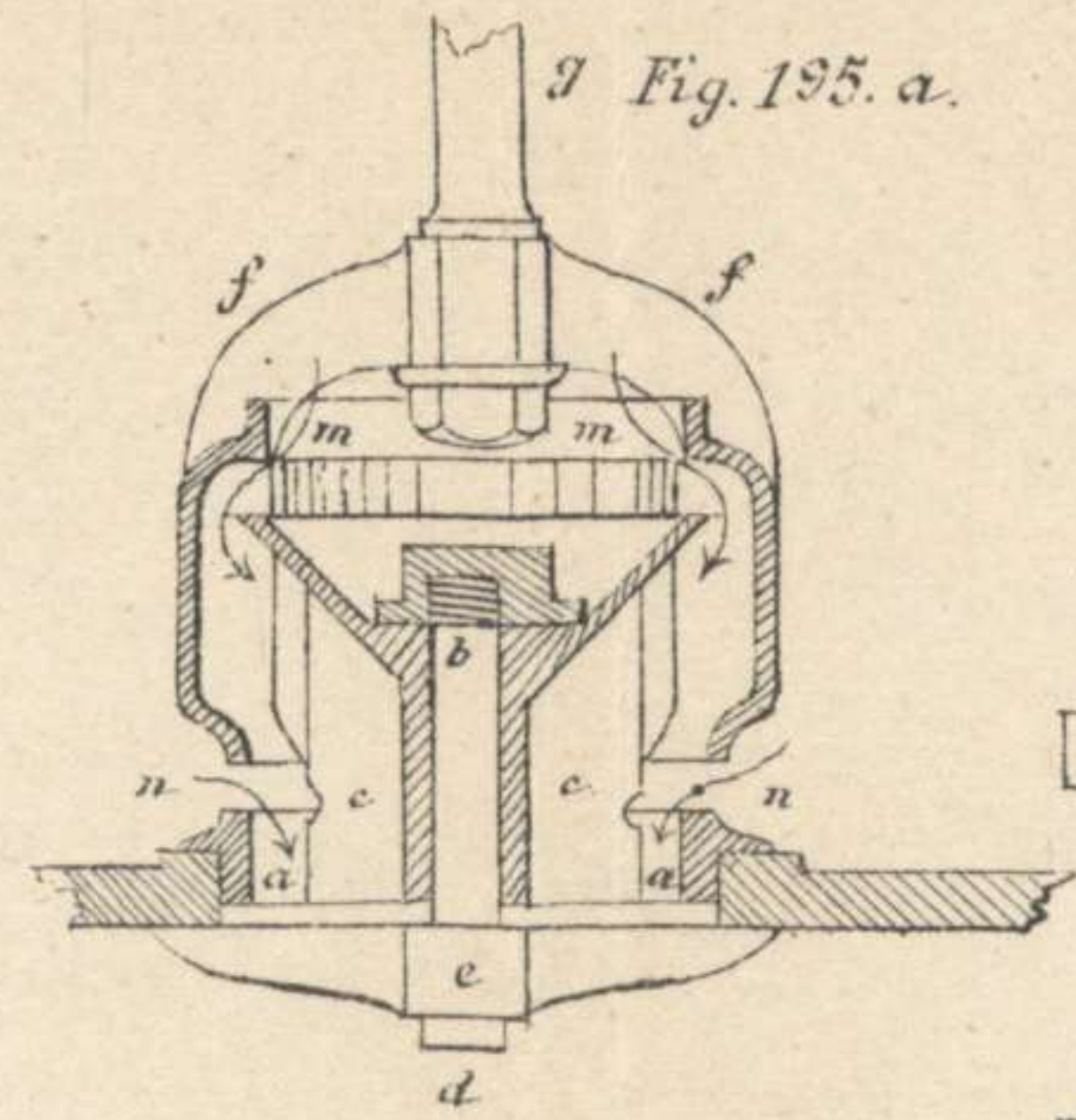
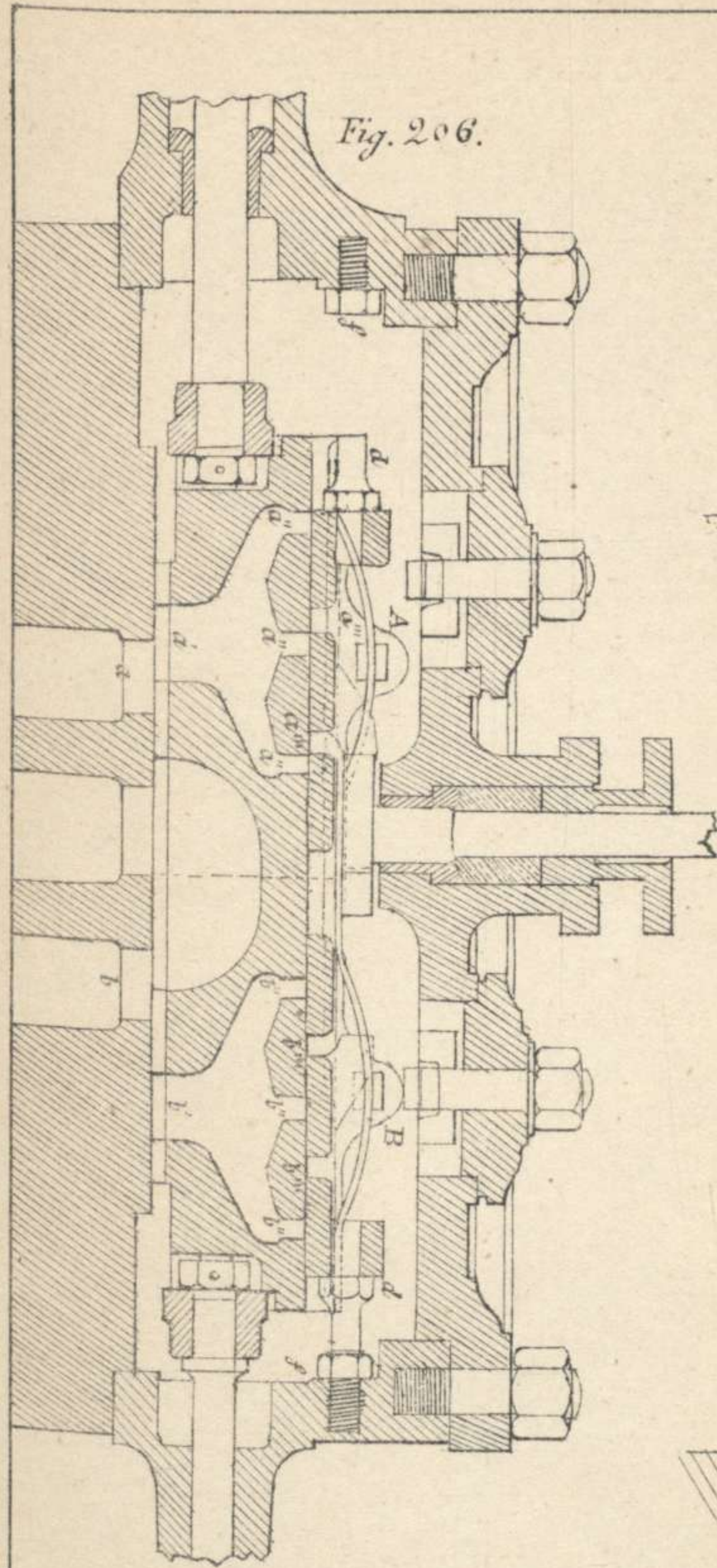

Fig. 198.





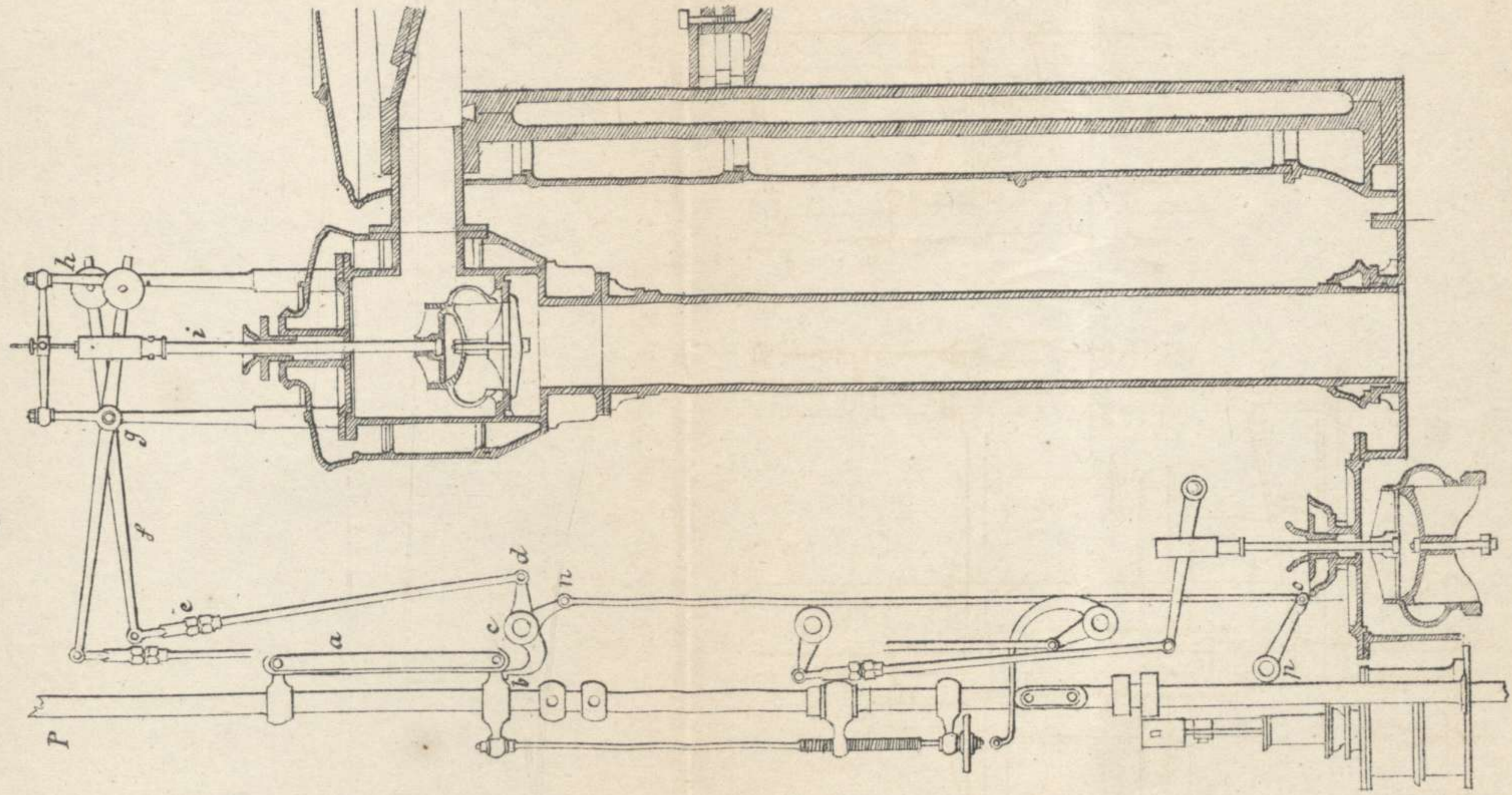

Fig. 210.

Lit. de M. Ventura.

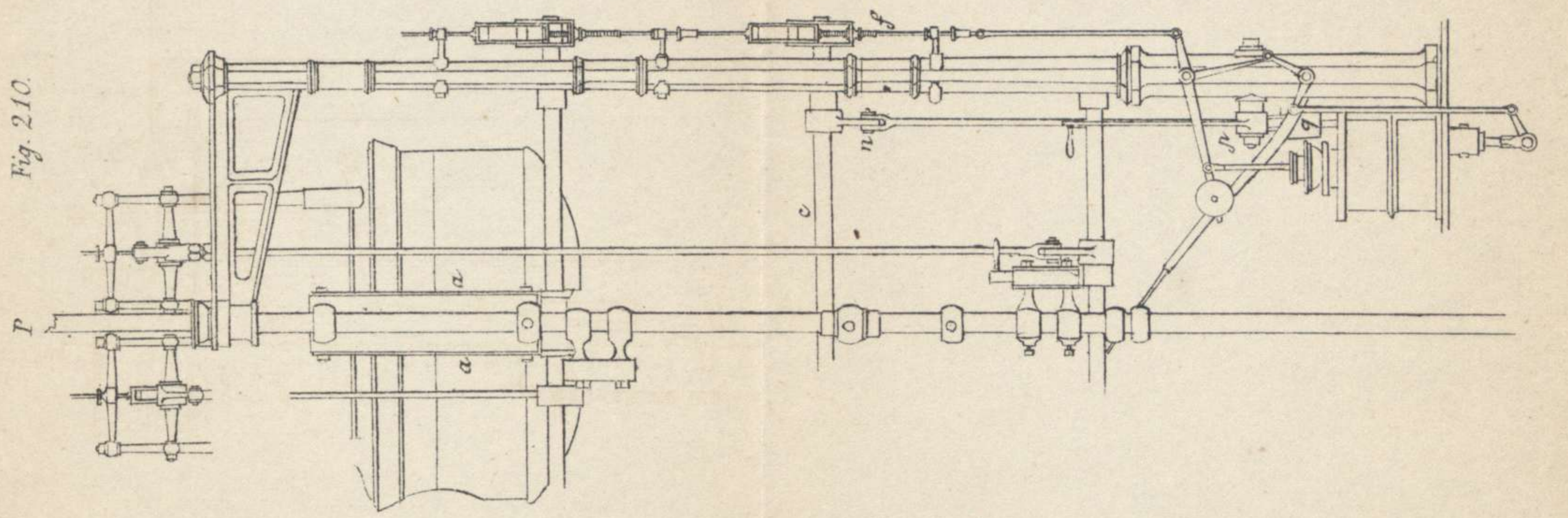

Fig. 210.

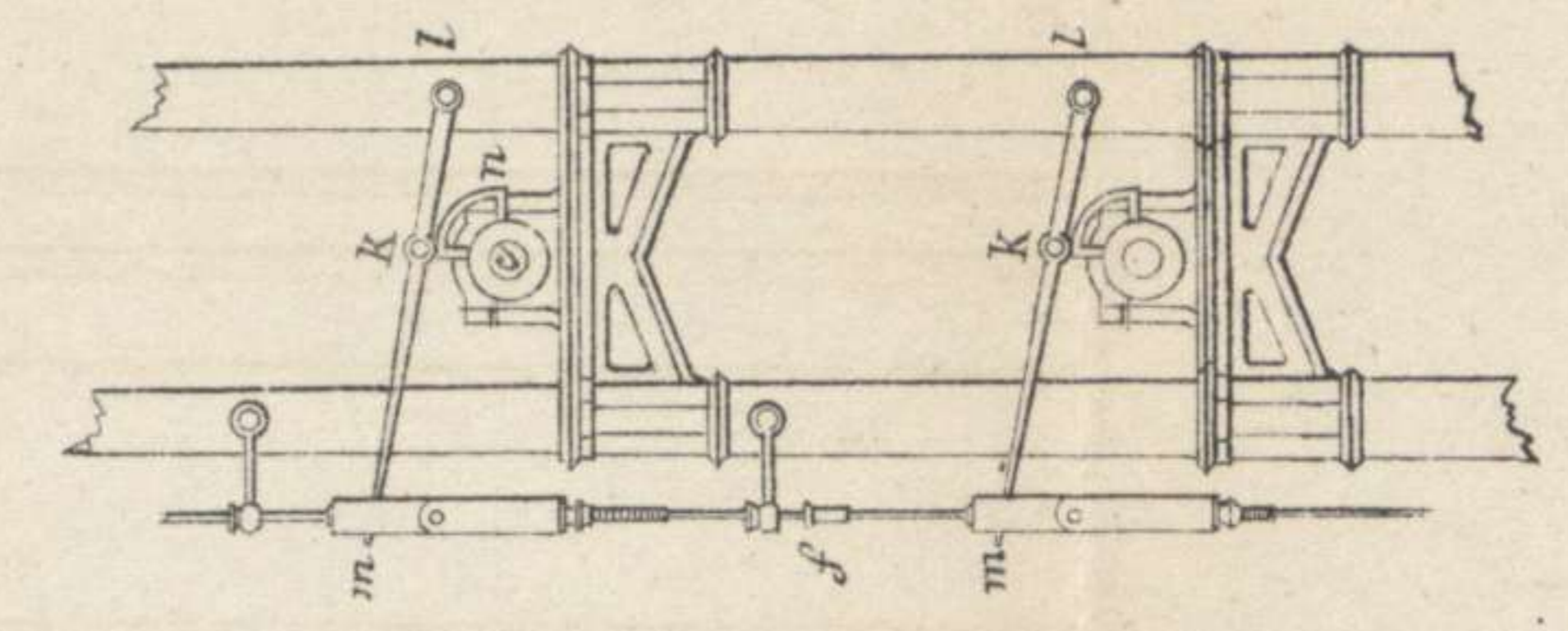

Fig. 209.

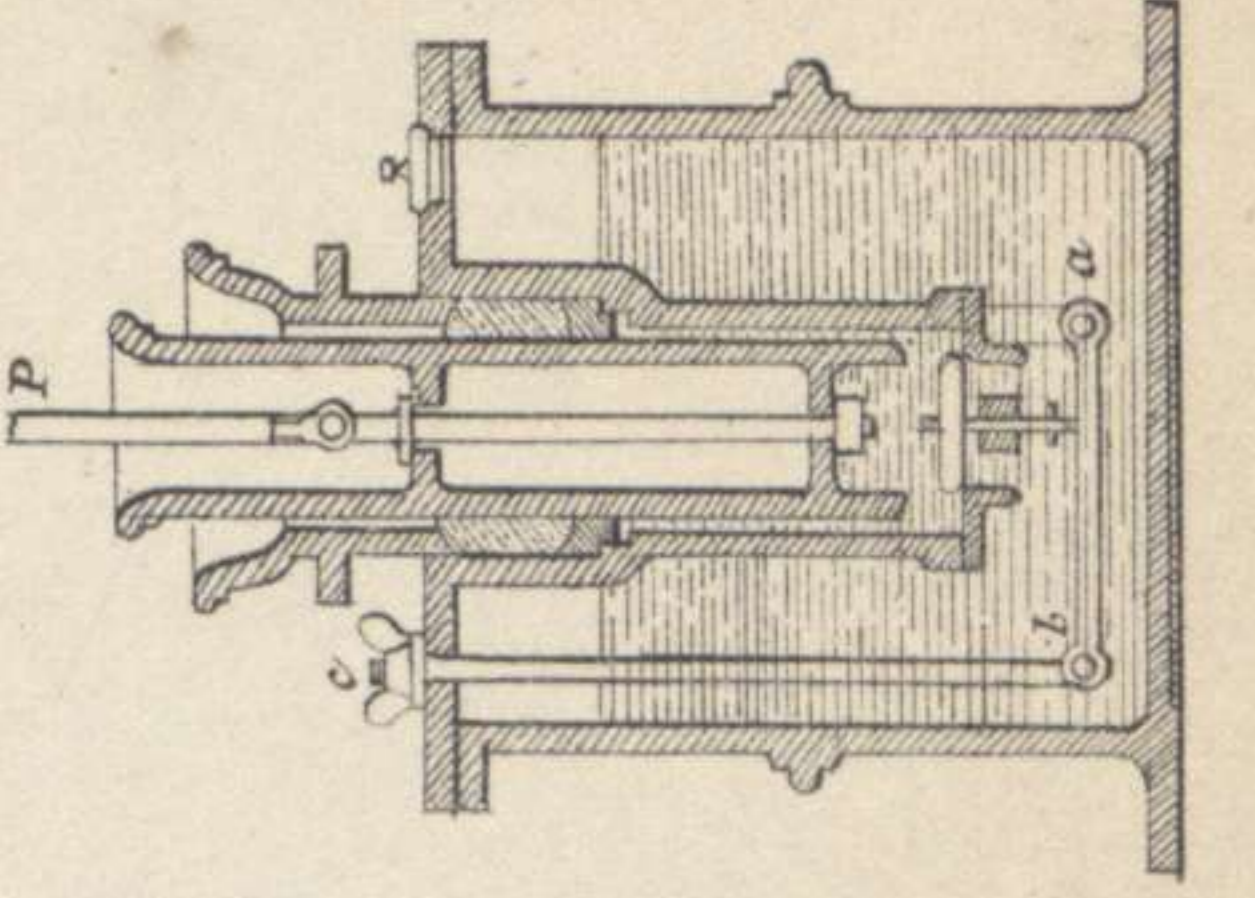

Fig. 207.

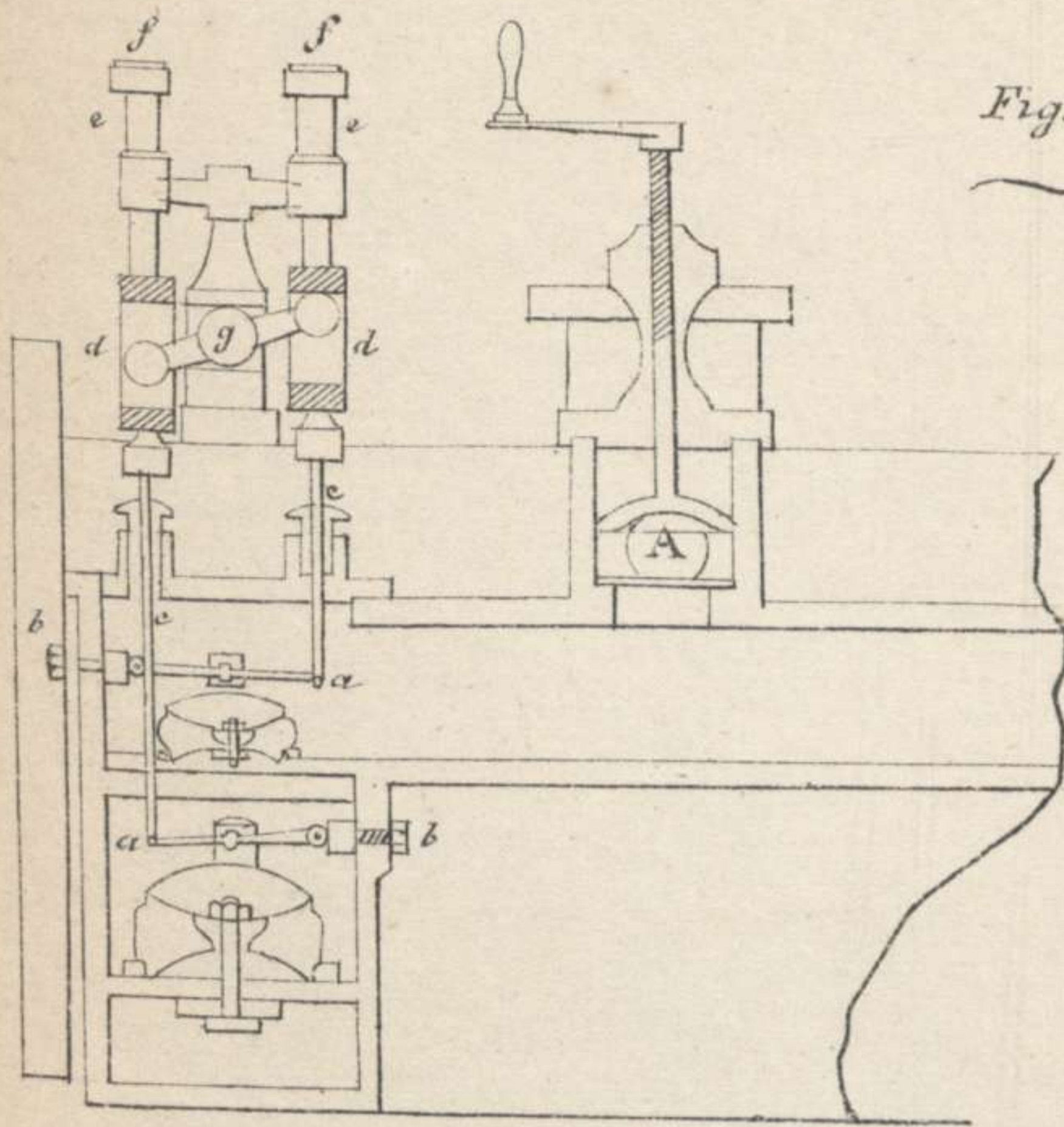

Fig. 215.

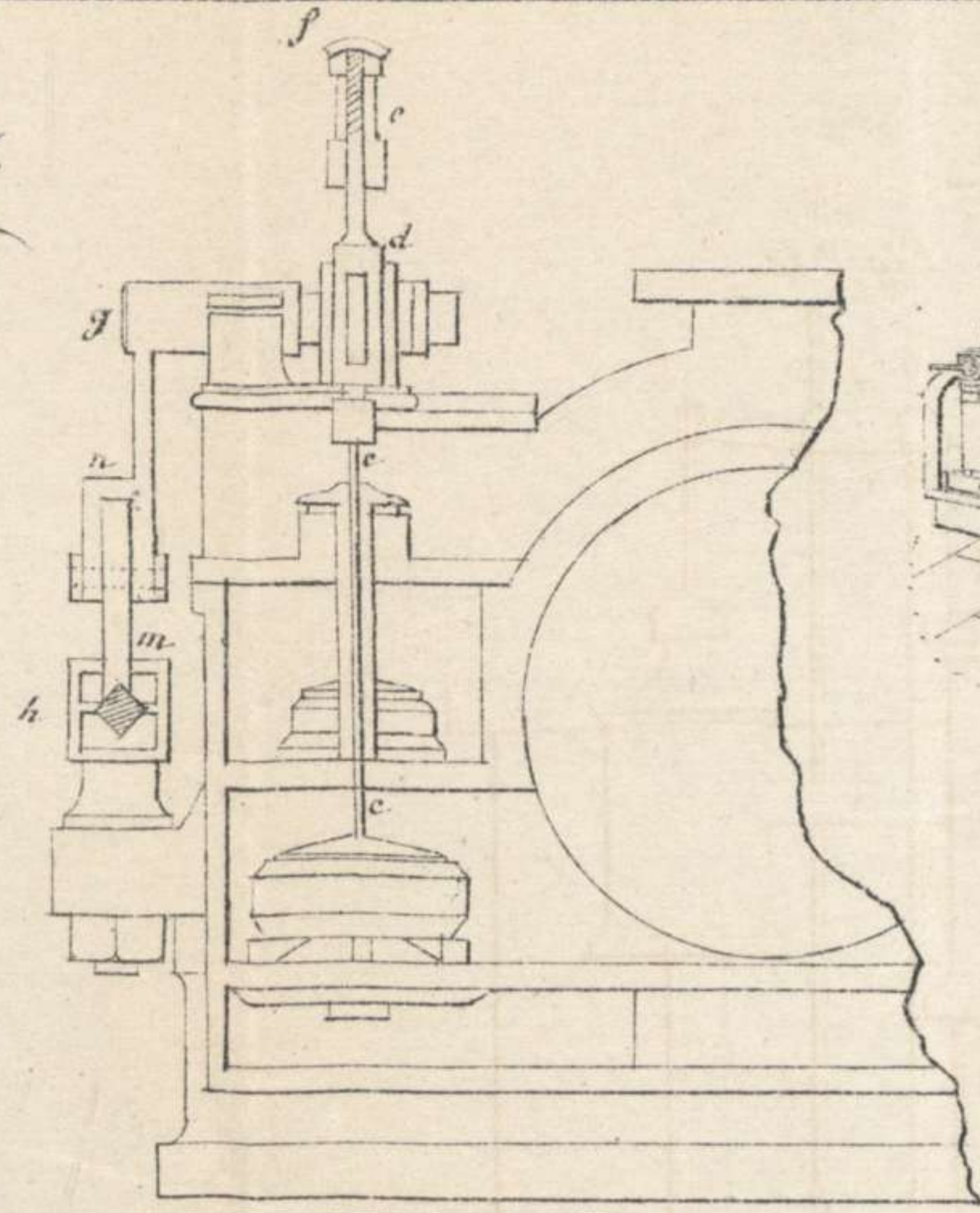

Fig. 216.

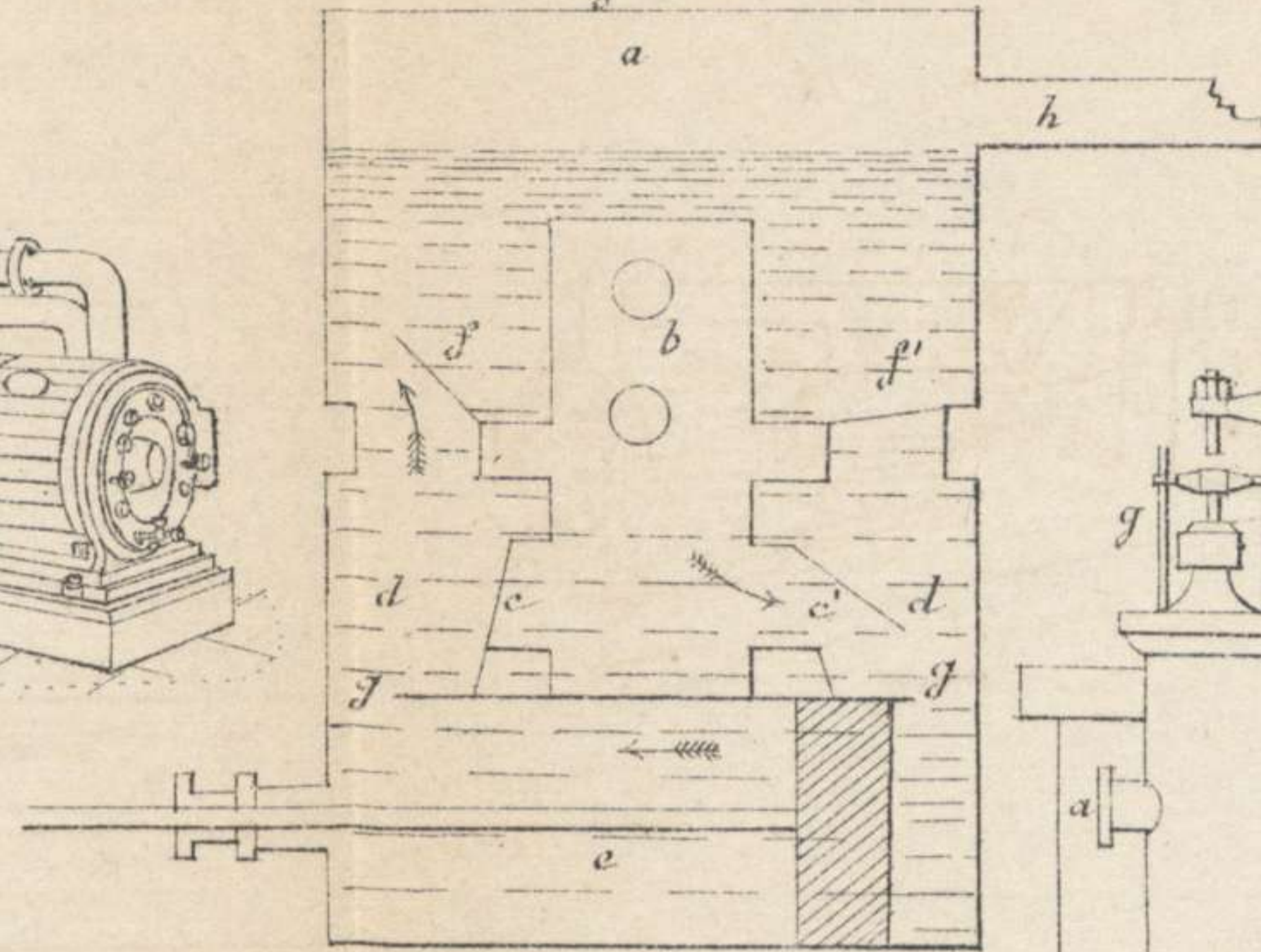

Fig. 212.

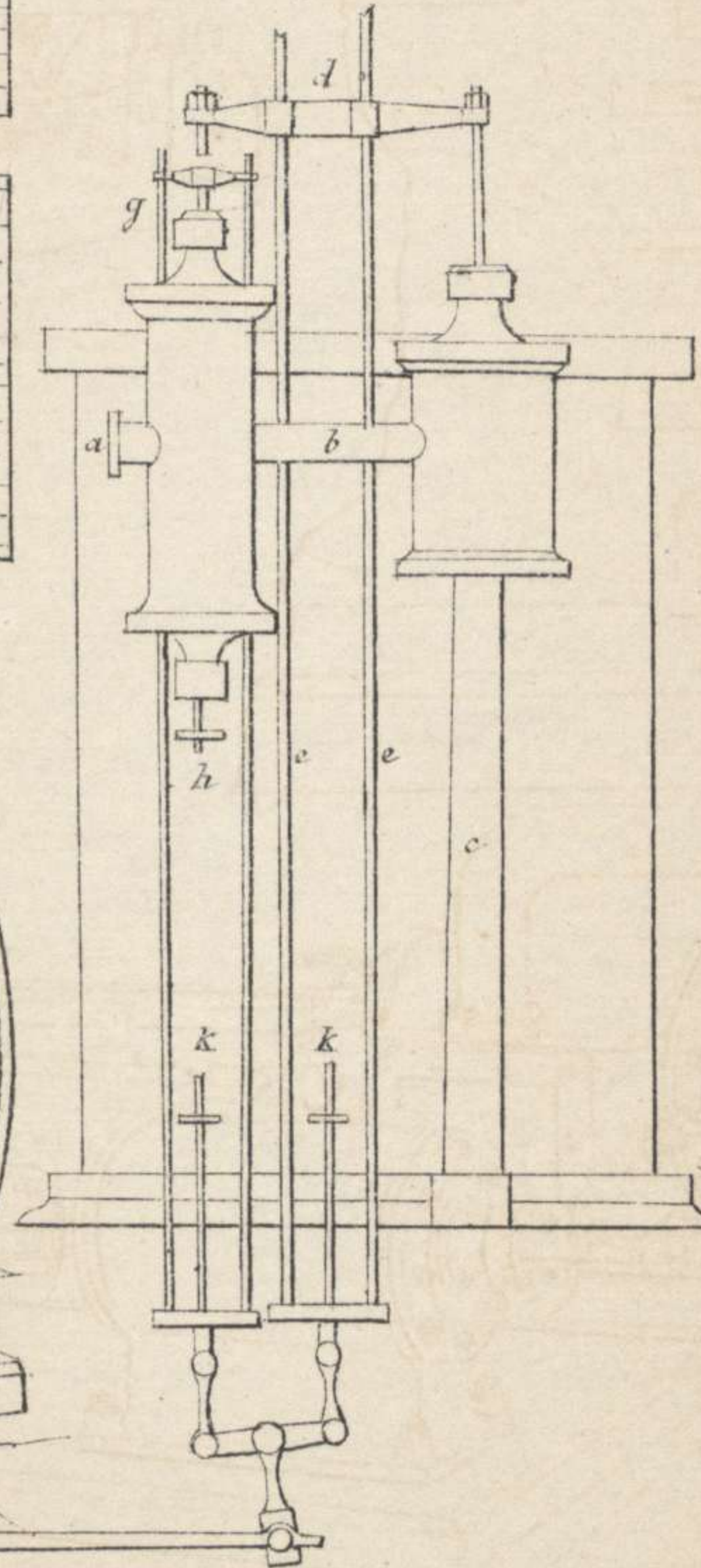

Fig. 217.

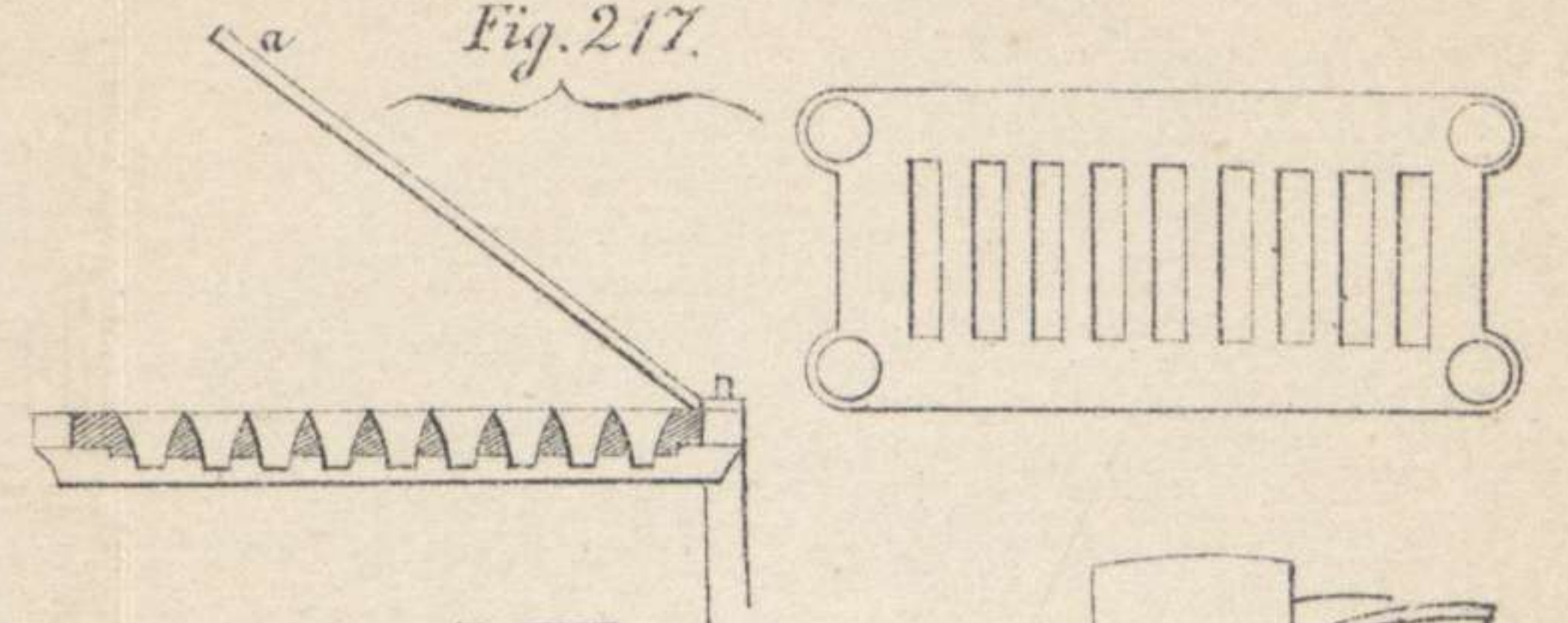

Fig. 213.

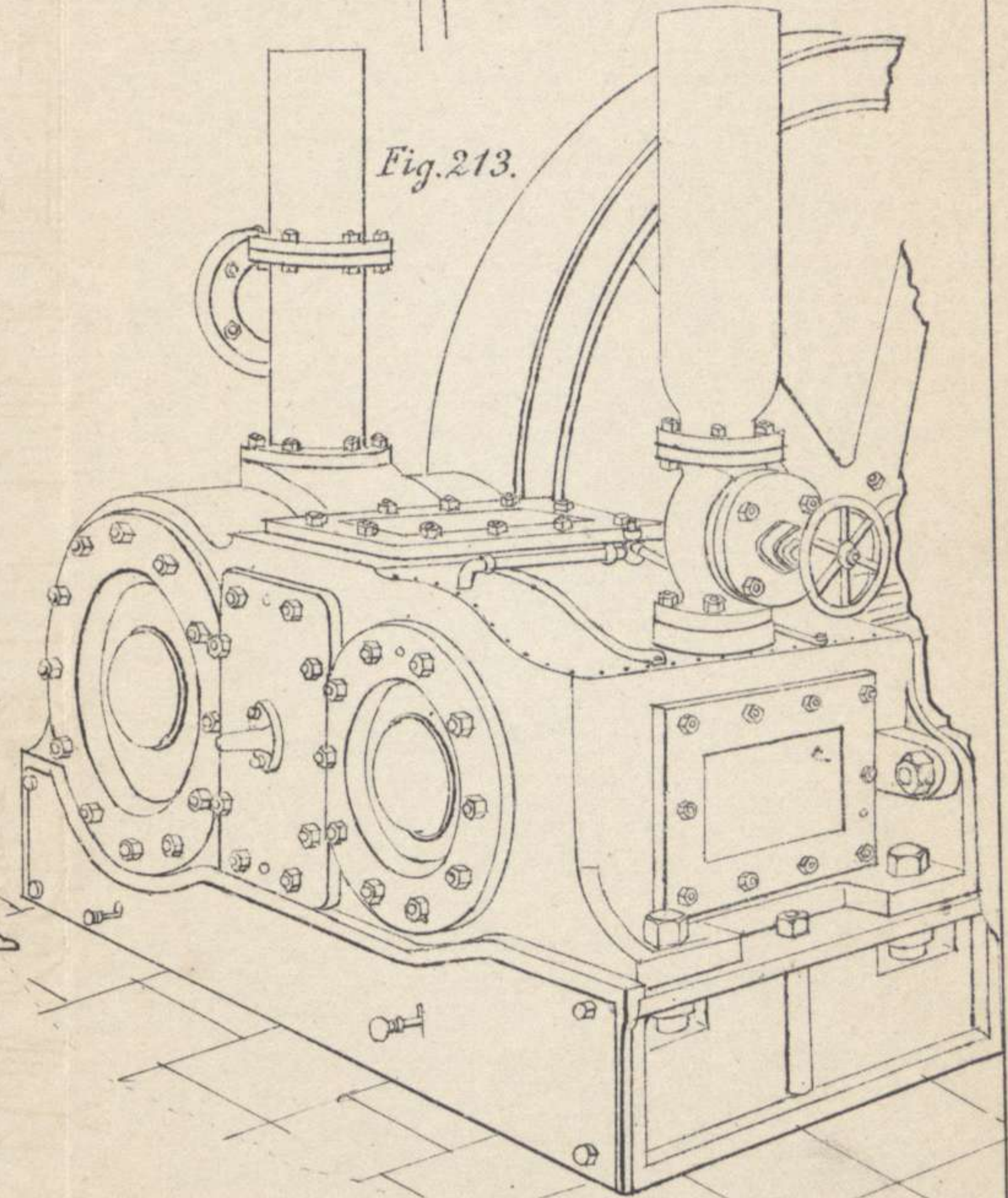

Fig. 211.

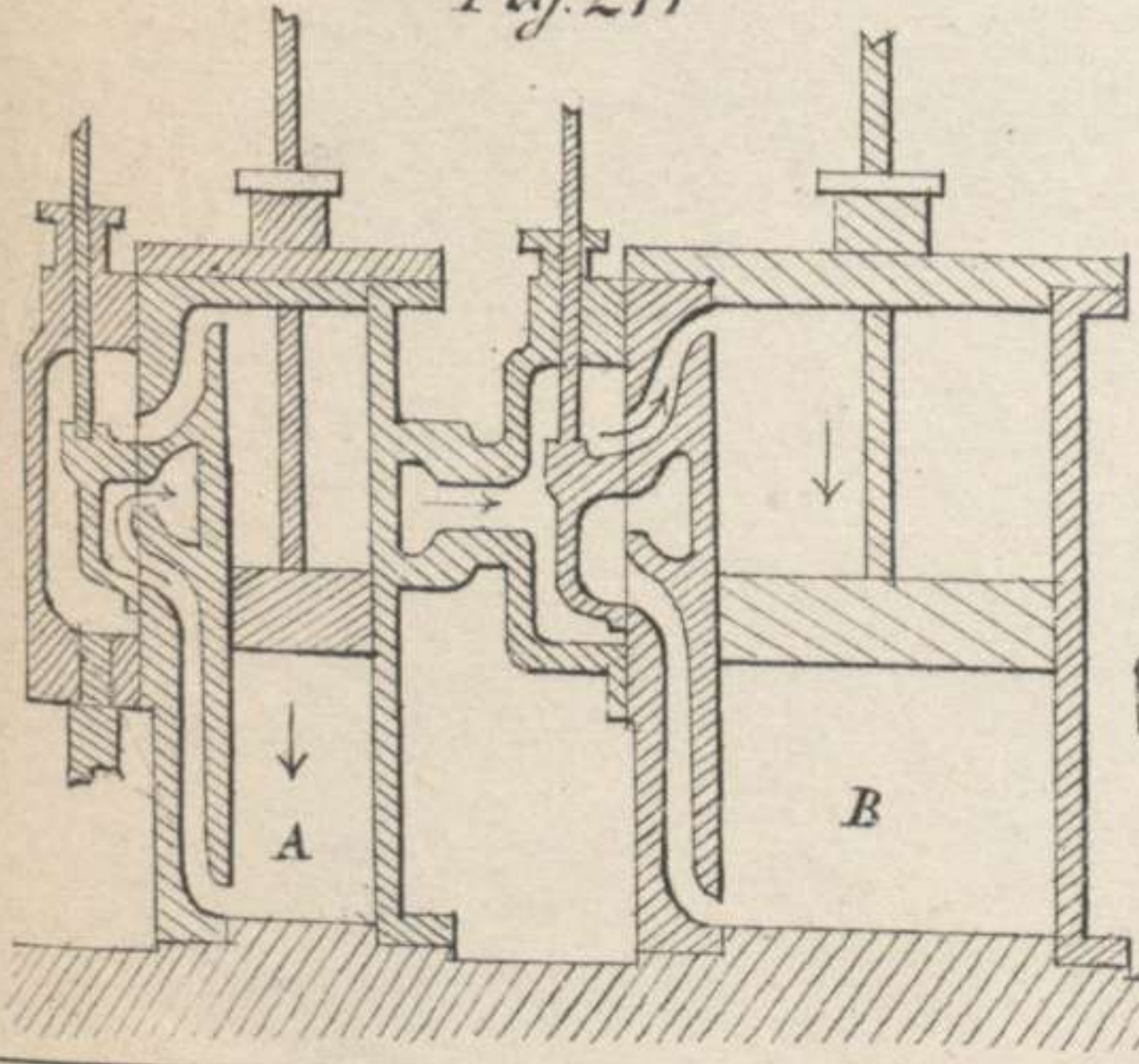

Fig. 214.

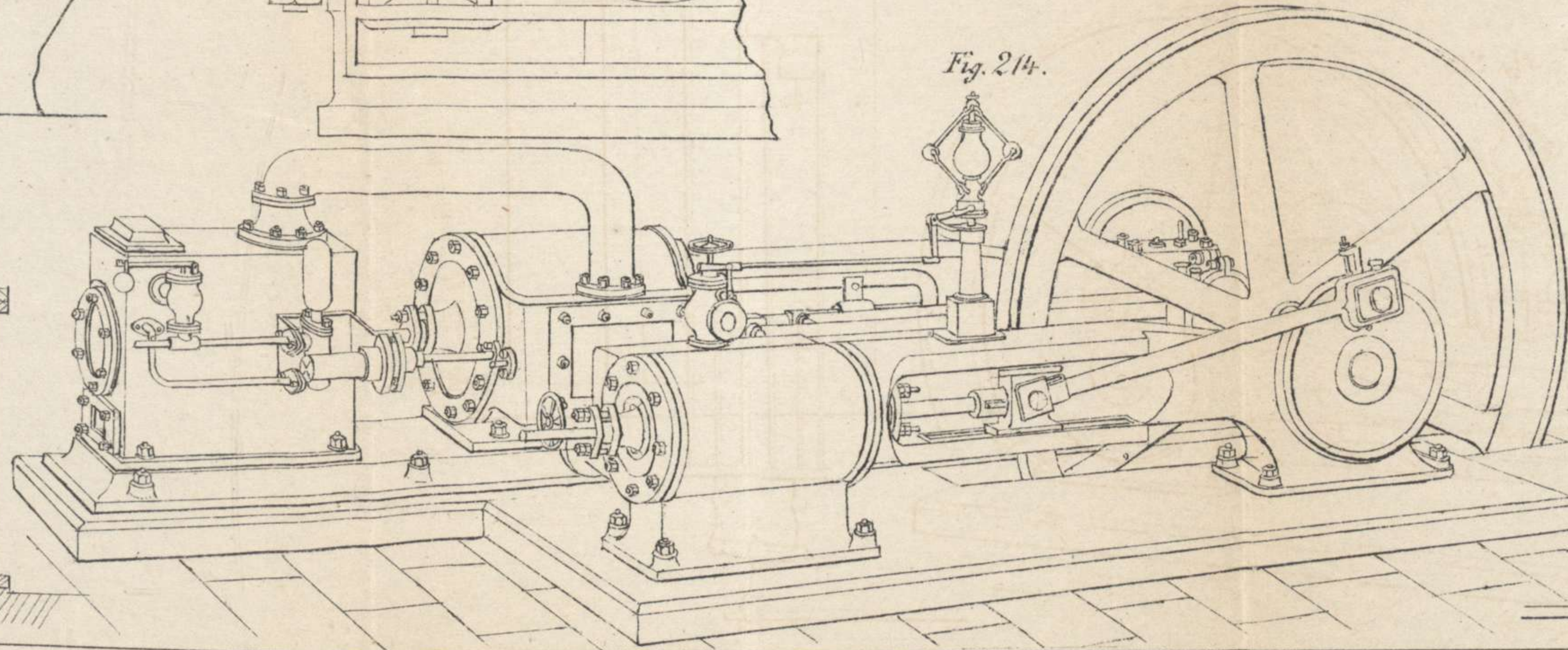

Fig. 218

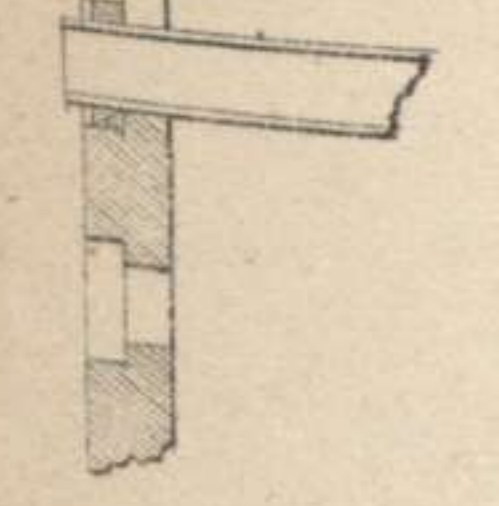

Fig. 219

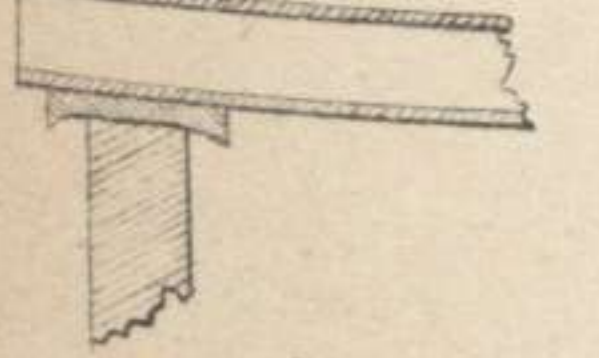

Fig. 220.

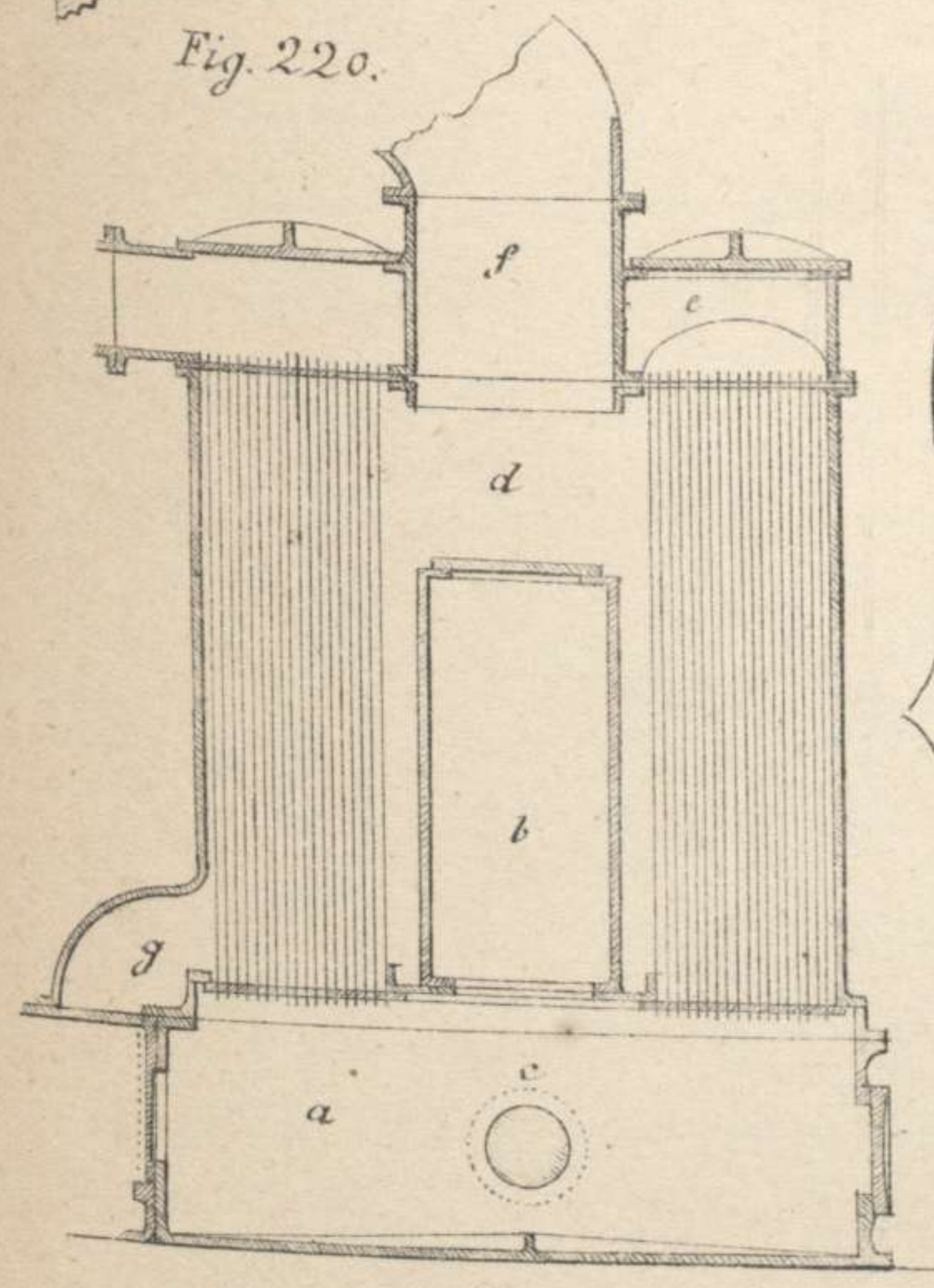

Fig. 221.

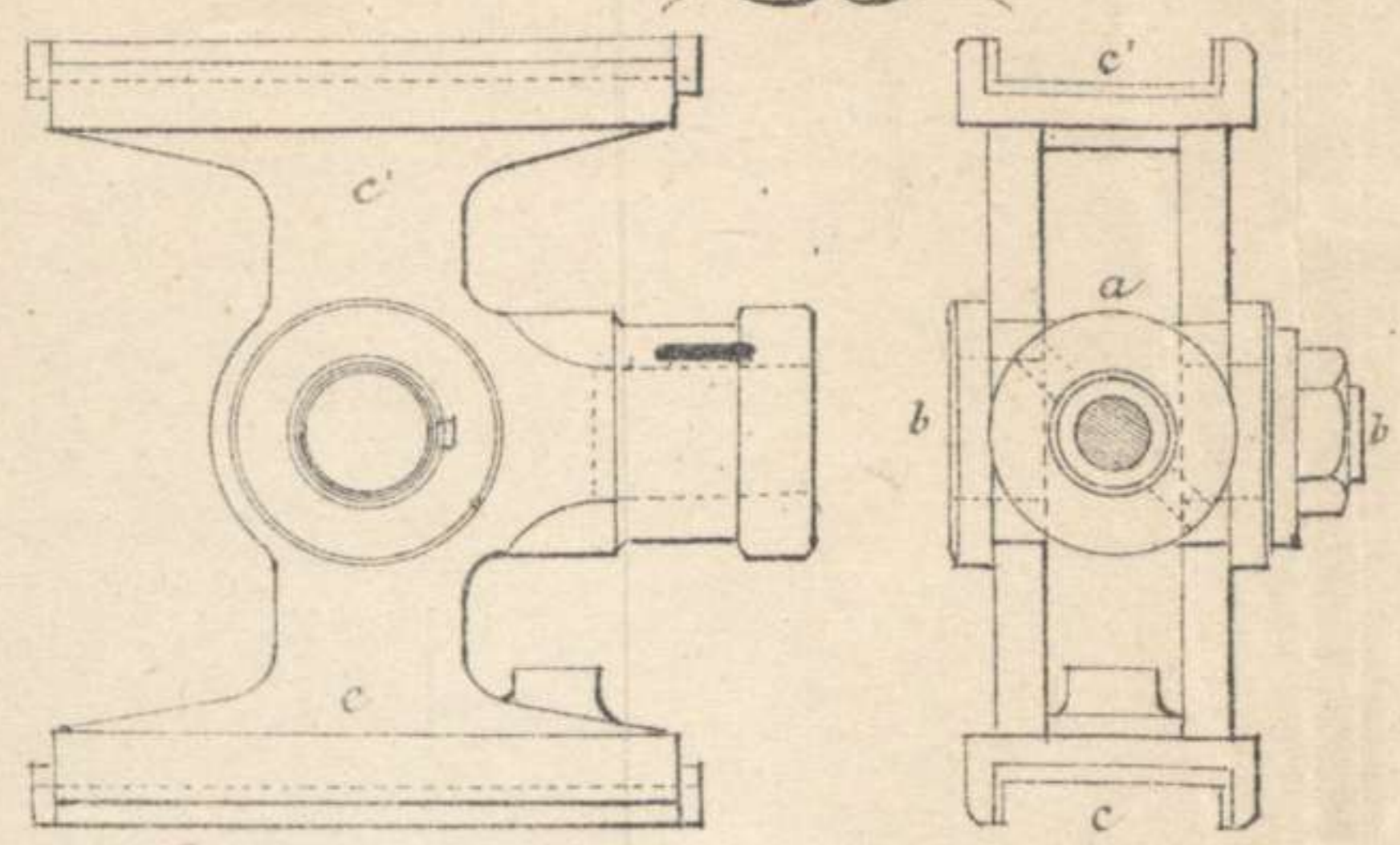

Fig. 222.

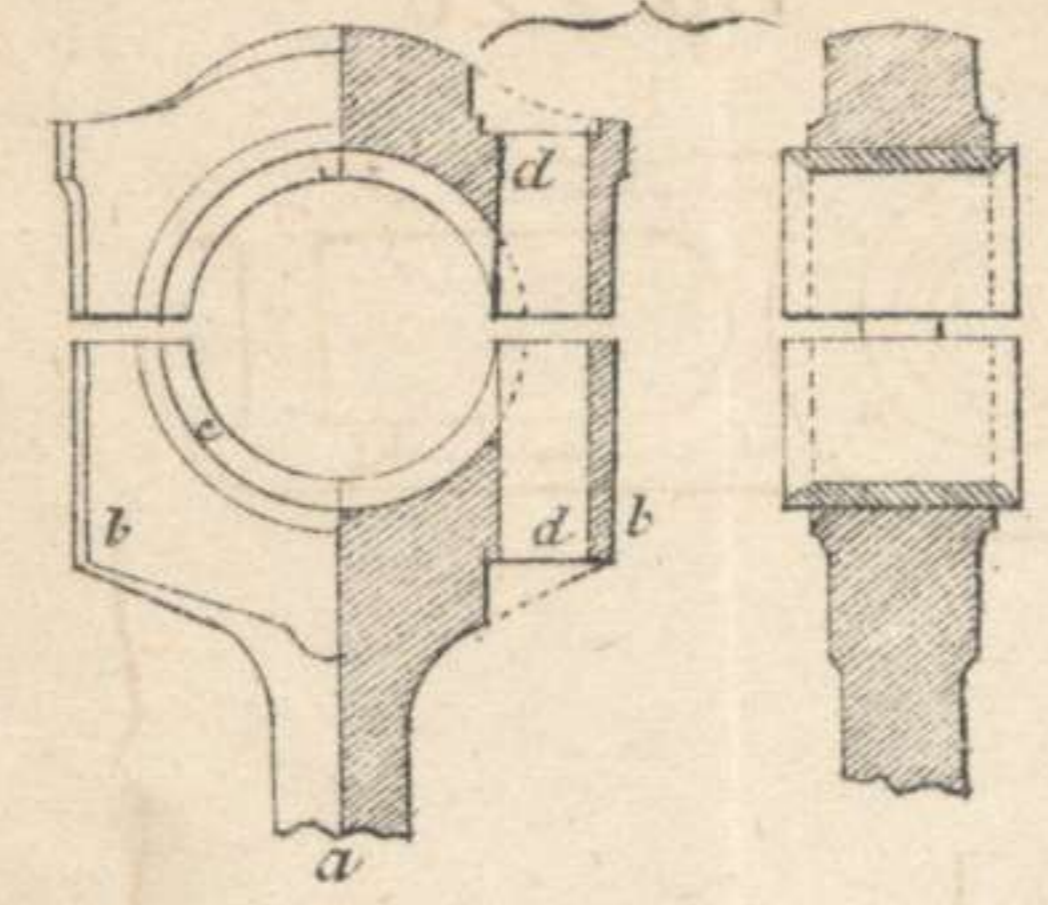

Fig. 223.

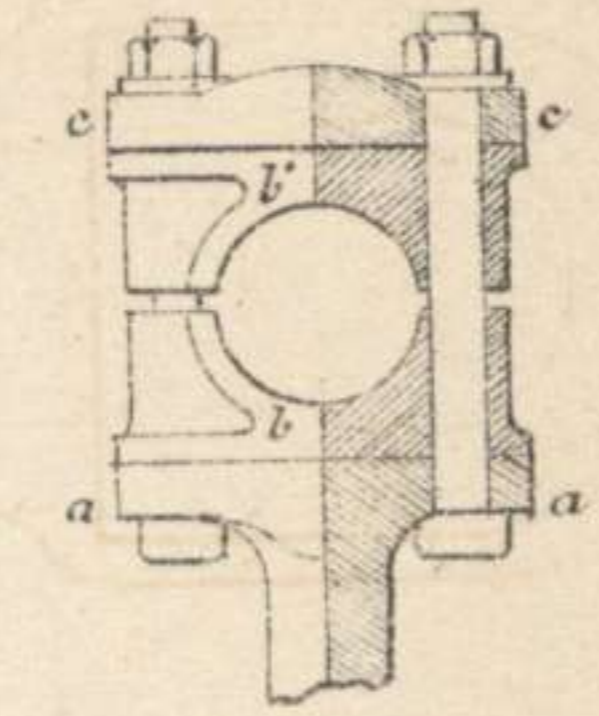

Fig. 224

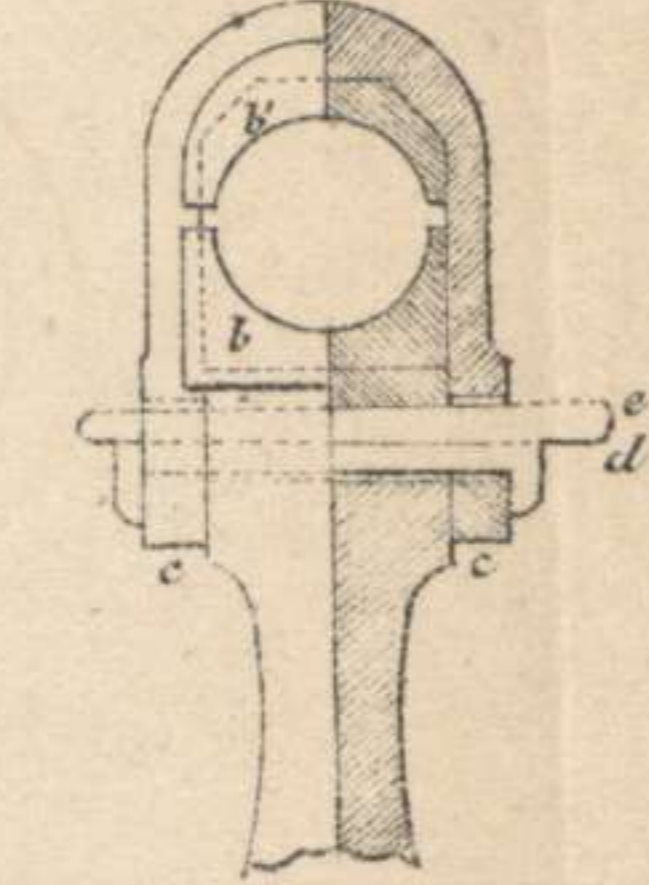

Fig. 226.

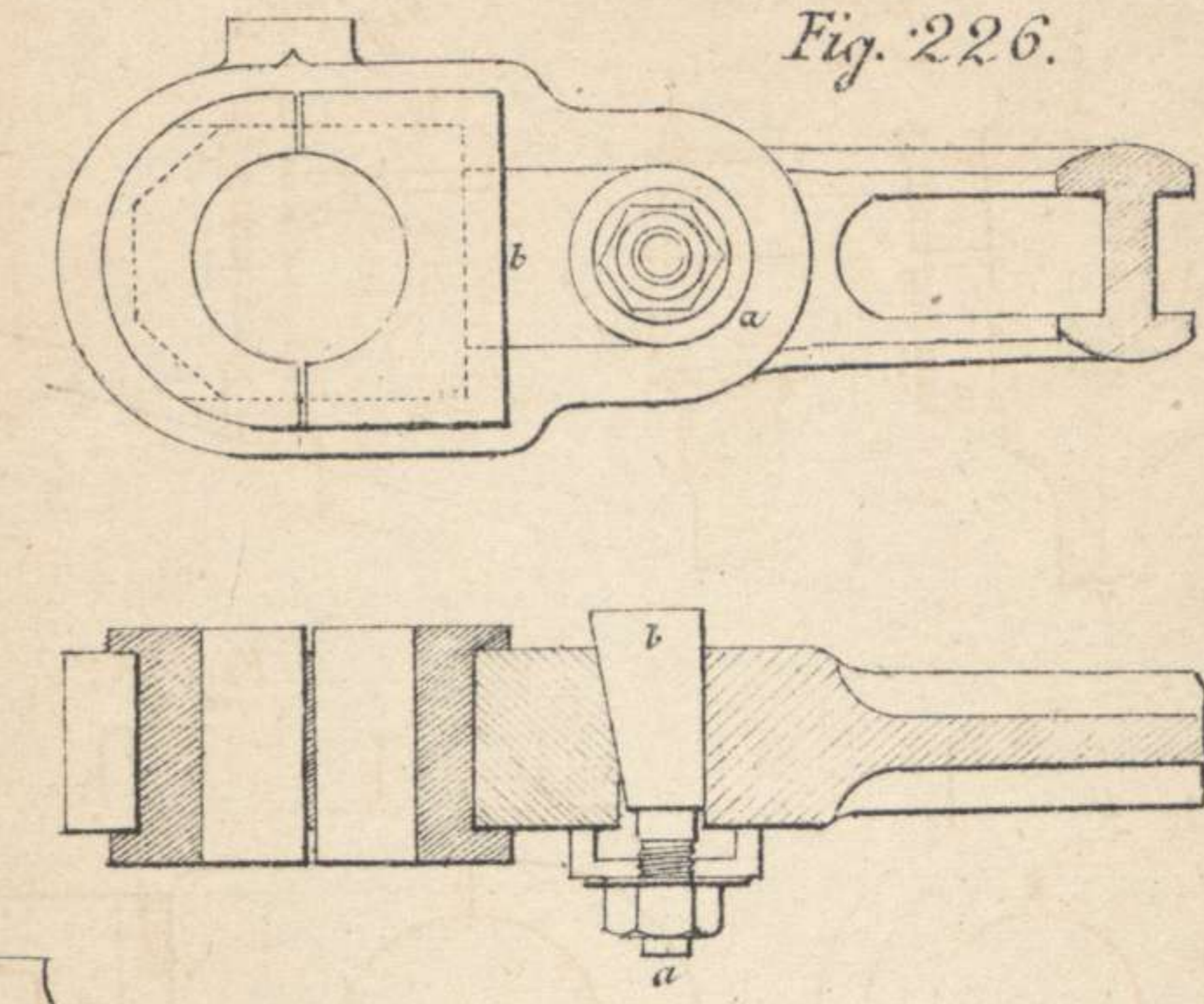

Fig. 227.

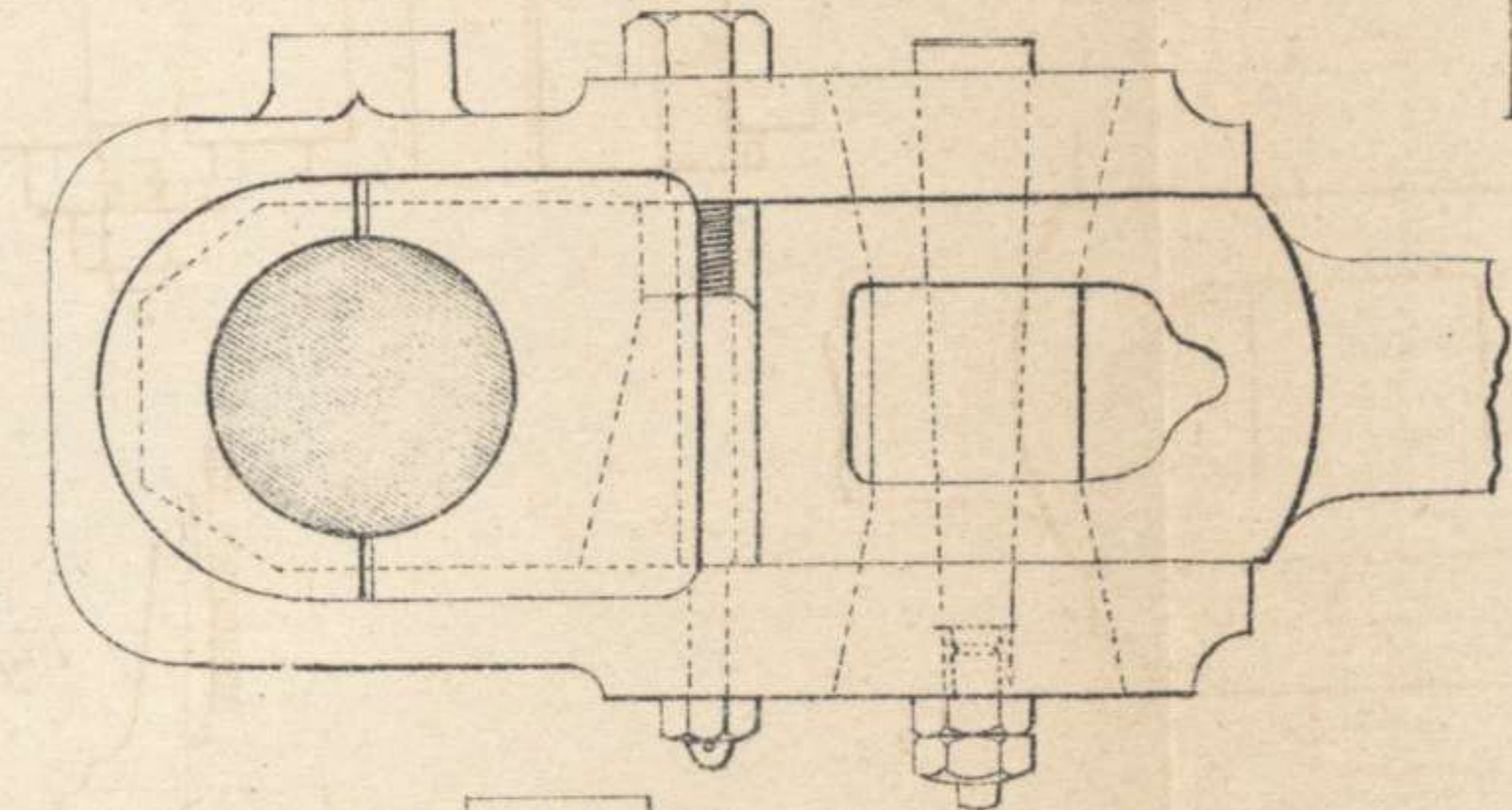

Fig. 229.

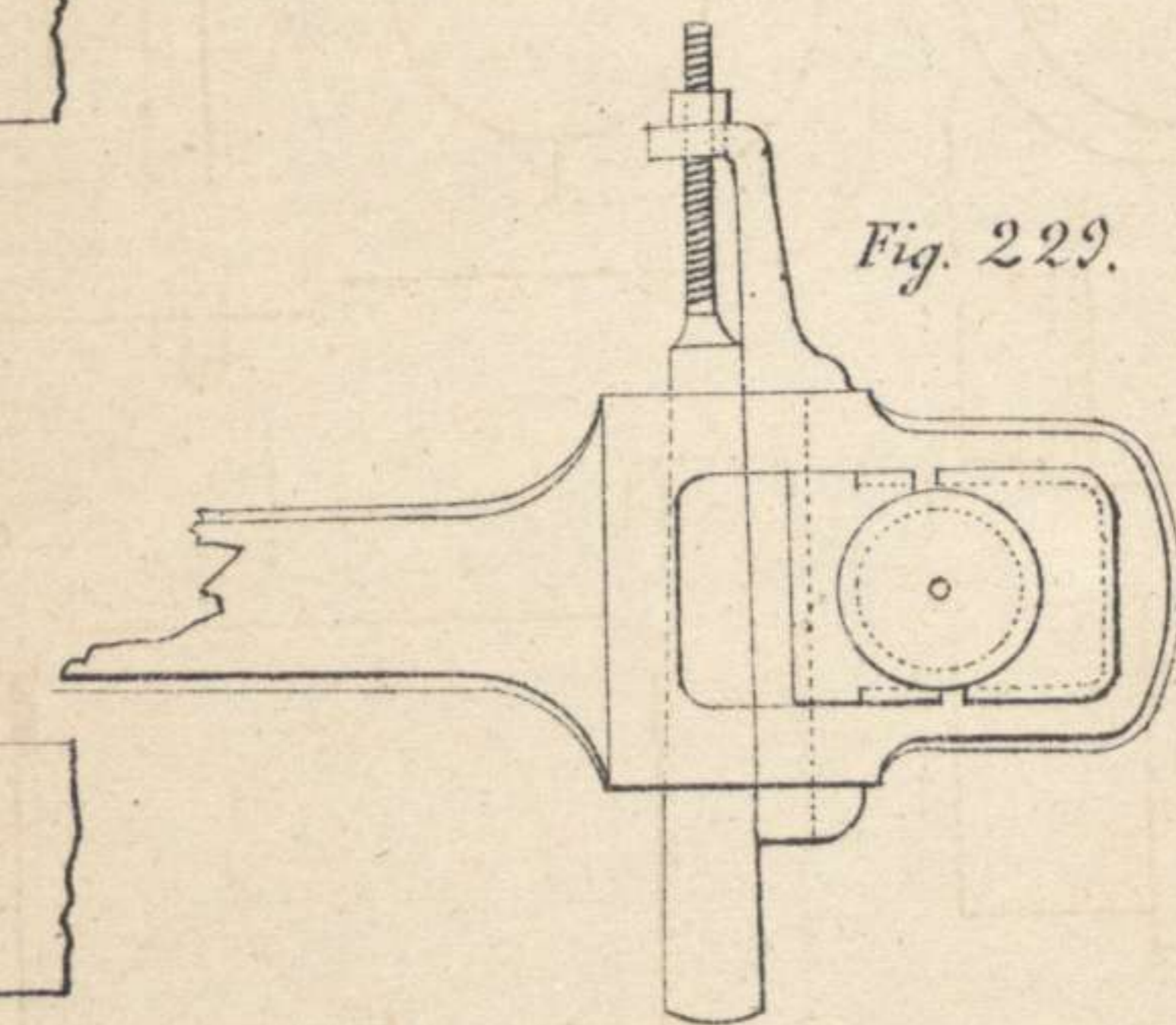

Fig. 228.

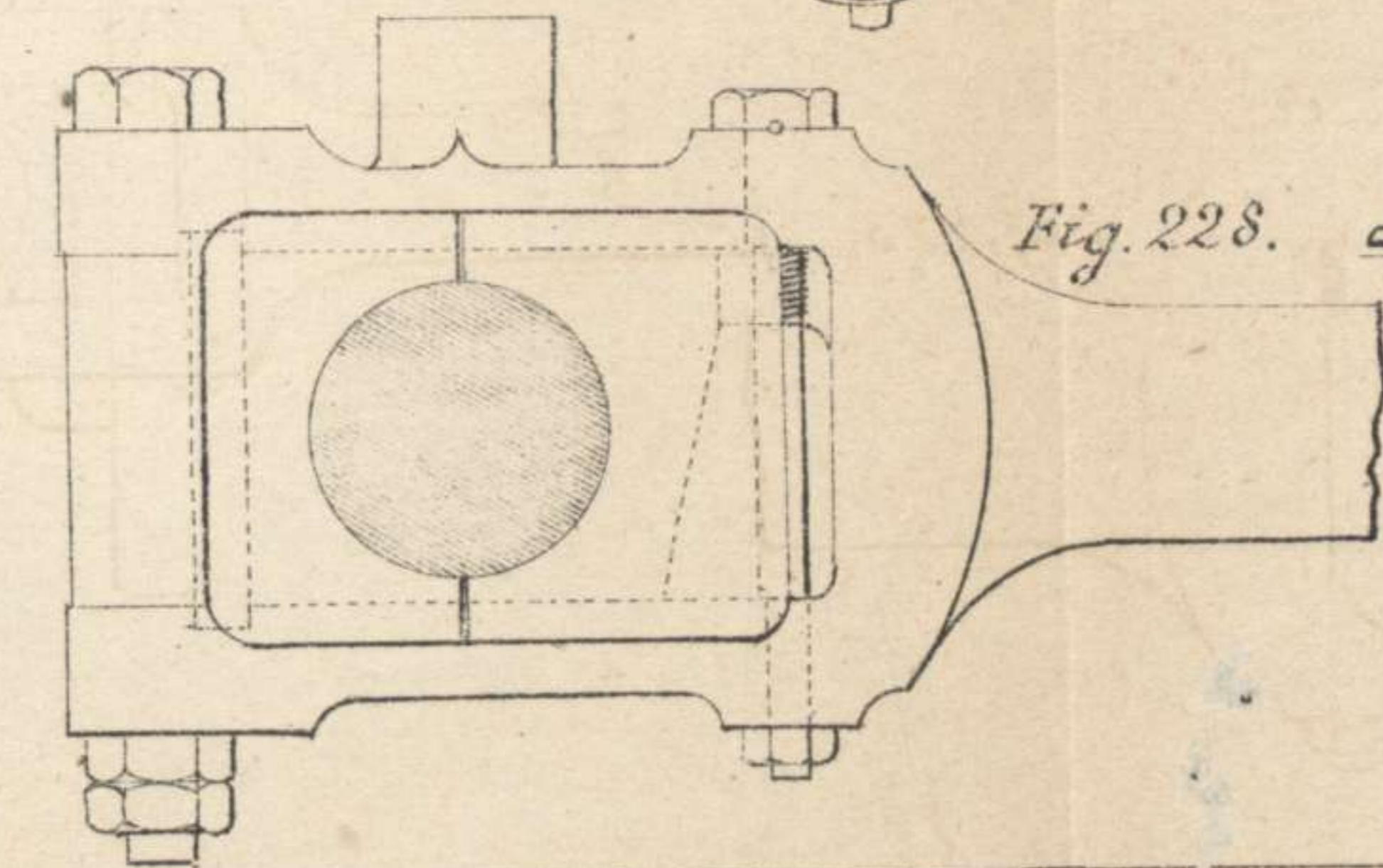

Fig. 225.

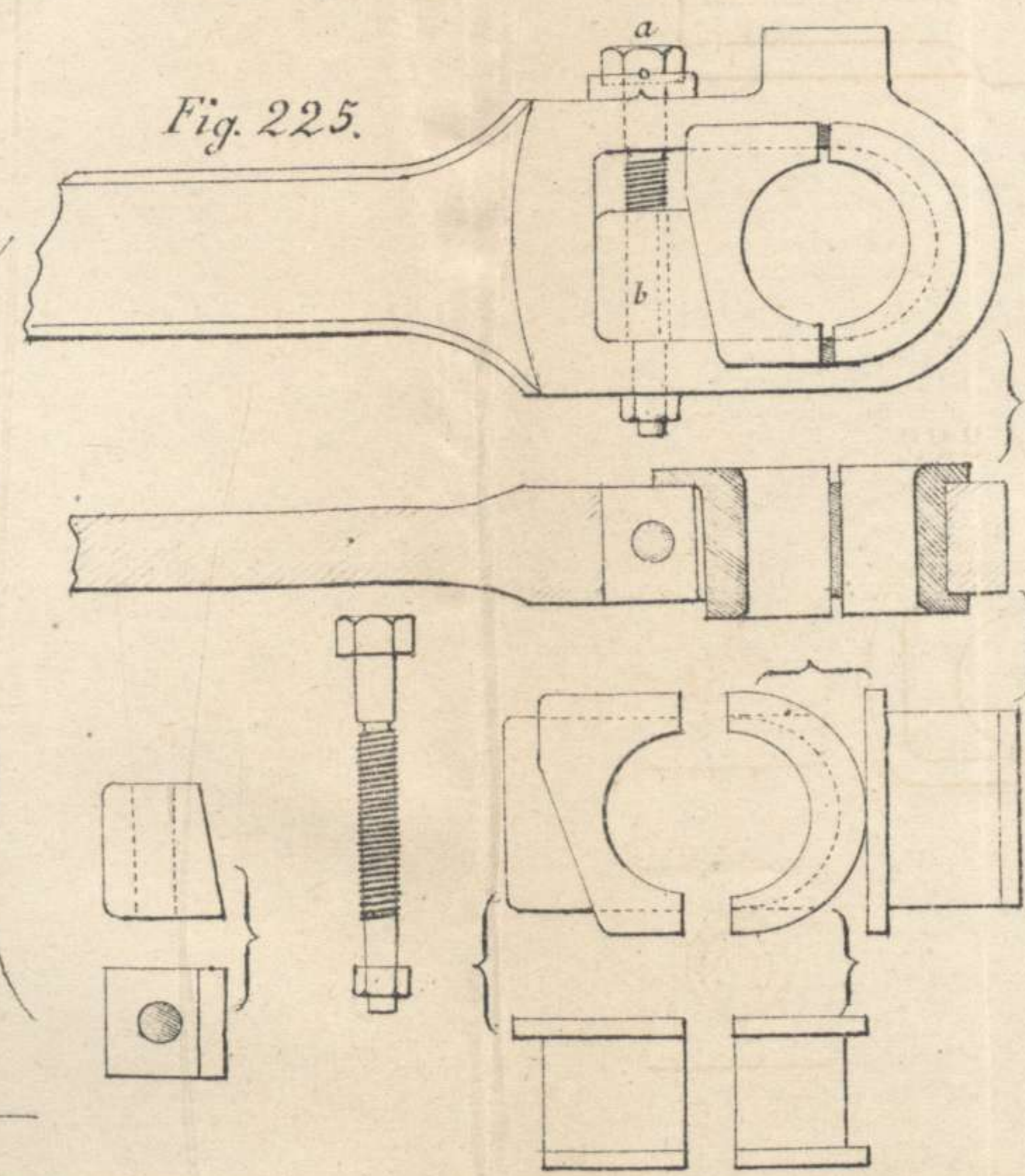

Fig. 231.

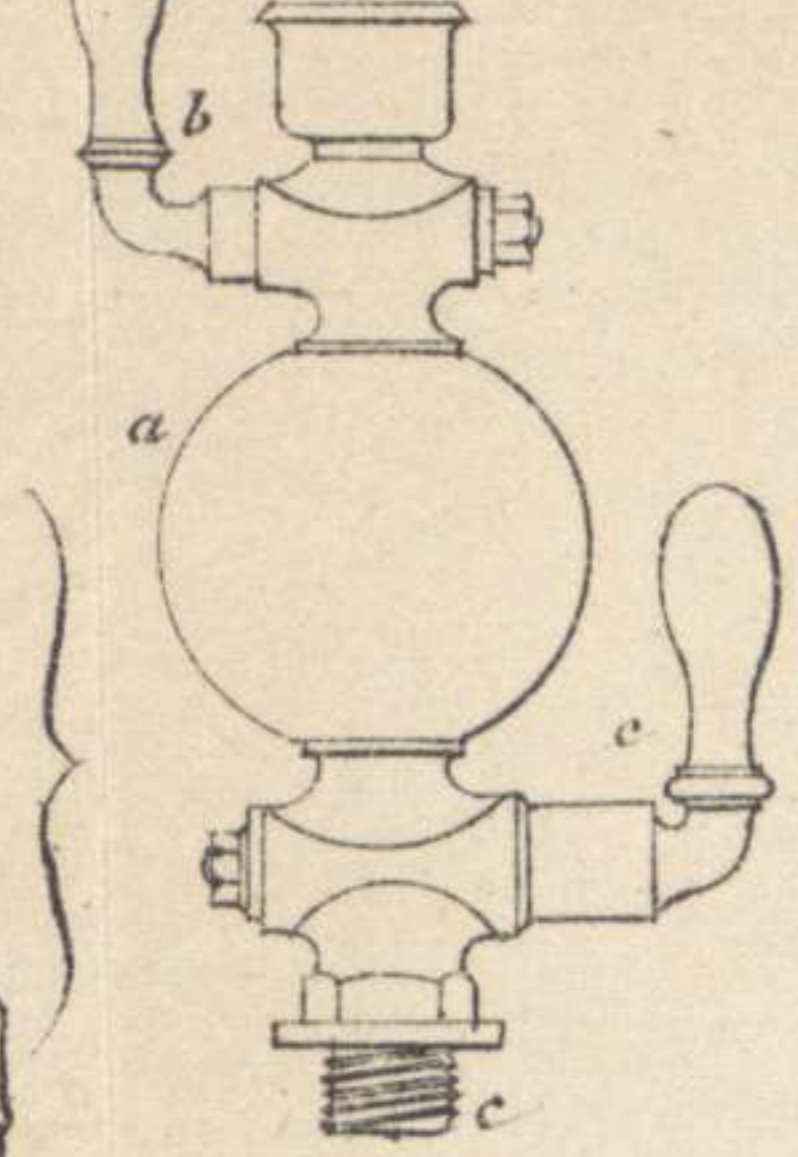

Fig. 232.

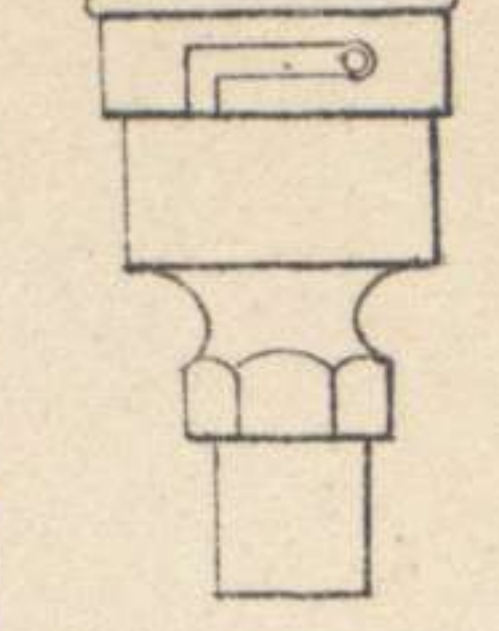

Fig. 233.

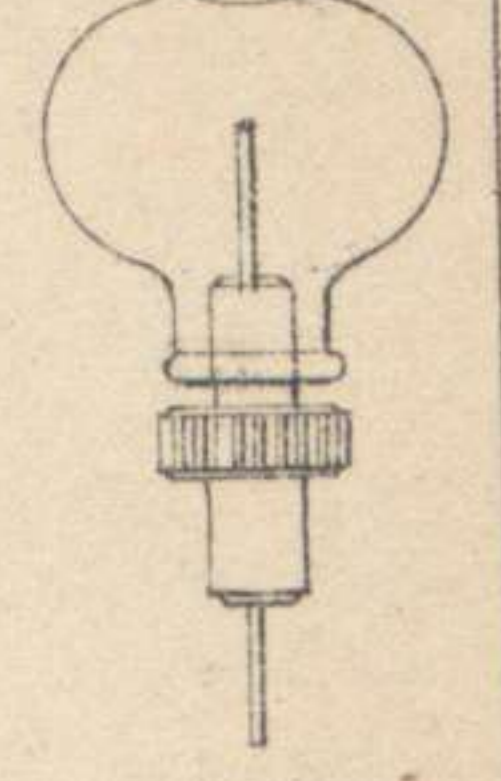

Fig. 230.

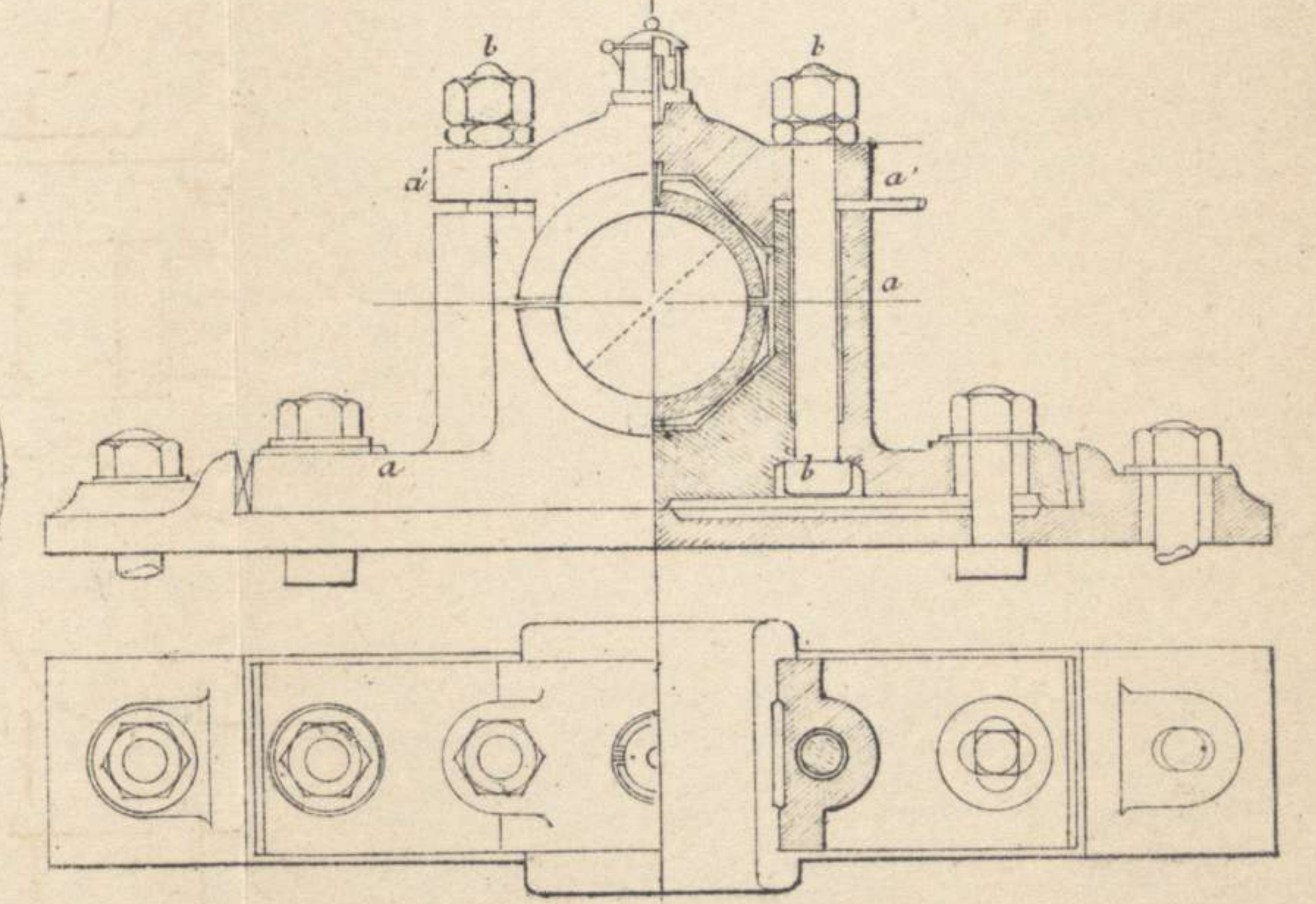

Fig. 238.

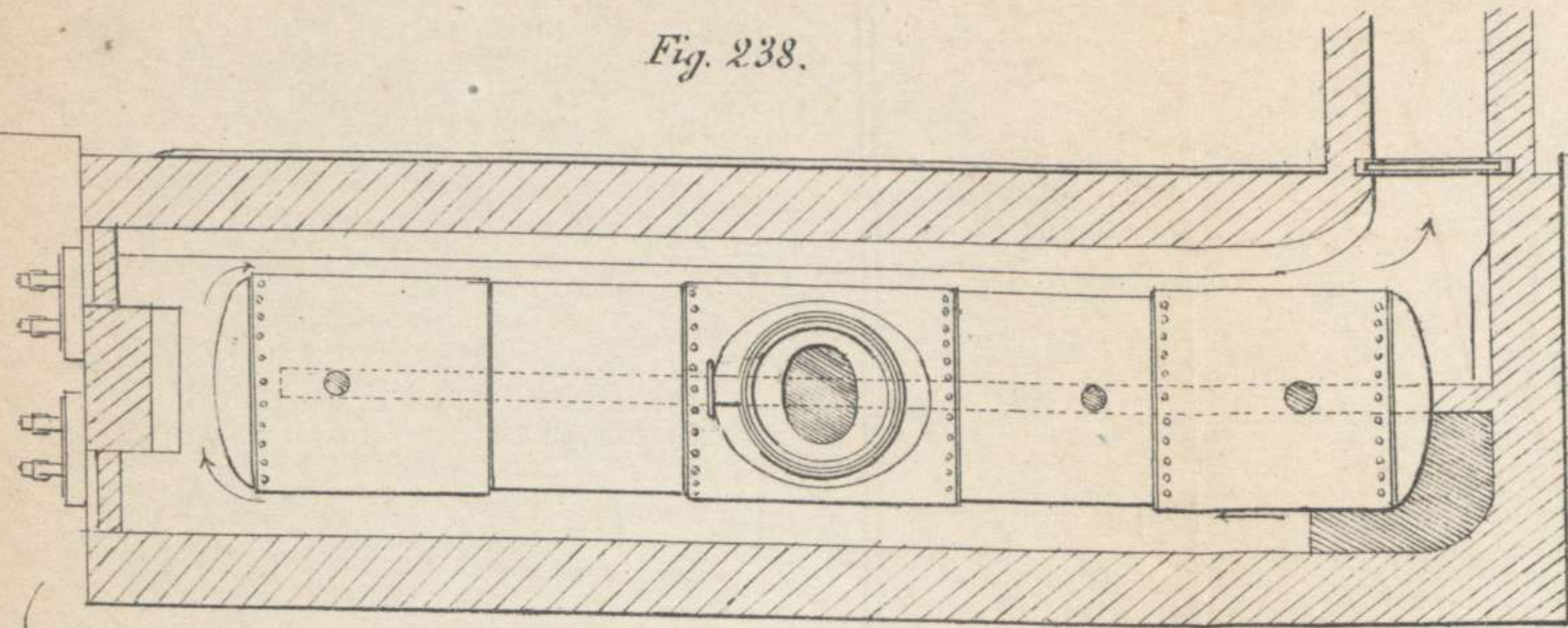

Fig. 235.

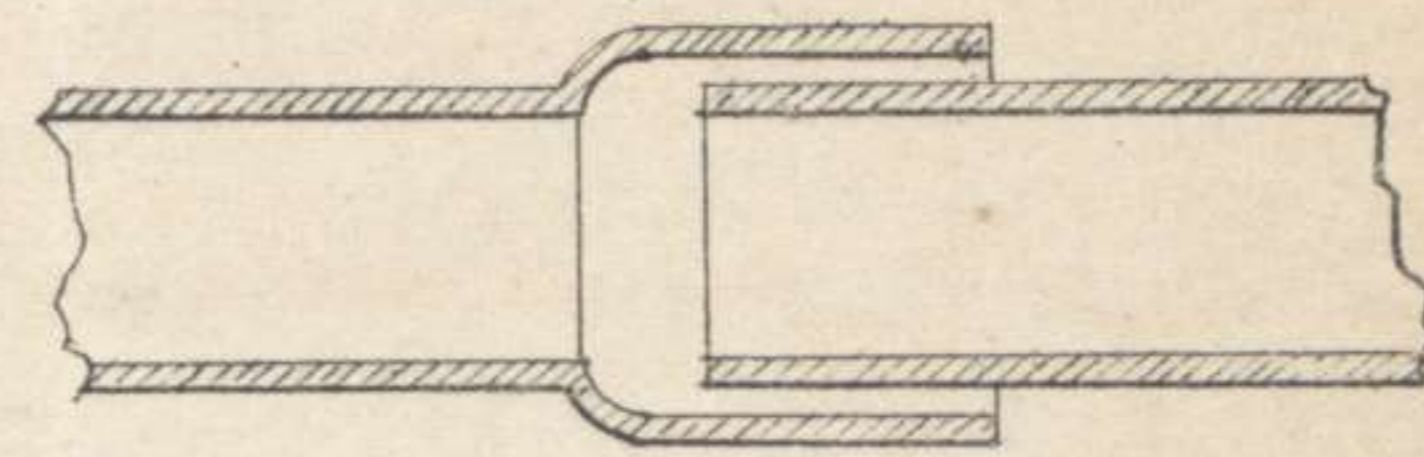

Fig. 236.

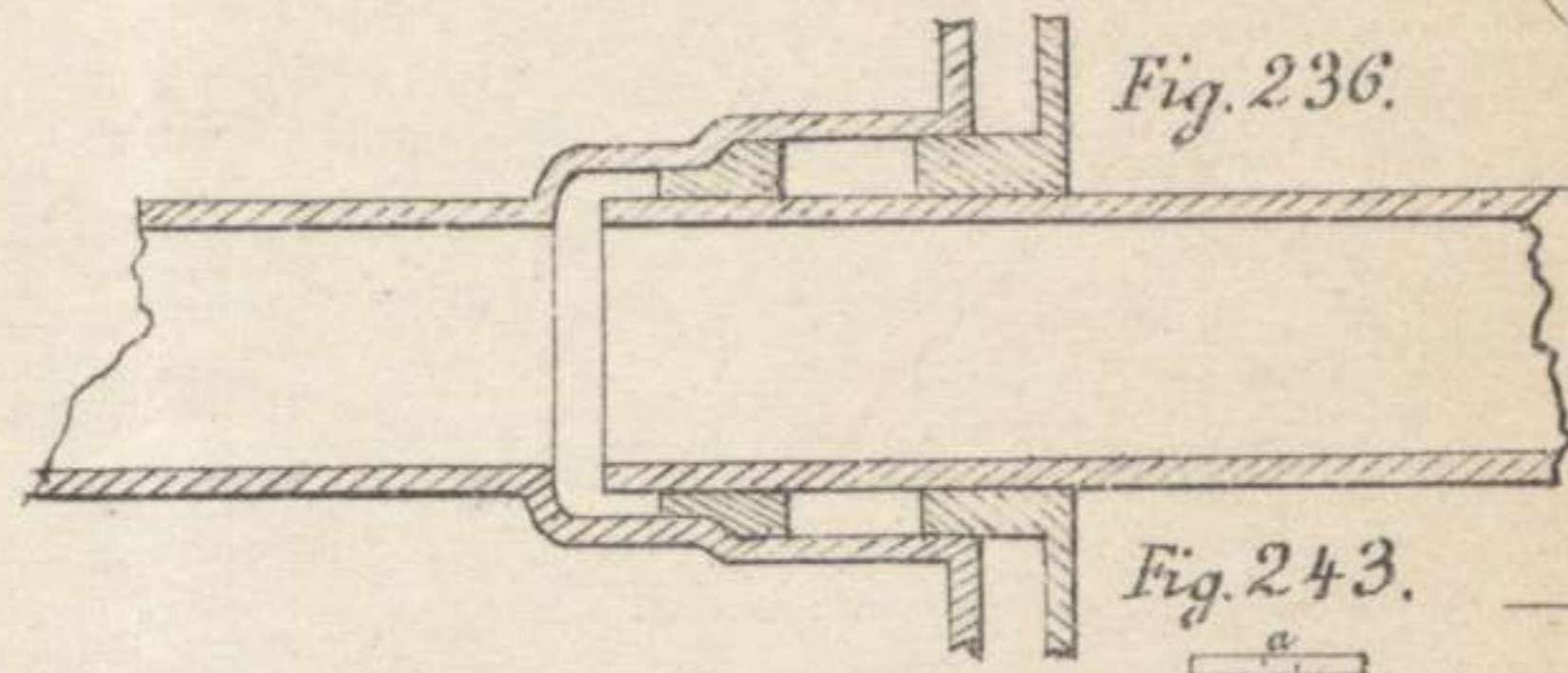

Fig. 243.

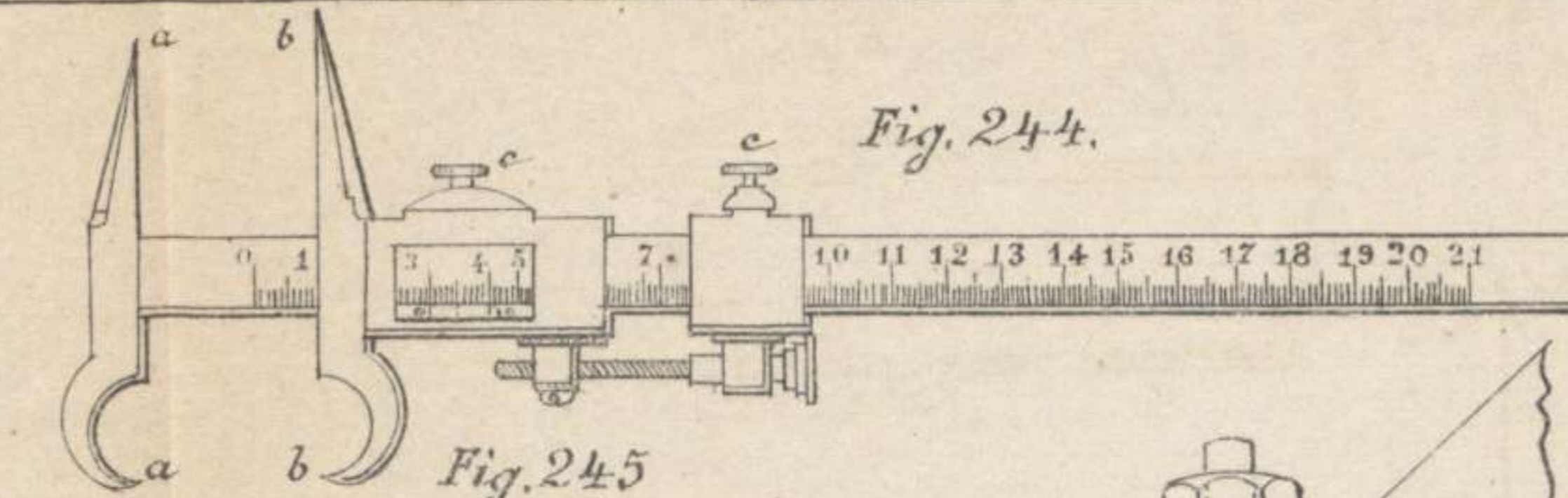
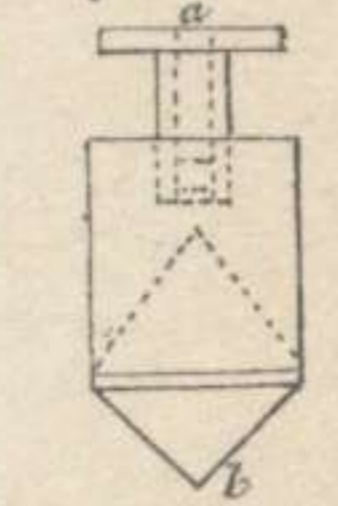

Fig. 244.

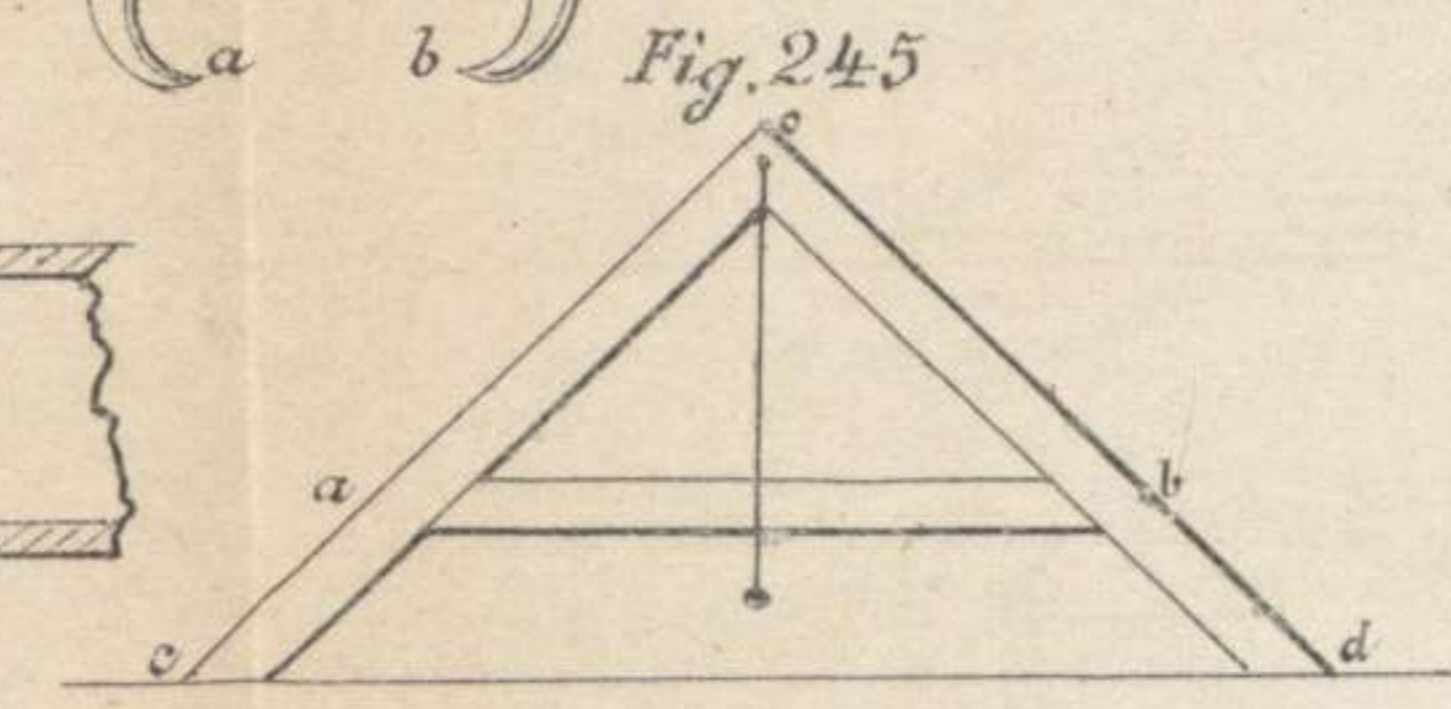

Fig. 245.

Fig. 247.

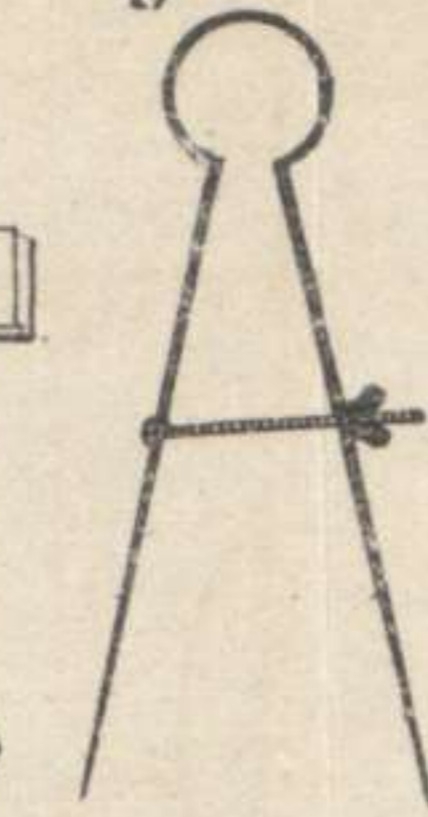

Fig. 246.

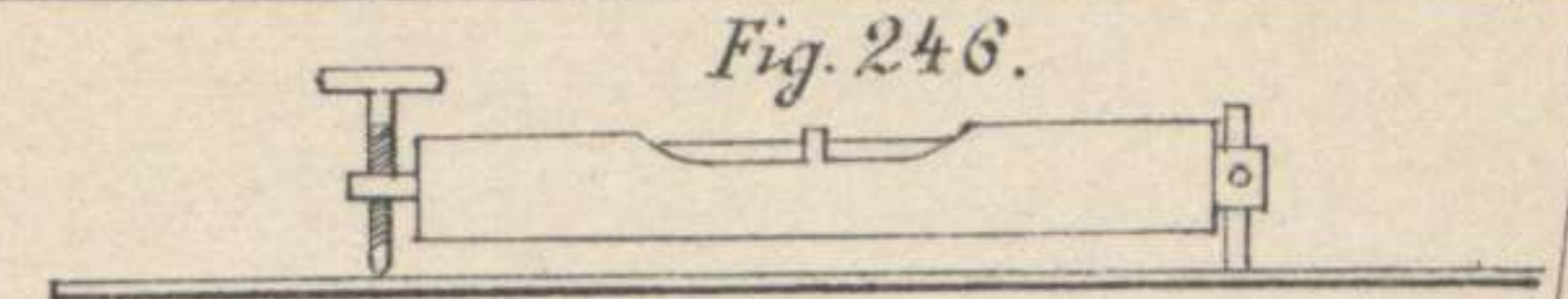

Fig. 248.

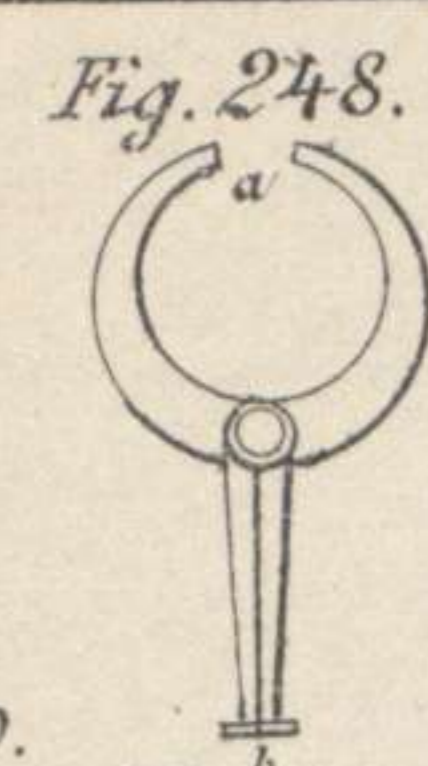

Fig. 244.

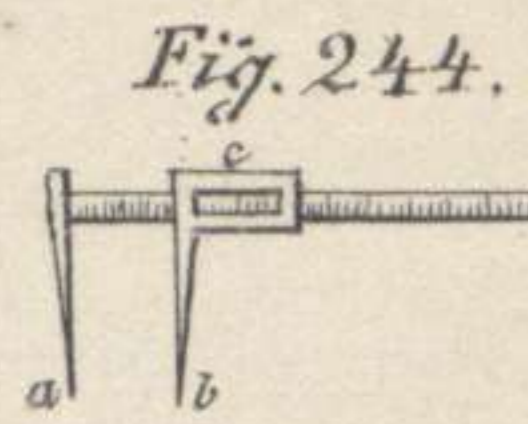

Fig. 249.

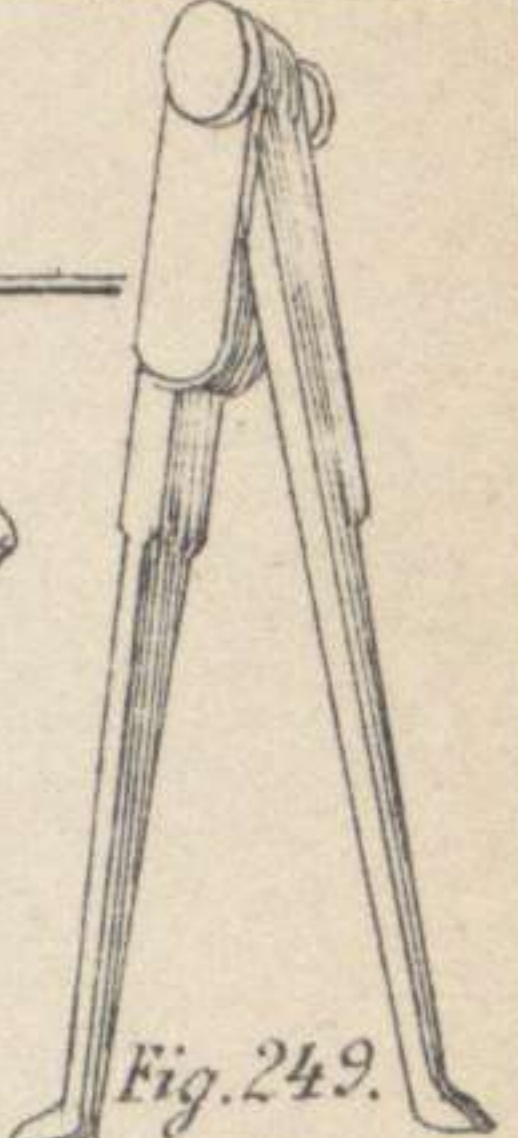

Fig. 250.

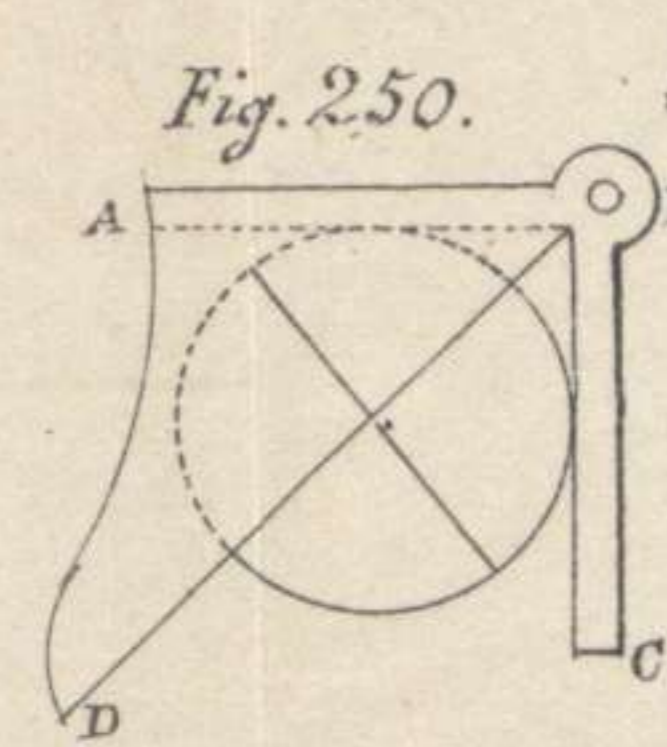

Fig. 241.

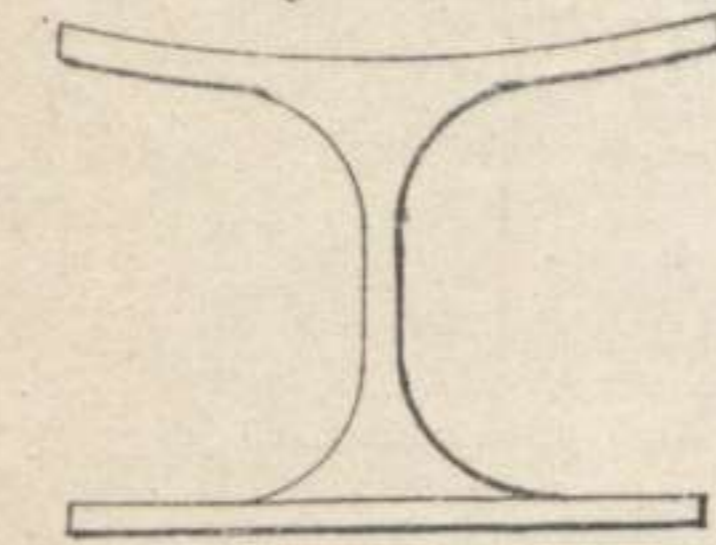

Fig. 242.



Fig. 239.

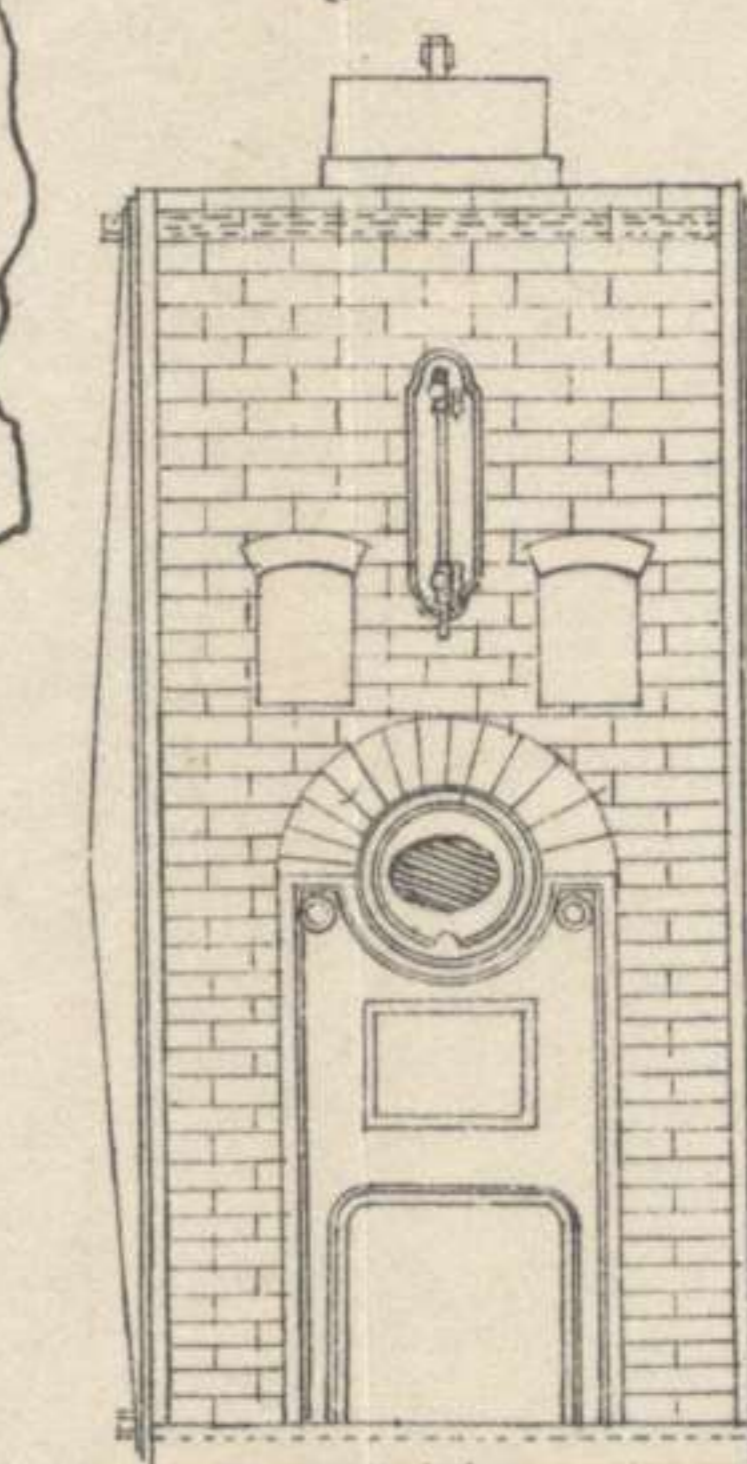

Fig. 234.

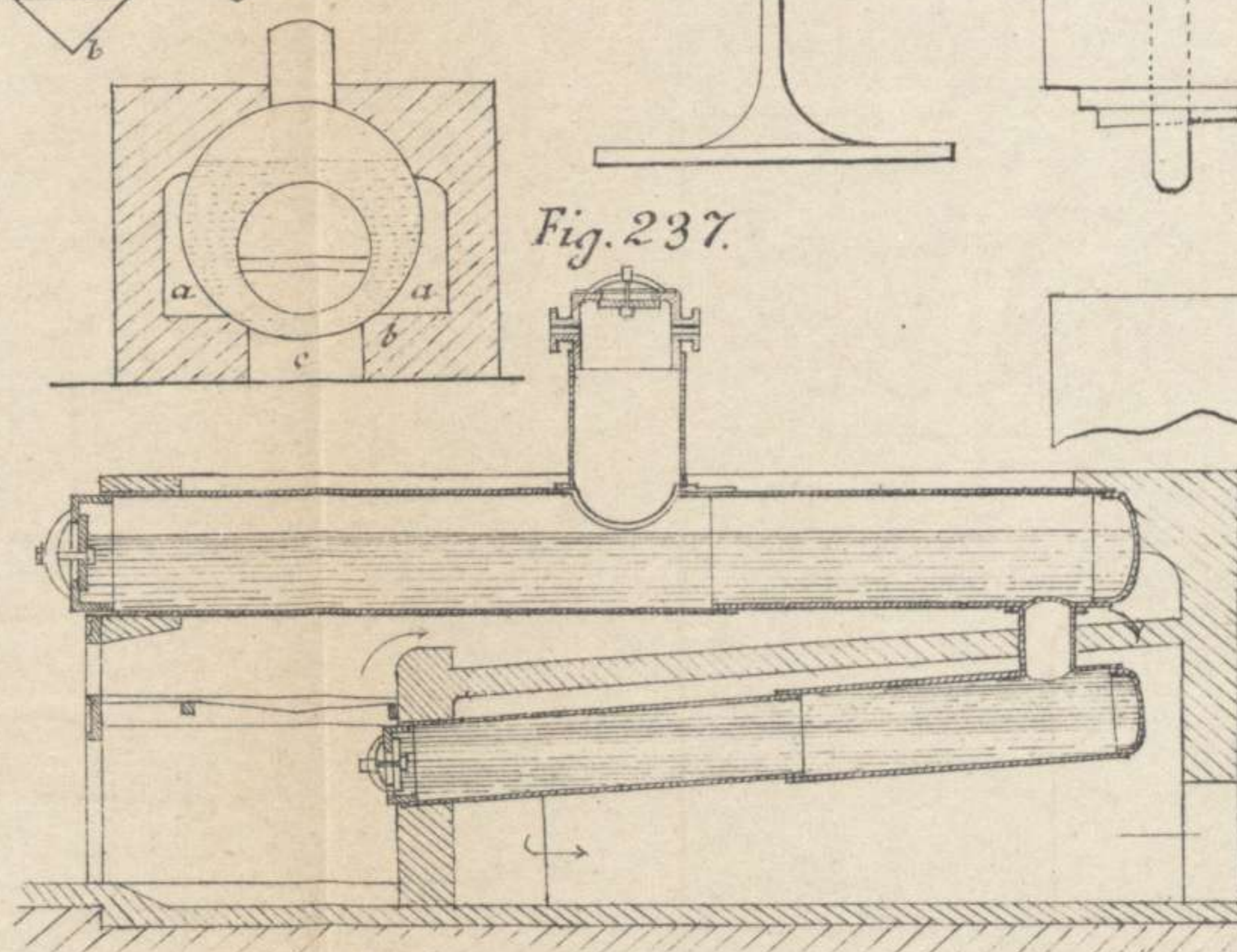
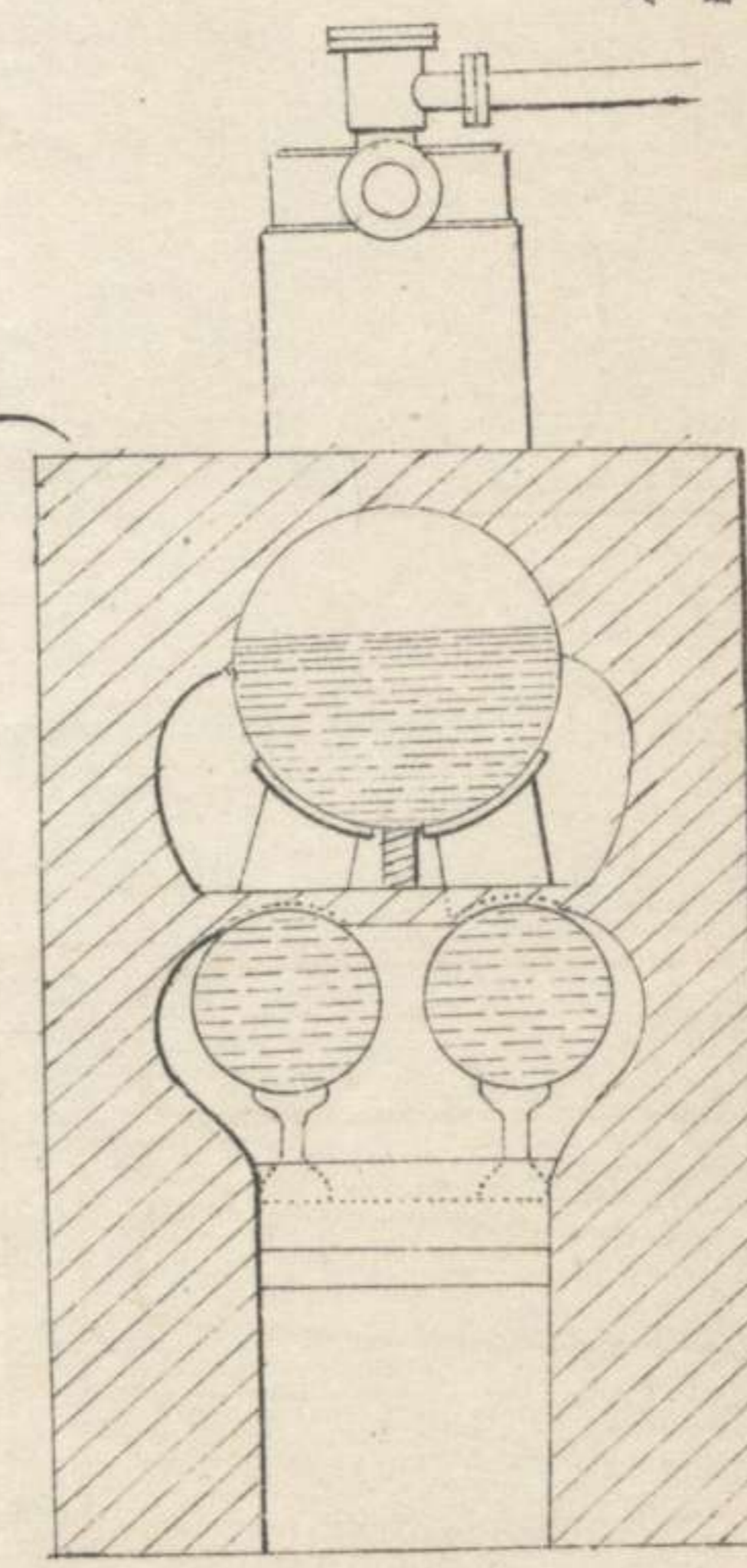
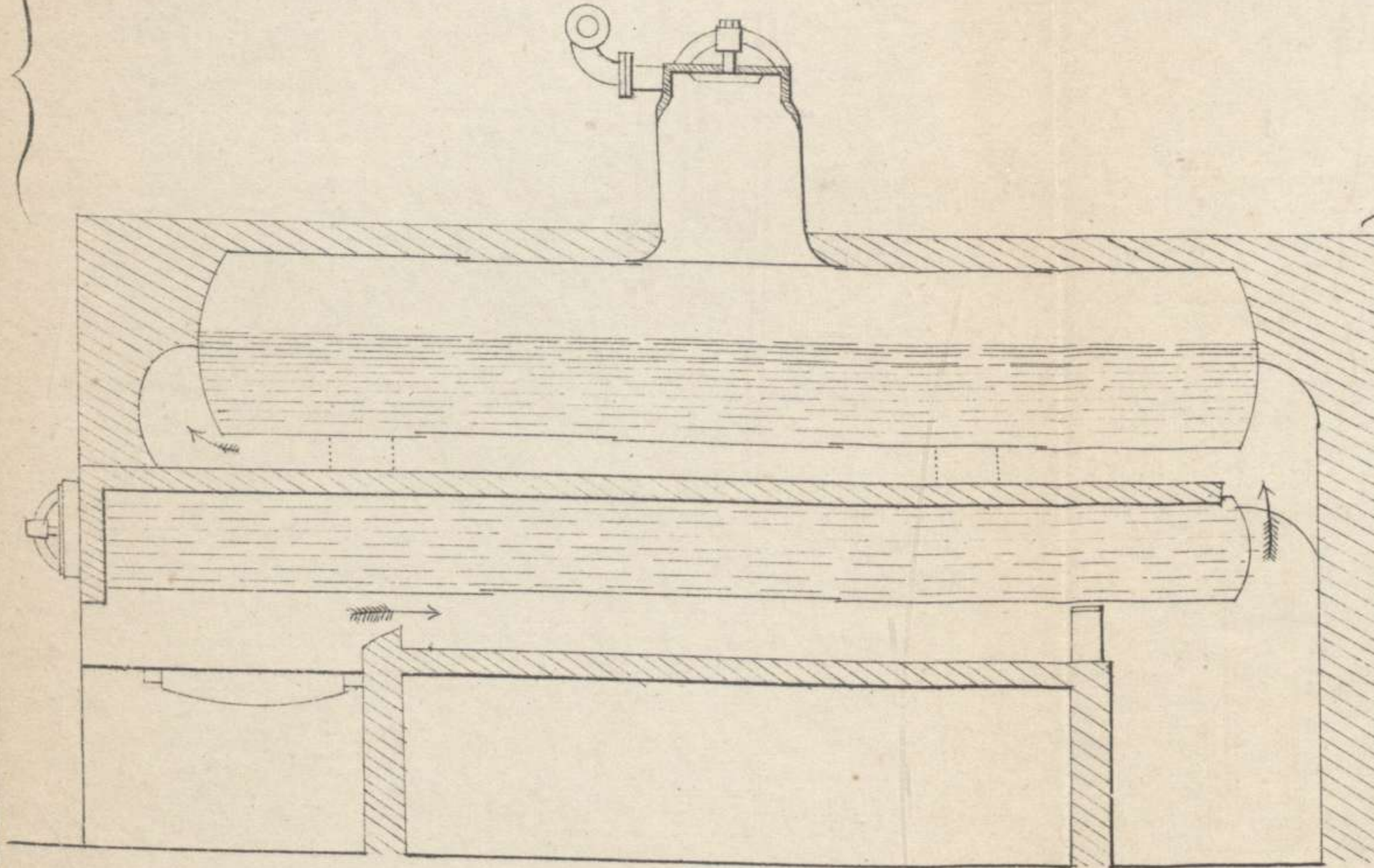
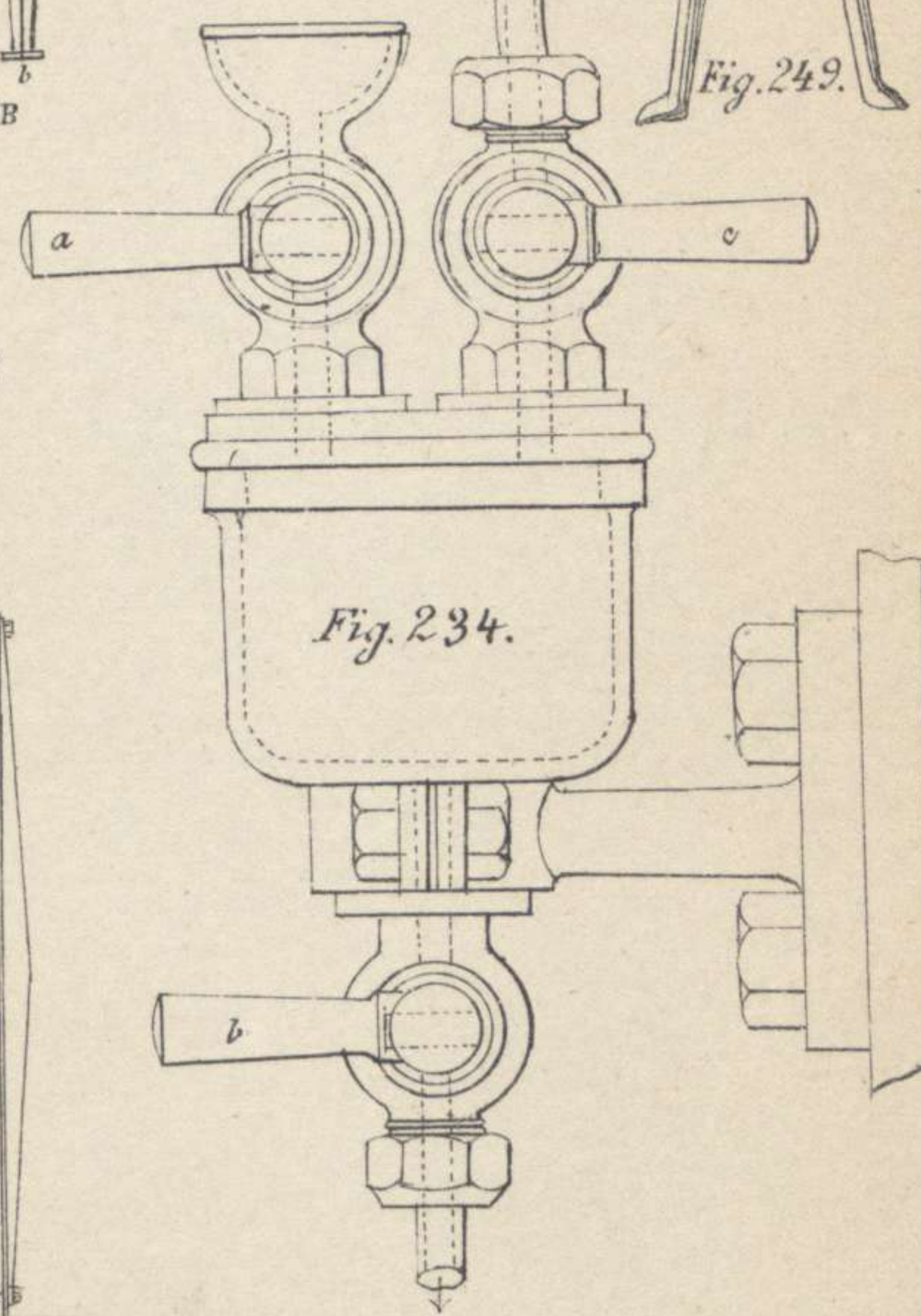

Fig. 240.

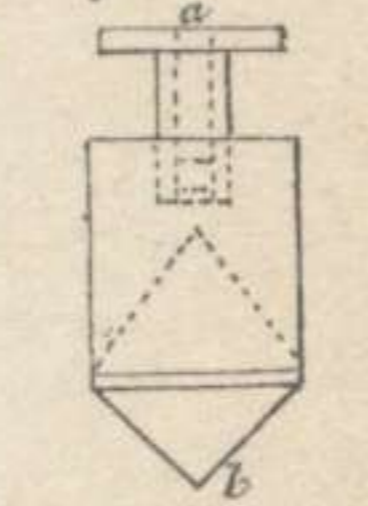

Fig. 237.

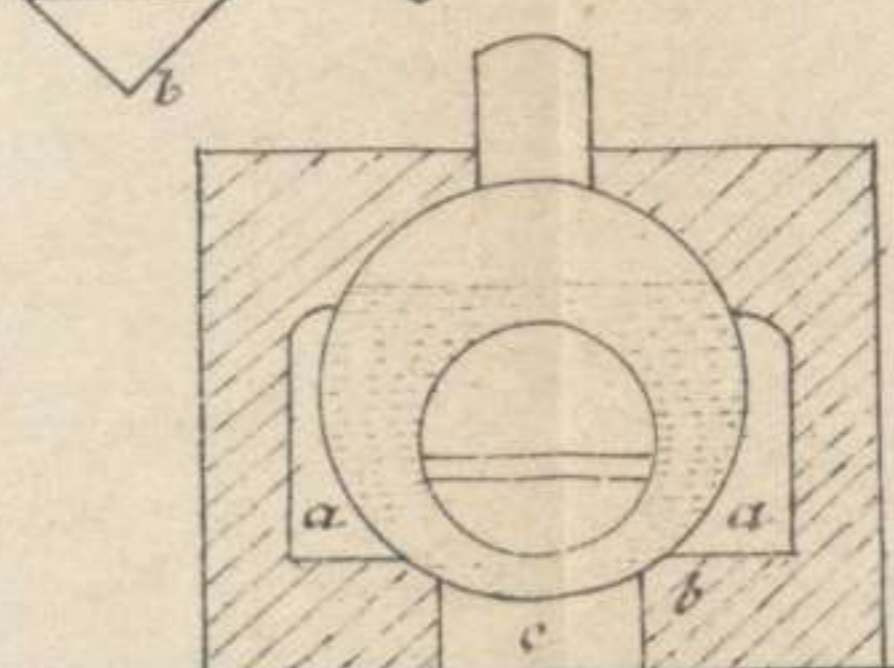

Fig. 251

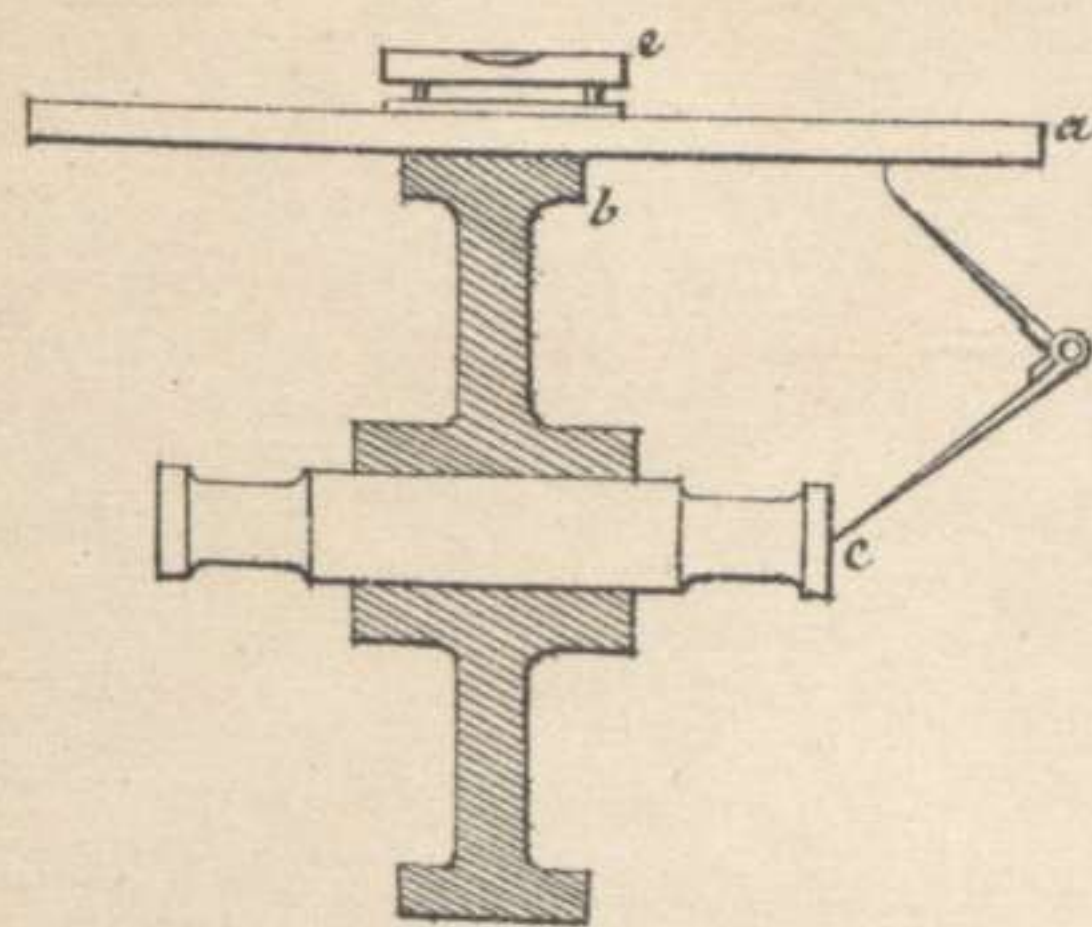

Fig. 252.

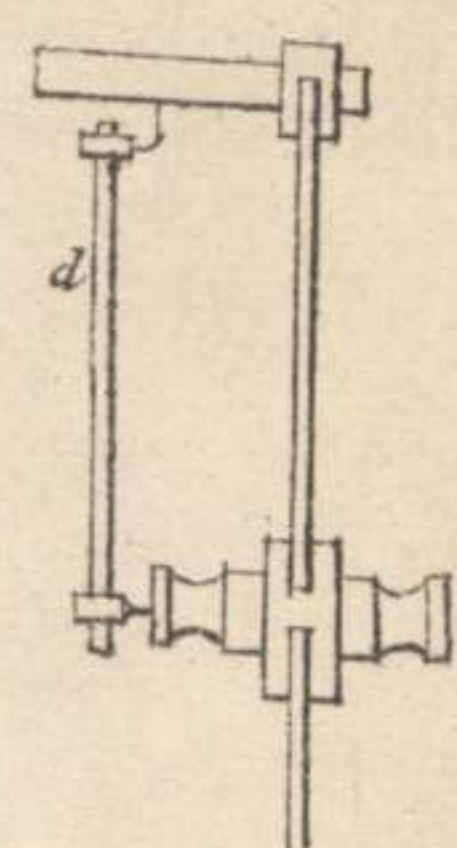

Fig. 253.

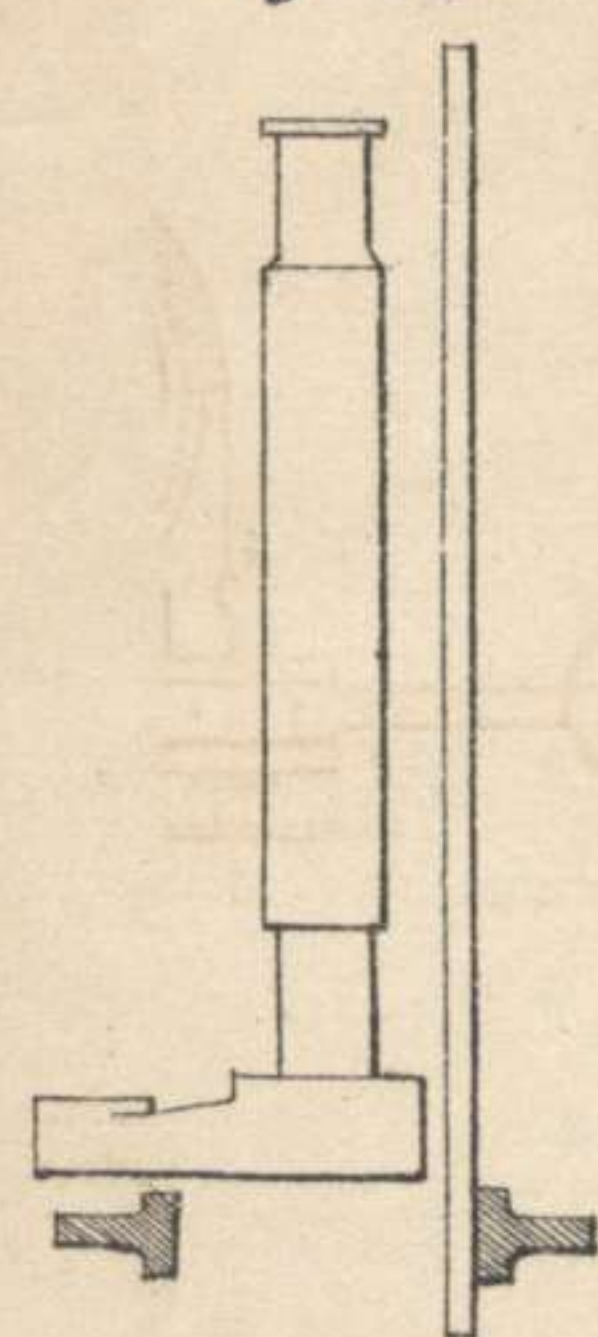

Fig. 254.

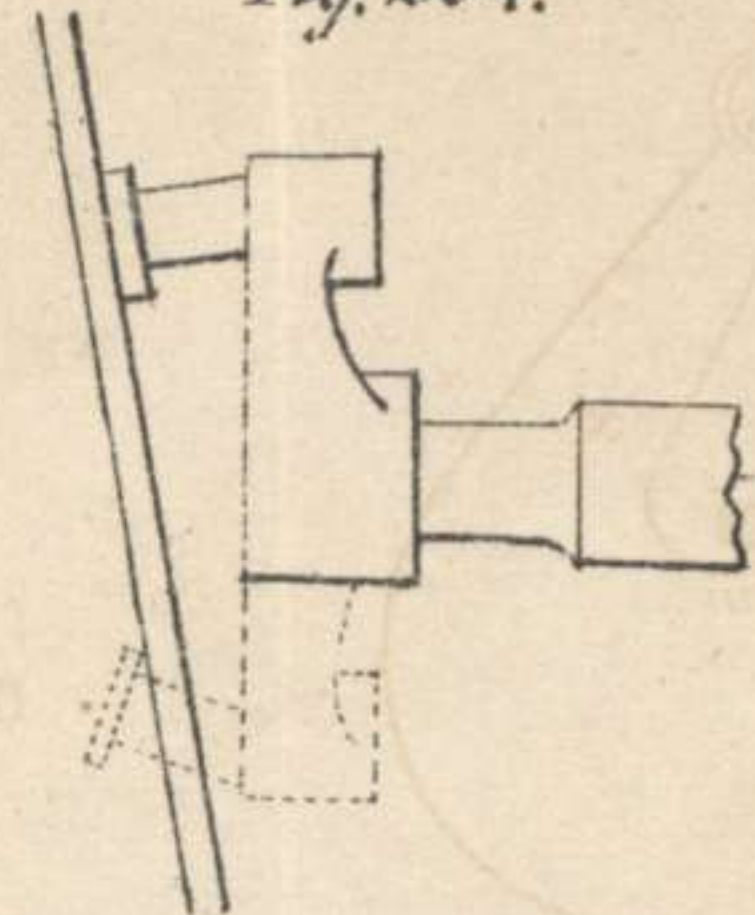

Fig. 255.

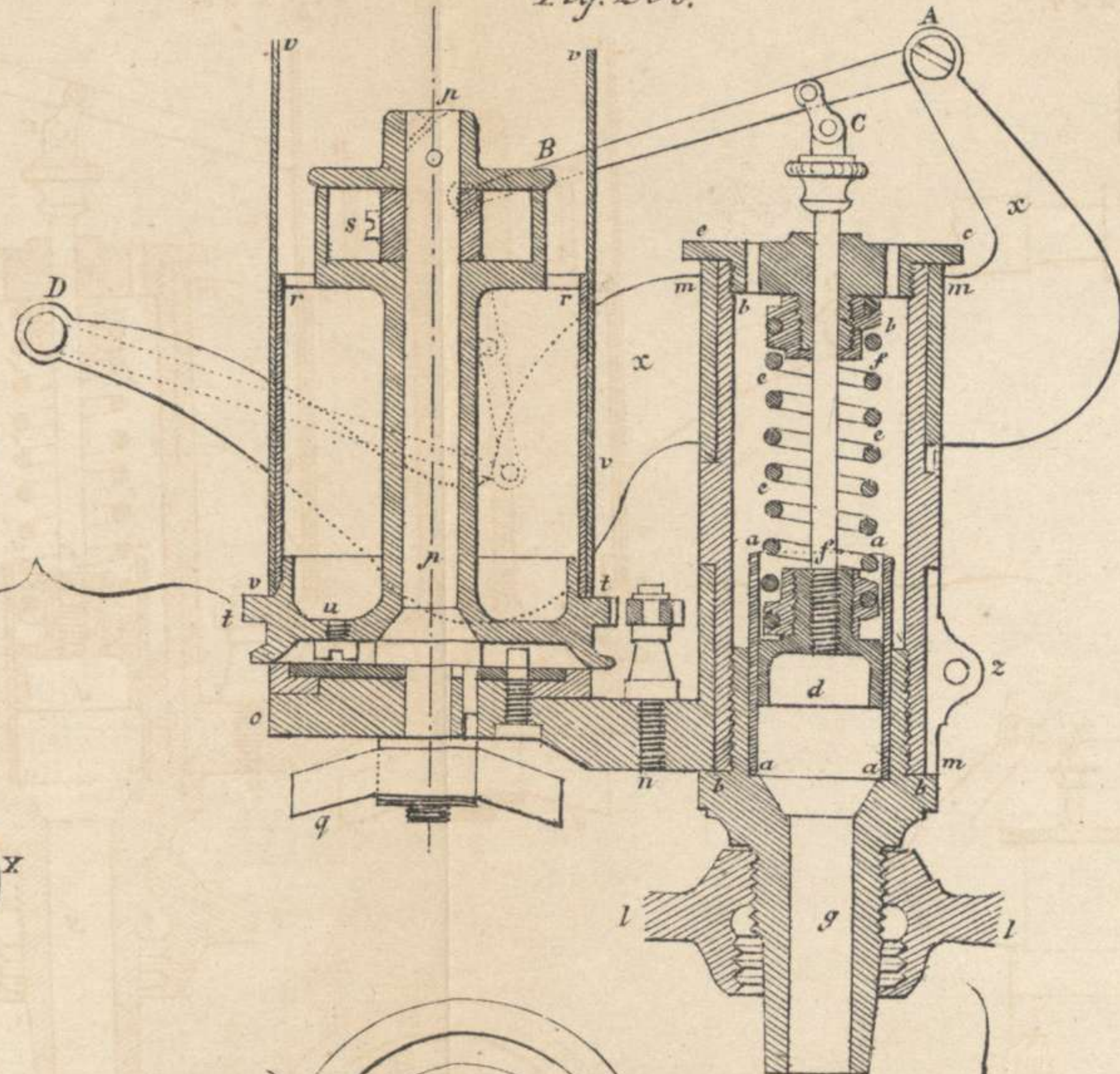

Fig. 261.

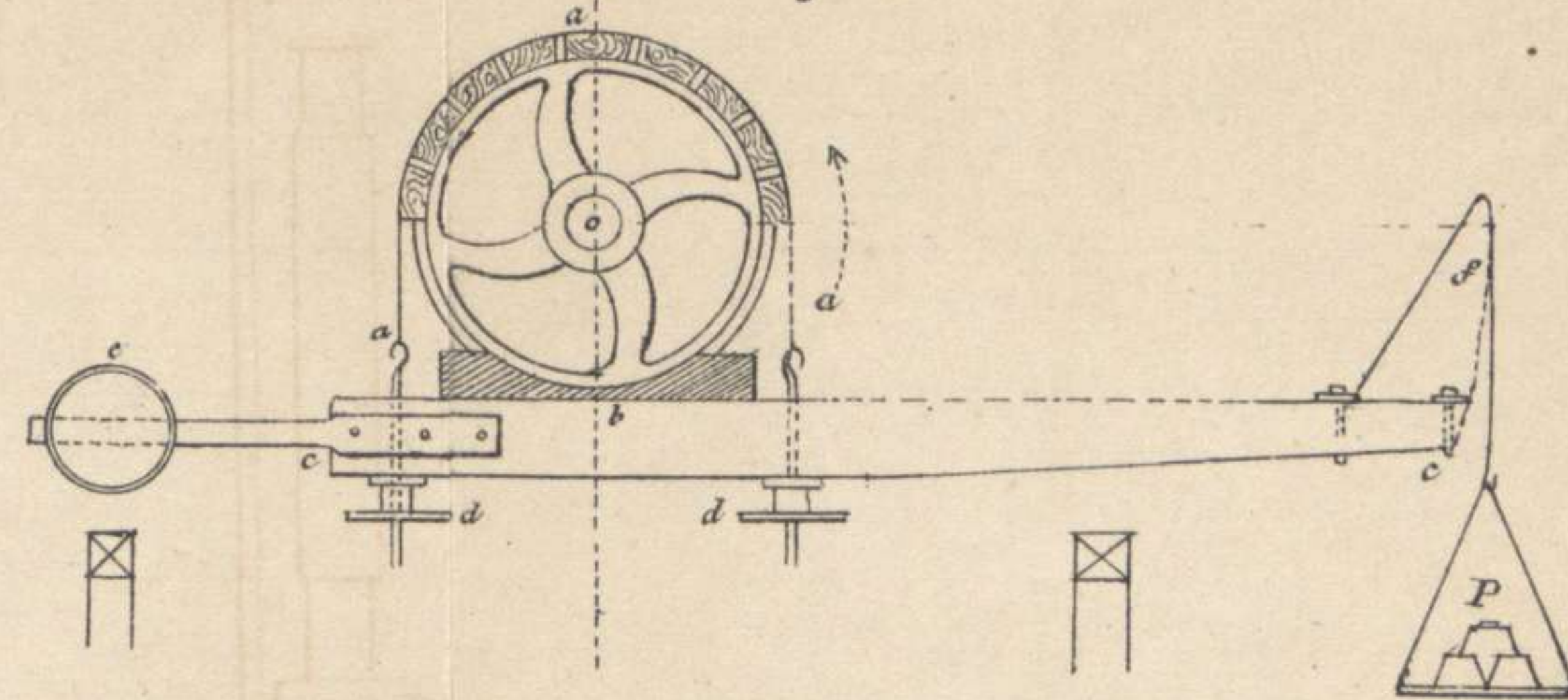

Fig. 256.

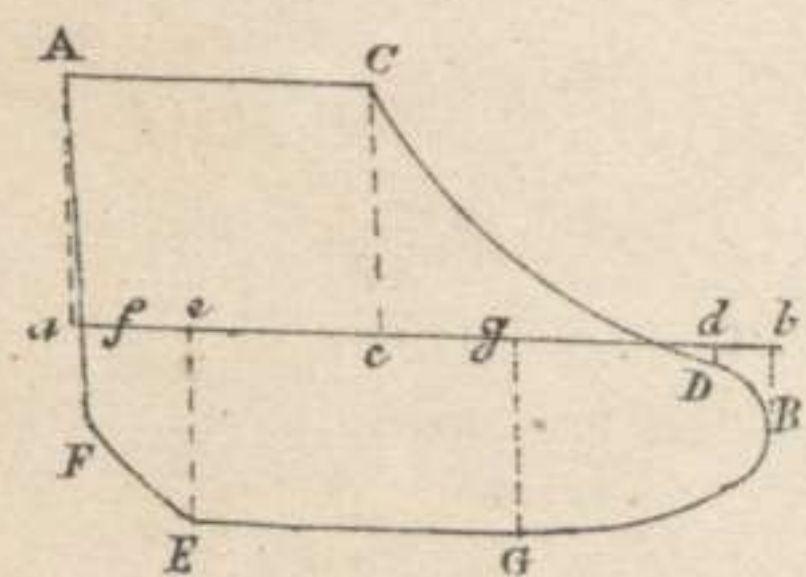

Fig. 257.

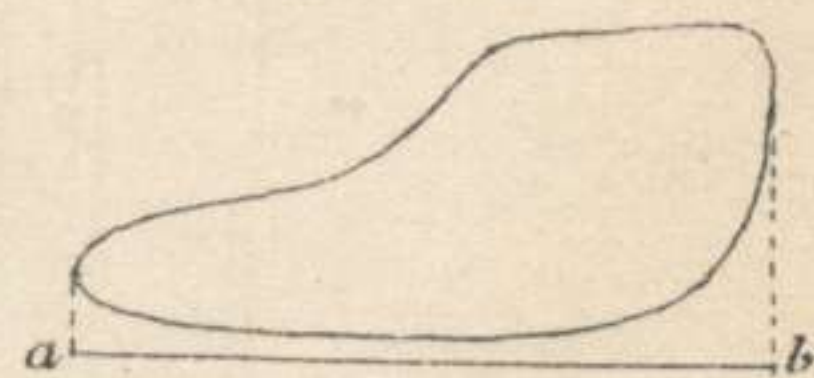

Fig. 260.

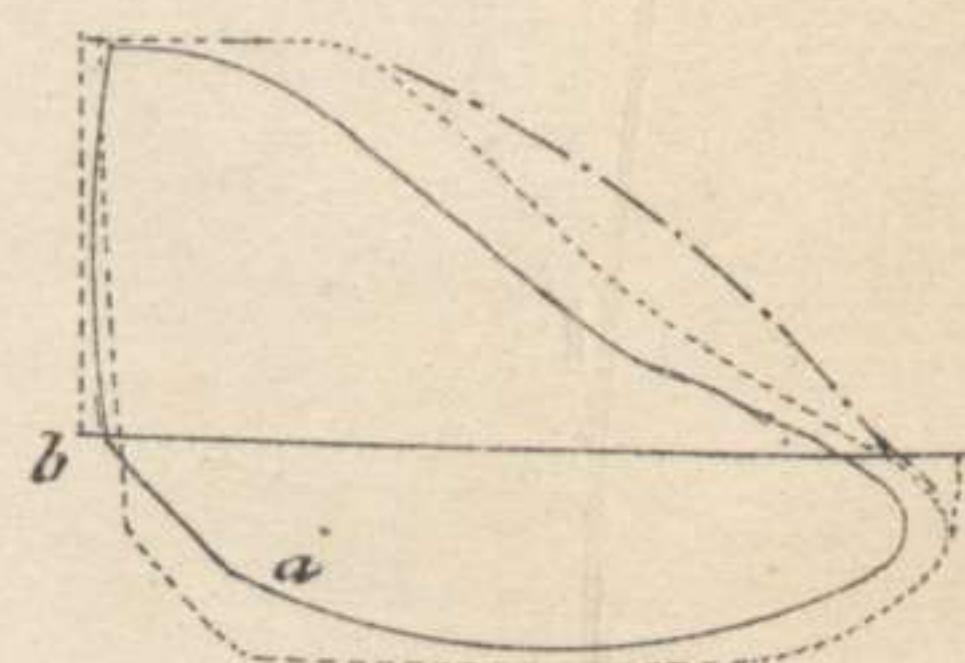

Fig. 259.

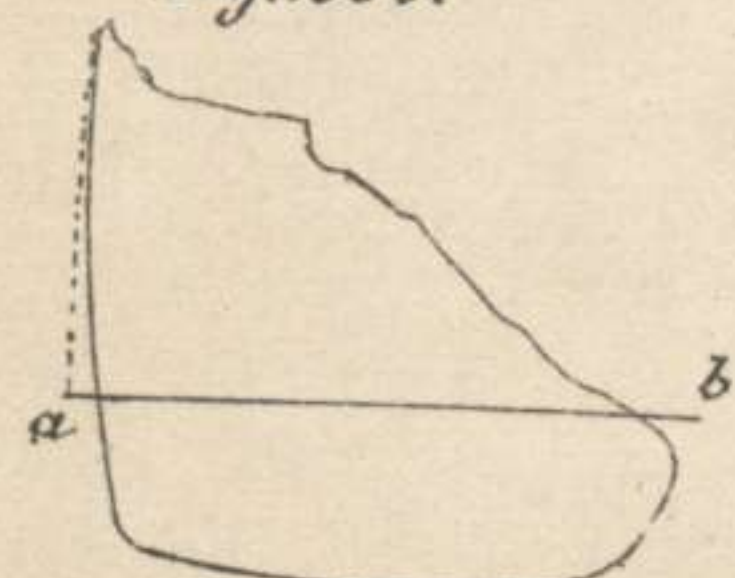

Fig. 258.

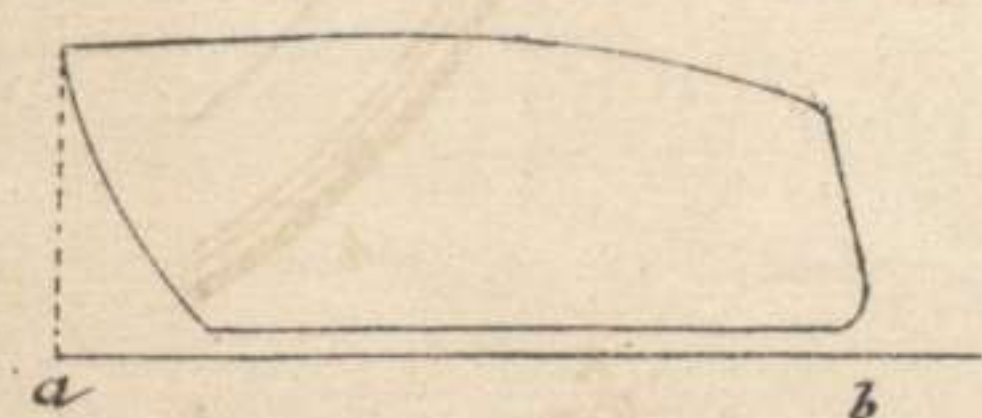

Fig. 262.

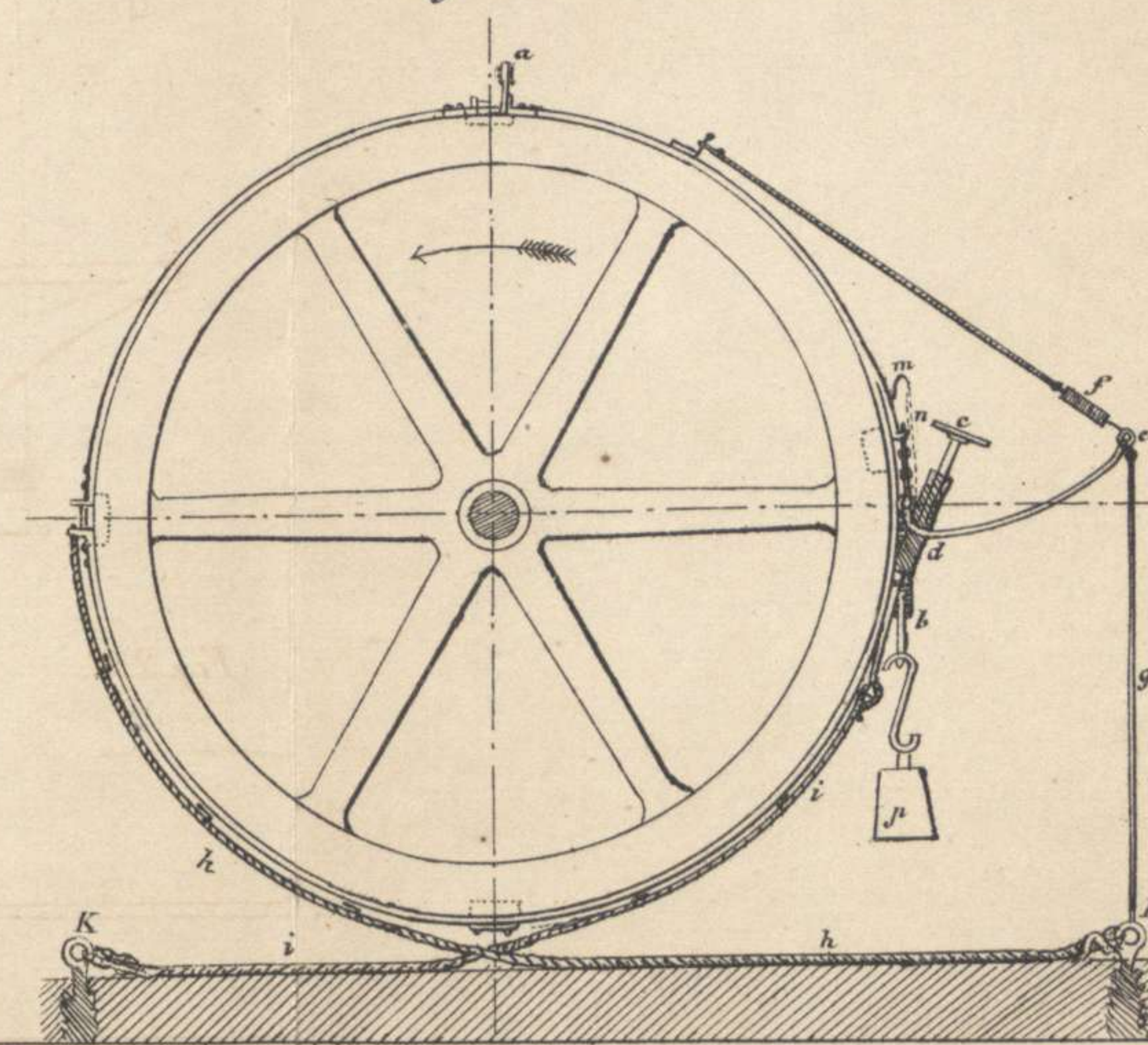

Fig. 263.

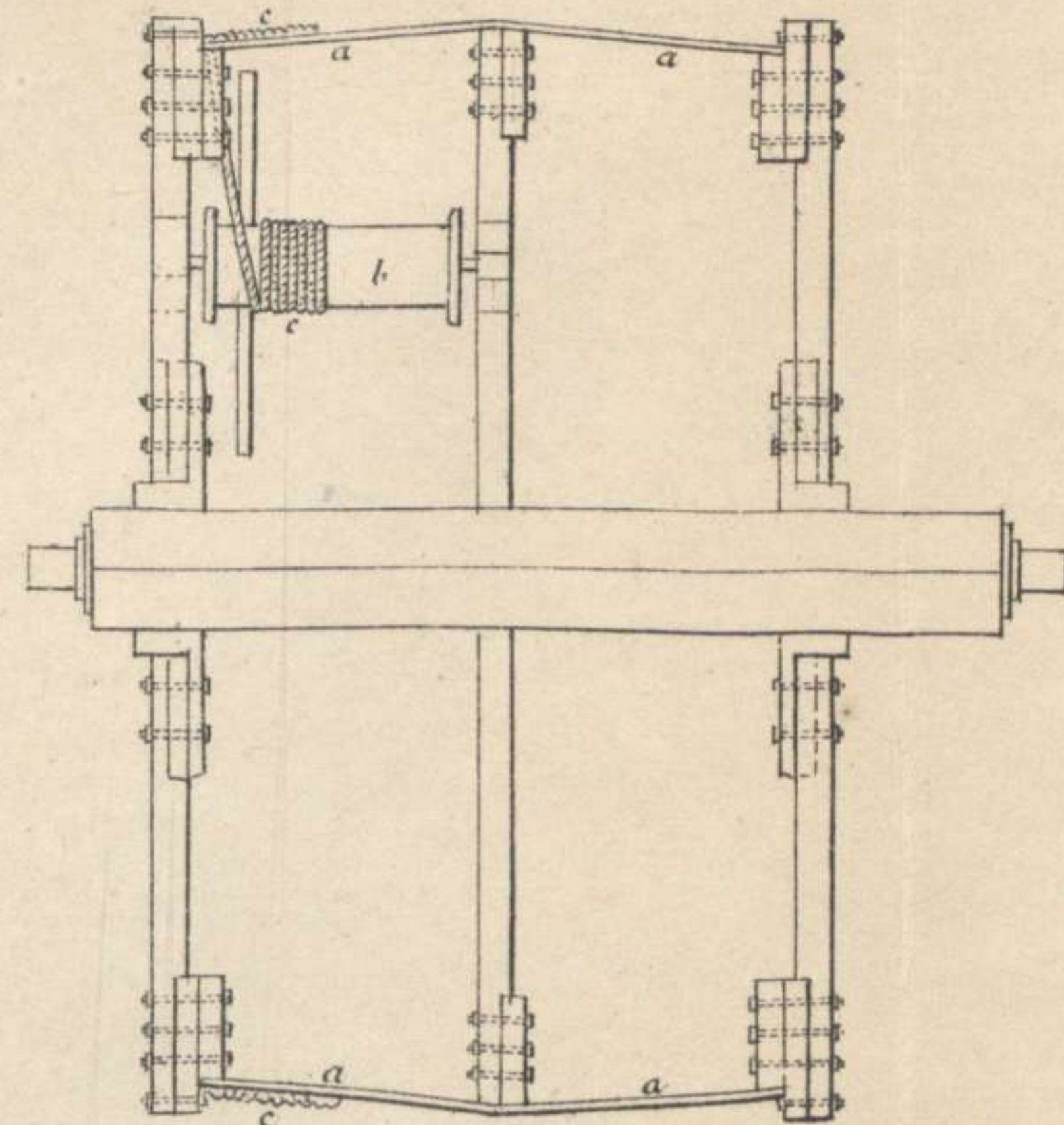

Fig. 264.

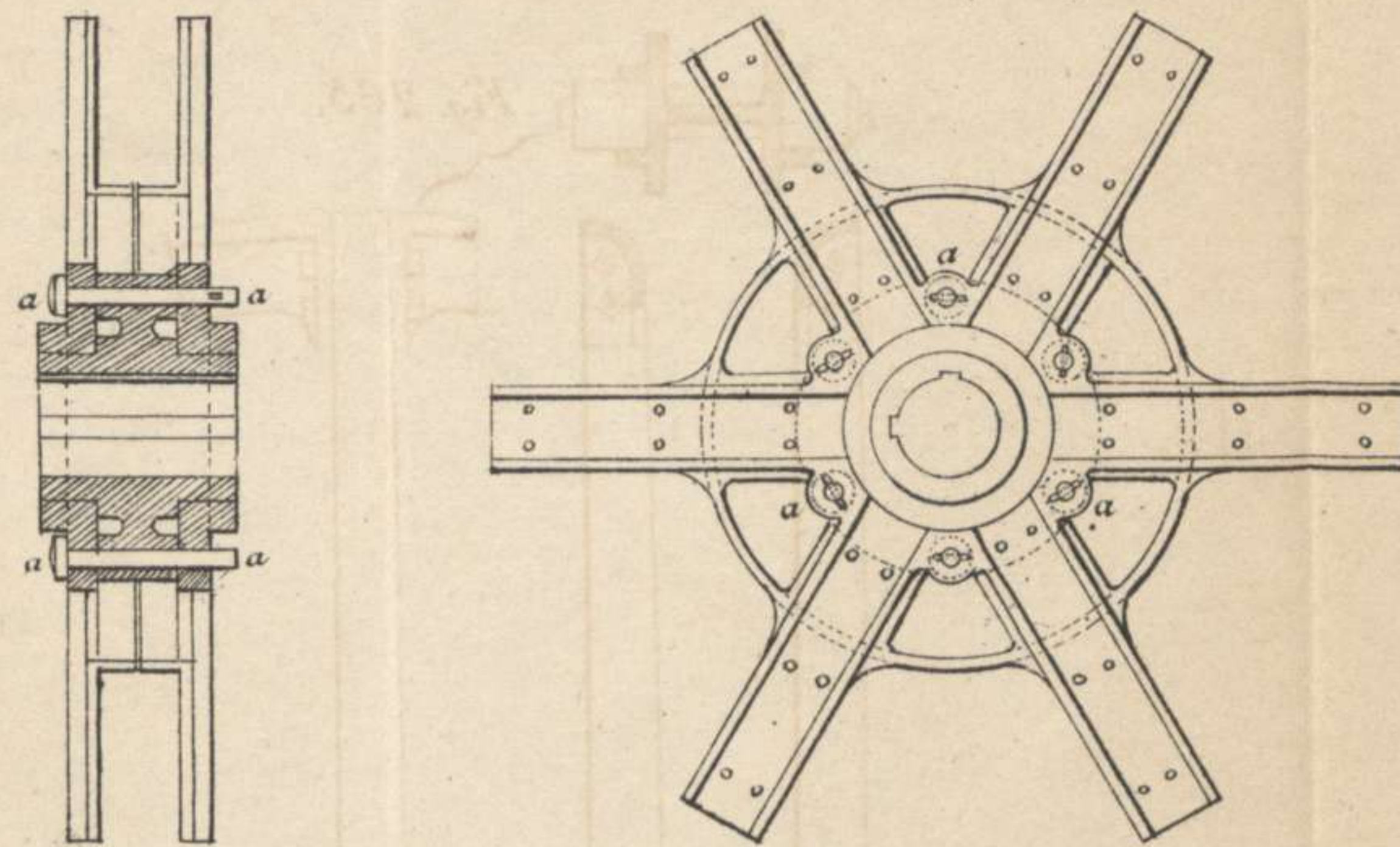

Fig. 265.

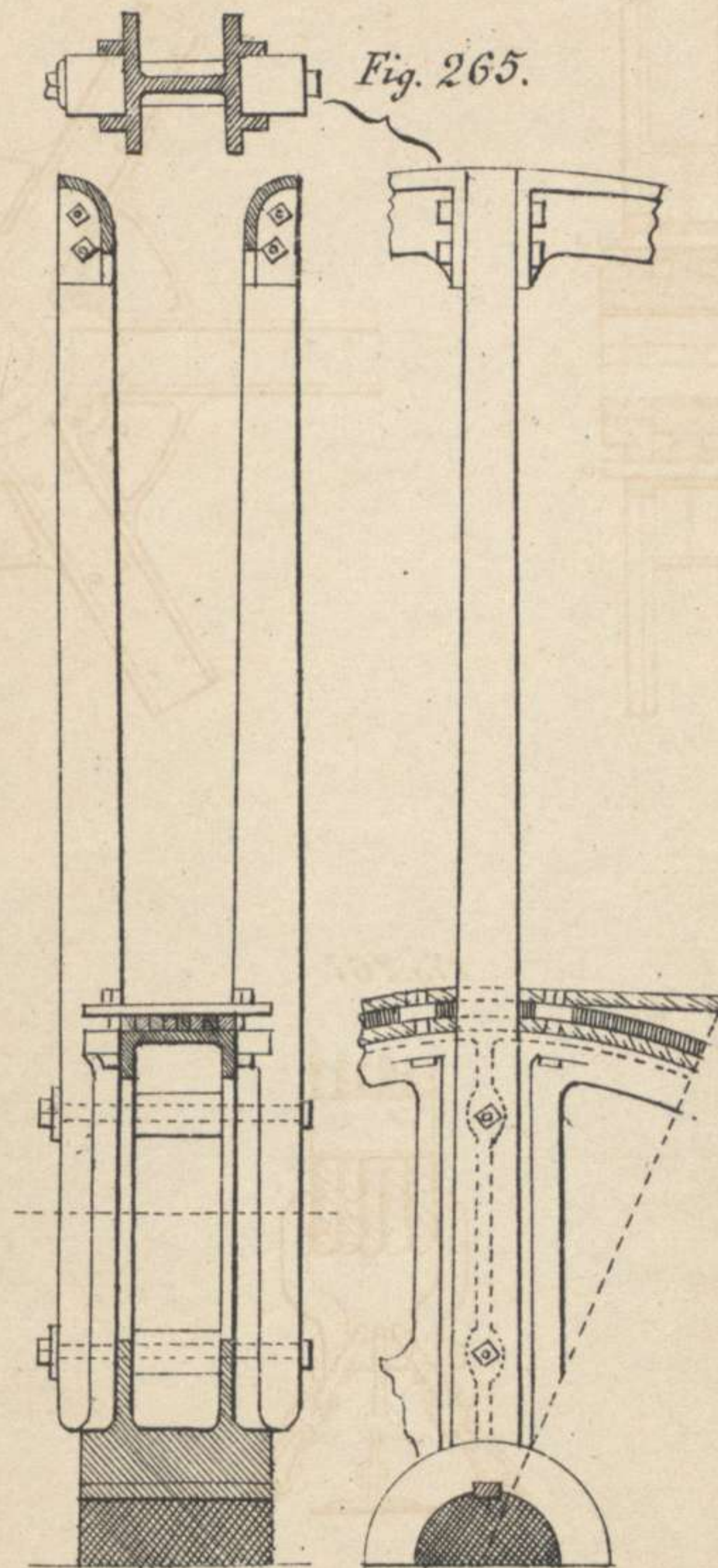

Fig. 269.

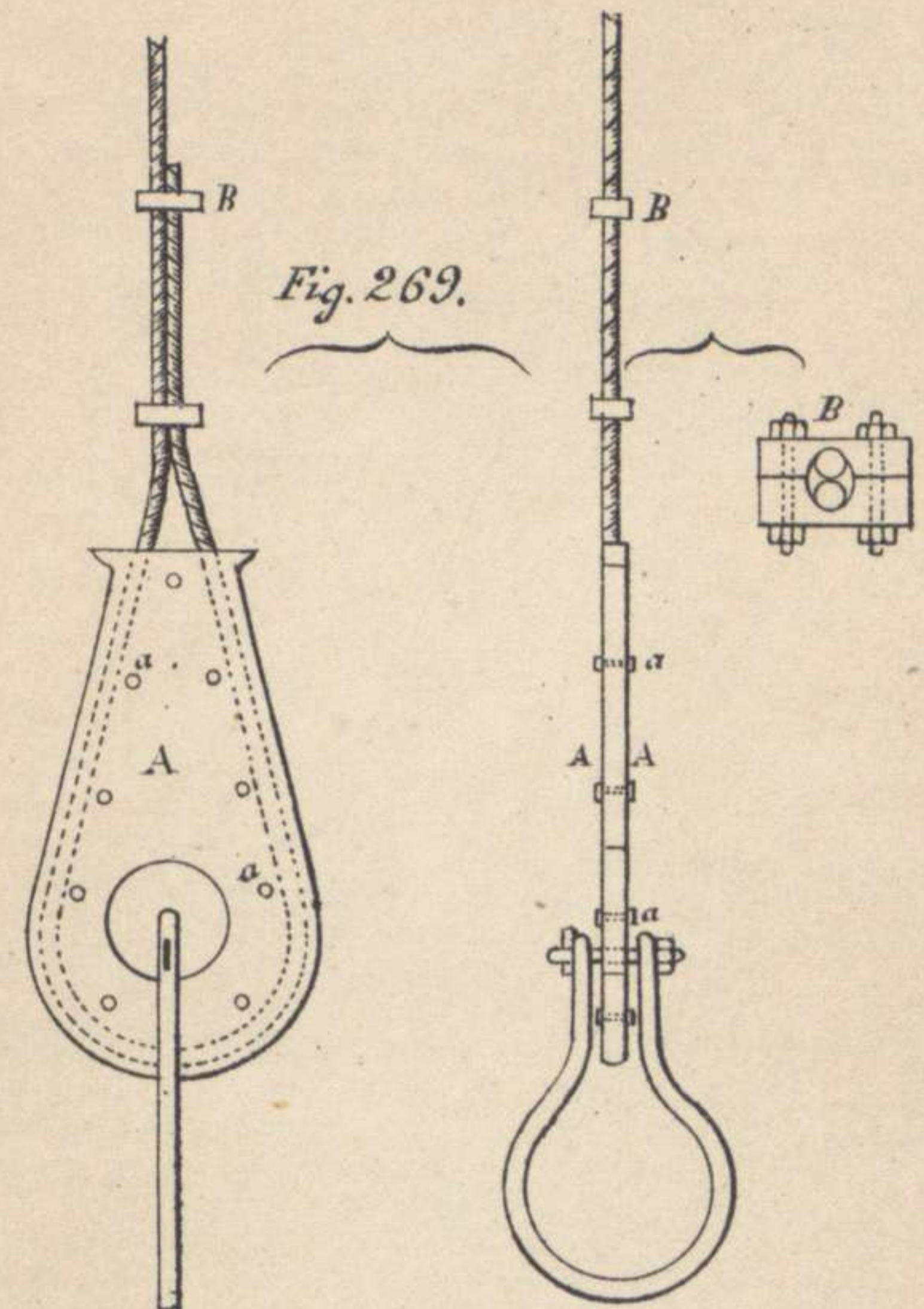

Fig. 266.

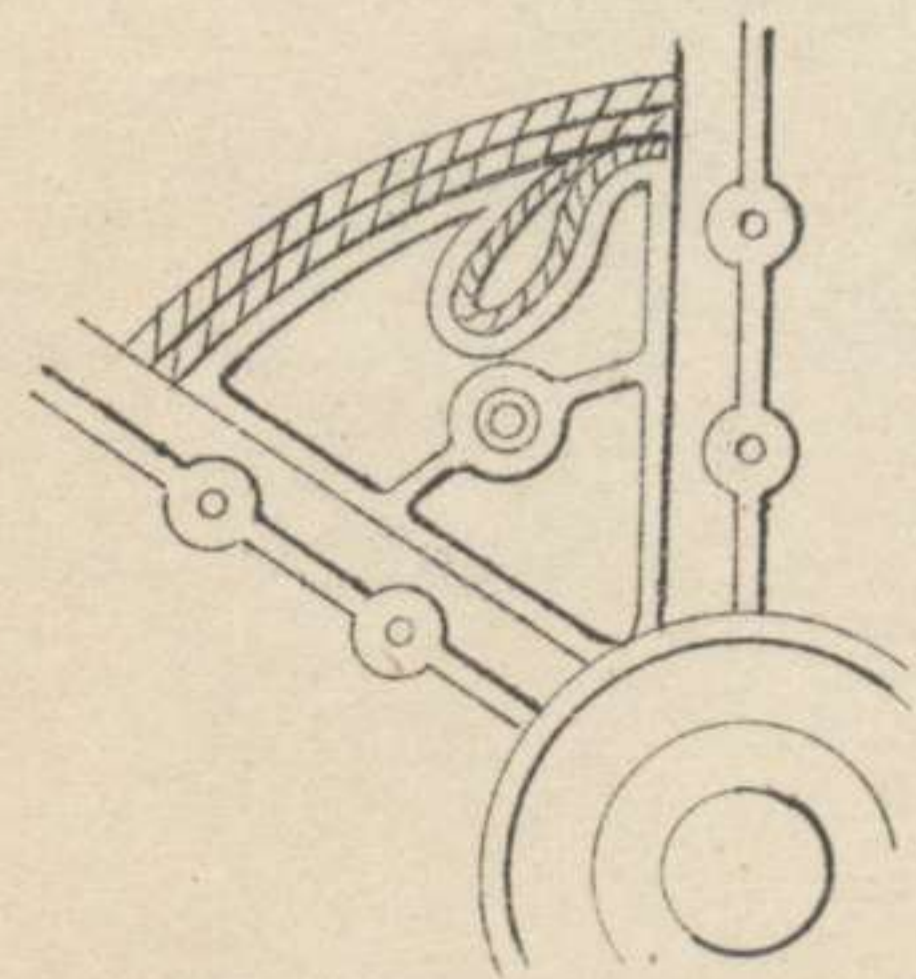

Fig. 267.

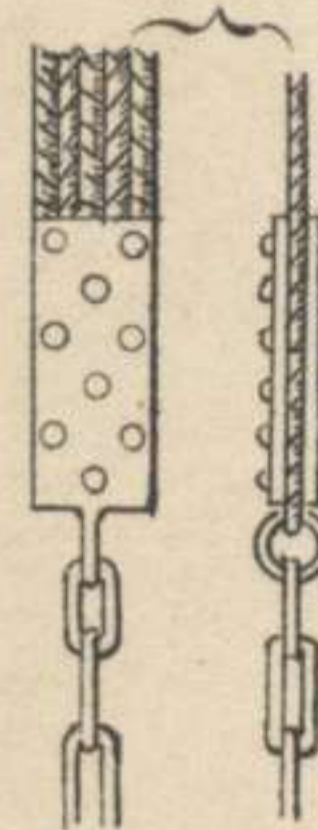

Fig. 267.

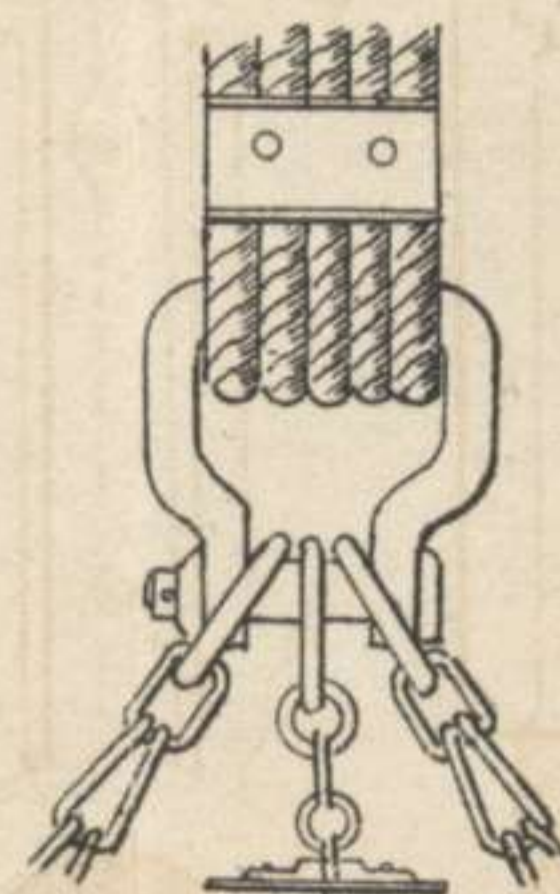

Fig. 268.

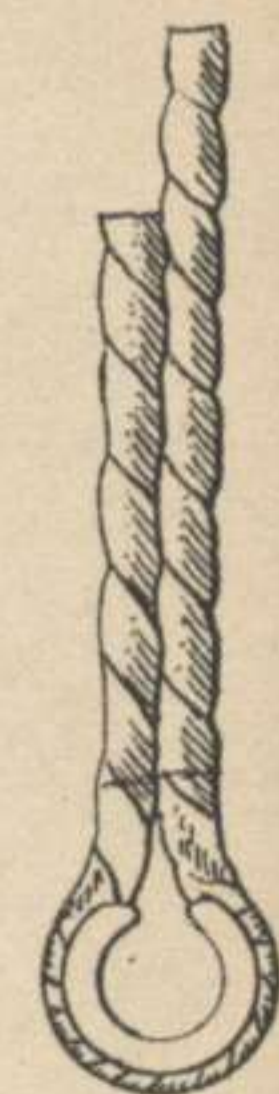
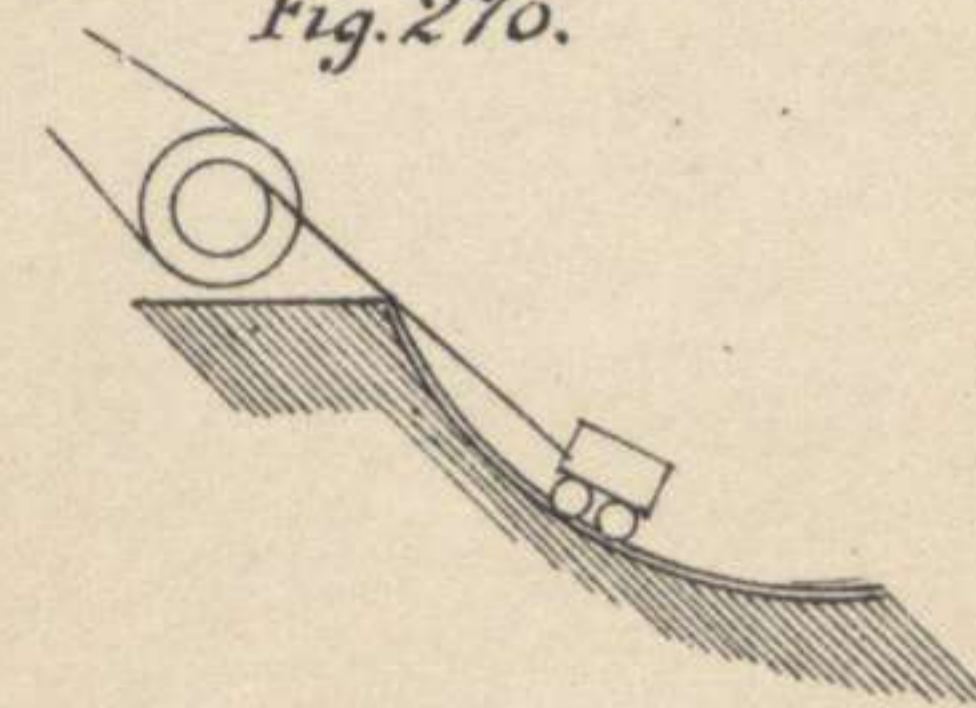

Fig. 270.



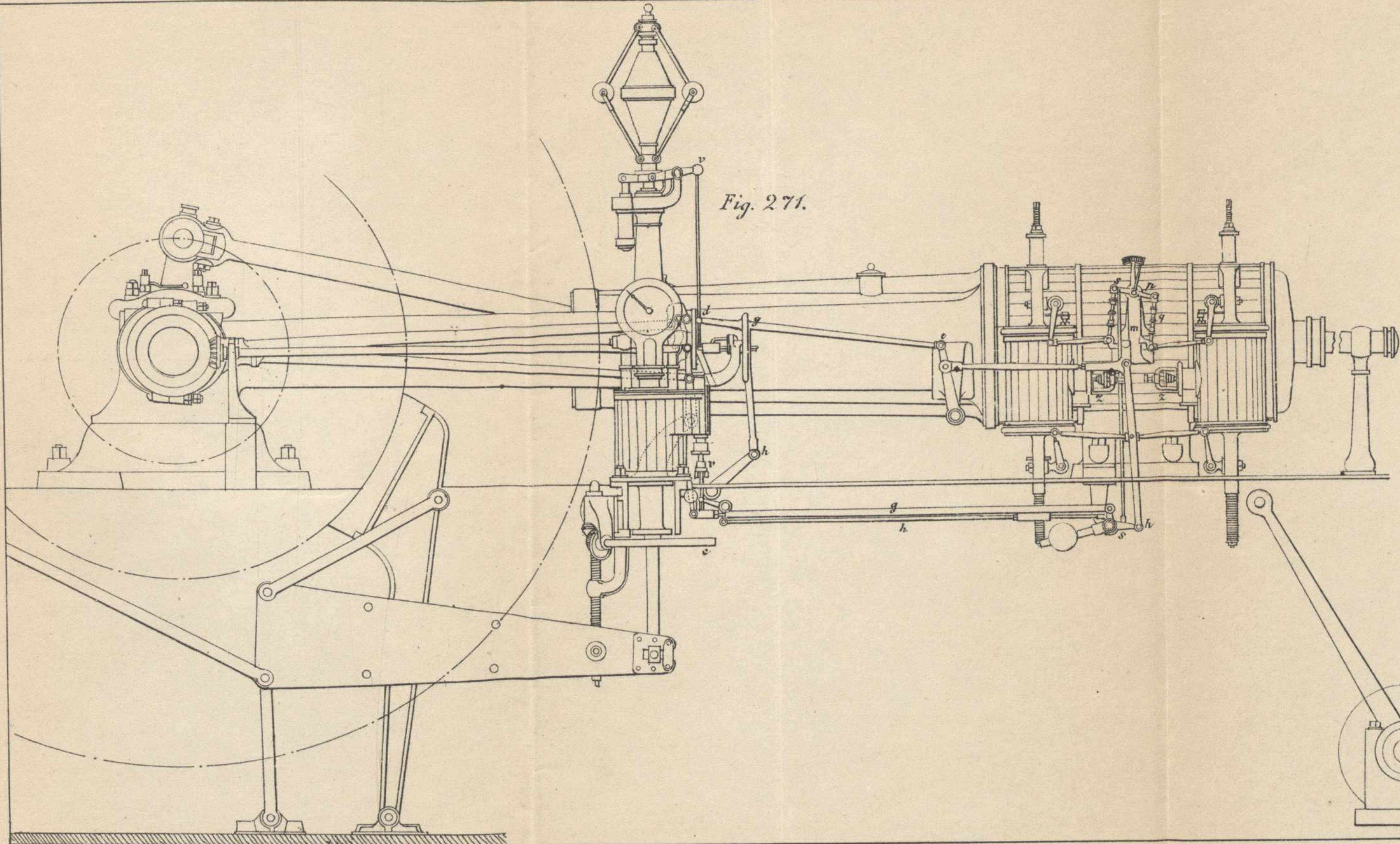

Fig. 271.

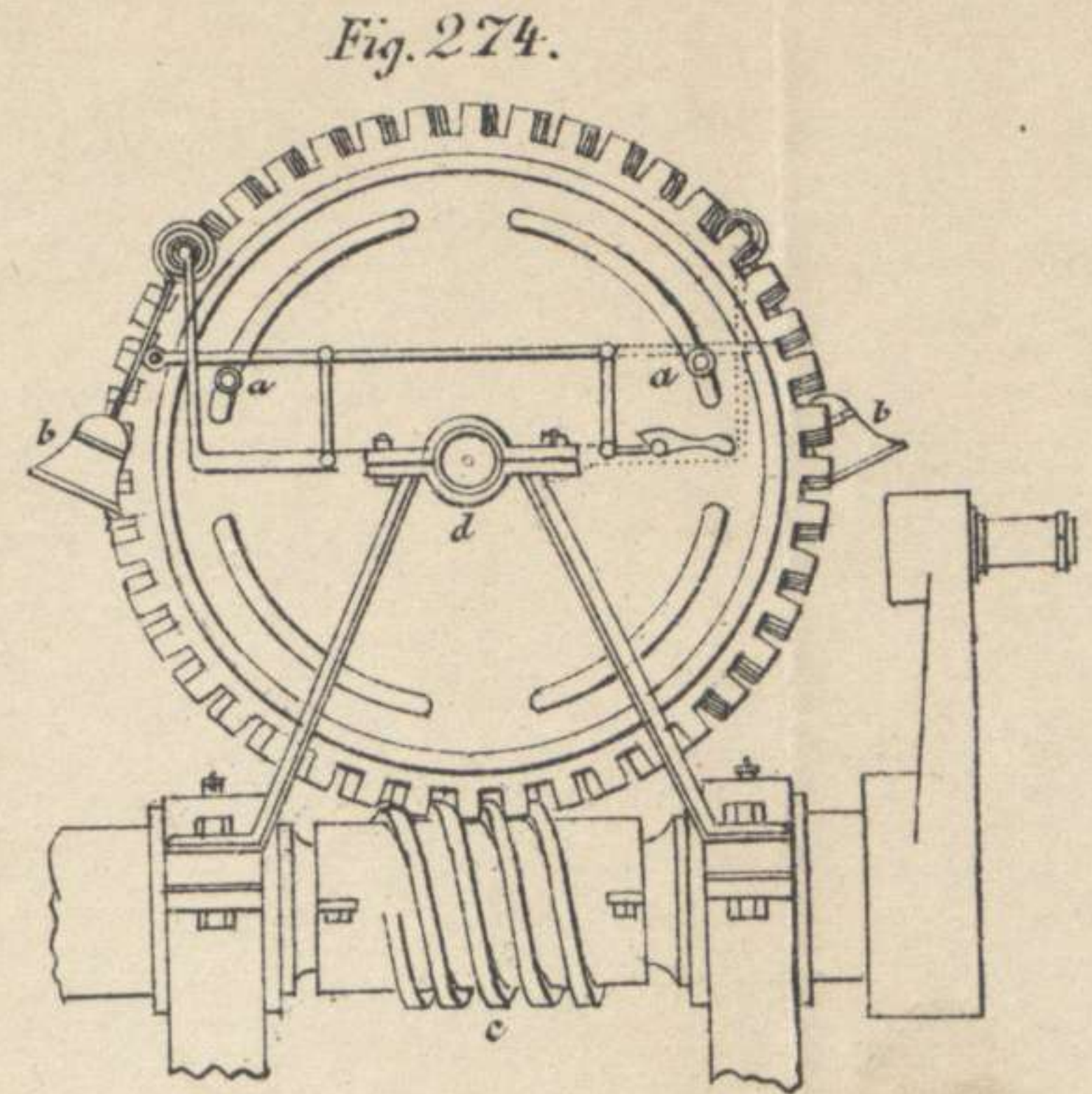

Fig. 274.

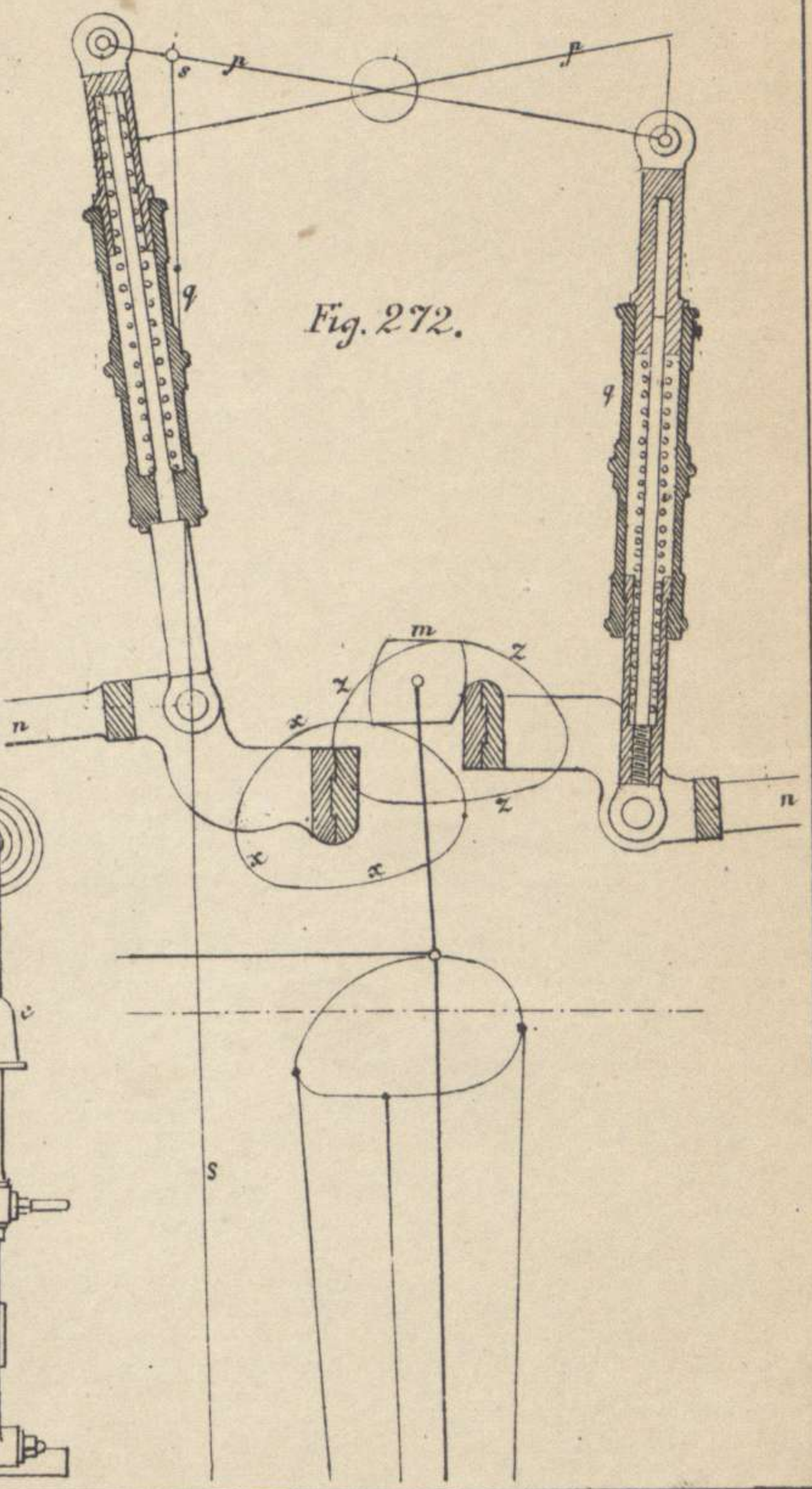

Fig. 272.

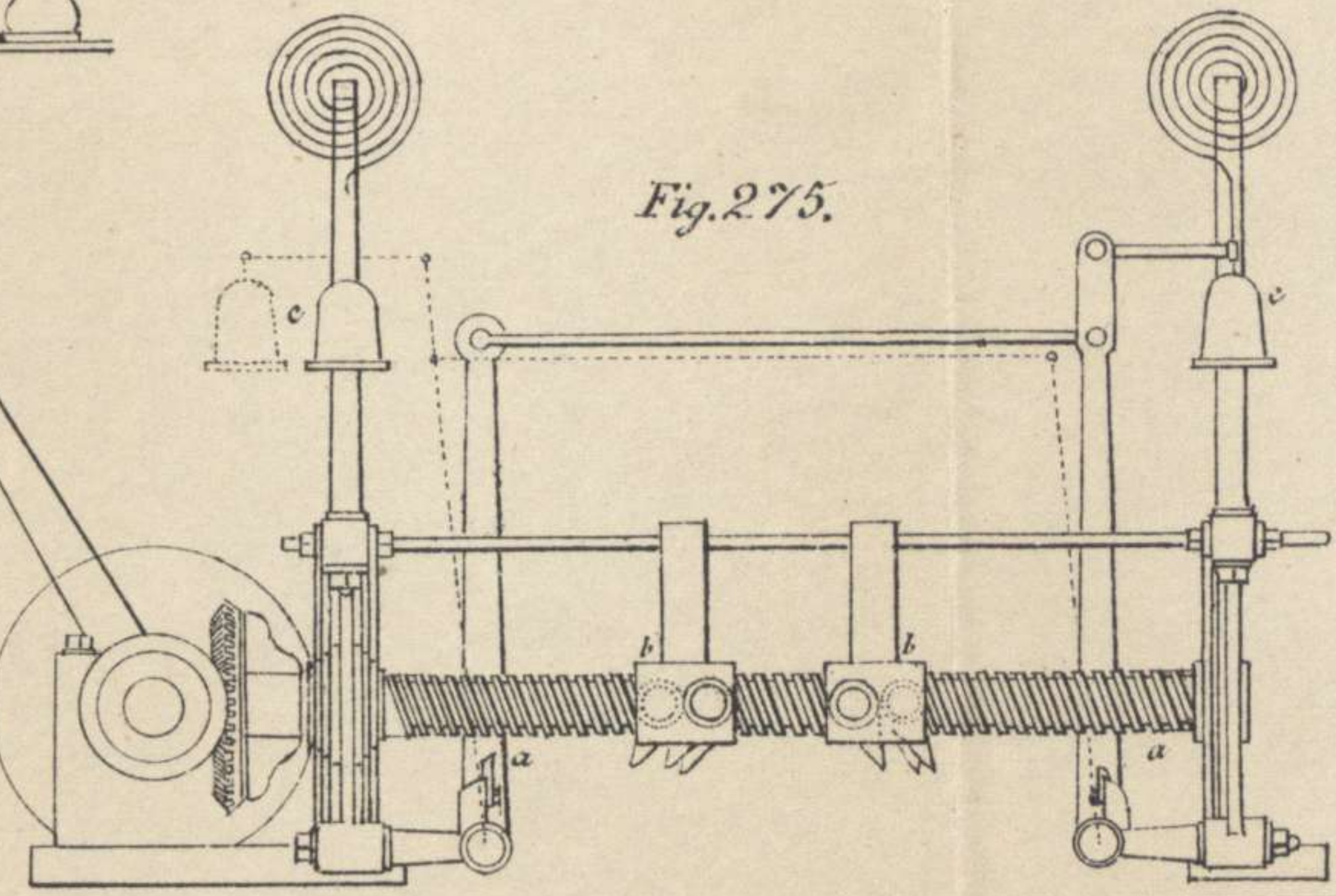

Fig. 275.

Fig. 273.

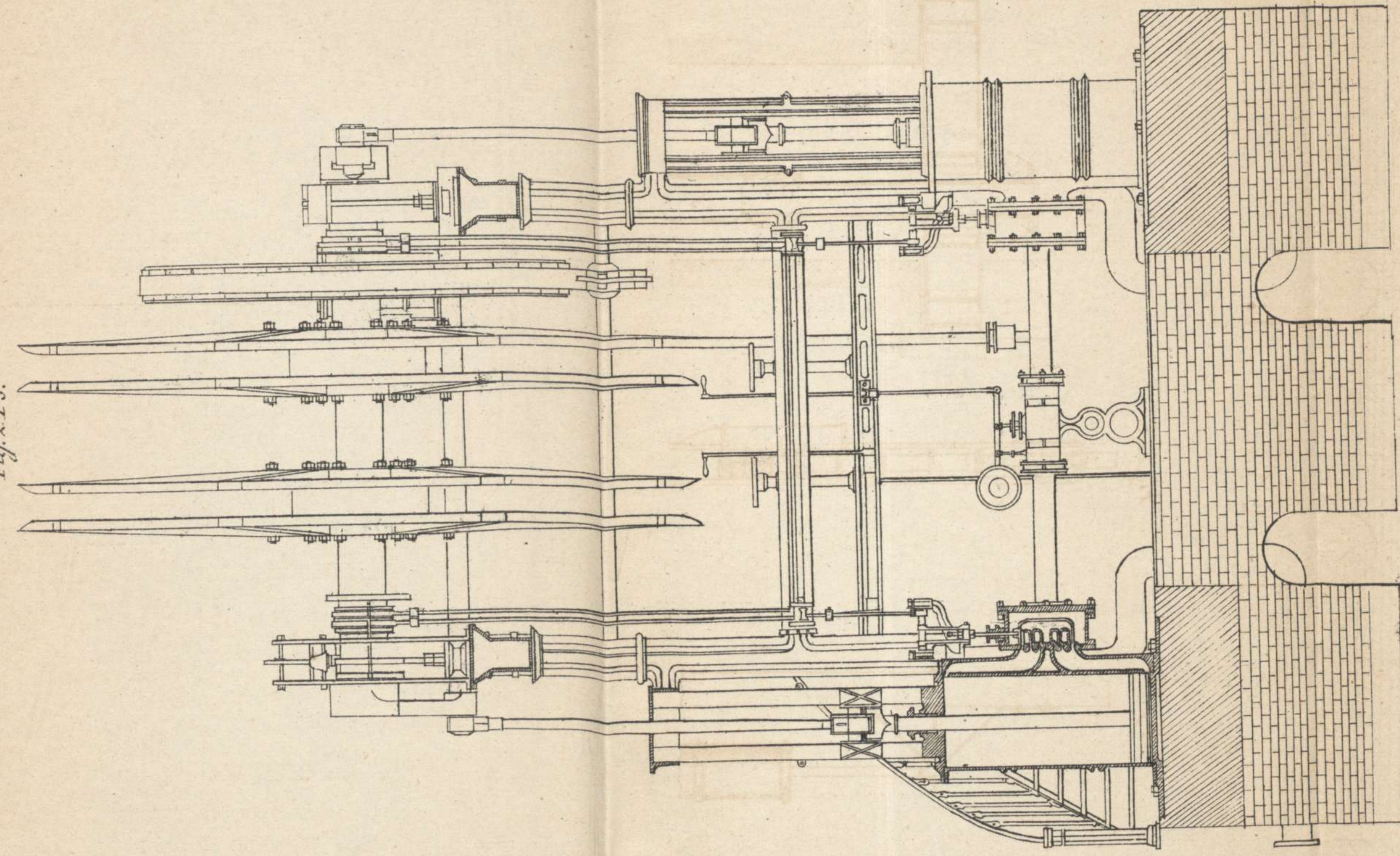

Fig. 280.

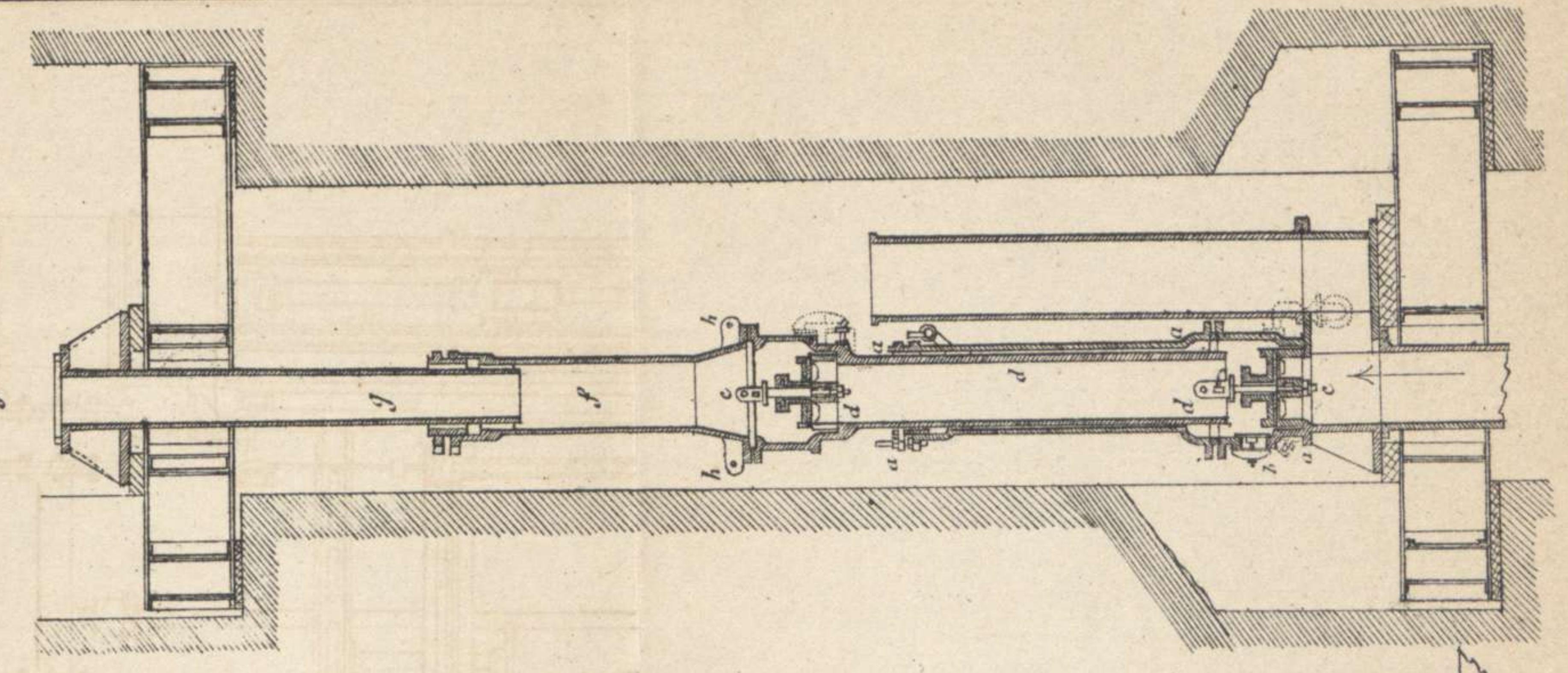

Fig. 278.

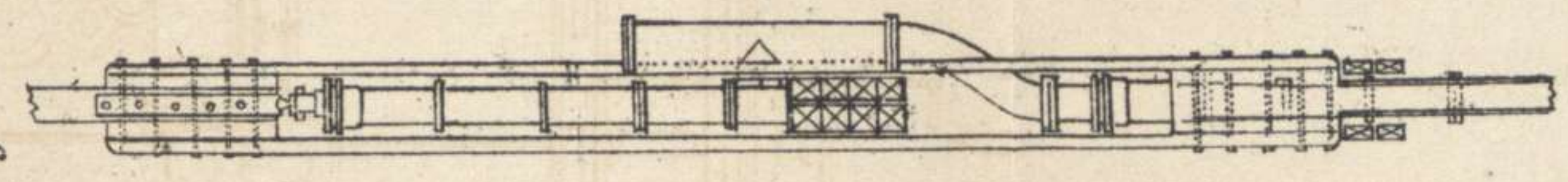

Fig. 279.

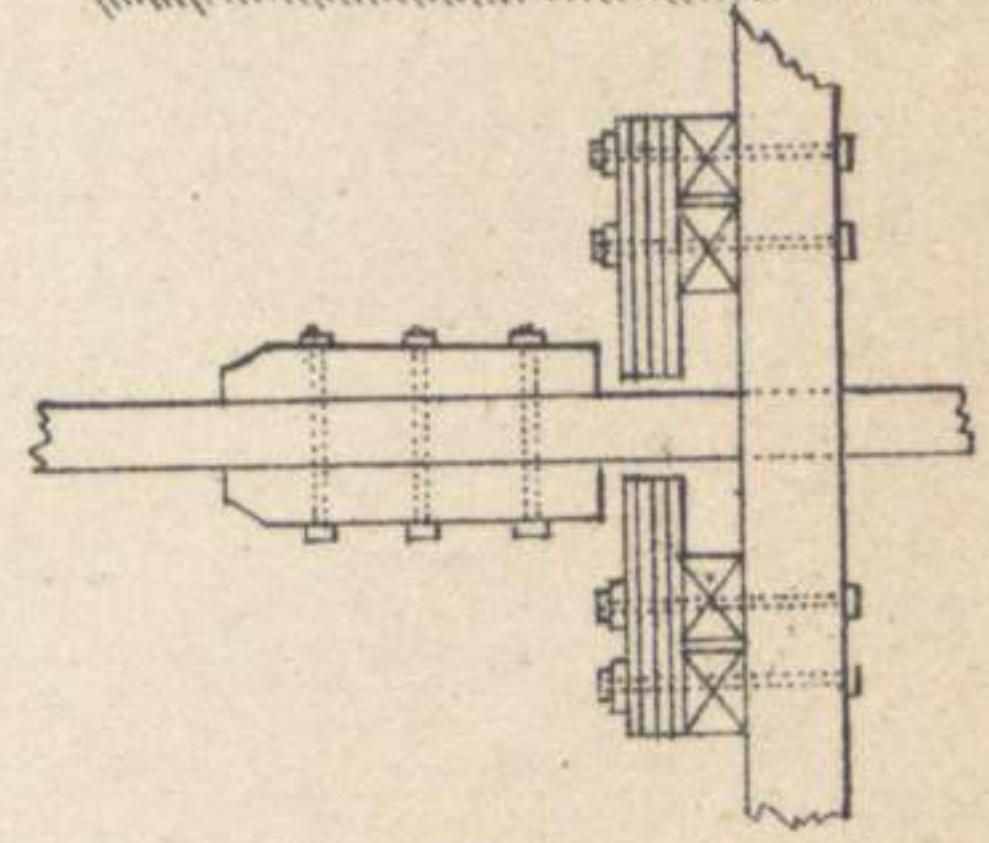

Fig. 276.

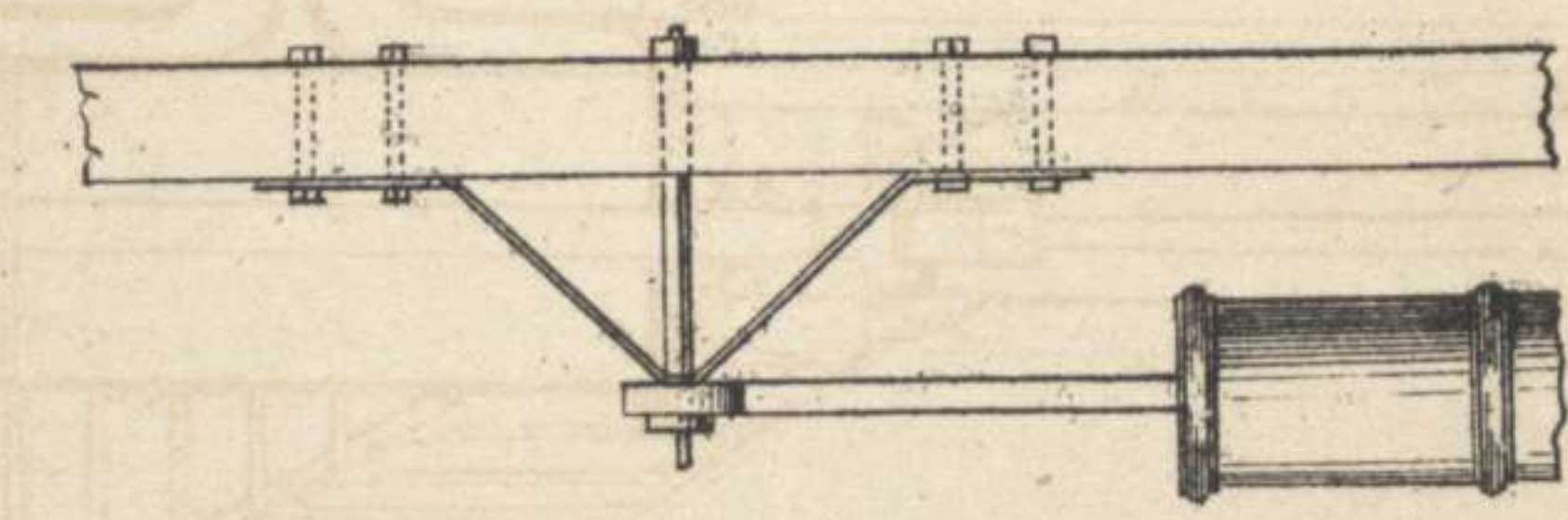

Fig. 277.

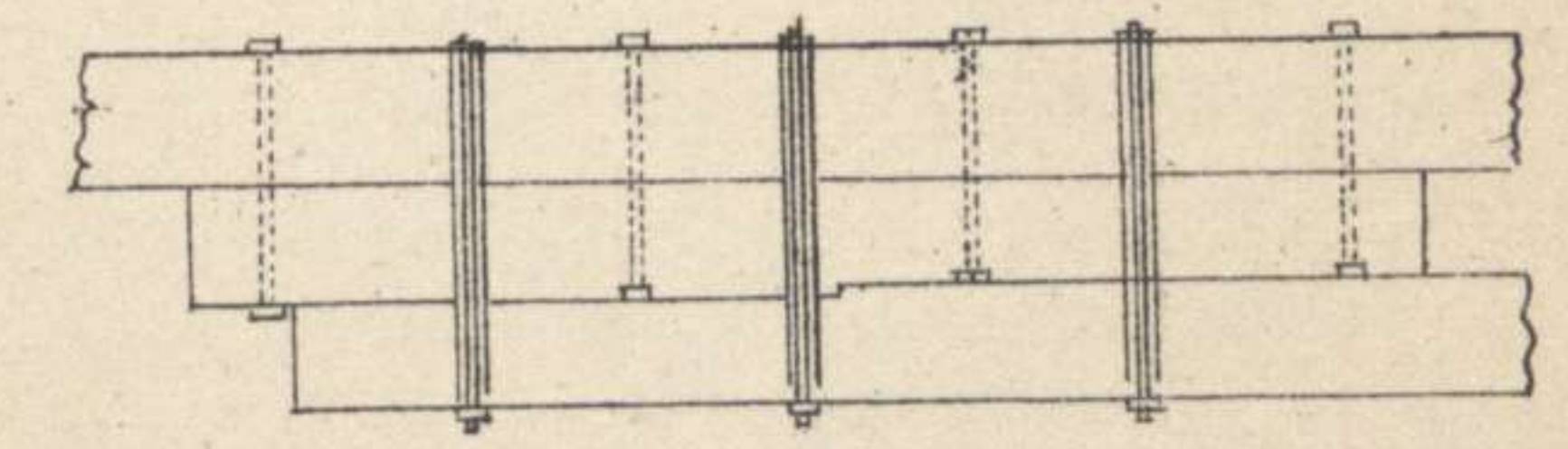

Fig. 282.

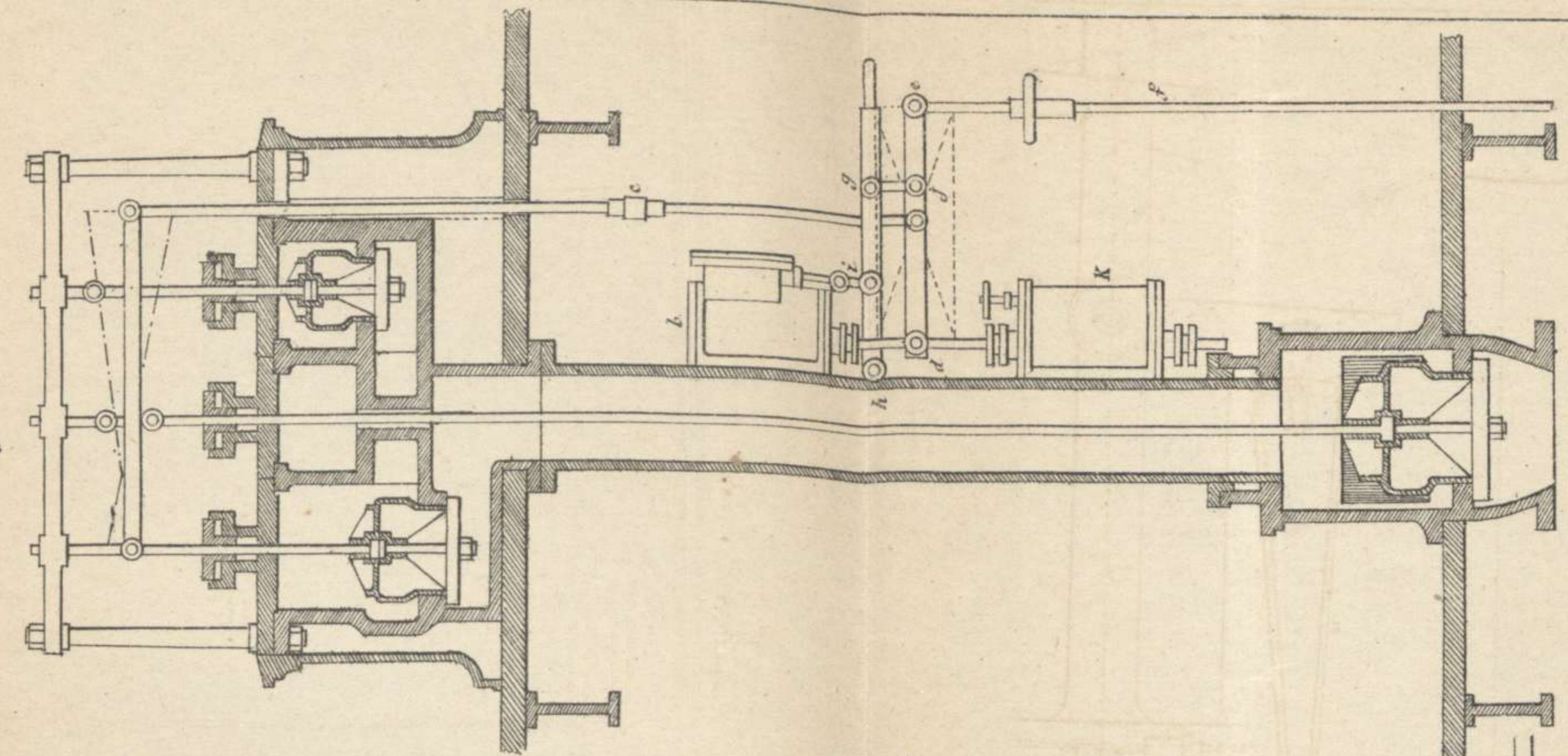
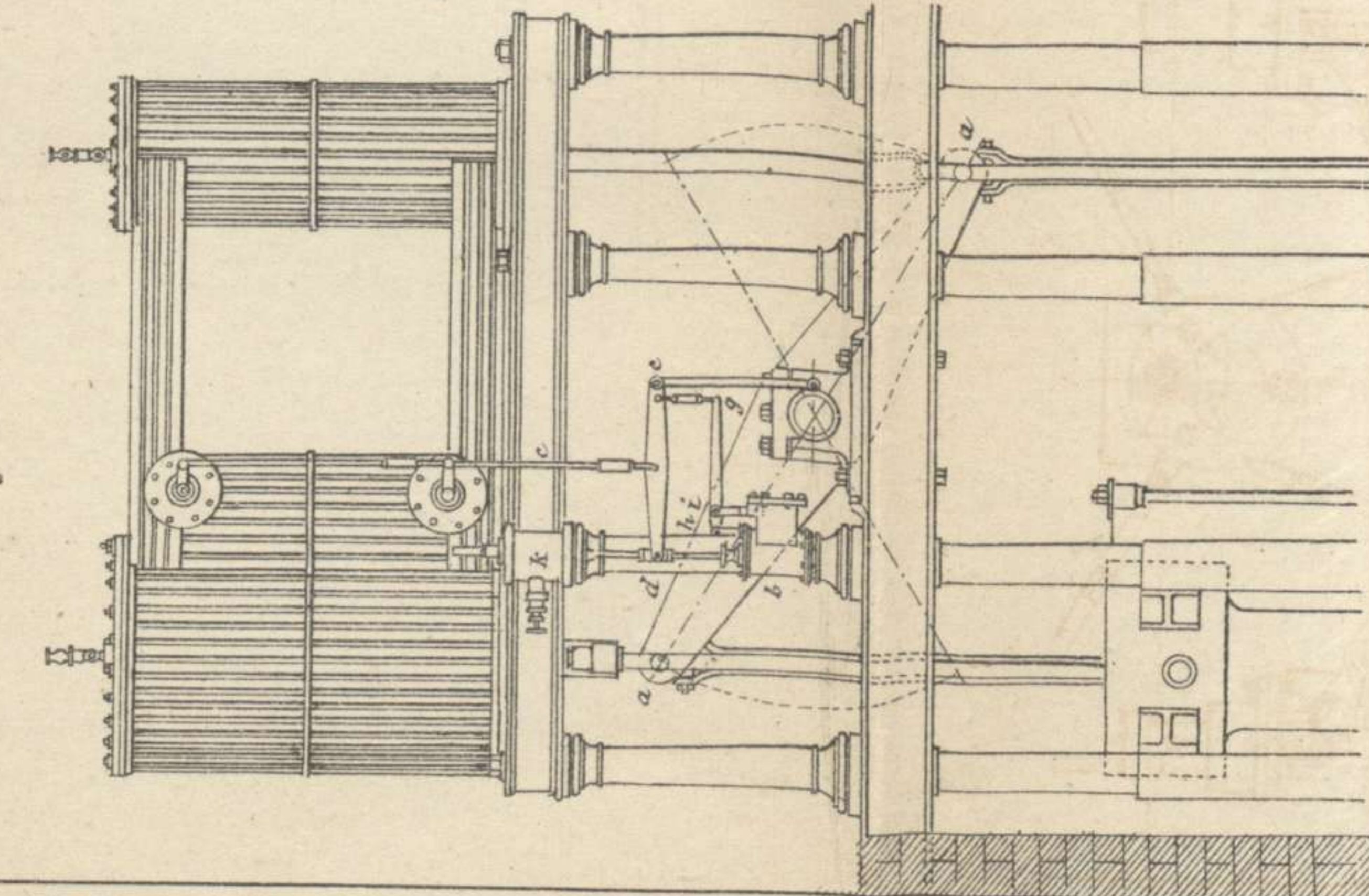

Fig. 281.



Lit. de M. Ventura.

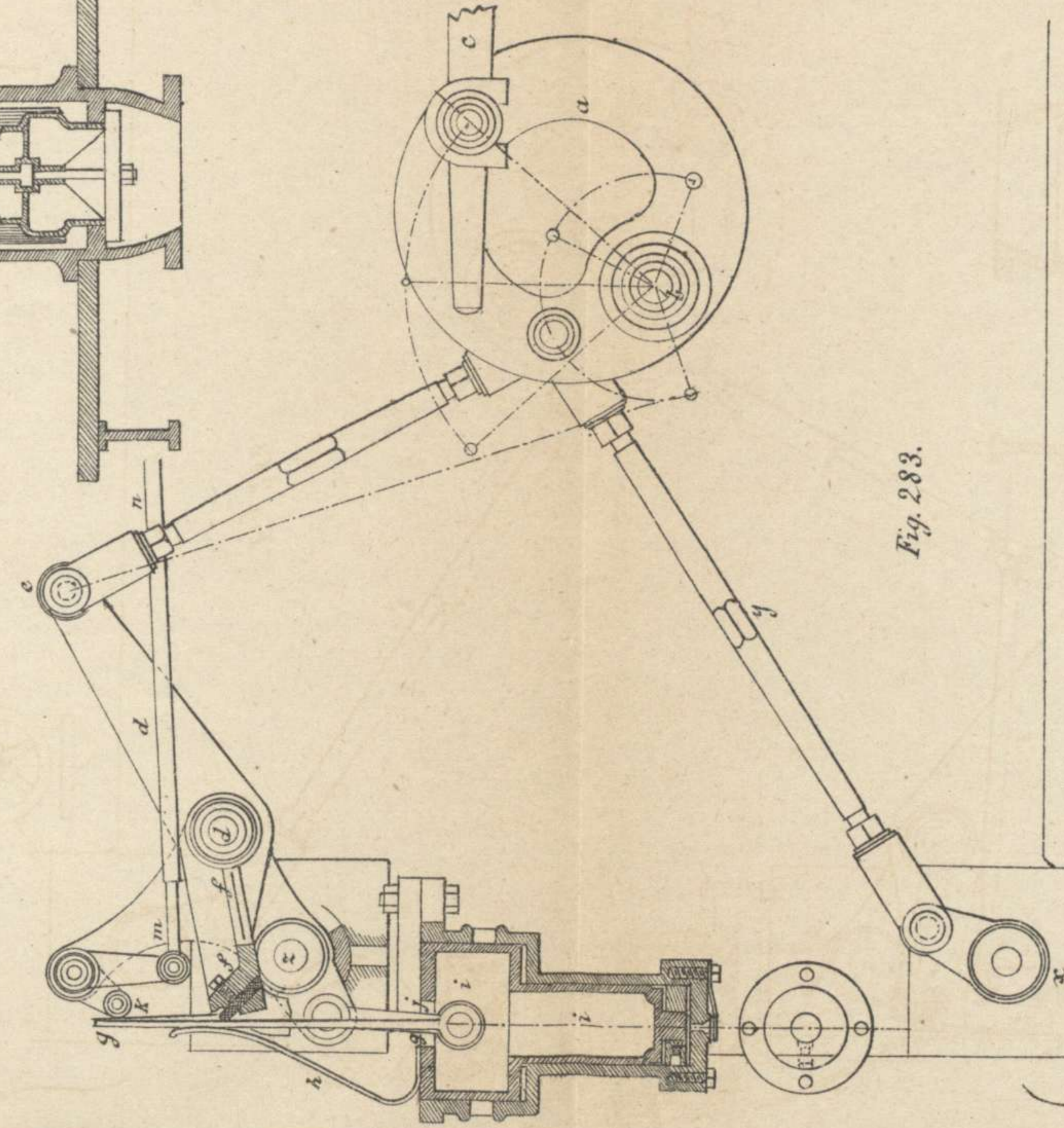

Fig. 283.

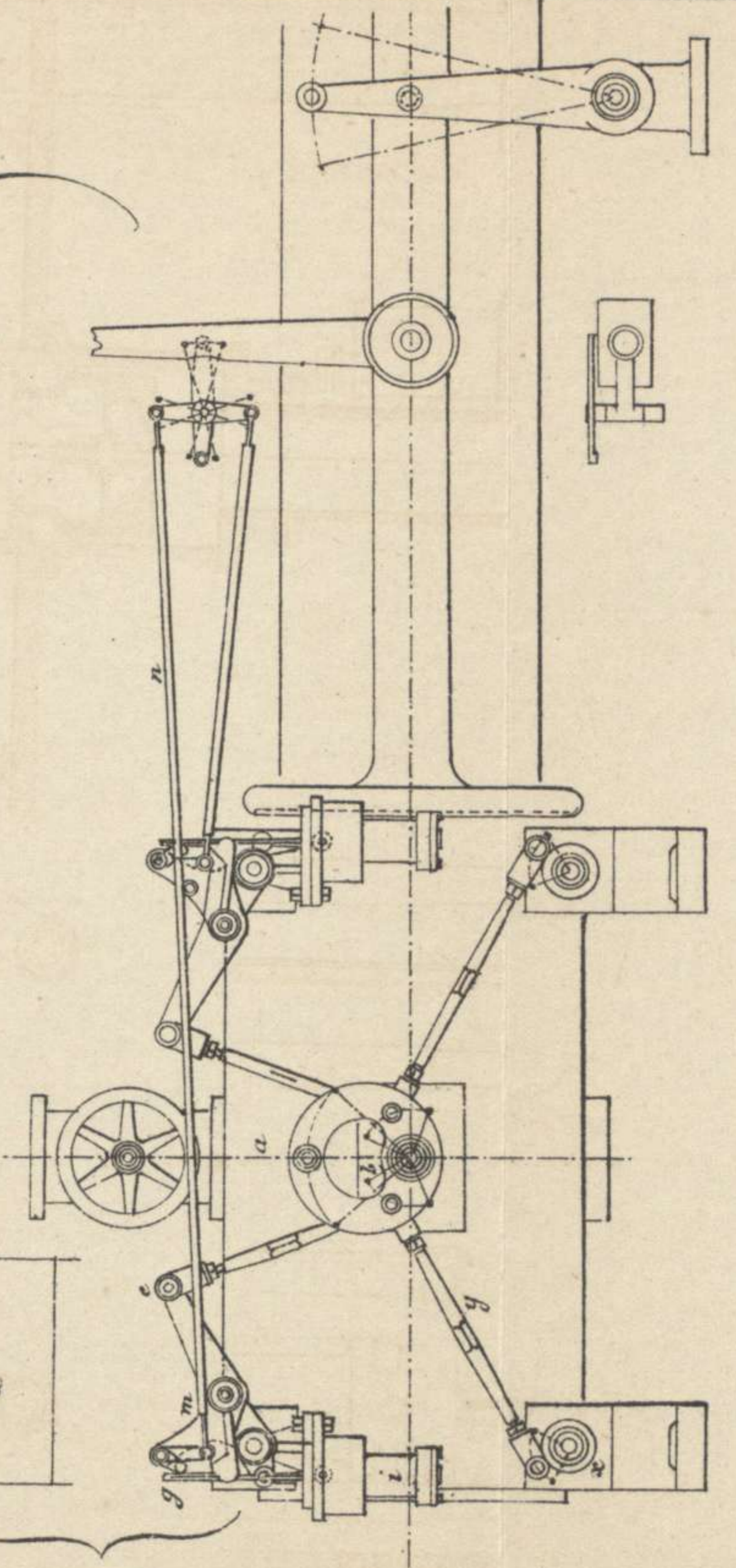
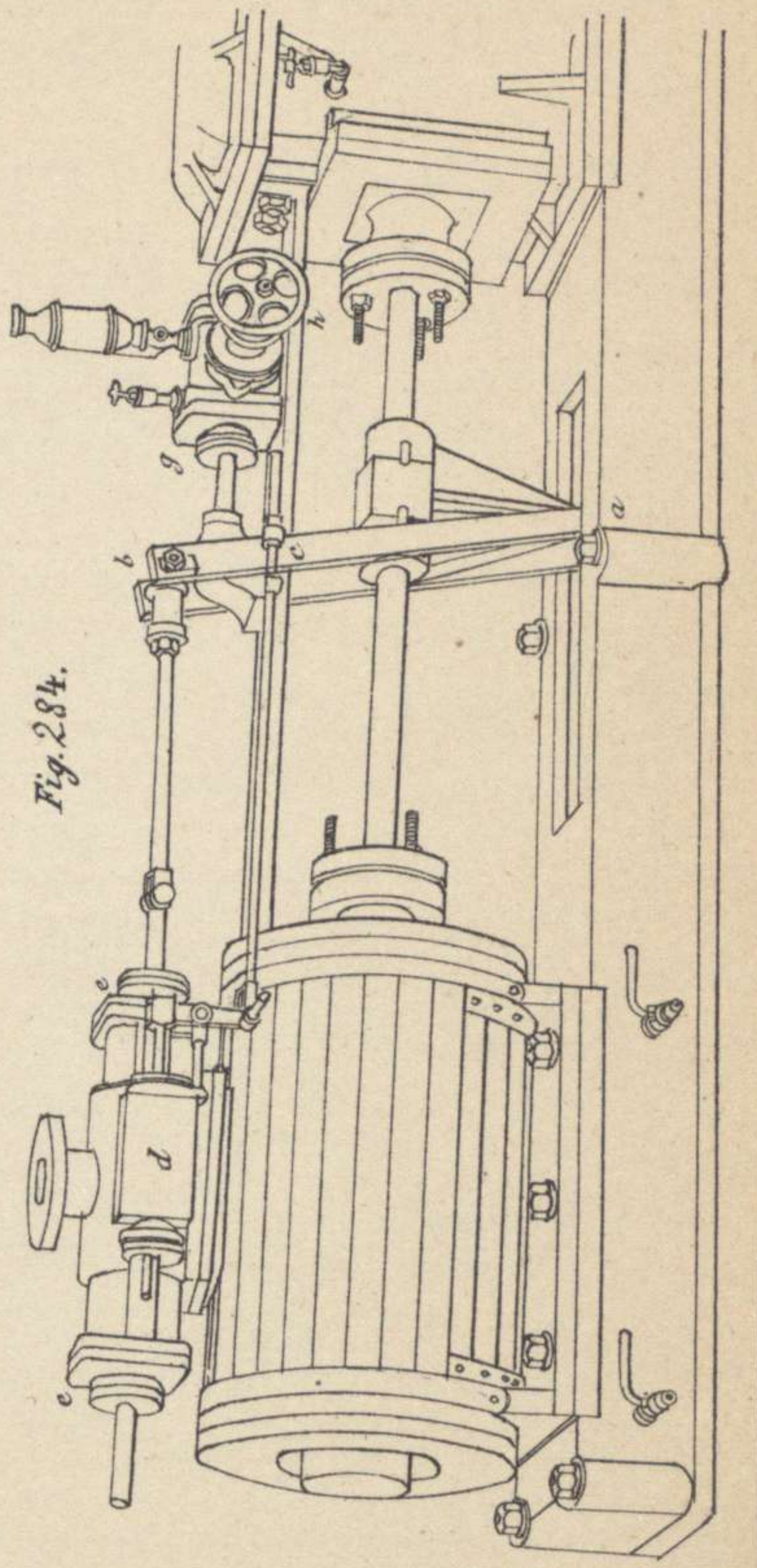

Fig. 284.



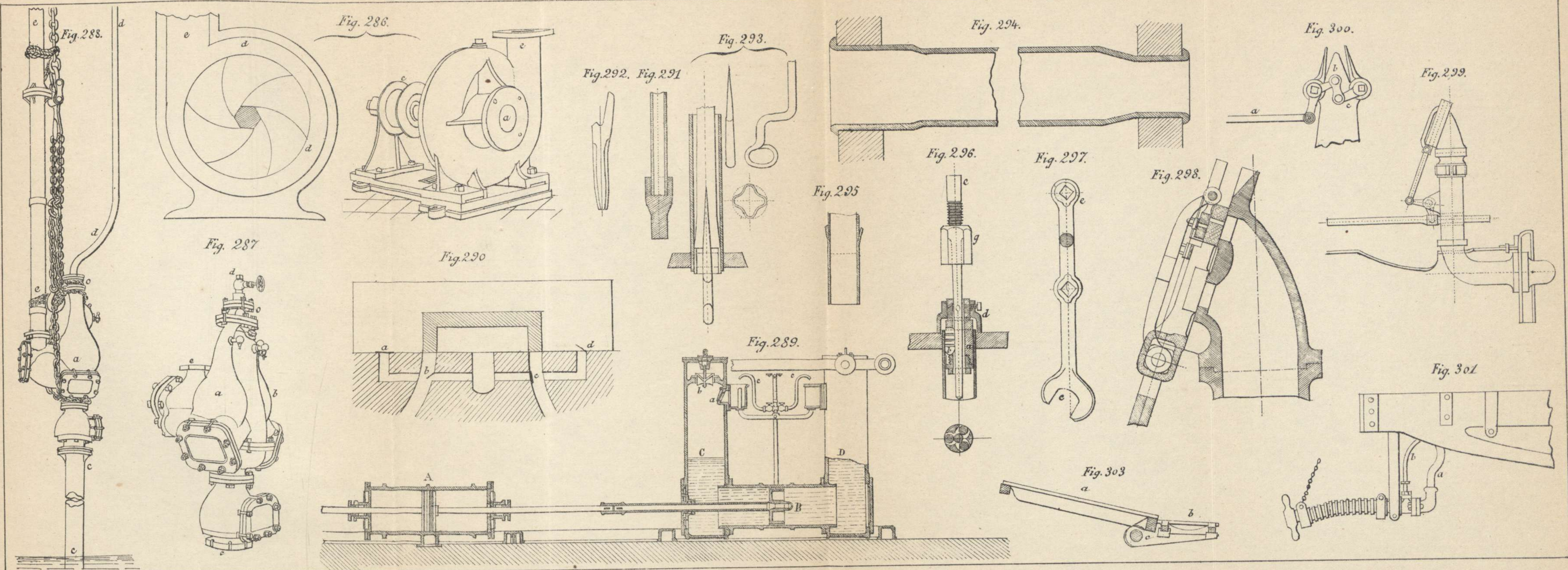

Fig. 302.

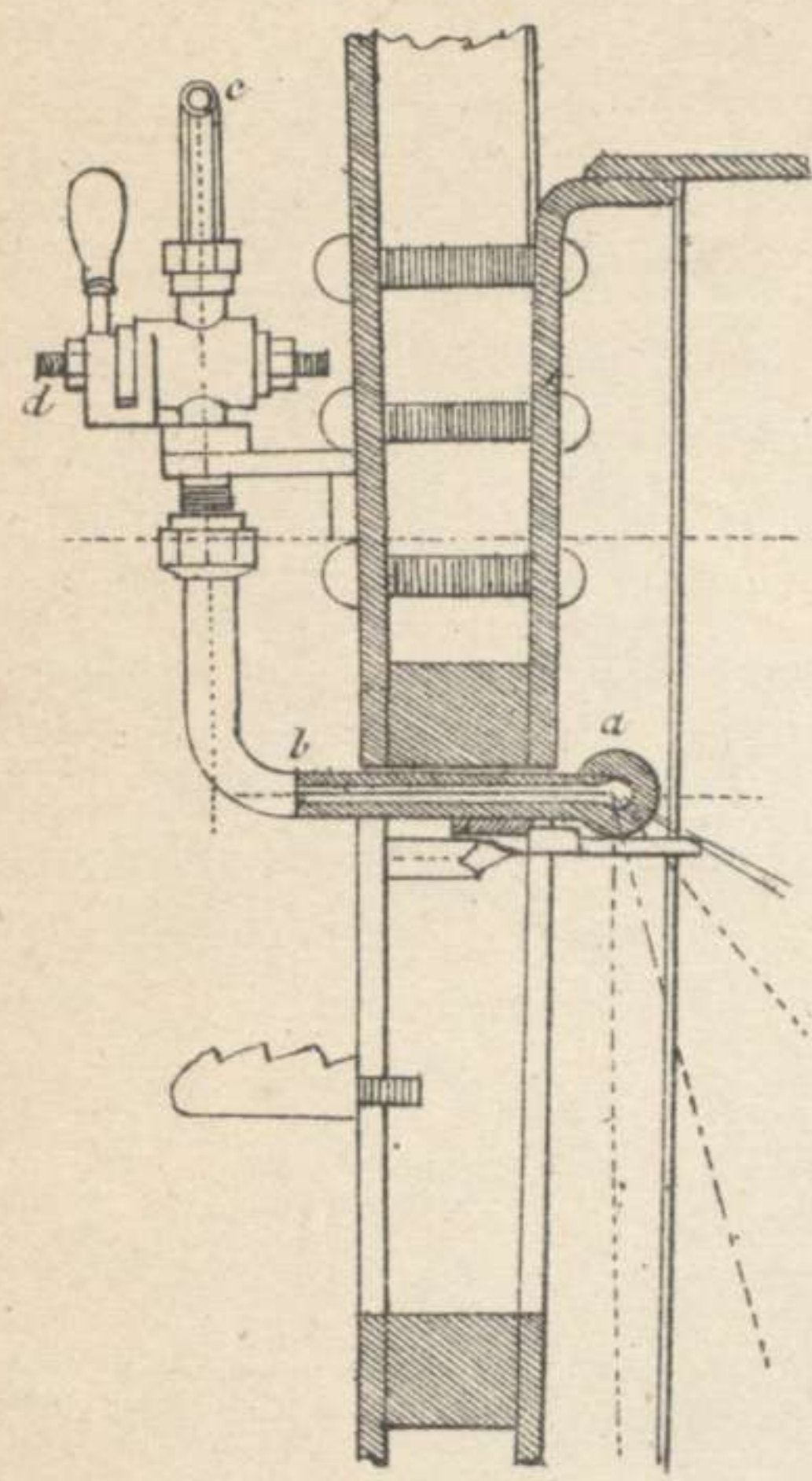

Fig. 305.

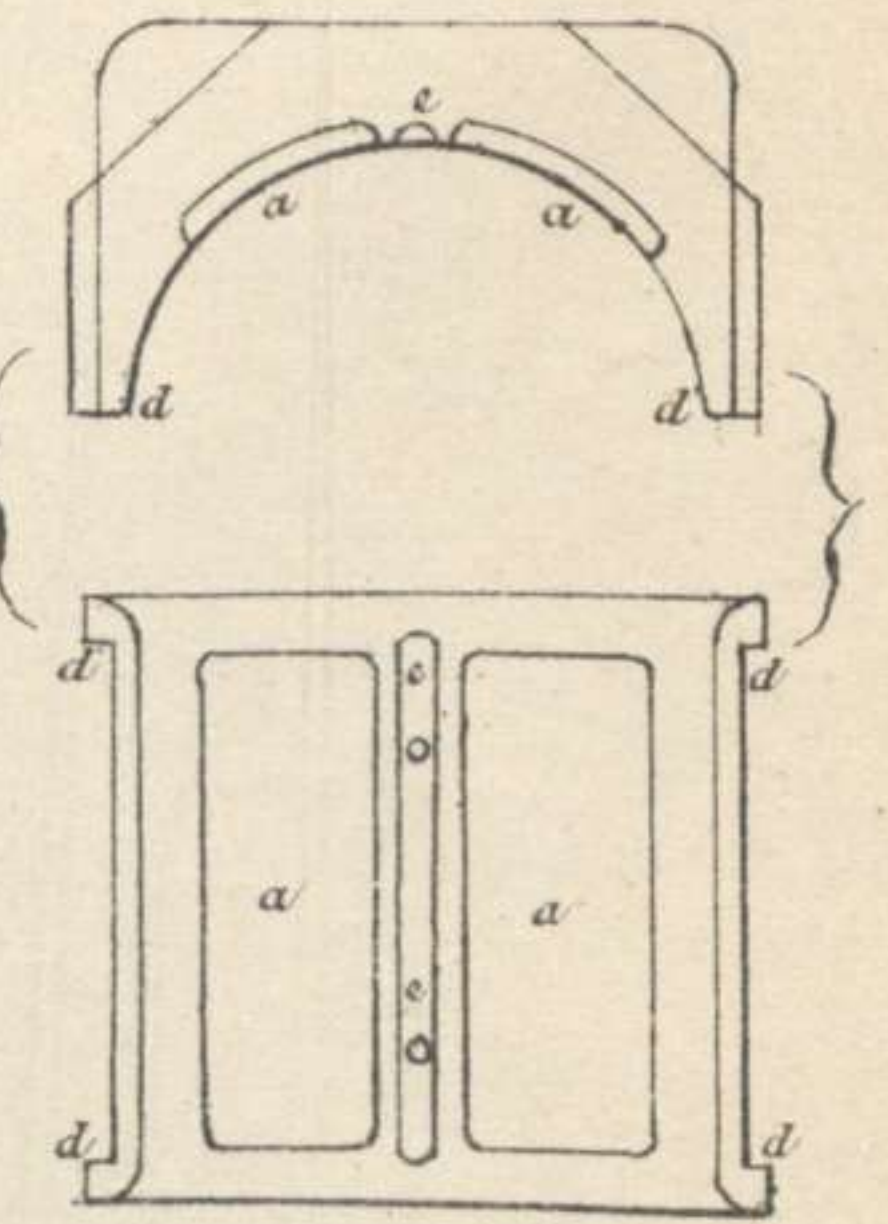

Fig. 304.

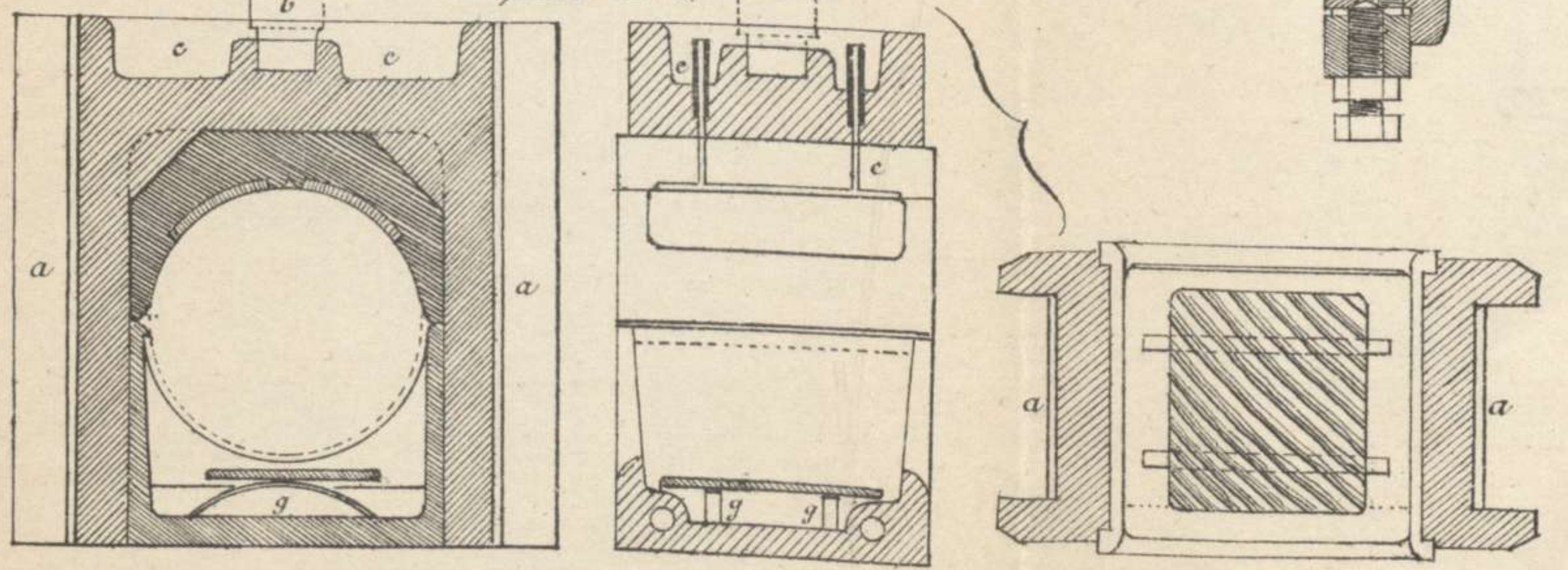

Fig. 306.

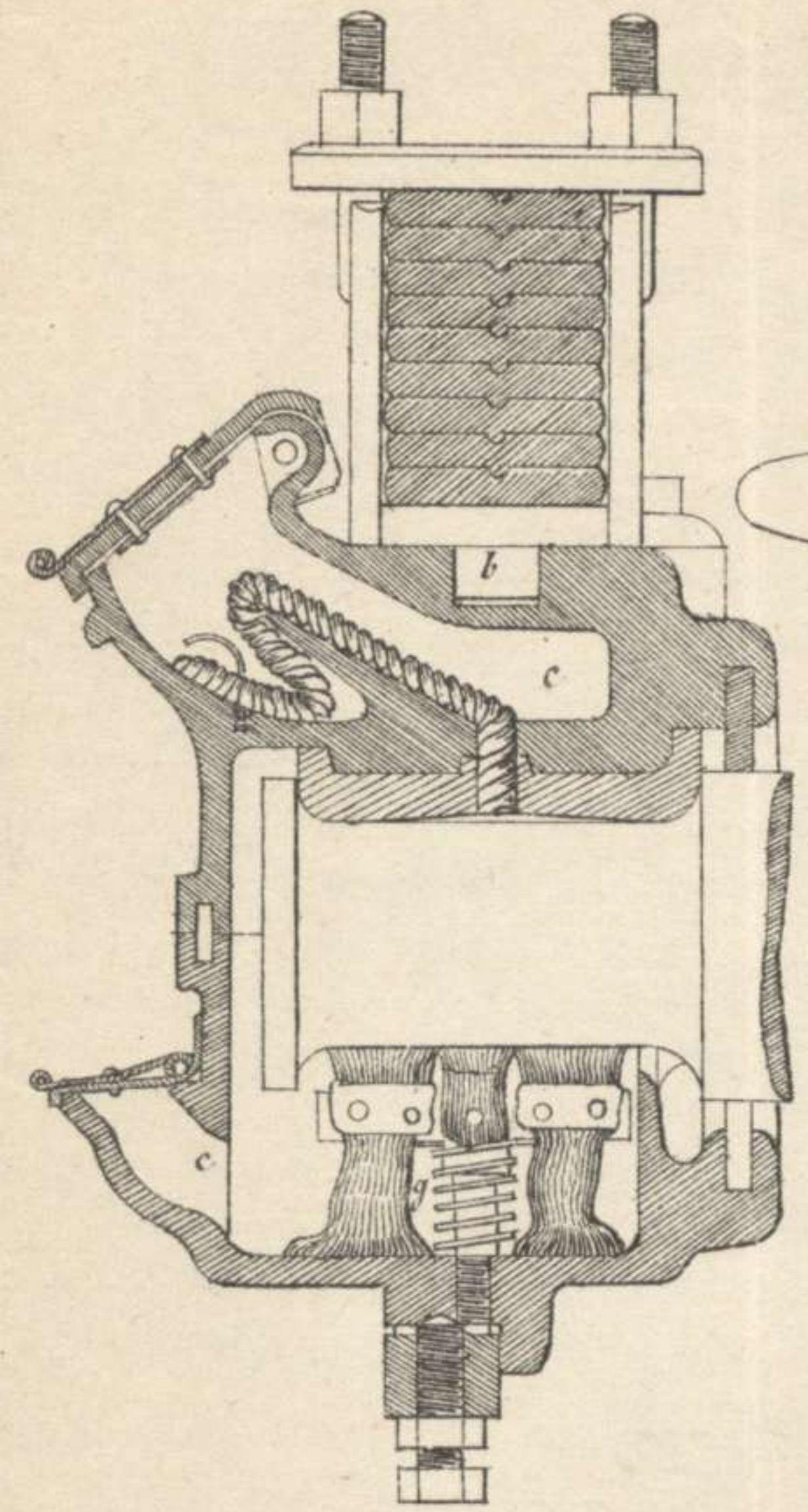

Fig. 307.

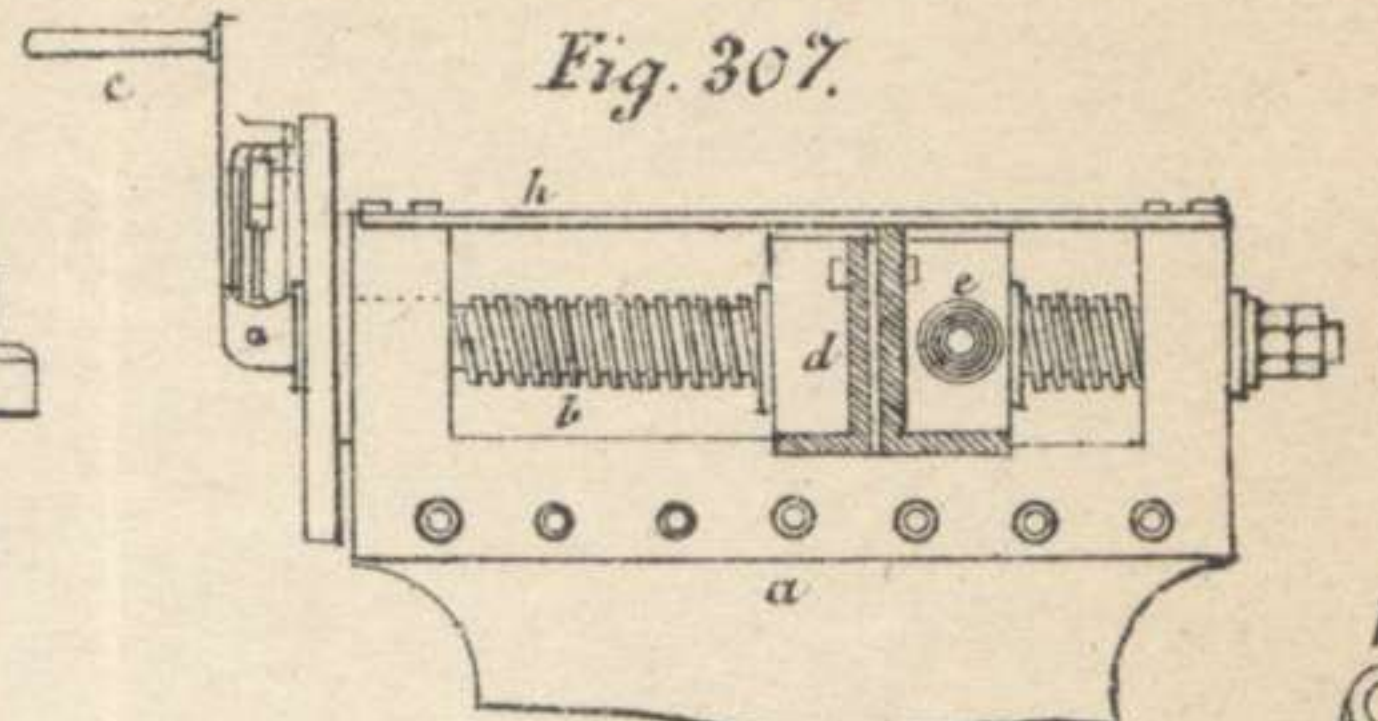

Fig. 308.

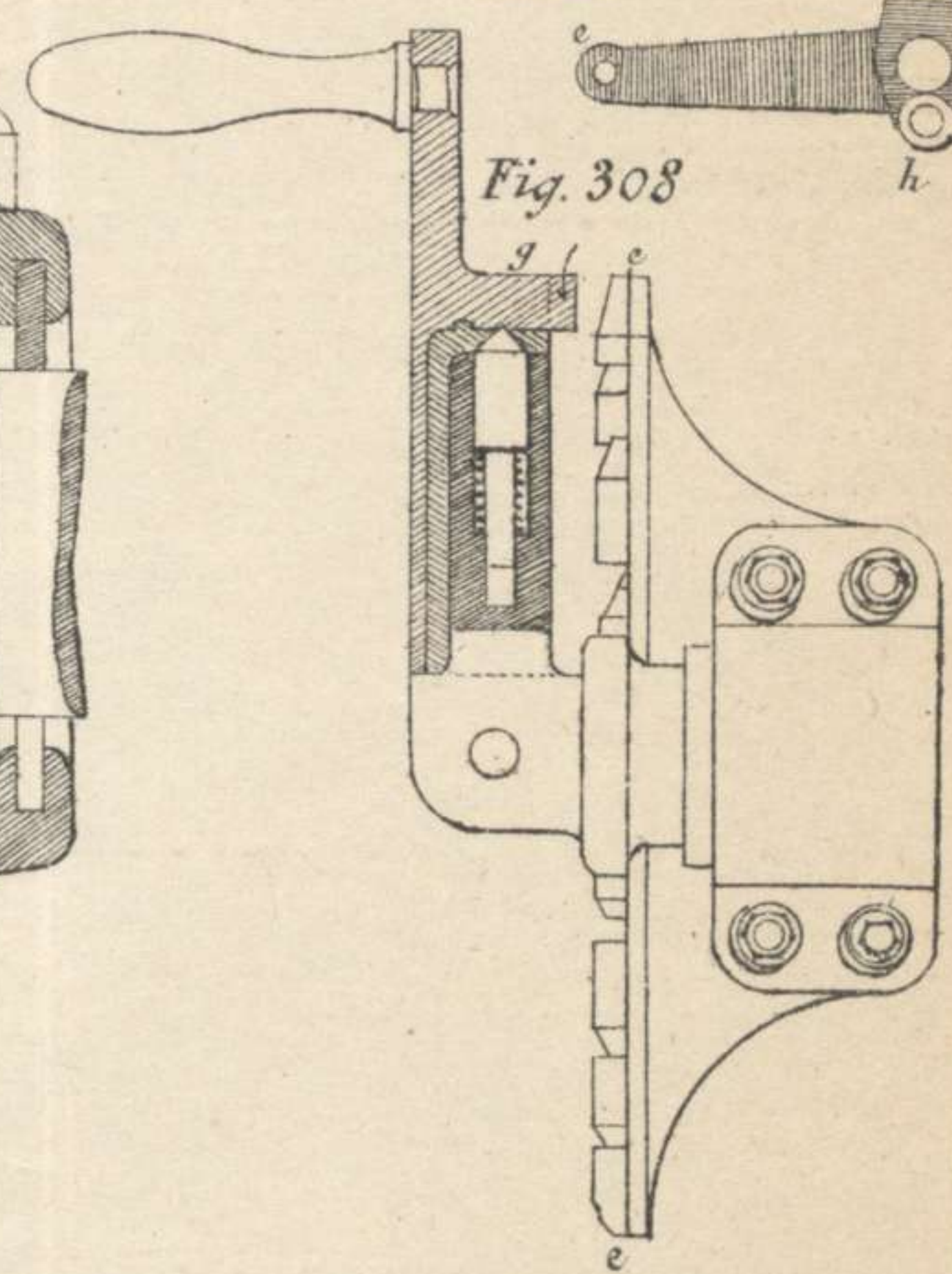

Fig. 311.



Fig. 310.

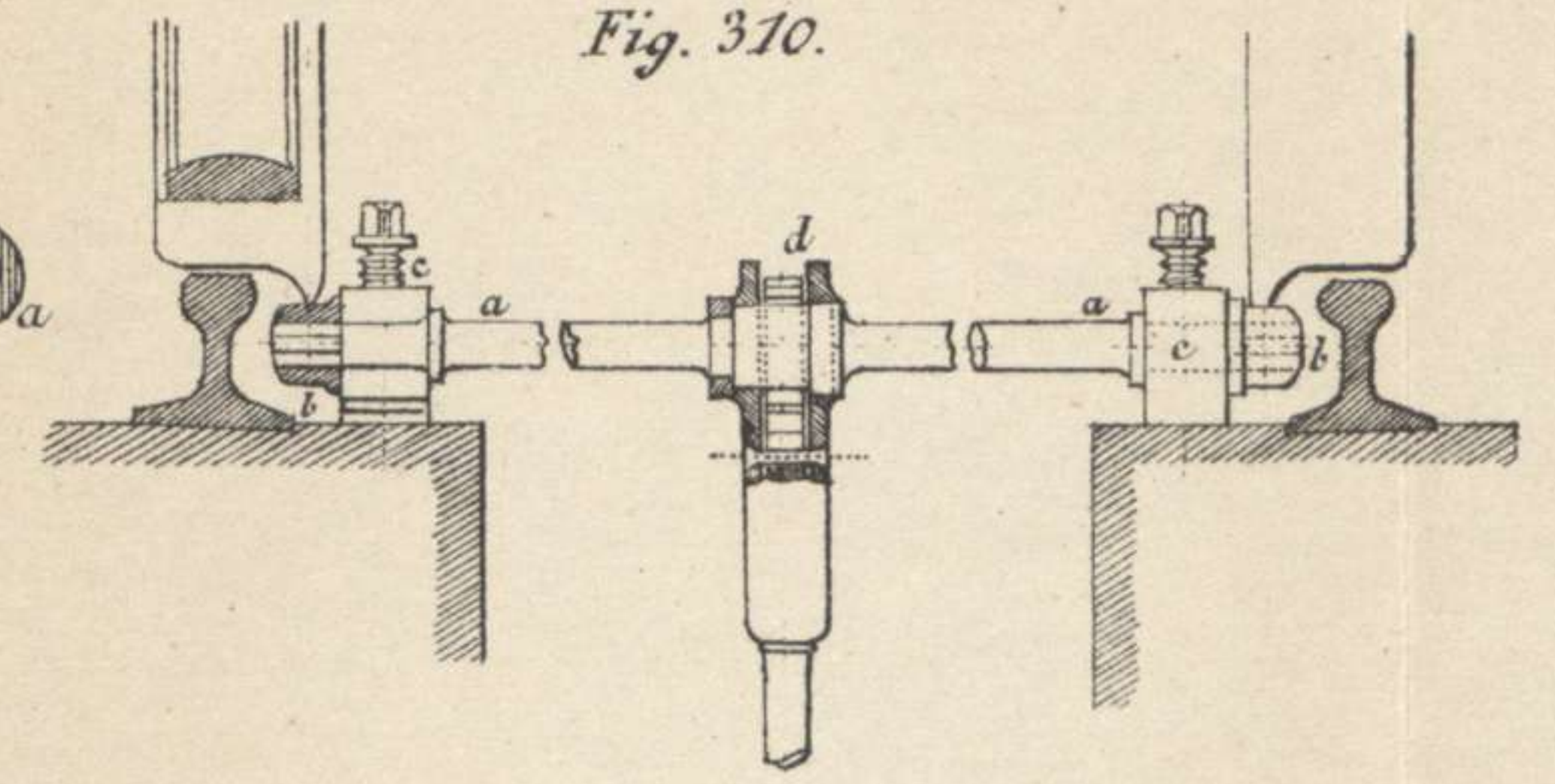

Fig. 309.

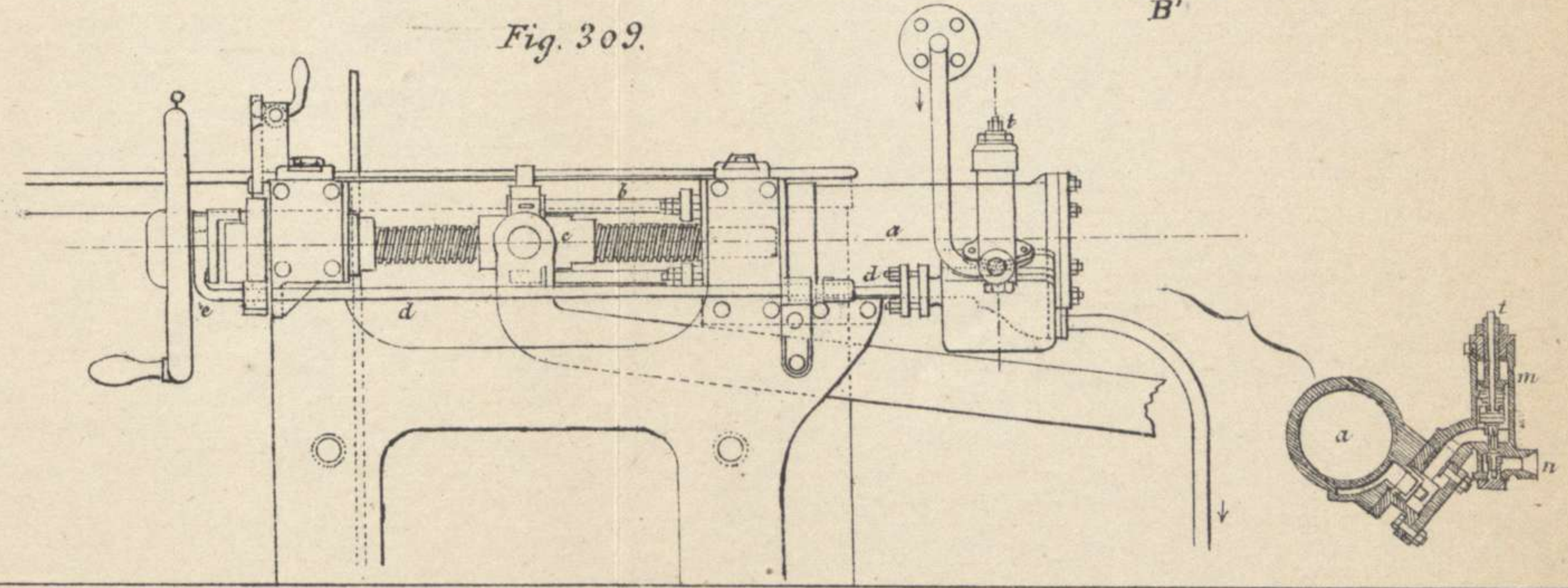
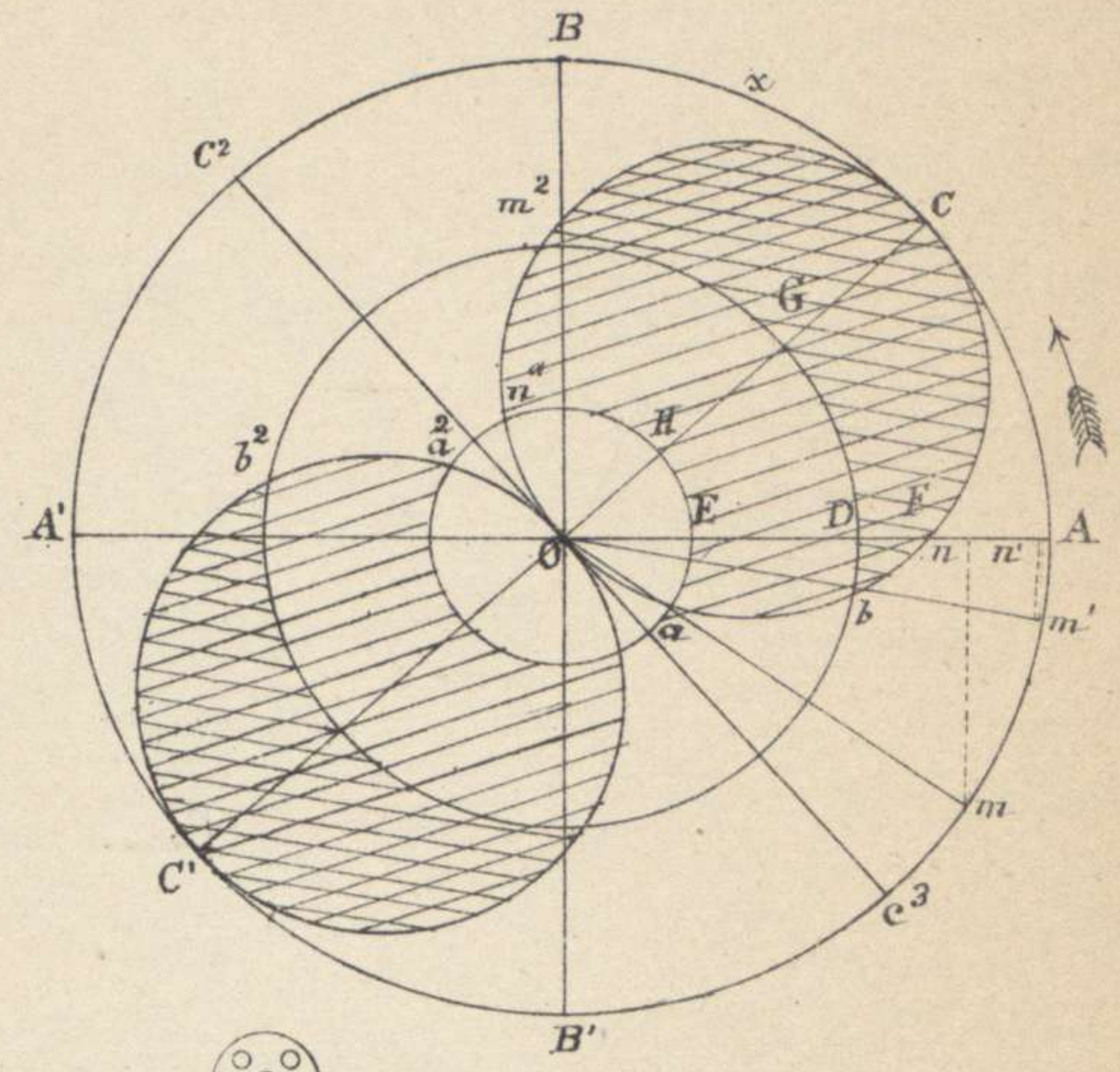
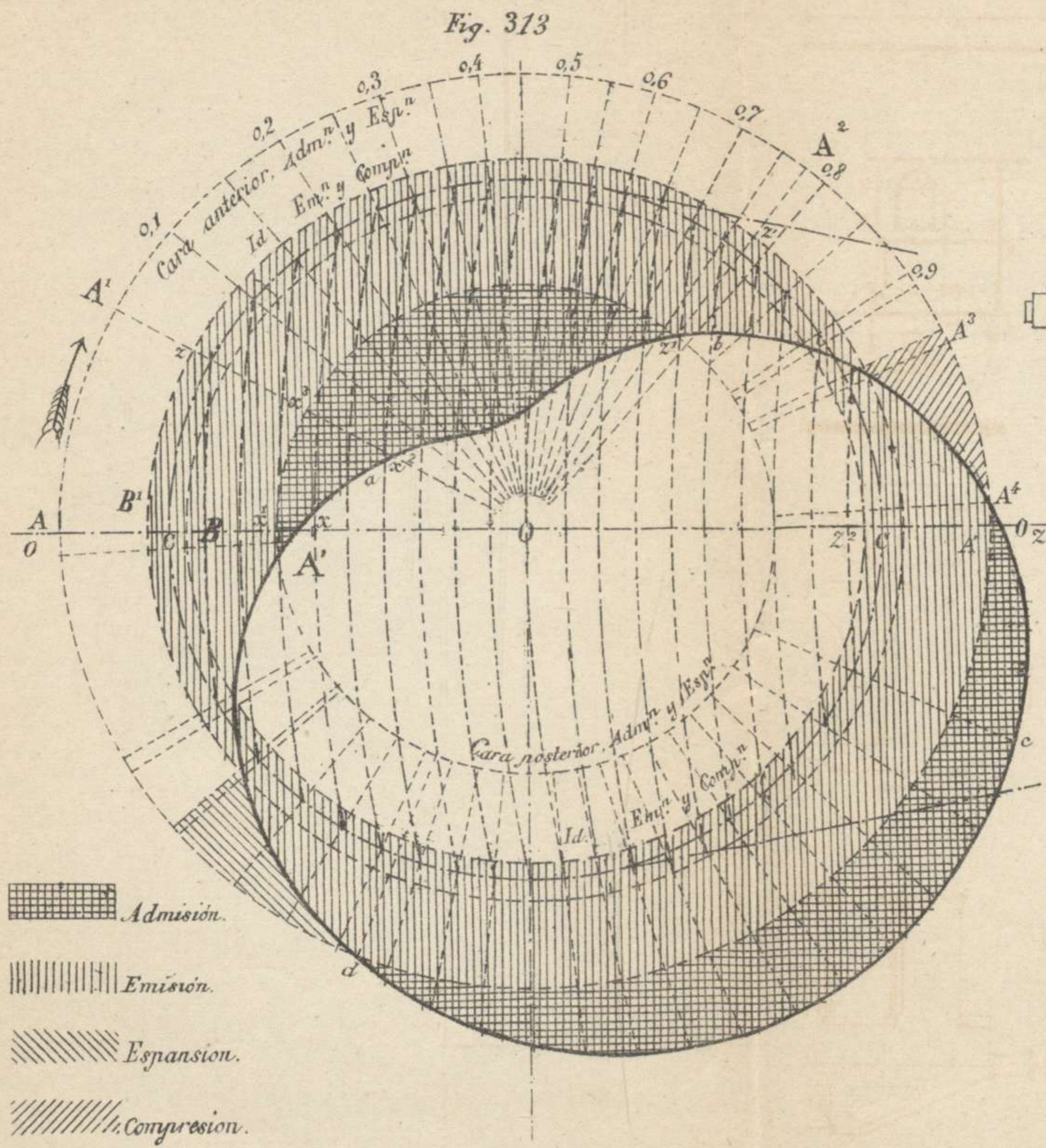
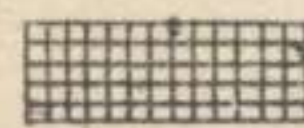
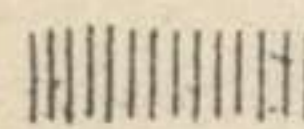

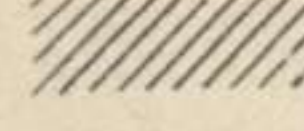
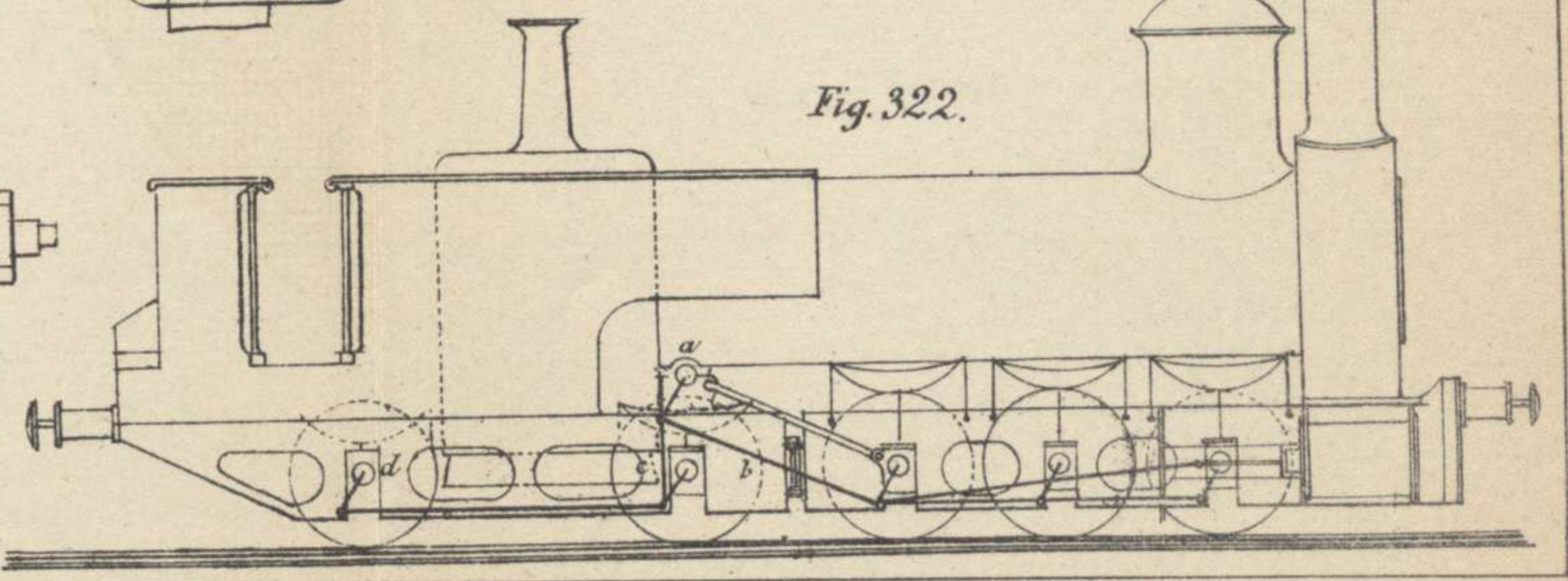
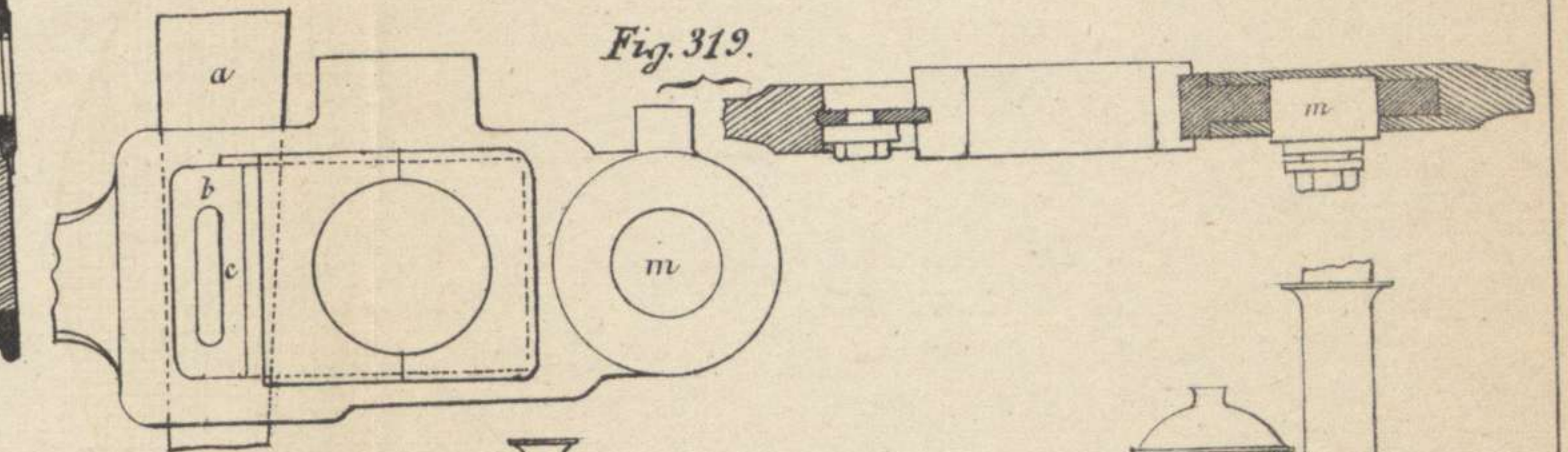
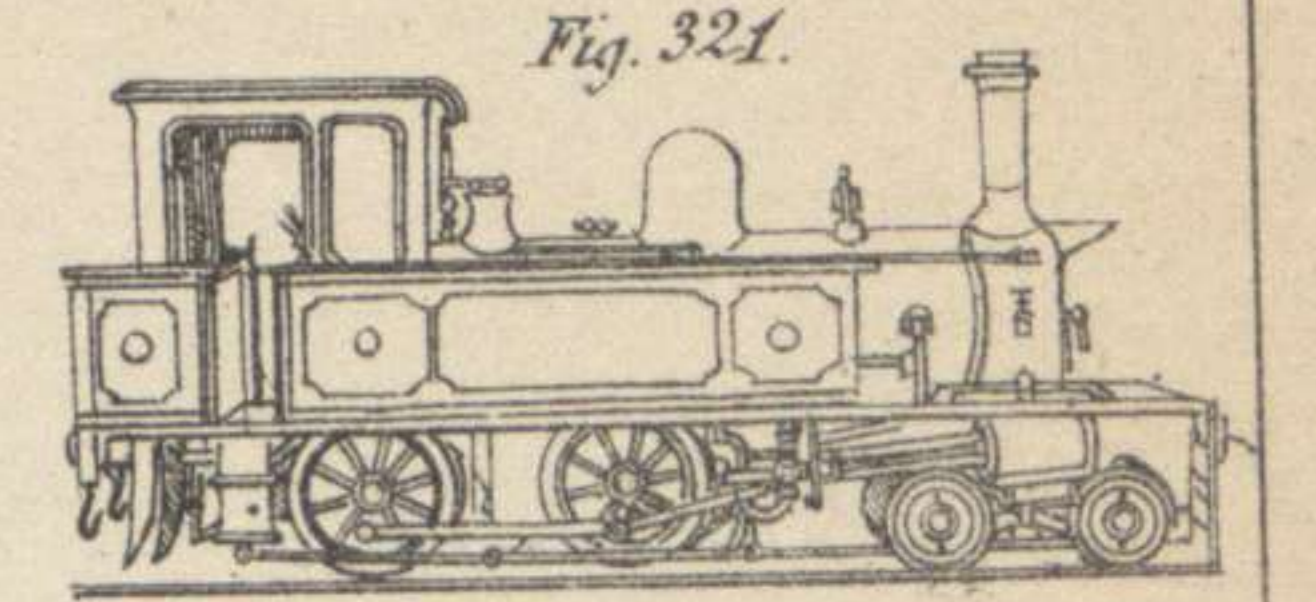
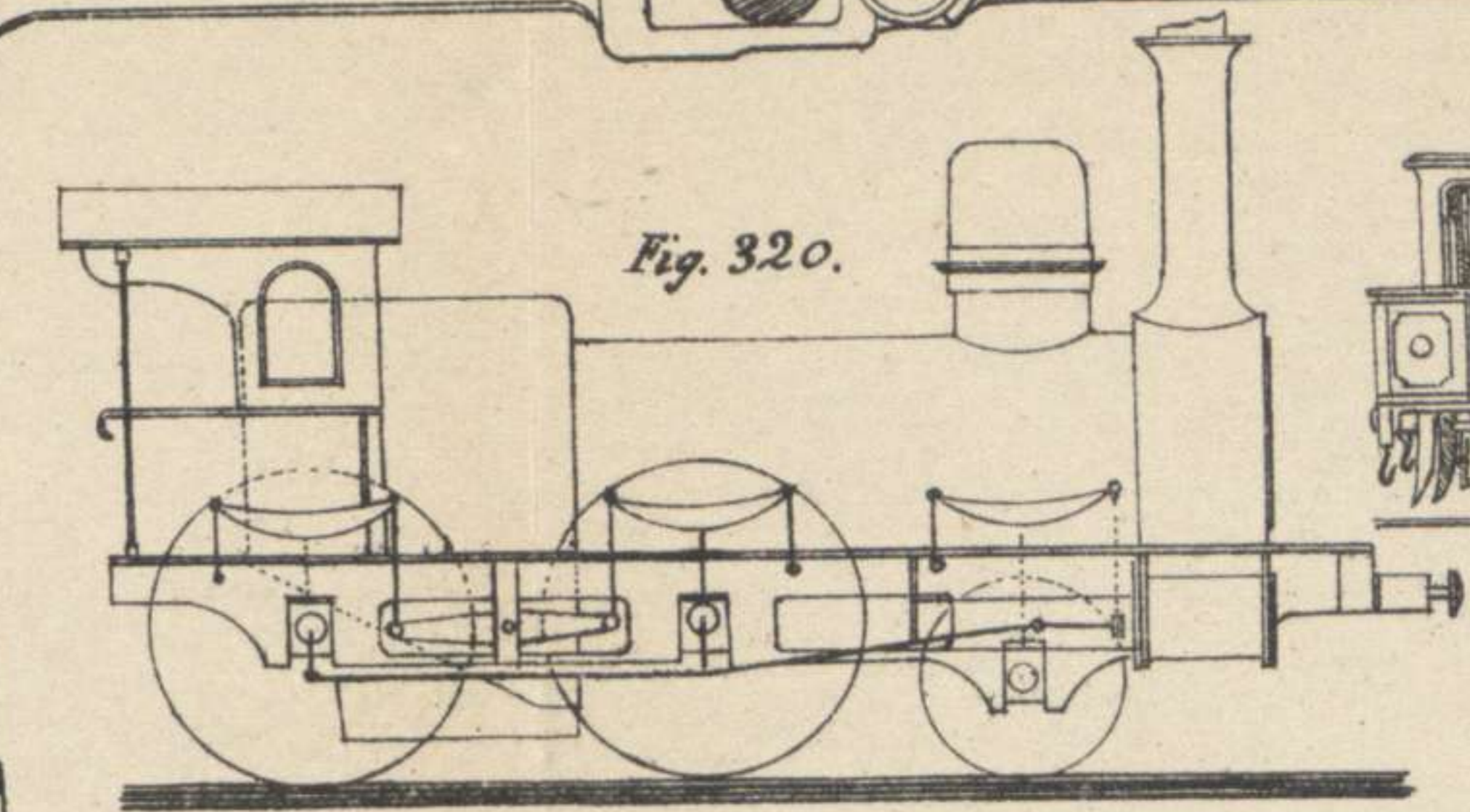
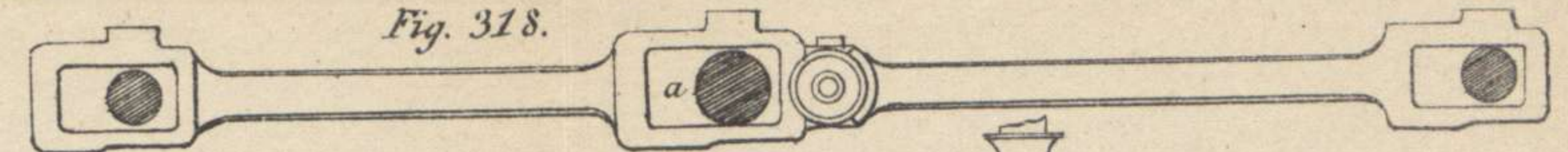
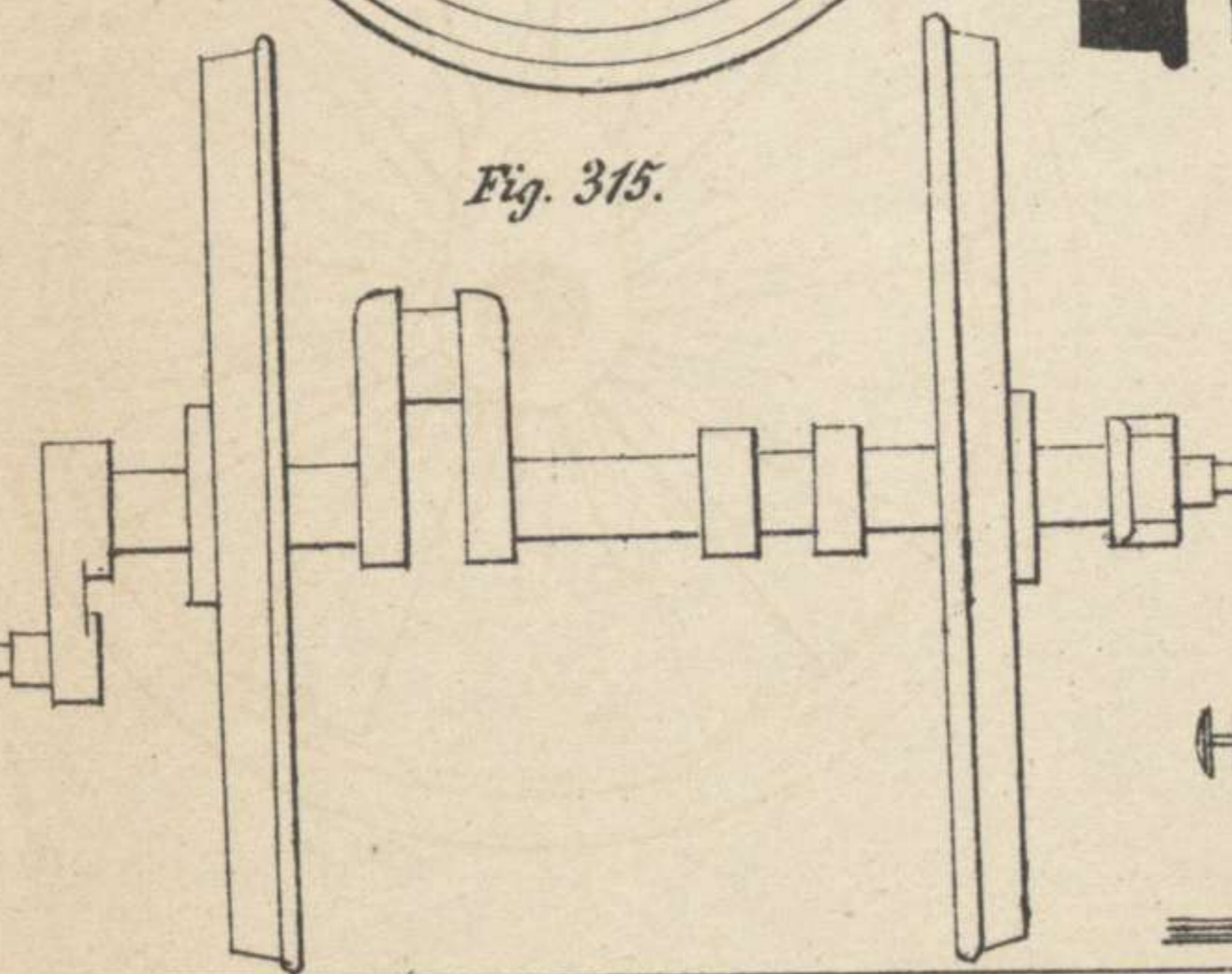
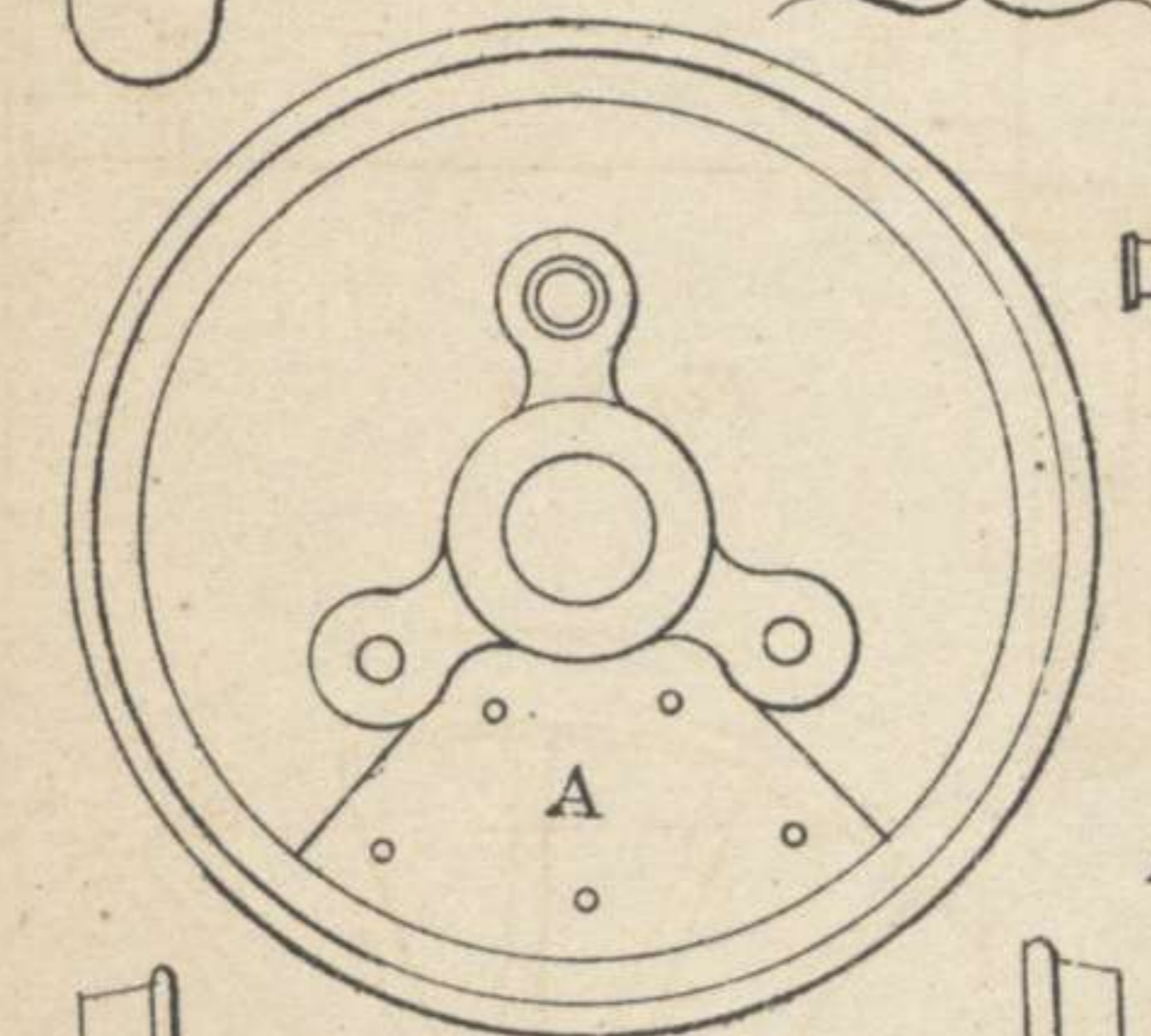
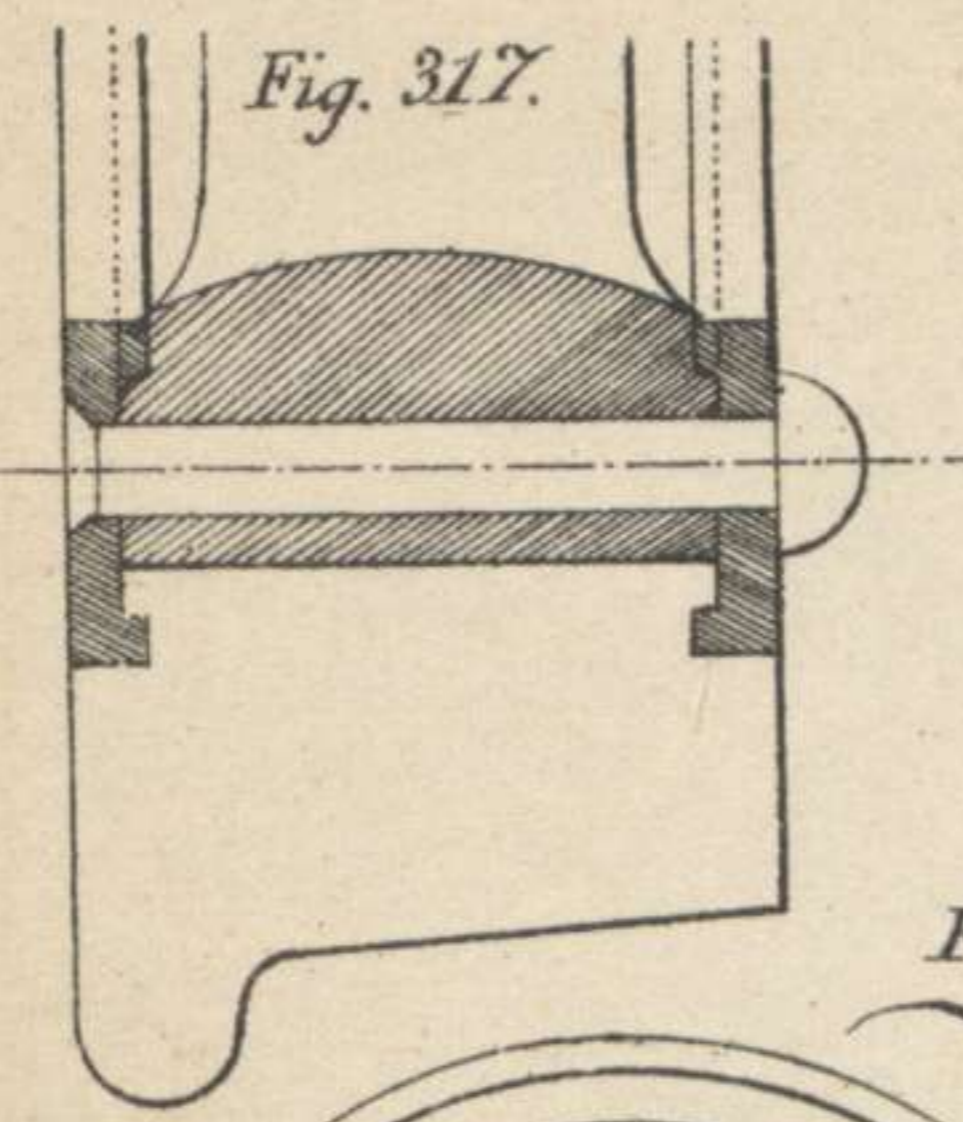
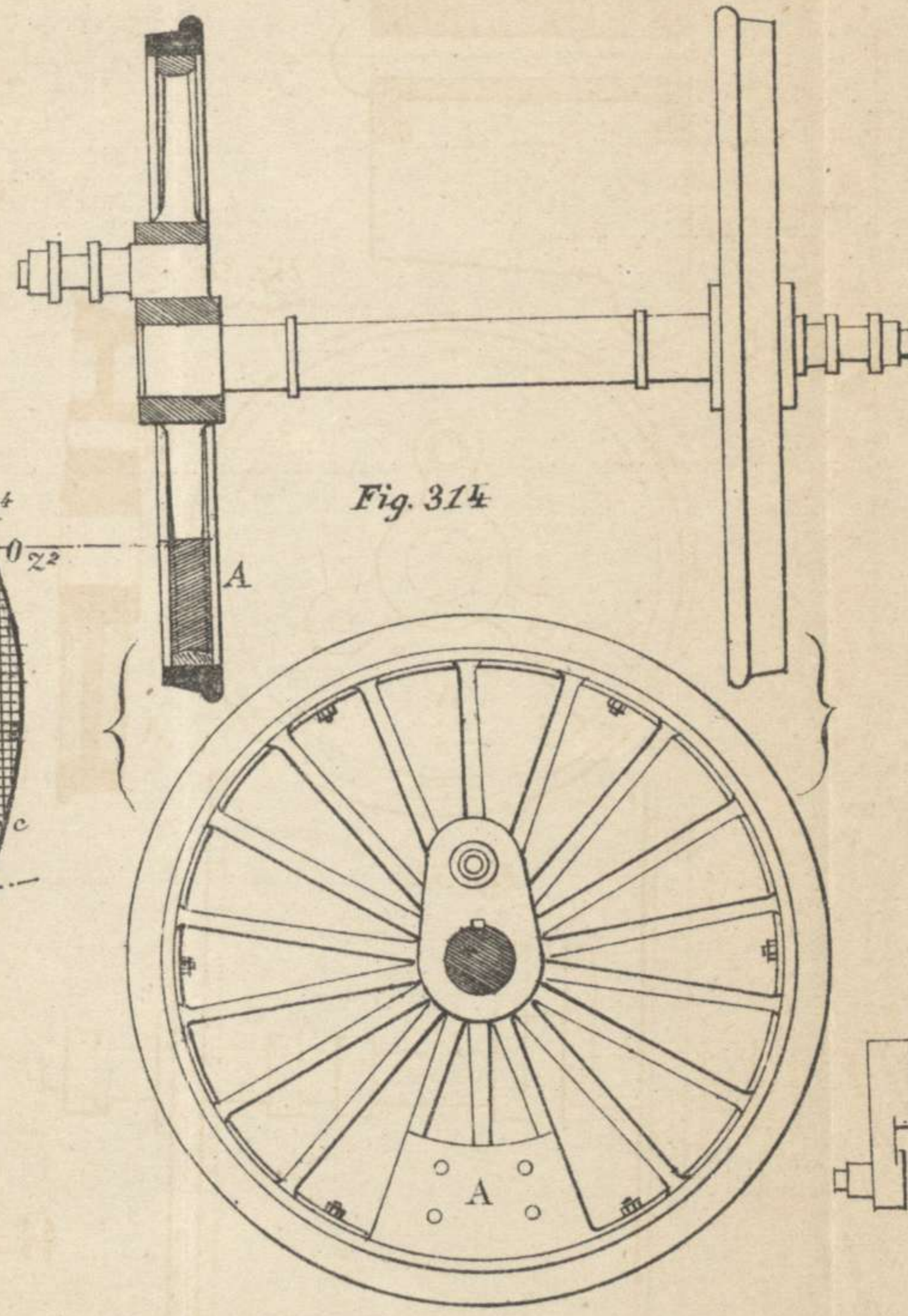

Fig. 312.





 Admisión.
 Emisión.
 Expansión.
 Compresión.



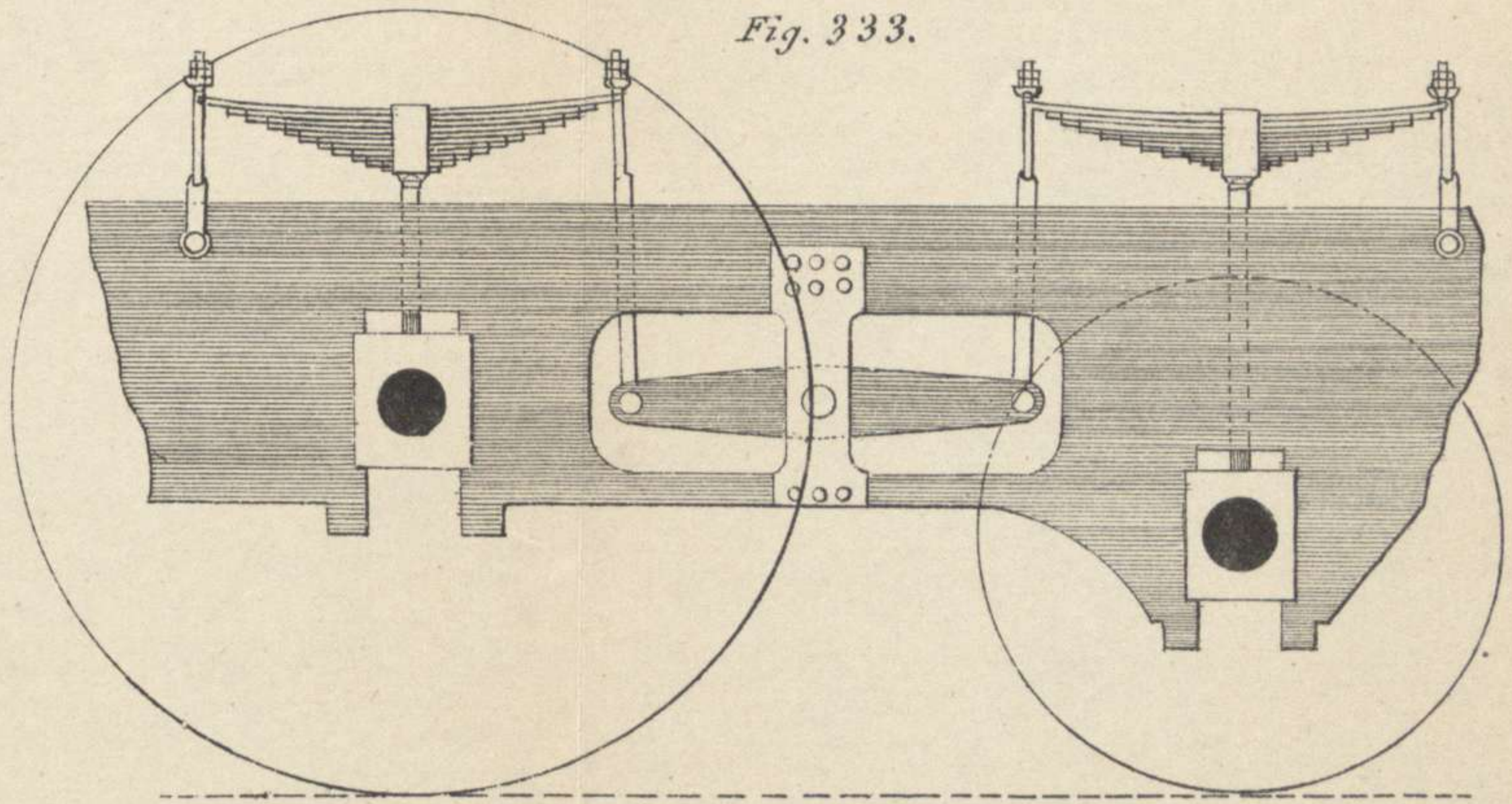
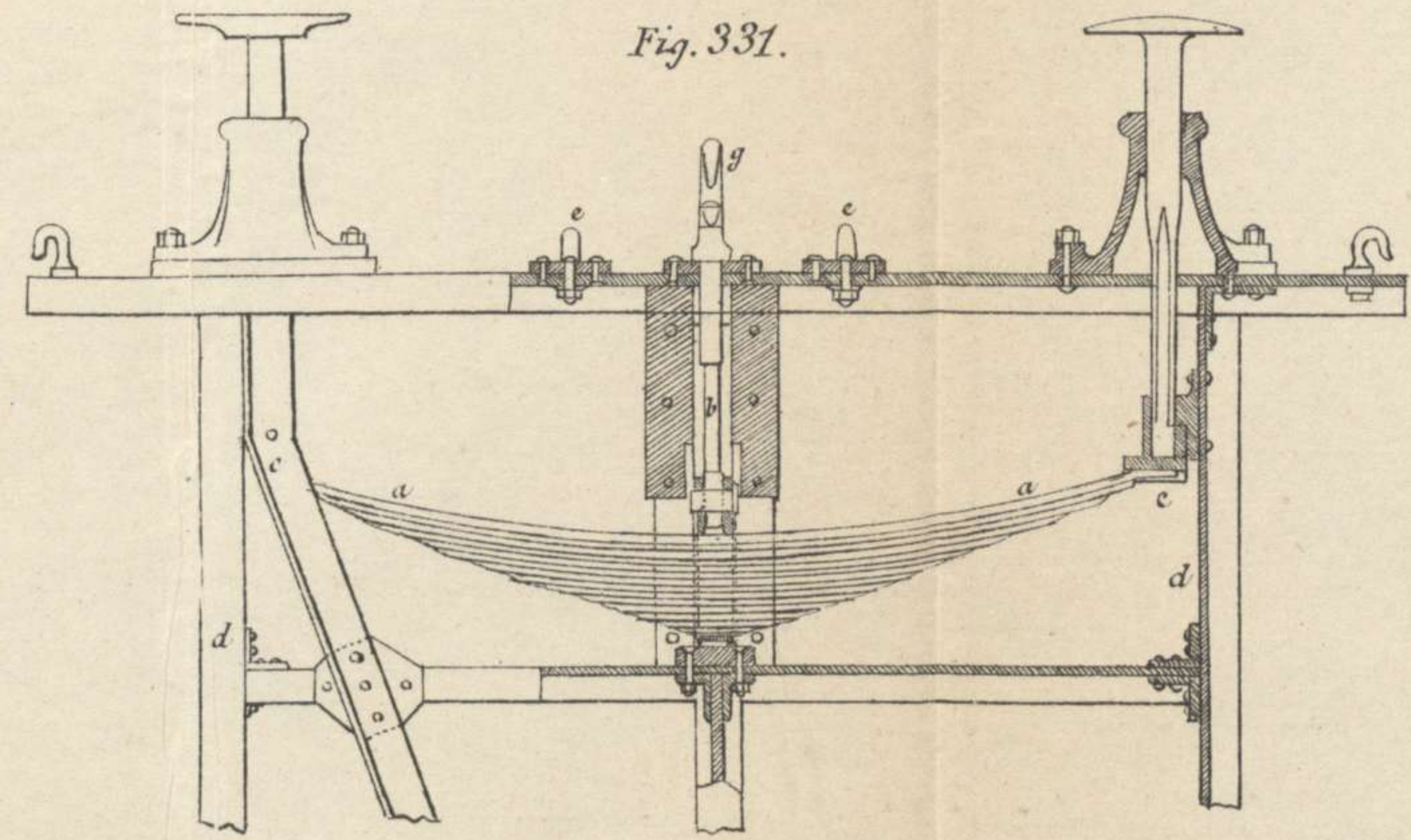
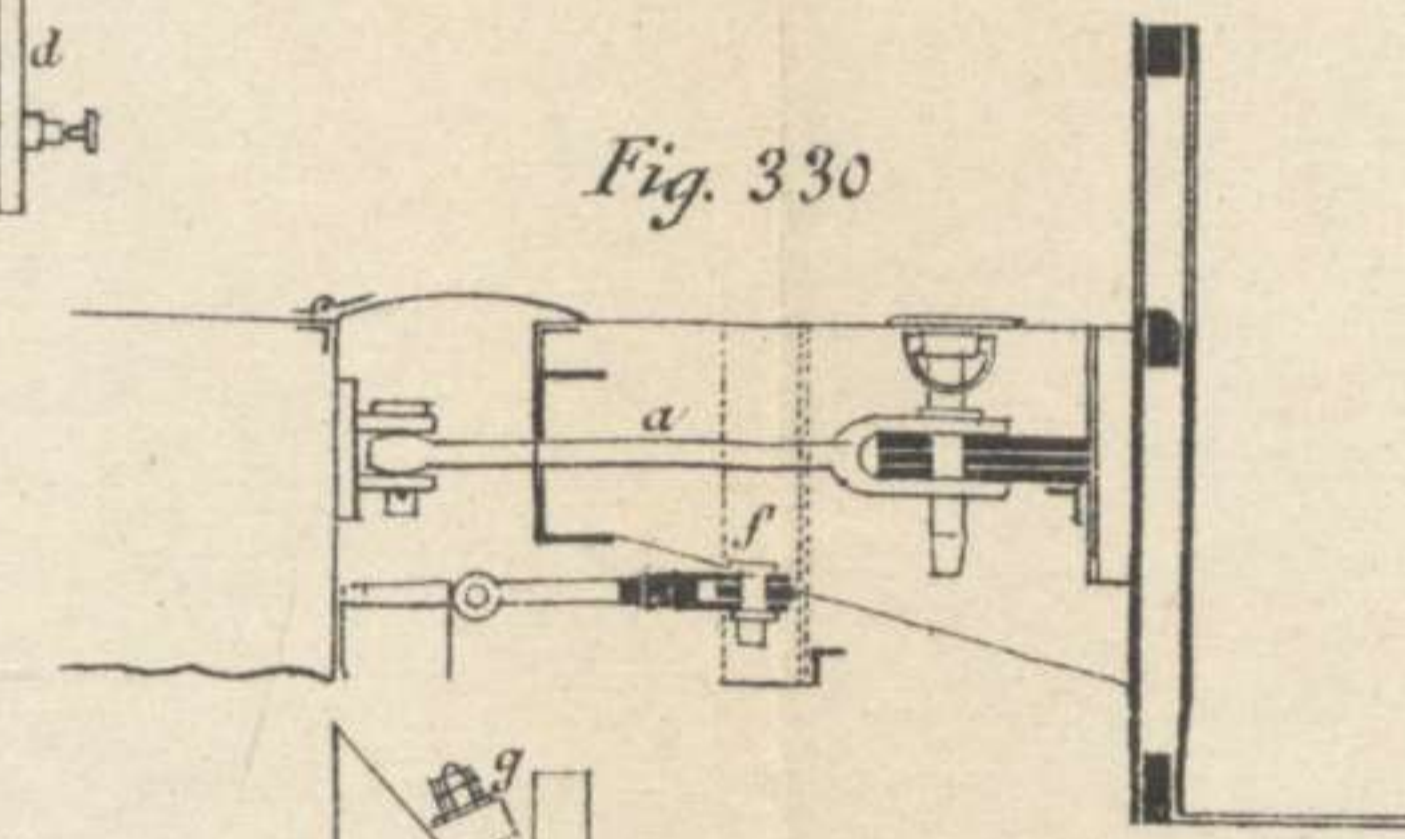
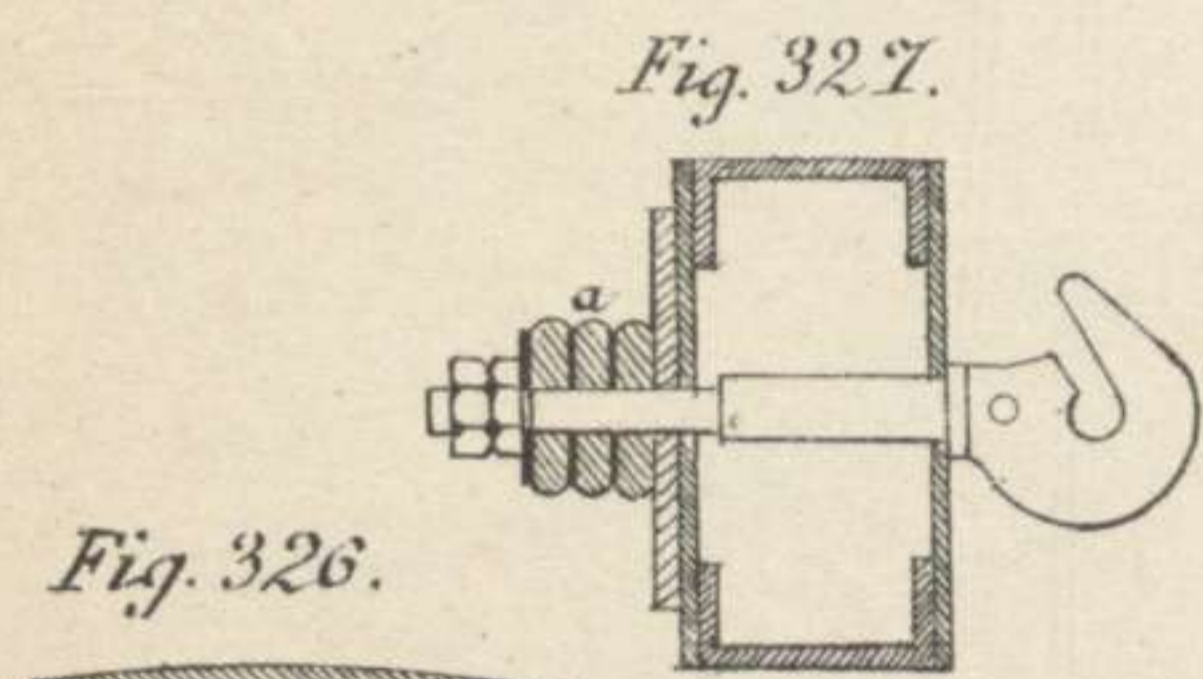
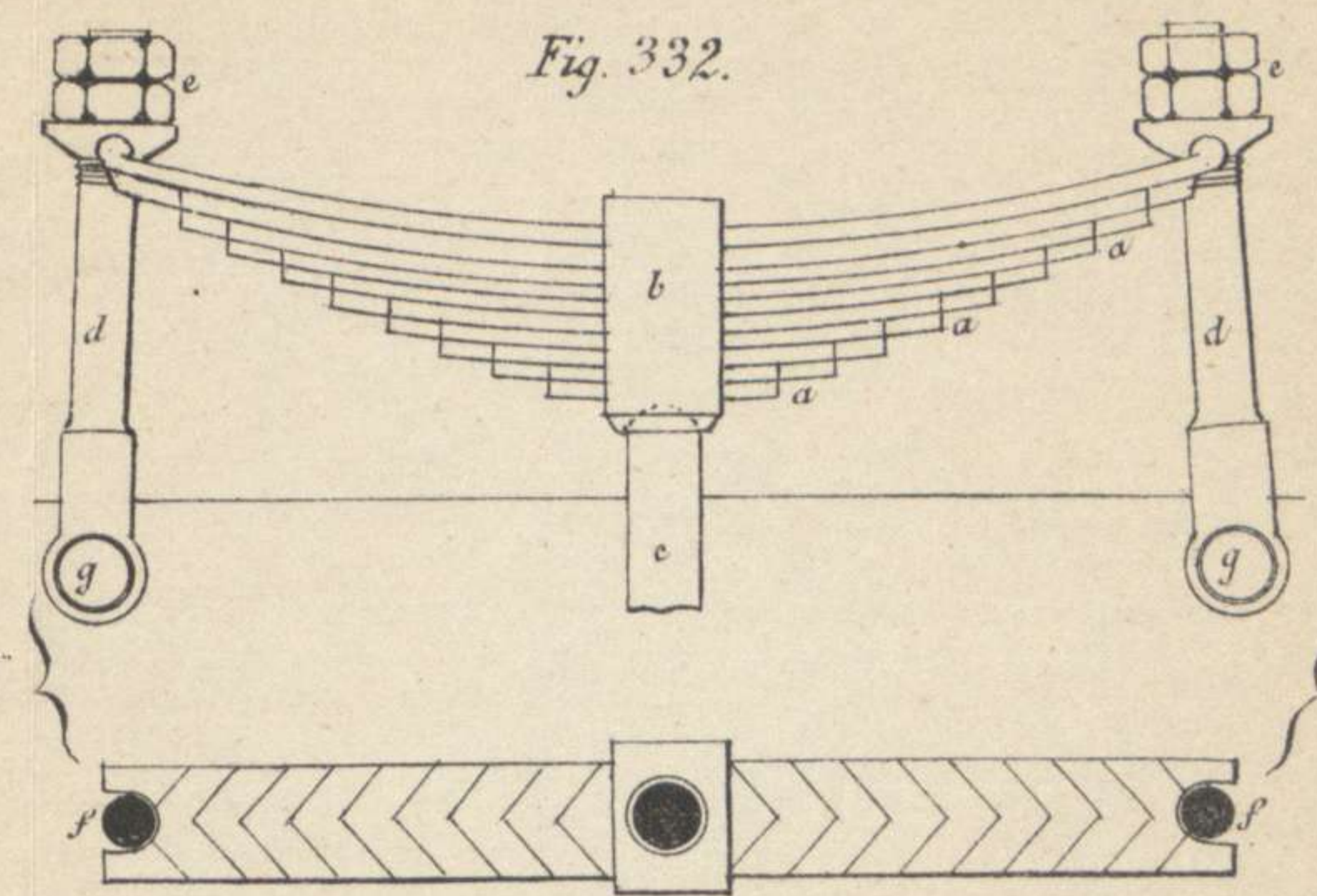
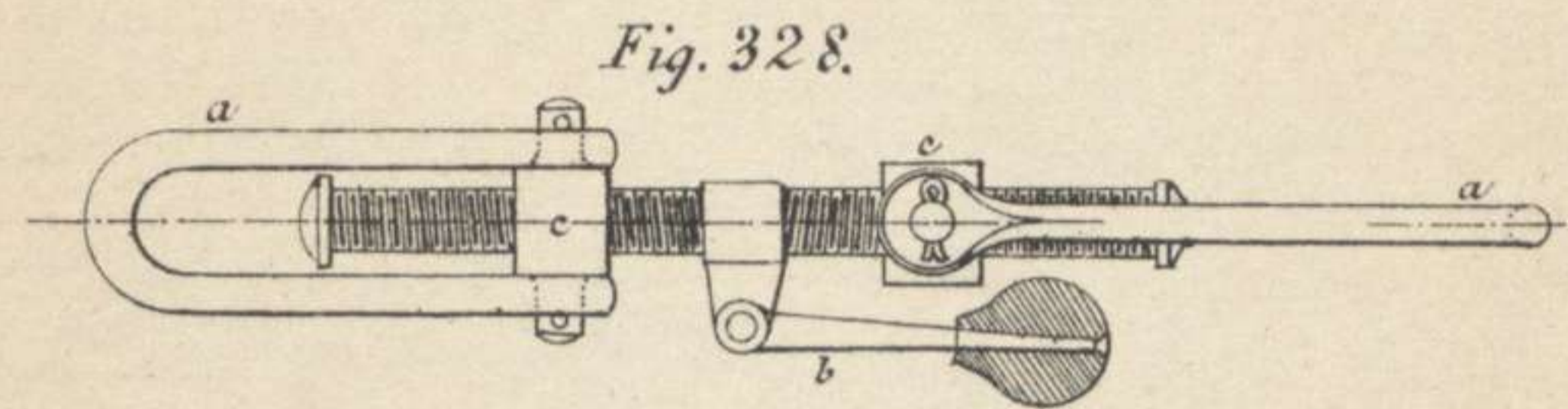
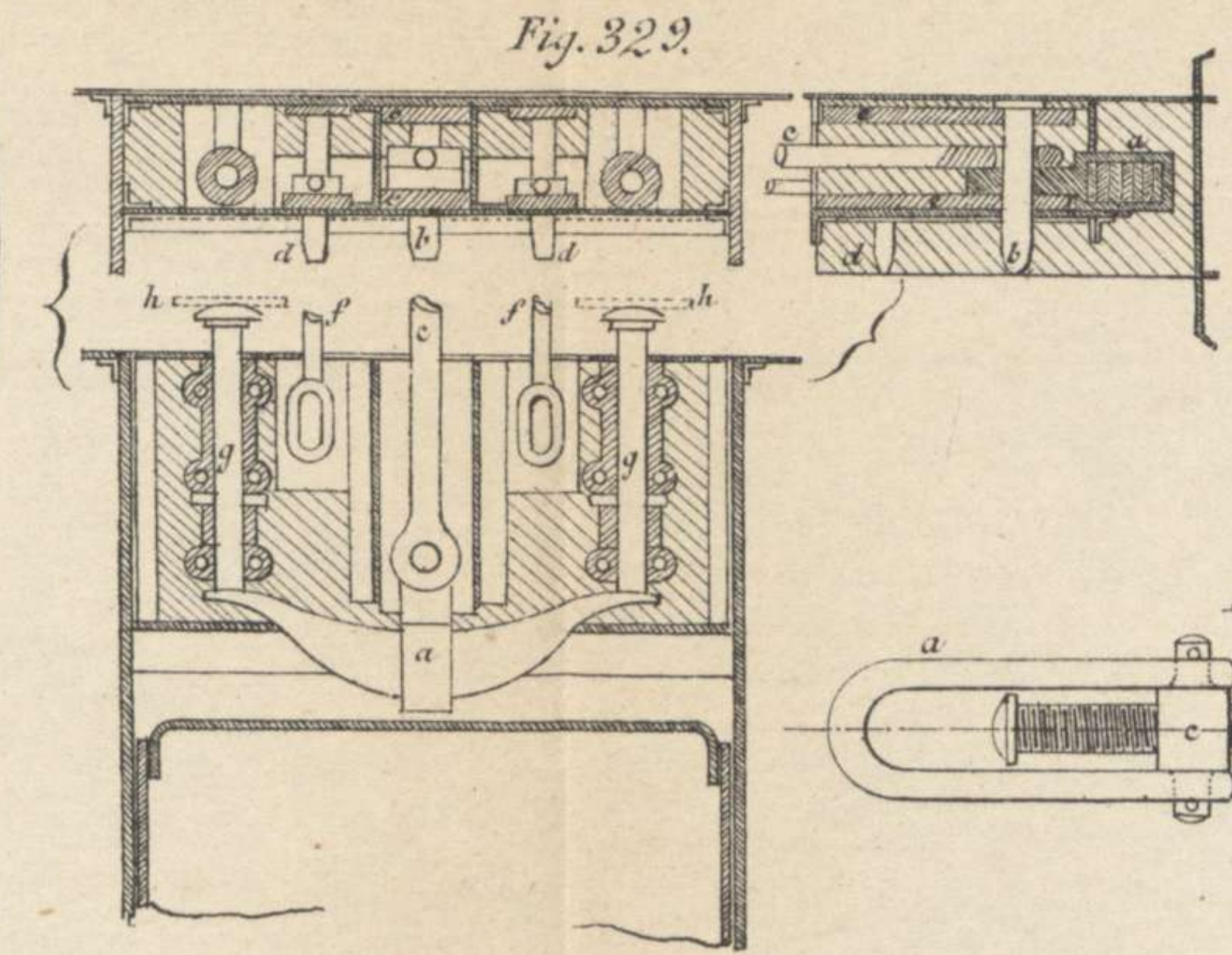
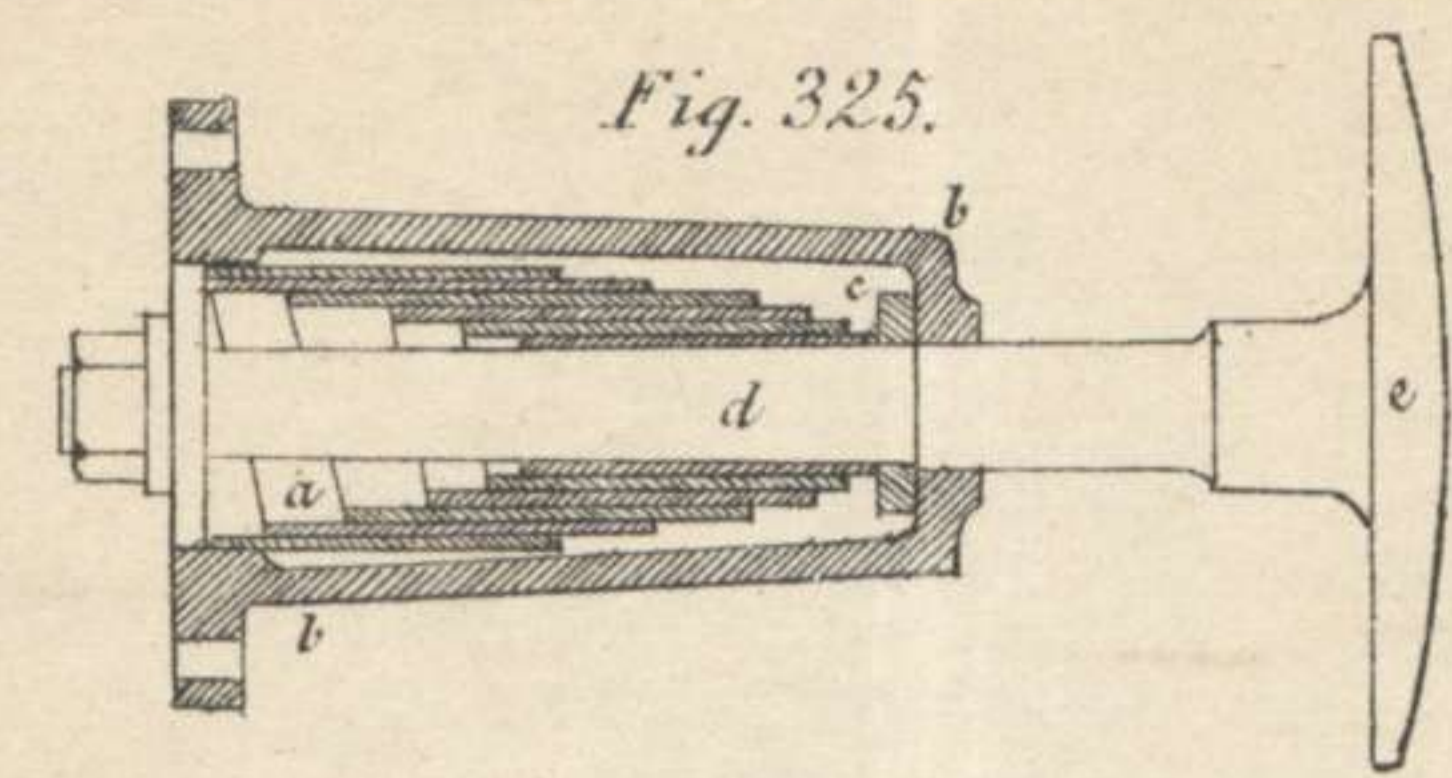
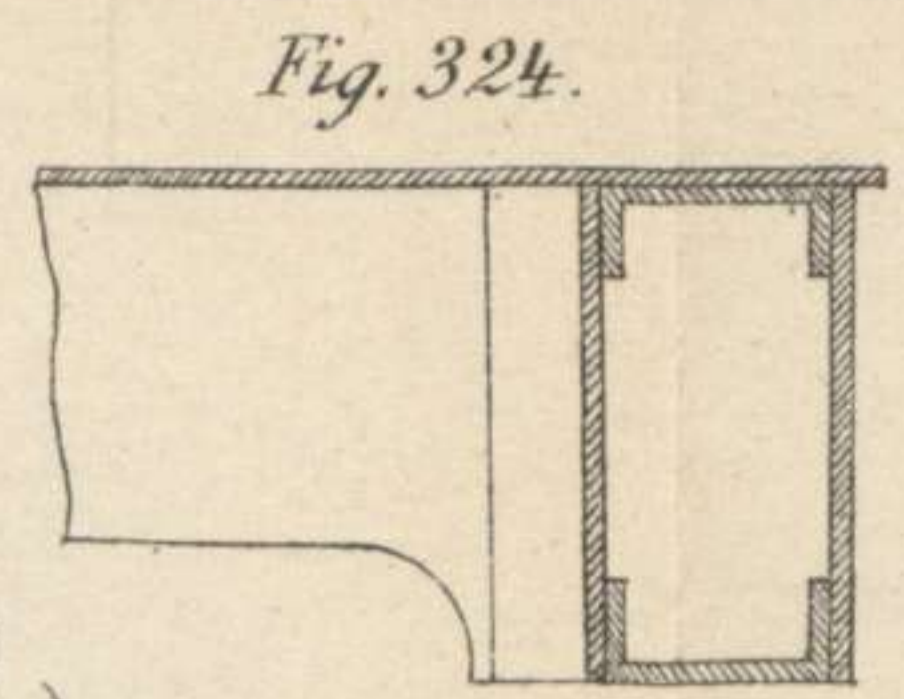
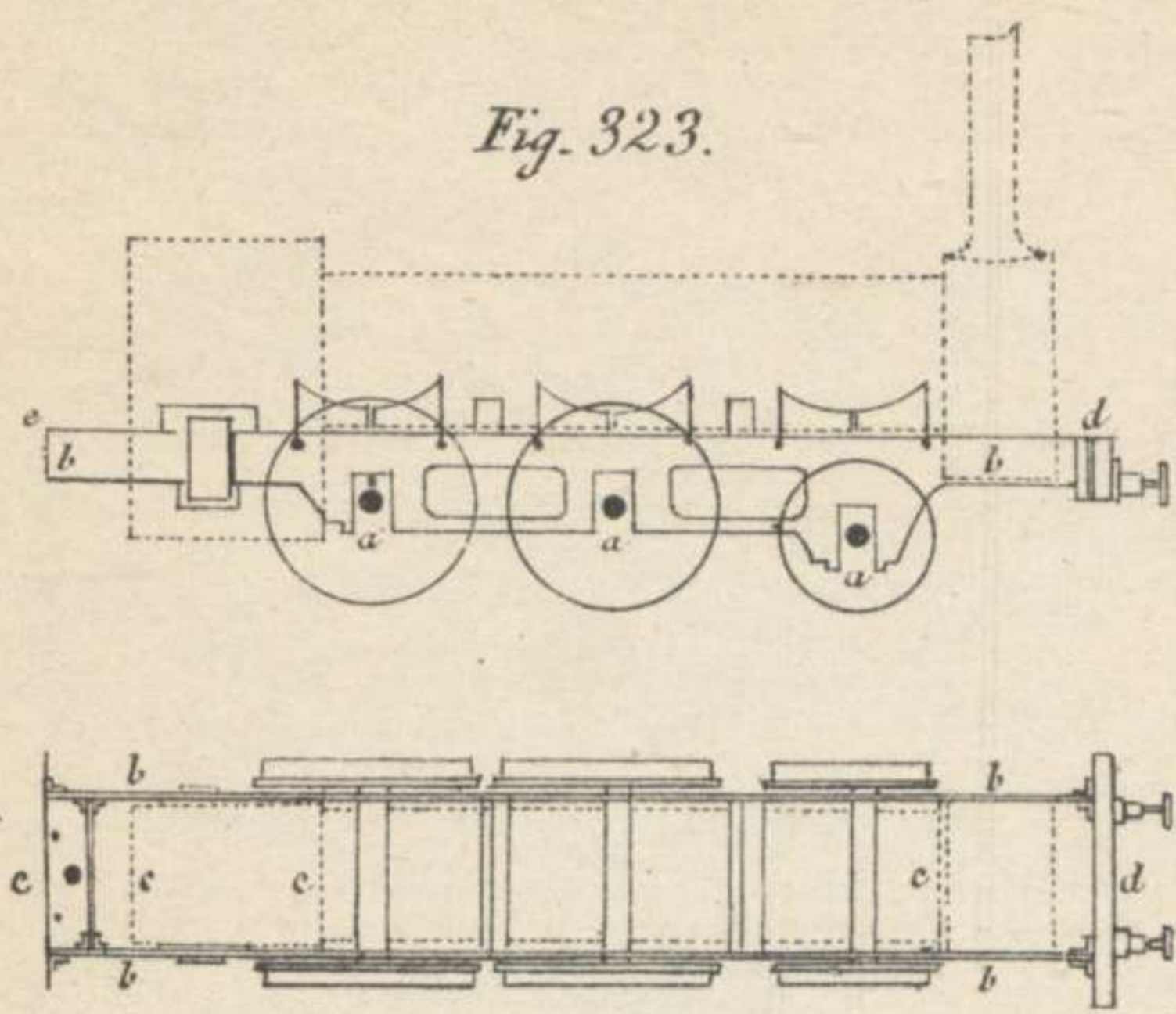

Fig. 334.

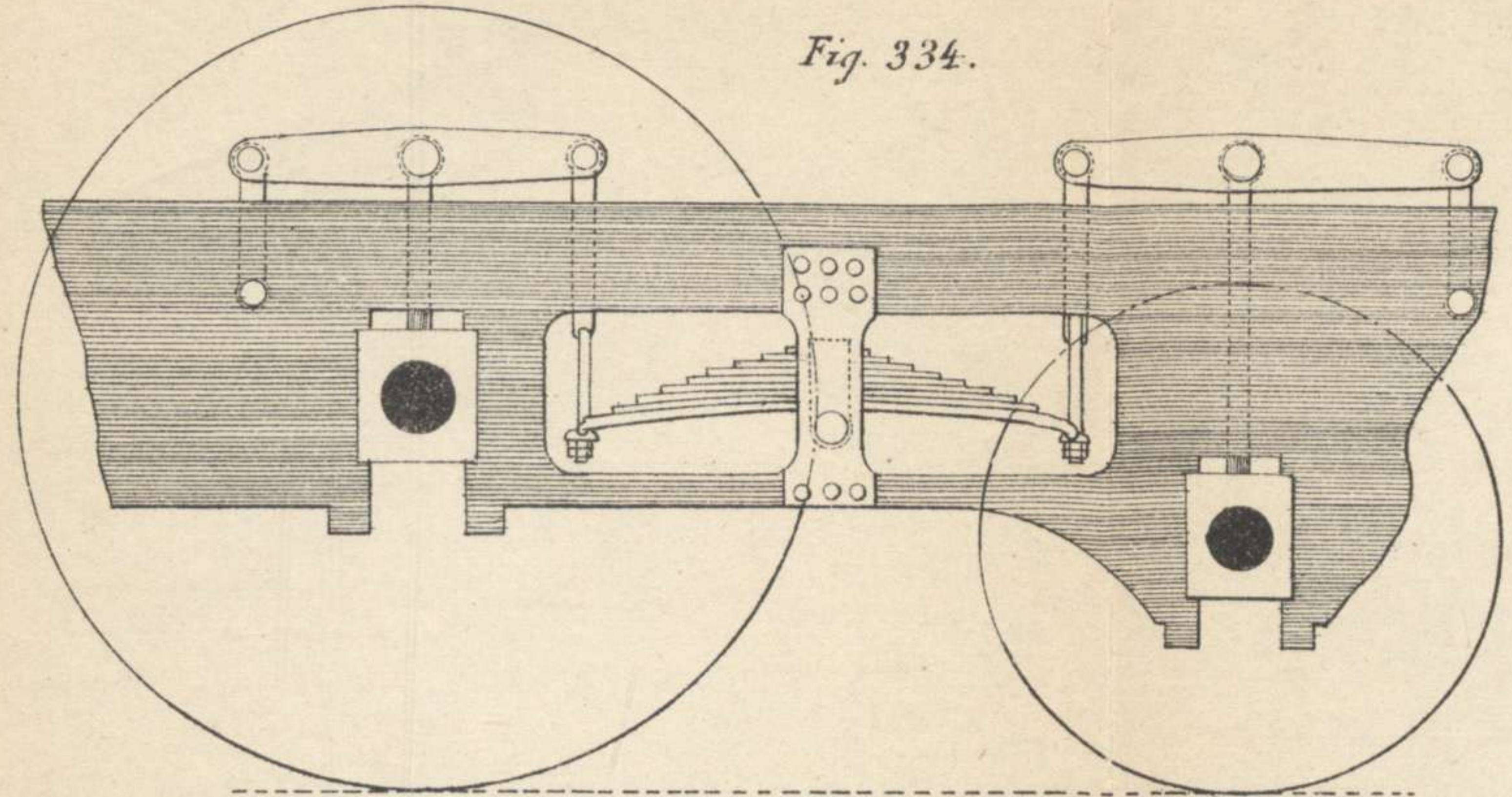

Fig. 335.

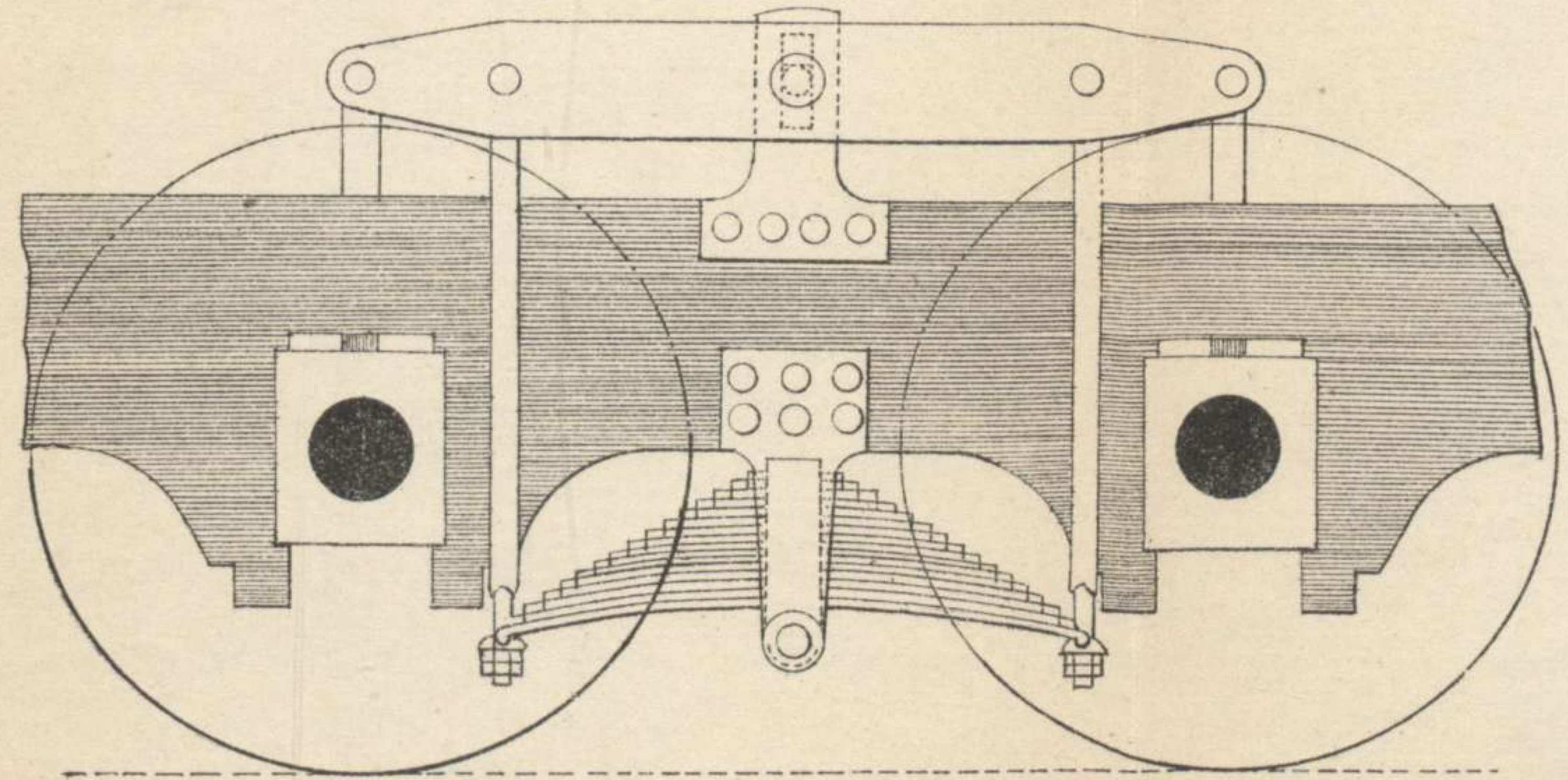

Fig. 338.

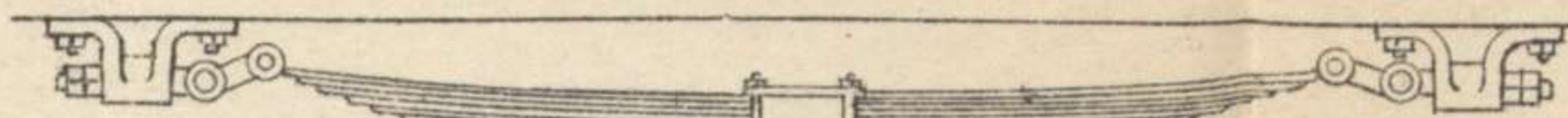

Fig. 337.

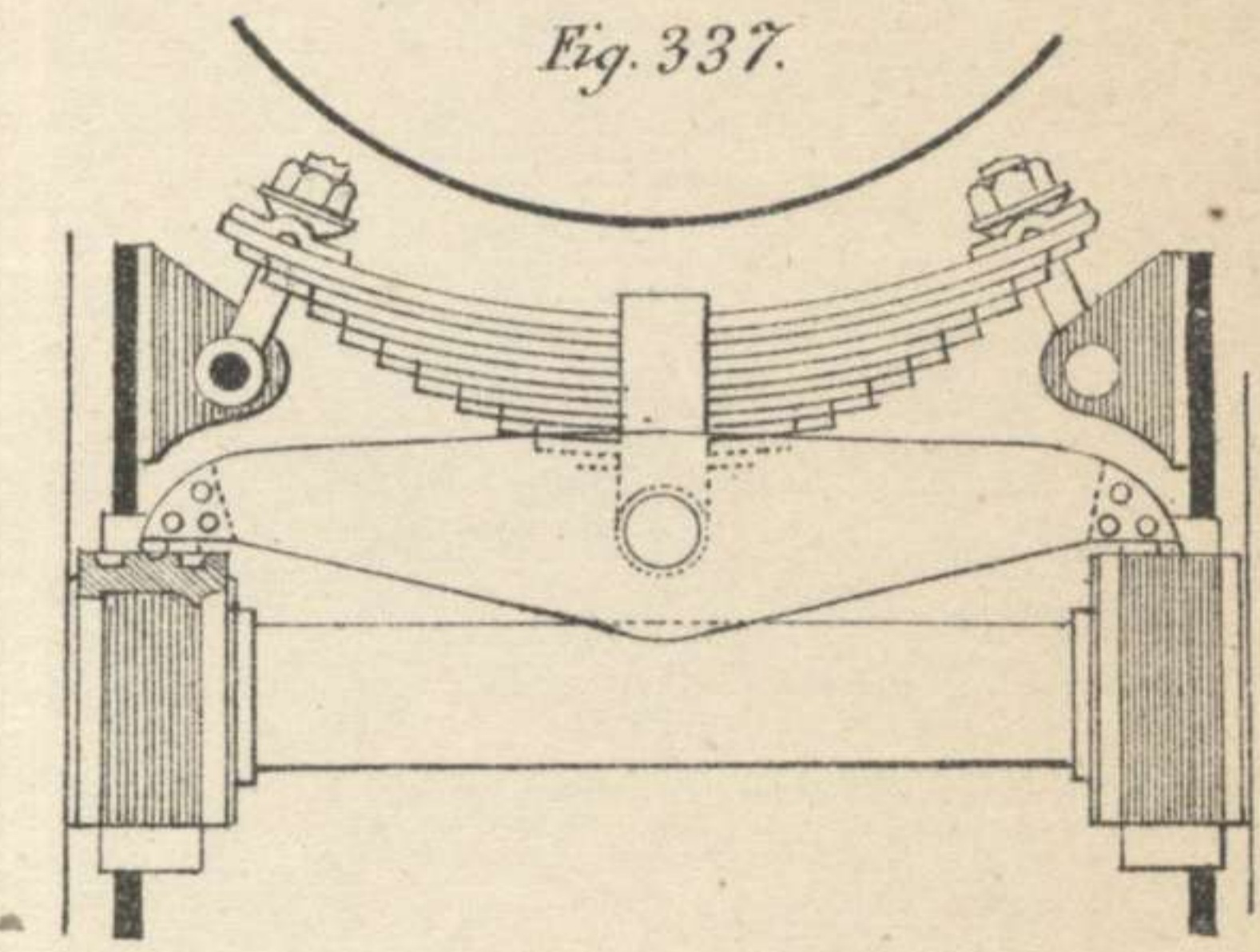

Fig. 336.

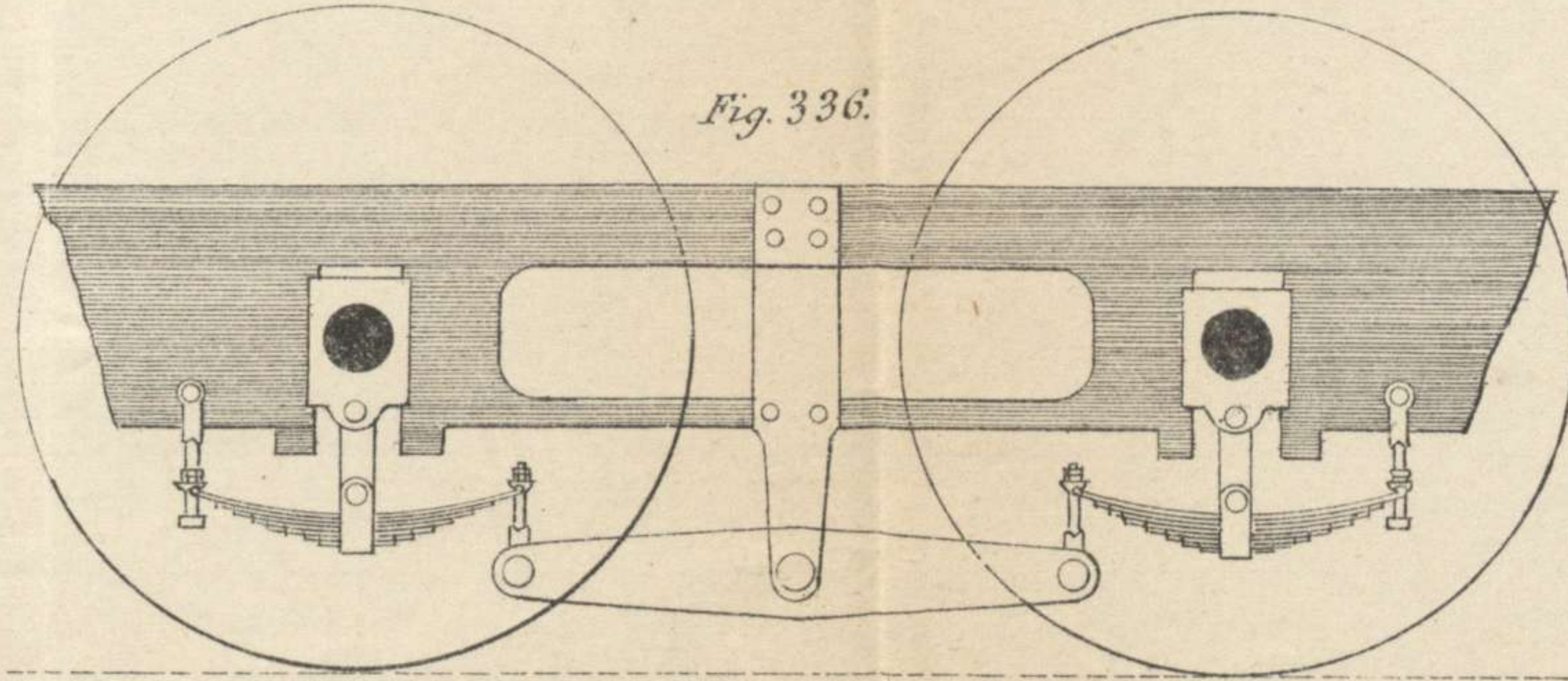

Fig. 339.

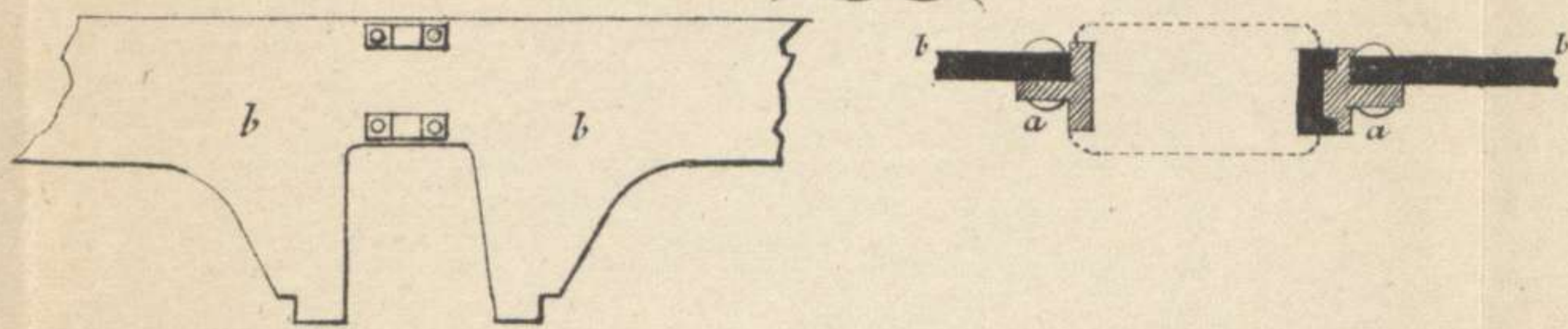

Fig. 340.

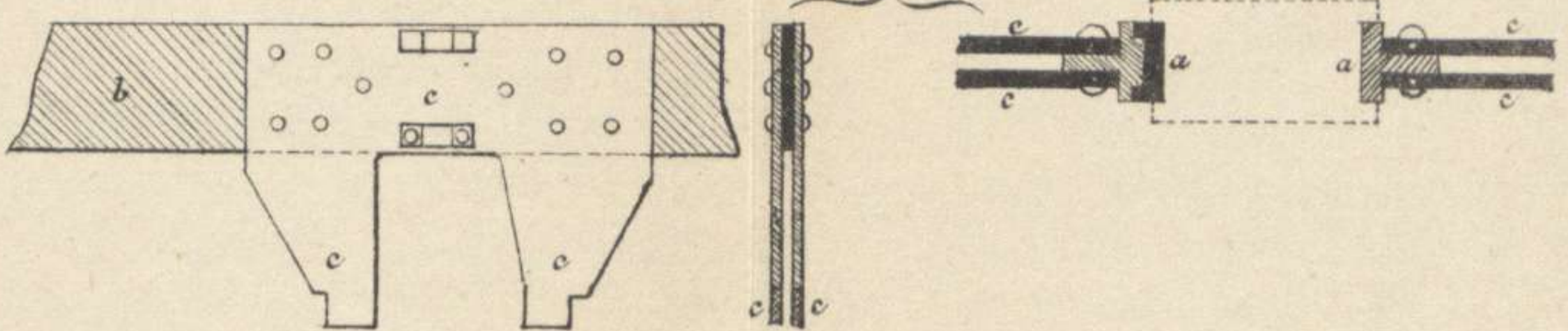

Fig. 341.

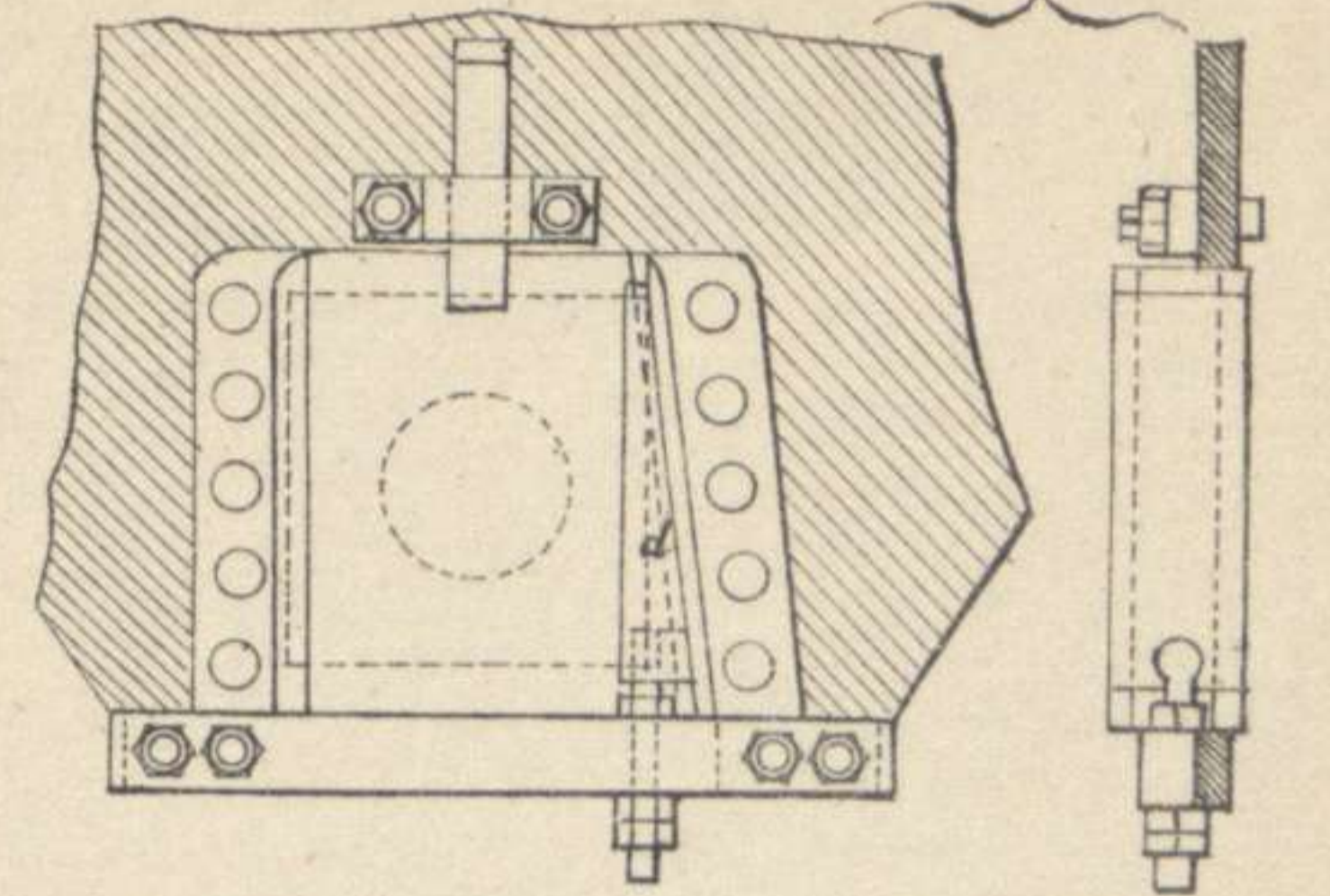
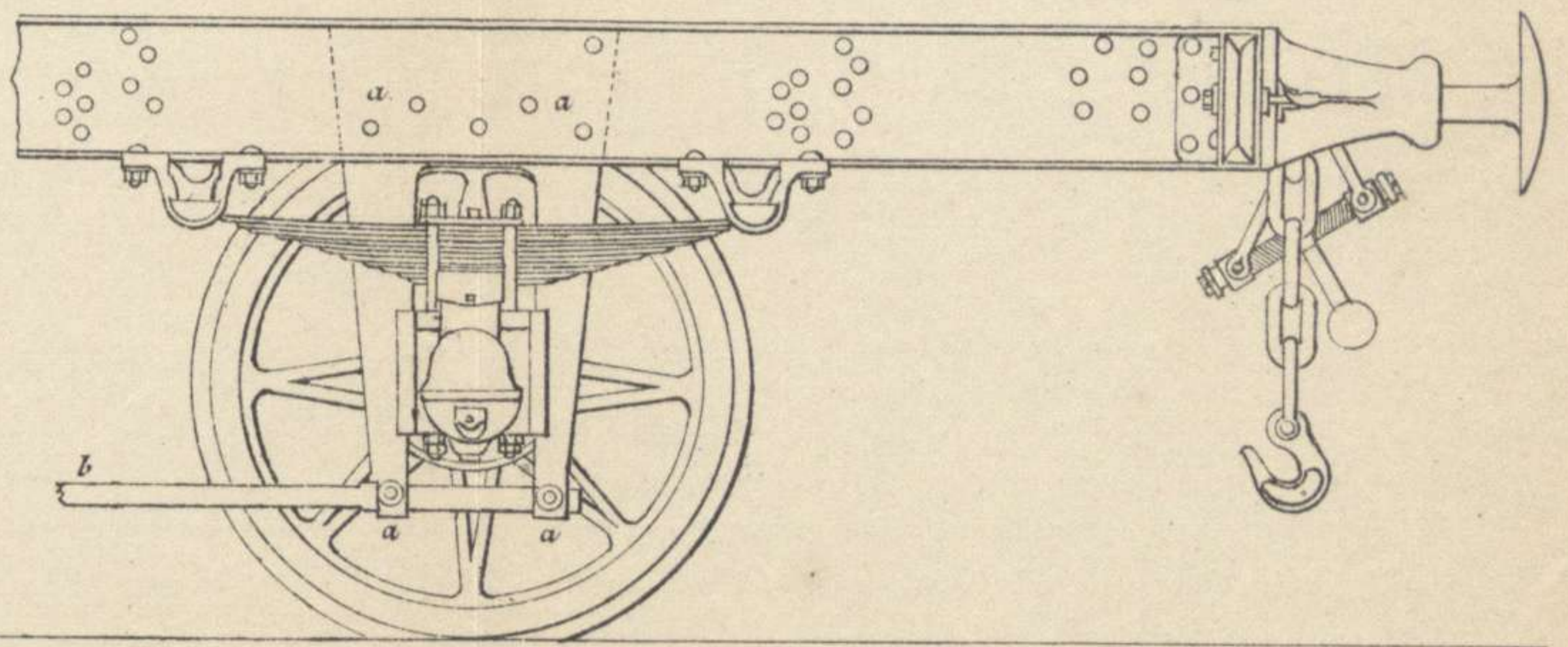

Fig. 342.



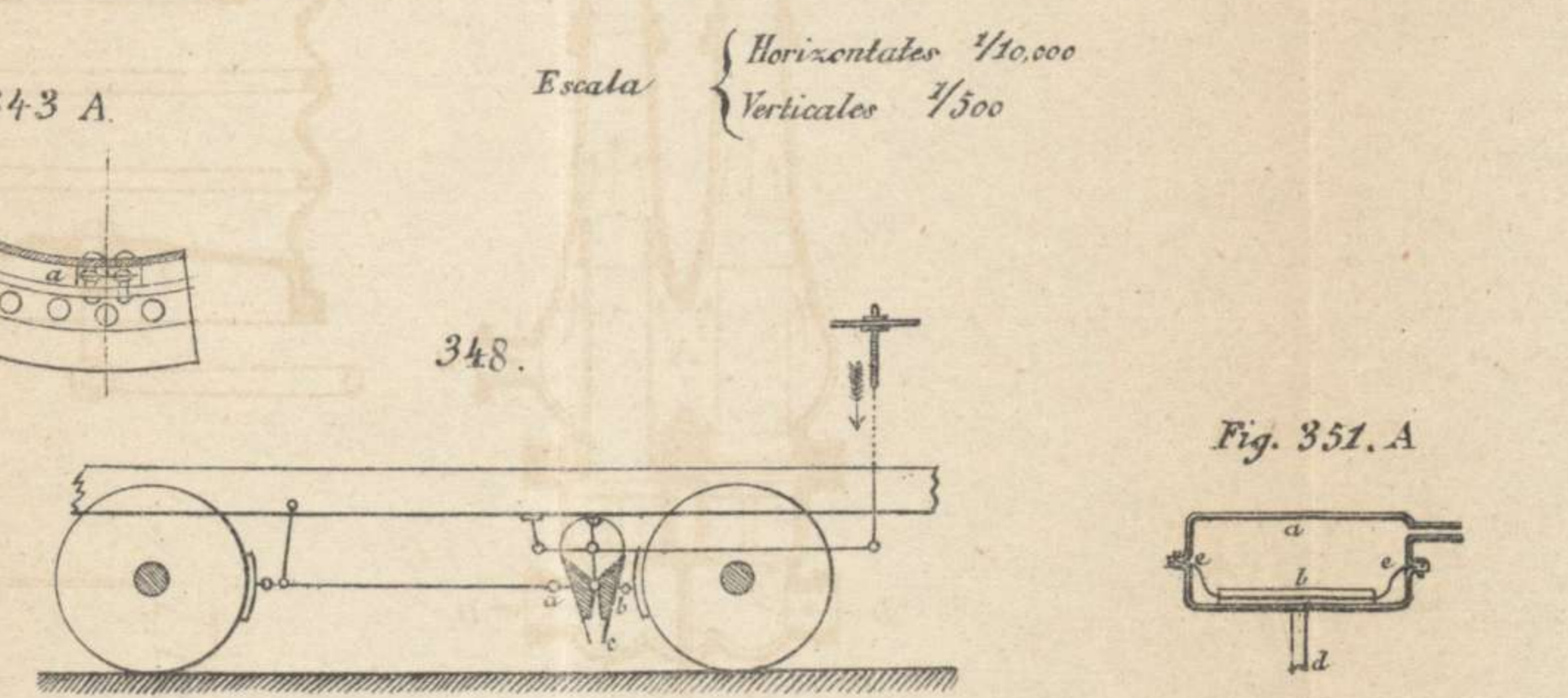
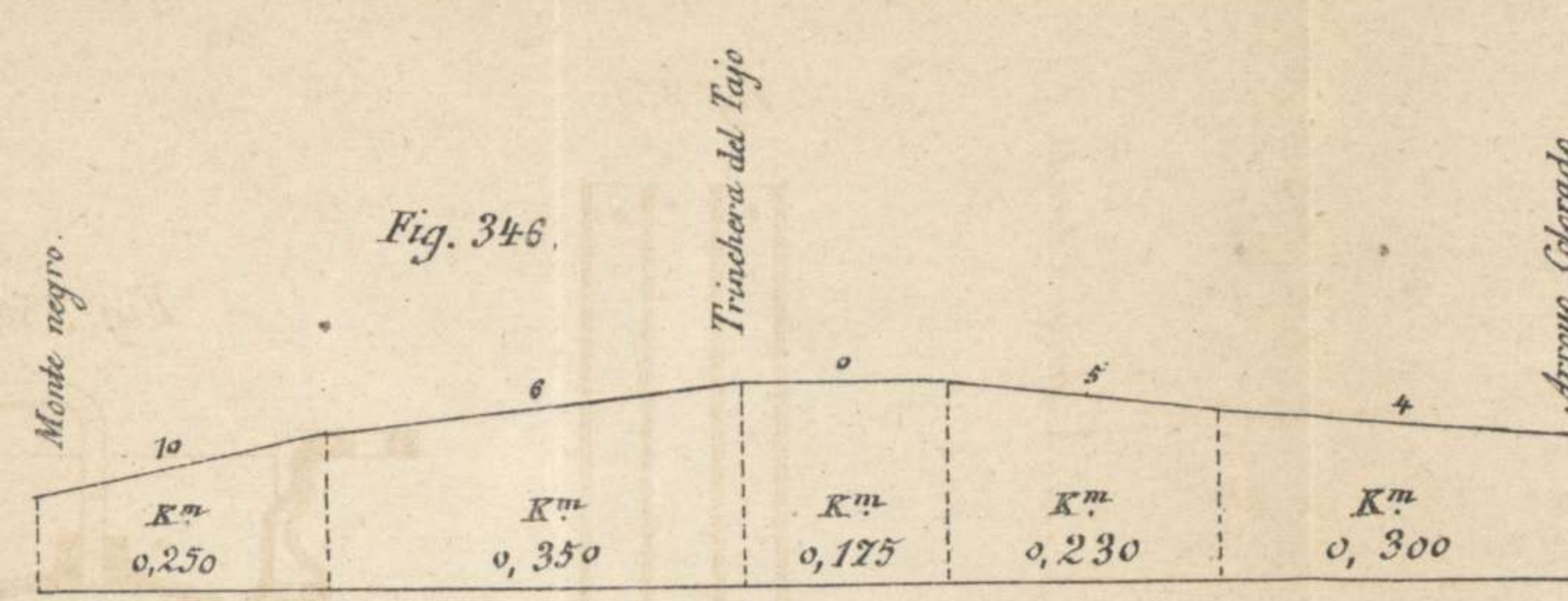
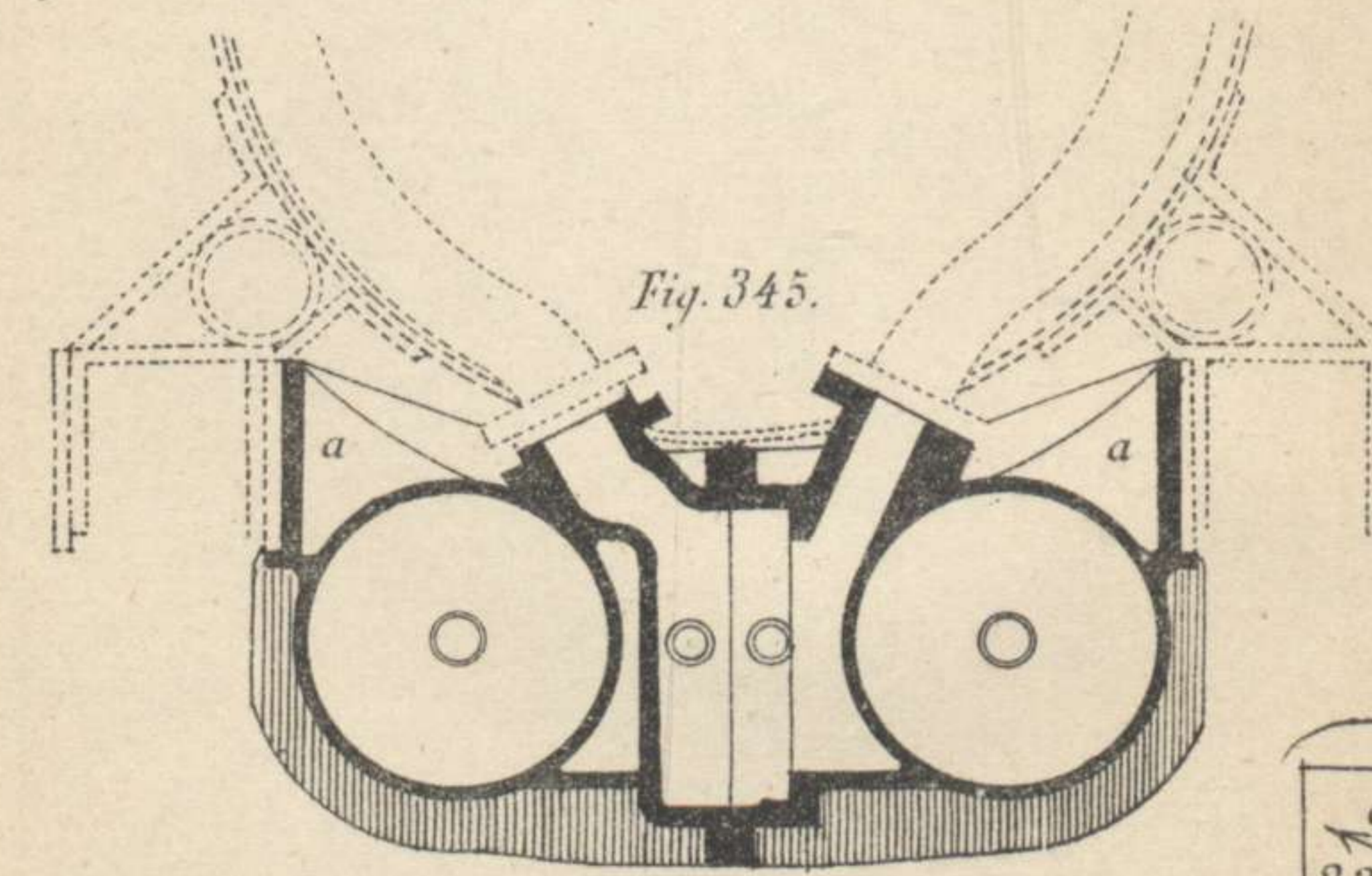
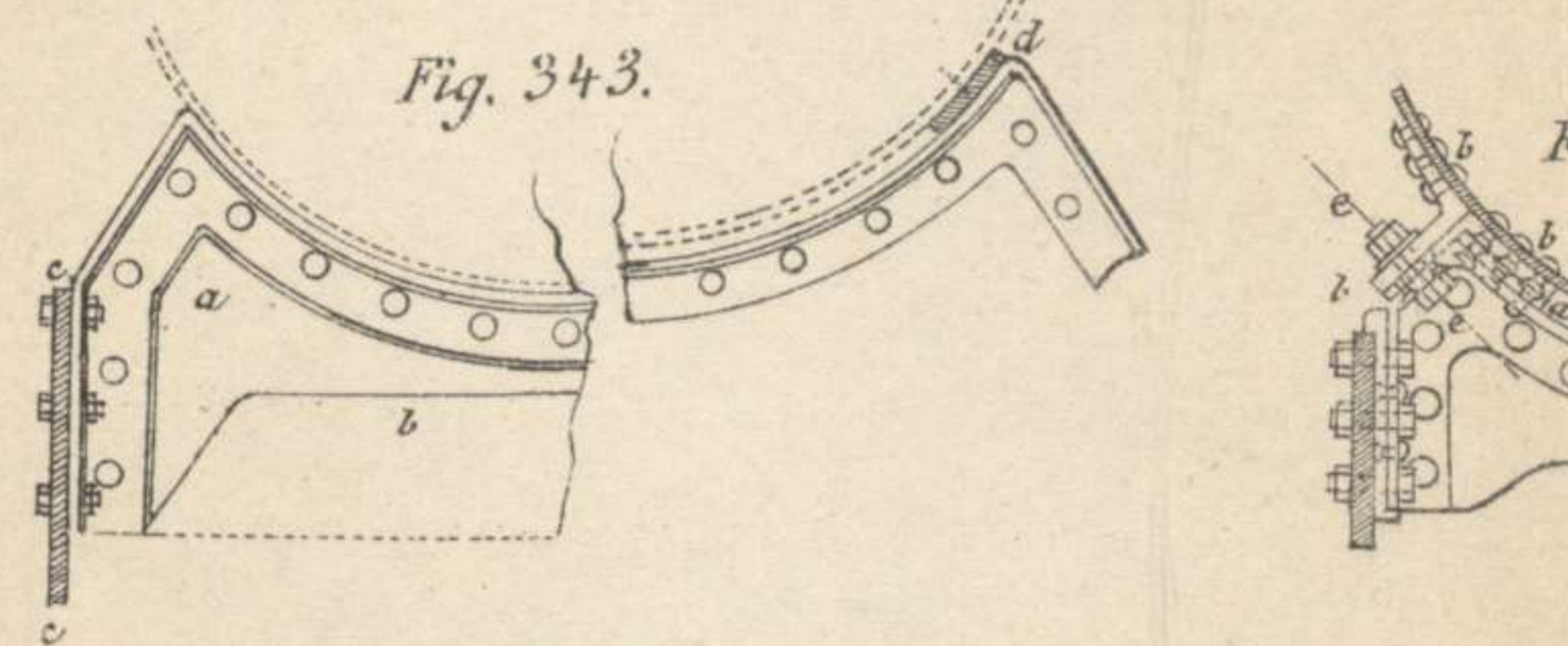
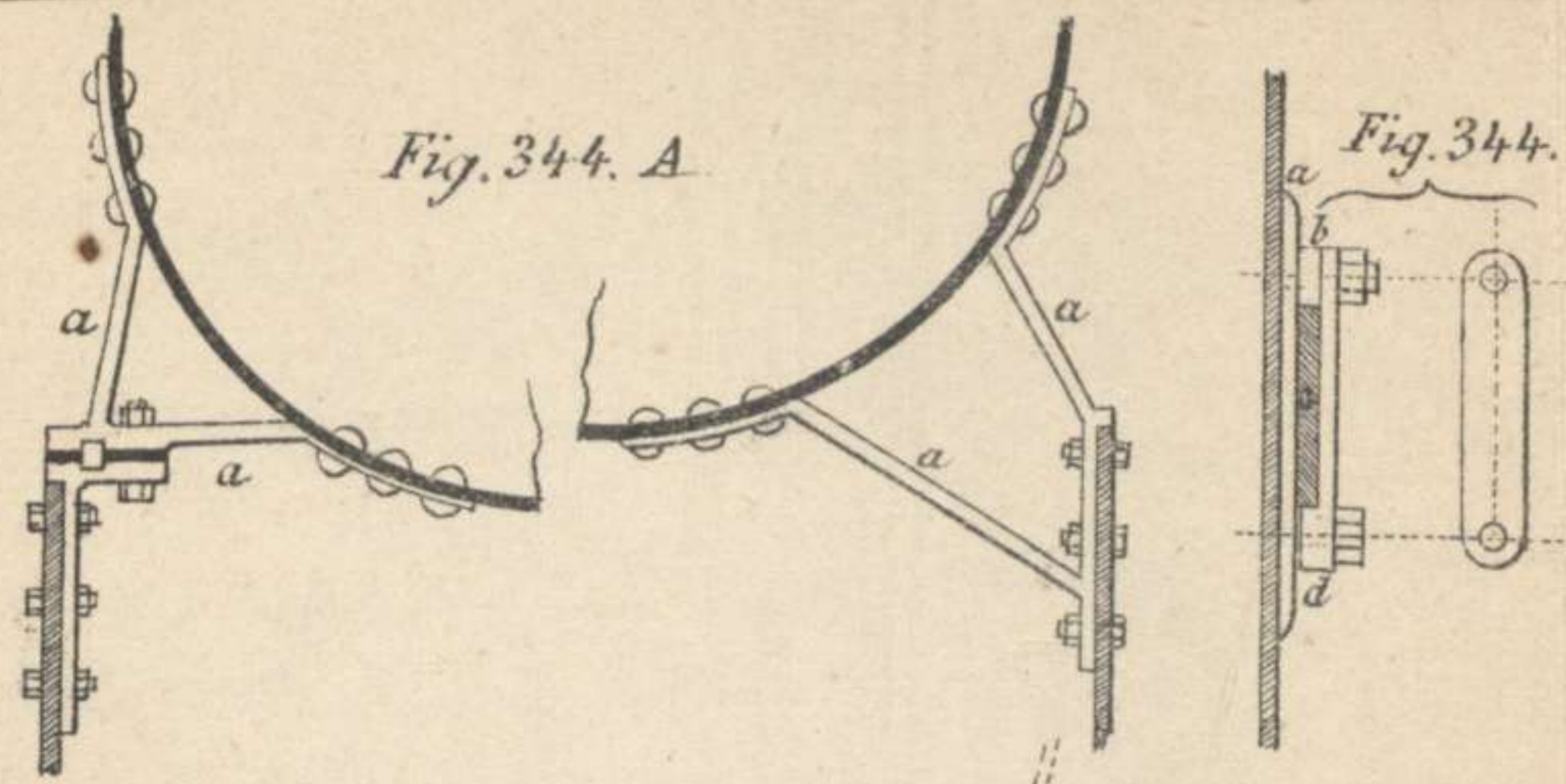
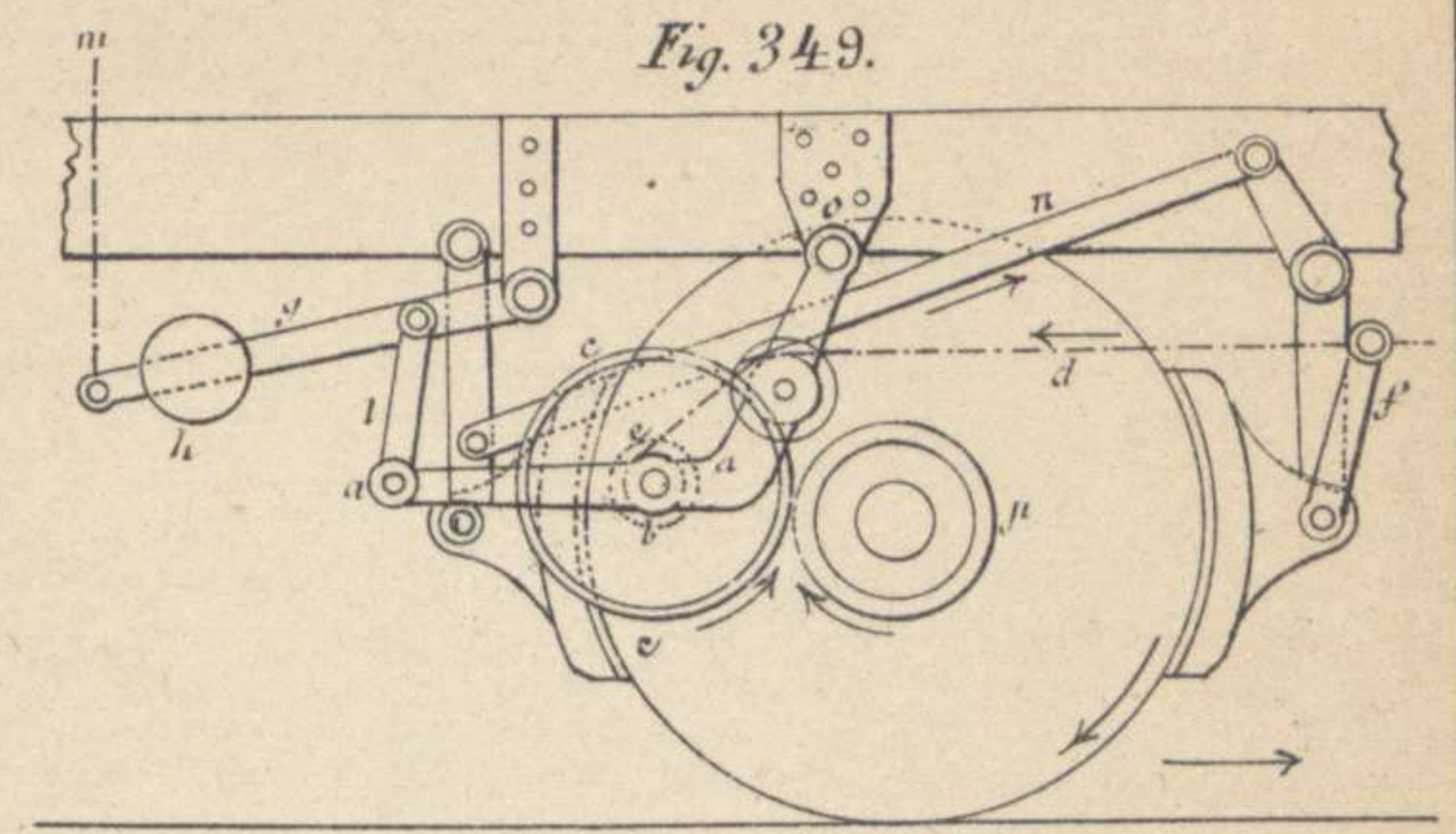
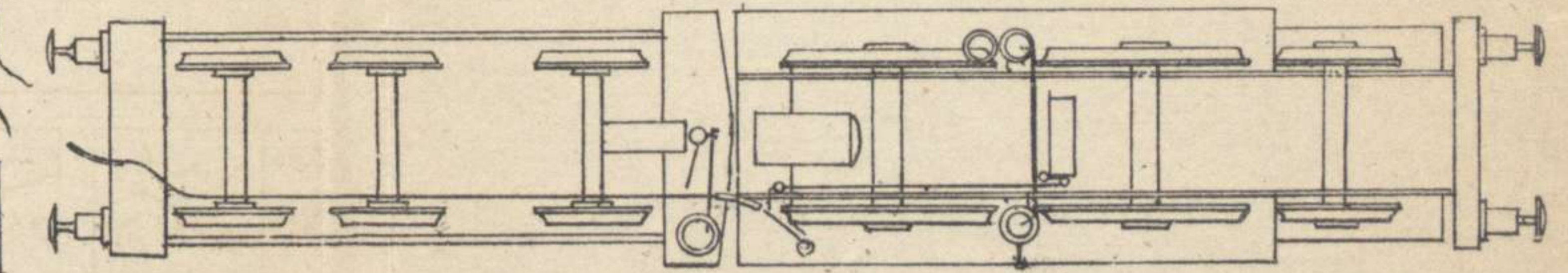
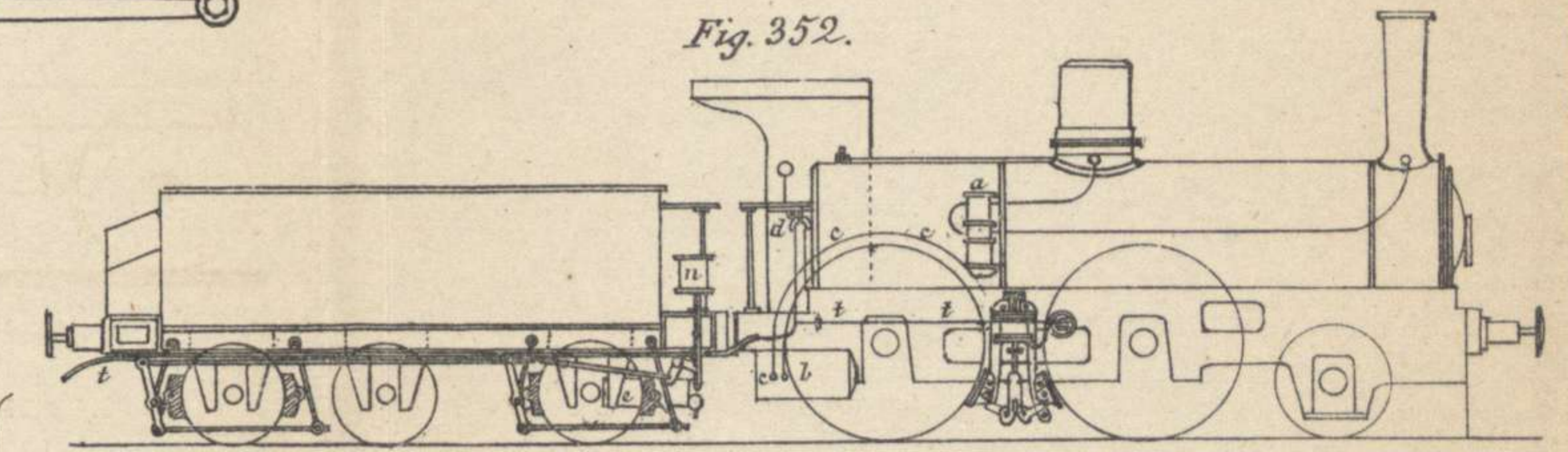
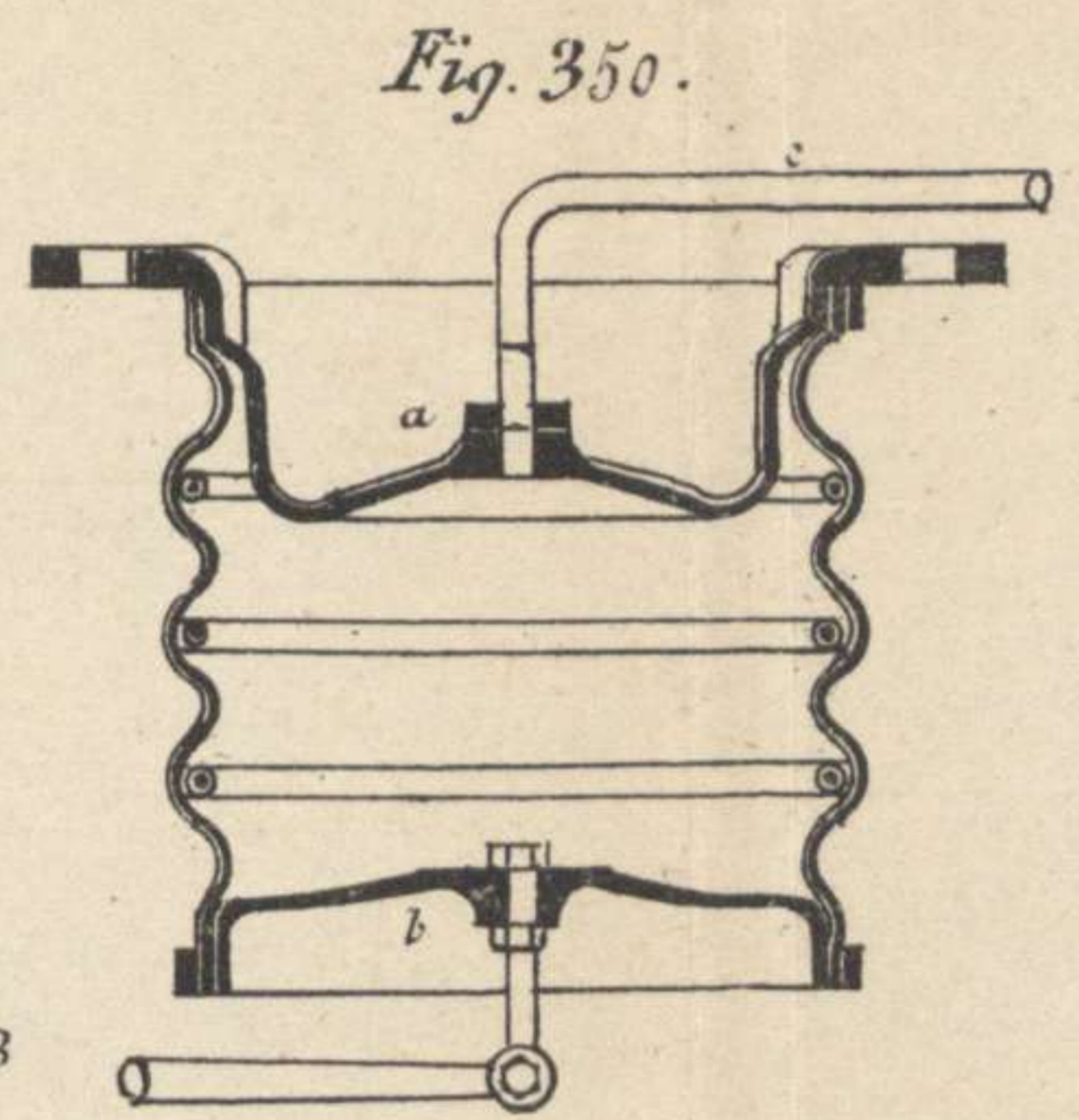
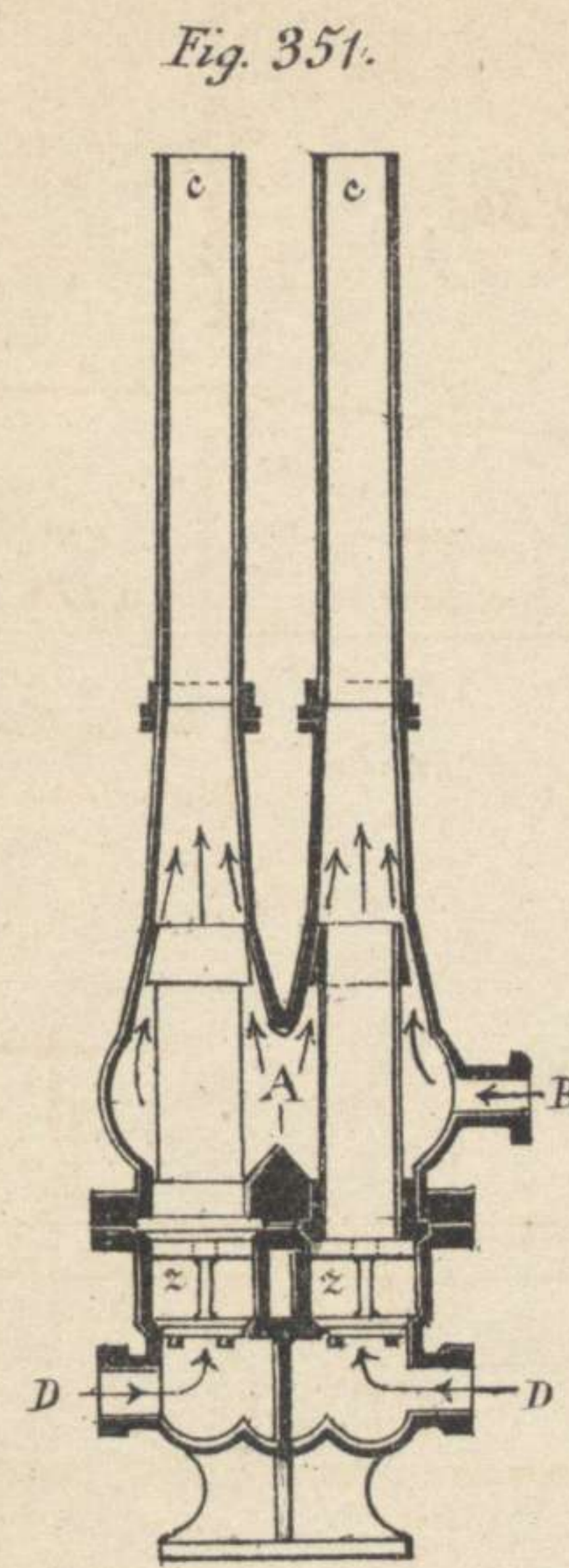
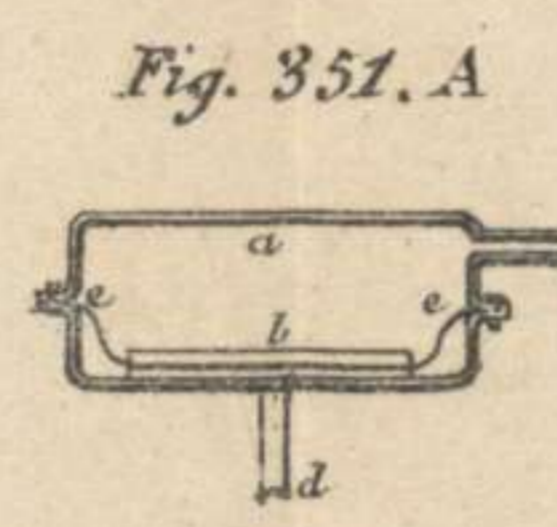

Fig. 347.

0,018	0,004	19	0	21	15	Horizontal	7
2300	1530	3500	760	350	1600		420

Fig. 347. A

0,018	7 ^m /m	0
2300	420	760



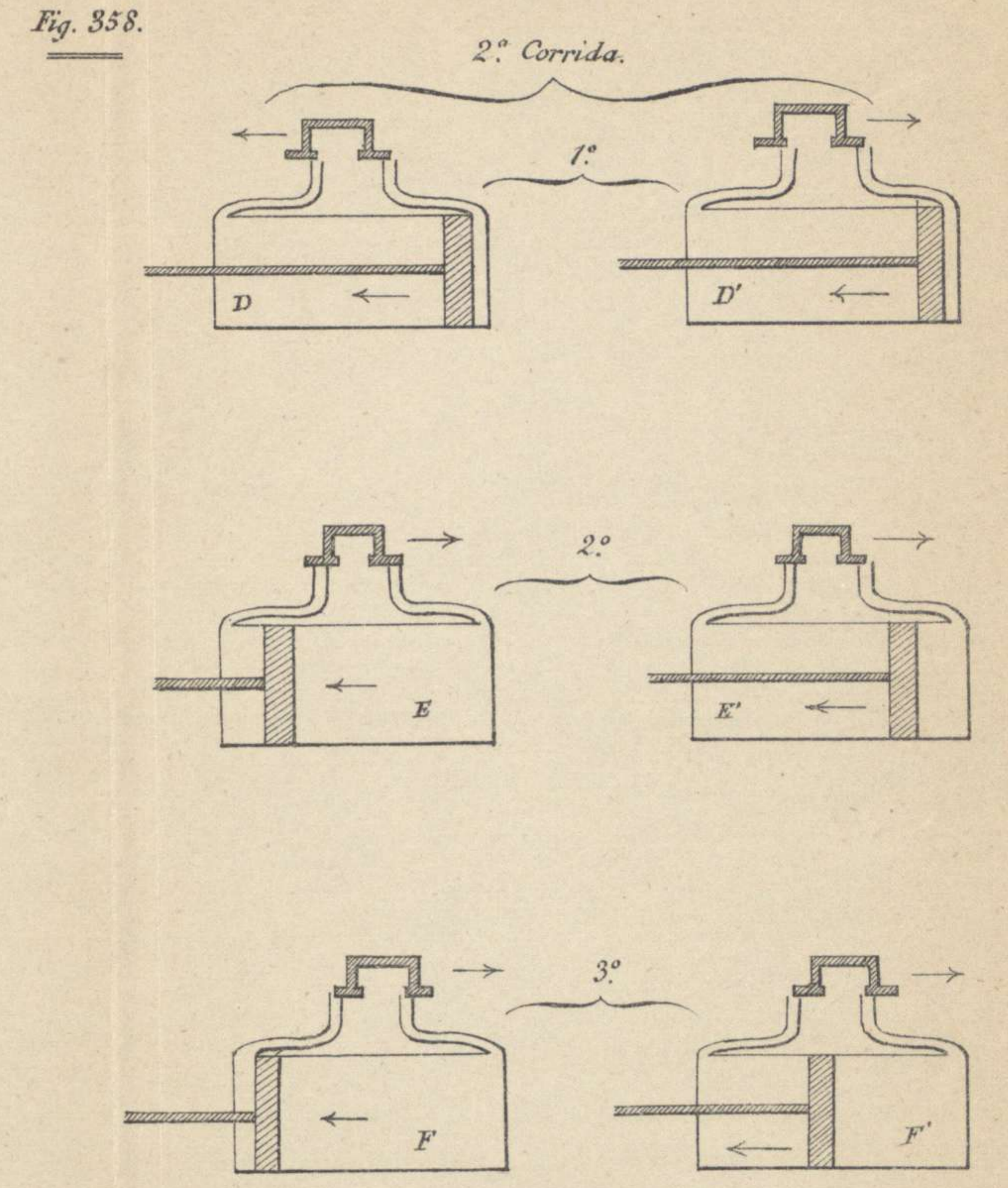
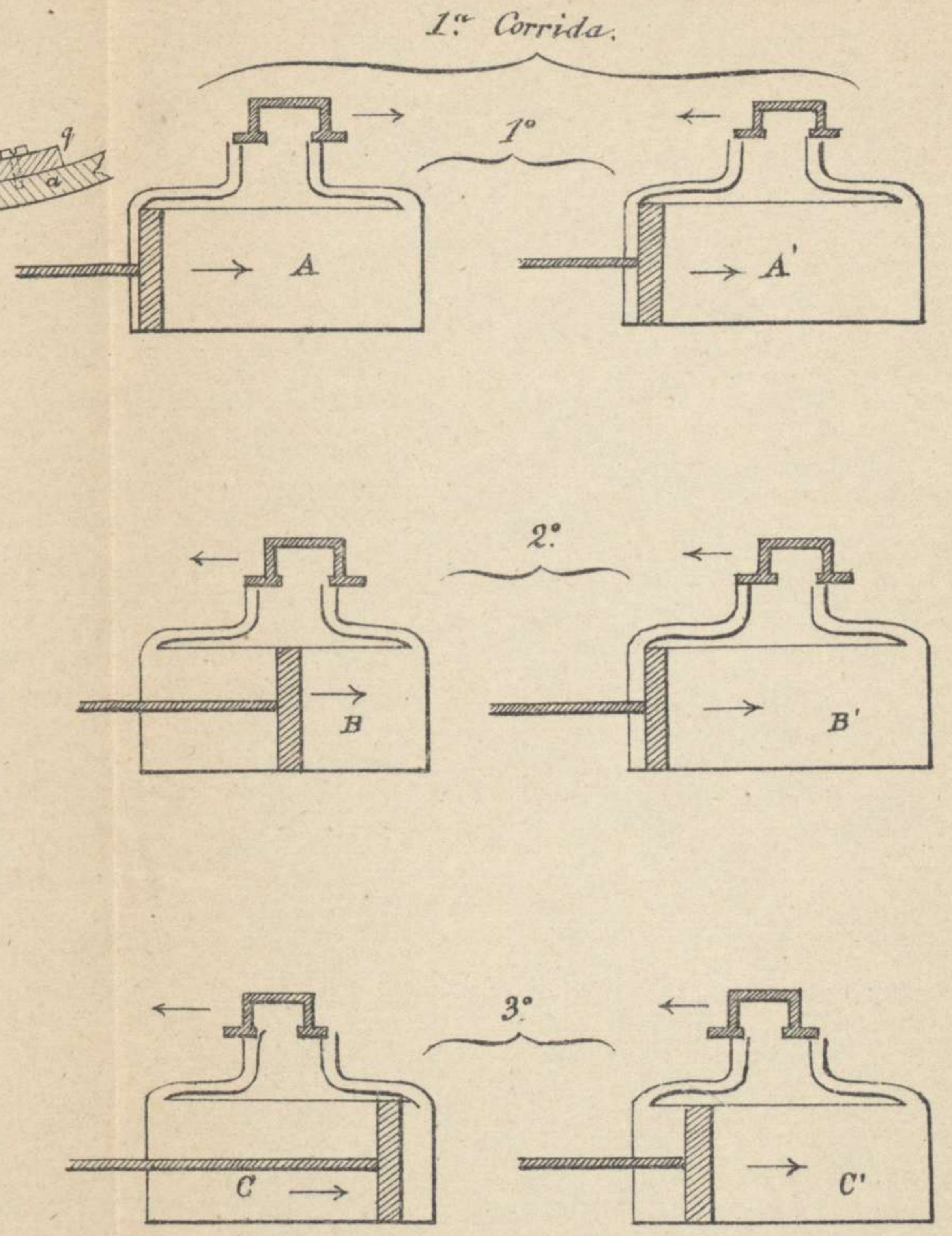
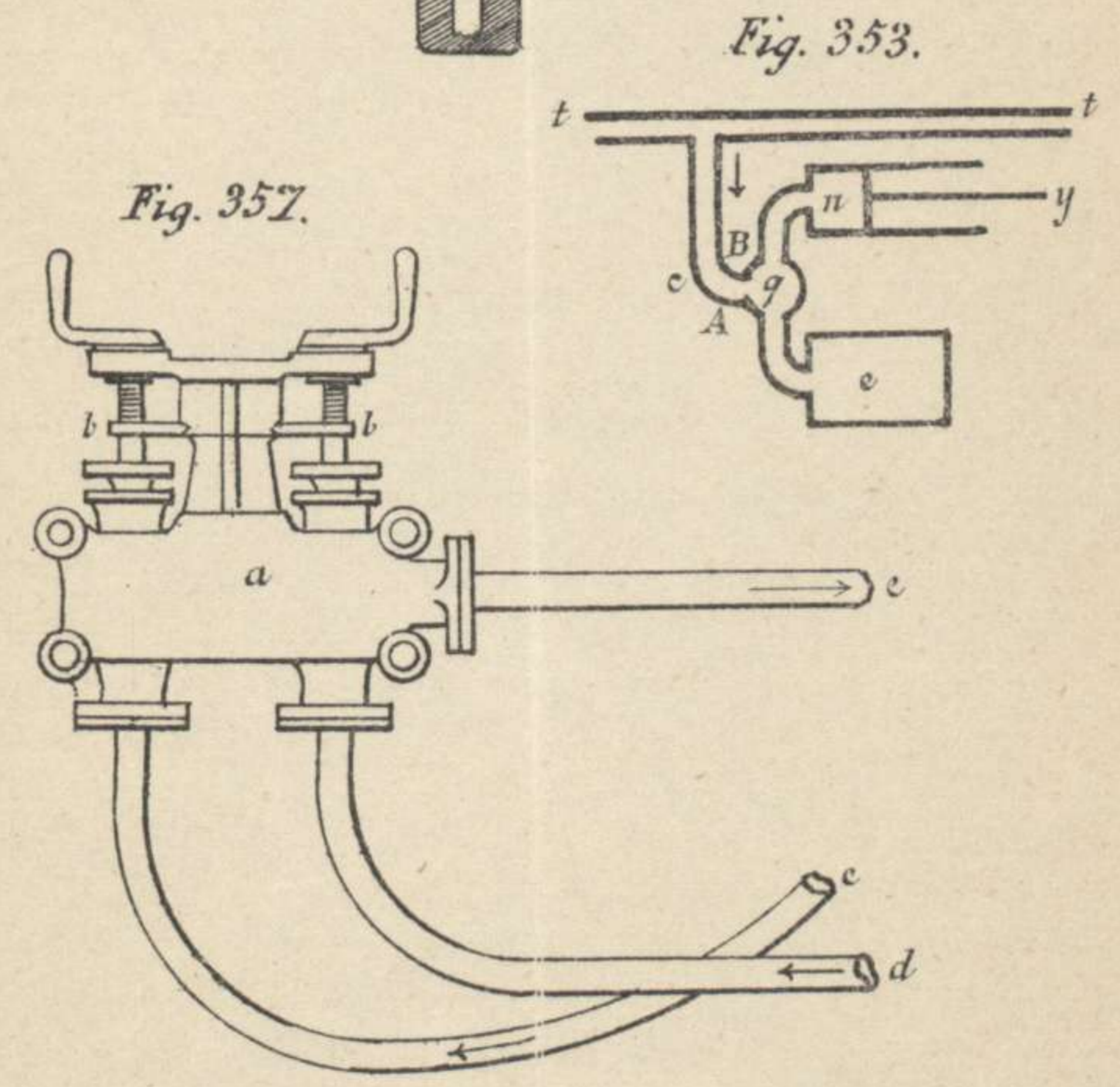
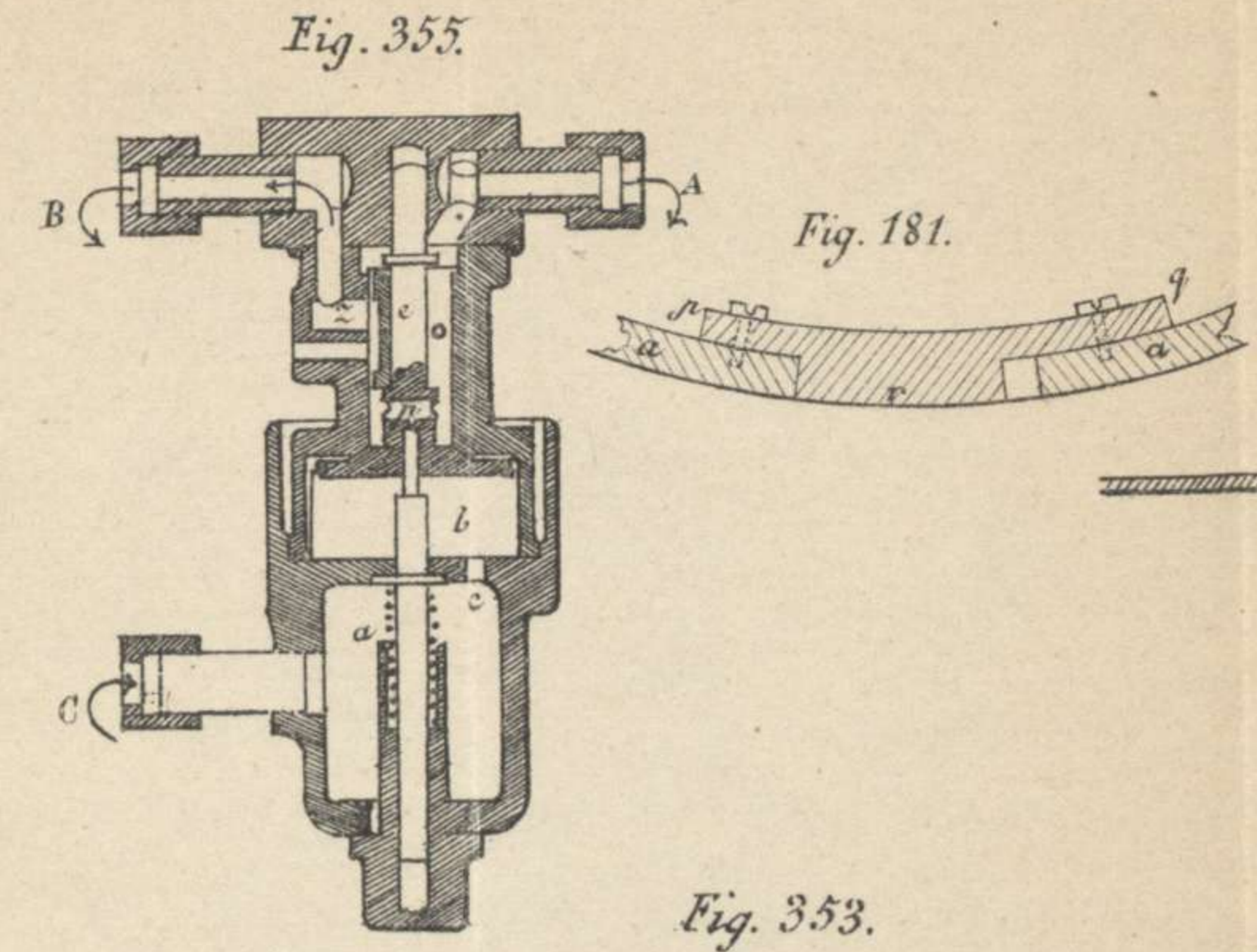
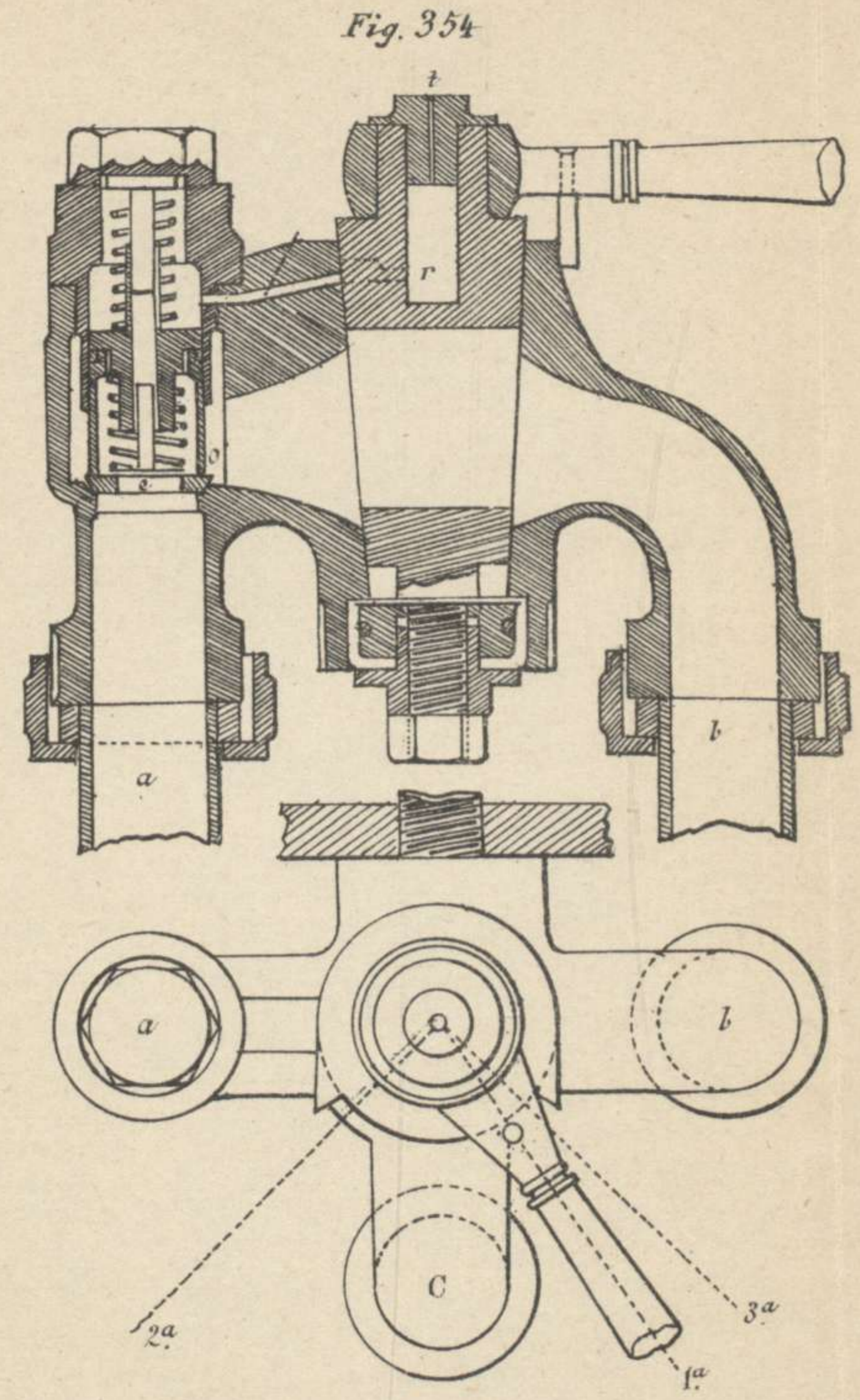

Locomotora-Tender para vía de un metro de anchura entre bordes interiores.
Elevación y Cortes.

Fig. 356.

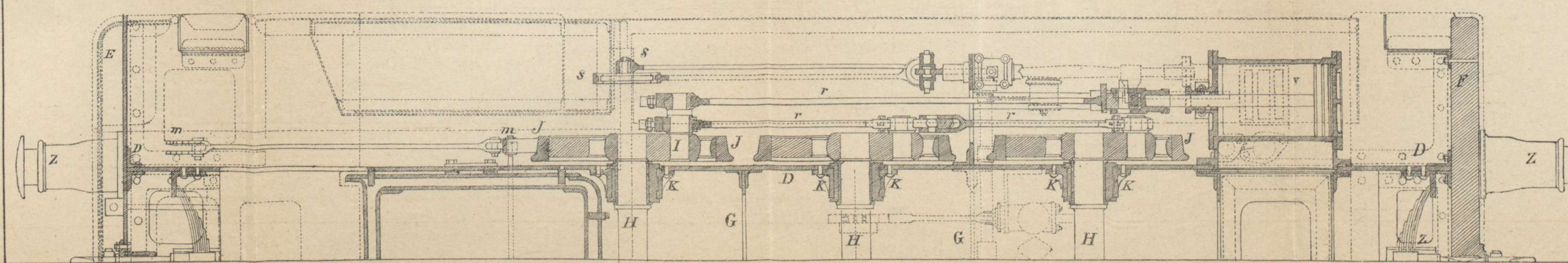
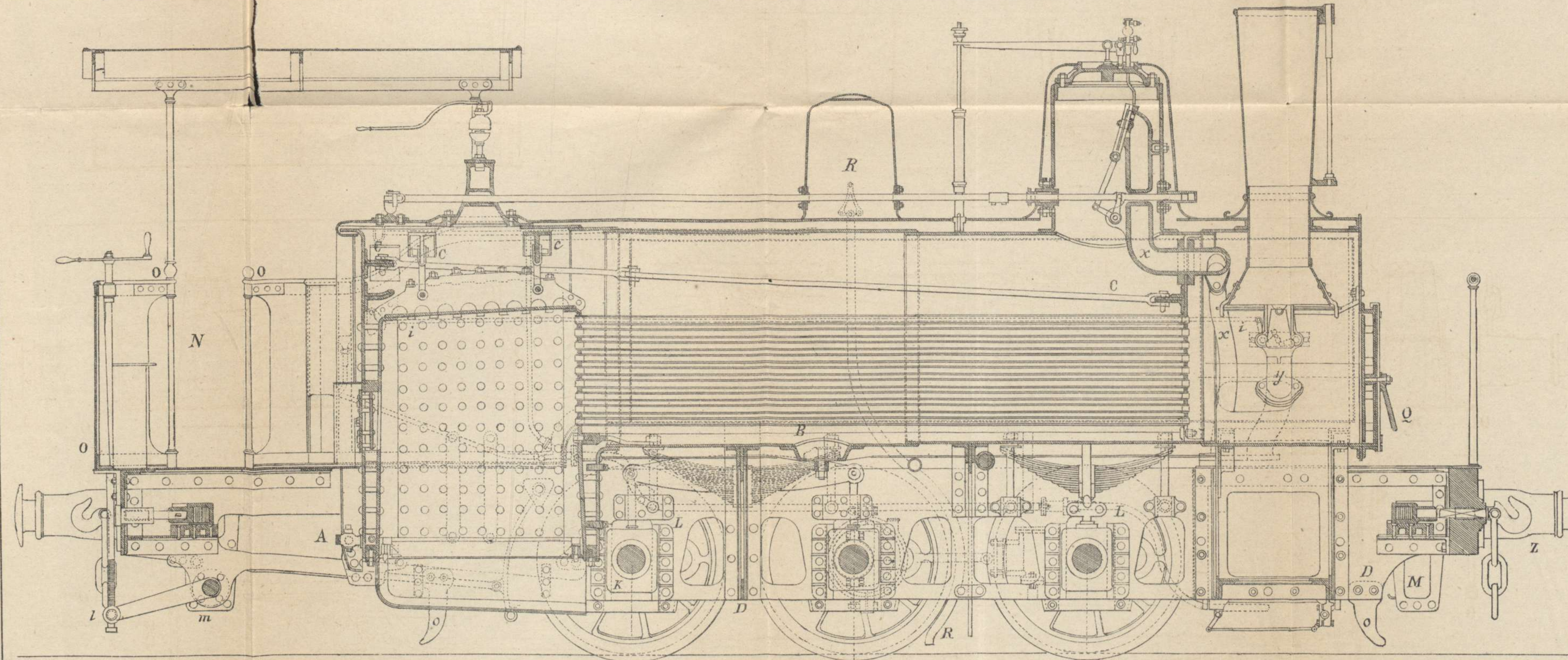
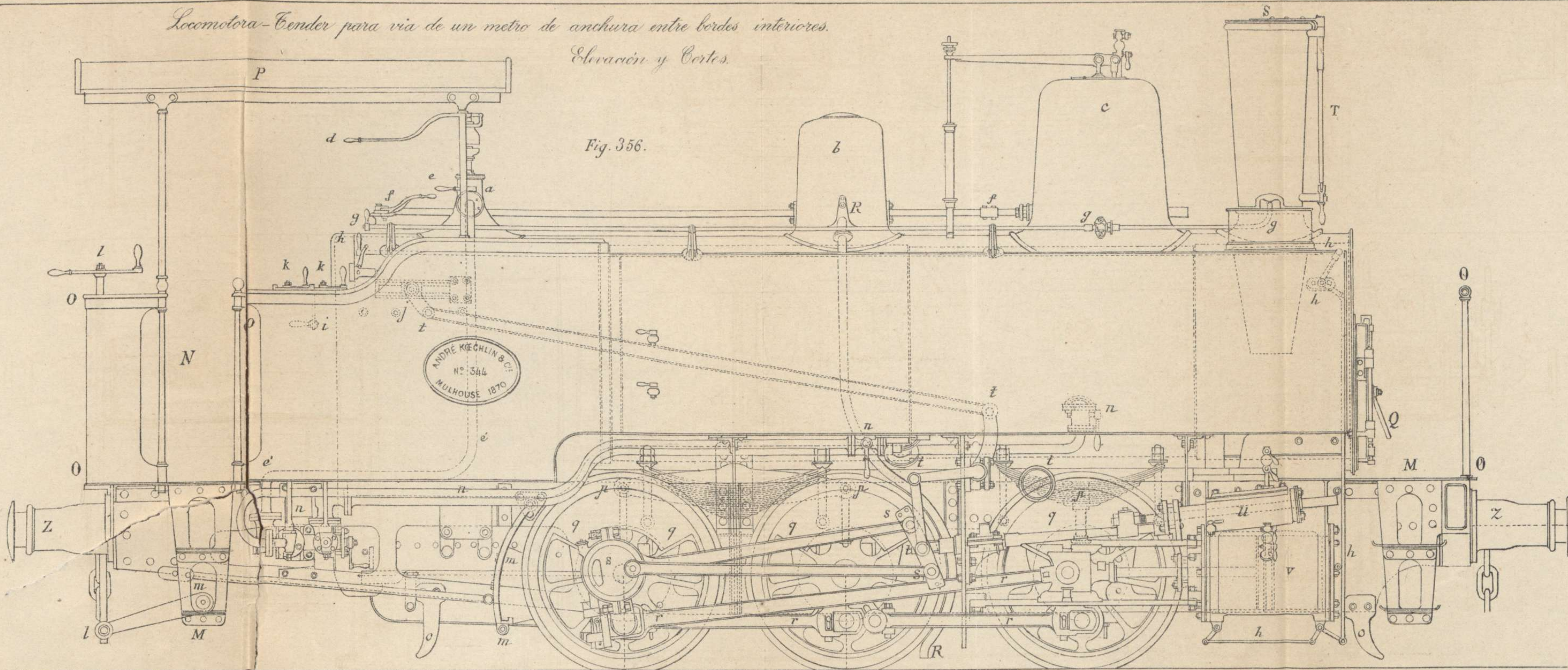

Locomotora para vía de 1^m450 de anchura entre bordes interiores.
Vista por detrás.

Fig. 359.

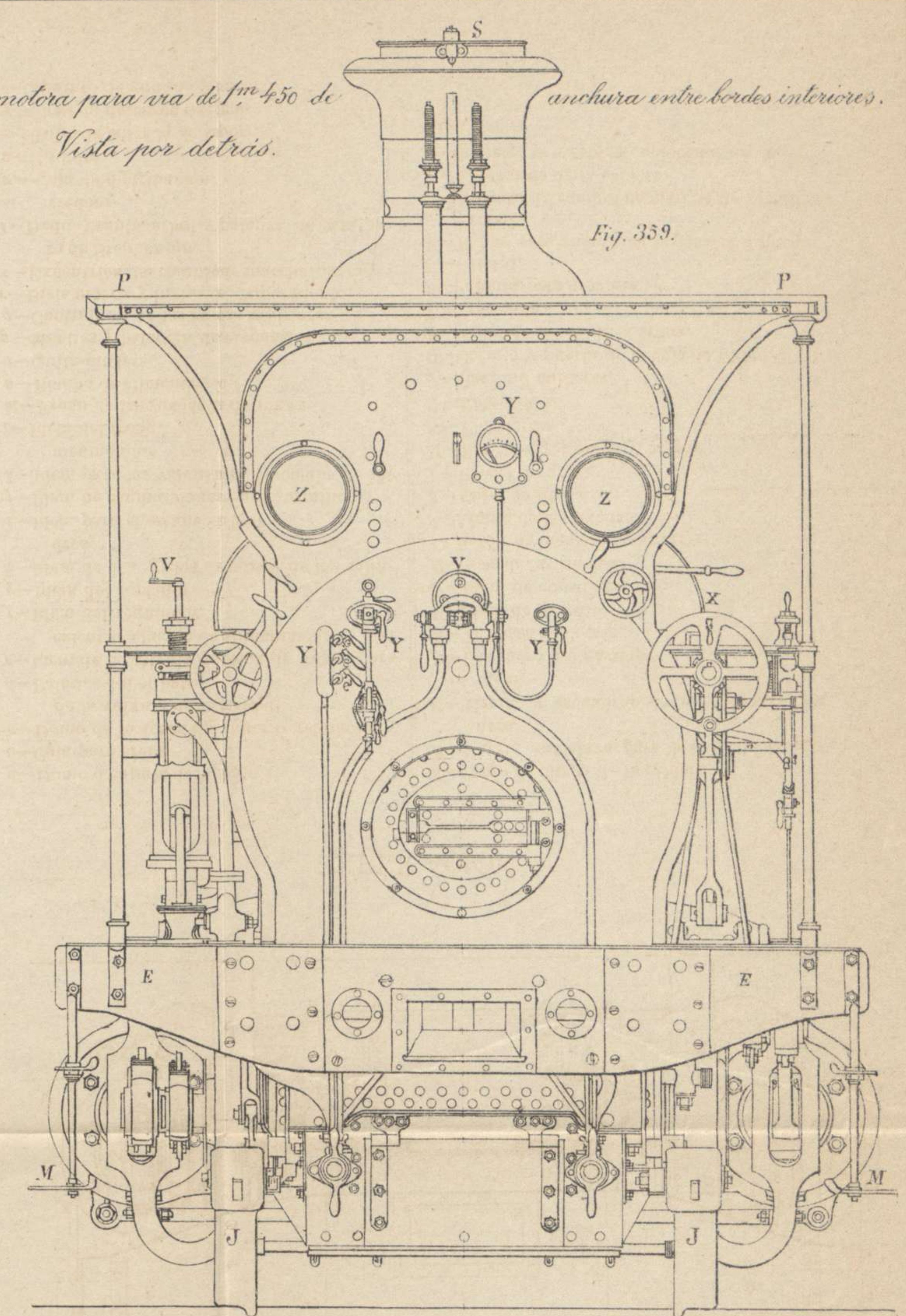

EXPLICACIÓN.

- a—Domo ó cúpula del silbato.
 - b—Caja para arena.
 - c—Domo de la toma de vapor ó regulador y de la válvula de seguridad.
 - d—Palanca del silbato.
 - e—Idem de la válvula de toma de vapor para calentar el agua de alimentación.
 - f—Idem del regulador.
 - g—Idem del soplador.
 - h—Idem de los gritos de purga de los cilindros.
 - i—Idem para el escape variable.
 - j—Idem de cambio de marcha á tornillo.
 - k—Idem para las válvulas de la bomba de alimentación.
 - l—Idem del freno.
 - m—Freno de las ruedas de detrás.
 - n—Bomba de alimentación.
 - o—Quita-piedras.
 - p—Muelles y balancín de suspensión
 - q—Contrapeso de las ruedas motrices.
 - r—Biela motriz y bielas de acoplamiento.
 - s—Excéntrica del cambio de marcha, corredera de Stephenson.
 - t—Dado, tirante, árbol y palanca de esta corredera.
 - u—Caja de distribución.
 - v—Cilindro.
 - x—Tubo de entrada de vapor.
 - y—Idem de descarga de idem.
 - z—Aparato de choque y tracción.
- A—Grifo de purga de la caldera.
 - B—Puerta autoclave para lavado de la caldera.
 - C—Tirante y escuadras de consolidación de idem.
 - D—Larguero del bastidor.
 - E—Travesa de detrás.
 - F—Idem de delante.
 - G—Idem de consolidación.
 - H—Ejes de las ruedas.
 - I—Botón de la manivela mptriz.
 - J—Llanta de las ruedas.
 - K—Cajas de grasa.
 - L—Placas de guía.
 - M—Estribos de subida y bajada.
 - N—Plataforma.
 - O—Antepecho.
 - P—Garita ó cubierta.
 - Q—Cerrojo y puerta de la caja de humos.
 - R—Tubo de salida de la arena.
 - S—Capuchón.
 - T—Palanca para moverla.
 - U—Giffard.
 - V—Tubos recalentadores y para la fumivoridad.
 - X—Aparato de cambio de marcha de tornillo.
 - Y—Accesorios de la caldera.
 - Z—Cristales protectores colocados en la visera.