

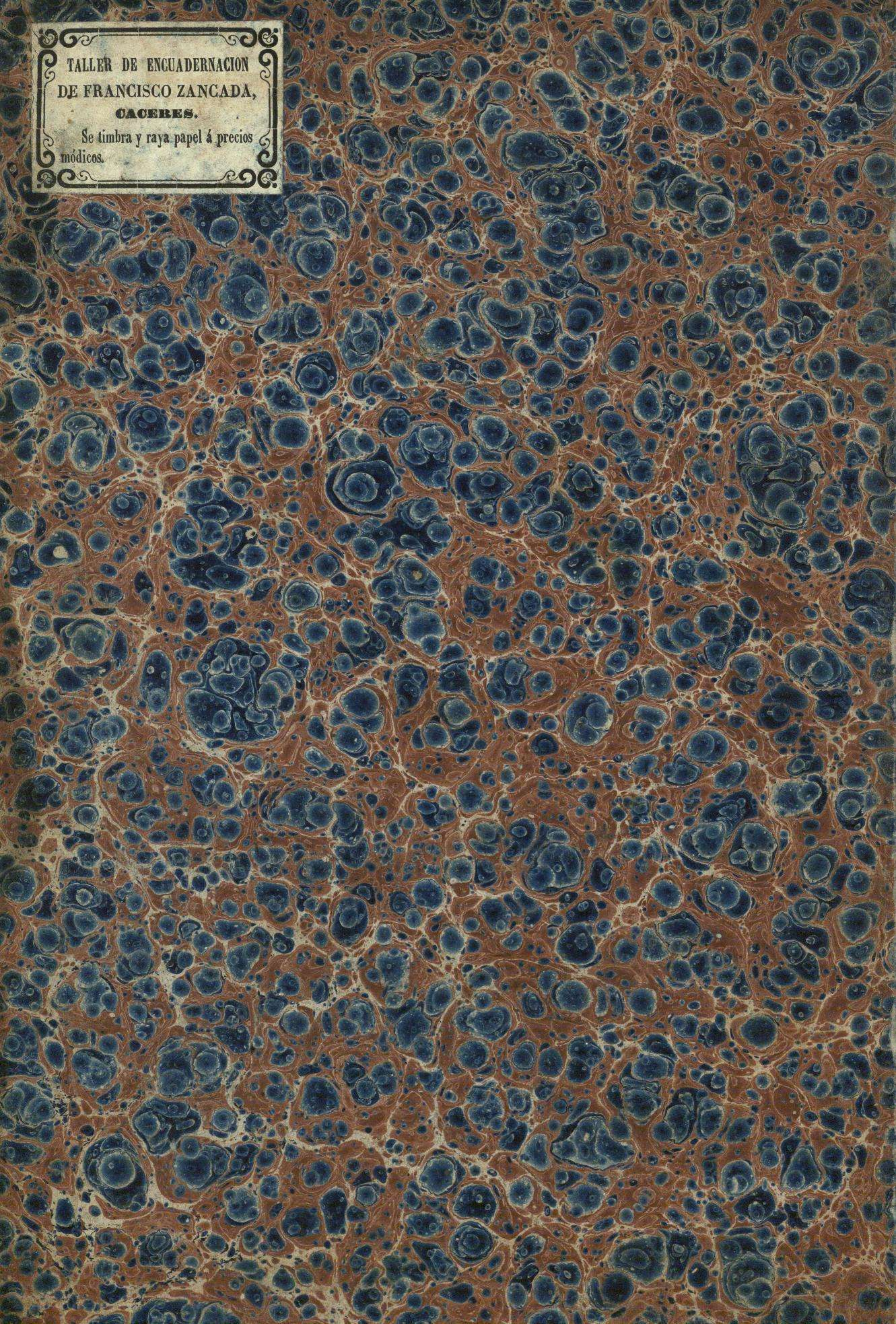


292

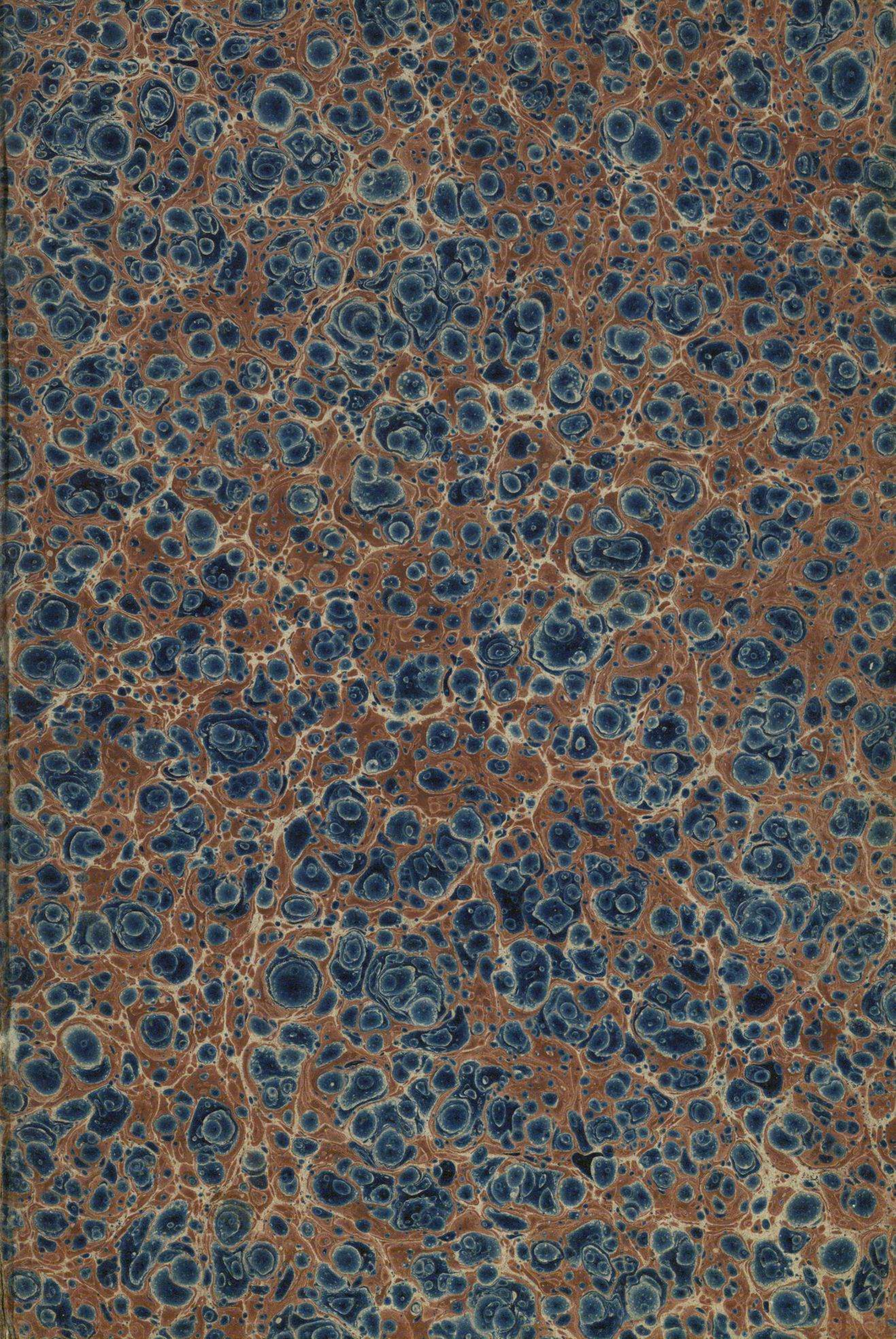


TALLER DE ENCUADERNACION  
DE FRANCISCO ZANCADA,  
CACERES.

Se timbra y raya papel á precios  
módicos.









2  
102792-



lit. 58362

Gl. 1064491

MADRID 1881









1874

# ATLAS

DEL

## DICCIONARIO DE AGRICULTURA PRACTICA Y ECONOMIA RURAL,

Publicado bajo la direccion

DEL

Exmo. Sr. D. Agustin Esteban Collantes  
y D. Agustin Colfaro

MADRID 1855.





1852

WILLIAM & ANNE

WILLIAM & ANNE

WILLIAM & ANNE



WILLIAM & ANNE

WILLIAM & ANNE

WILLIAM & ANNE





# Diccionario de Agricultura.

Fig. 1.



Fig. 2.



Fig. 3.

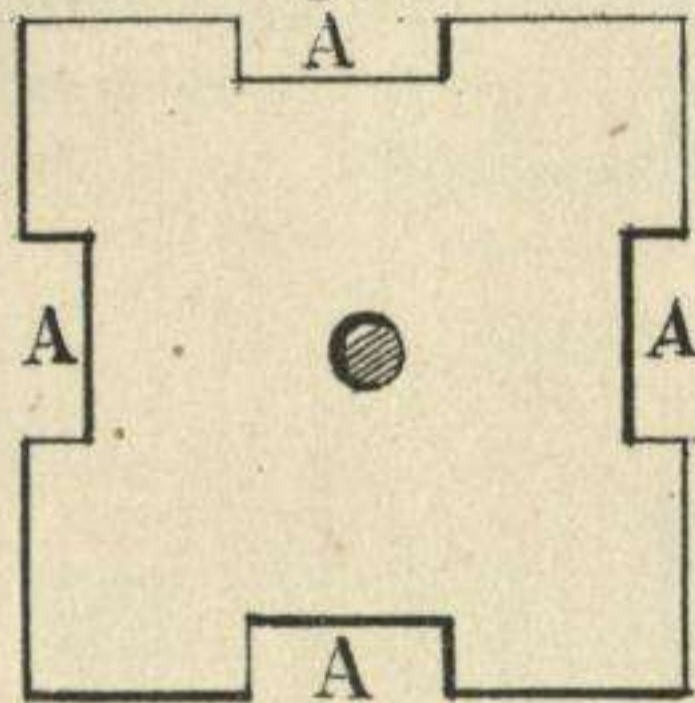


Fig. 4.

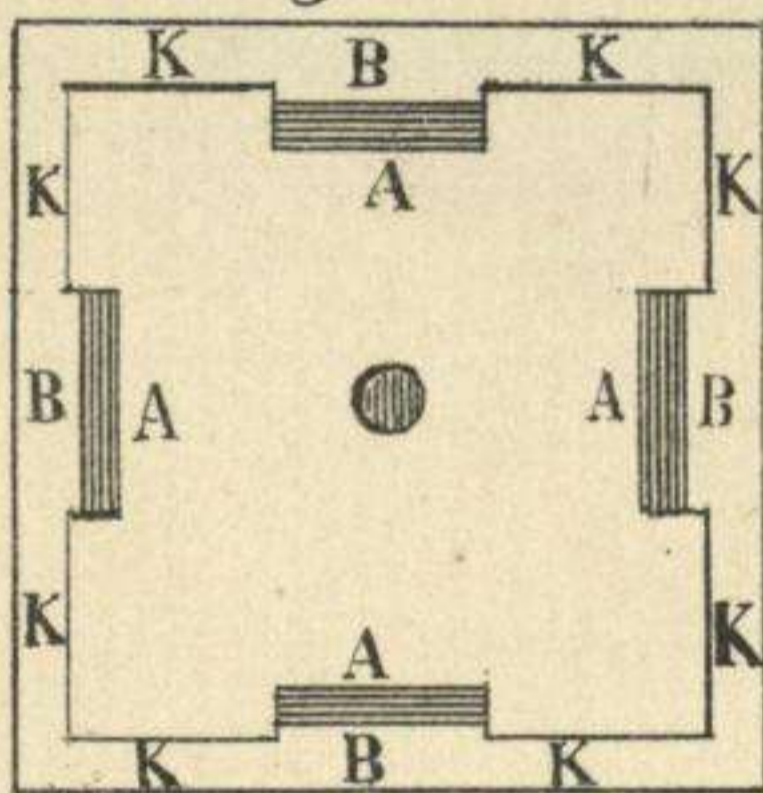


Fig. 5.

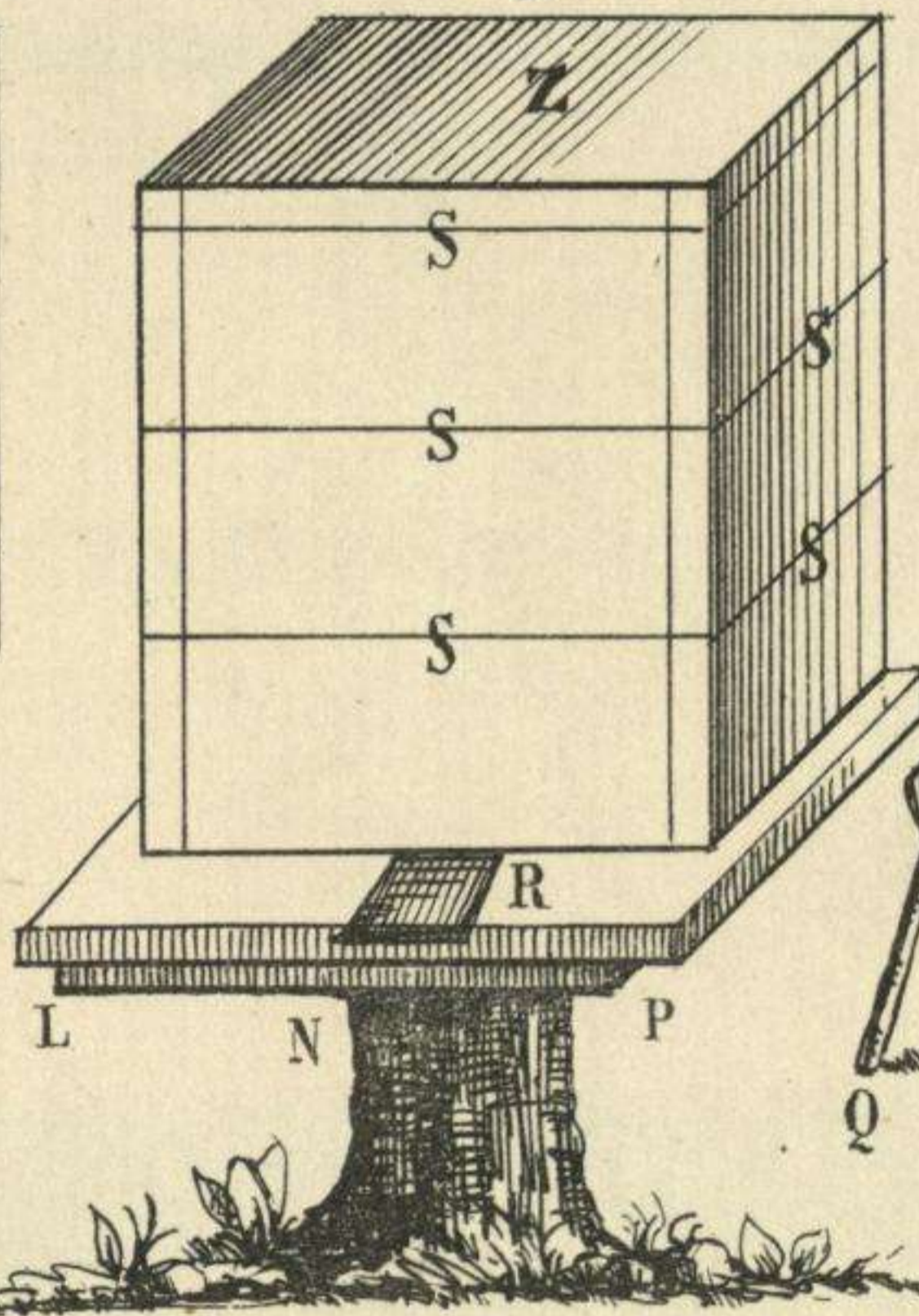


Fig. 6.

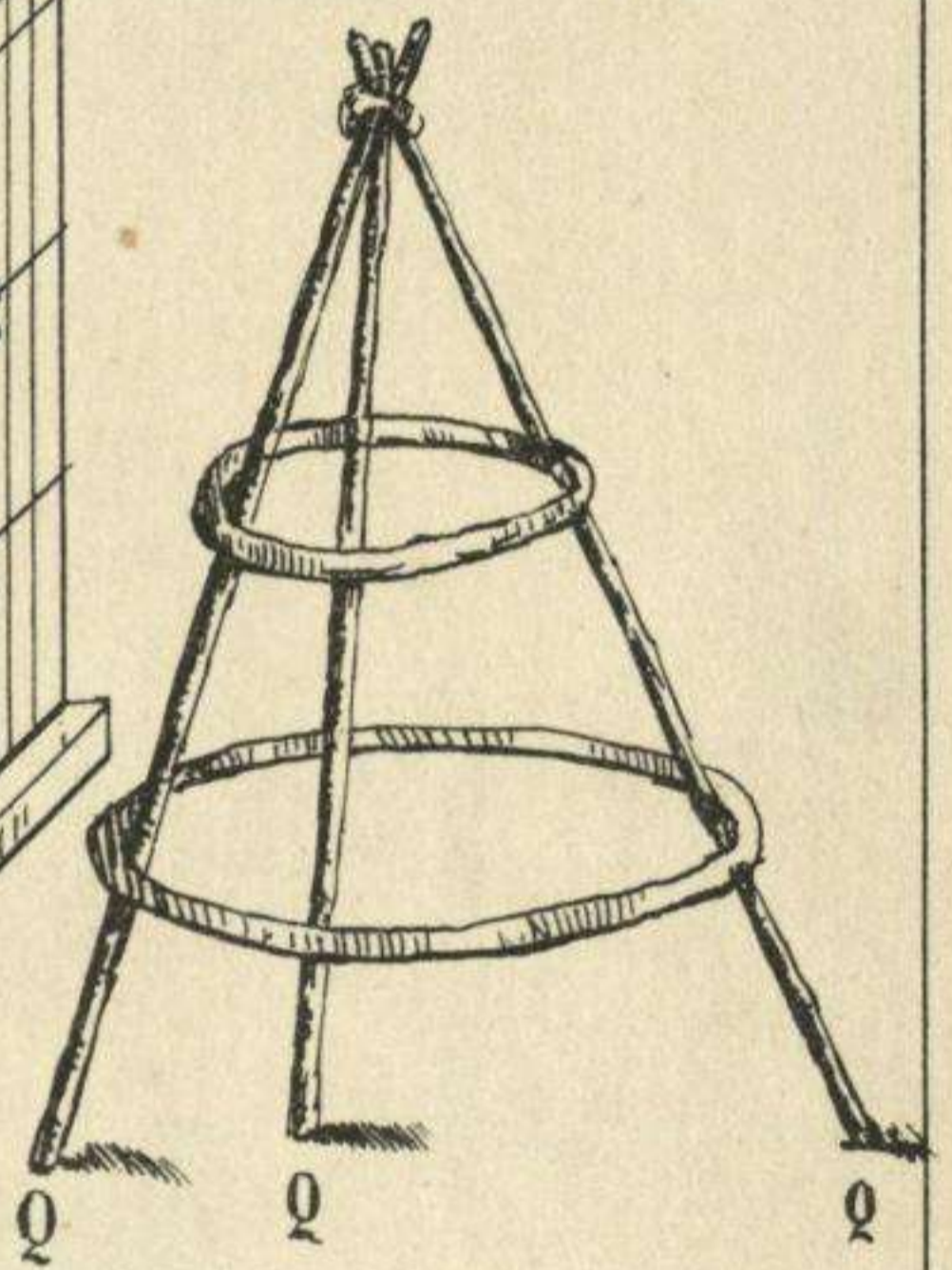


Fig. 9.

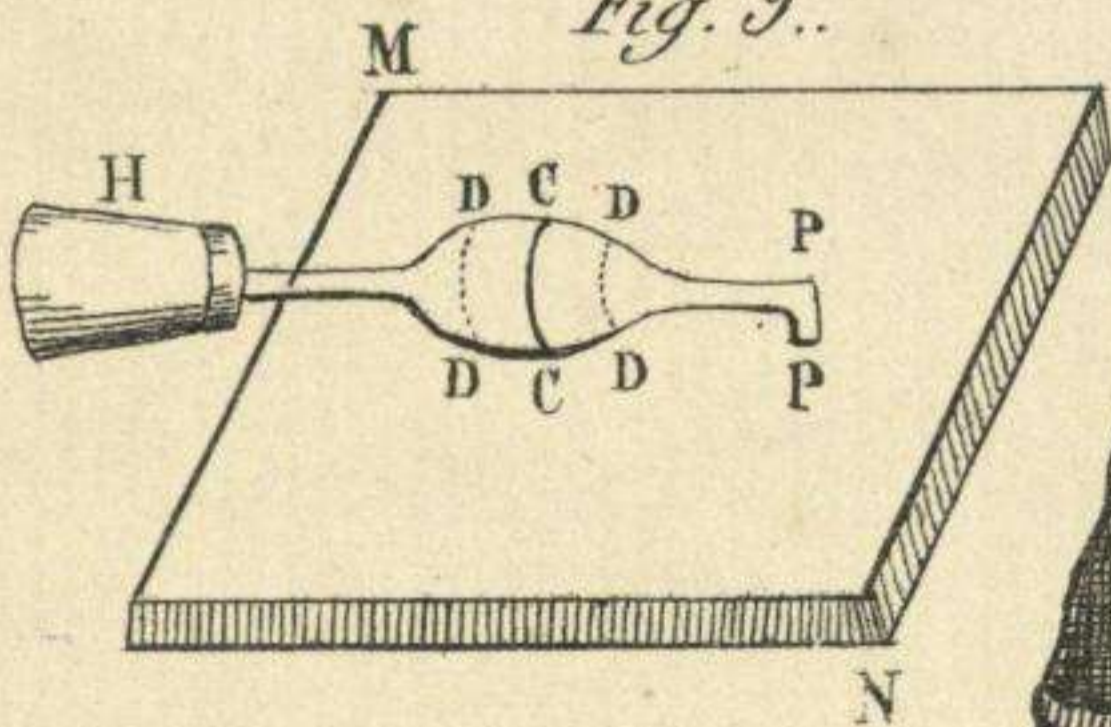


Fig. 8.

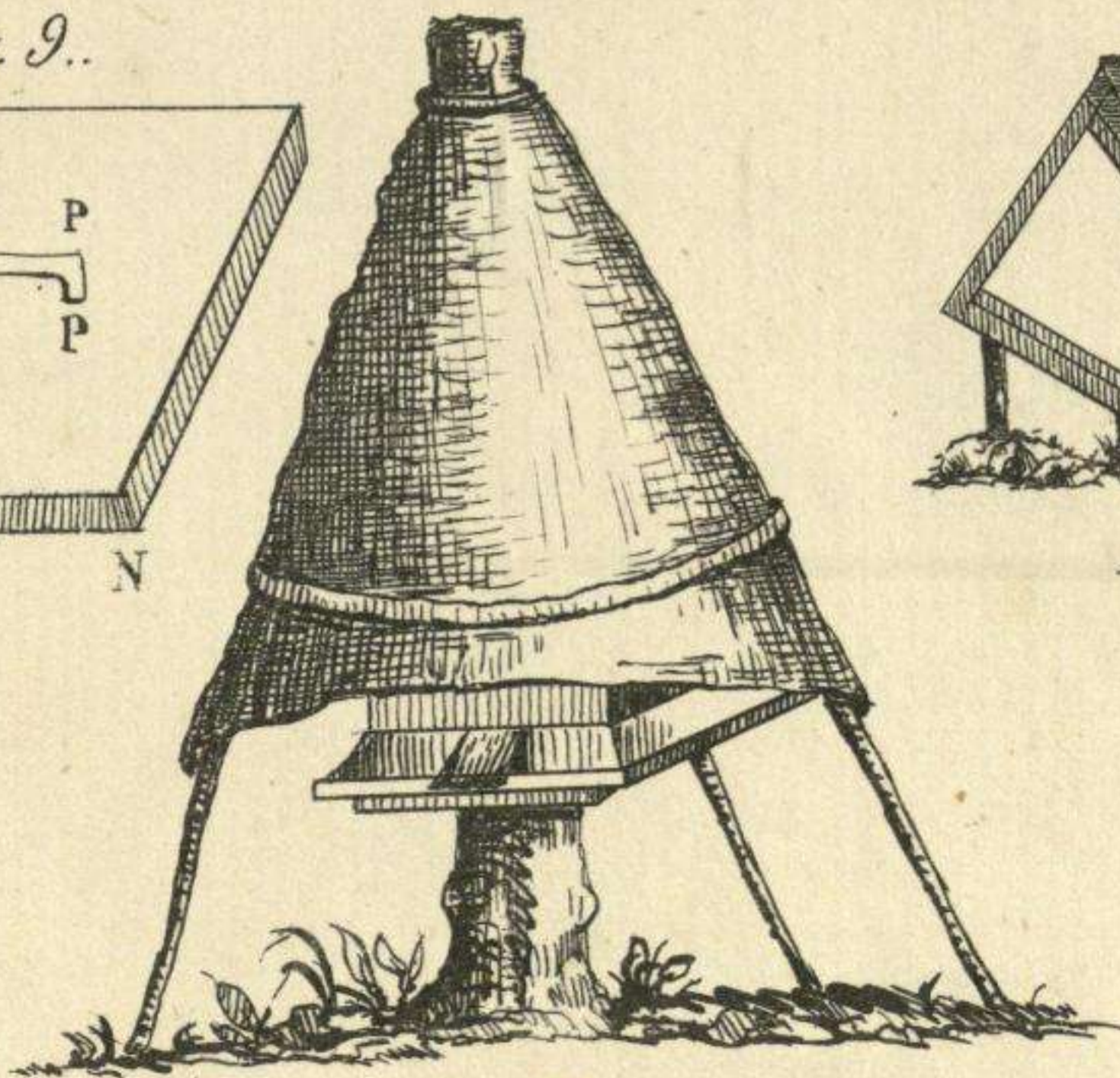
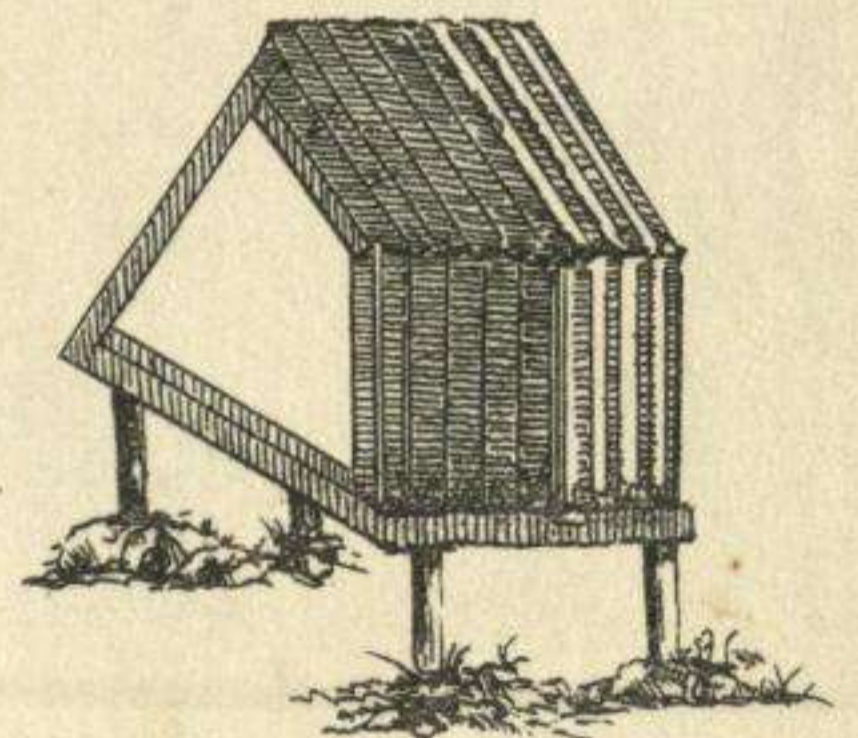


Fig. 7.







# Diccionario de Agricultura.

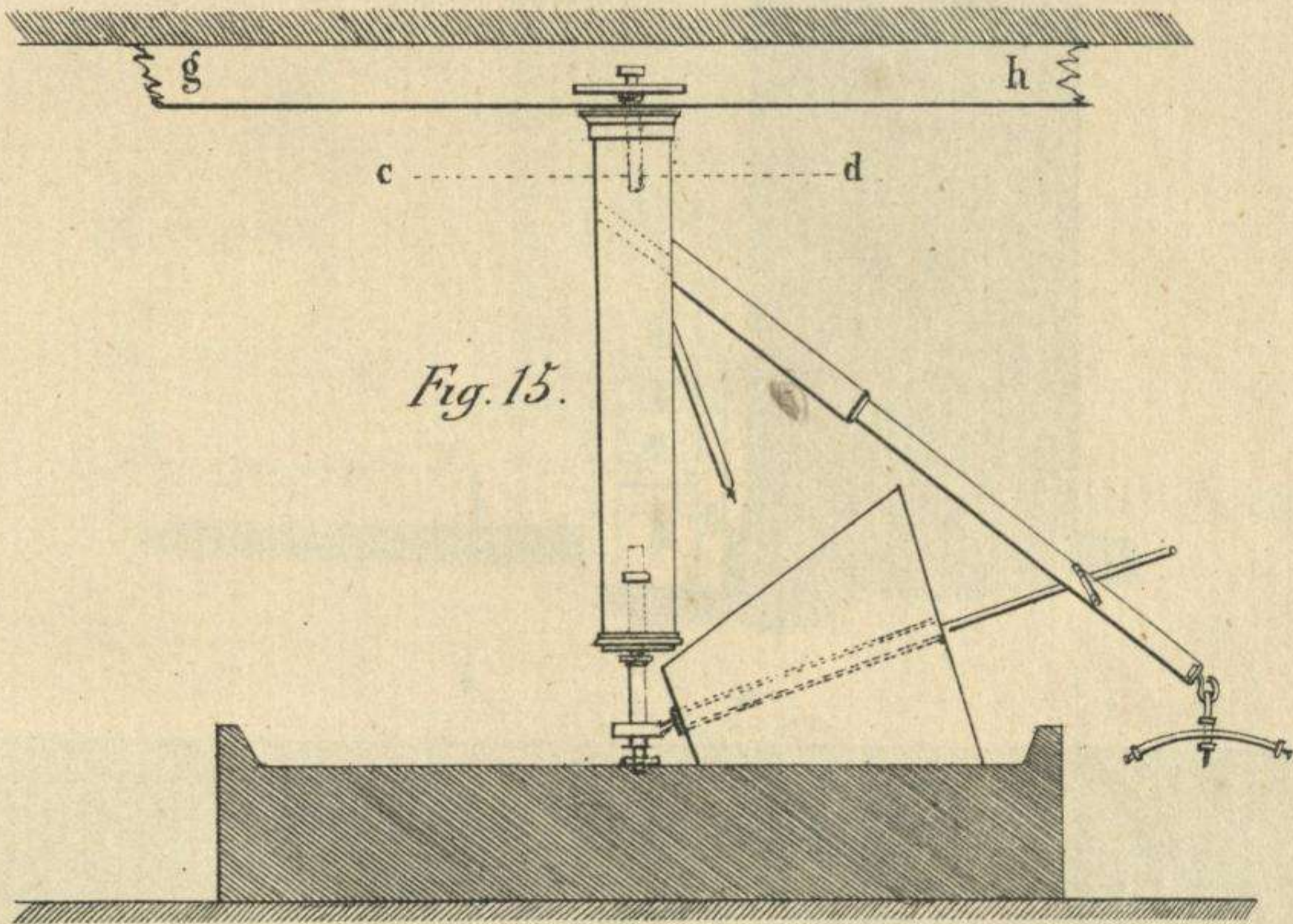
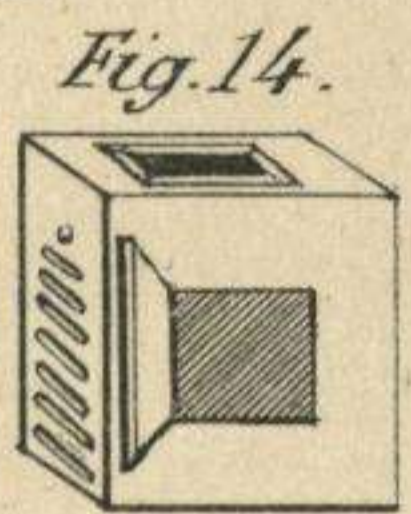
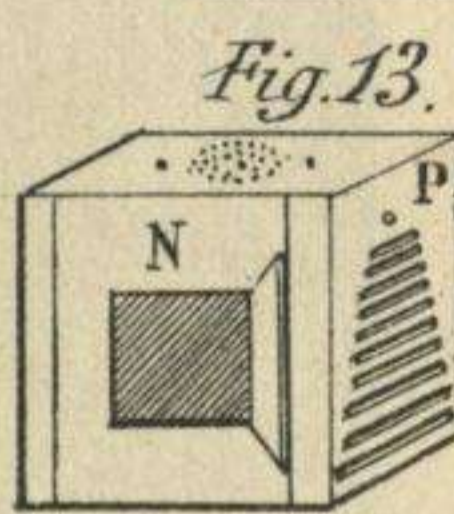
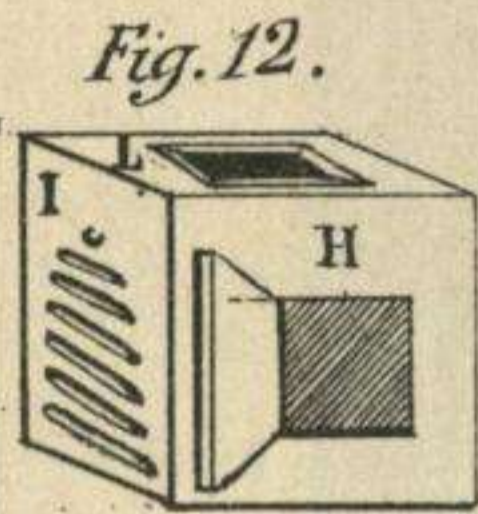
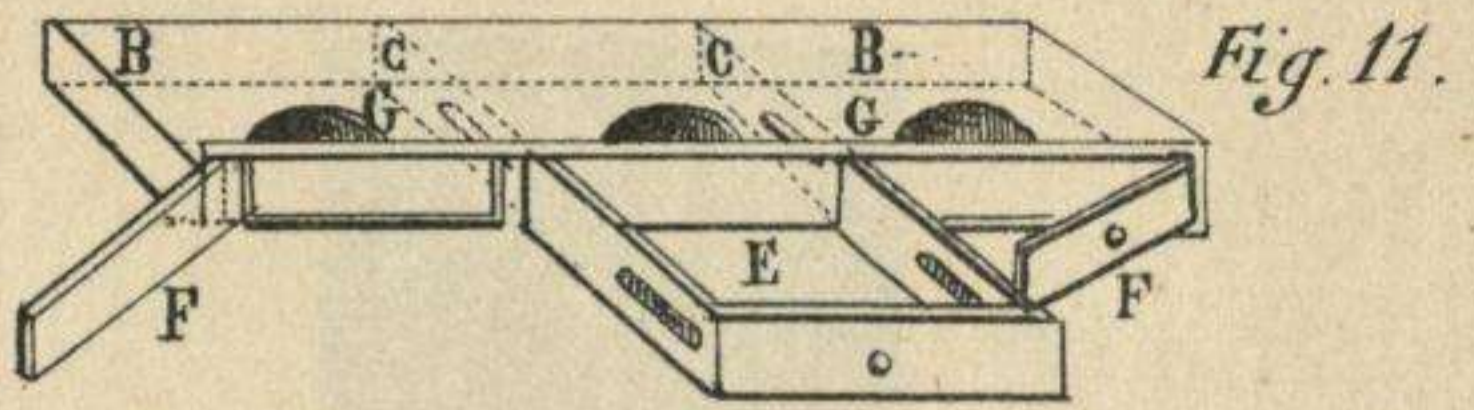
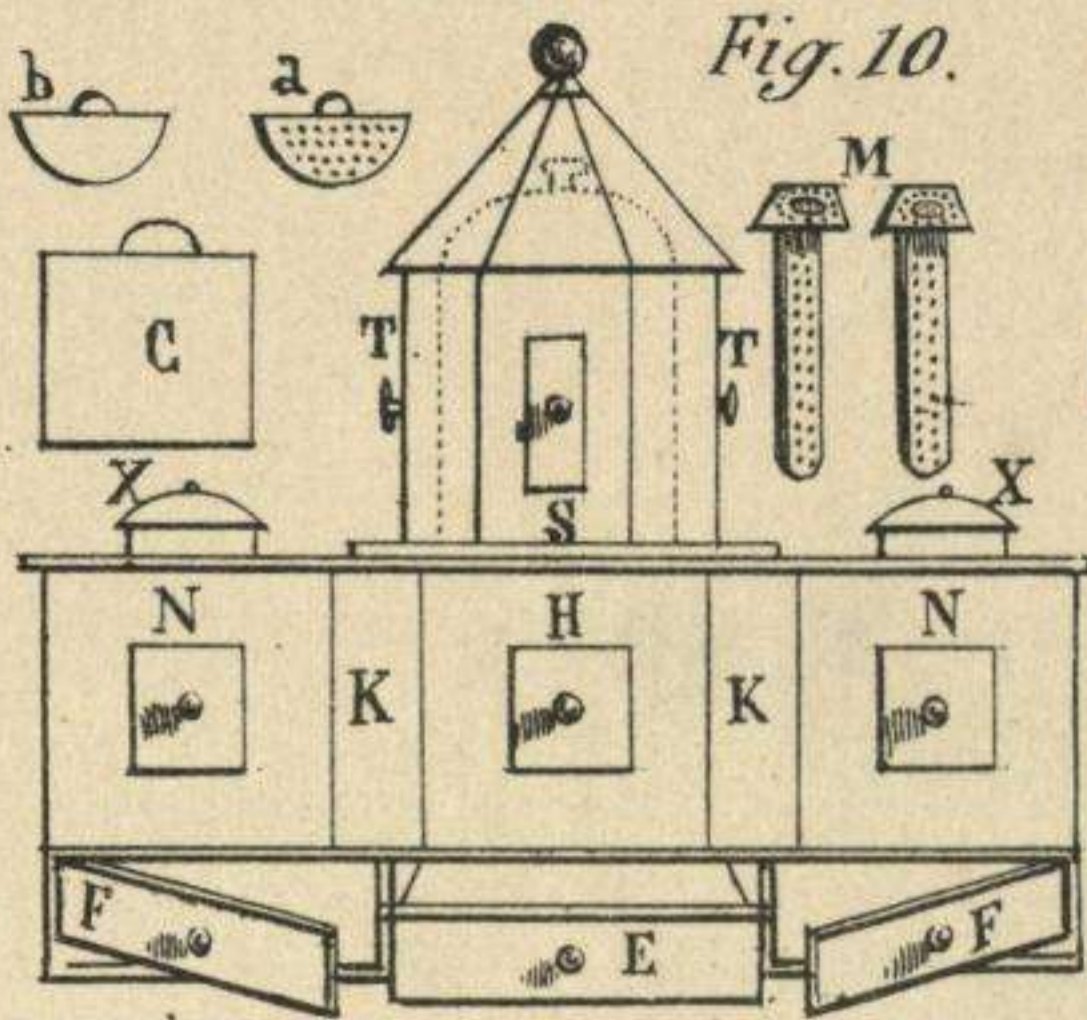


Fig. 16.

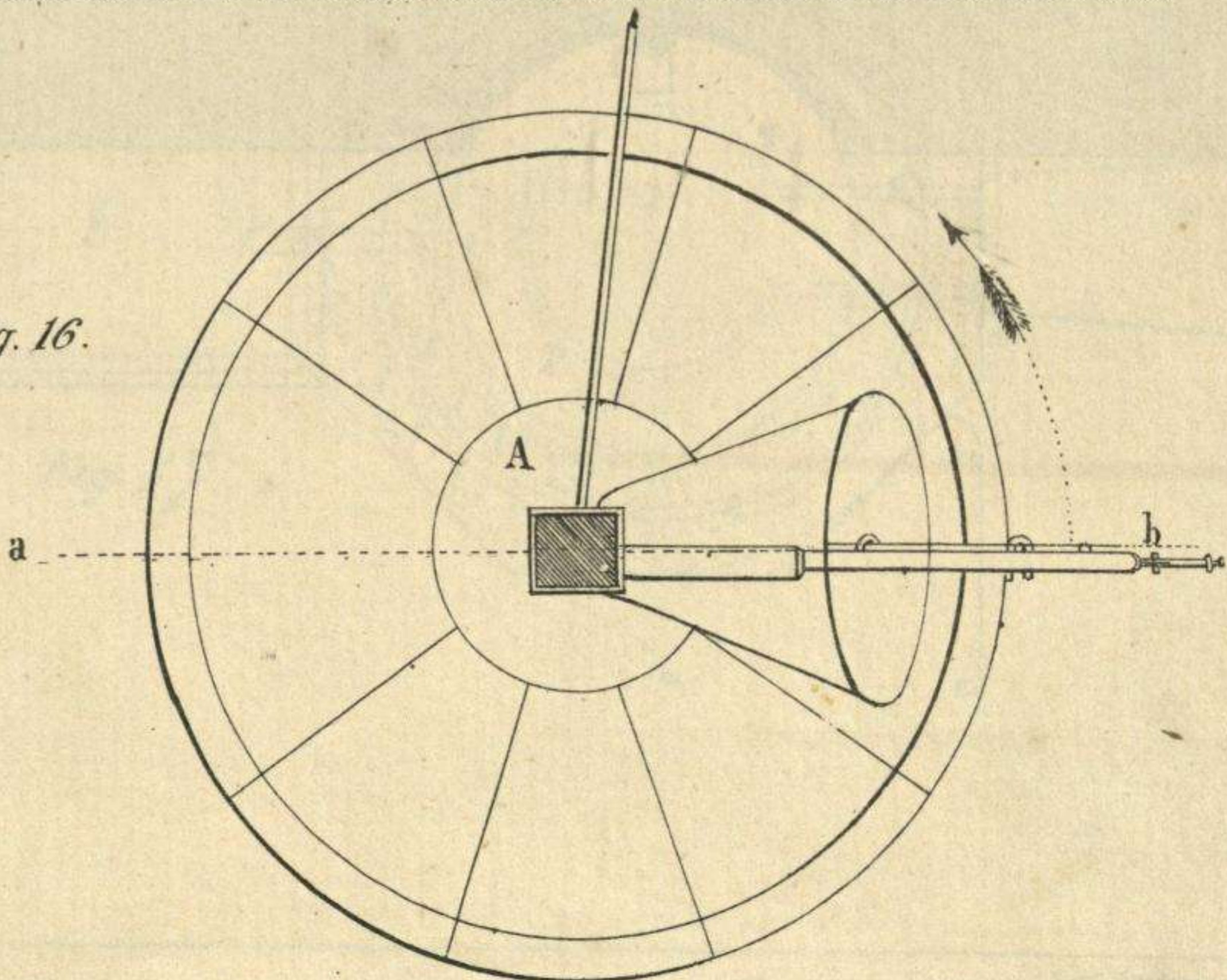








Fig. 18.

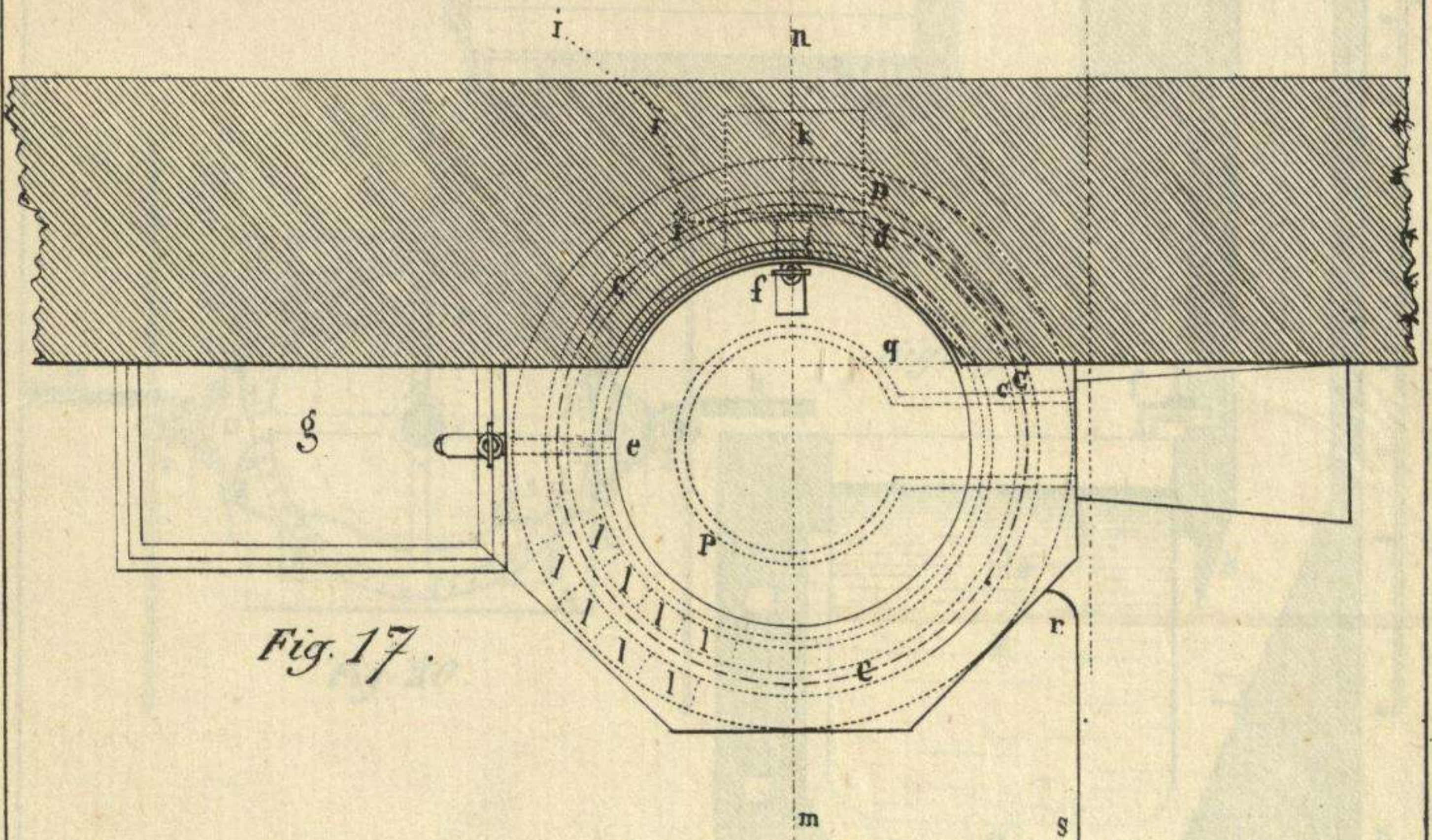
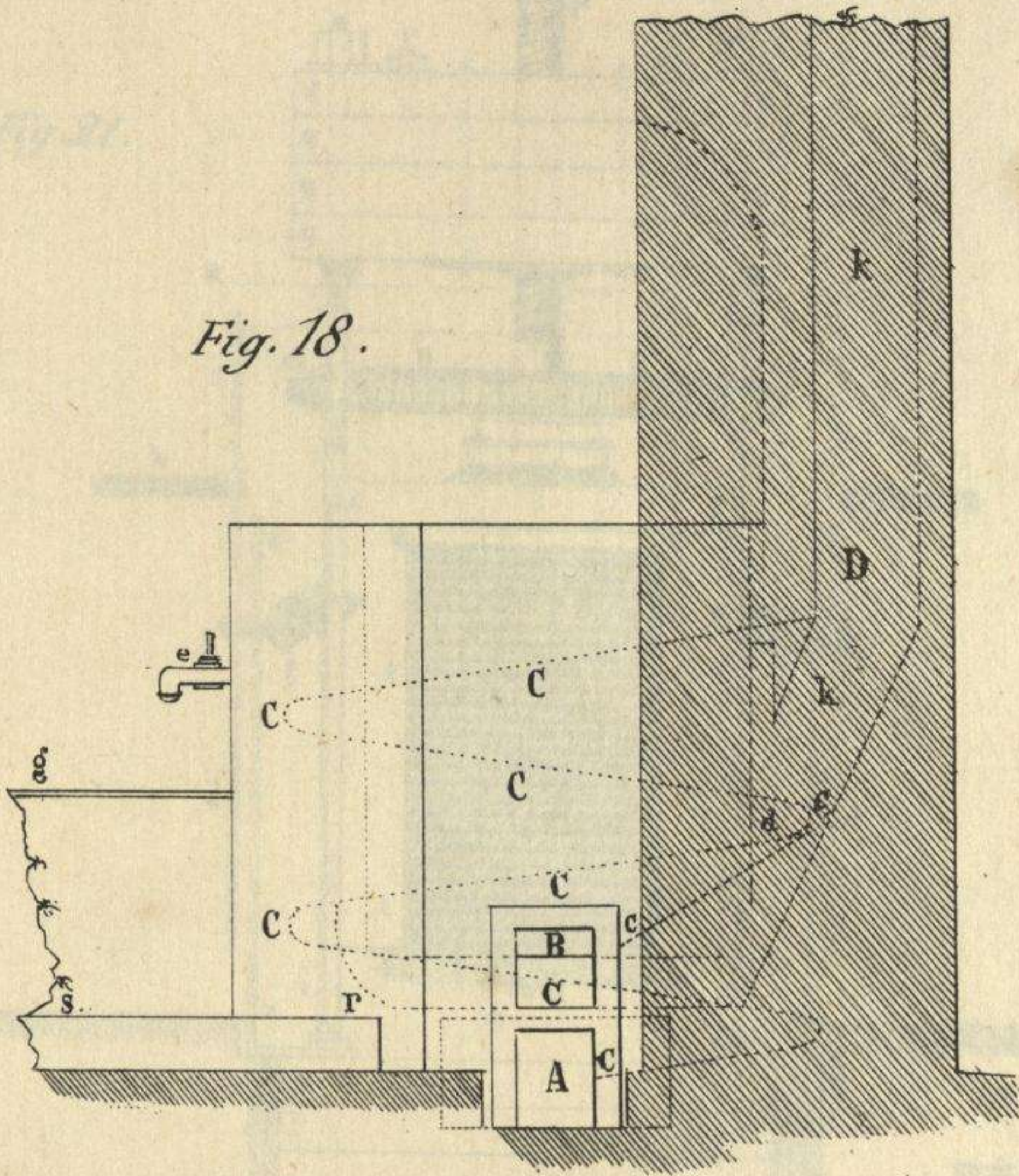


Fig. 17.







Fig. 21.

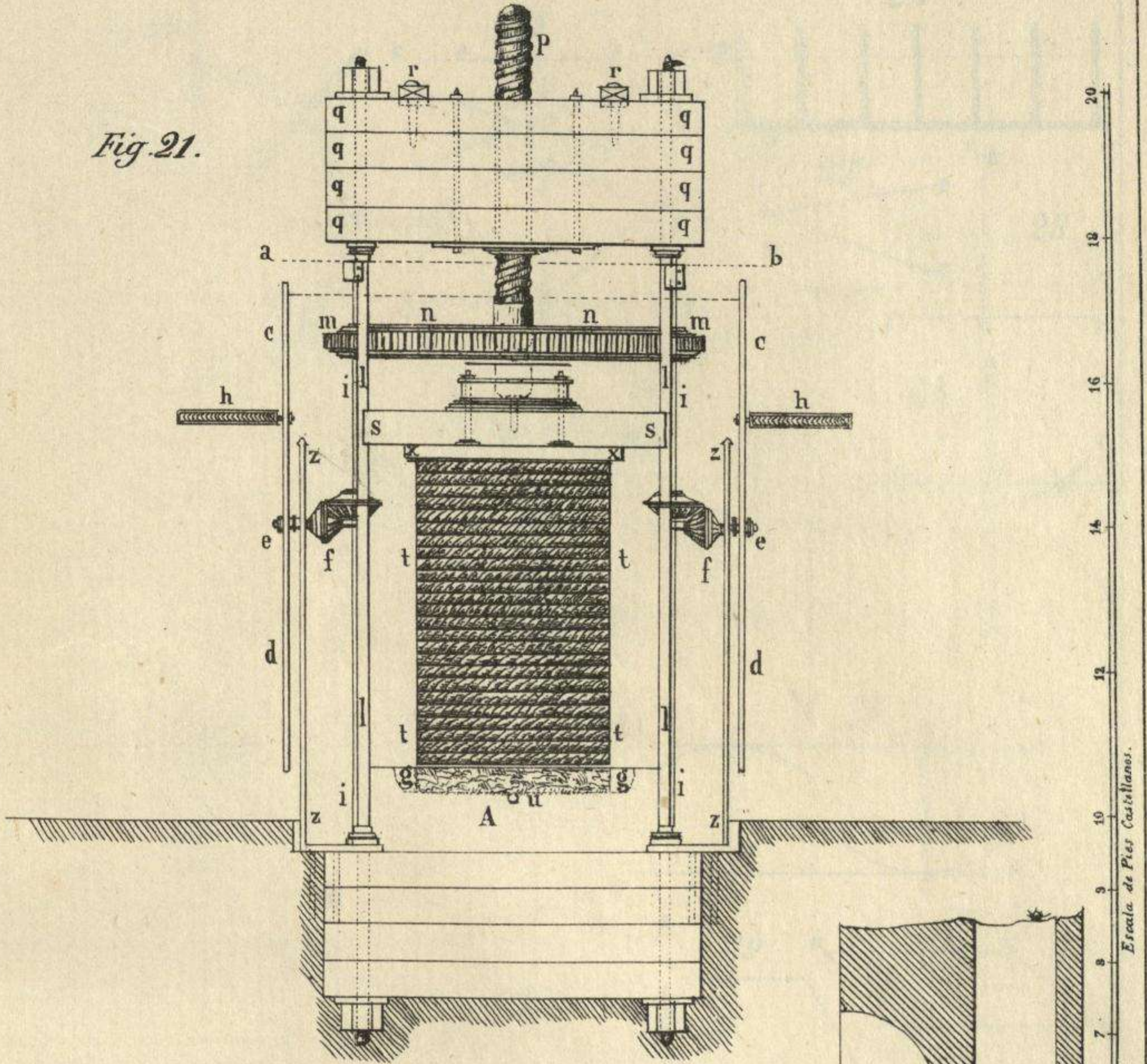


Fig. 19.

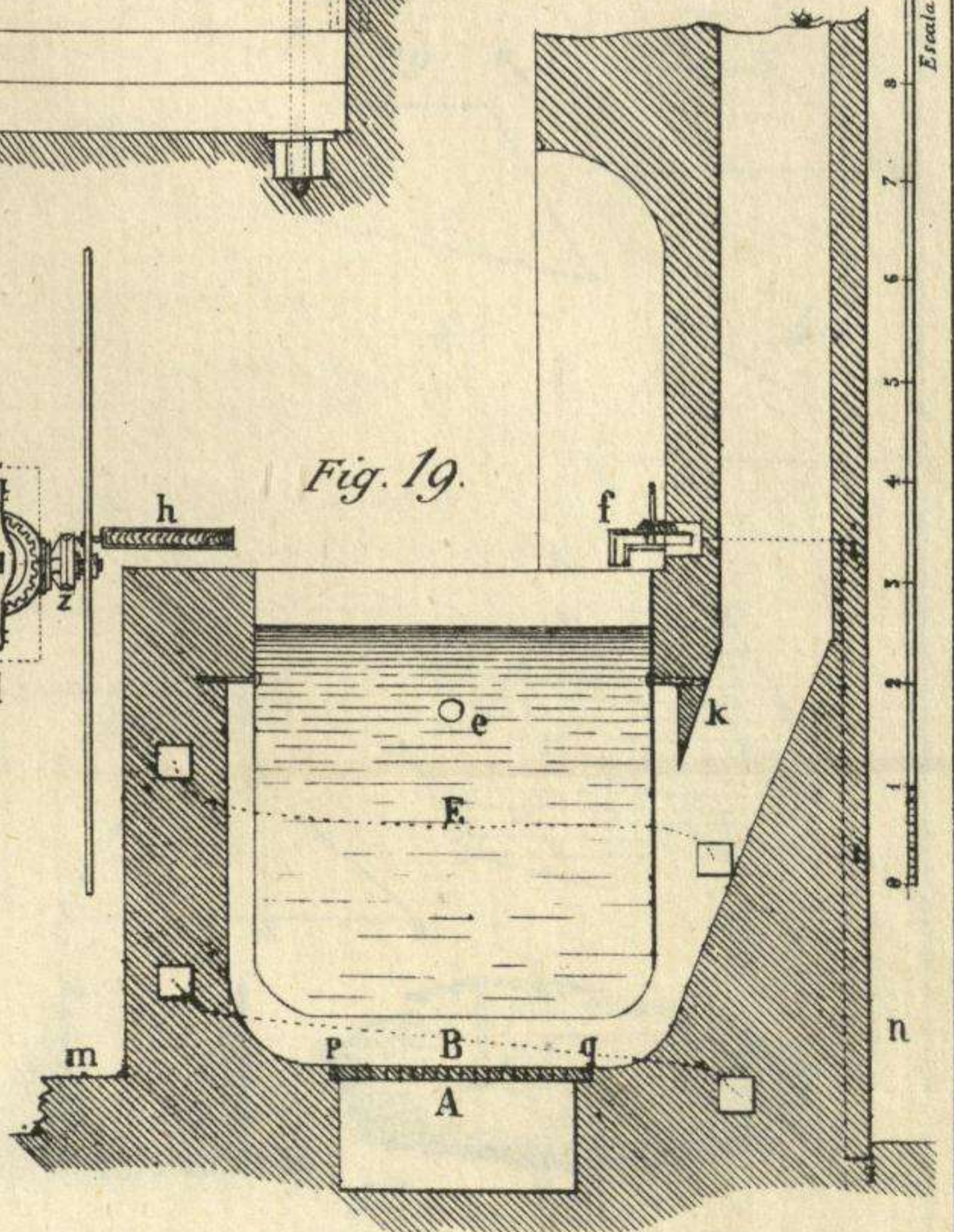
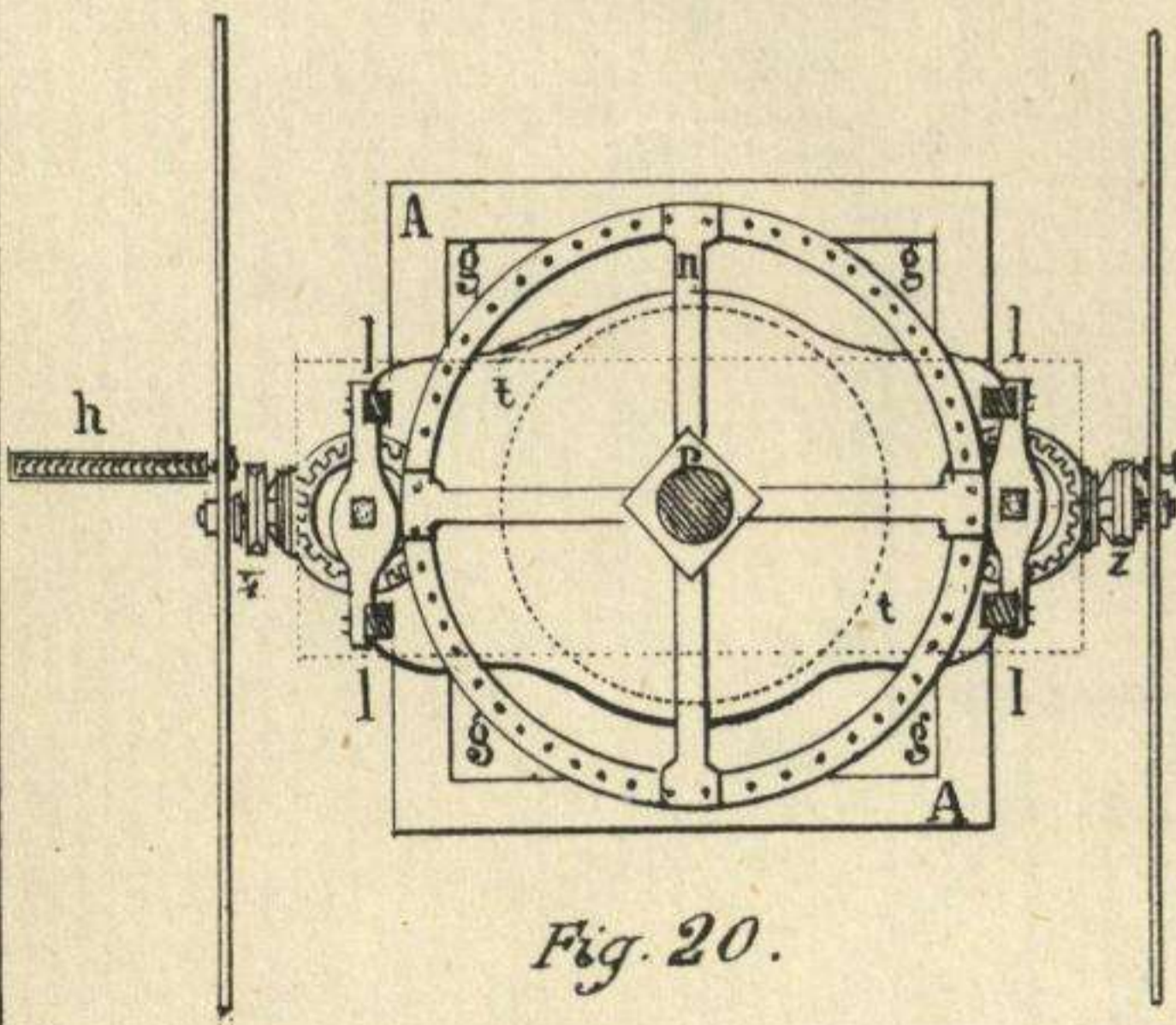


Fig. 20.

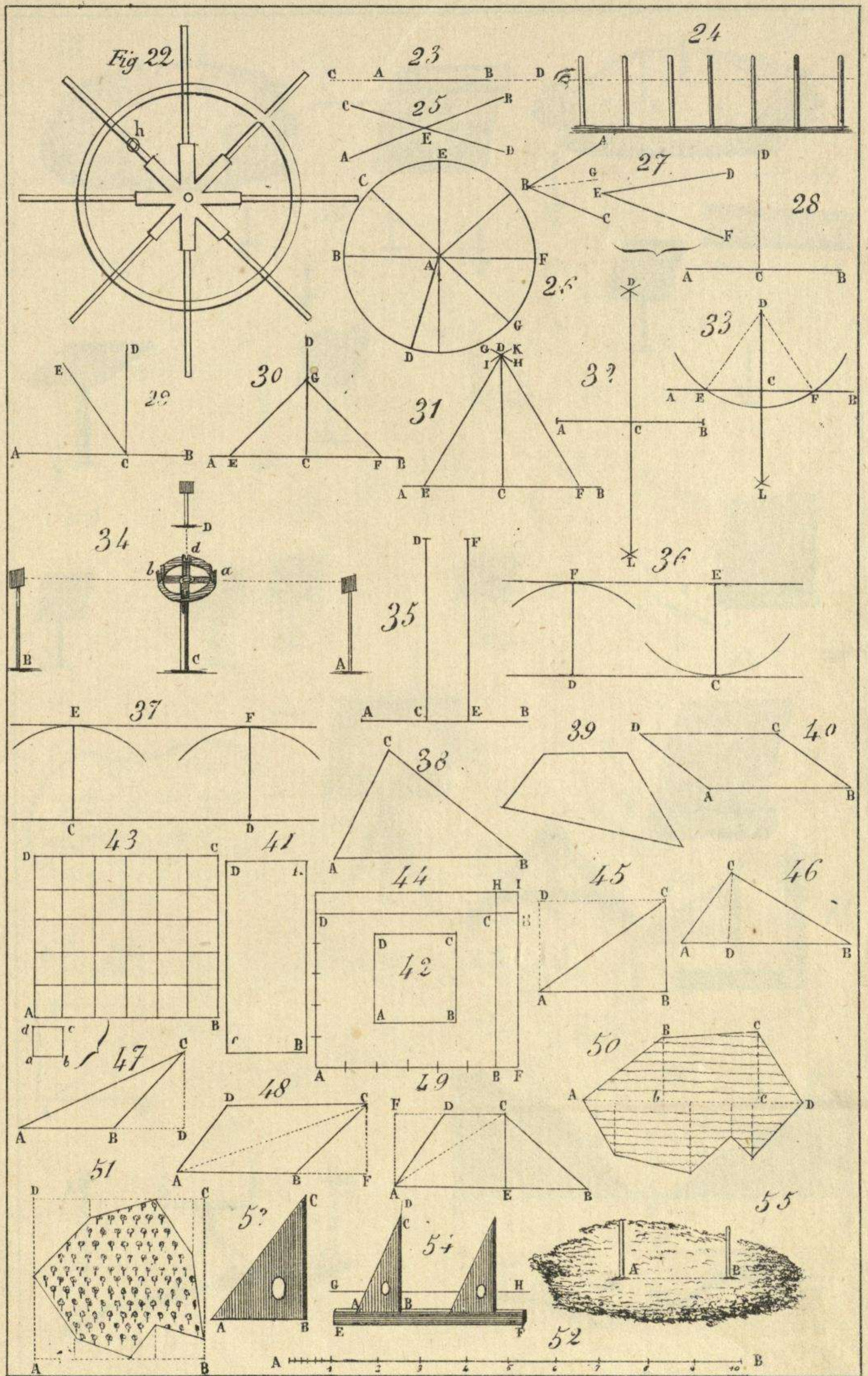




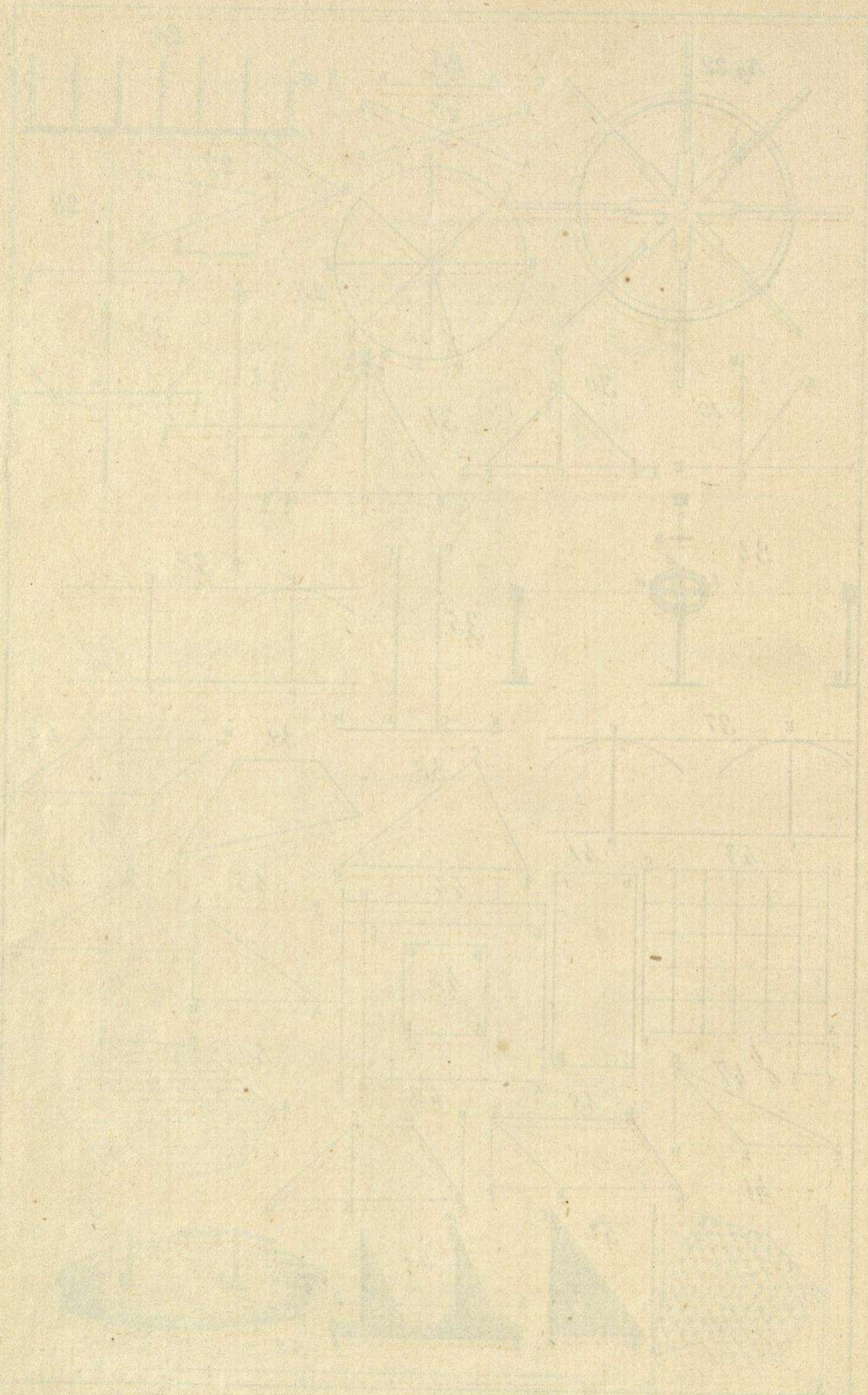




# Diccionario de Agricultura.

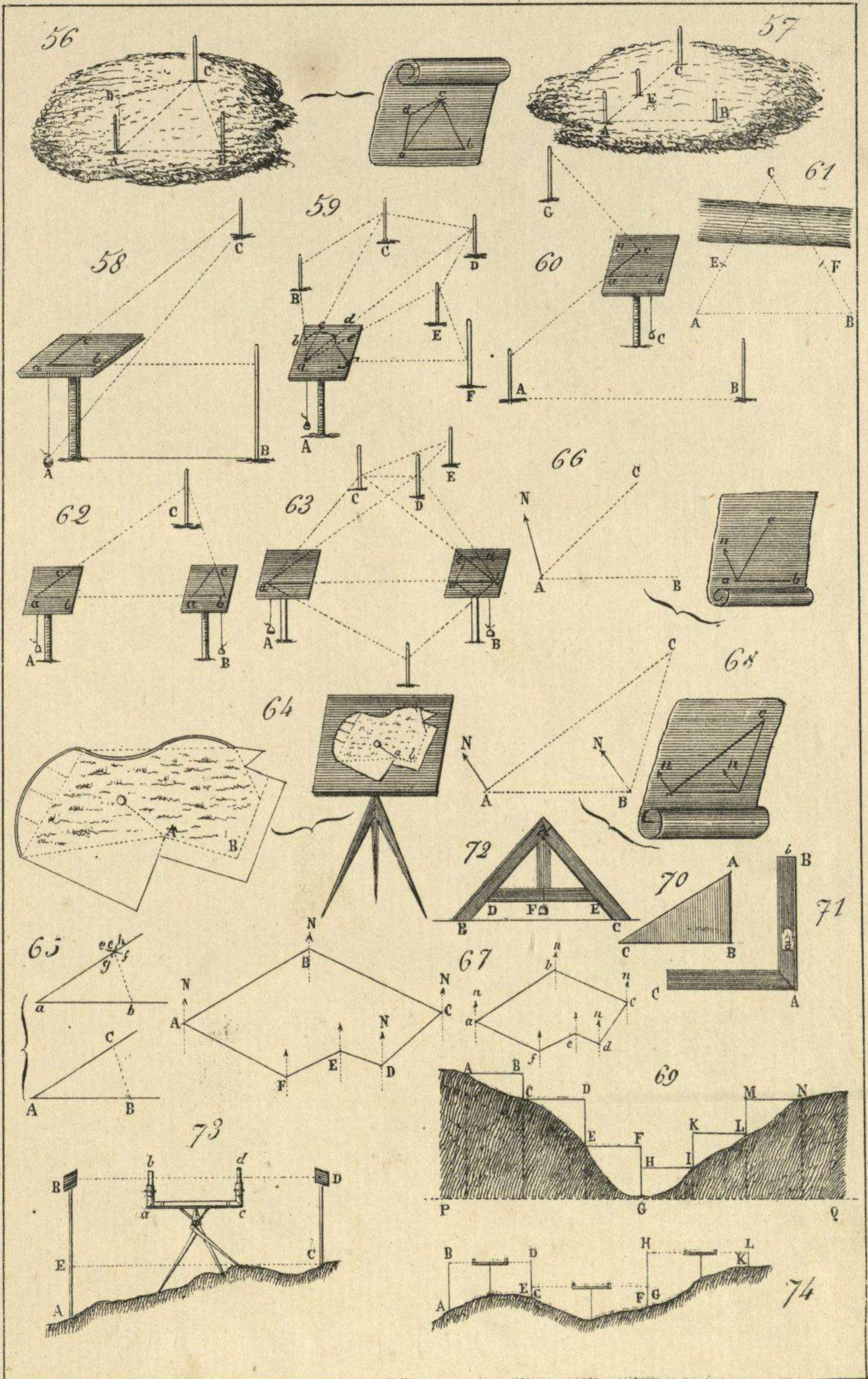




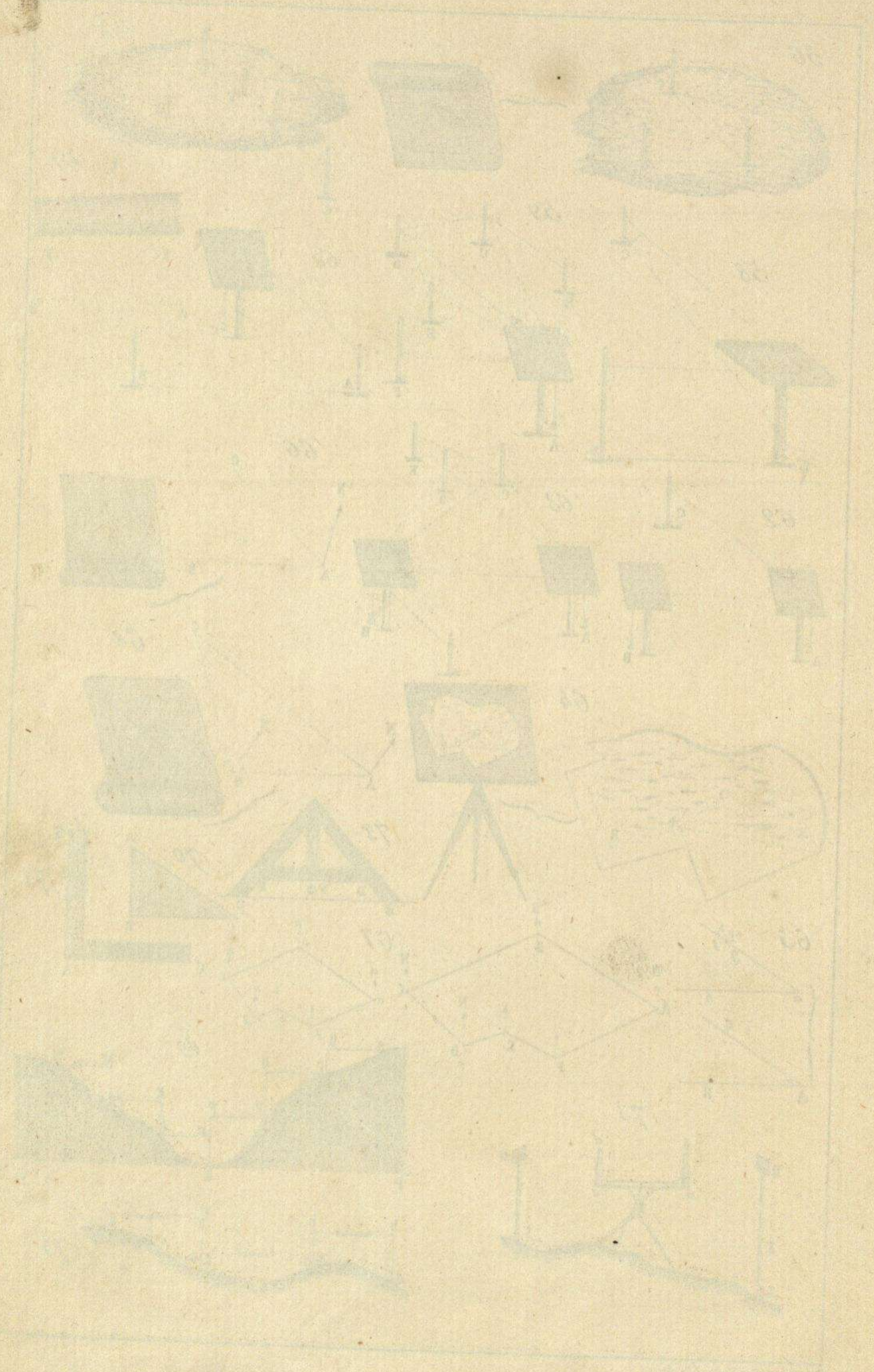




# Diccionario de Agricultura.









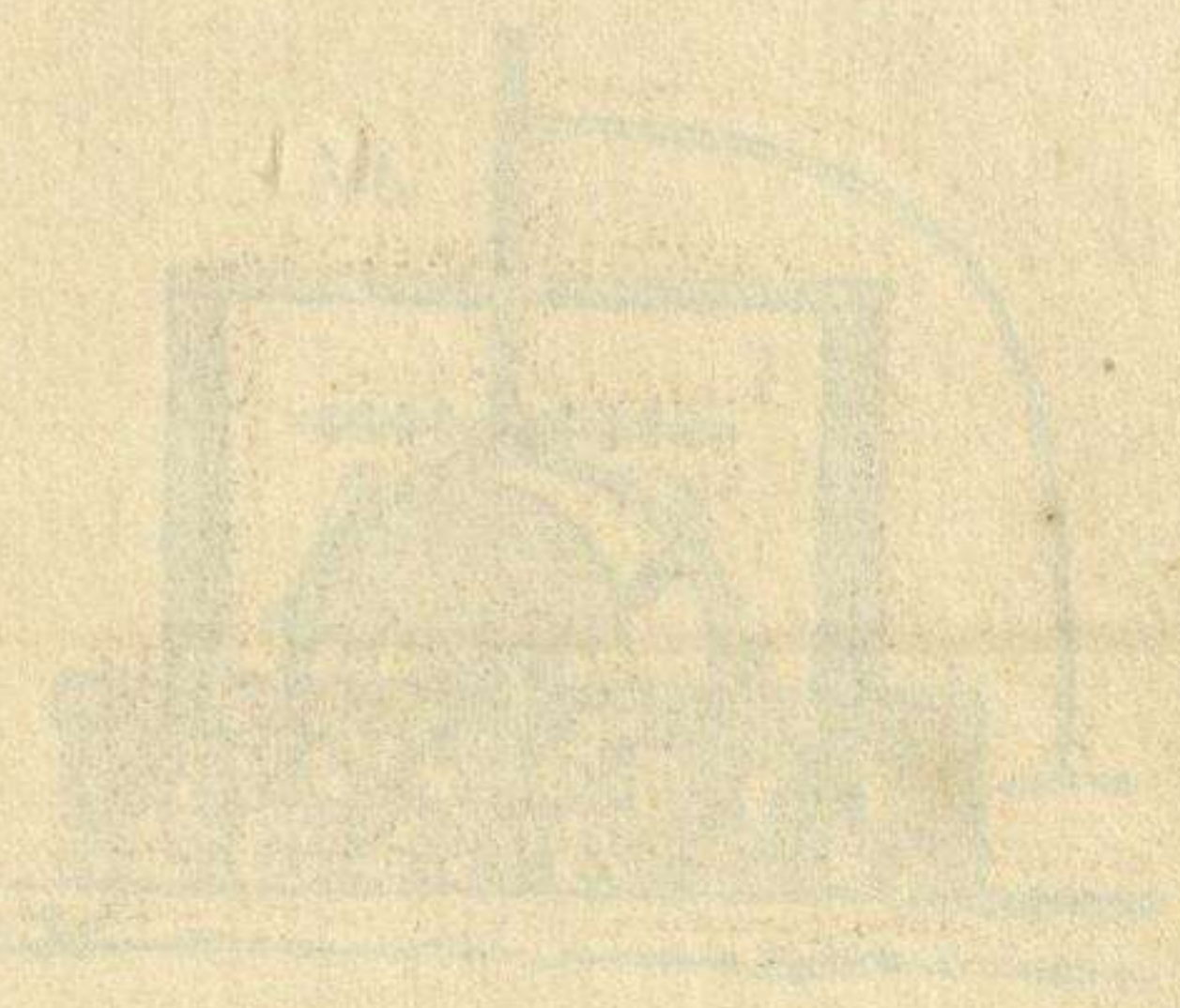
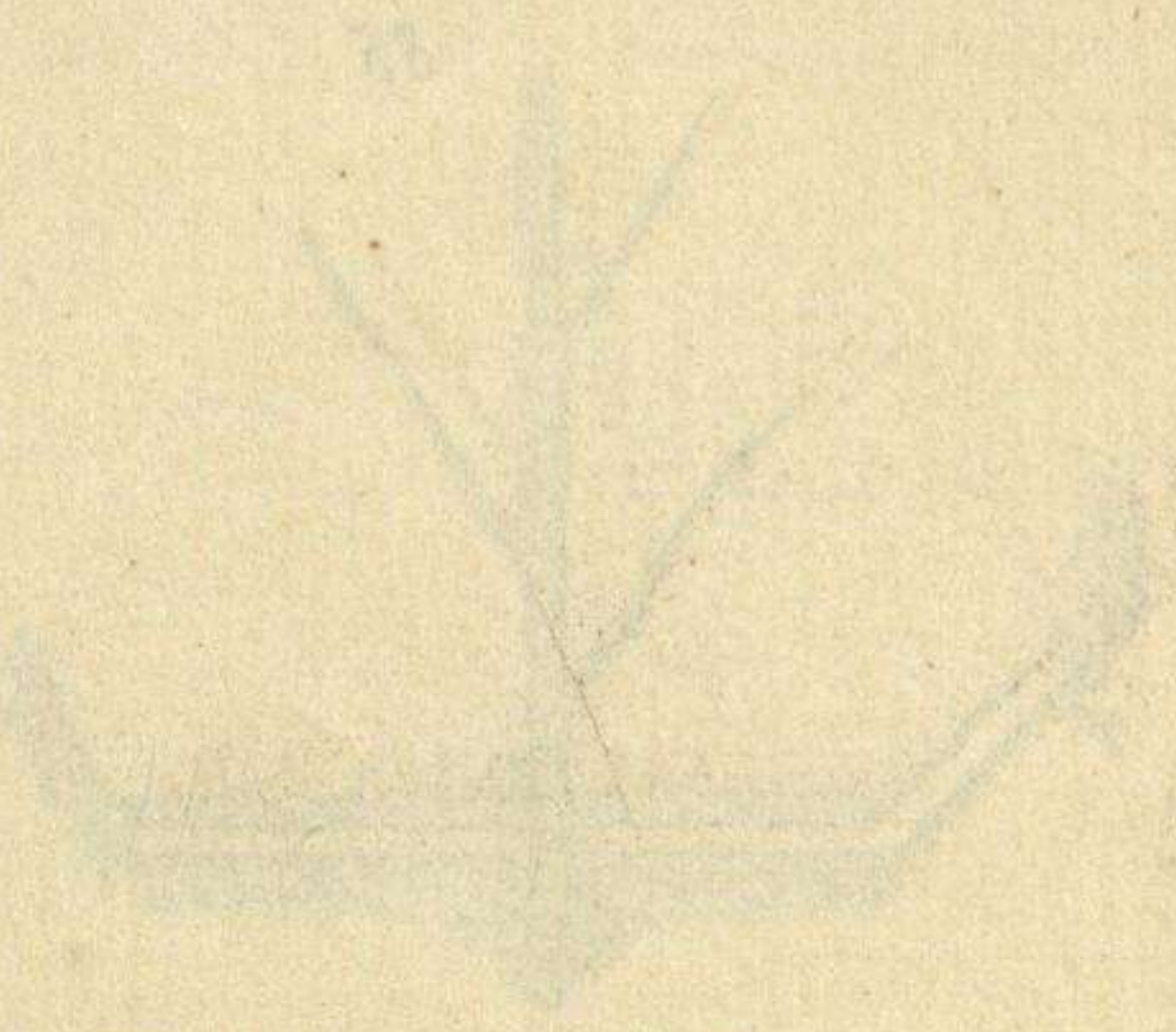
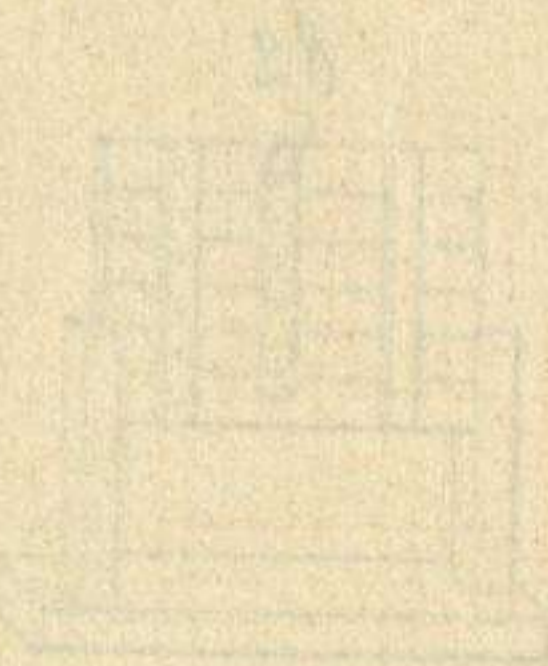
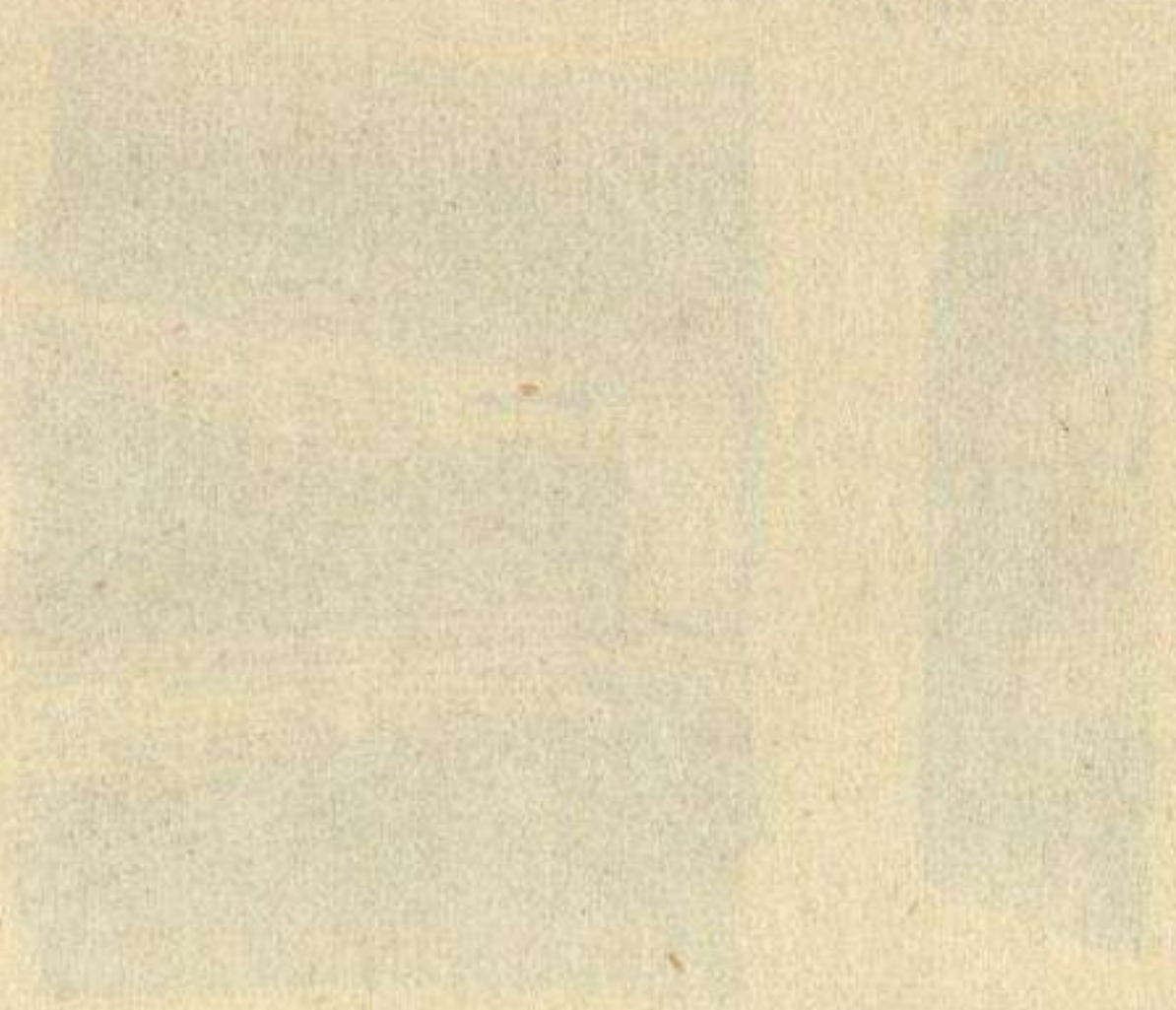
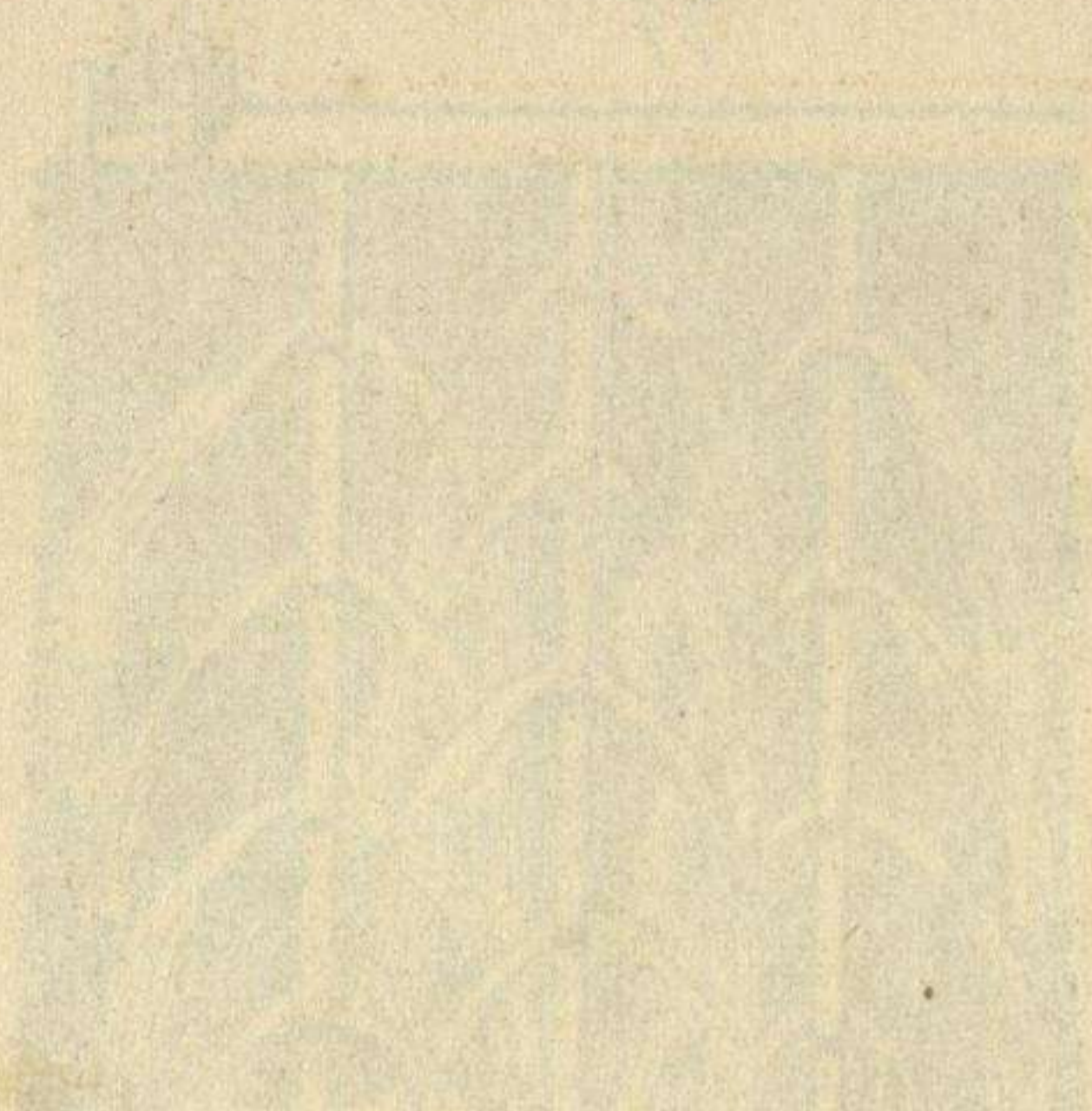
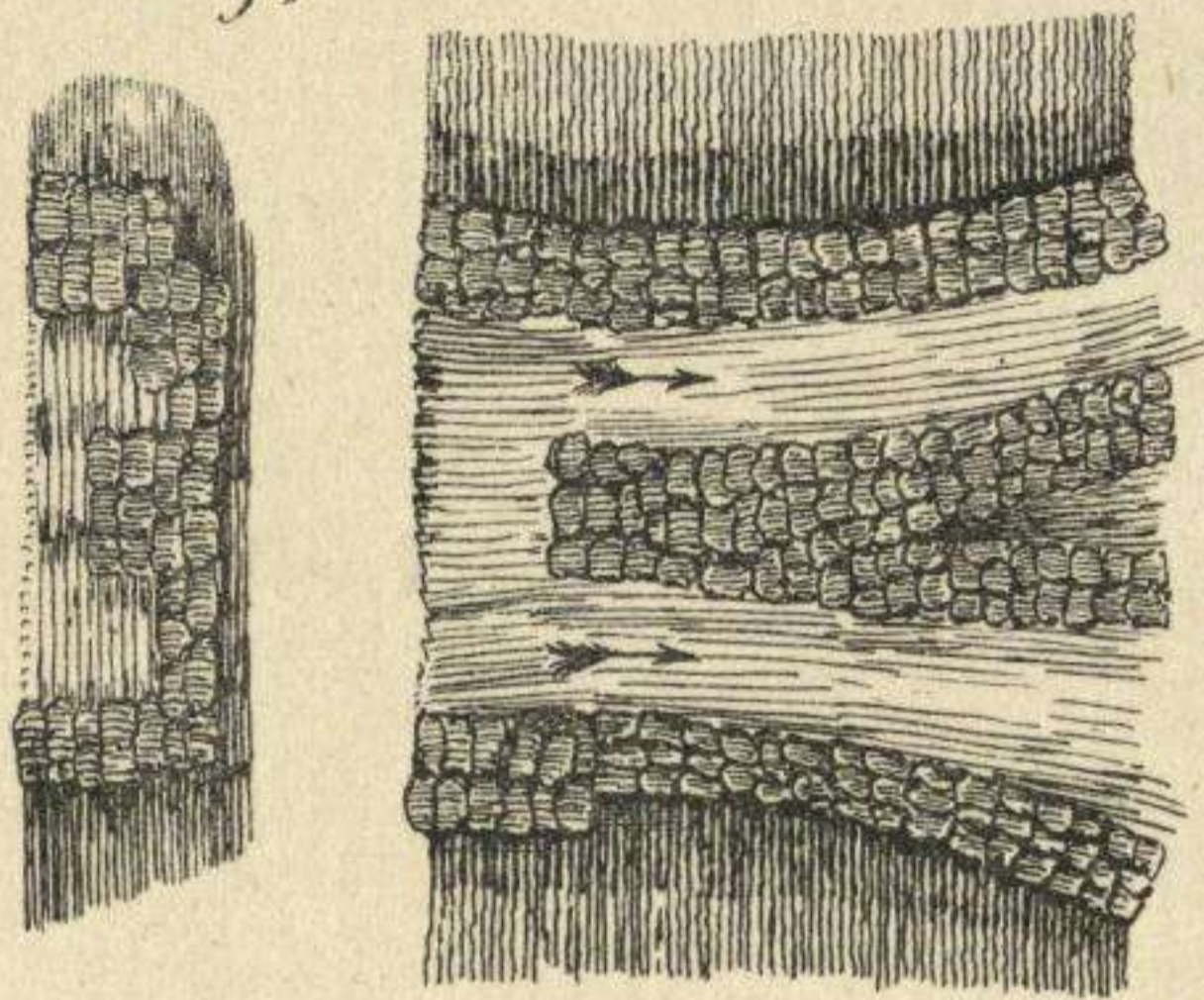
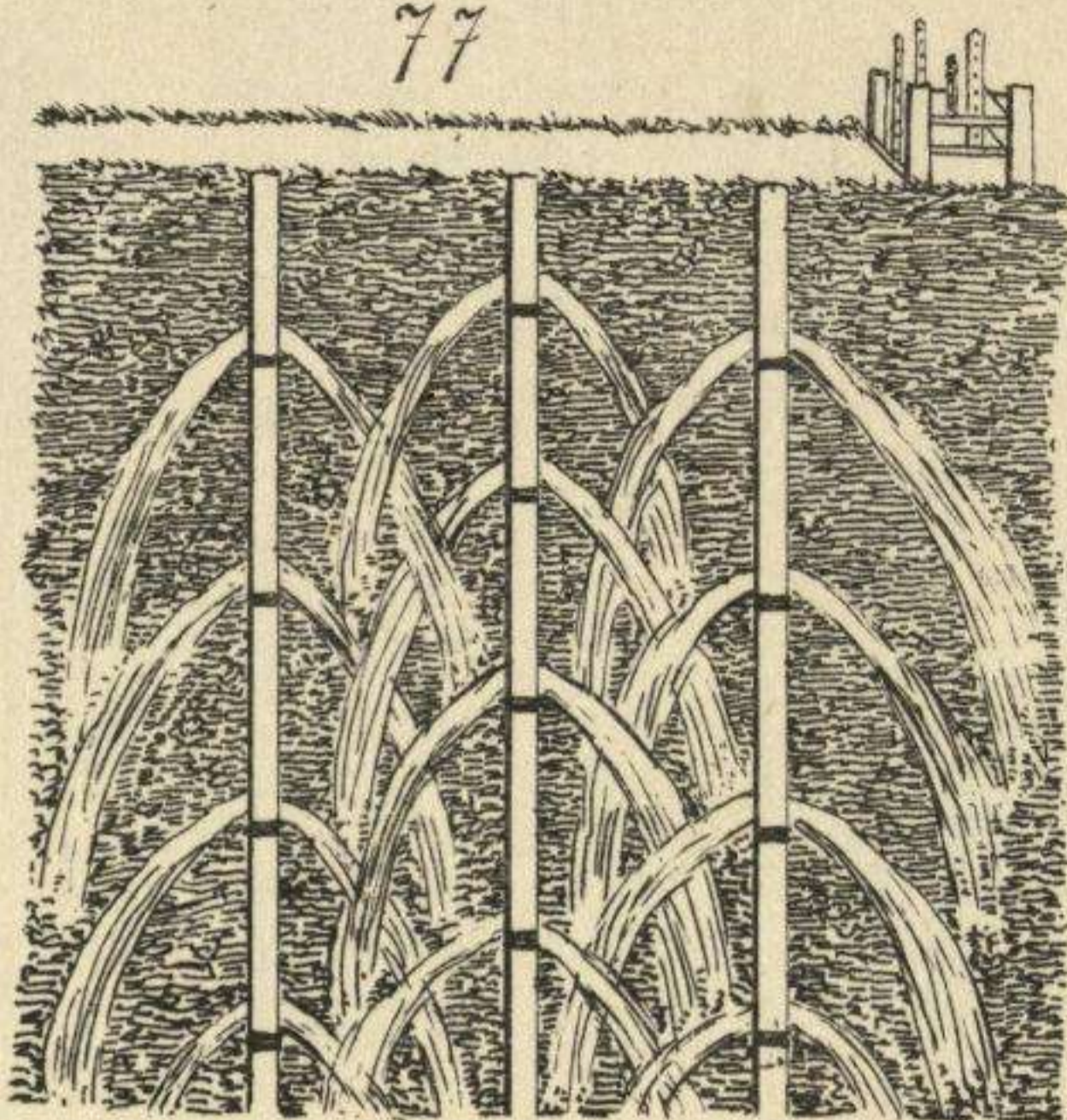




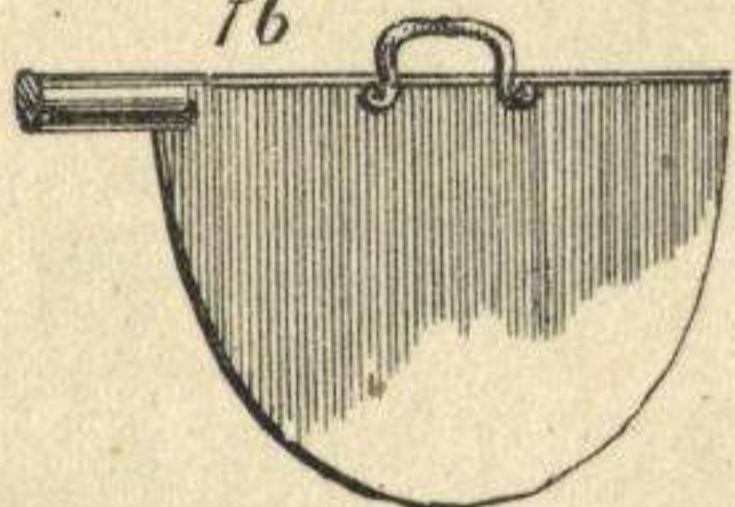
Fig. 75



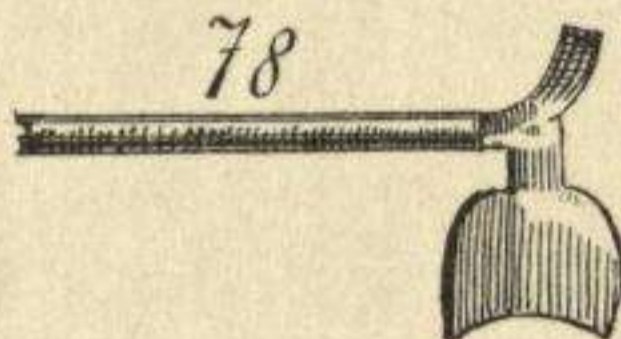
77



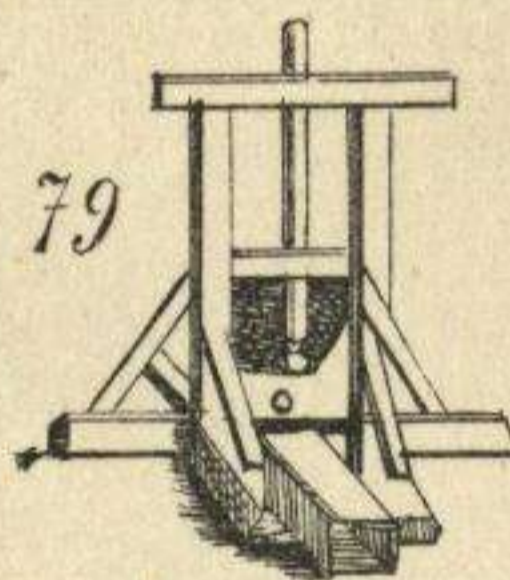
76



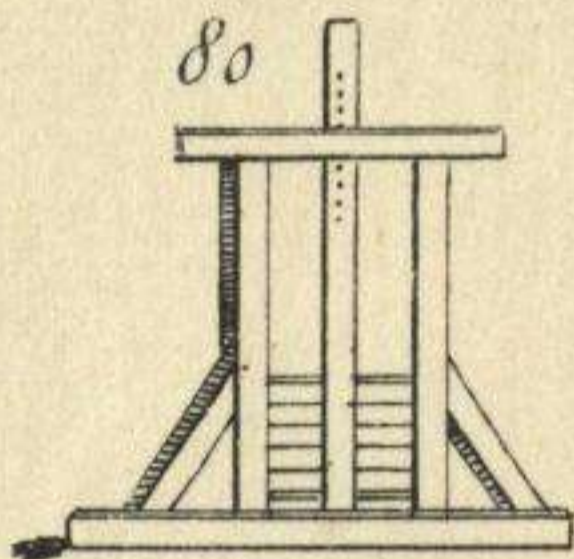
78



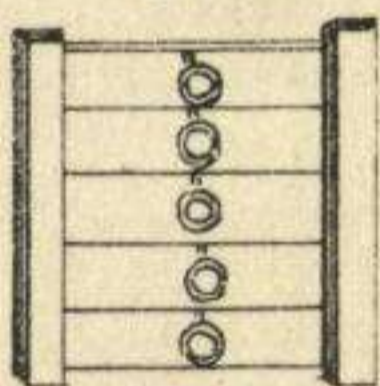
79



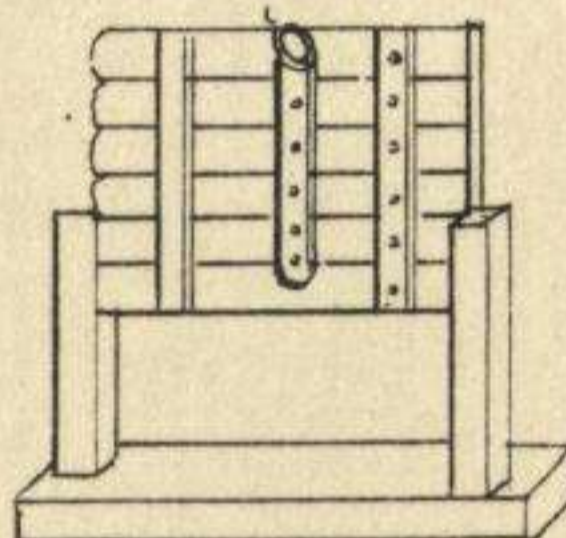
80



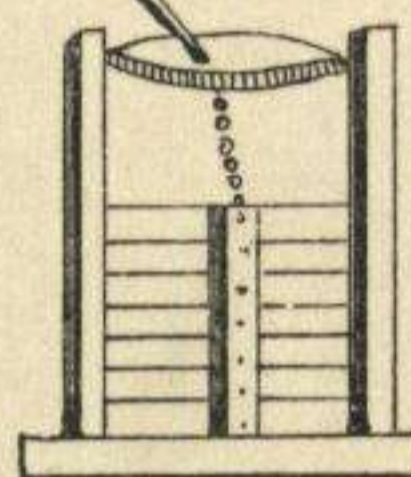
81



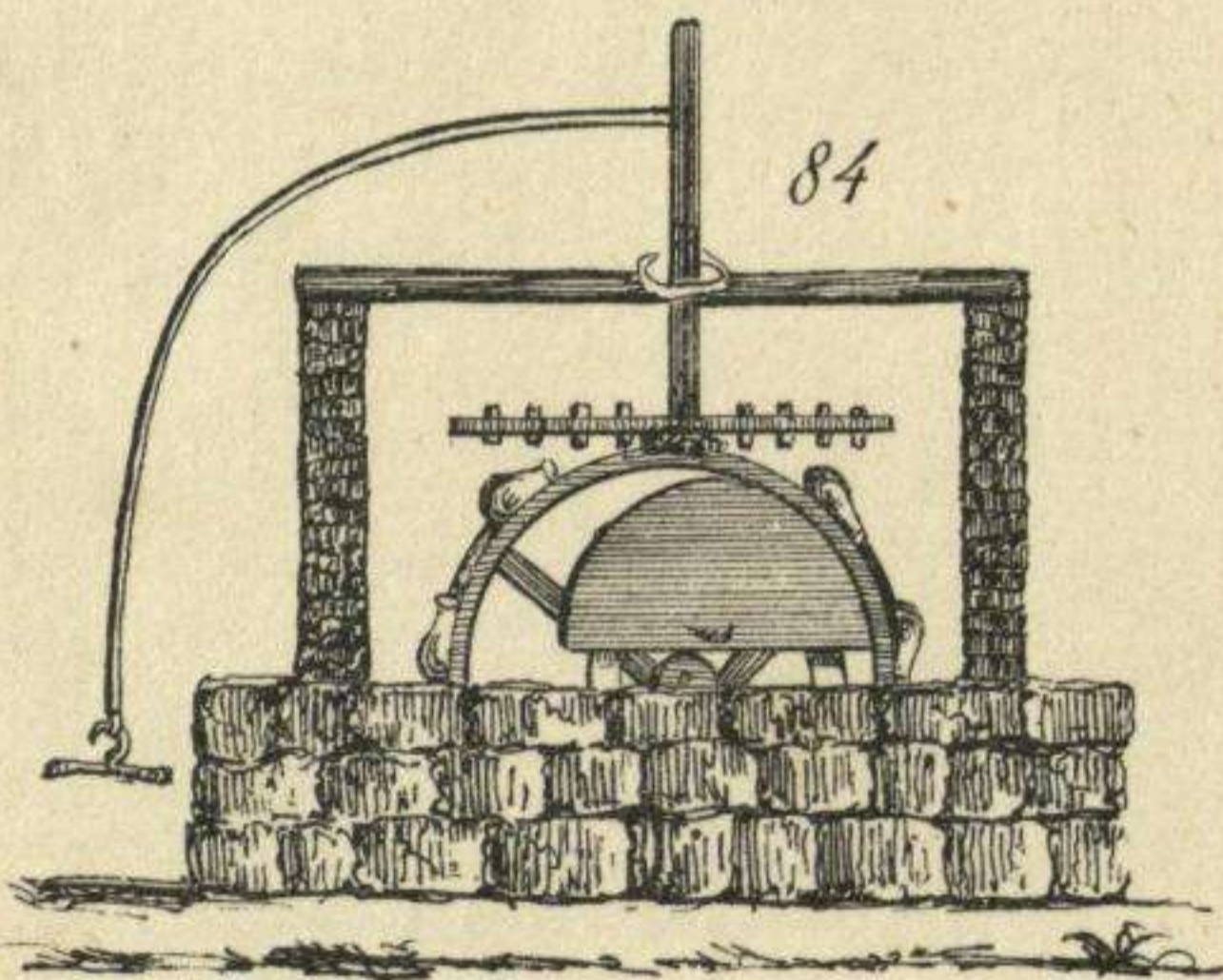
82



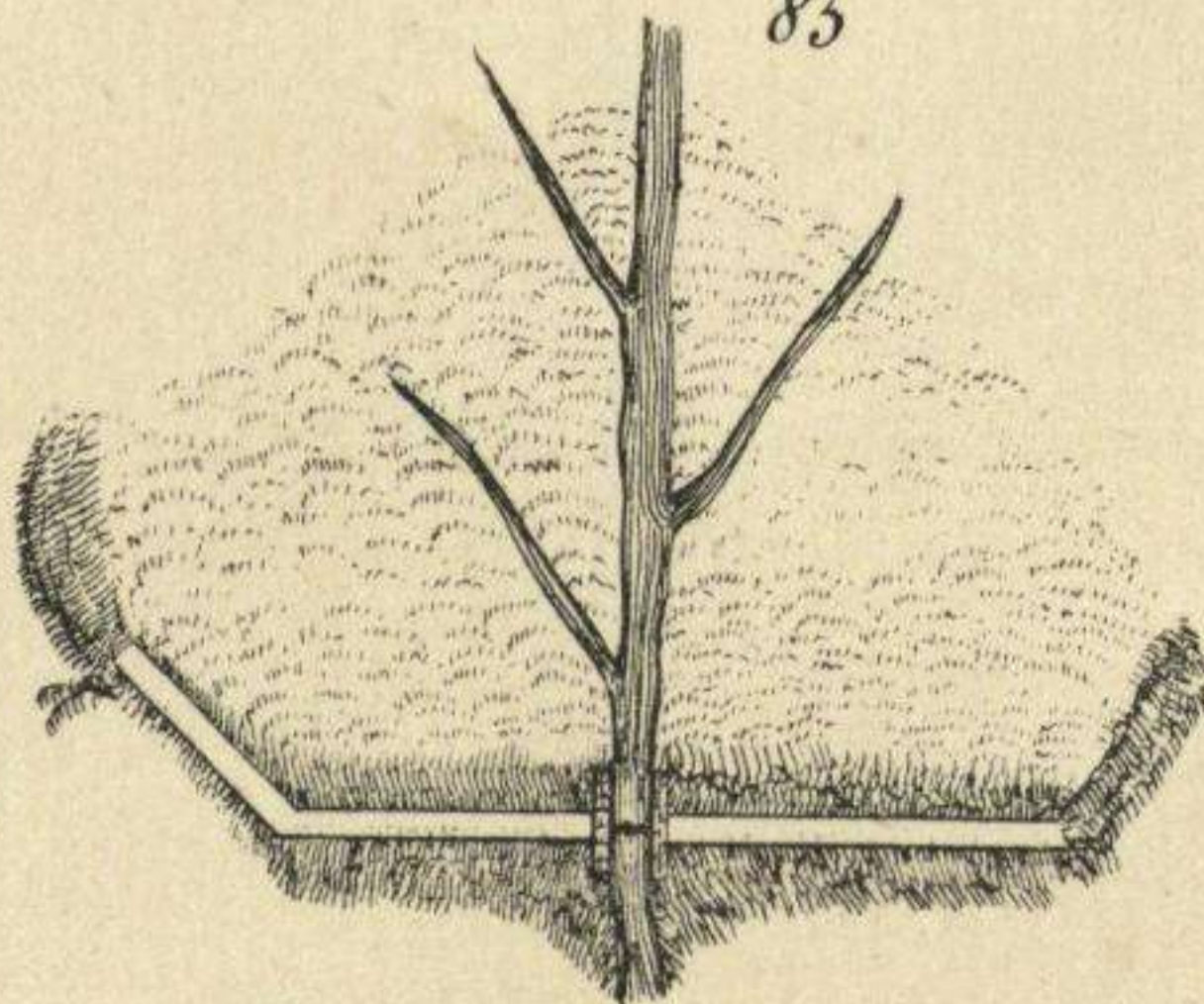
83



84

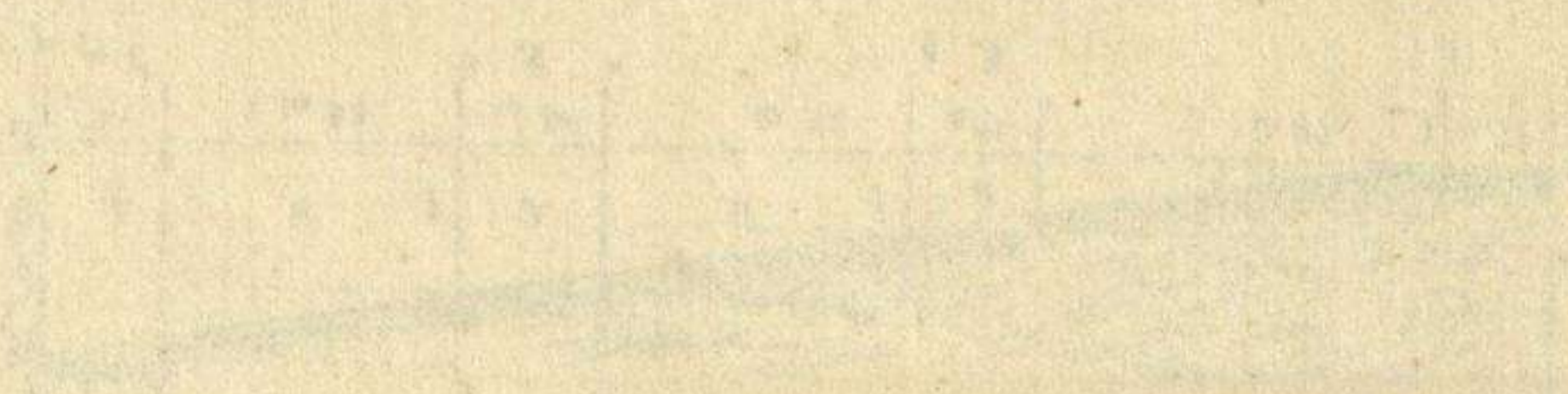
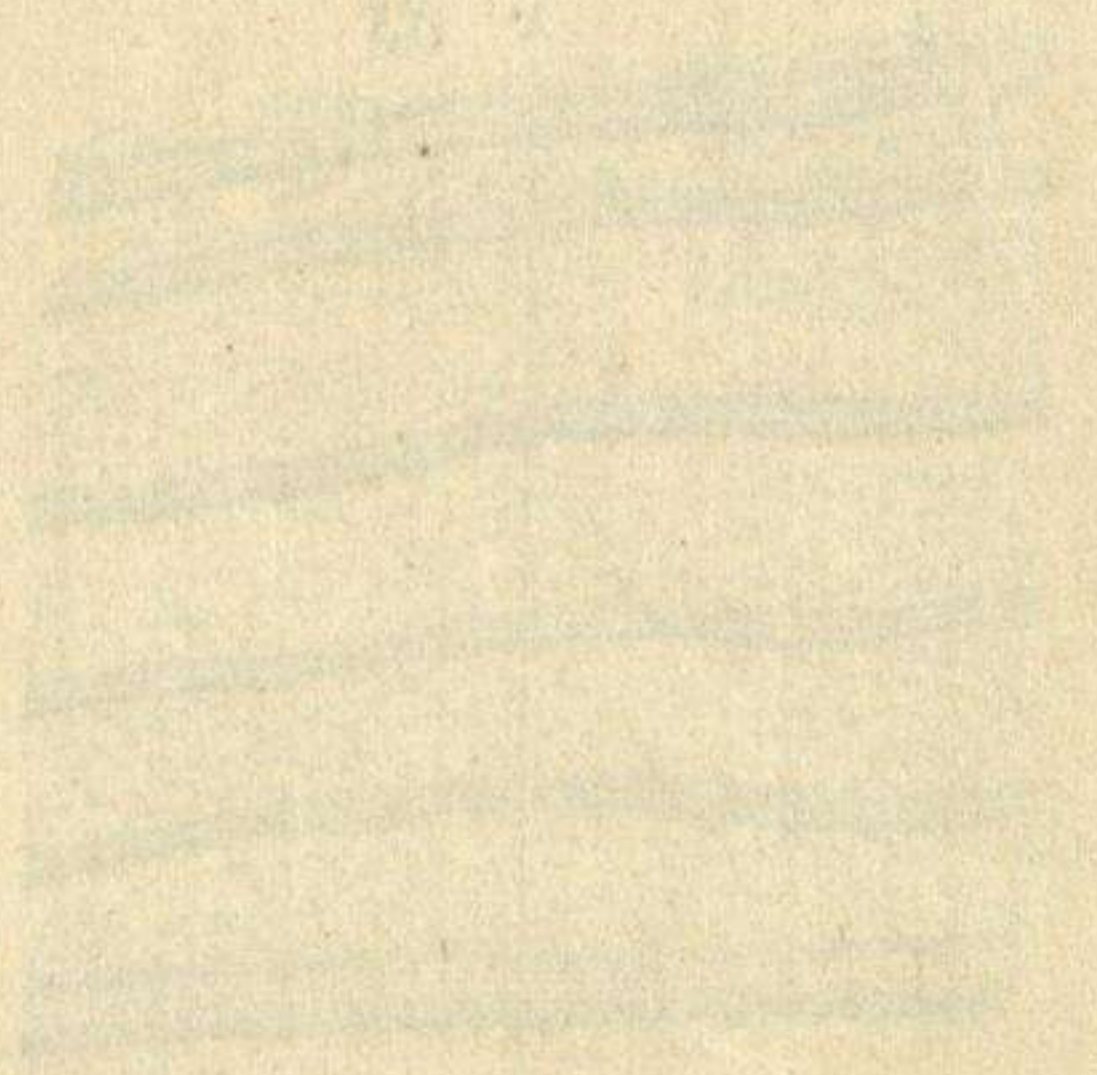
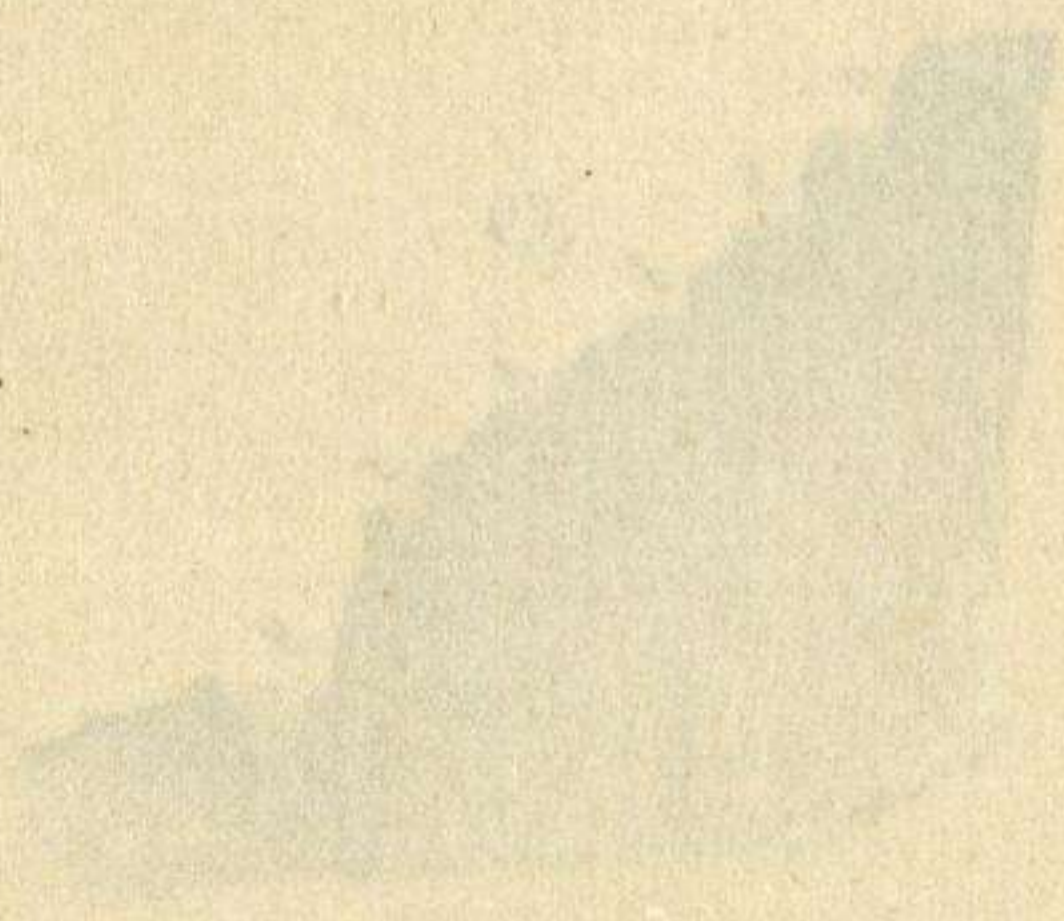
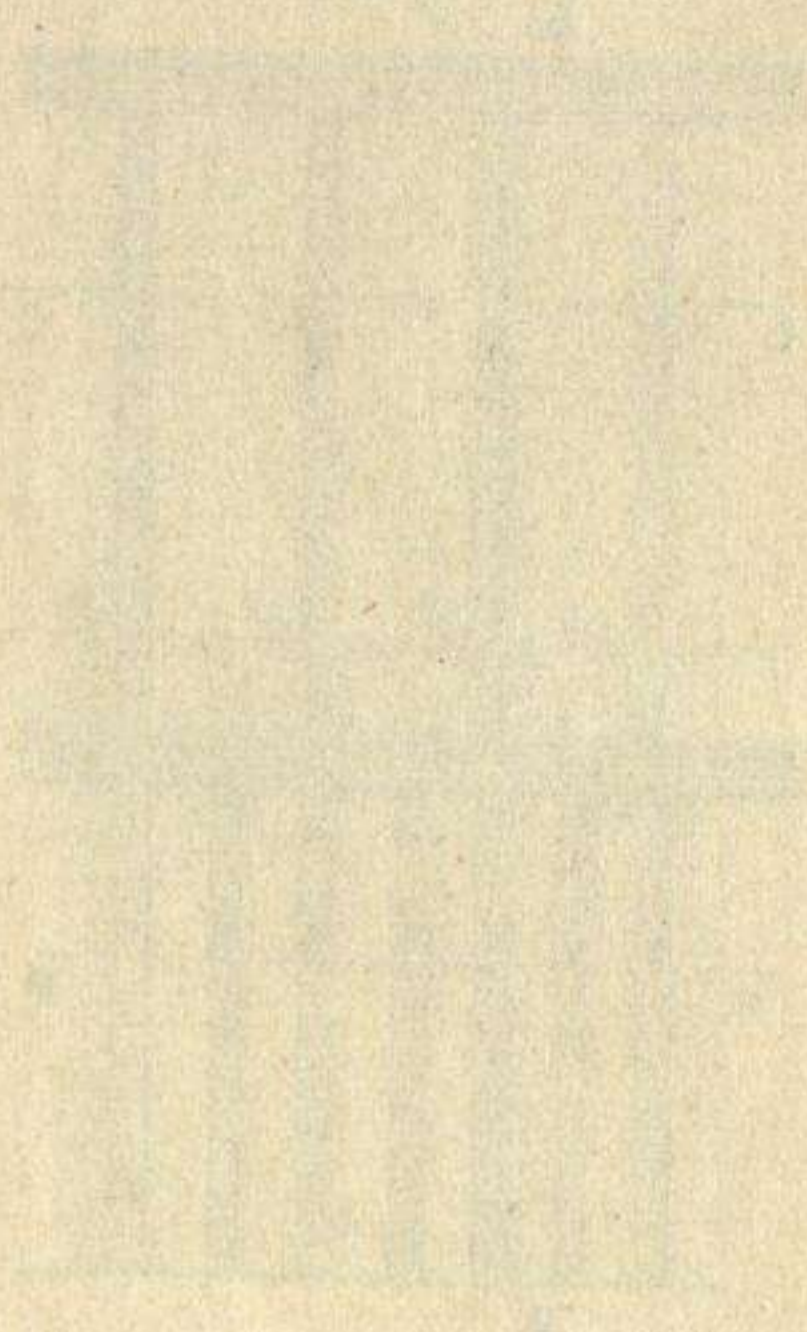
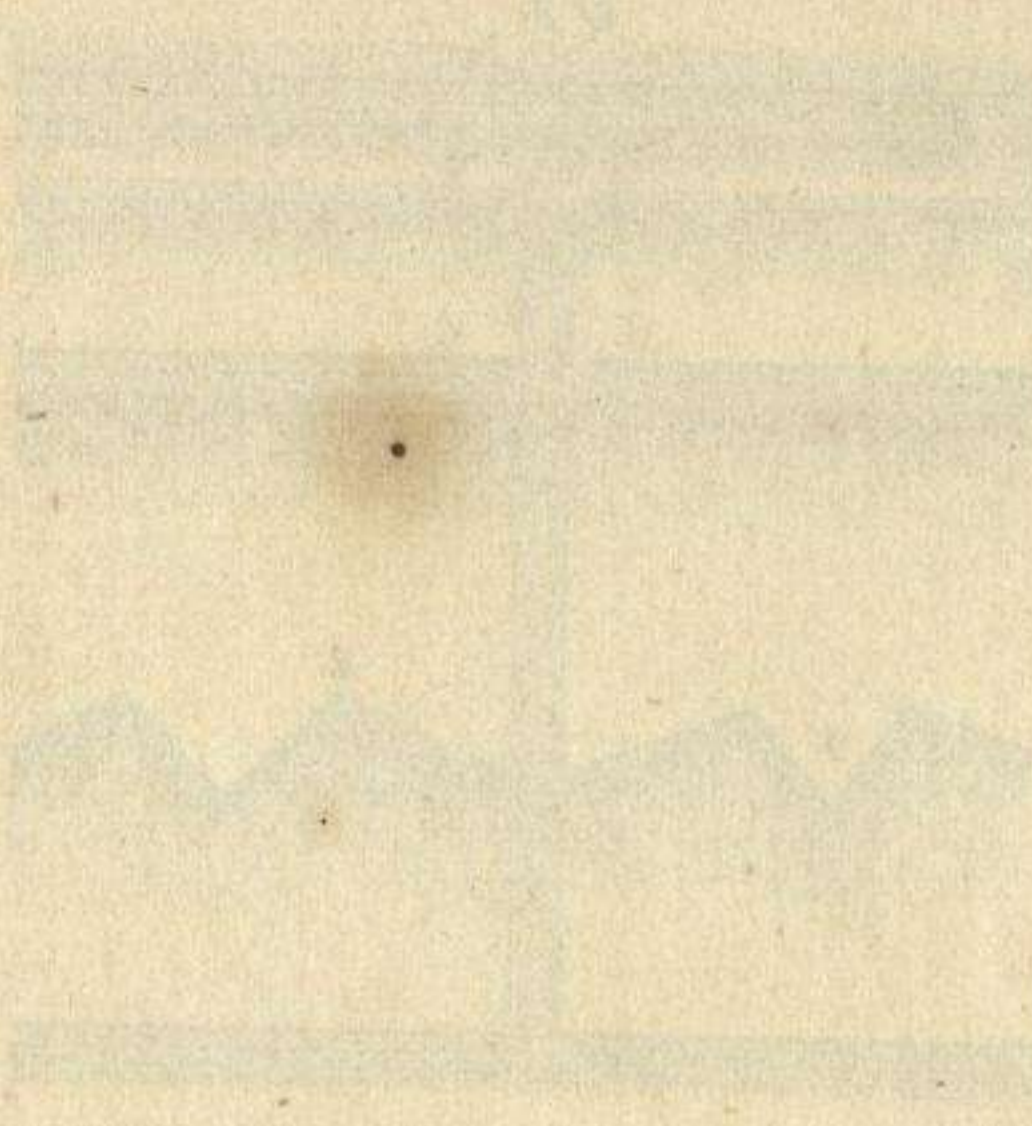


85





Faint, illegible text at the top of the page.





# Diccionario de Agricultura.

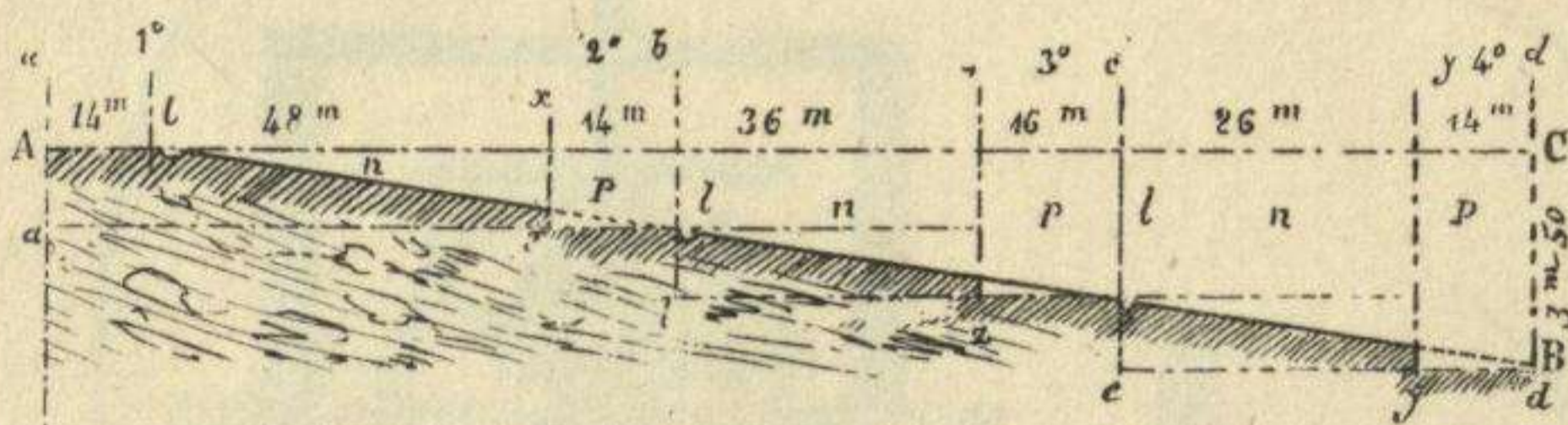
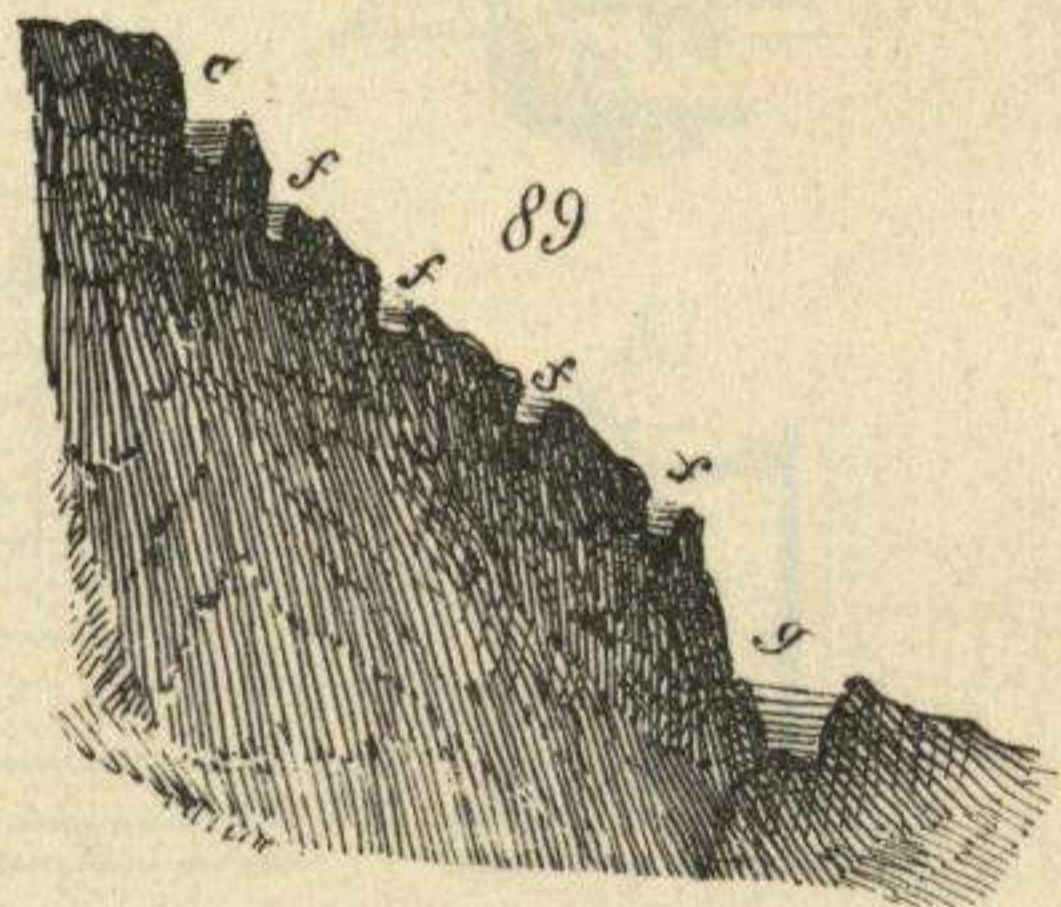
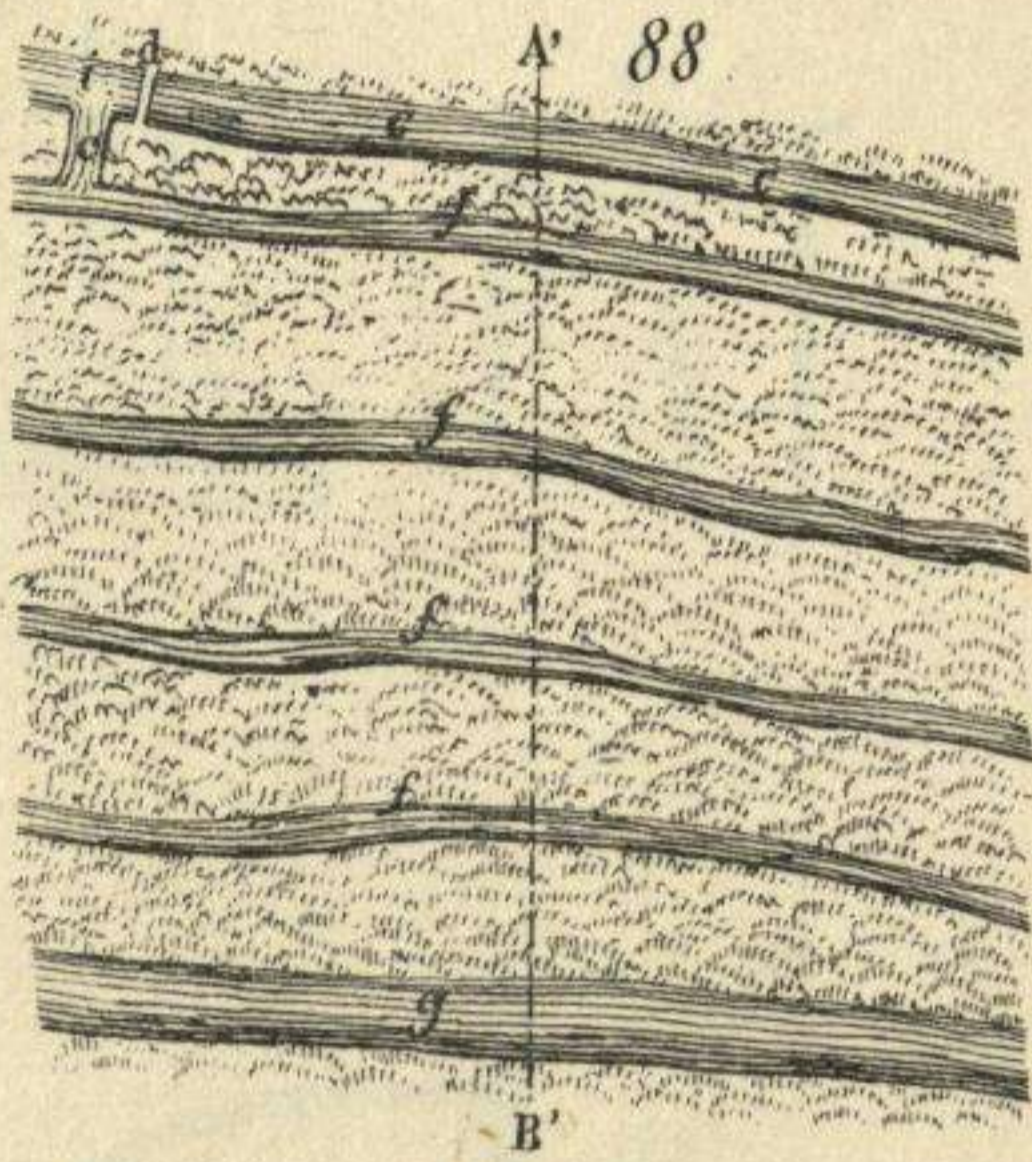
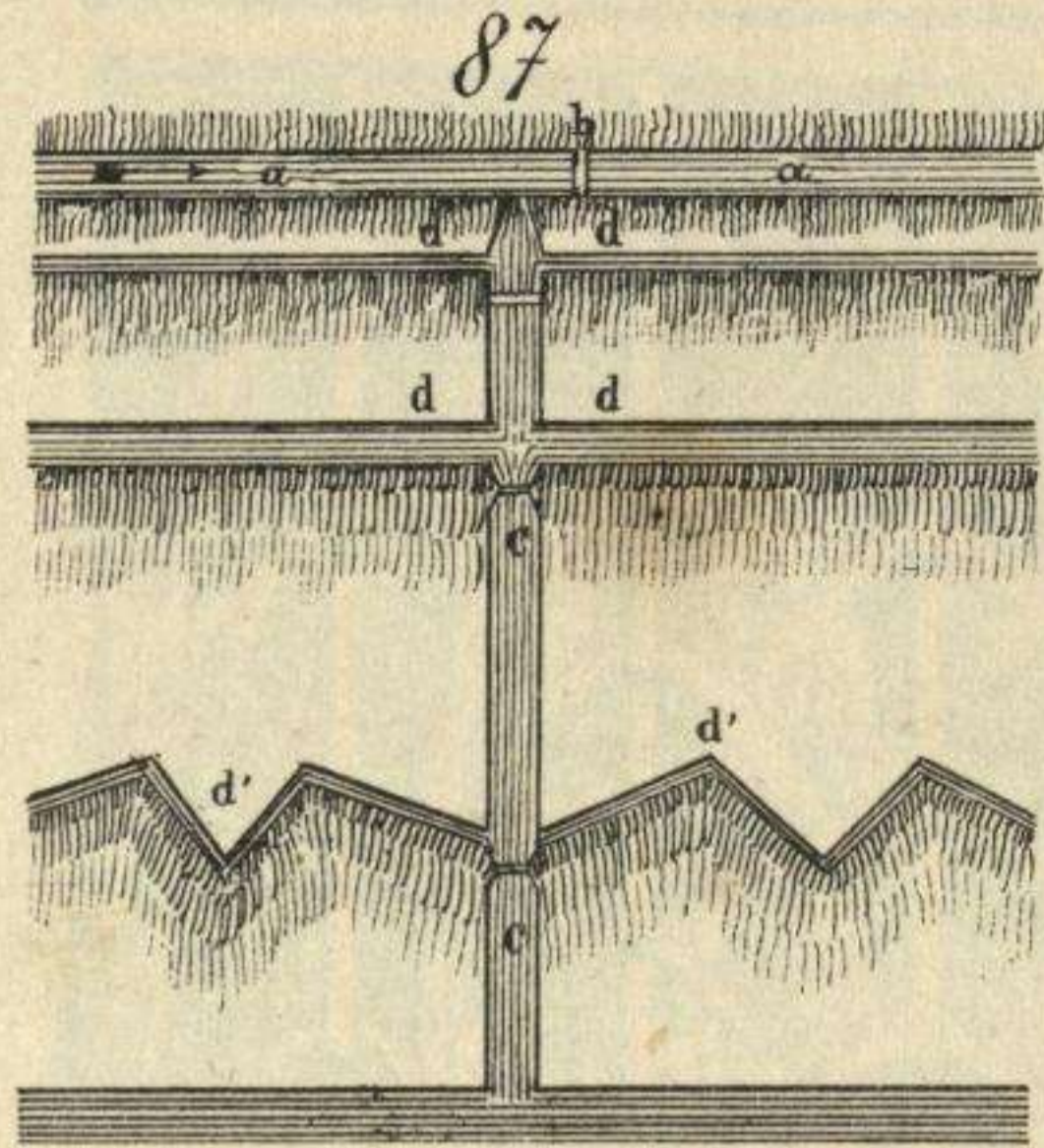
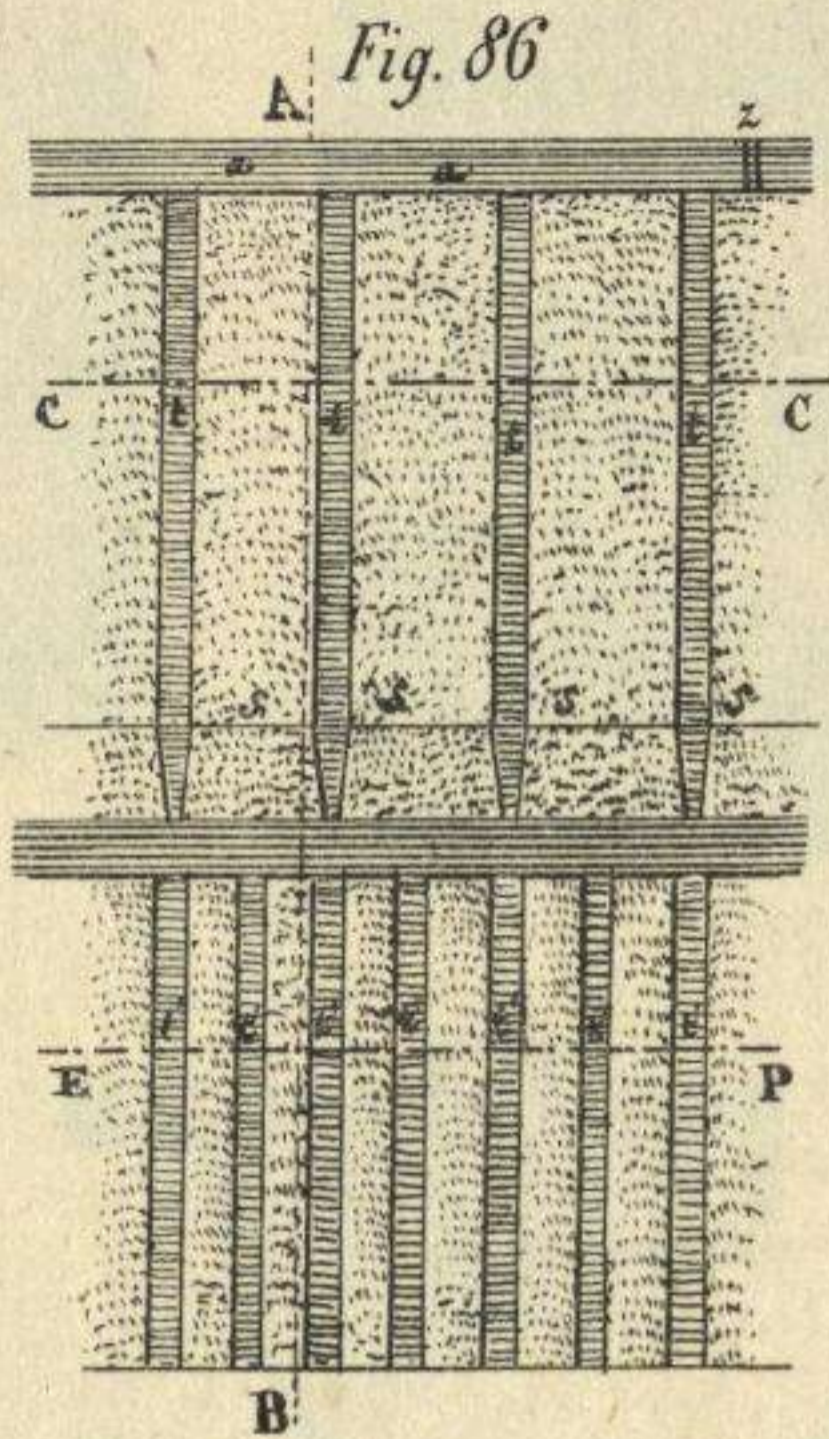
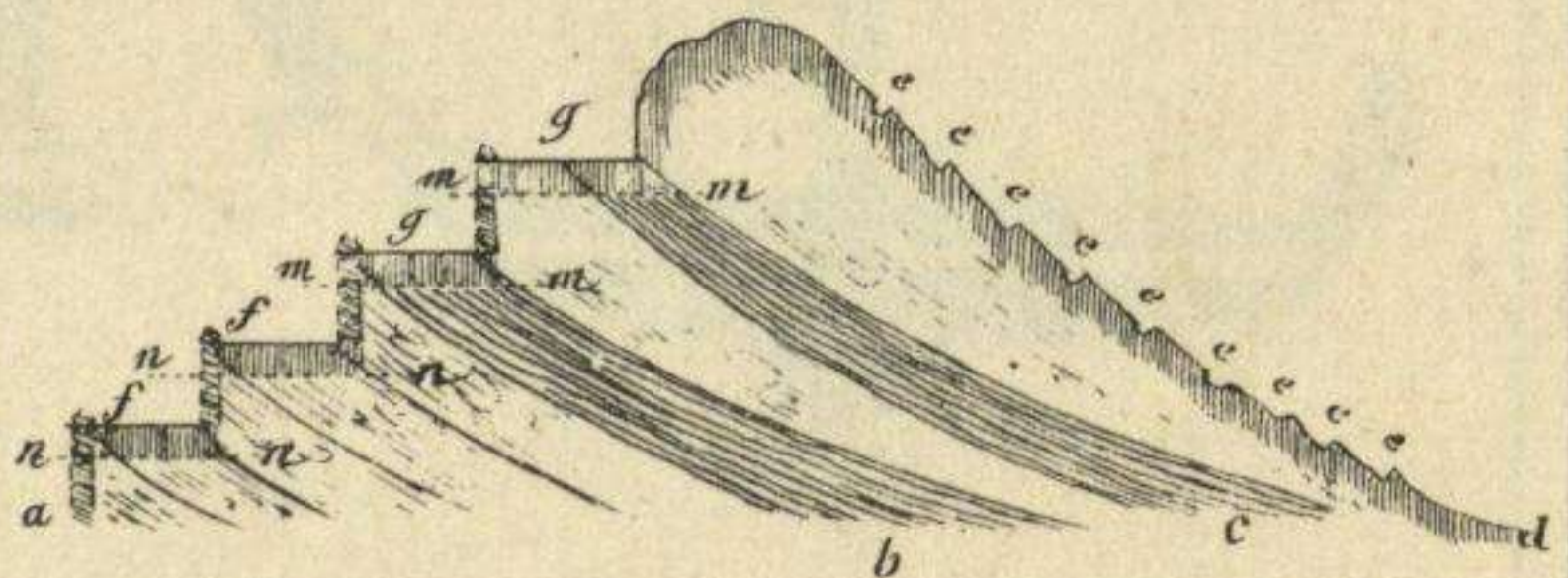


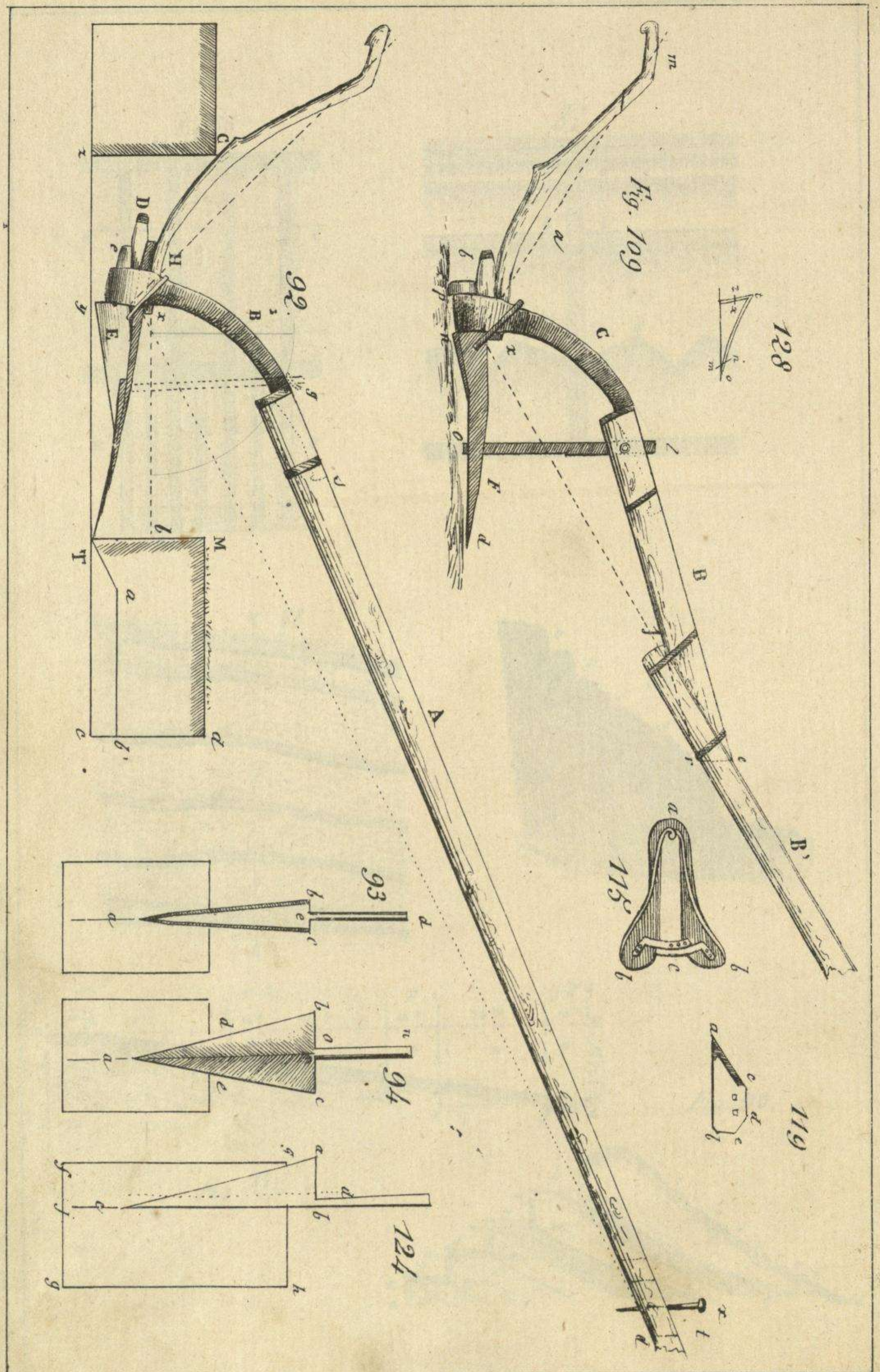
Fig. 91.



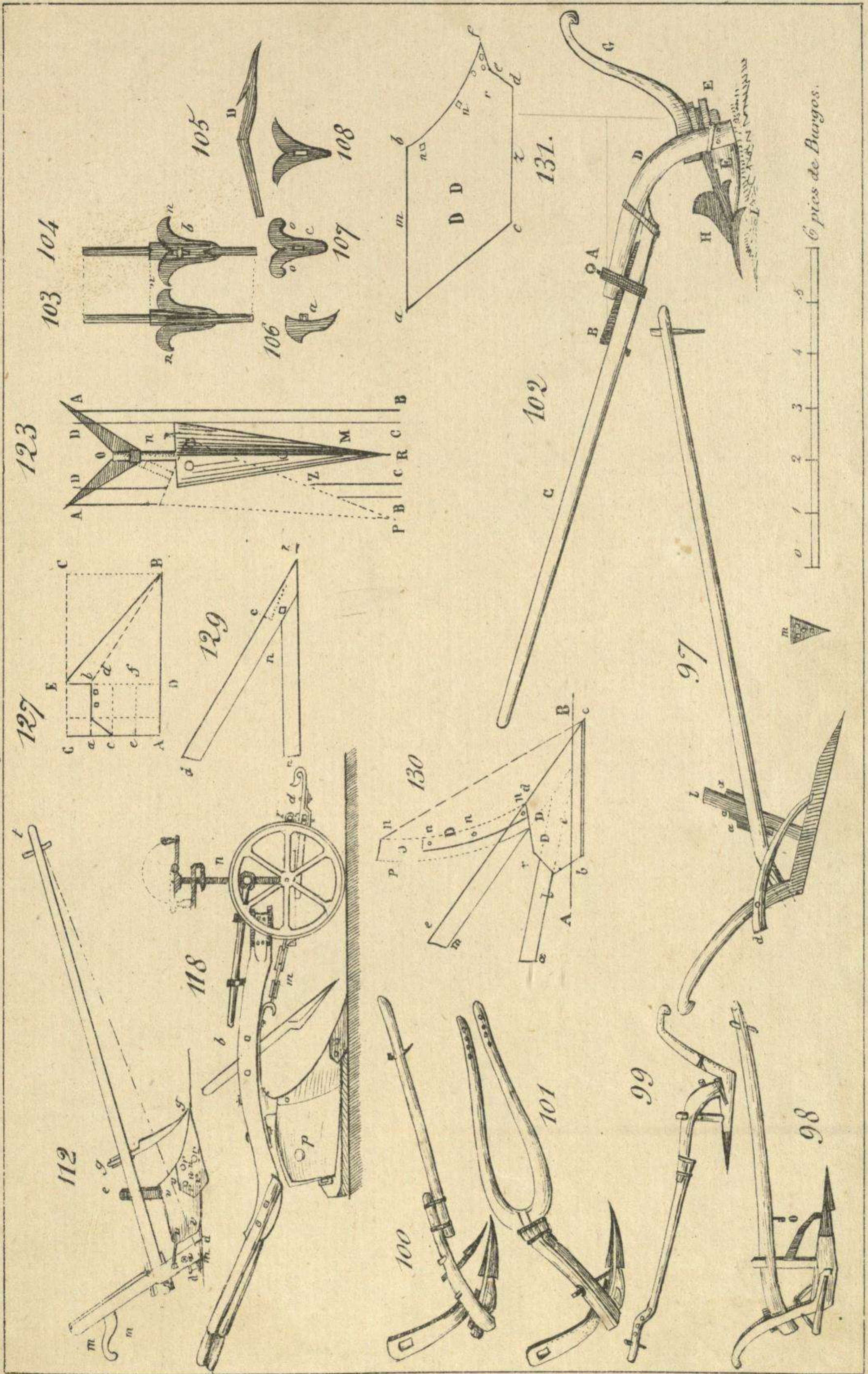






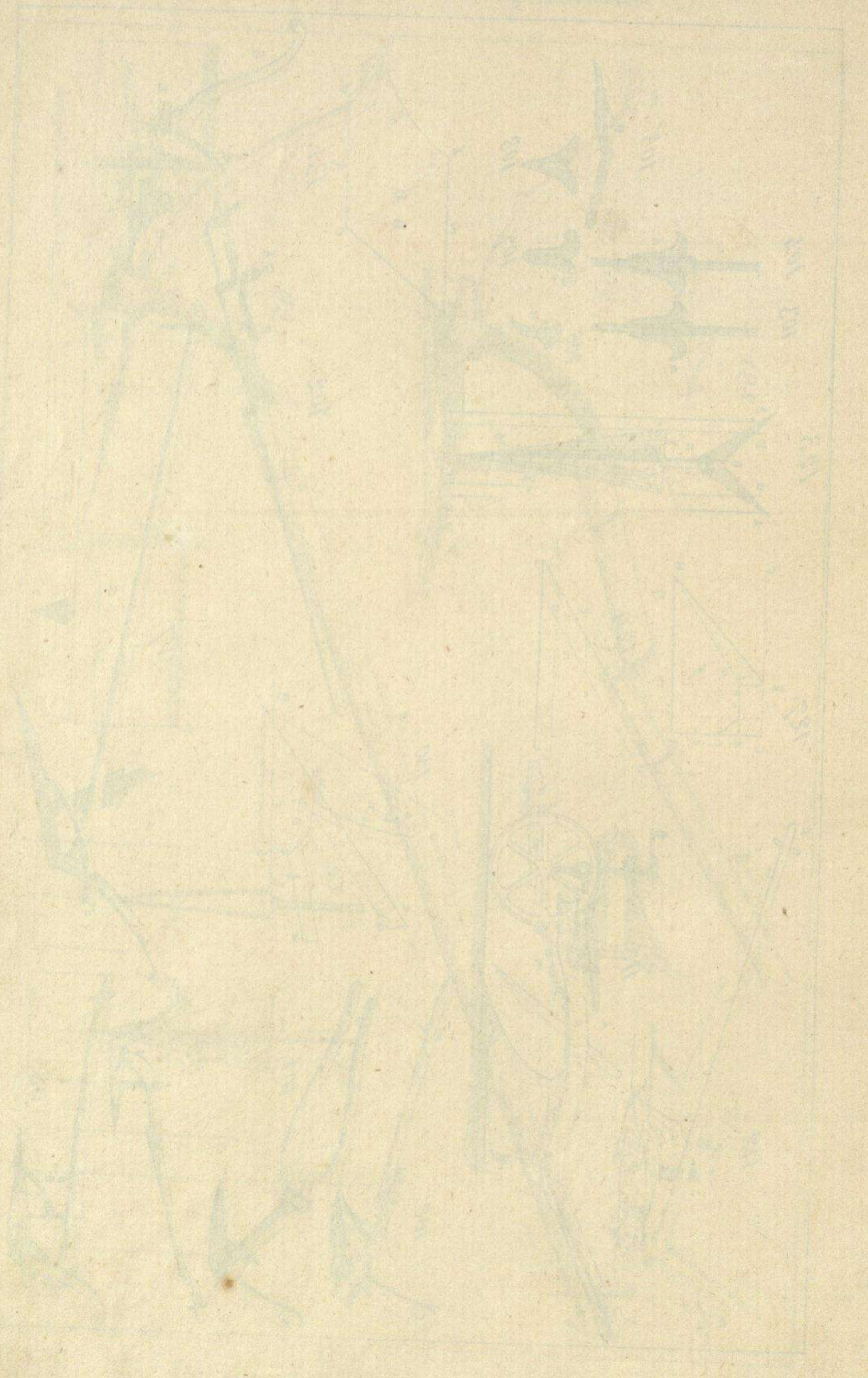






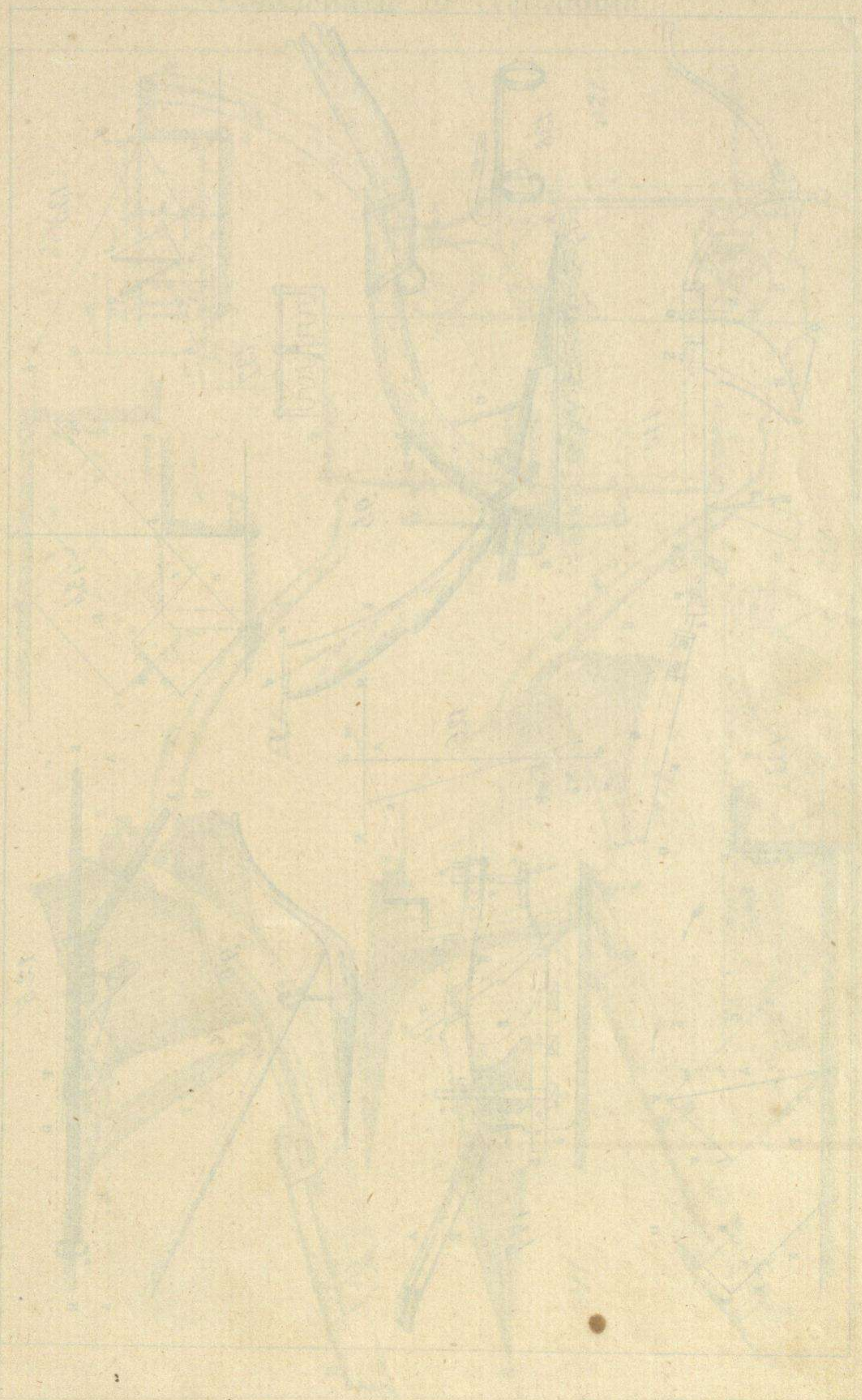


Handwritten title or header at the top of the page, possibly including a name and a date.

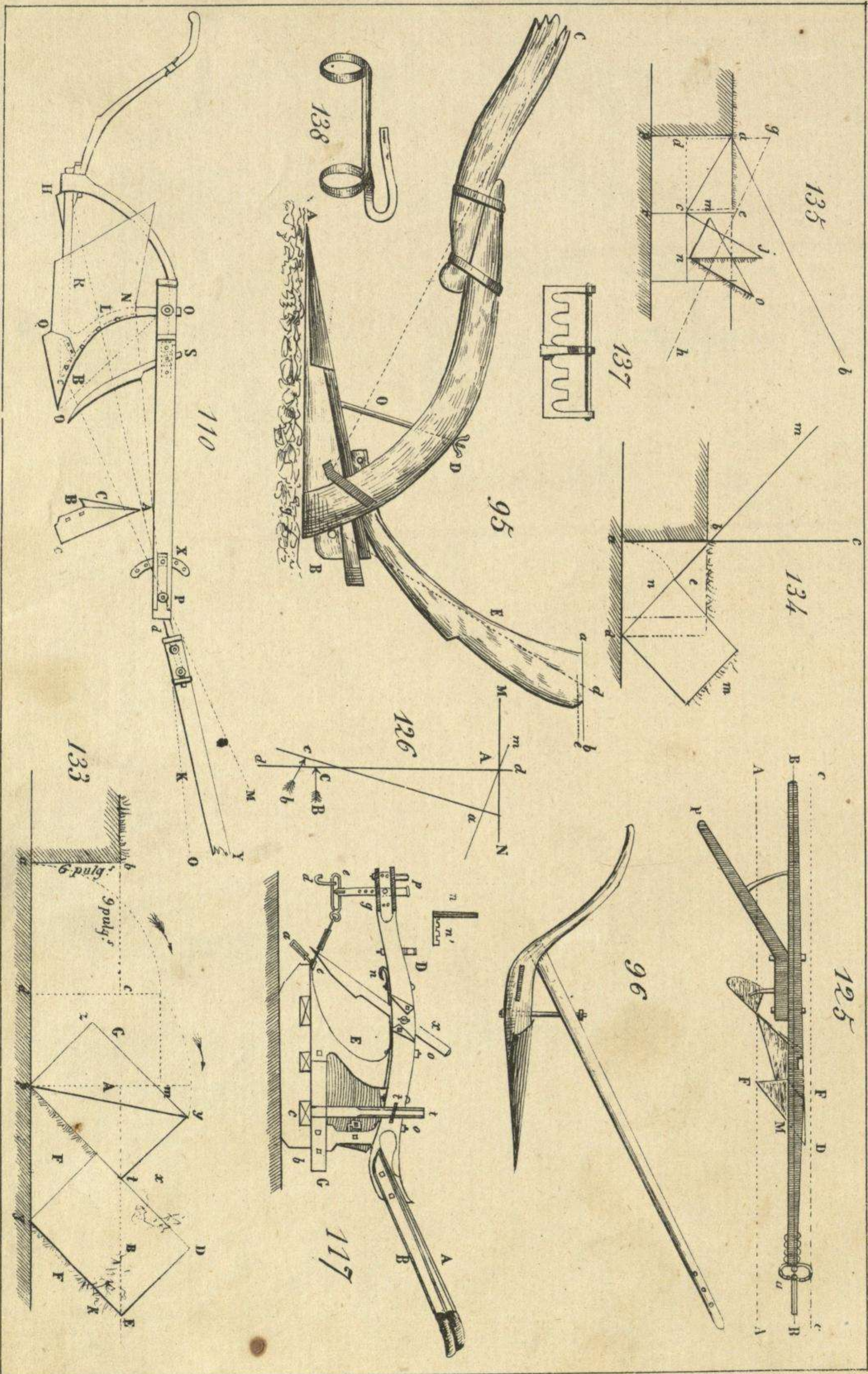




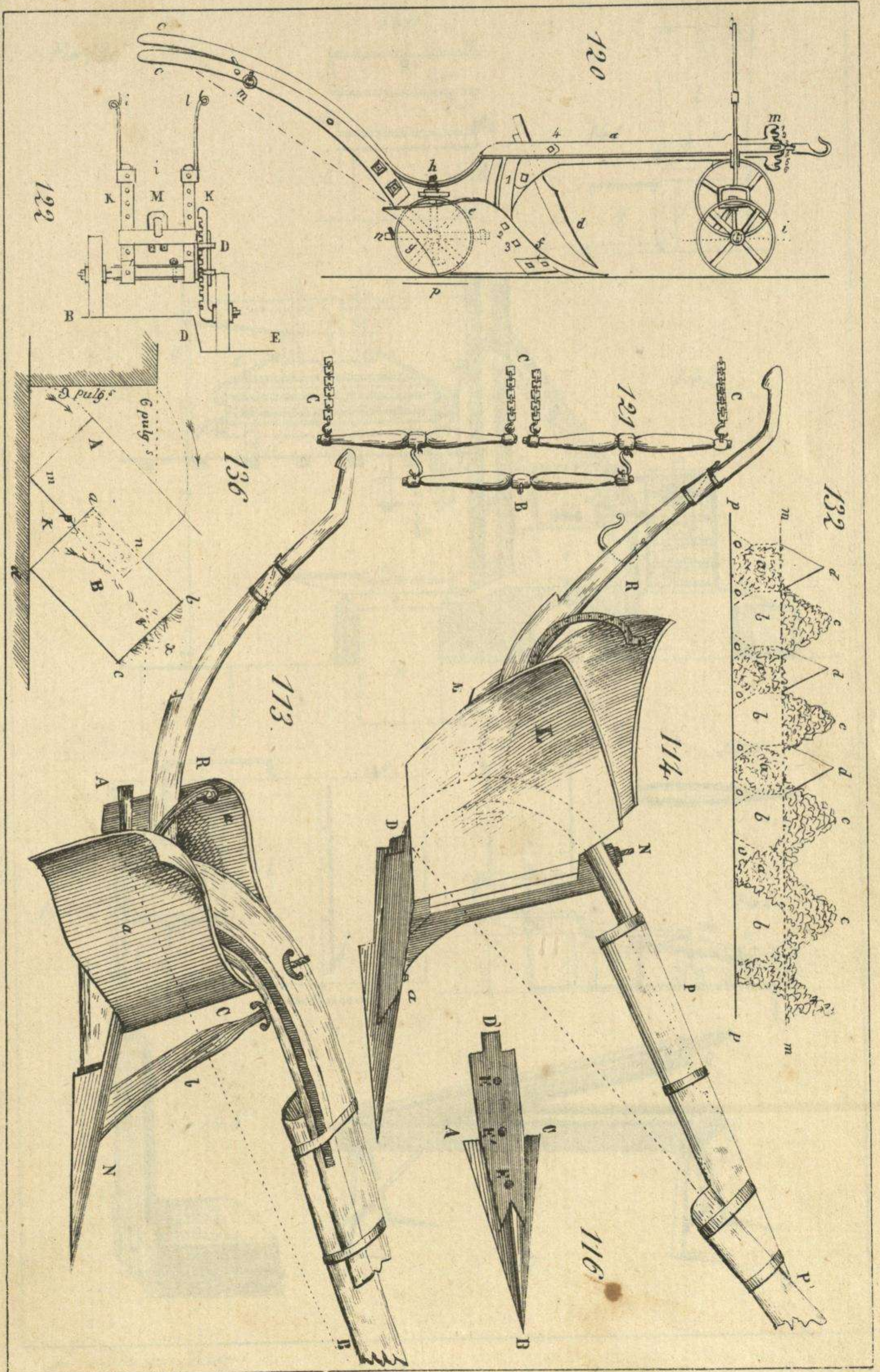
(1) *Diagram of a ship's hull*













Plan of the City of London

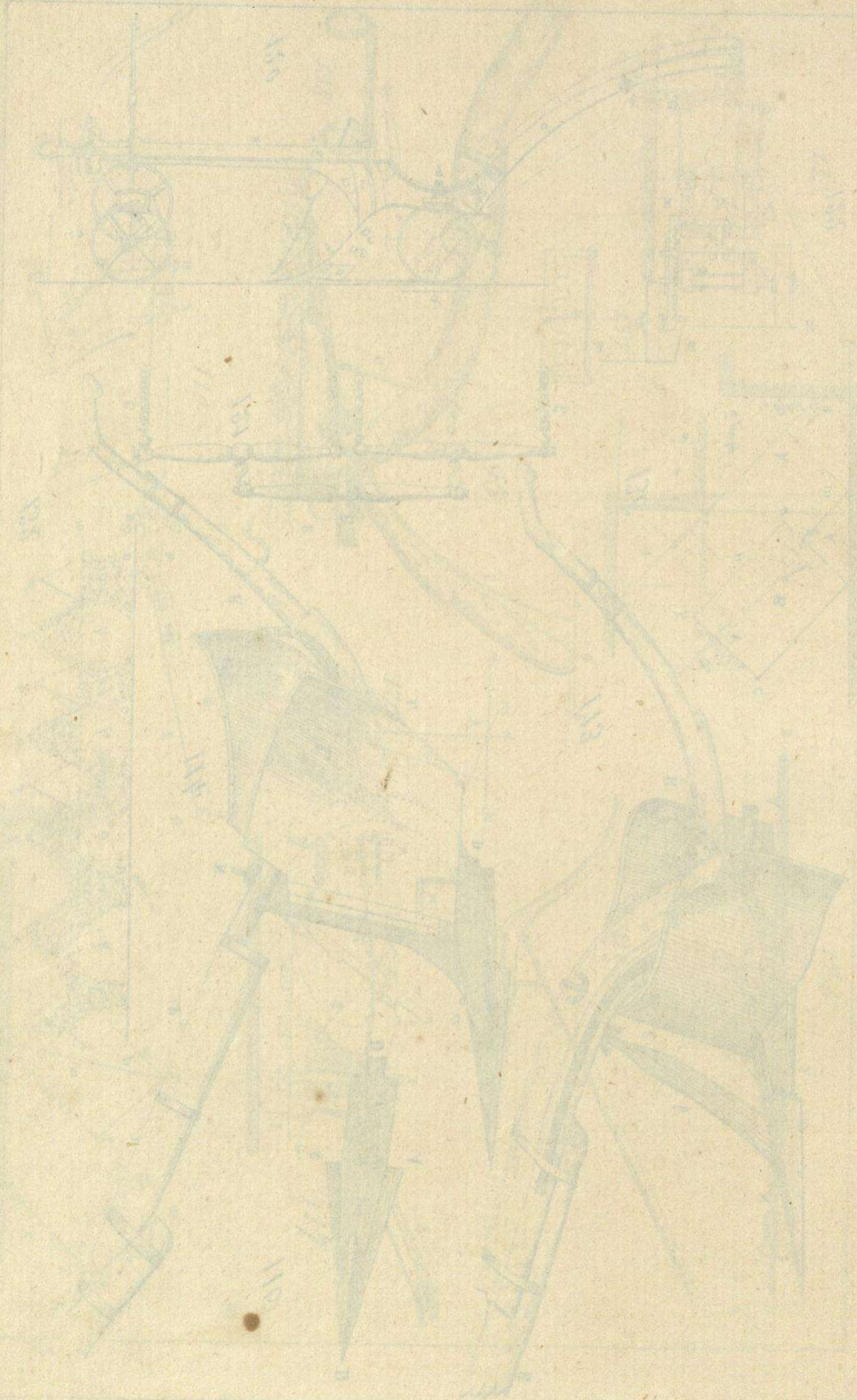
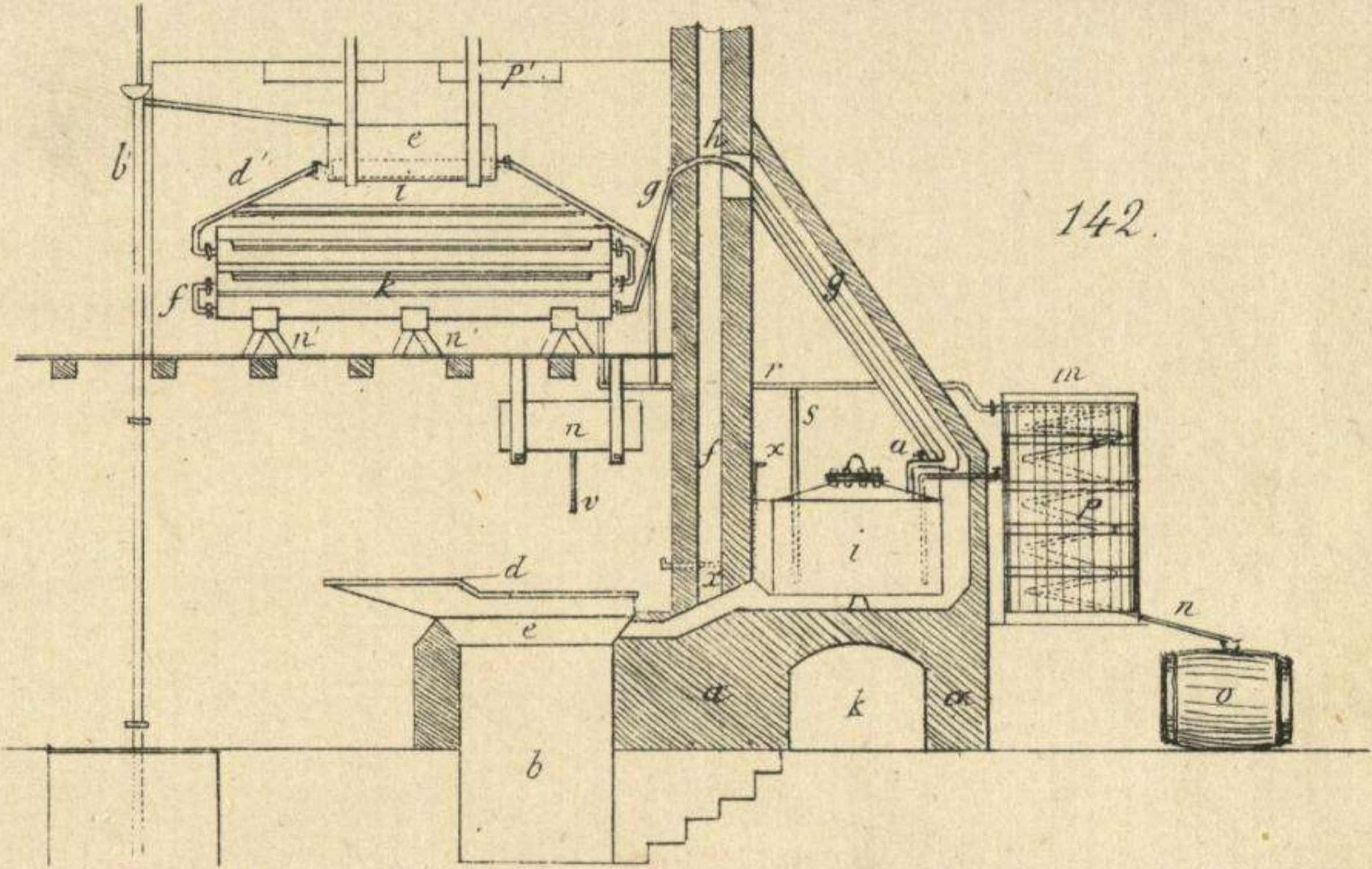
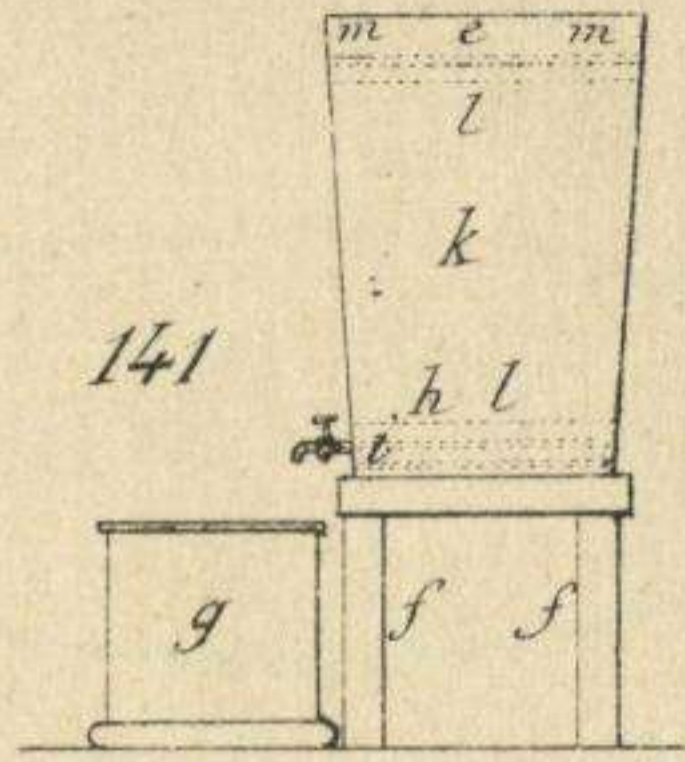
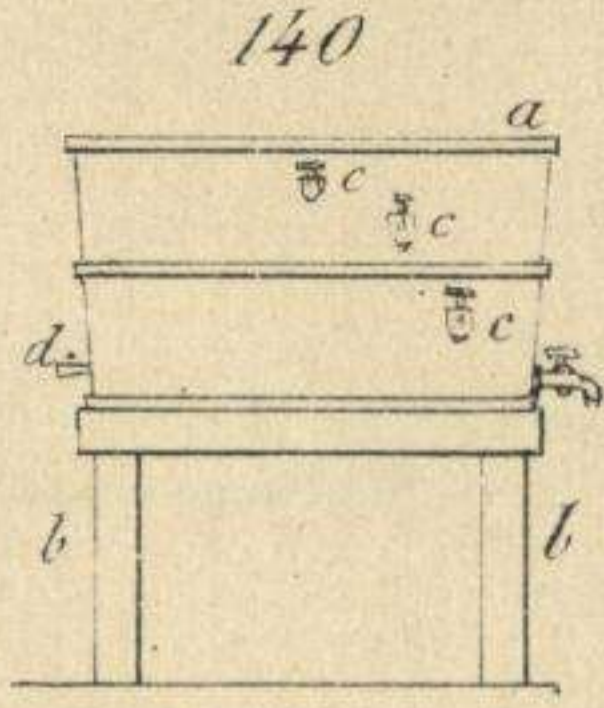
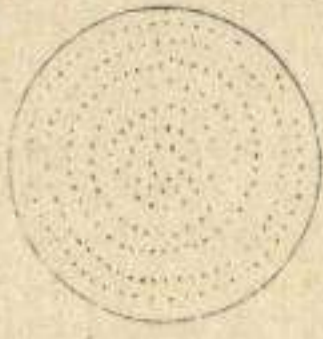
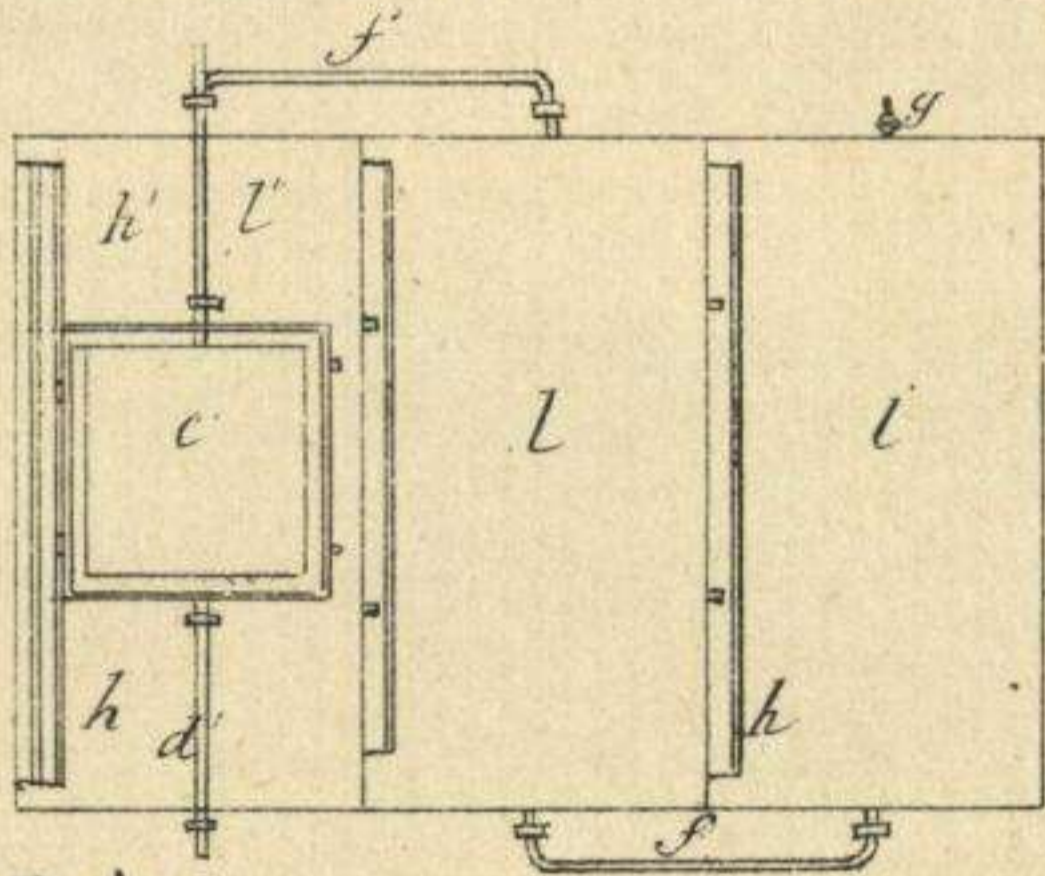




Fig. 139



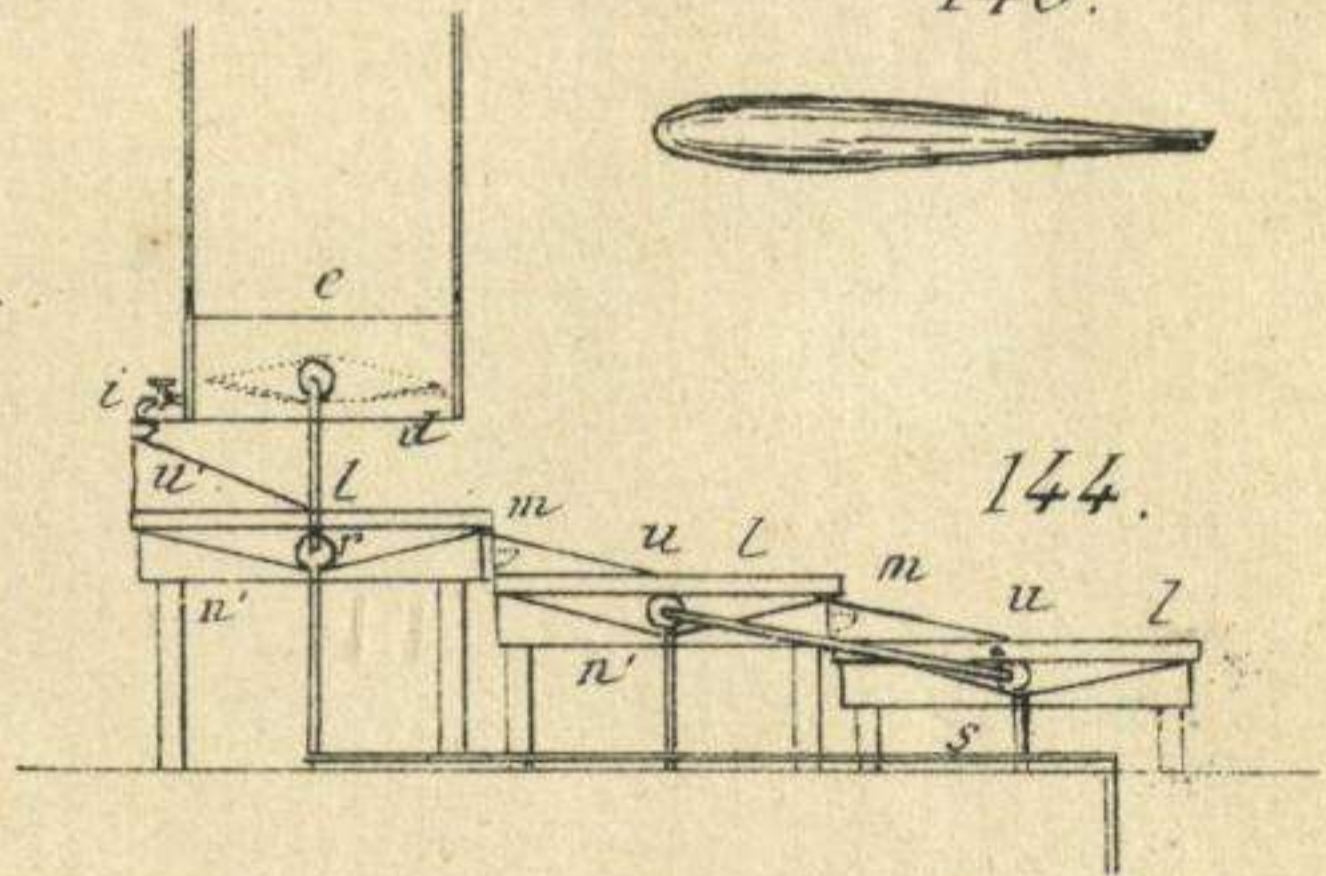
143.



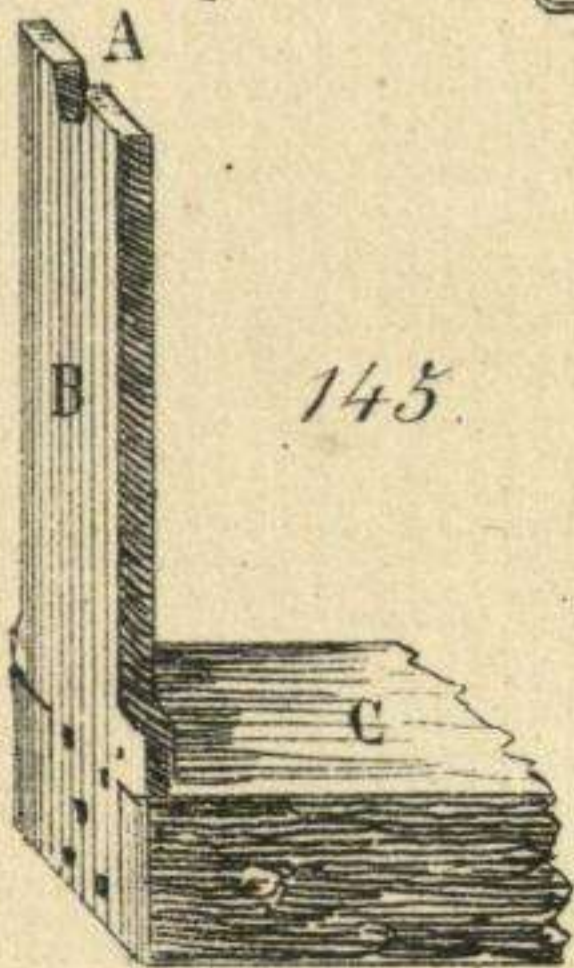
146.



144.



145.



147.

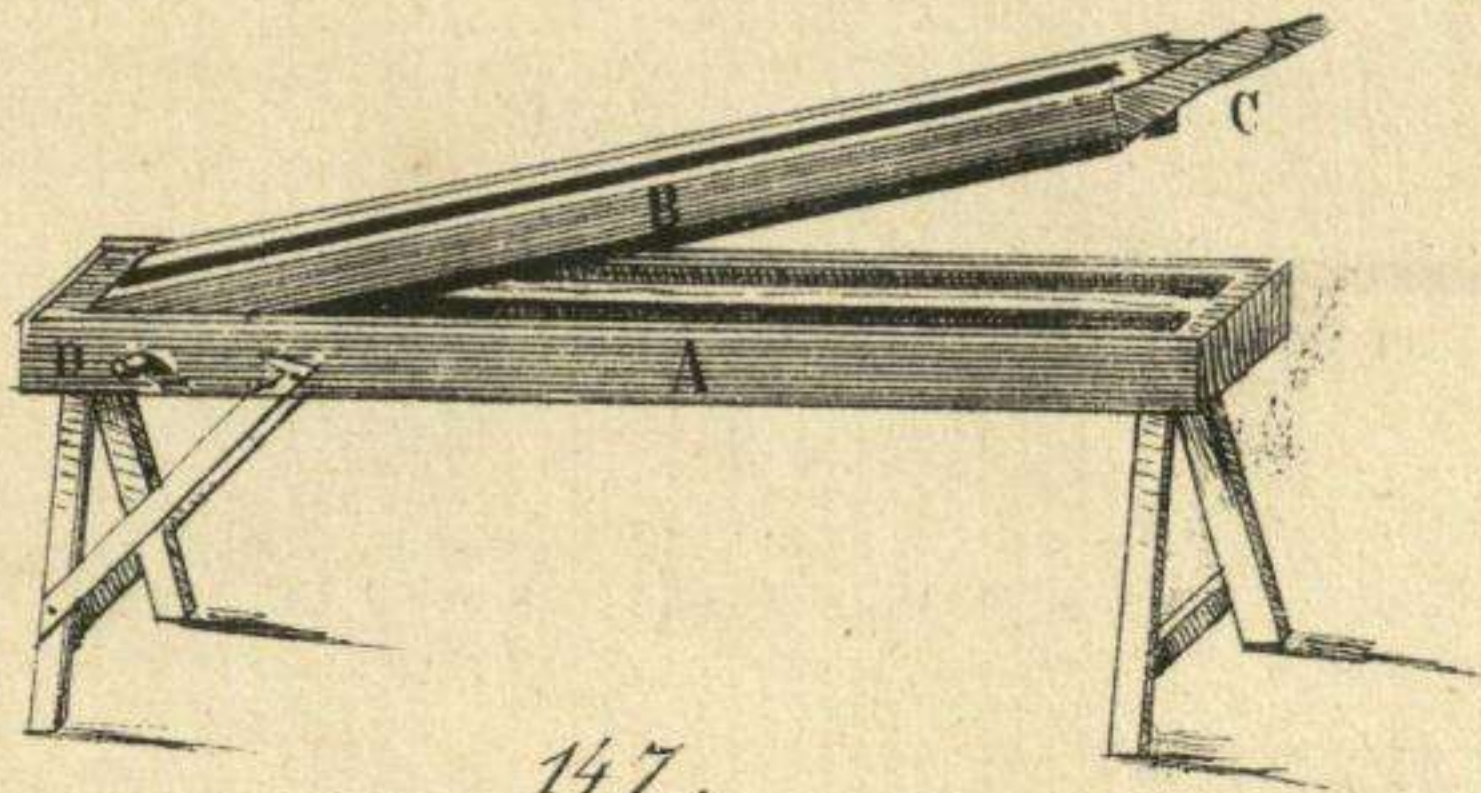




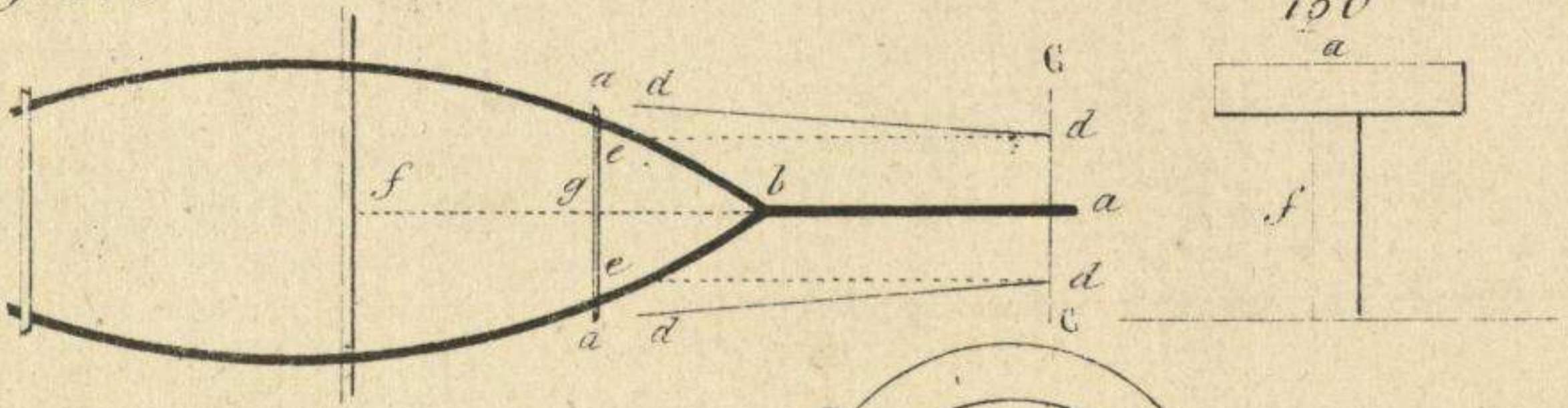




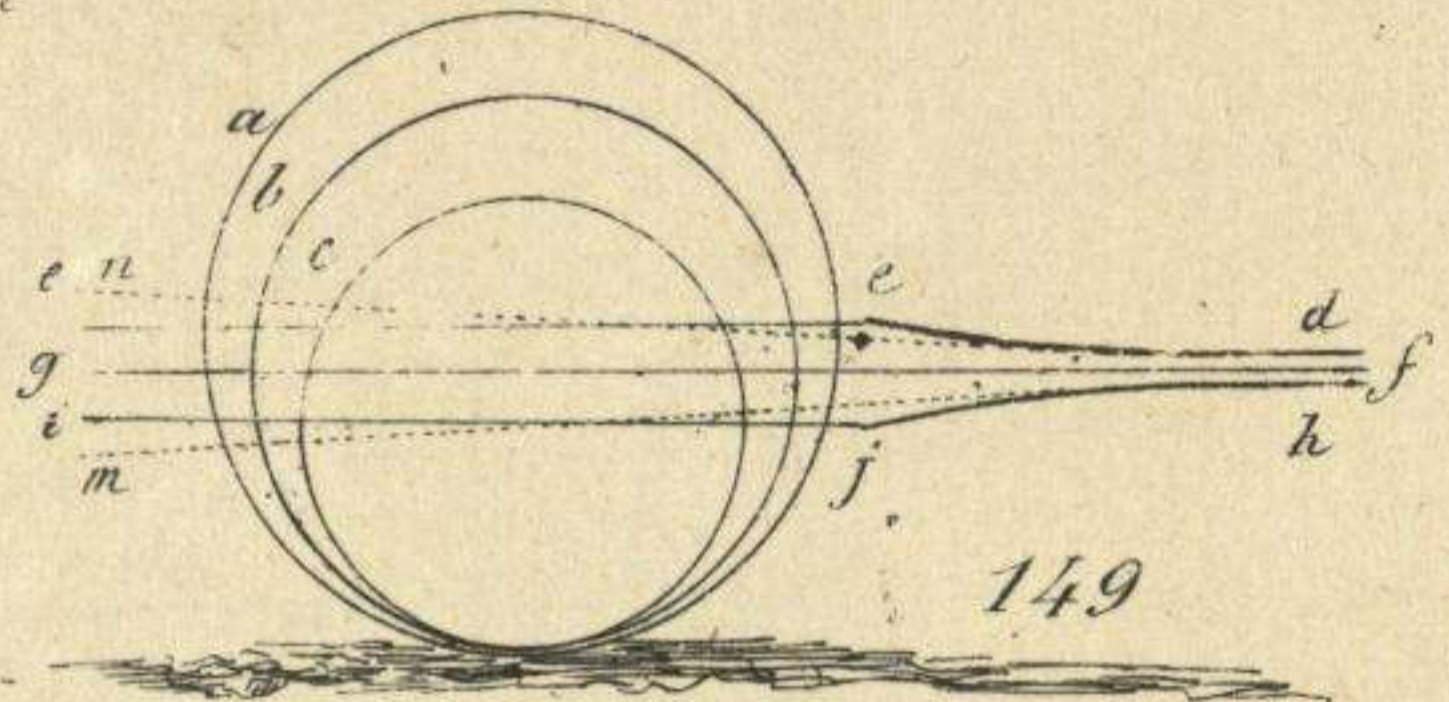
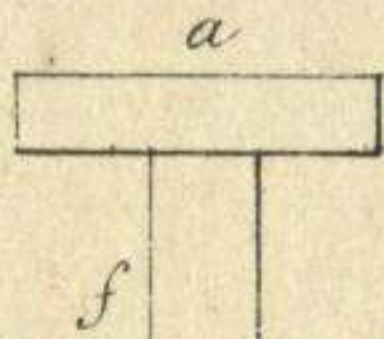




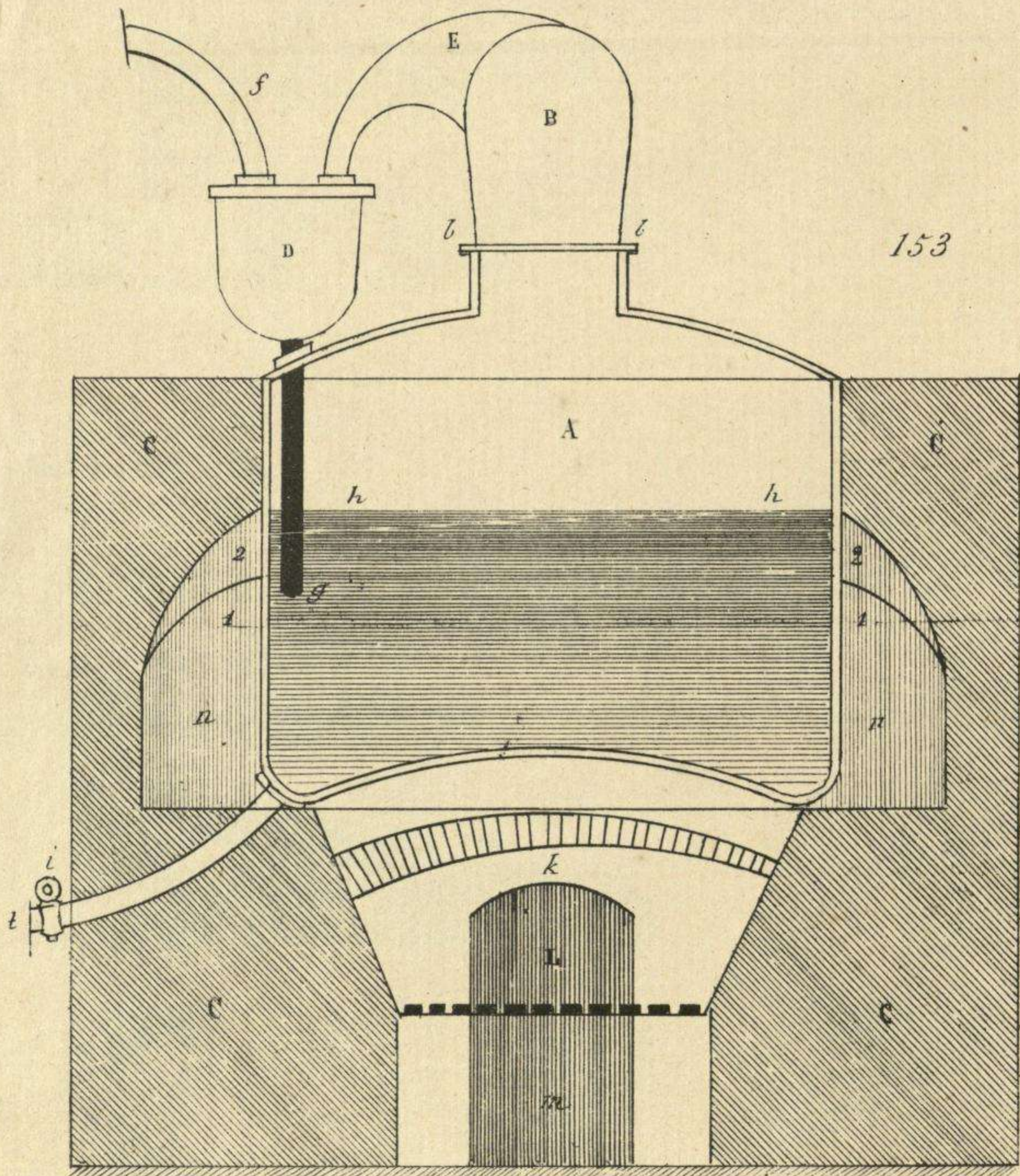
Fig. 148



151



149



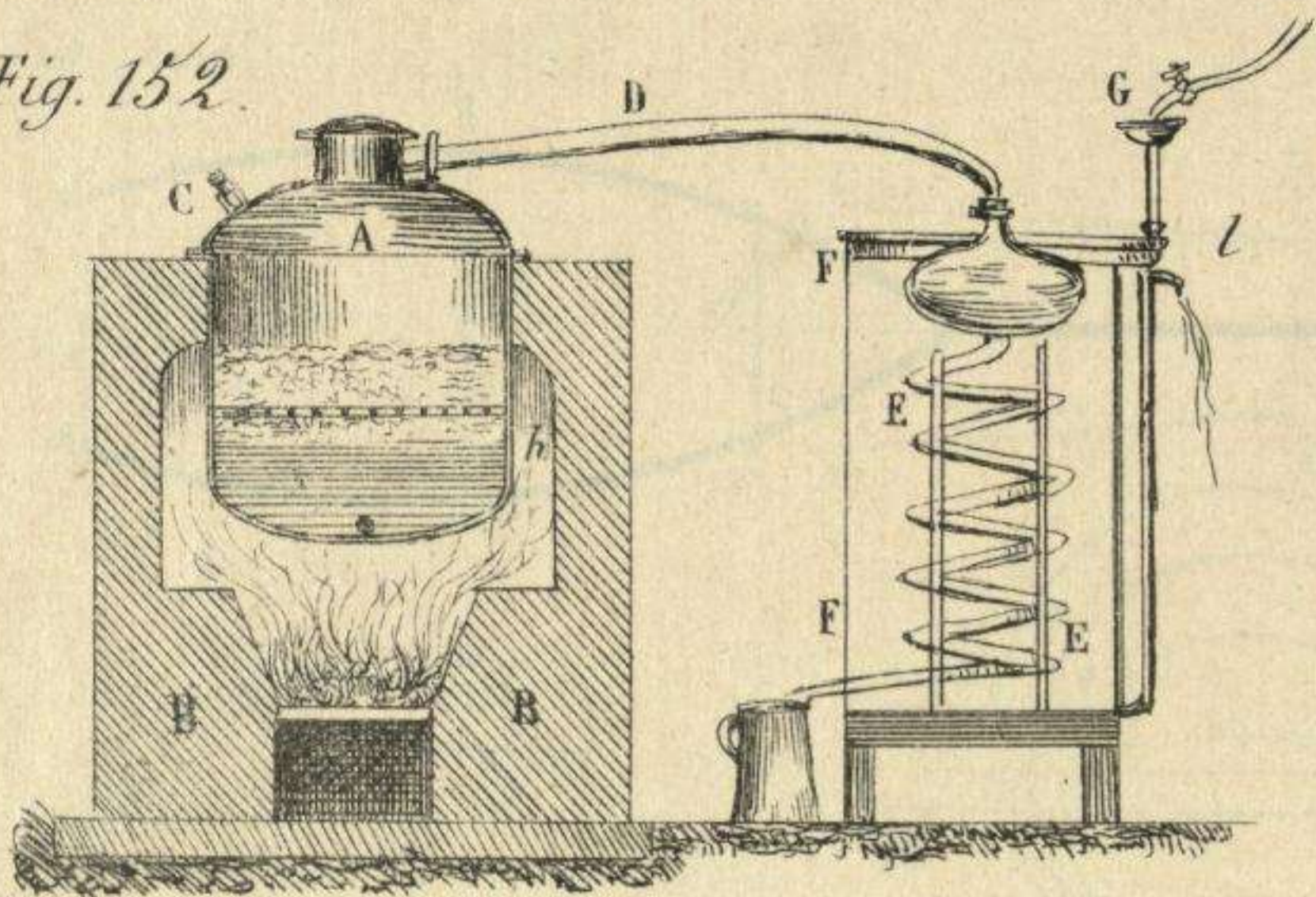
153



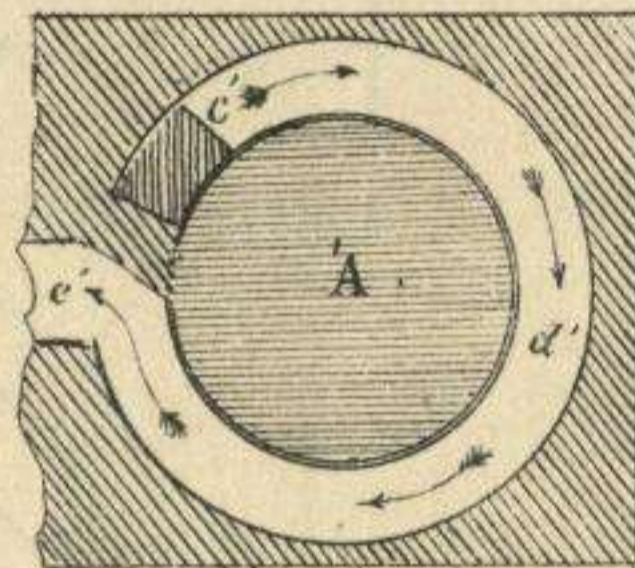




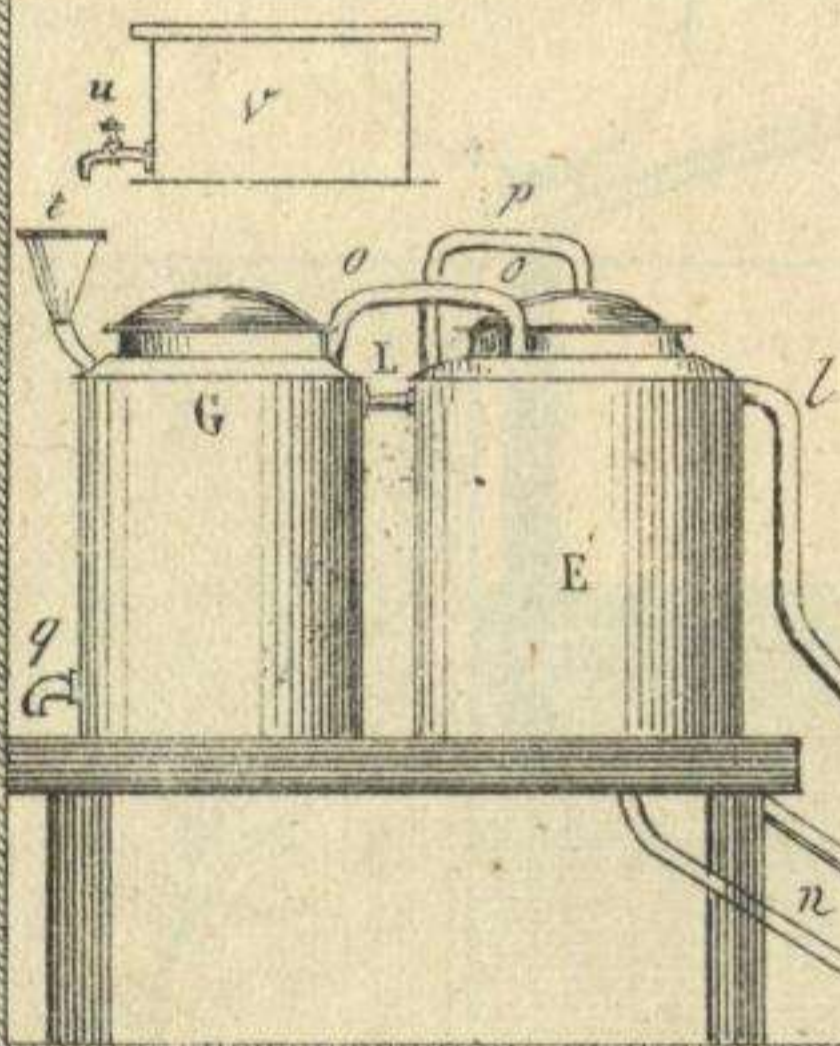
Fig. 152.



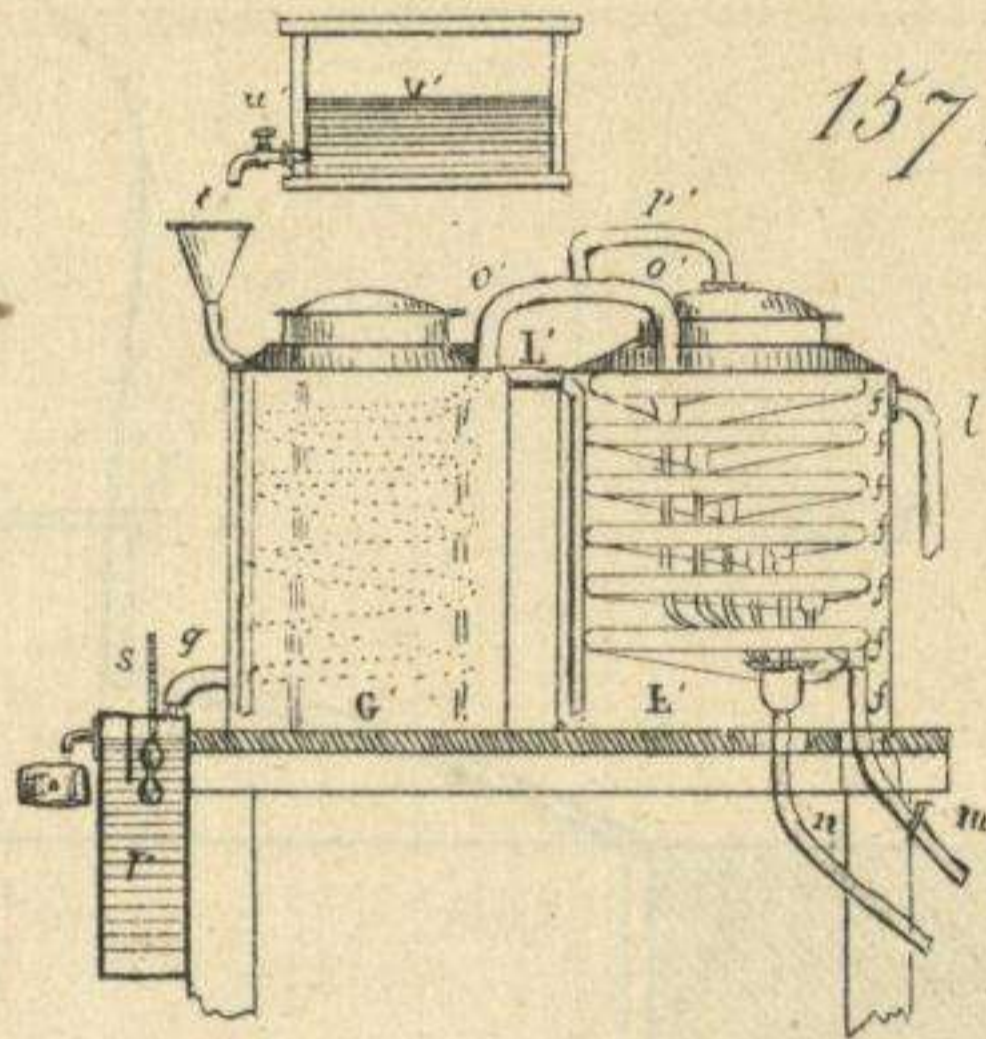
155



156.



157.



154.

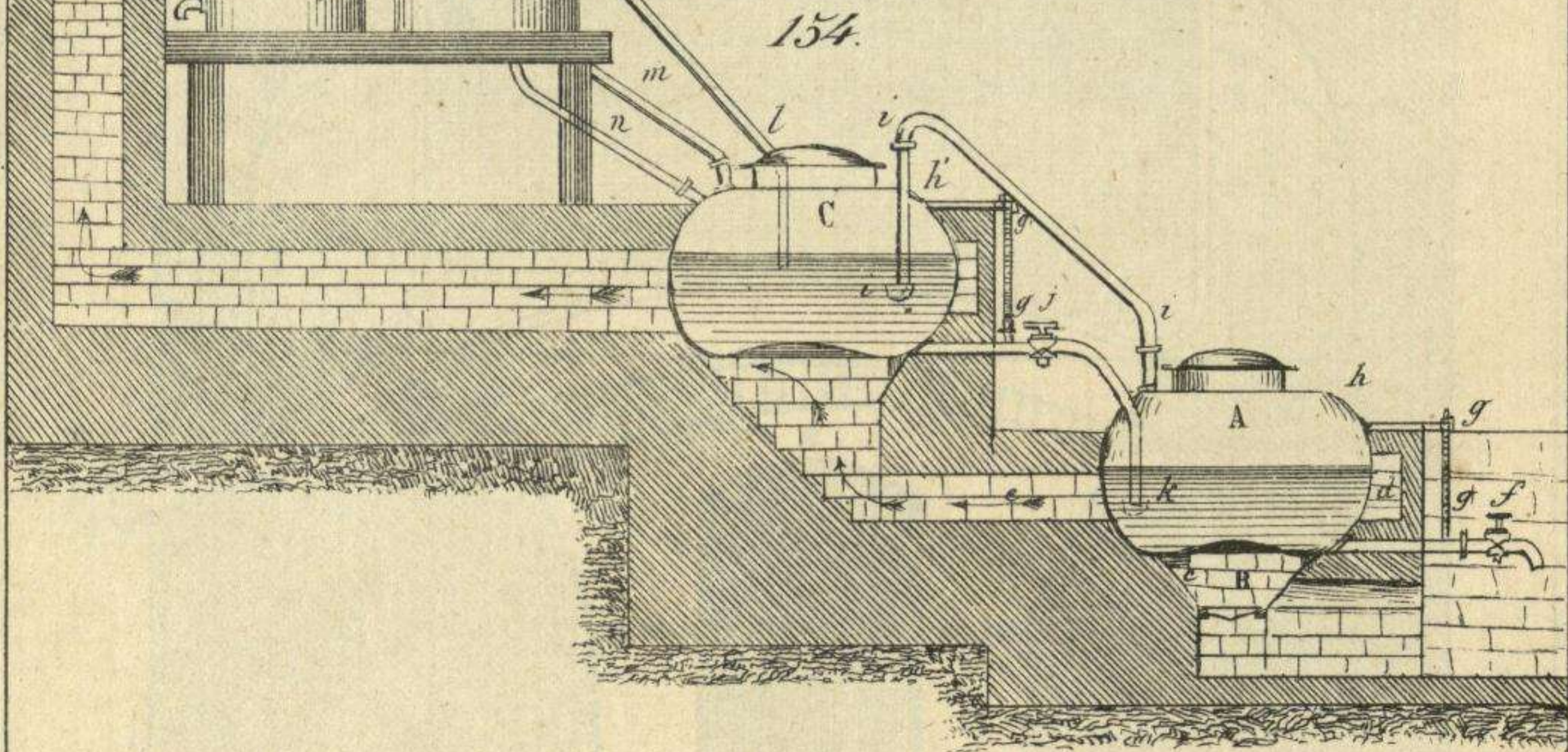
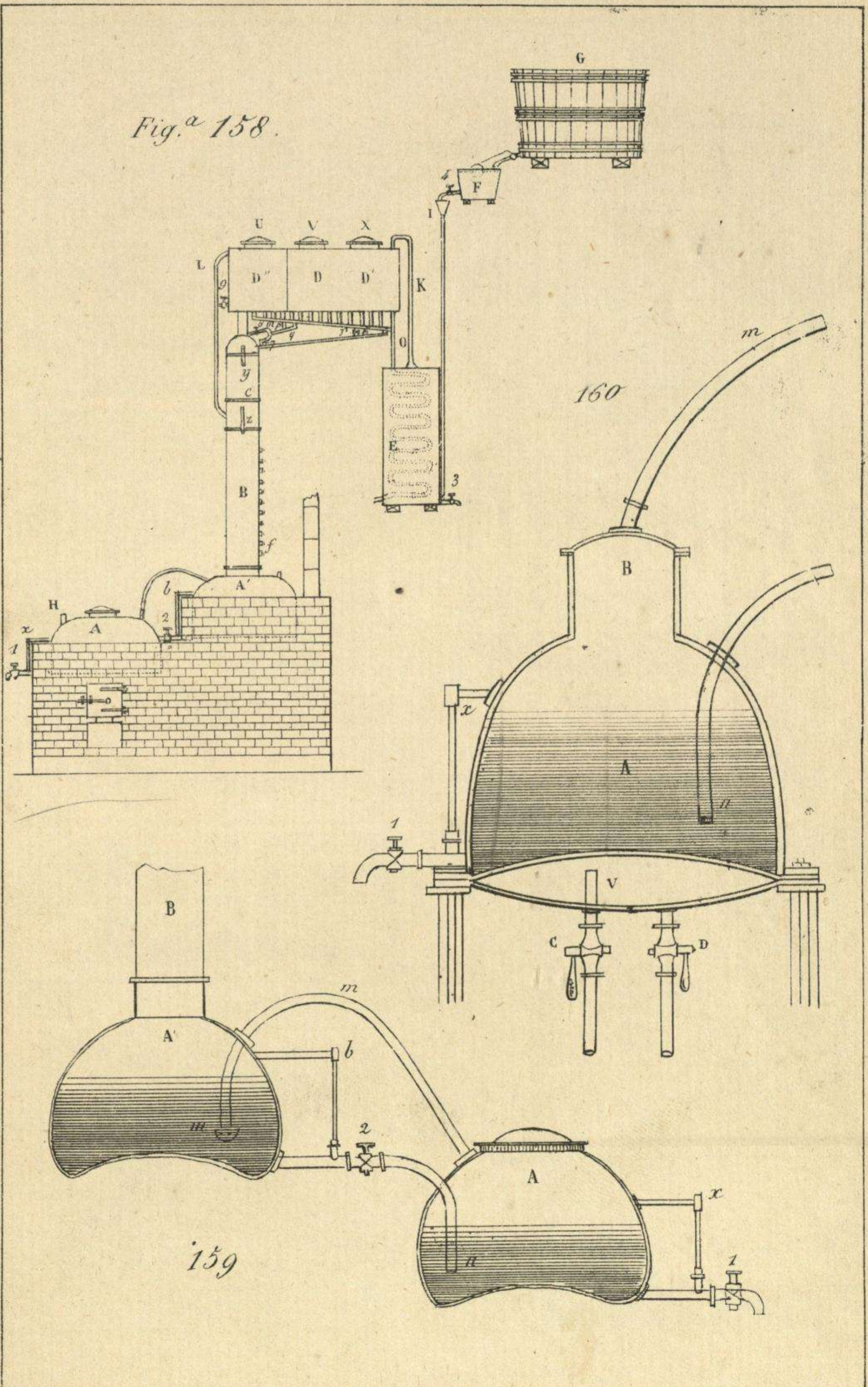




Fig.<sup>a</sup> 158.

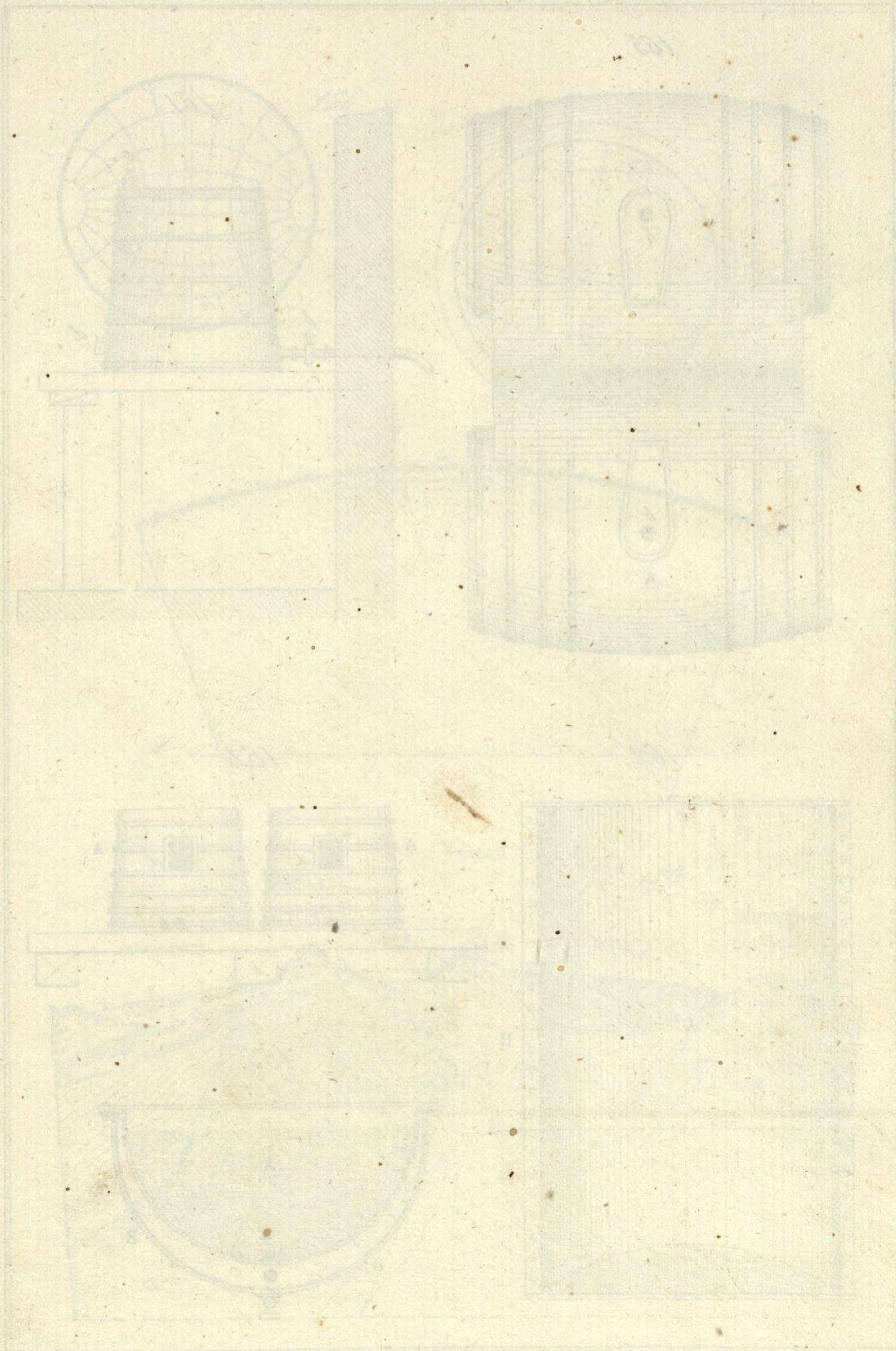






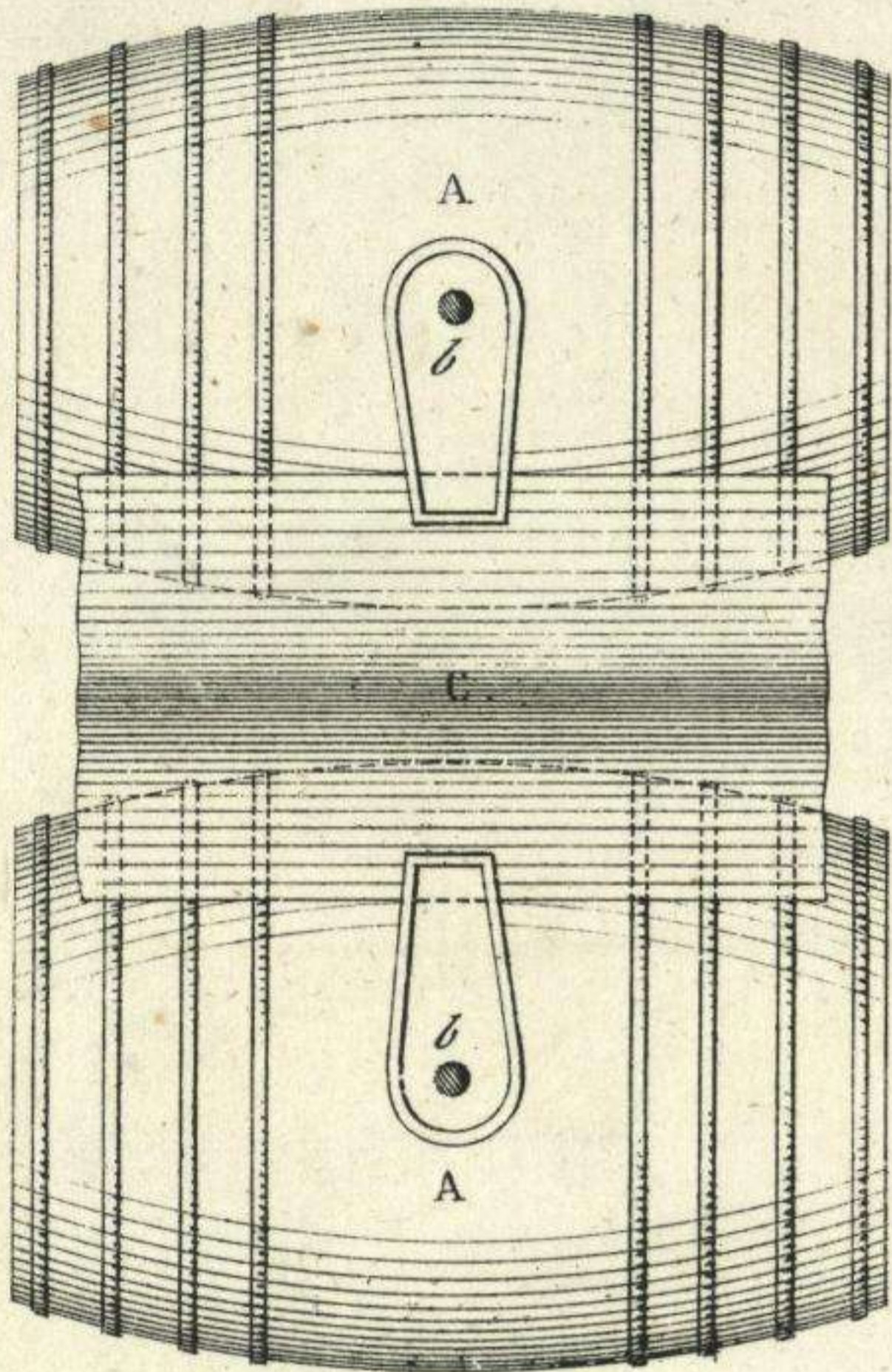


*Handwritten title or text at the top of the page, possibly a name or date, written in a cursive script.*

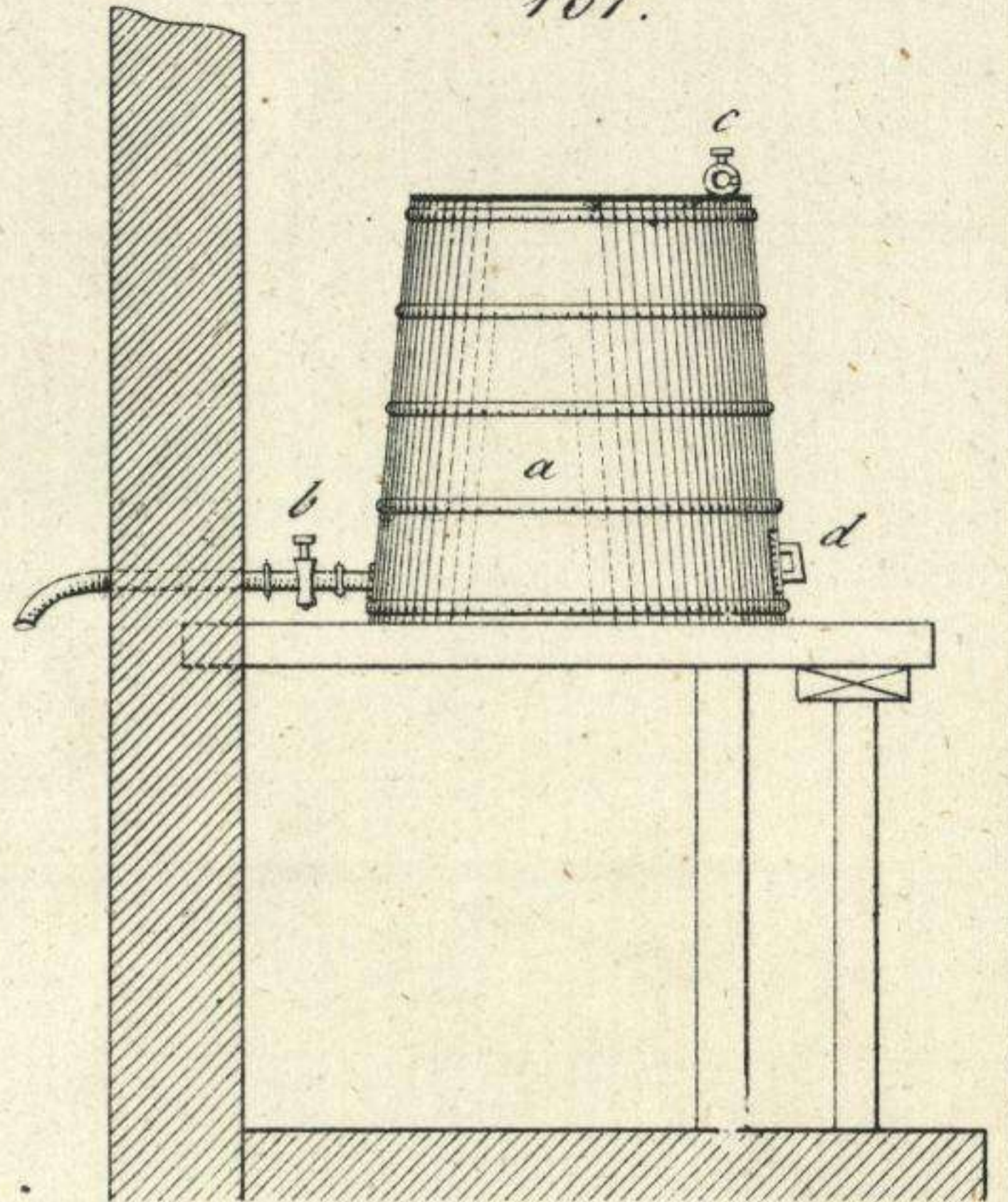




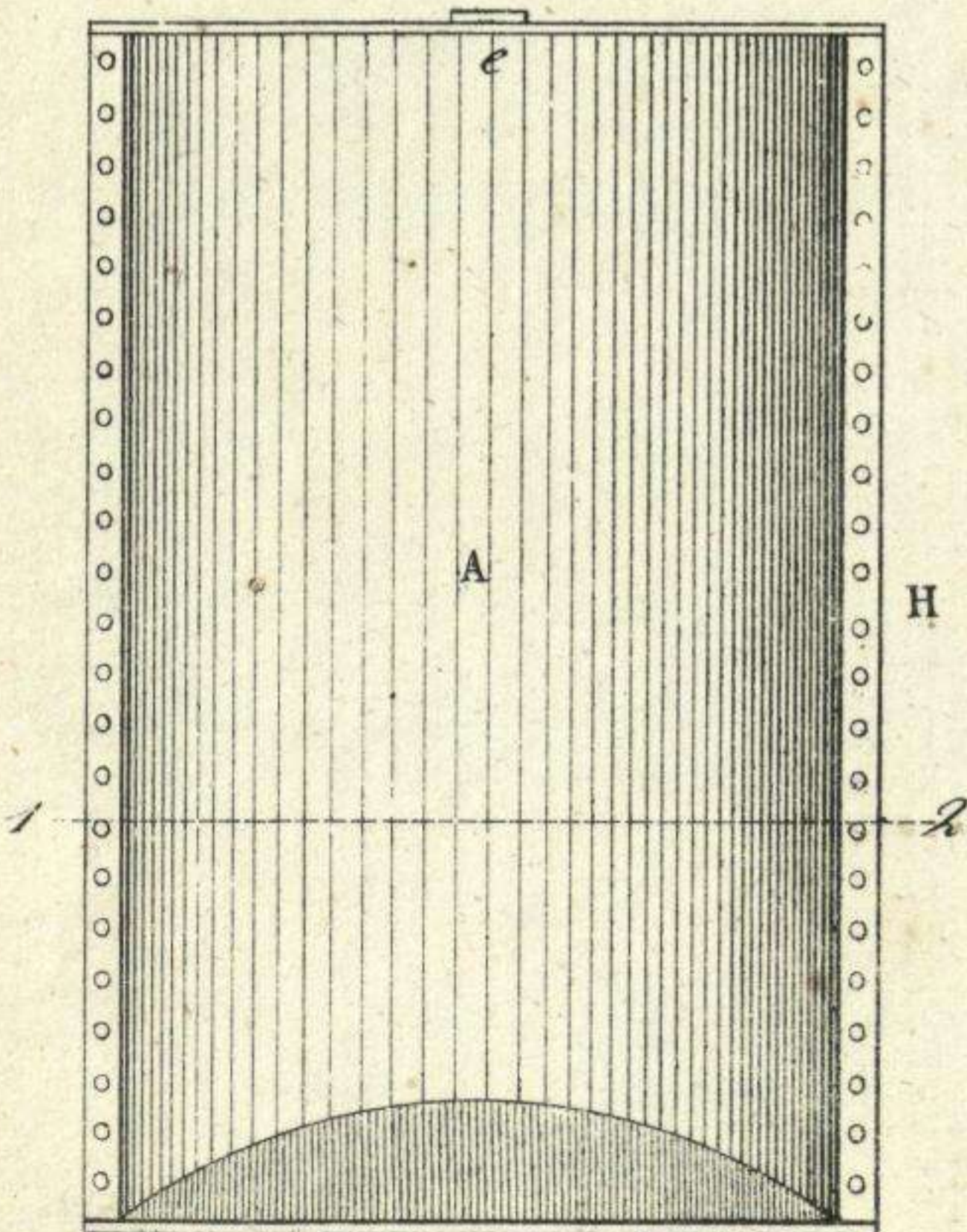
165.



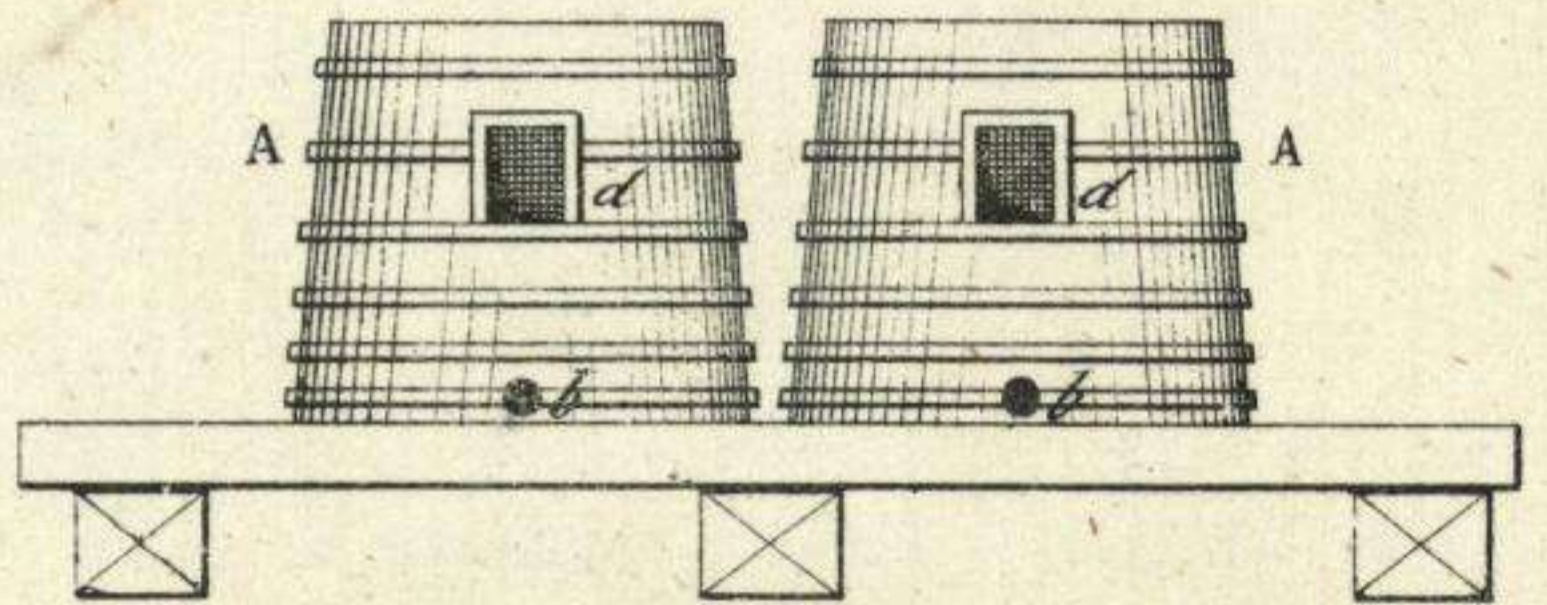
161.



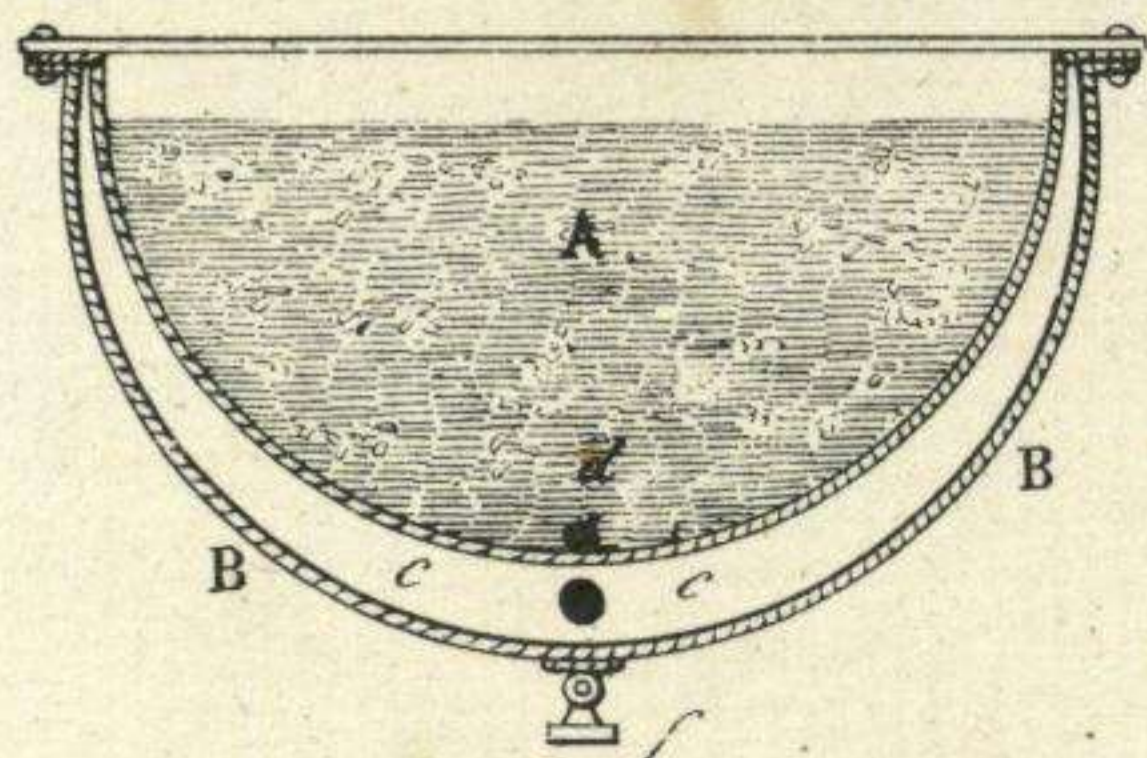
162.



164.

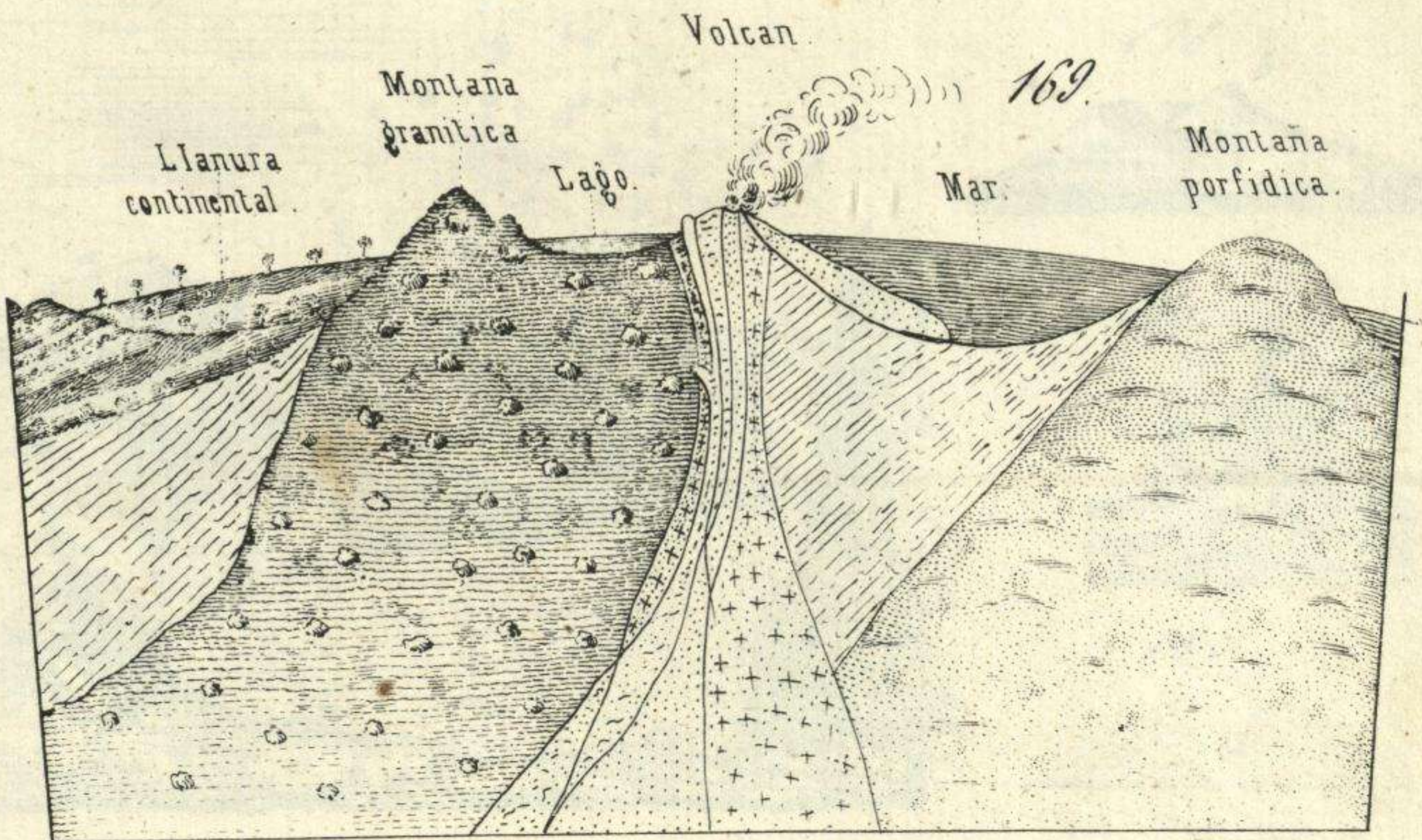
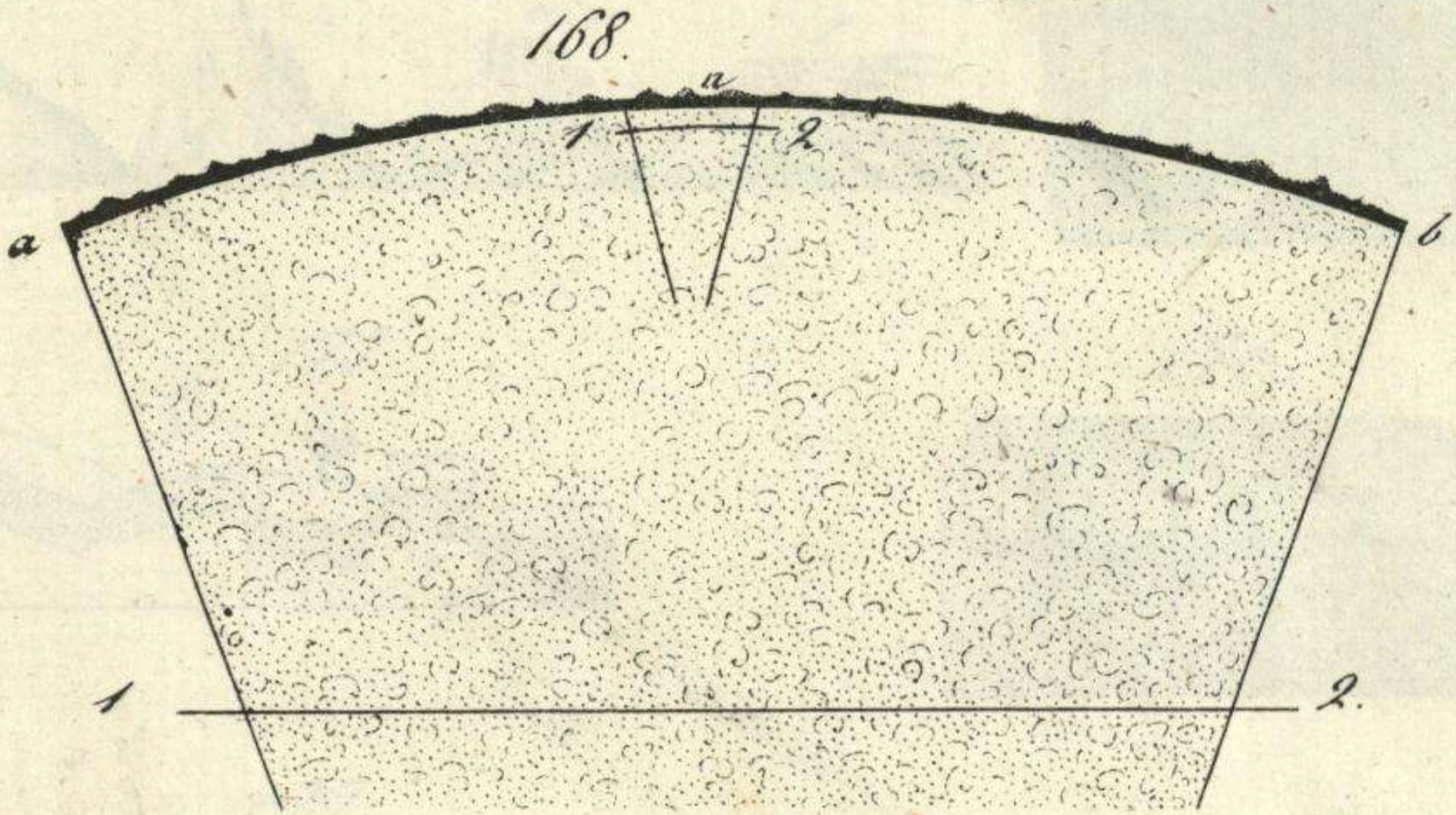
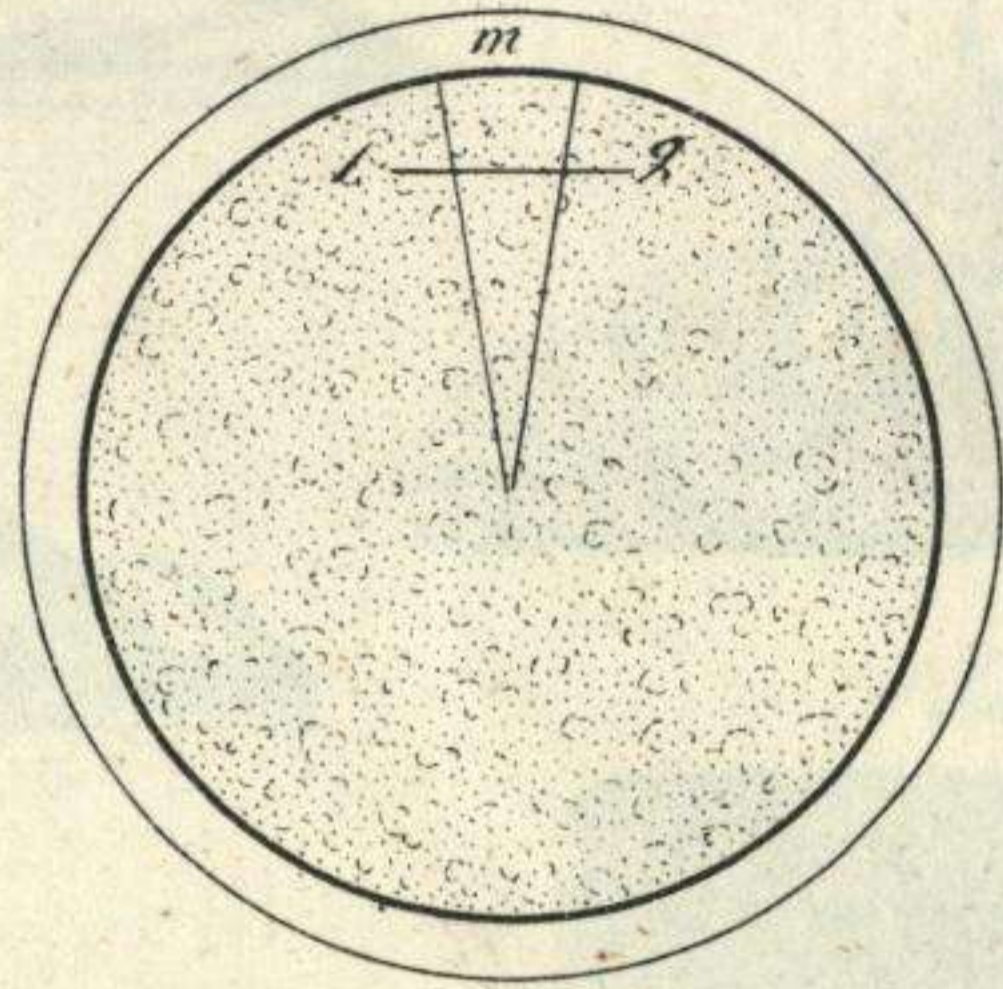
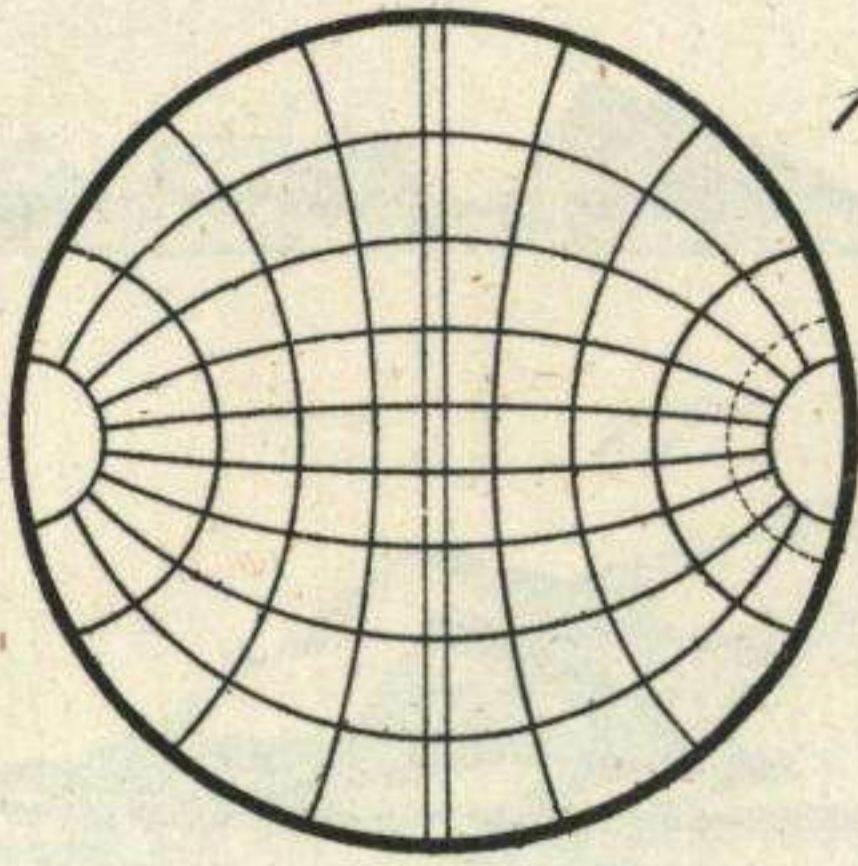


163.



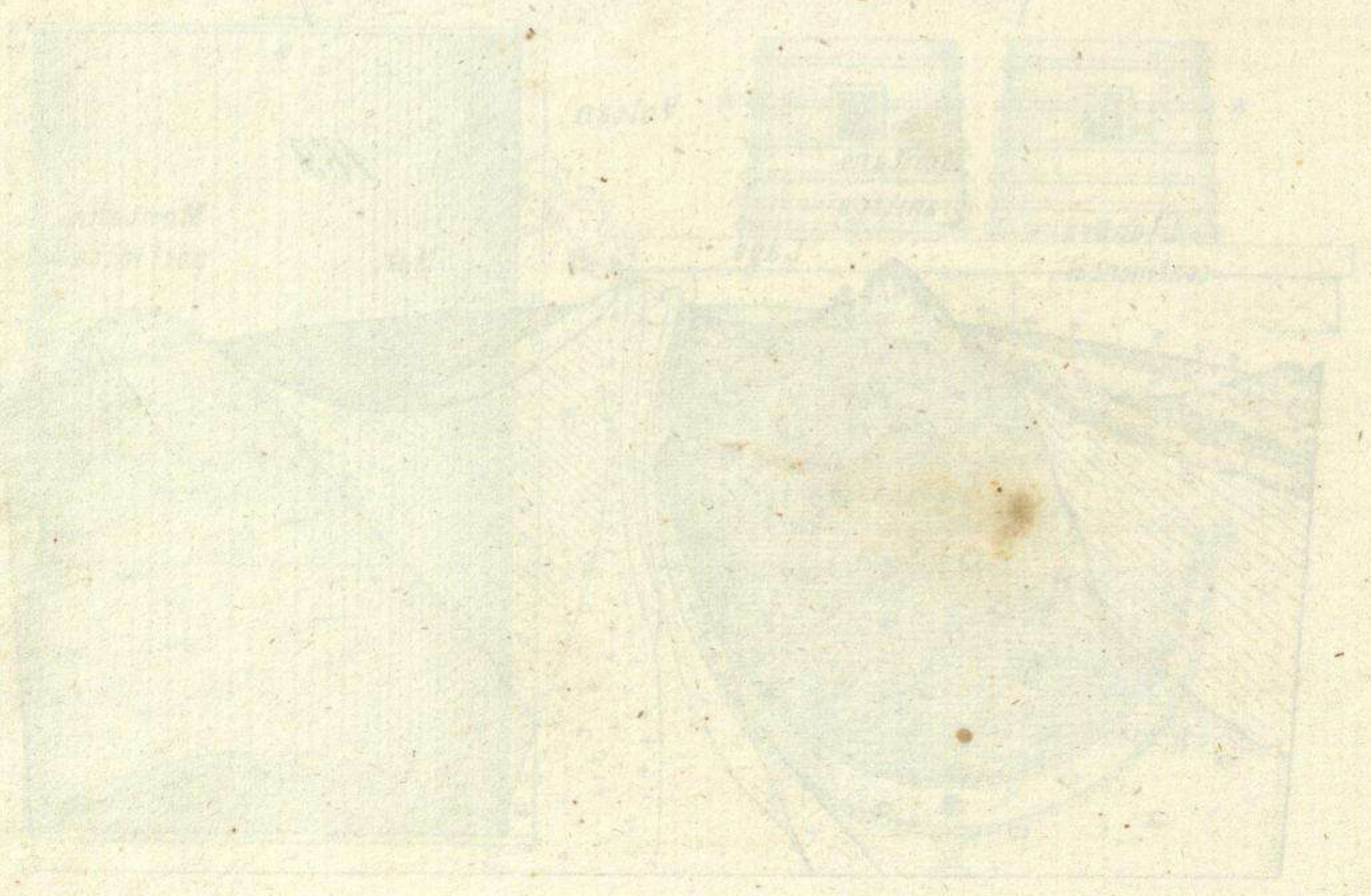
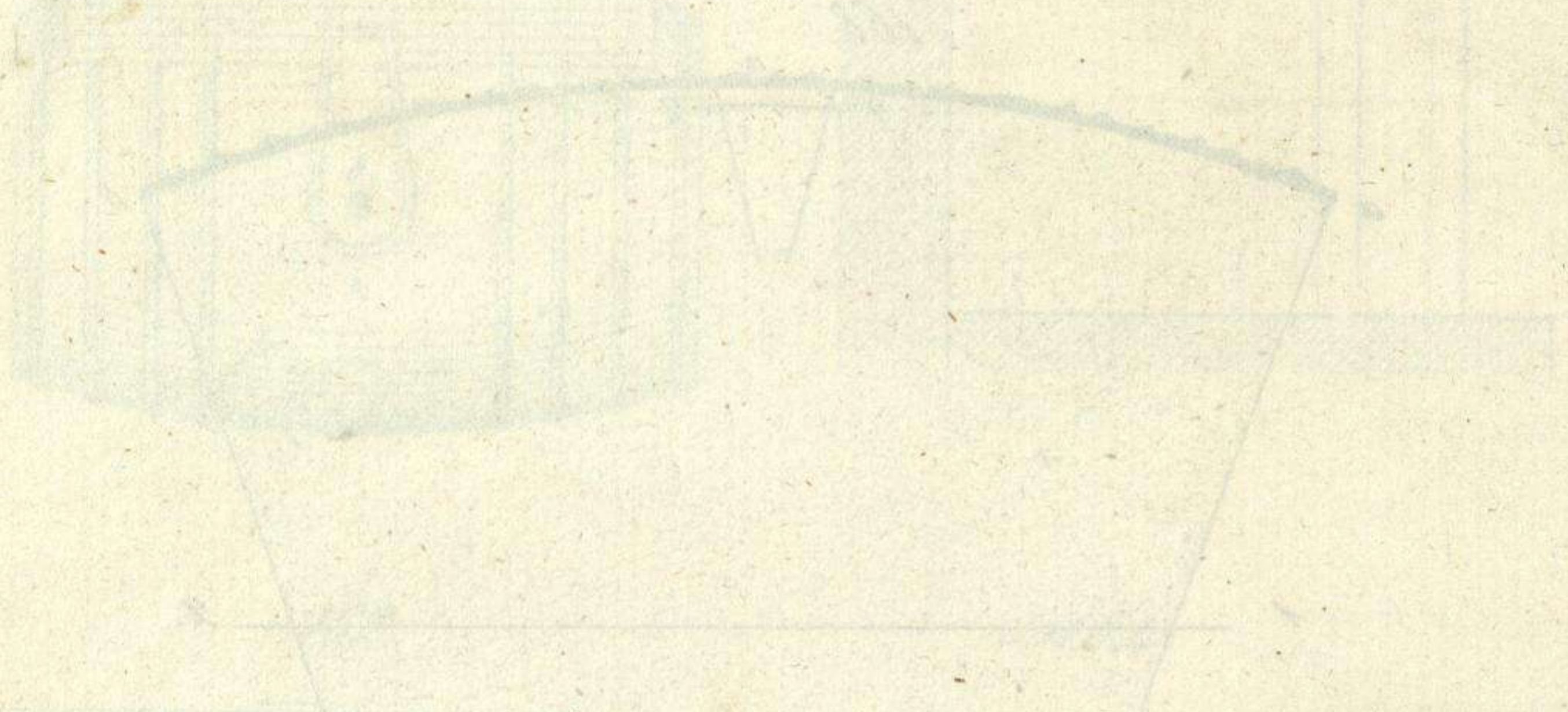
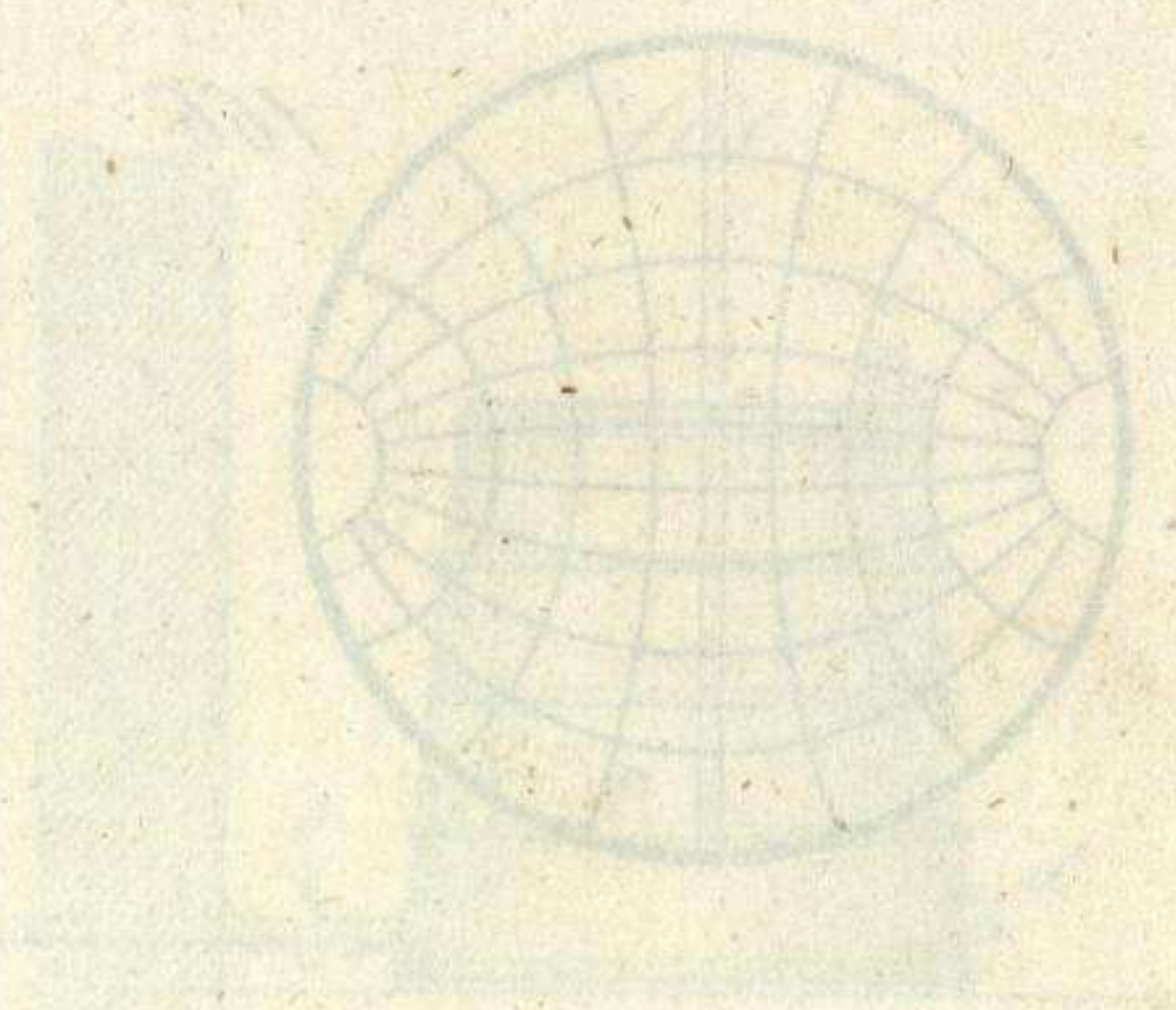
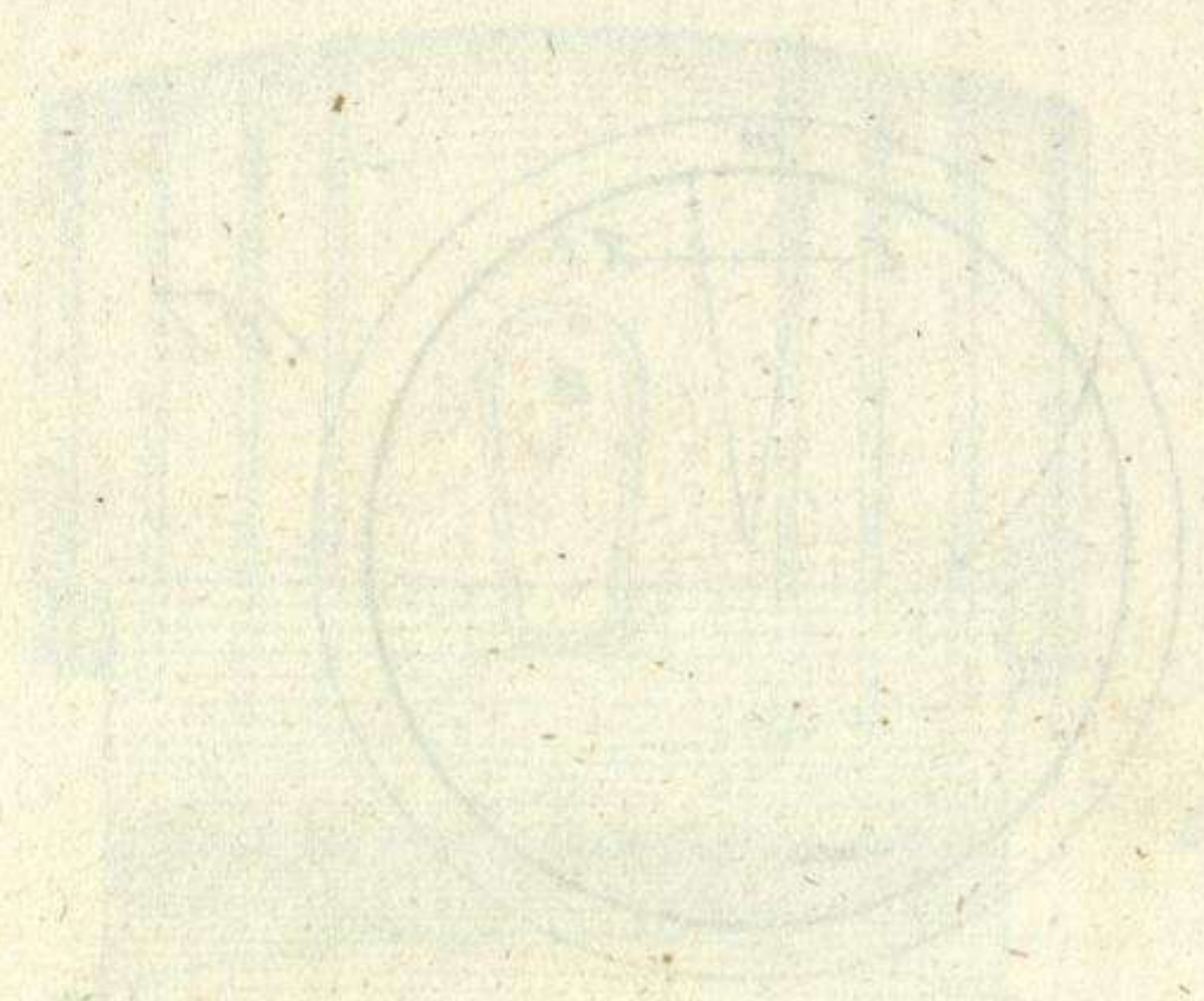


# Diccionario de Agricultura.





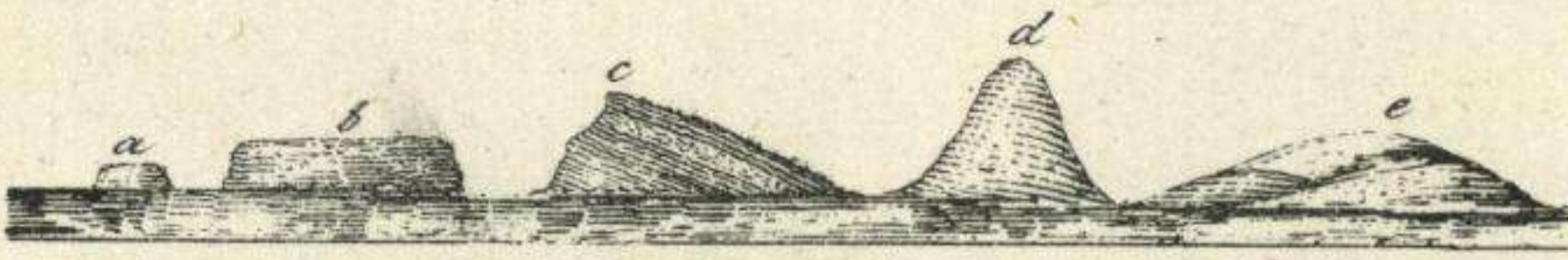
*Handwritten title or text at the top of the page, possibly a name or date, which is faint and difficult to decipher.*





# Diccionario de Agricultura.

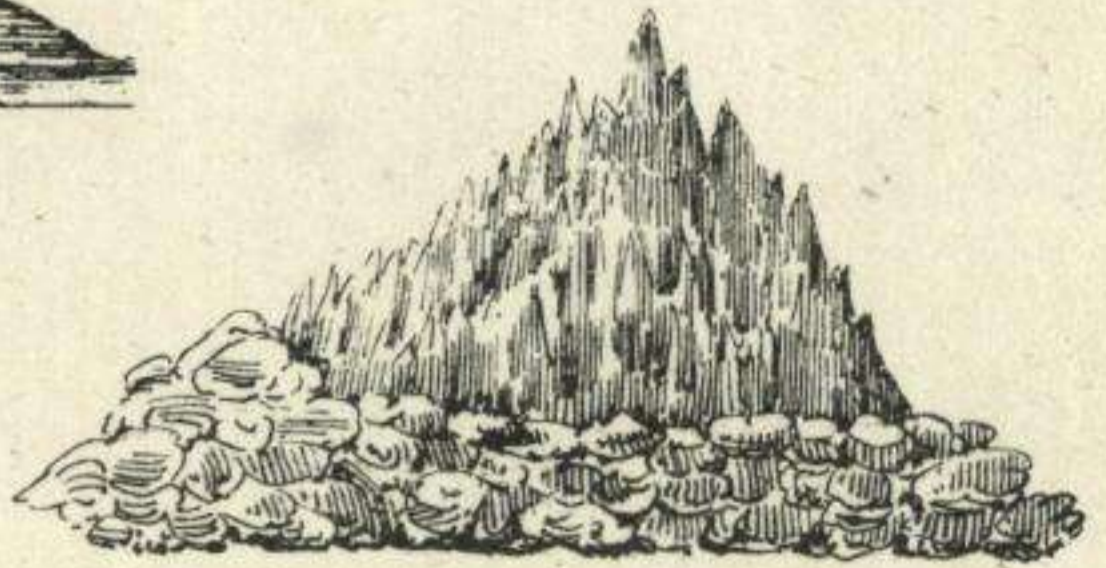
170.



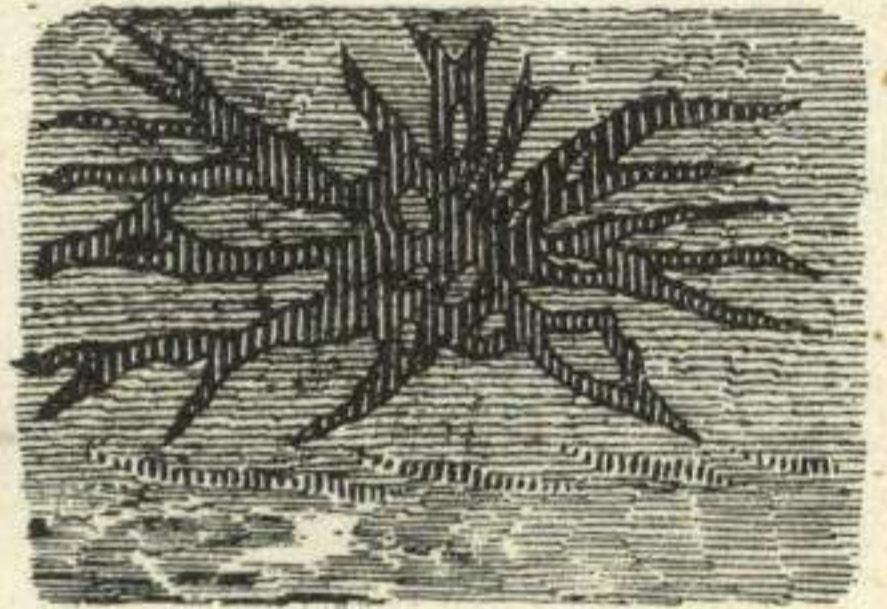
171.



173.



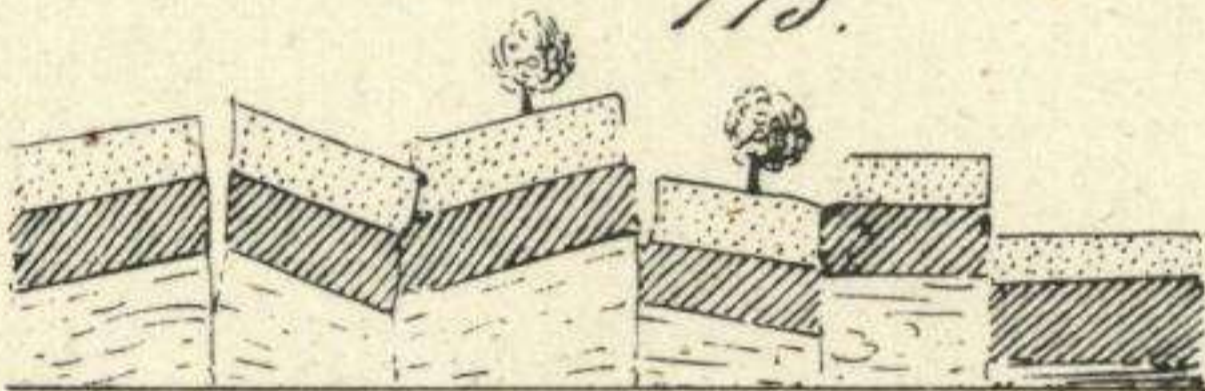
174.



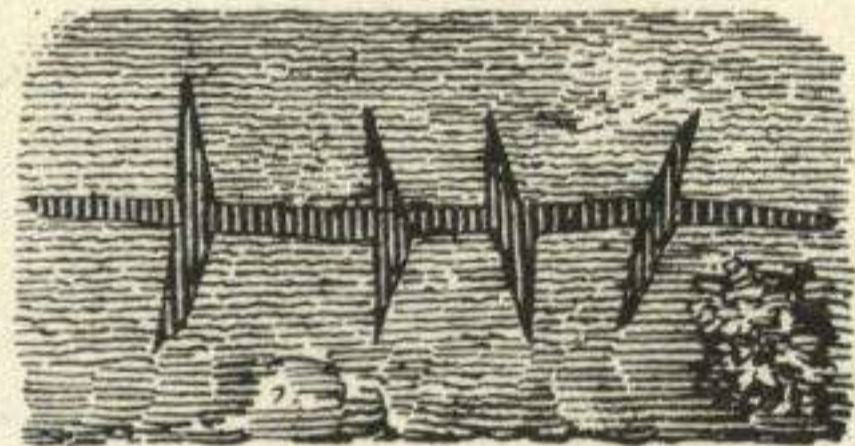
172.



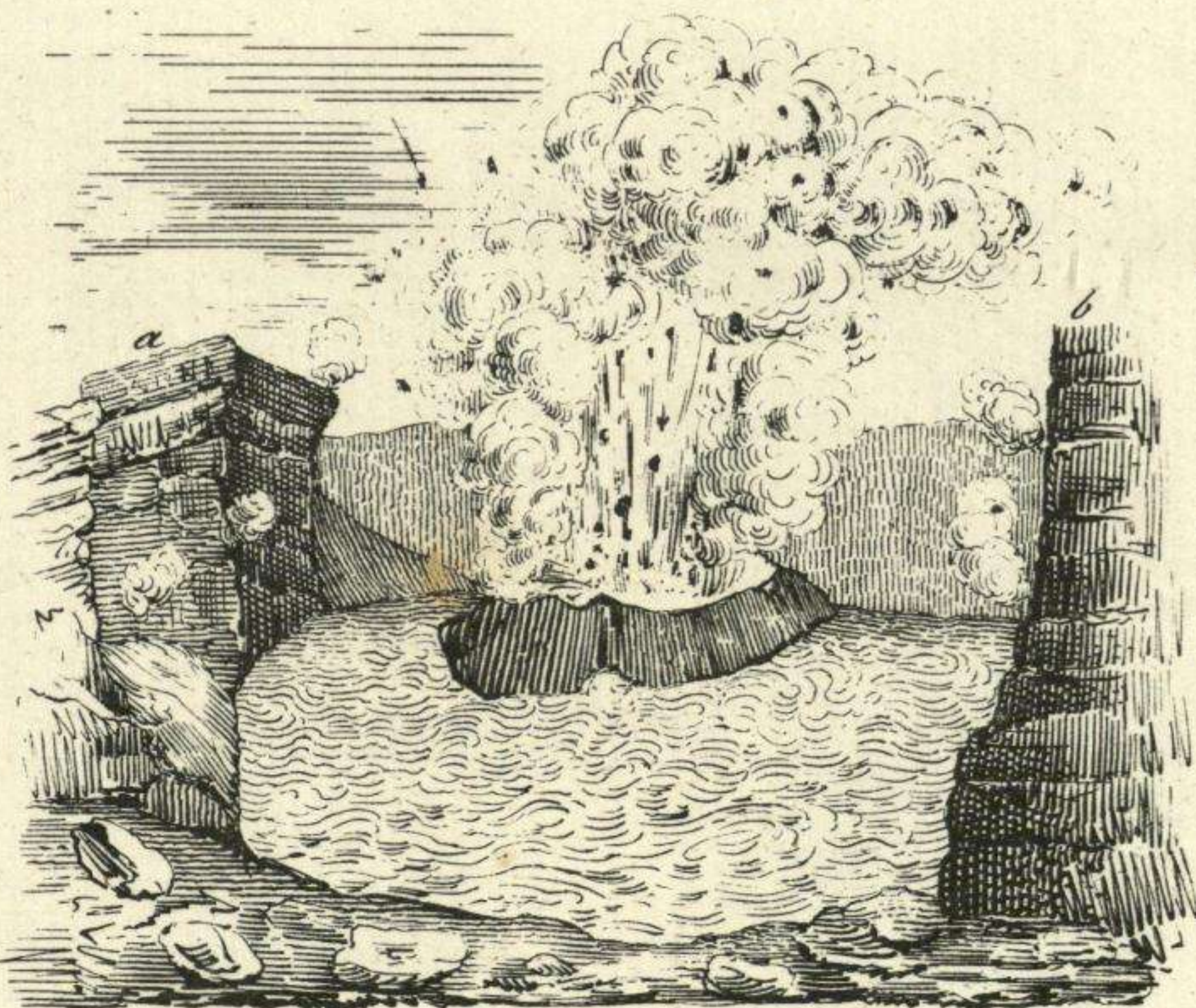
175.



176.



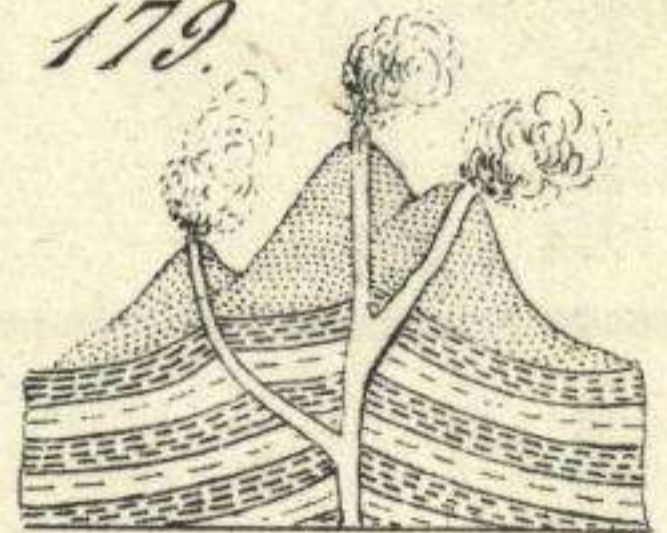
177.



178.



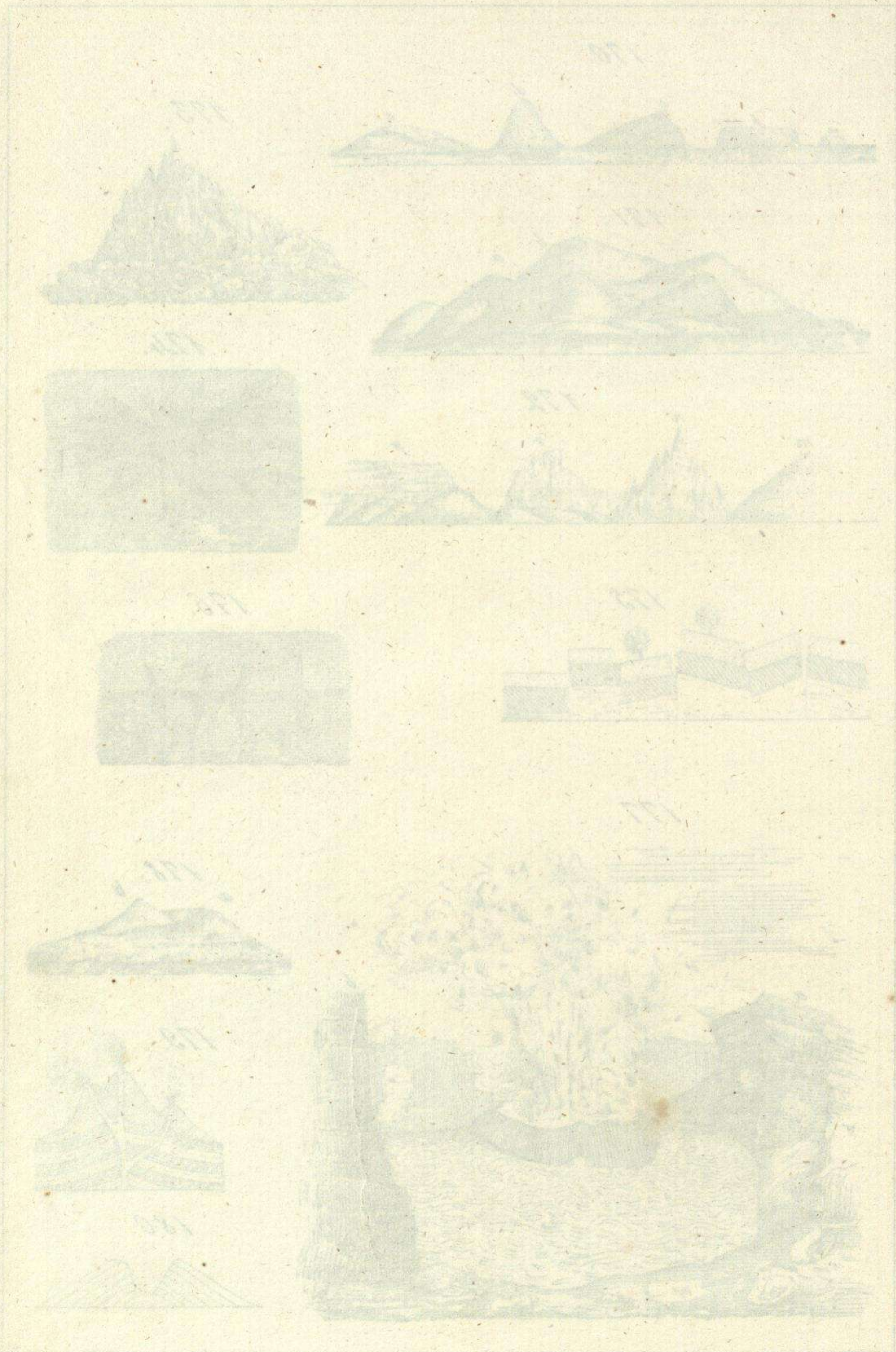
179.



180.







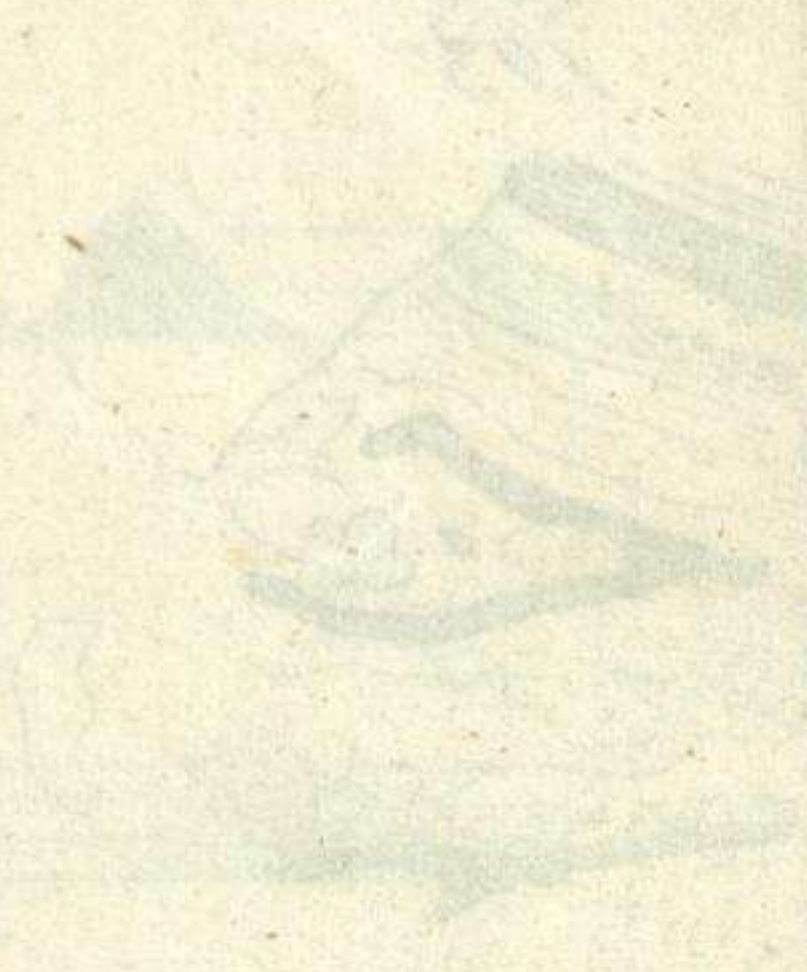
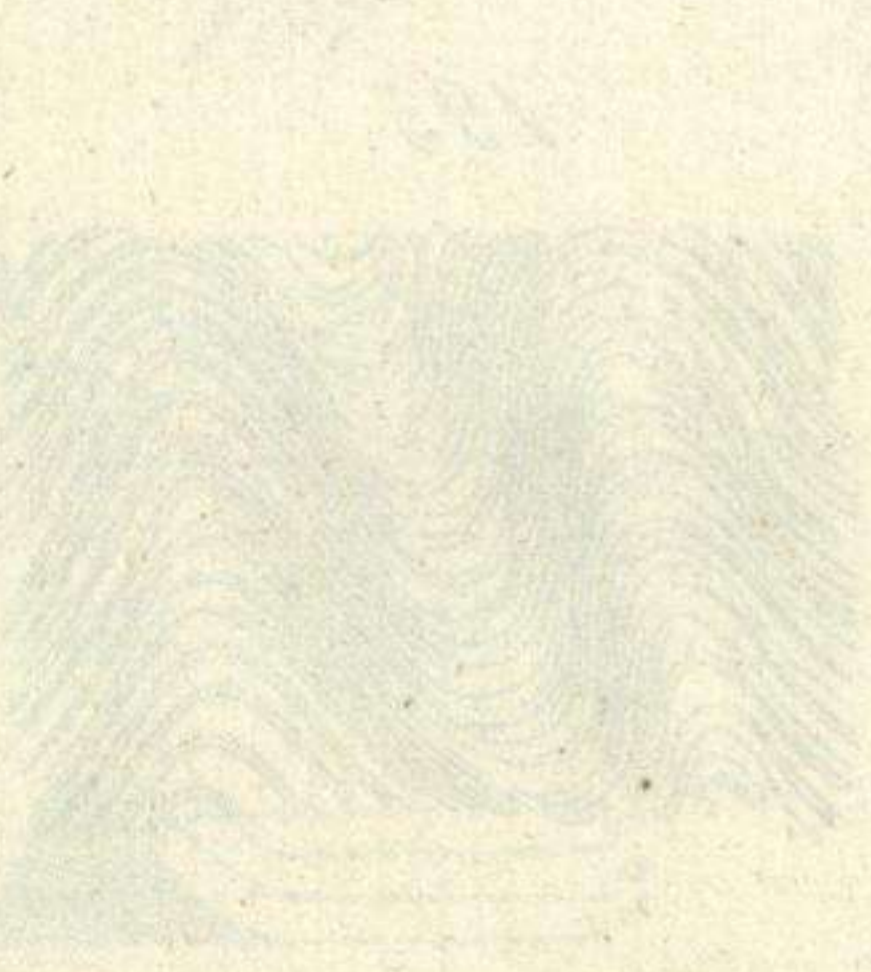
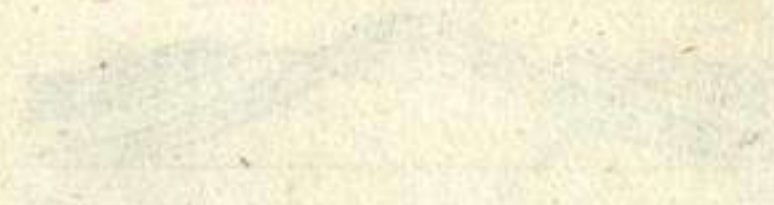
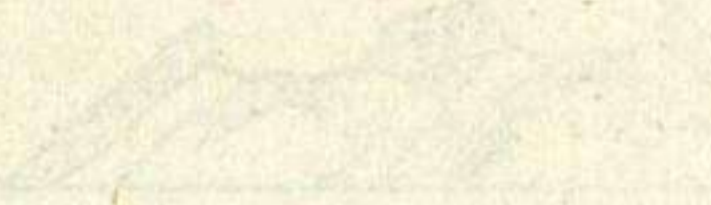


Exercises in Calligraphy

No. 1

No. 2

No. 3



No. 4

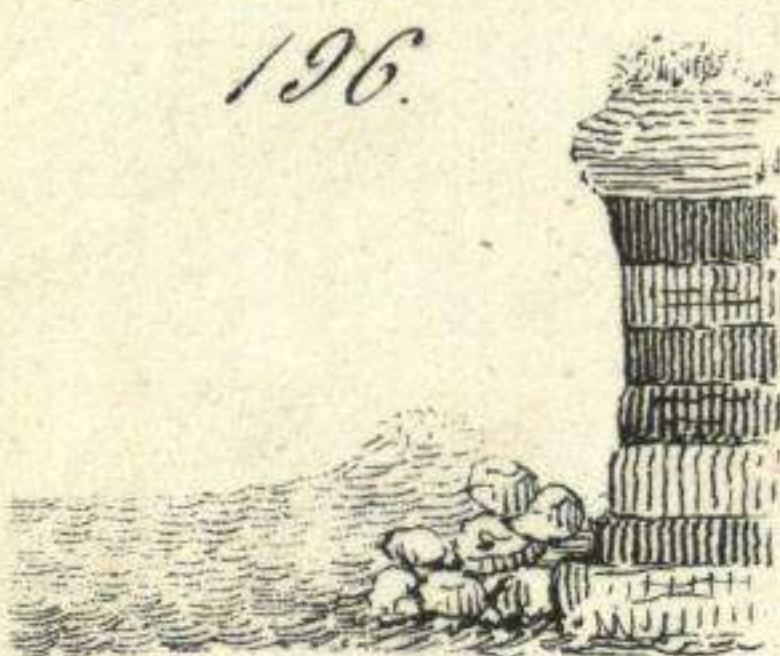
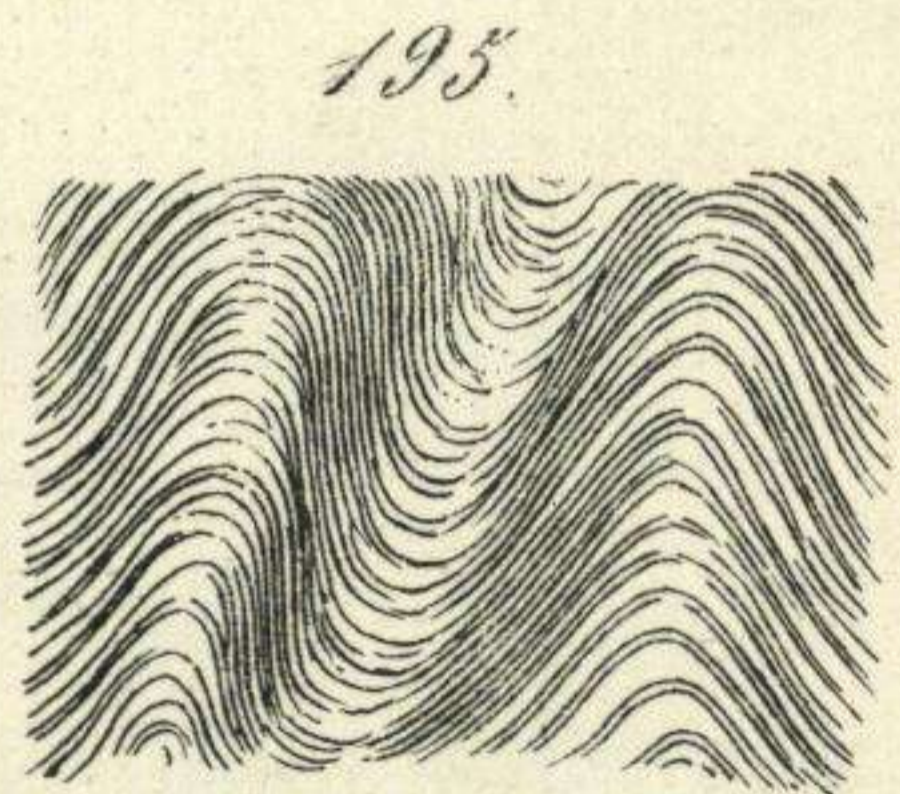
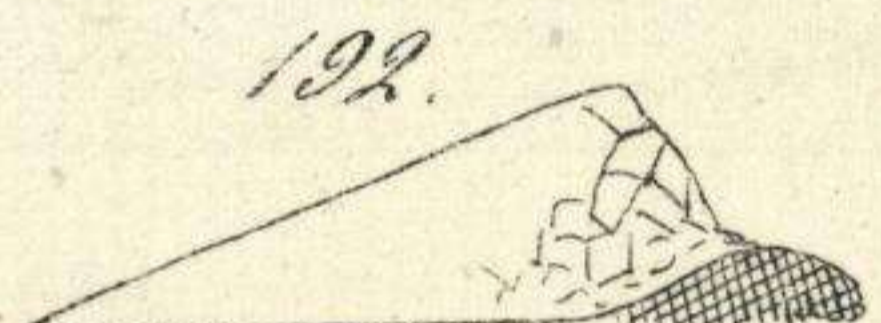
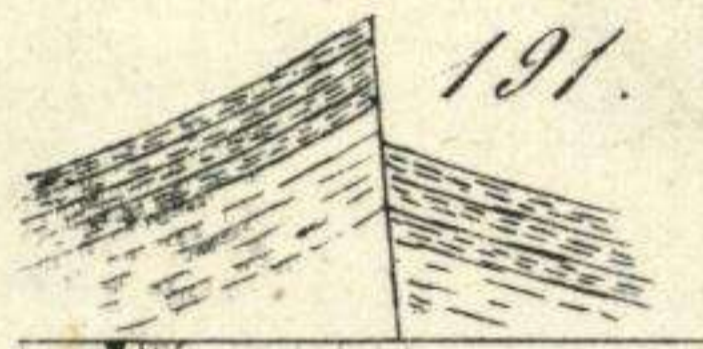
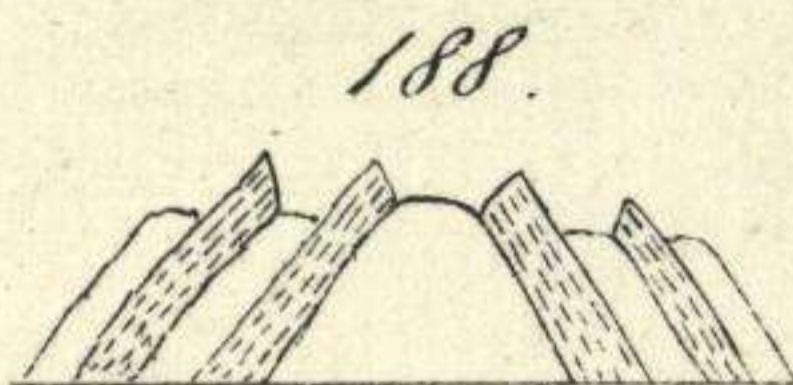
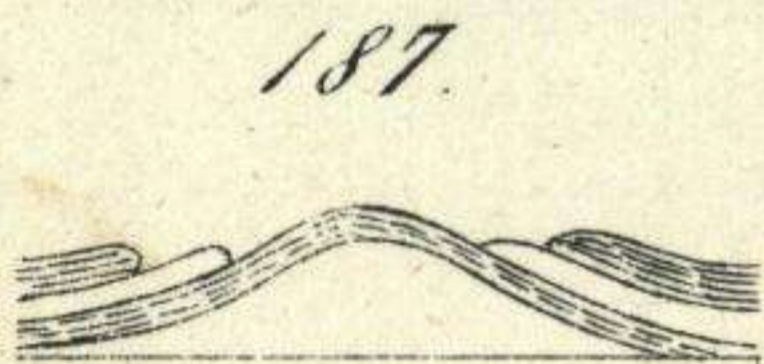
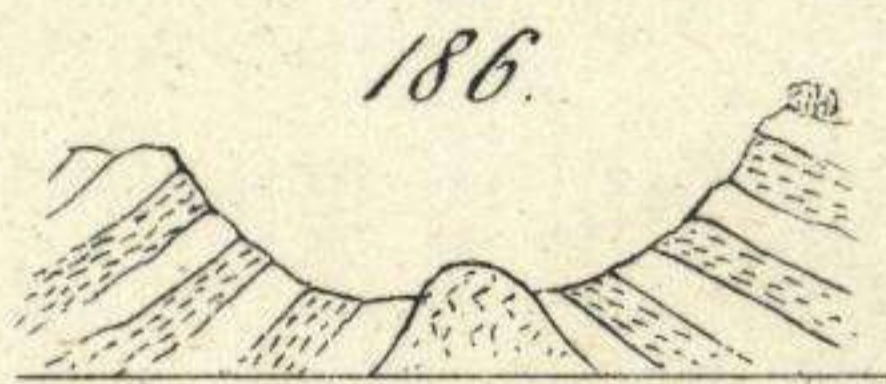
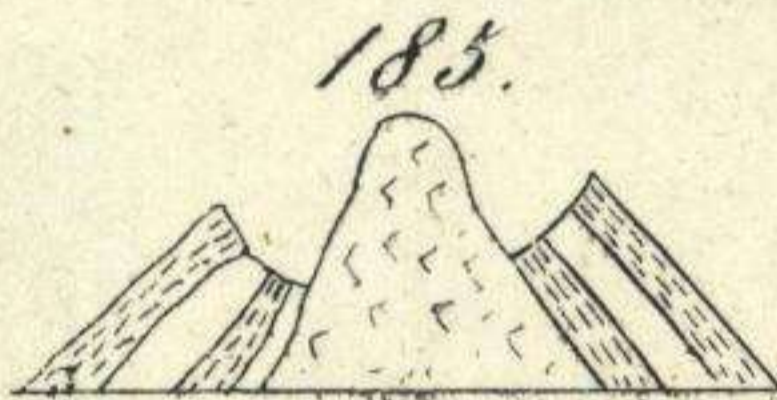
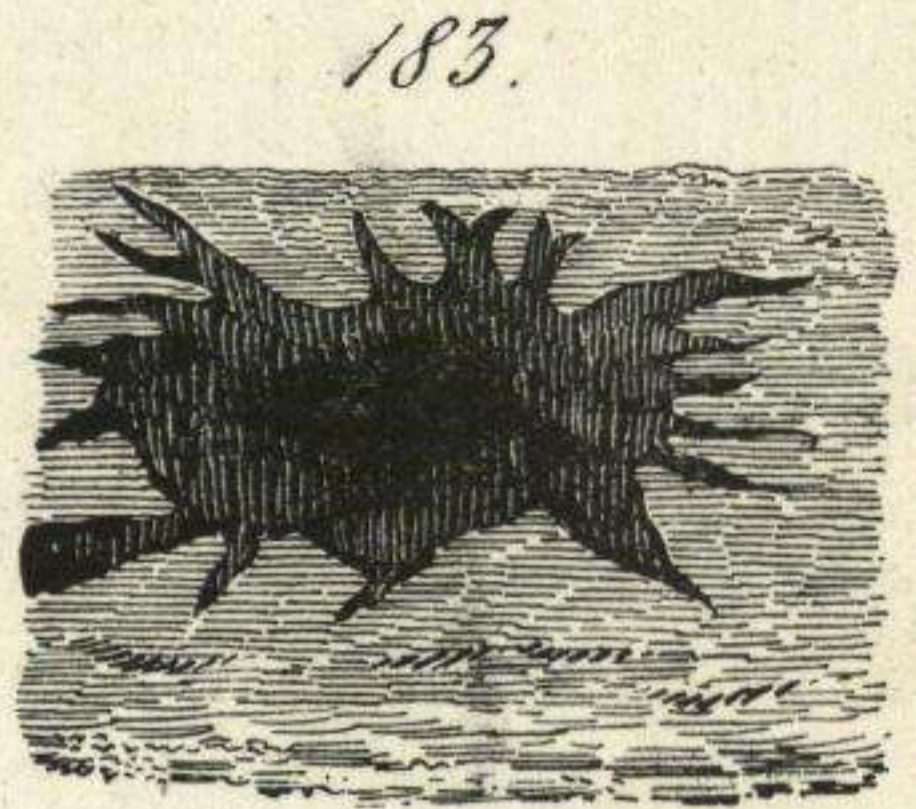
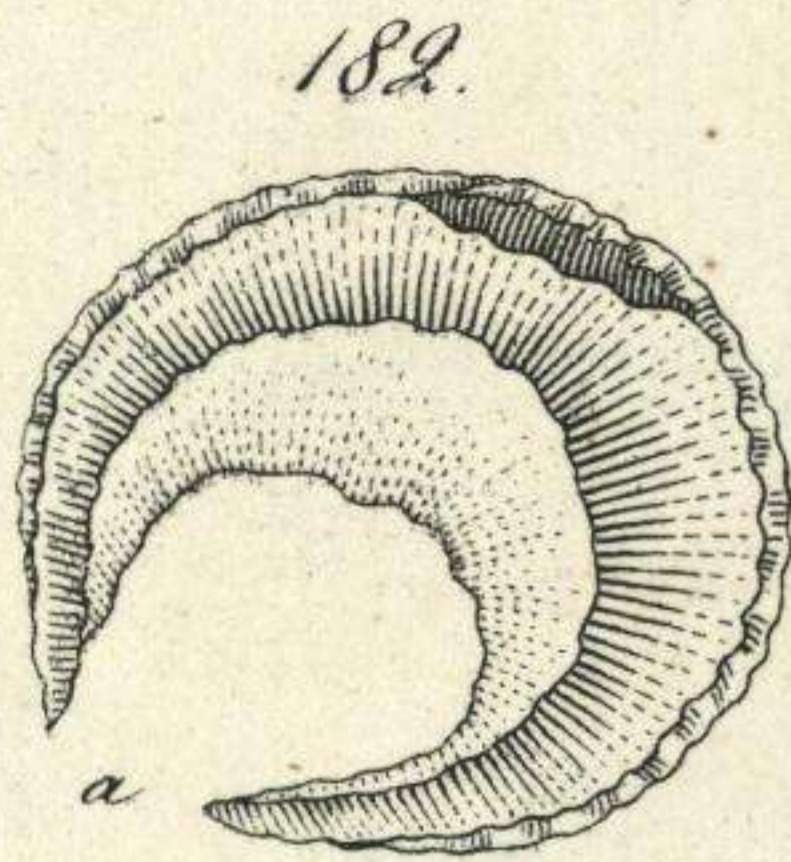
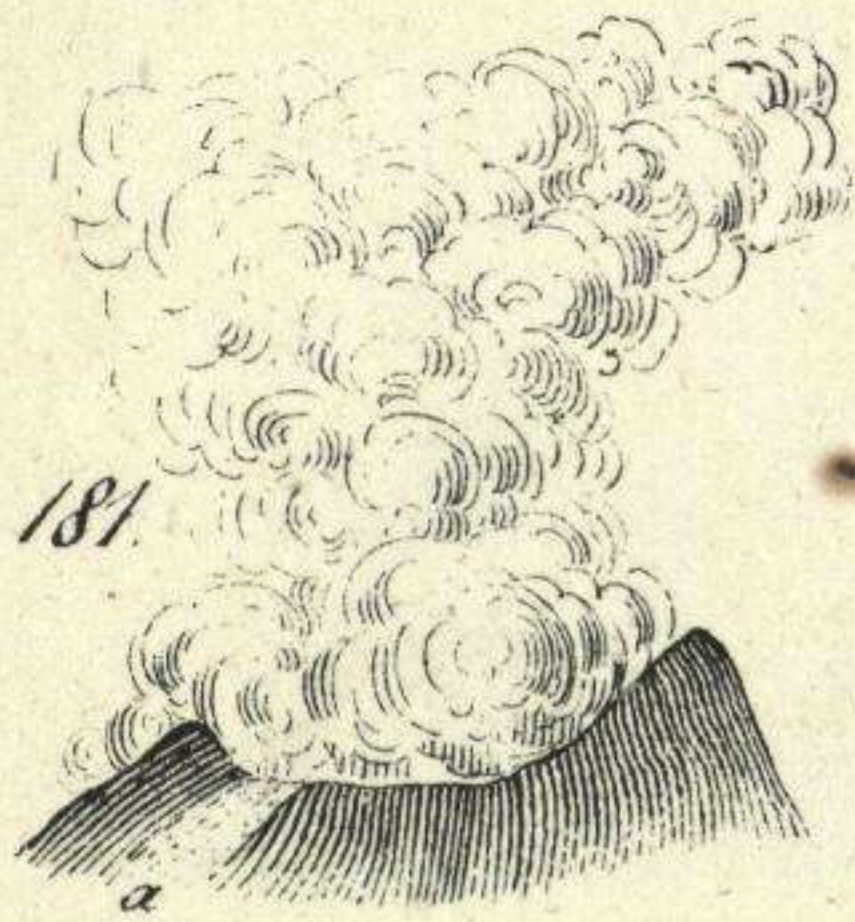
No. 5

No. 6



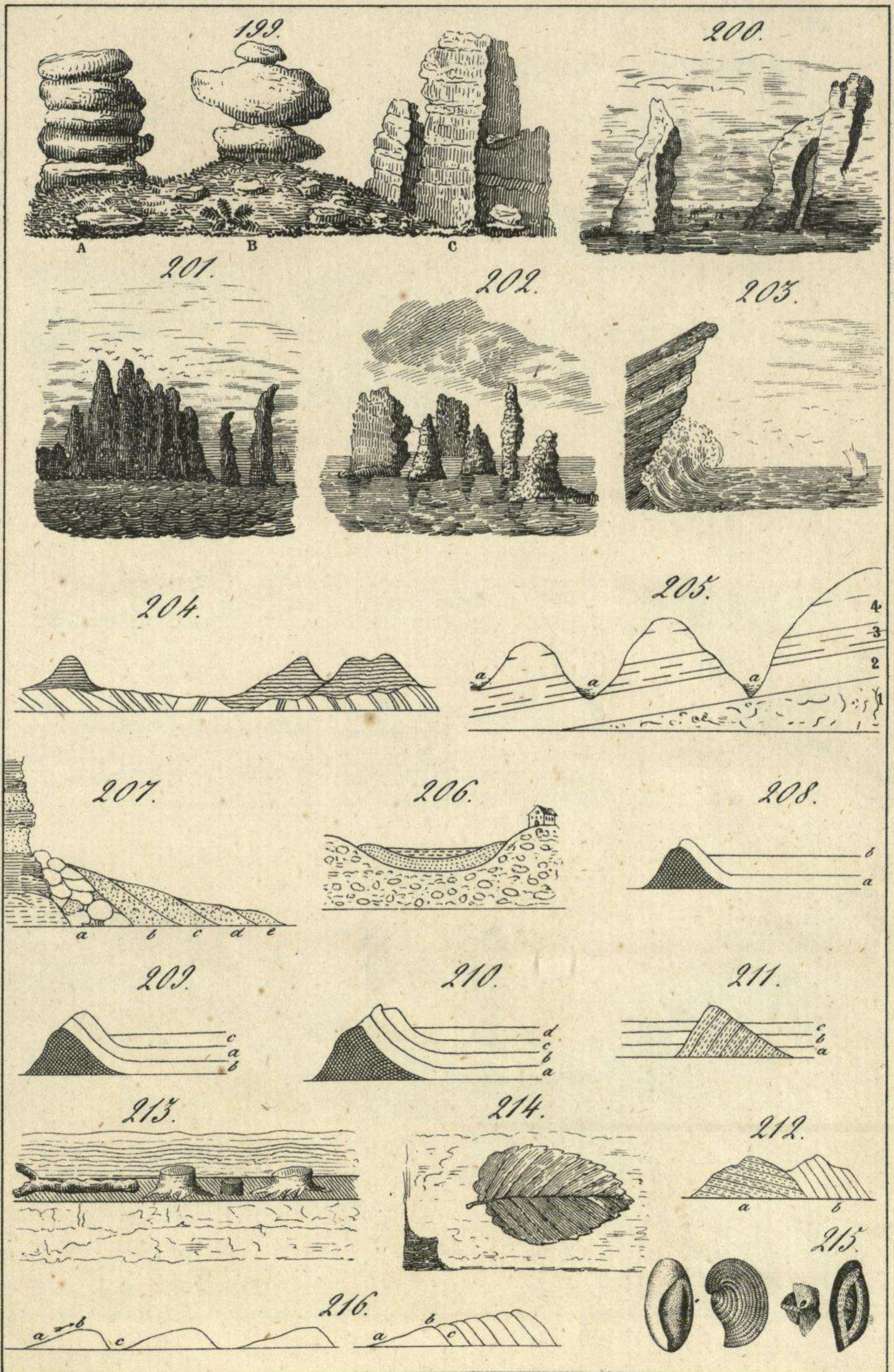


Diccionario de Agricultura.





# Diccionario de Agricultura.





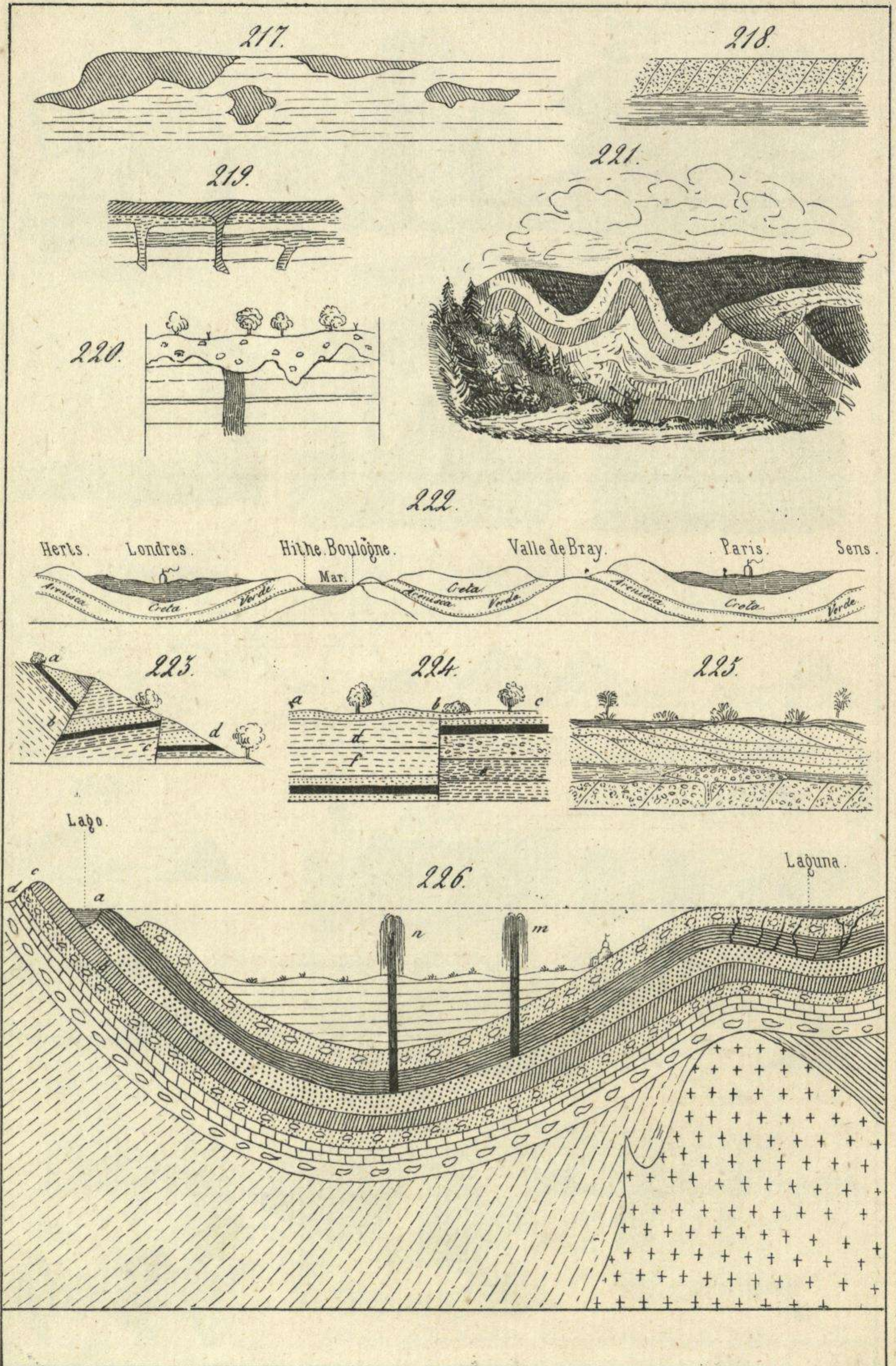








# Diccionario de Agricultura.



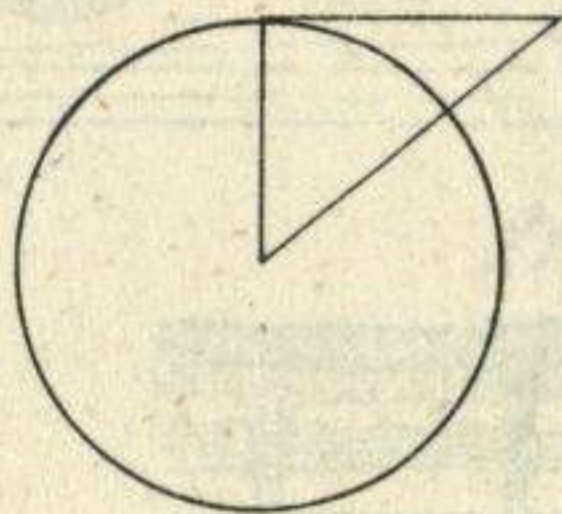




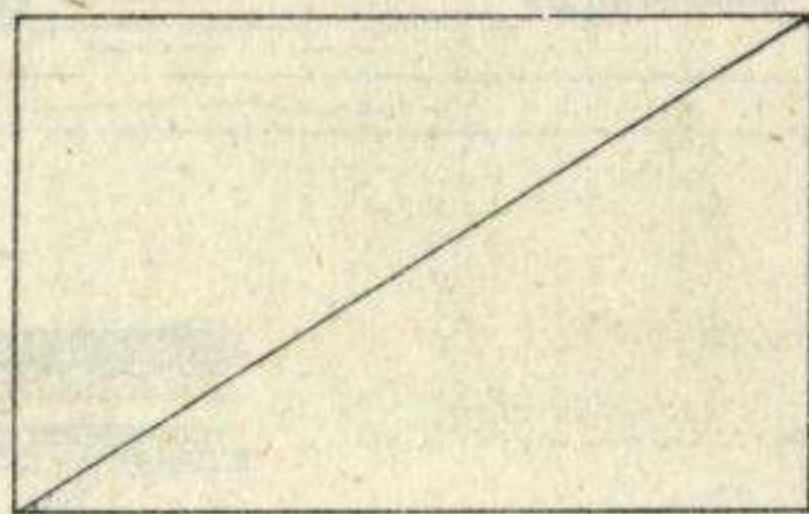


Diccionario de Agricultura.

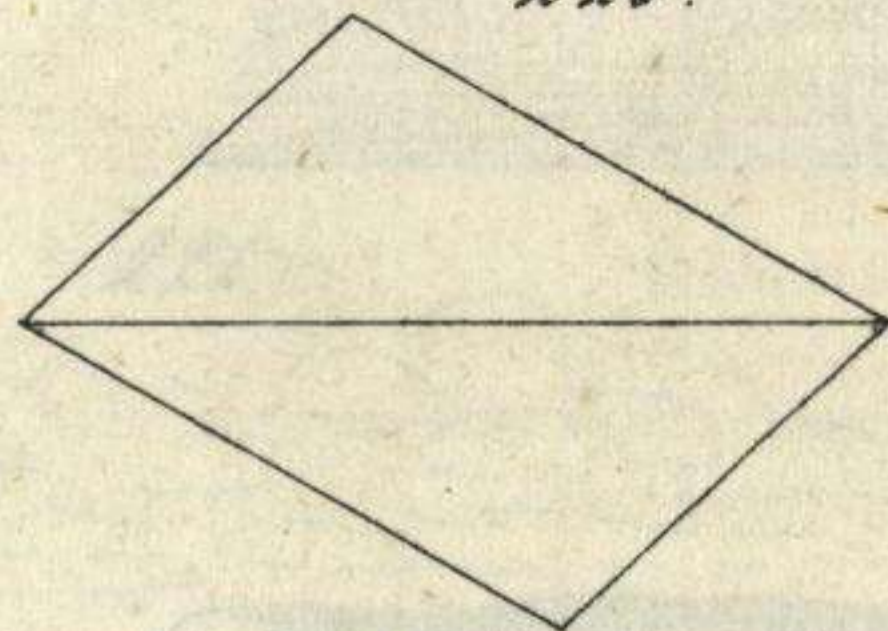
227.



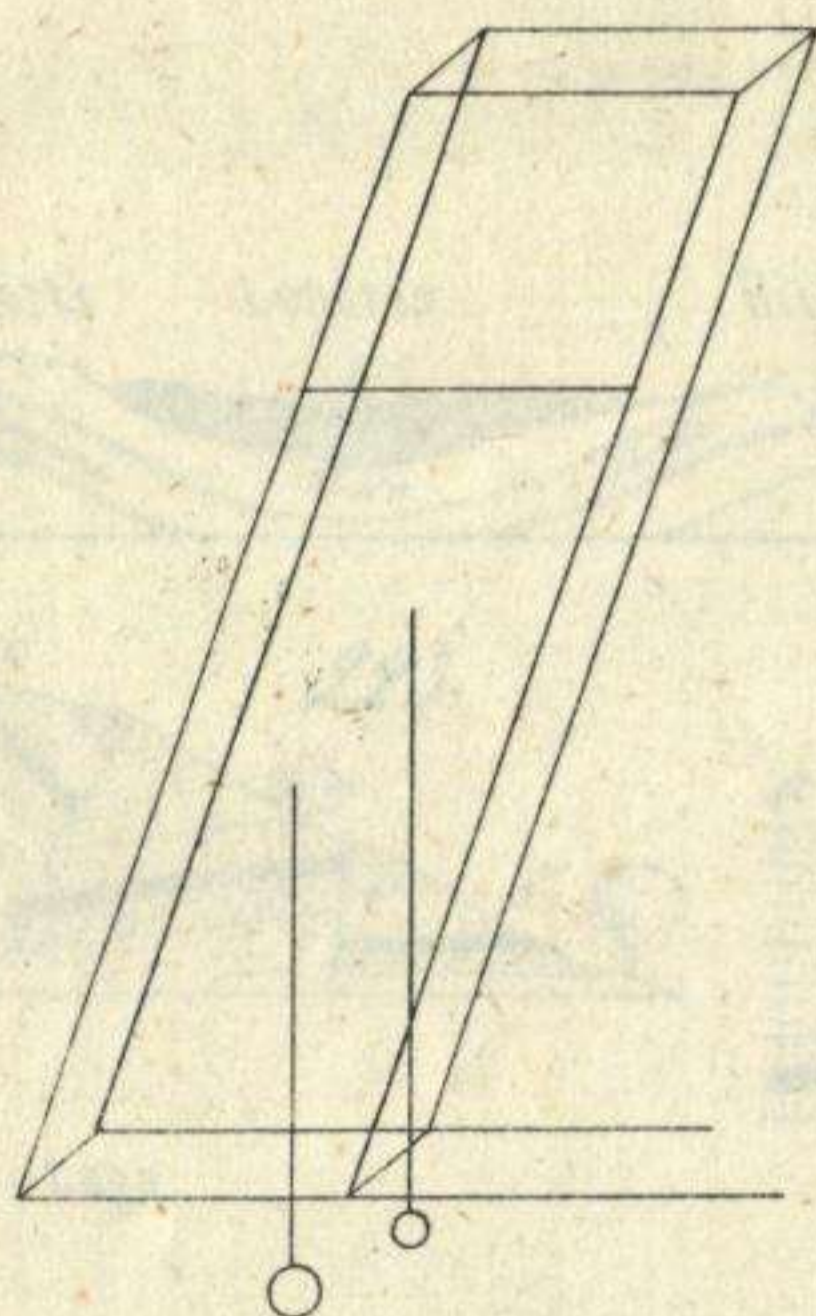
228.



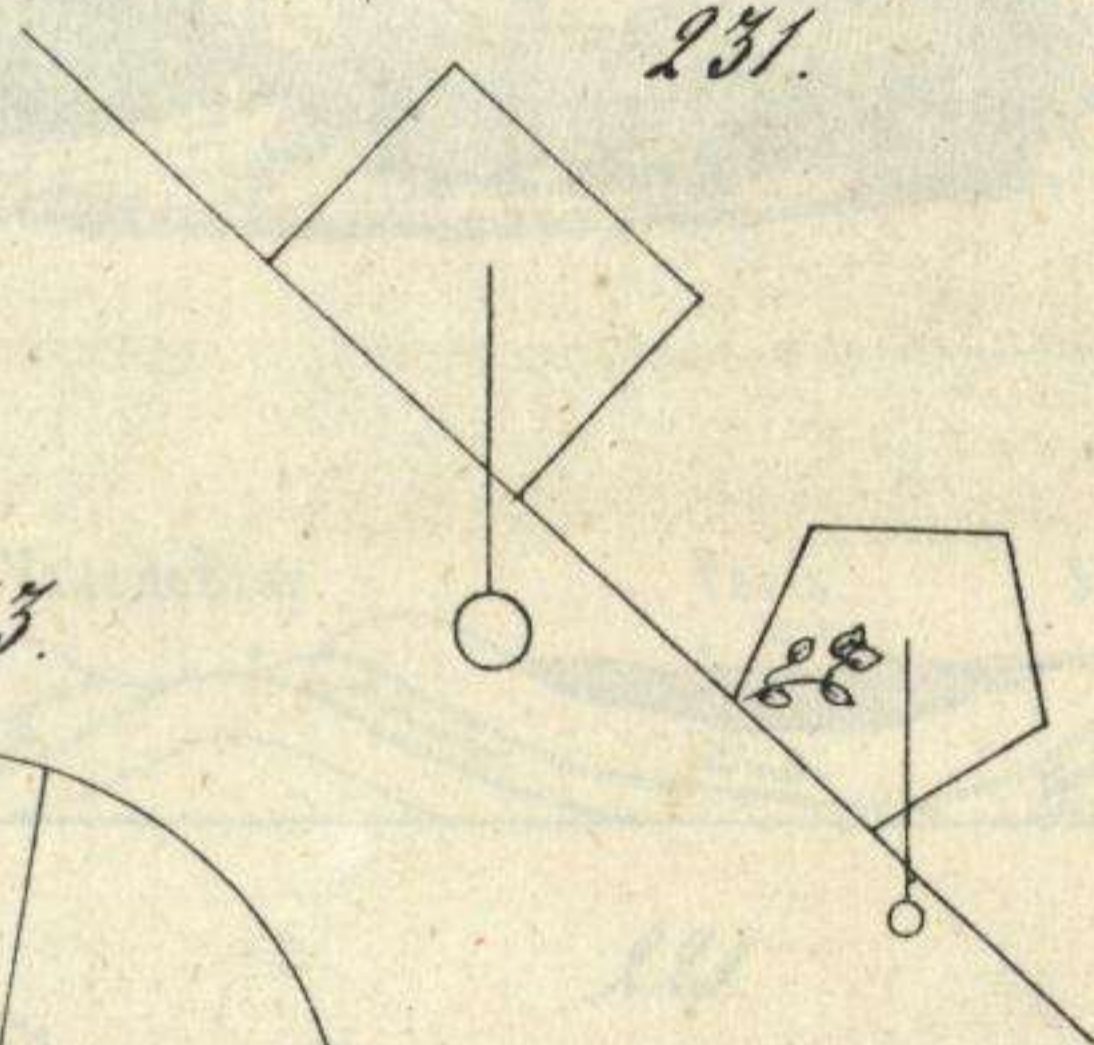
229.



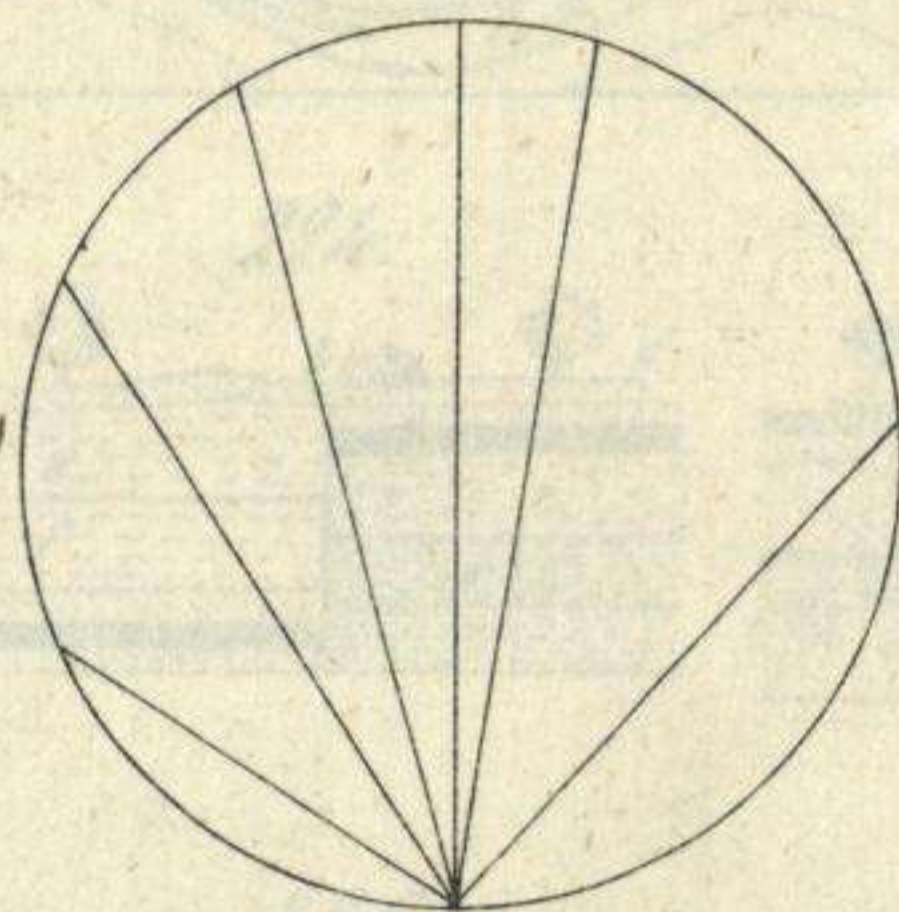
230.



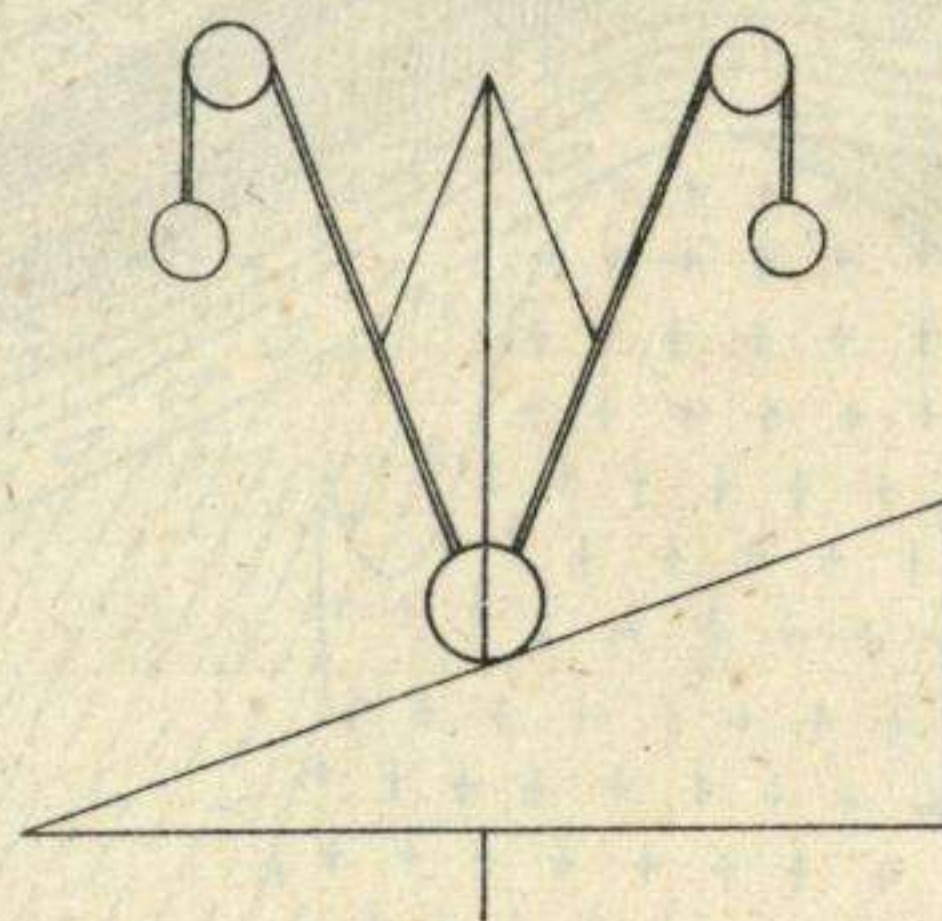
231.



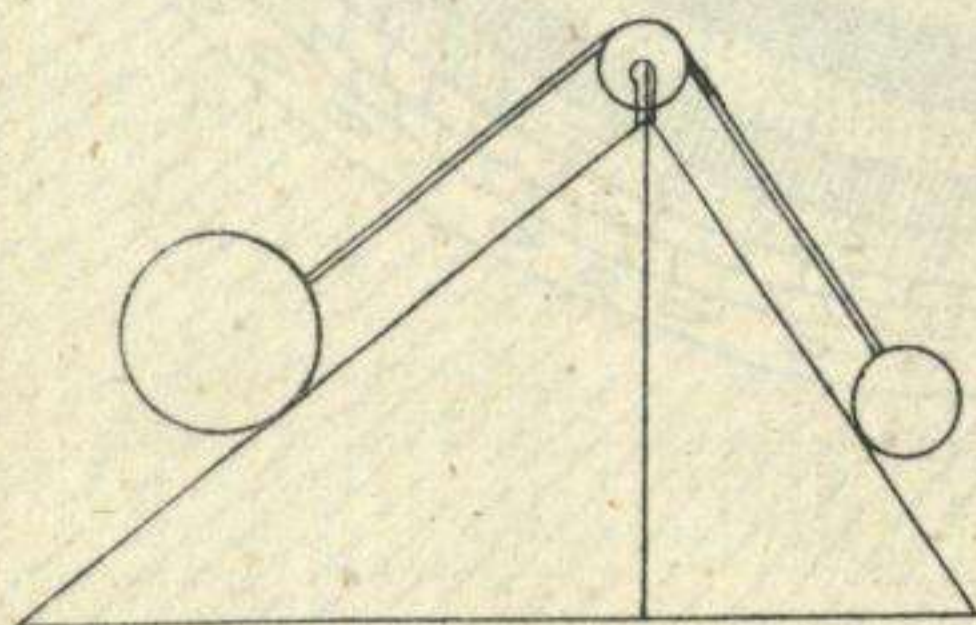
233.



232.



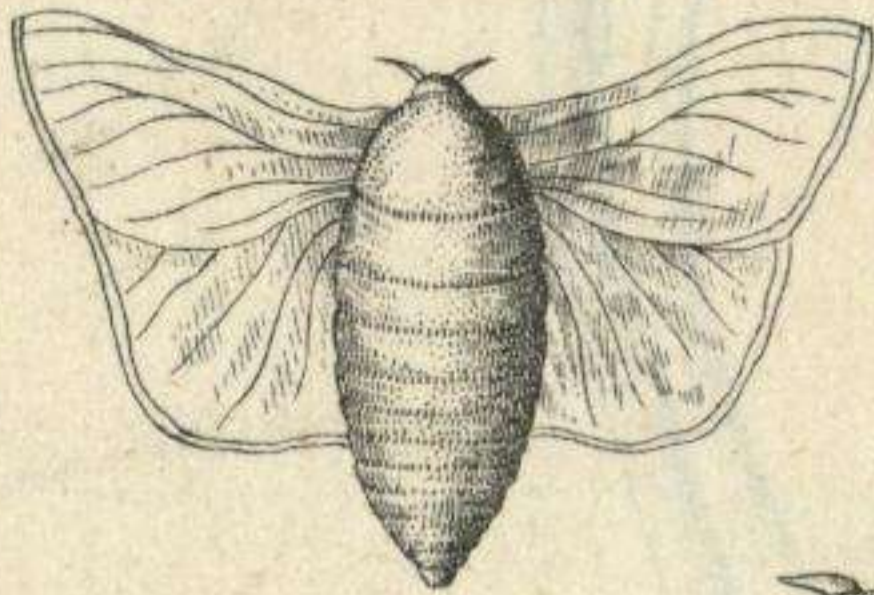
234.



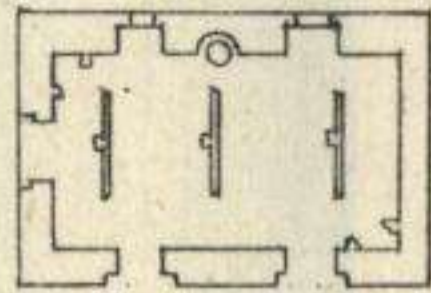


# Diccionario de Agricultura.

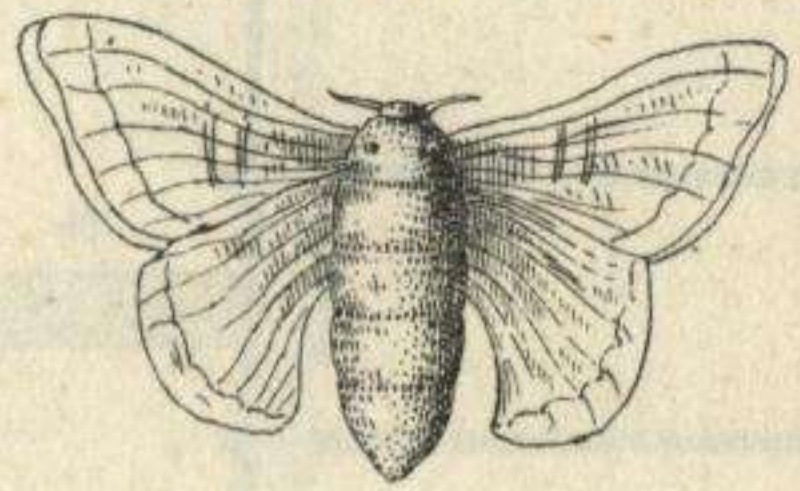
236.



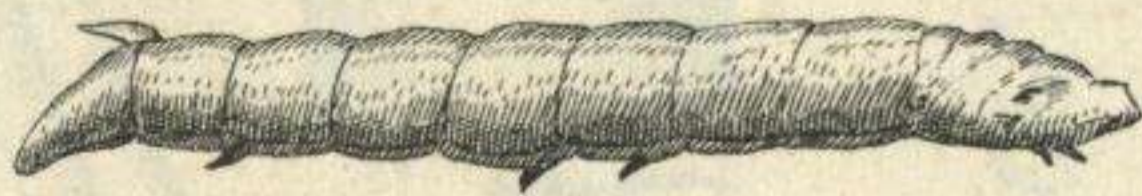
240.



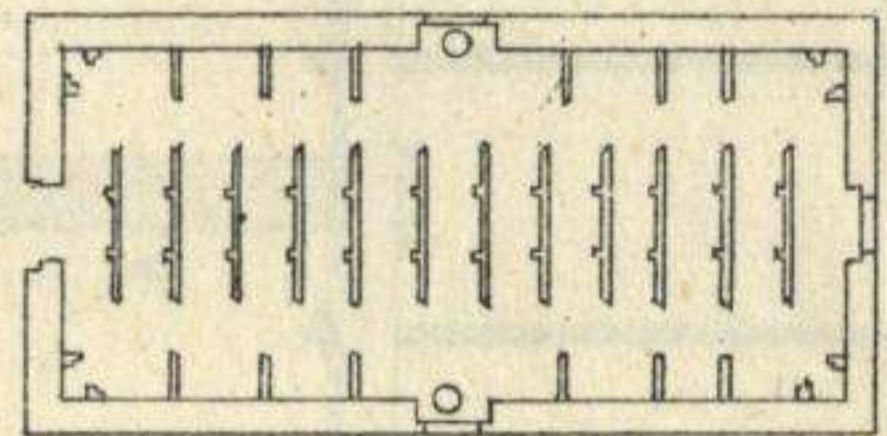
237.



235.



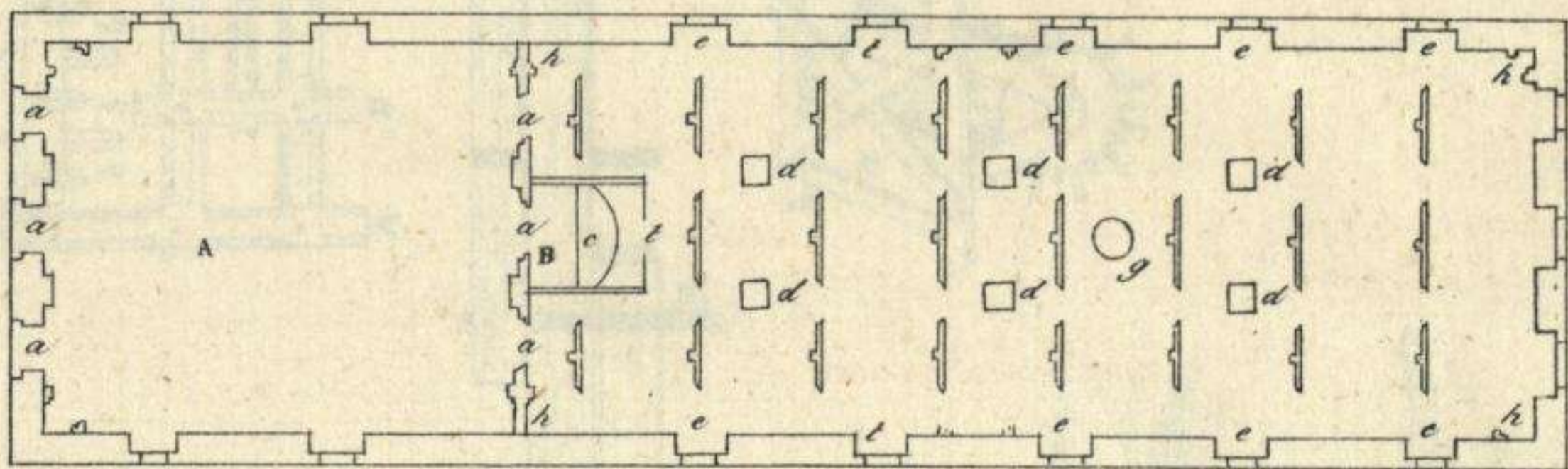
239.



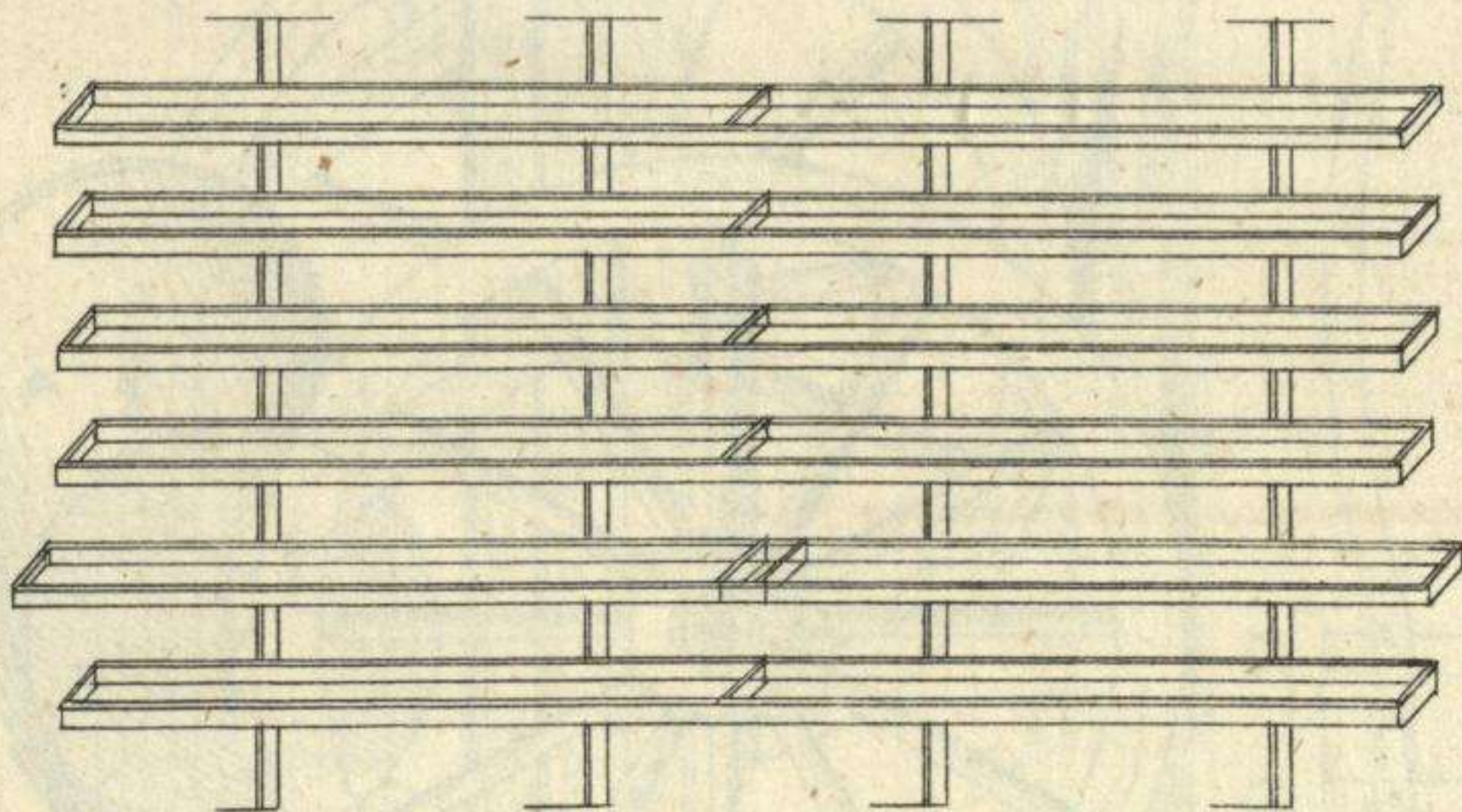
242.



238.



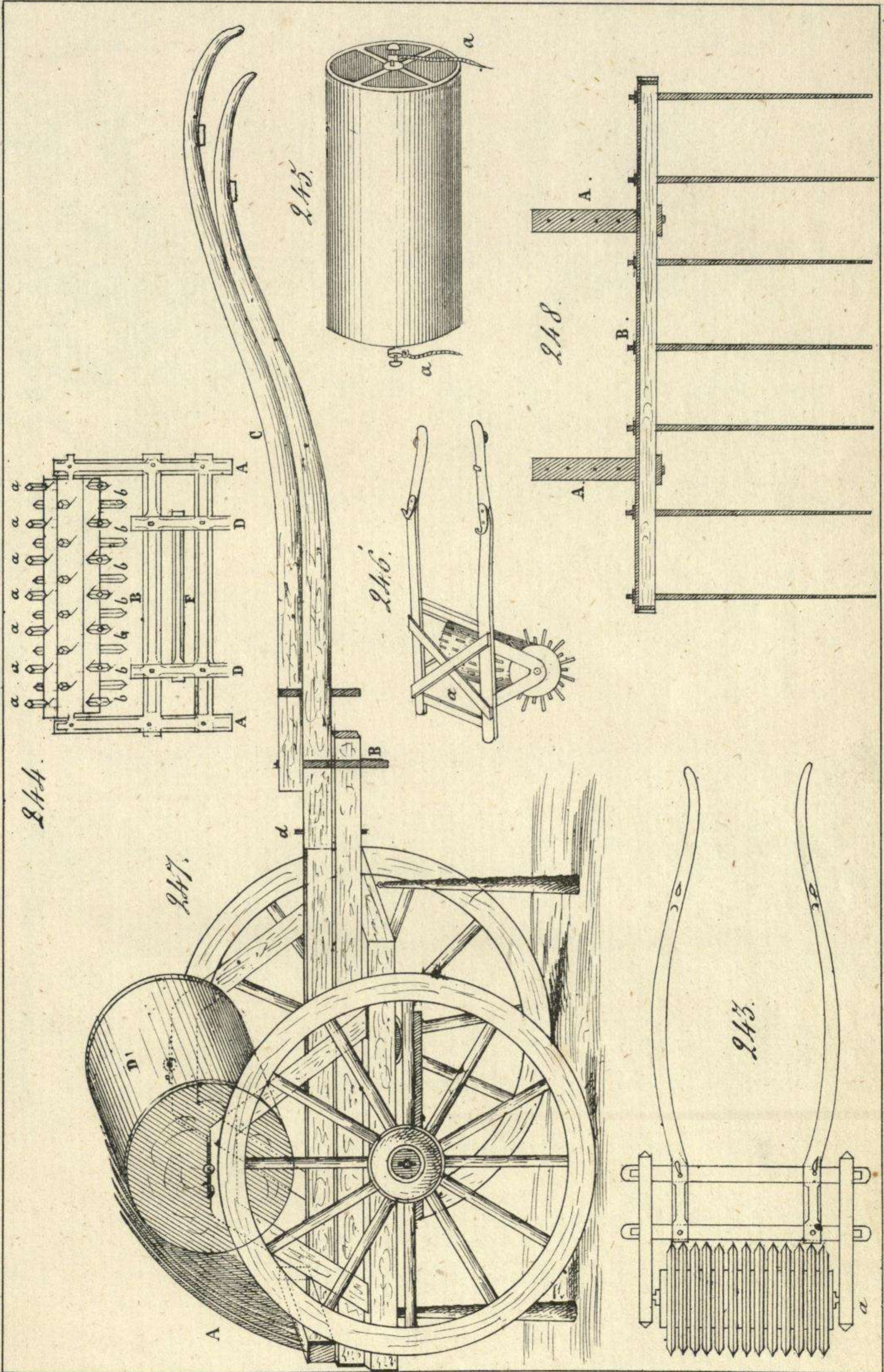
241.











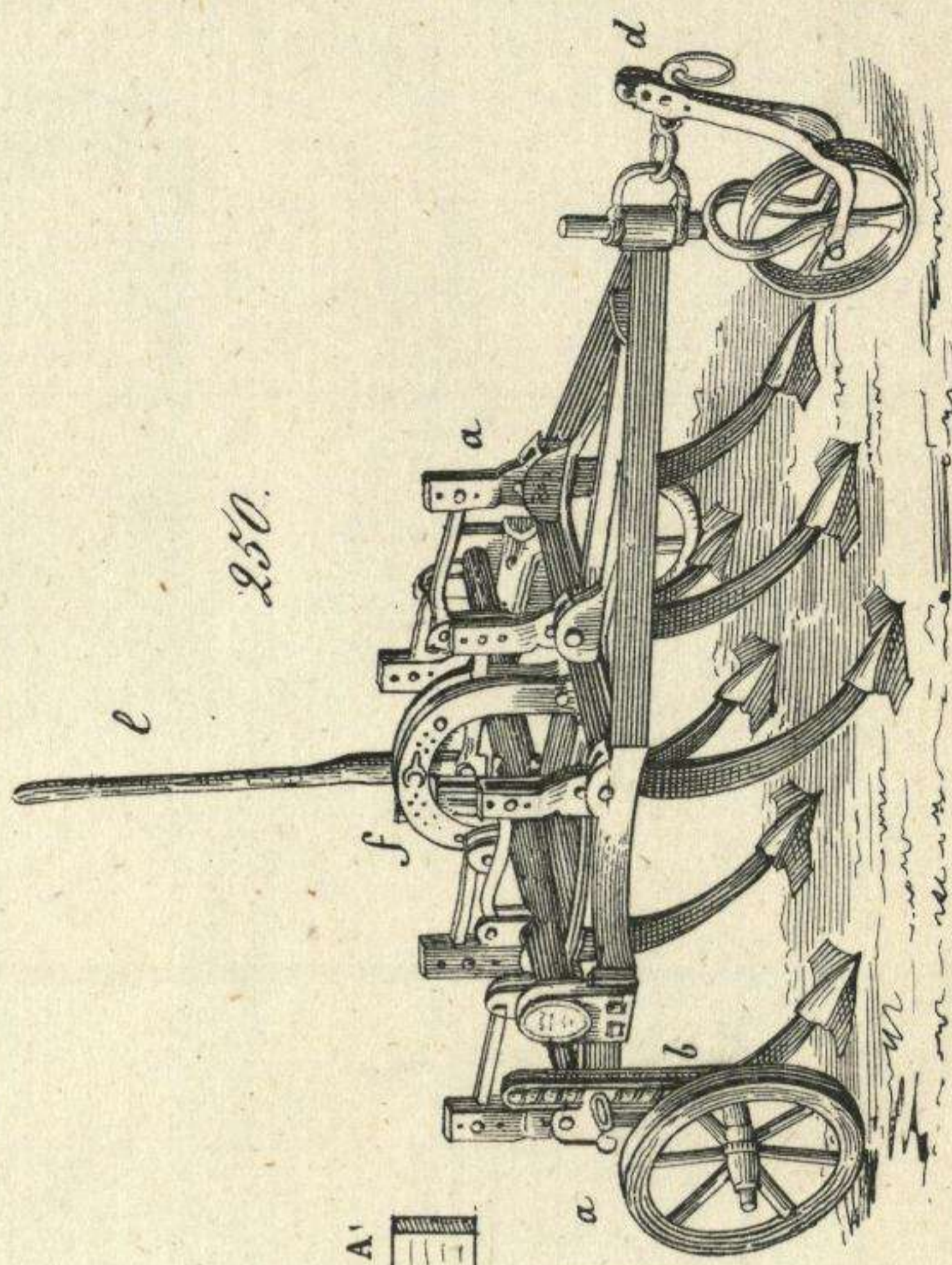
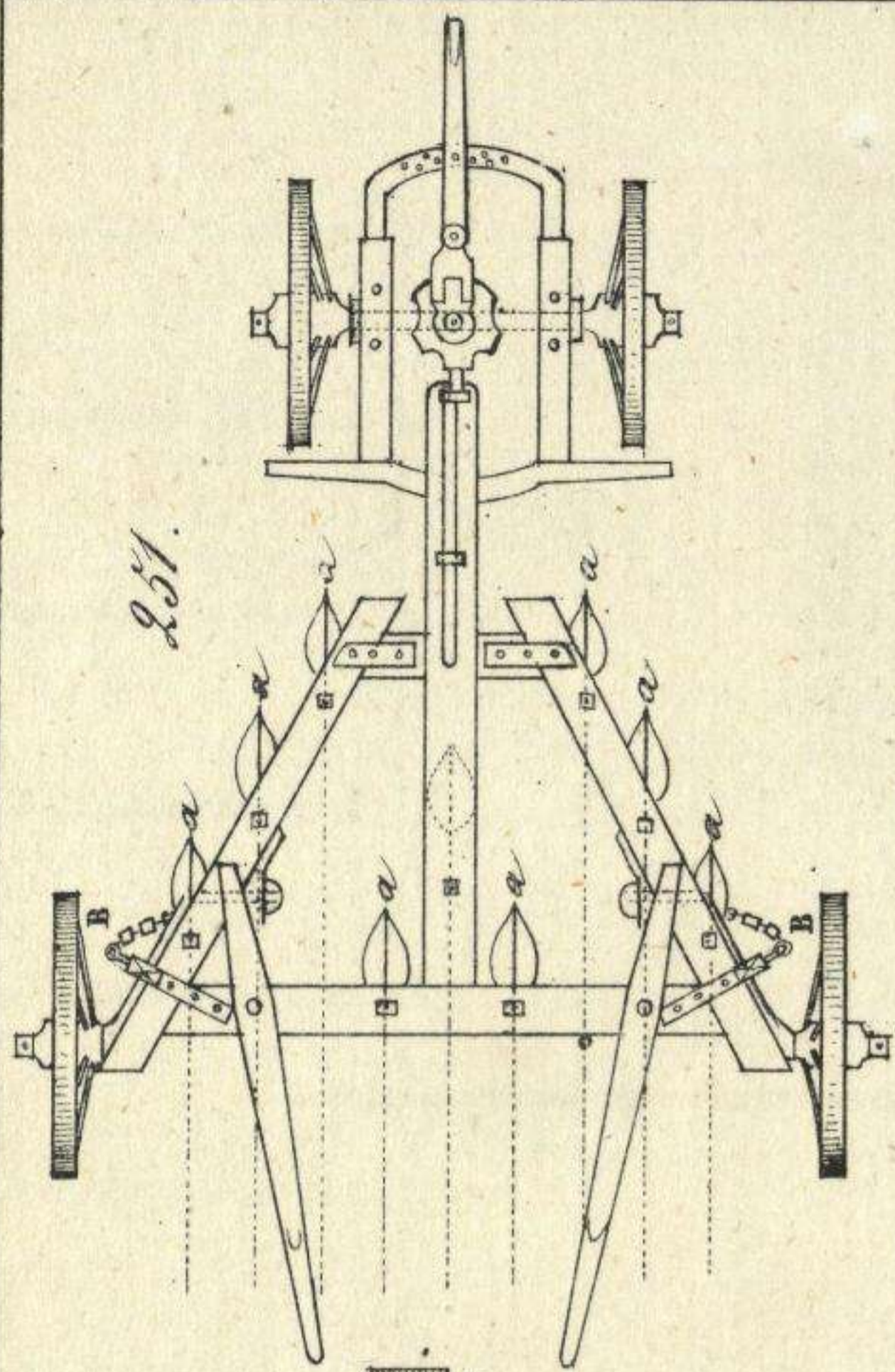
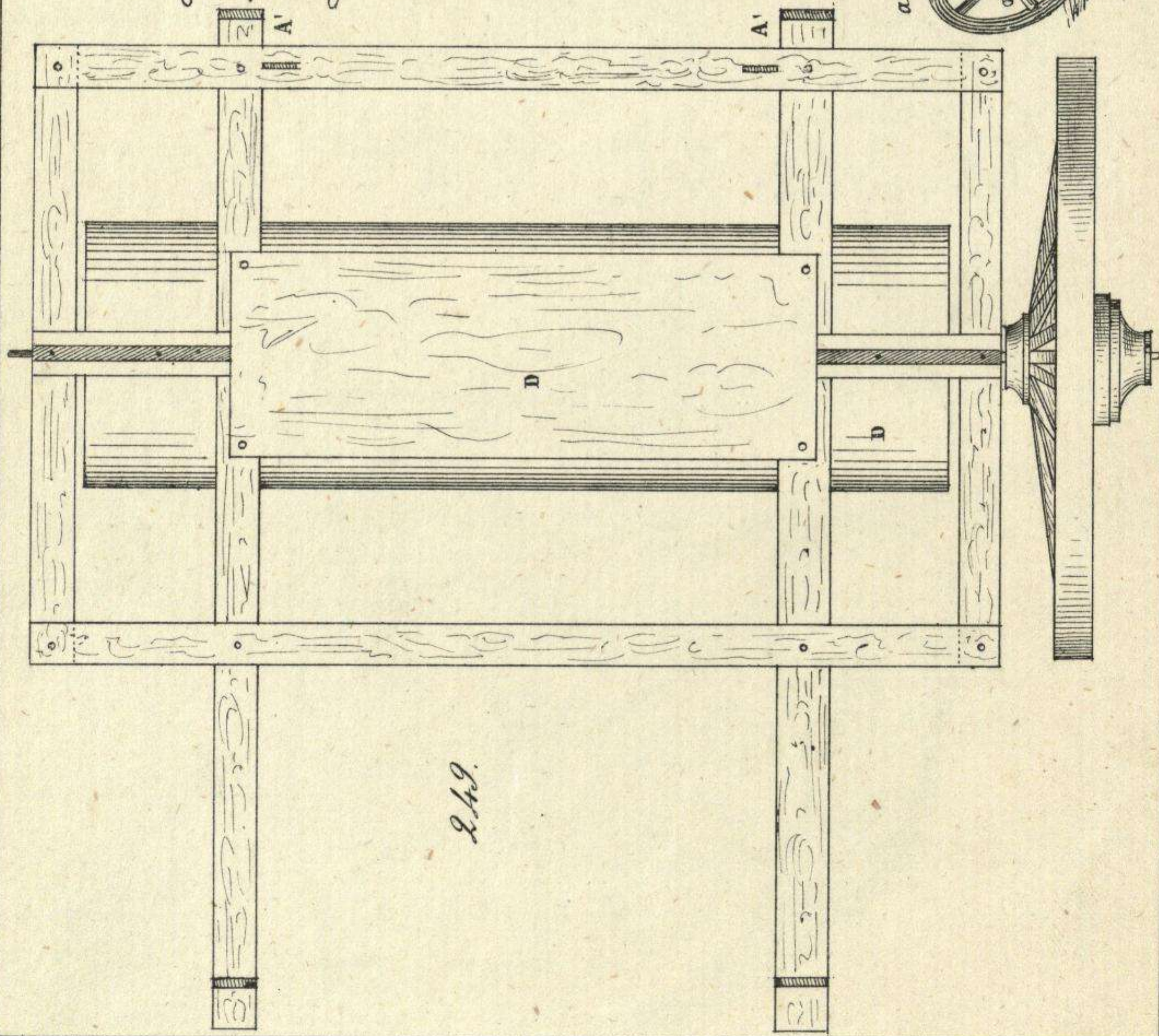






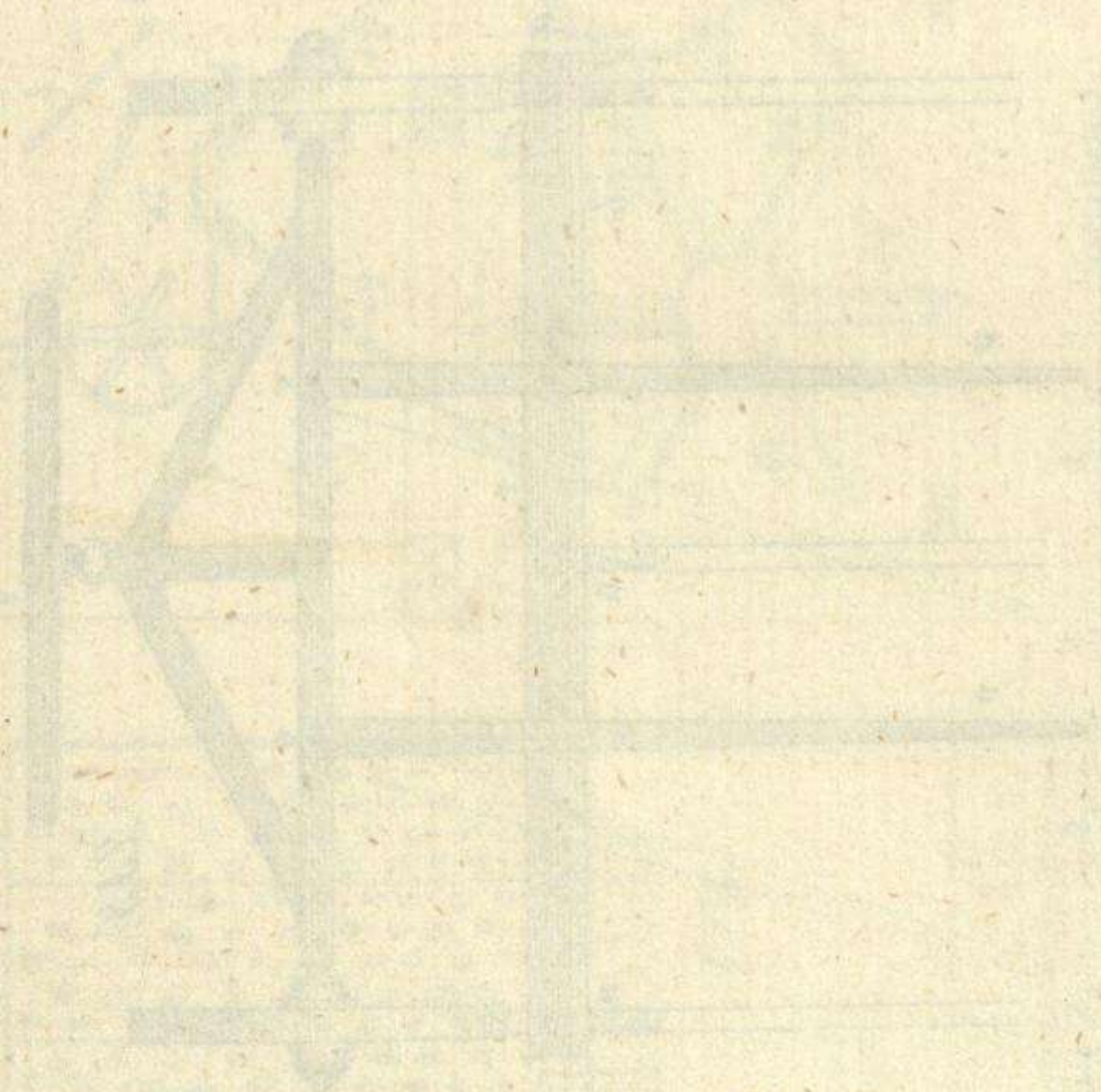




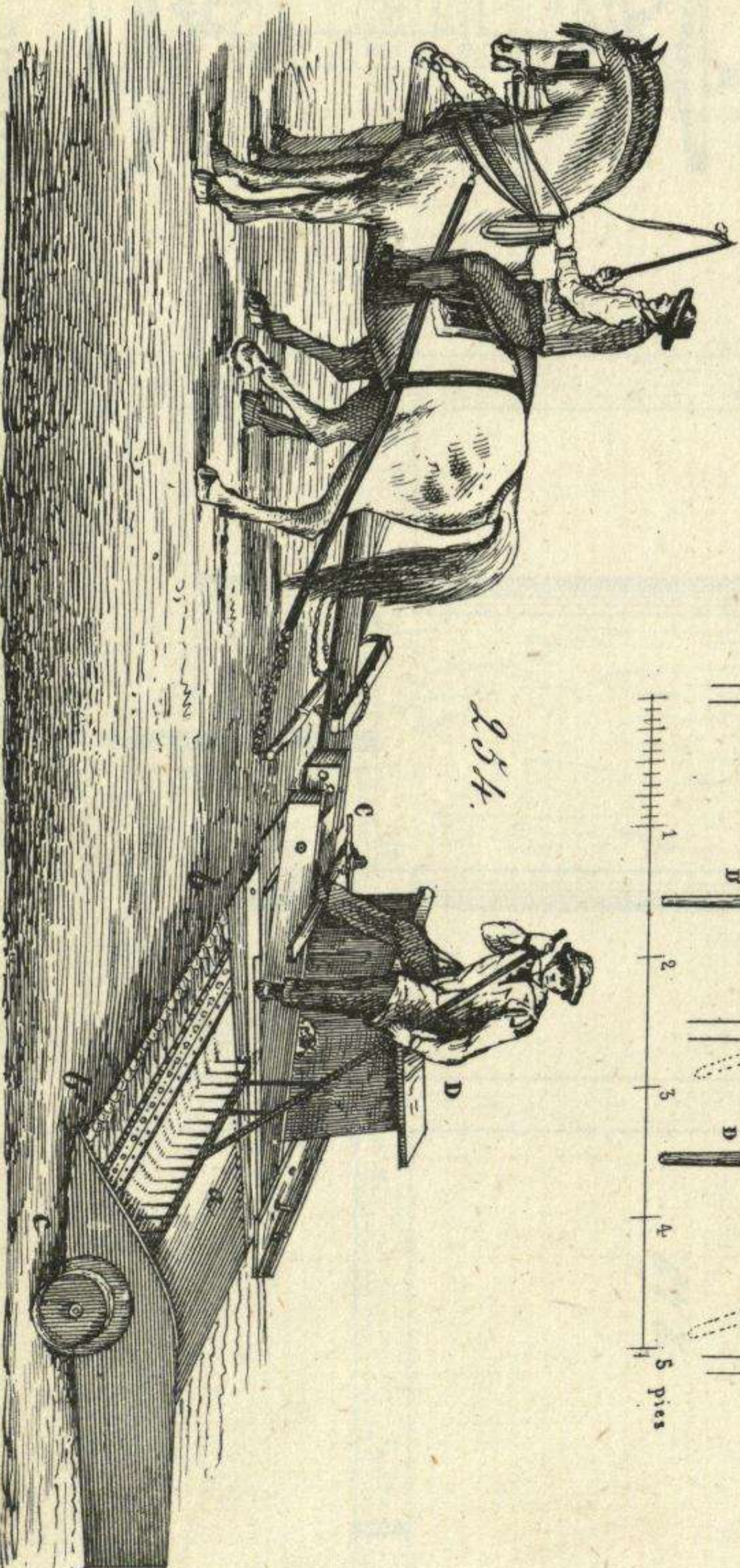
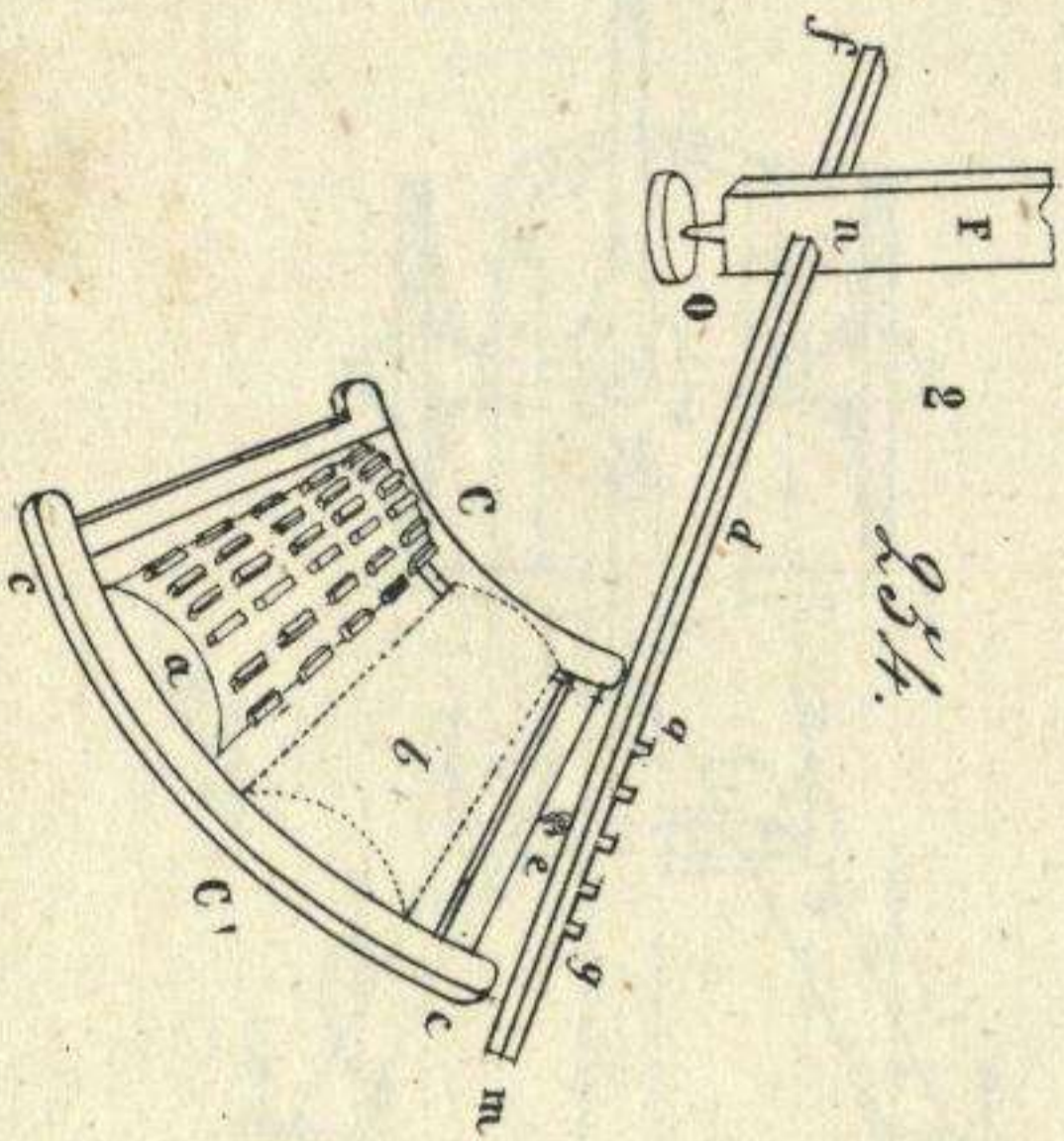
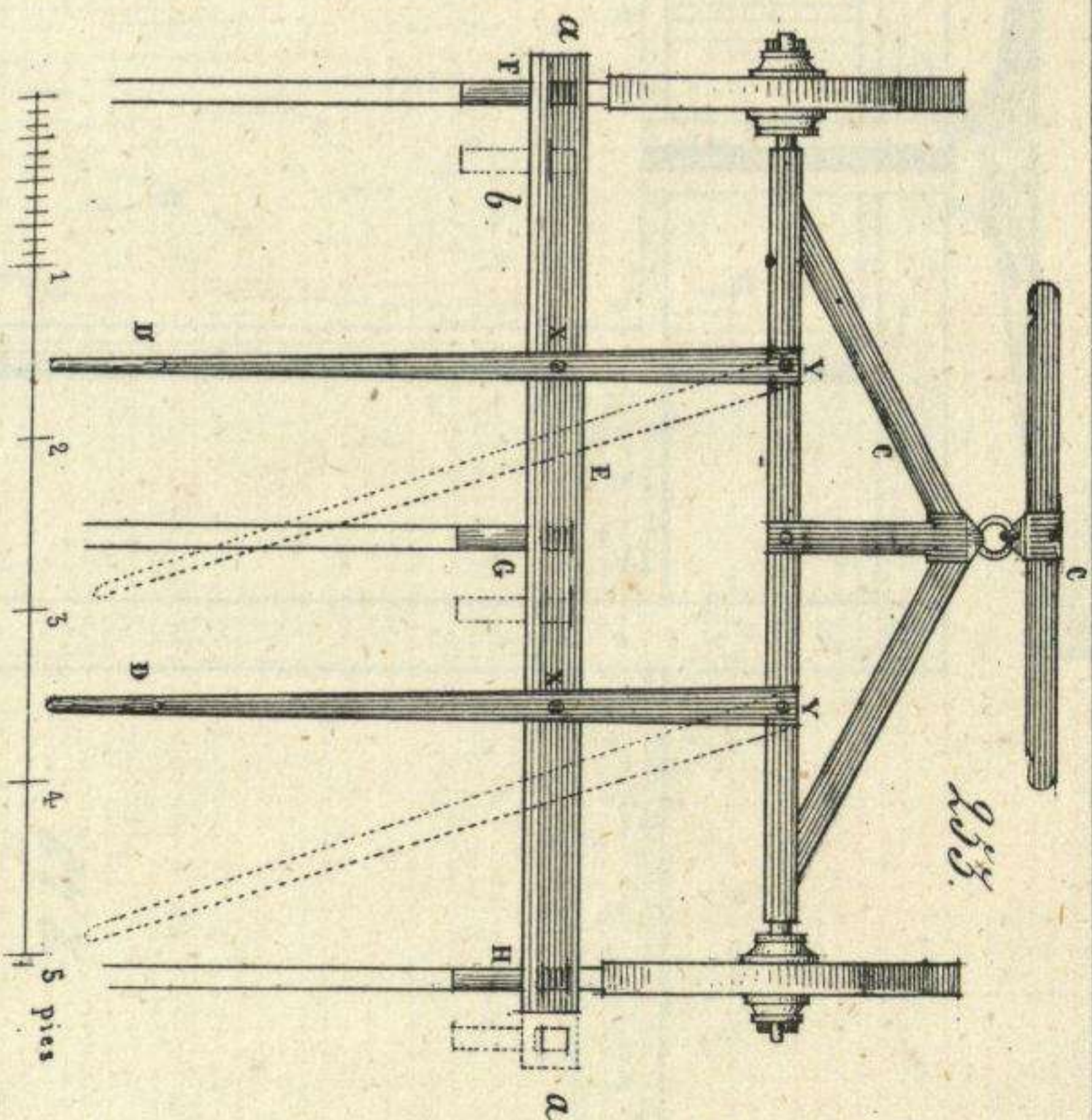
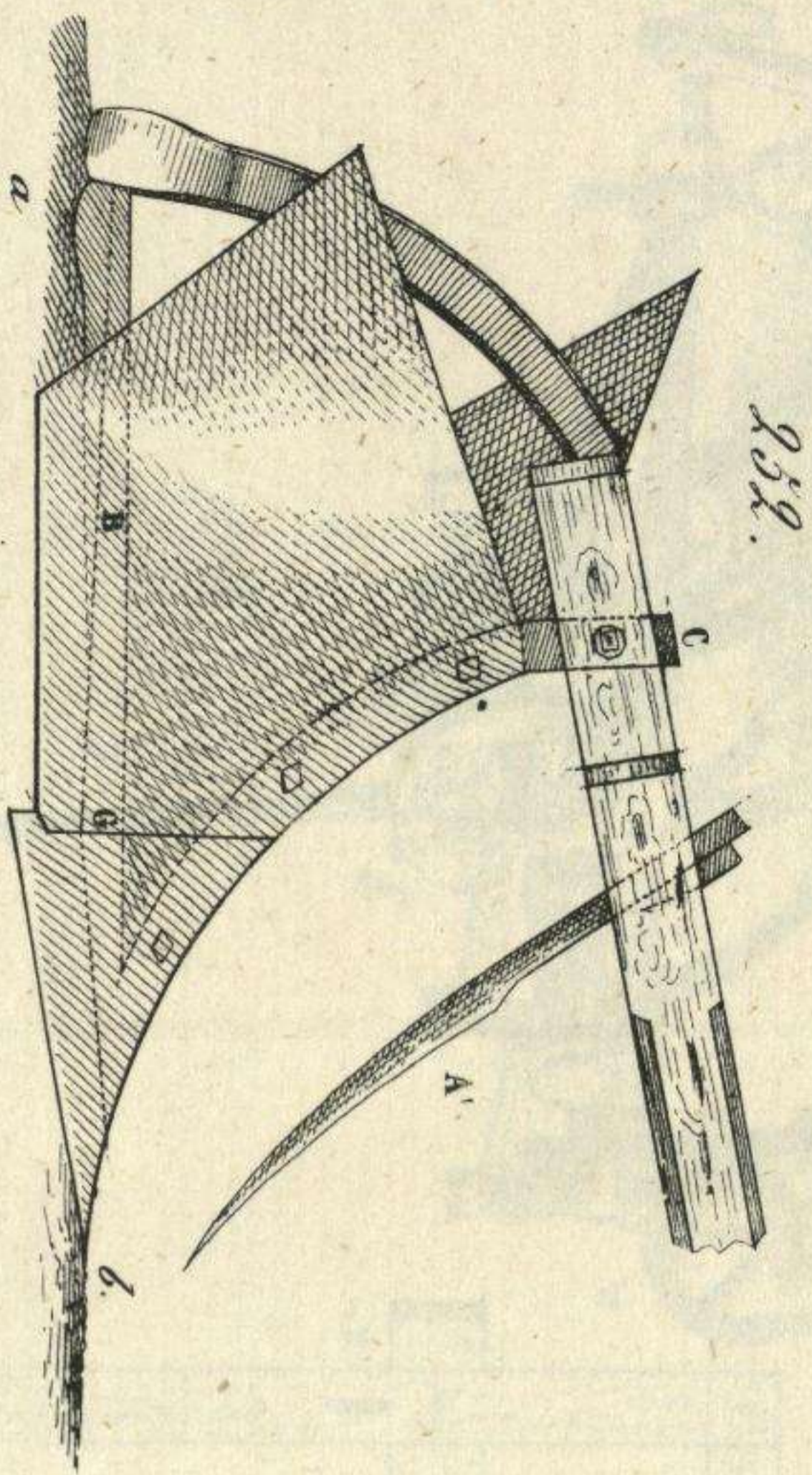




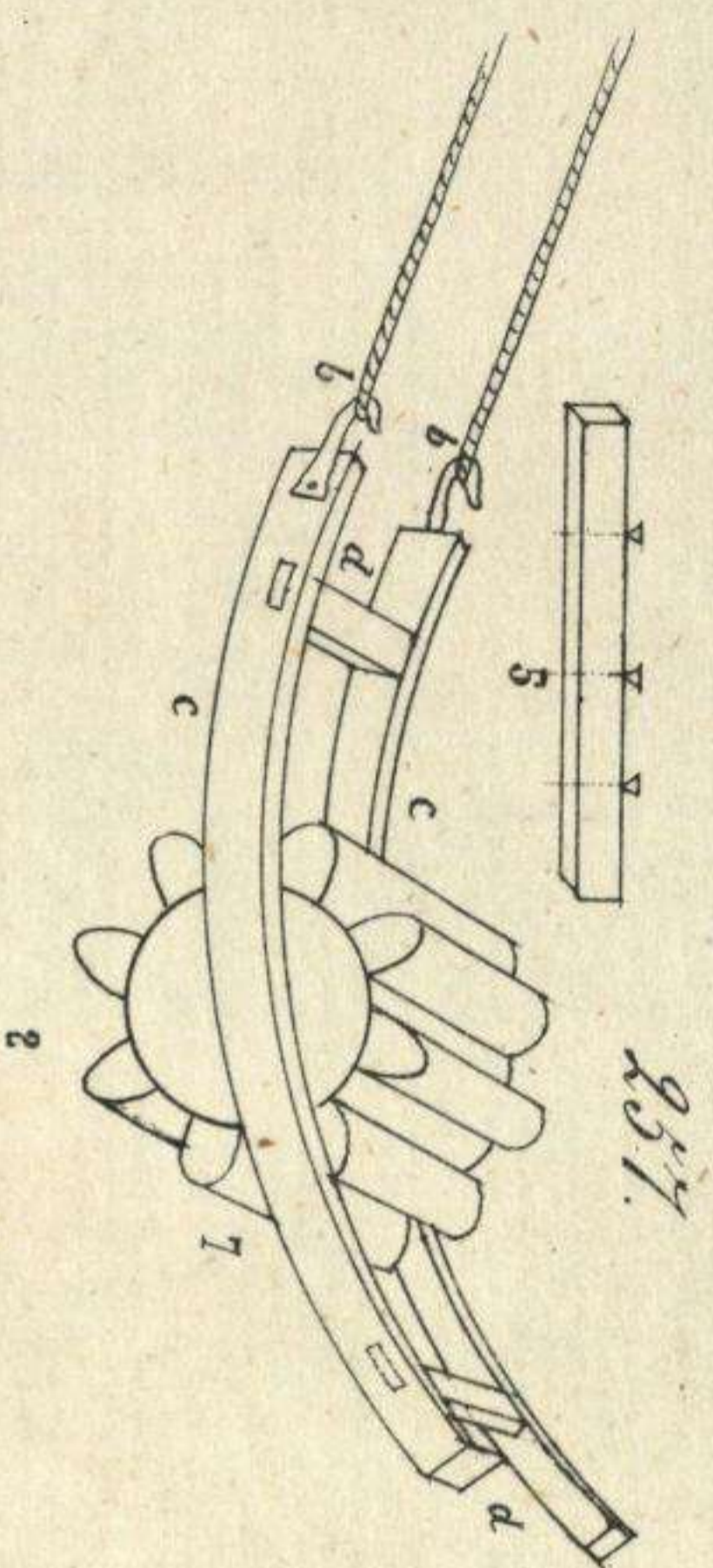
Observations on the ...



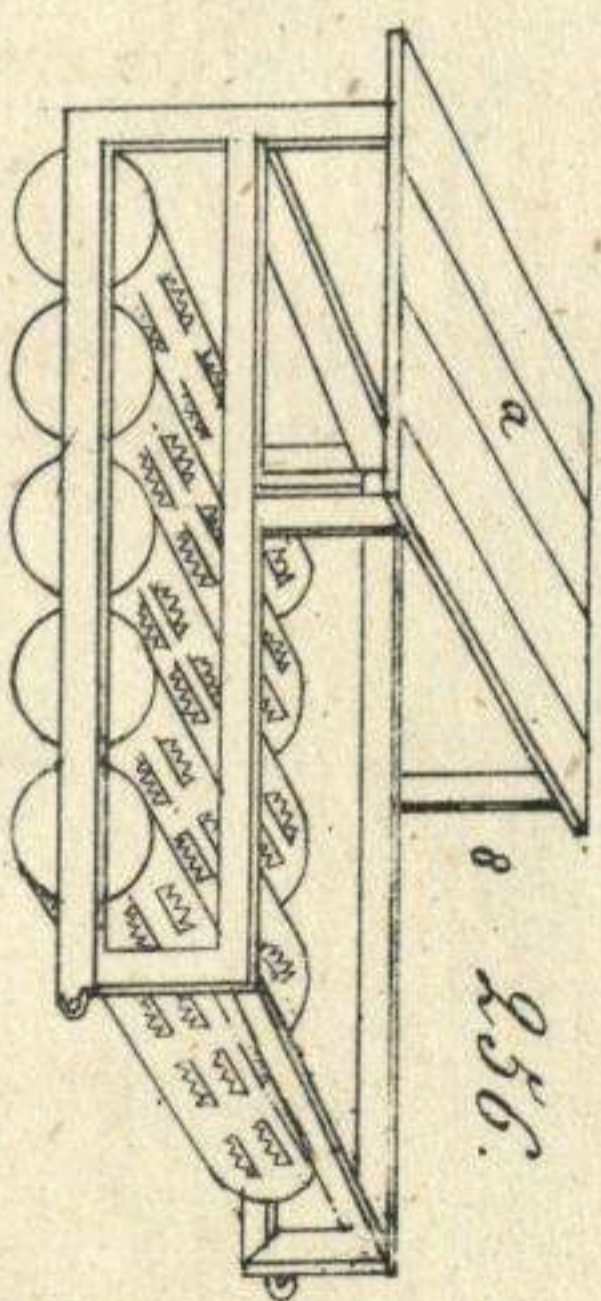




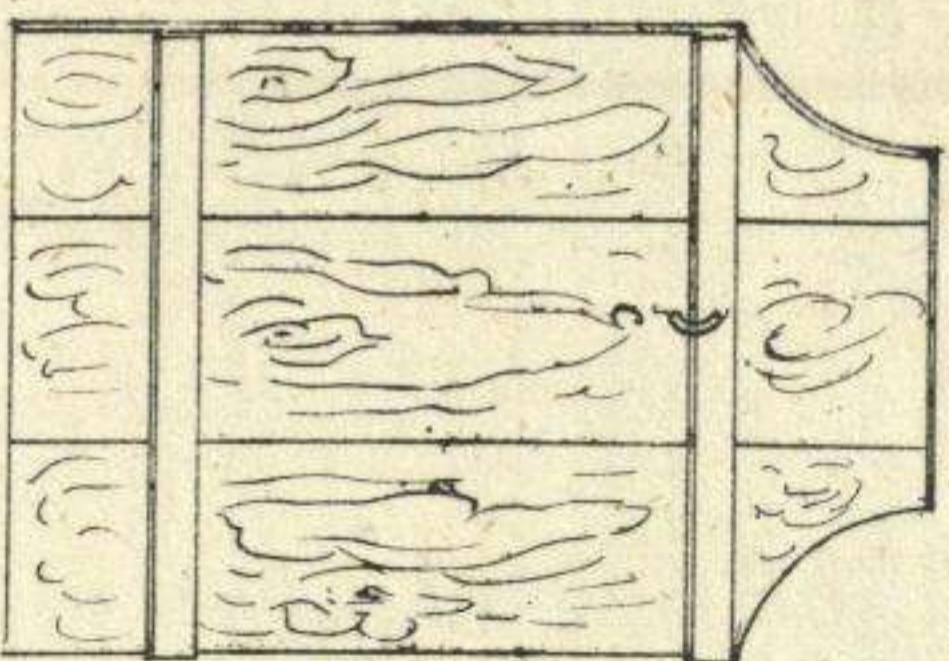




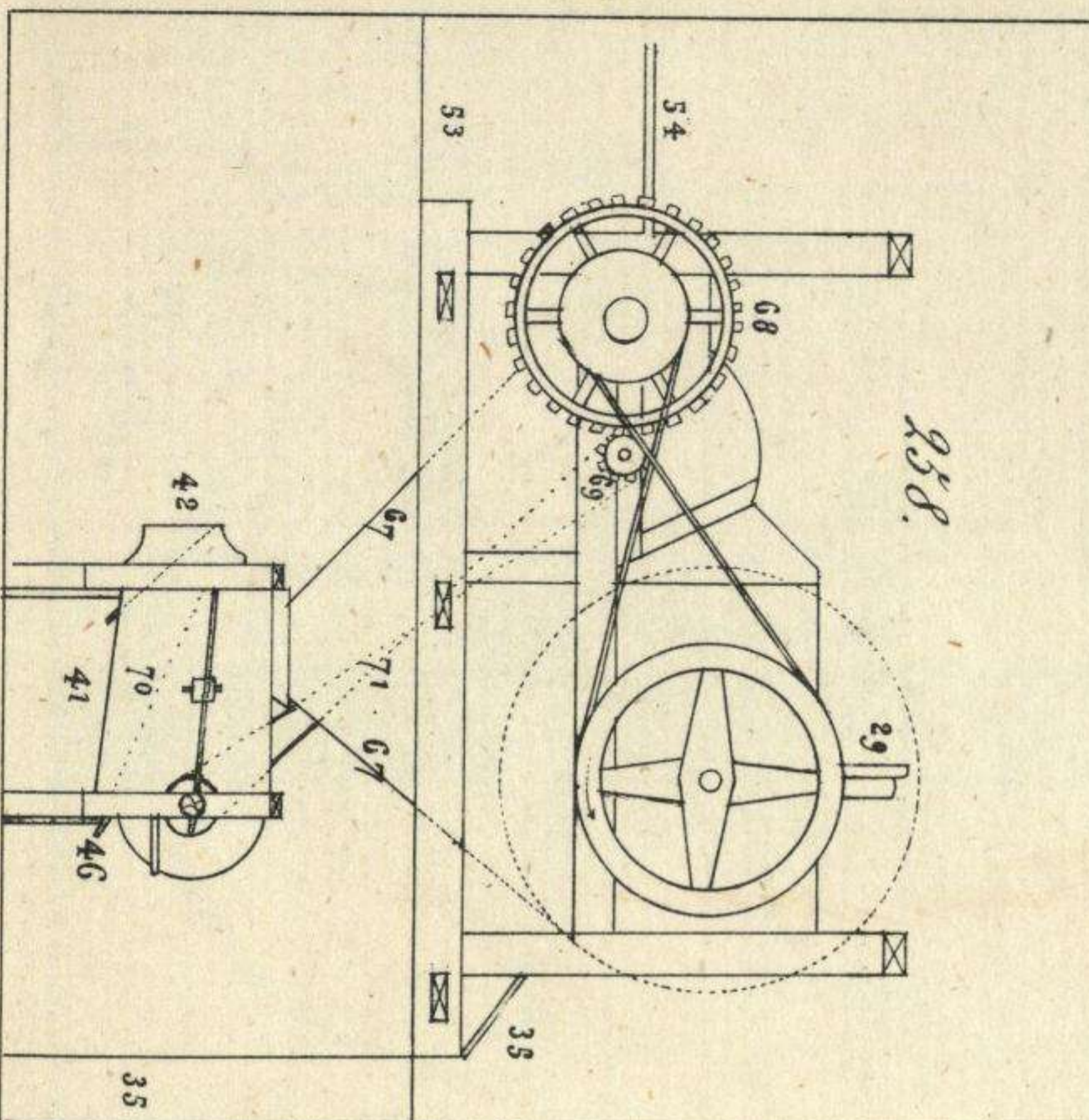
257.



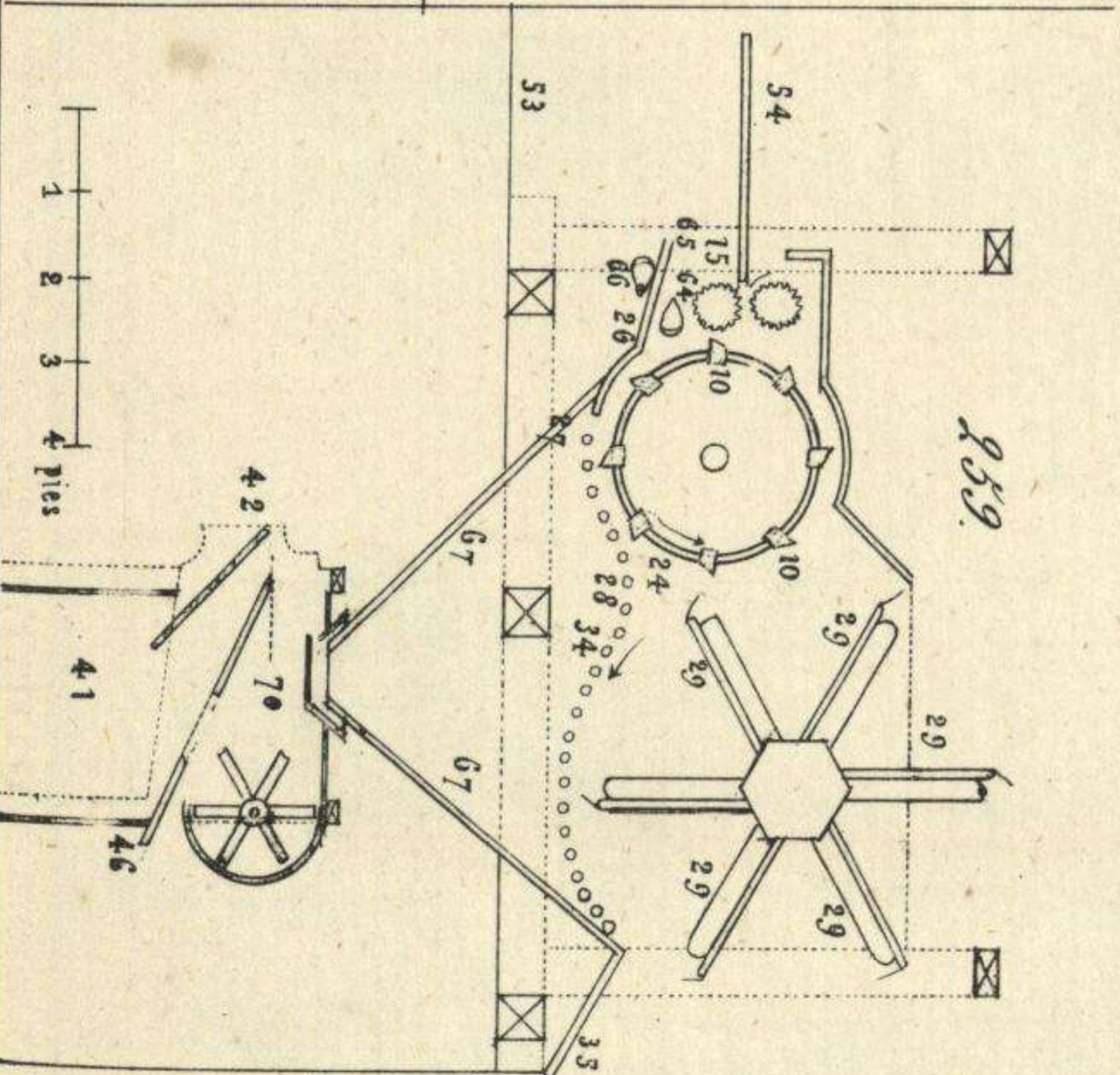
256.



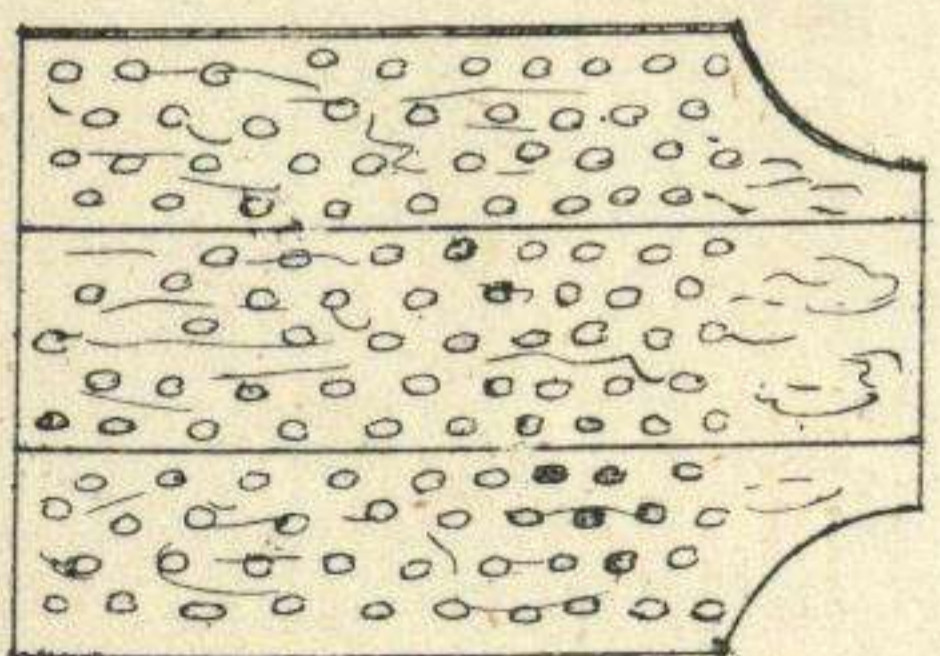
255.



258.



259.

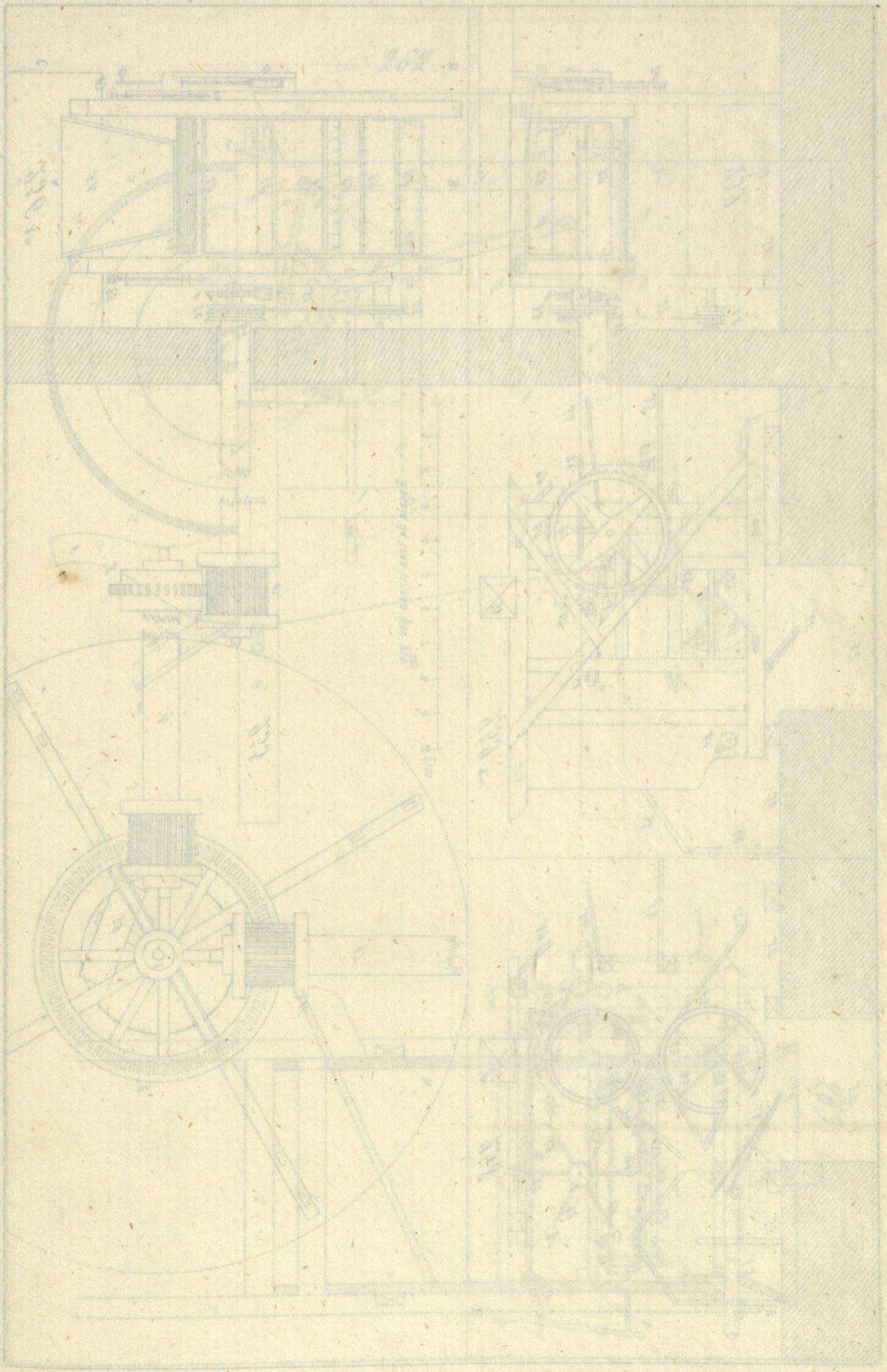


254.

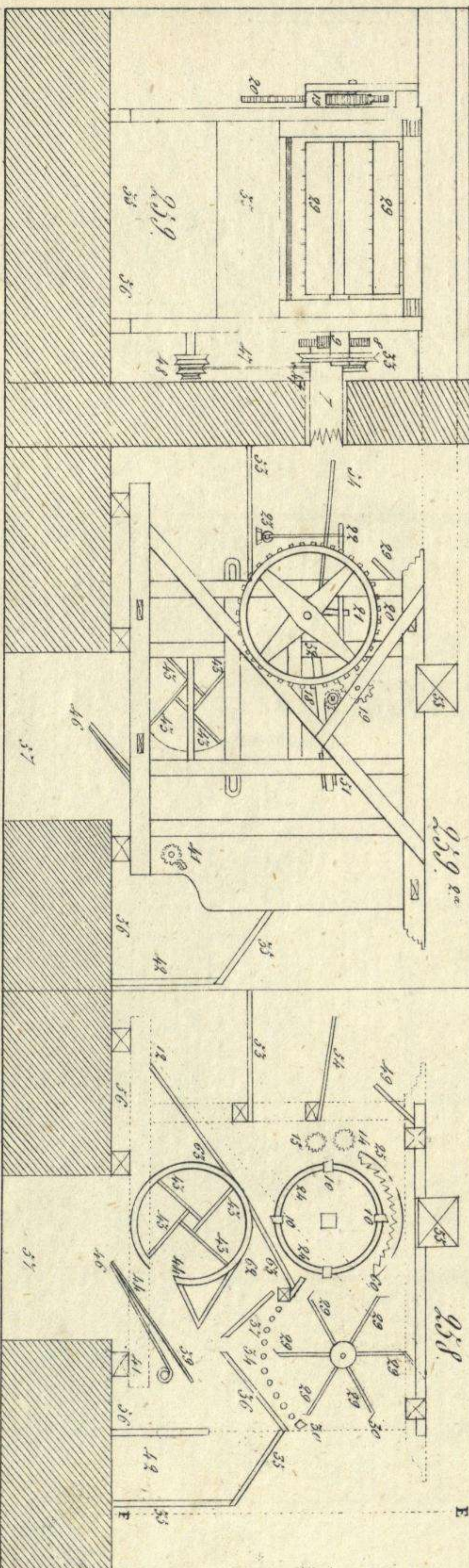
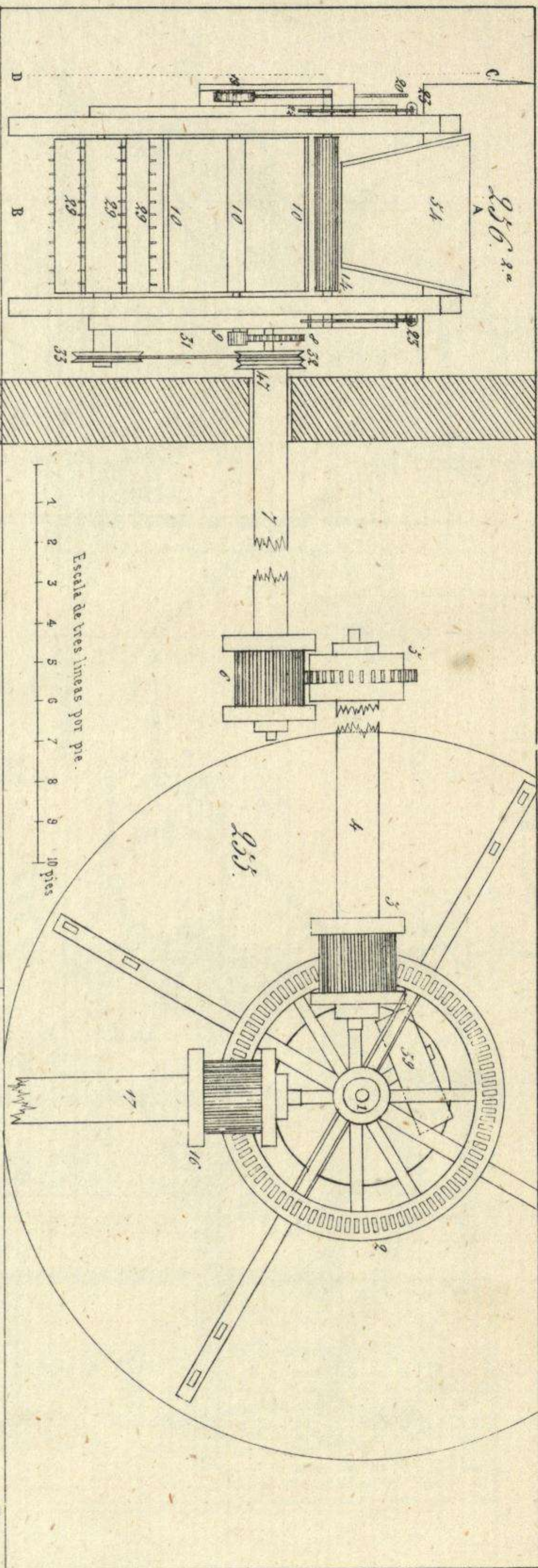






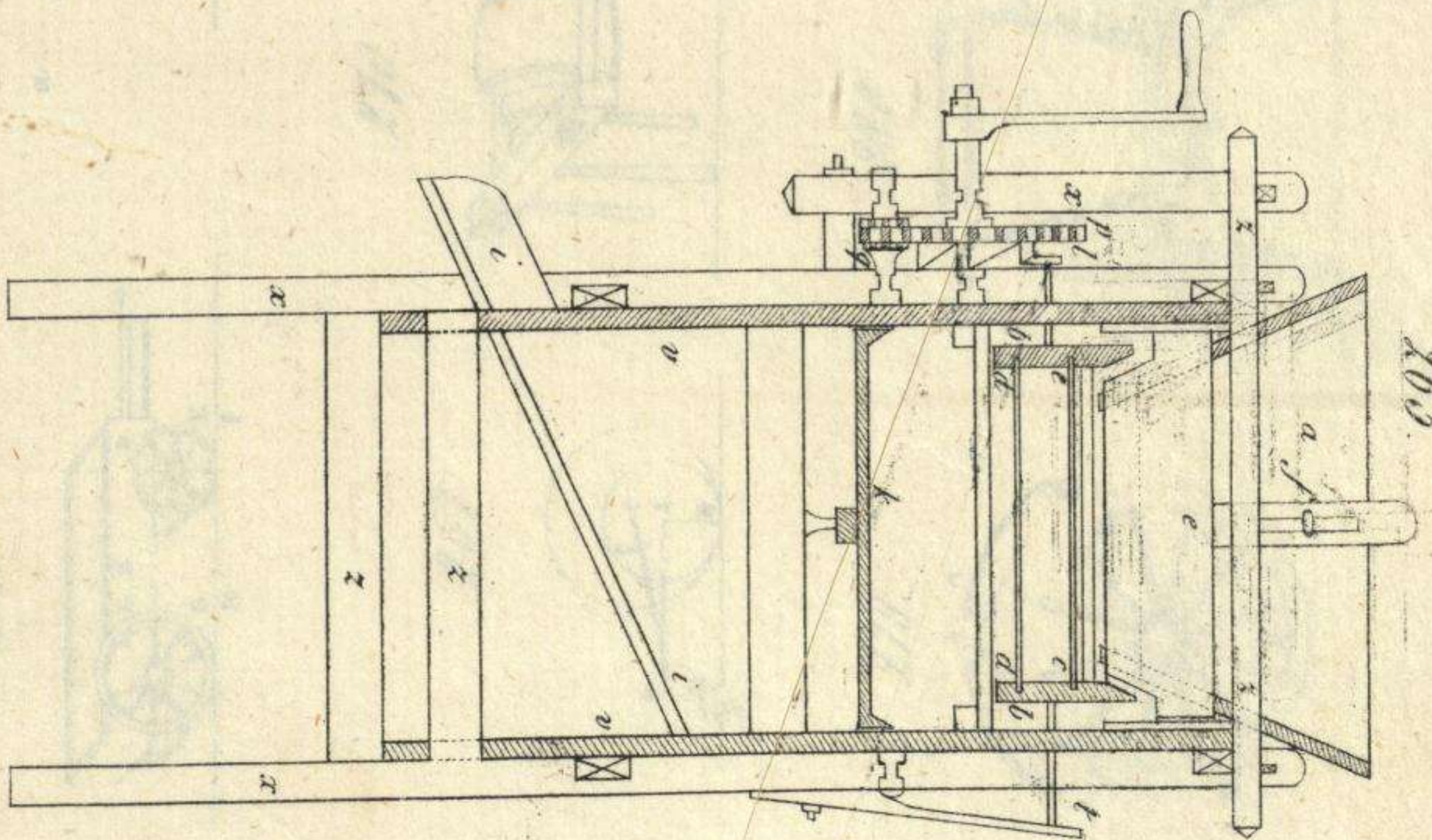
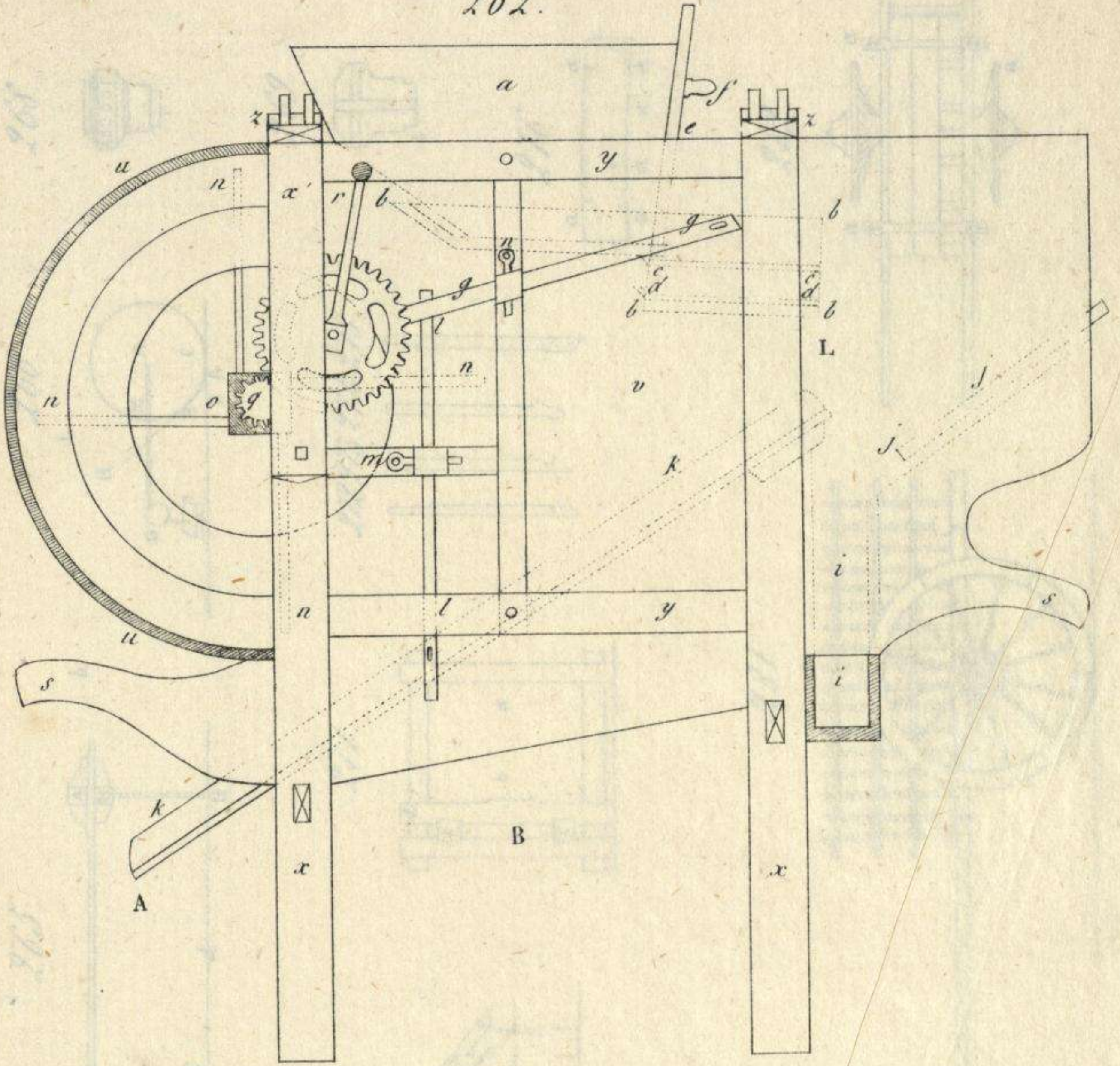








262.

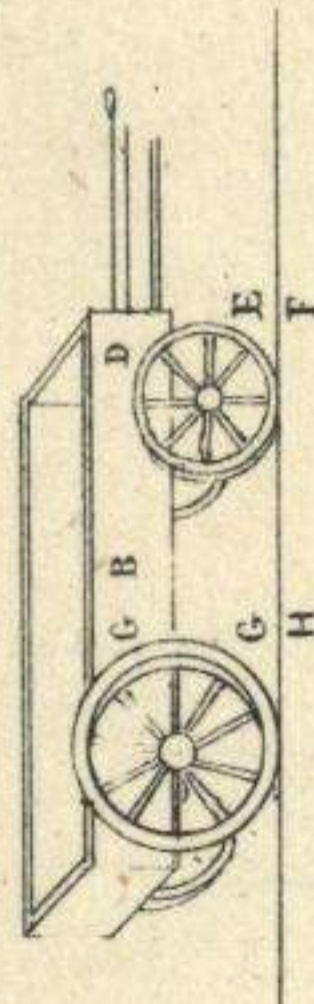




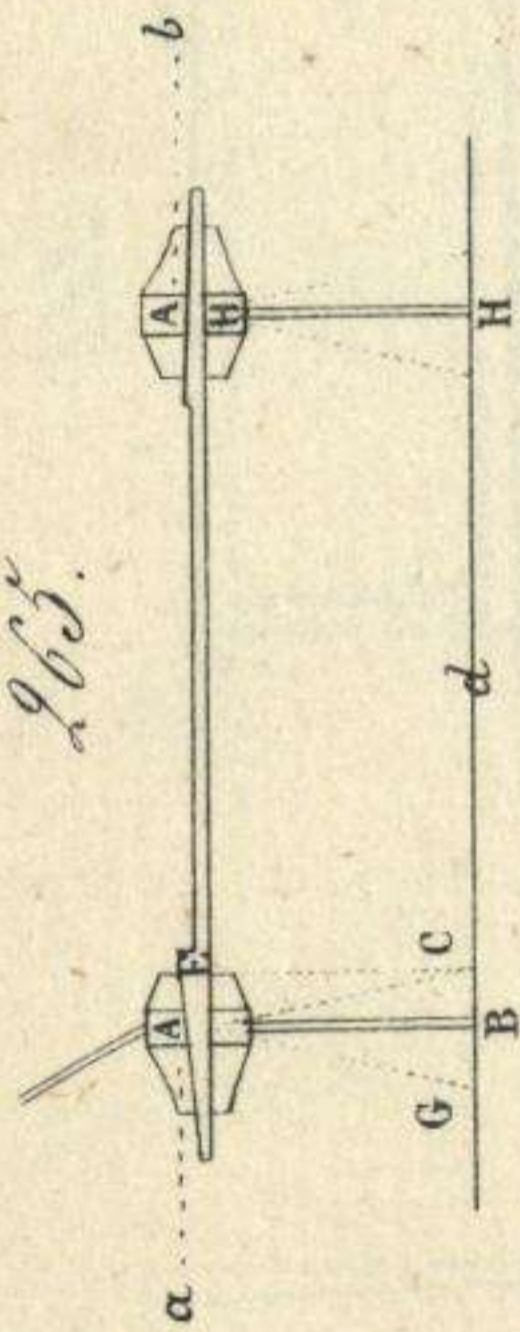




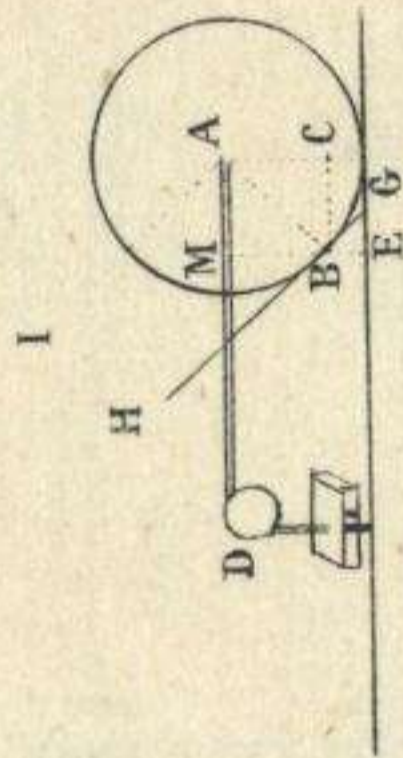
264.



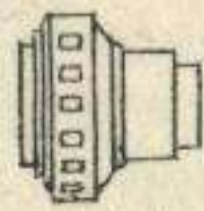
265.



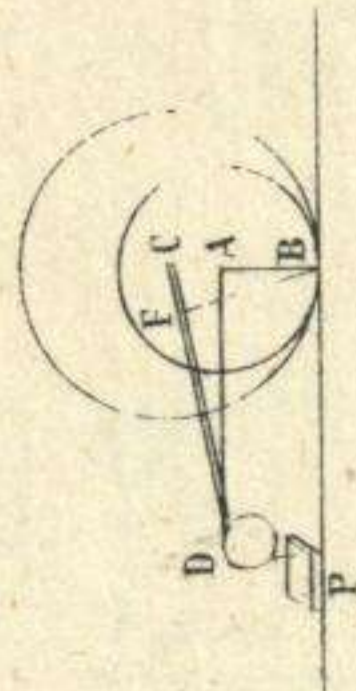
266.



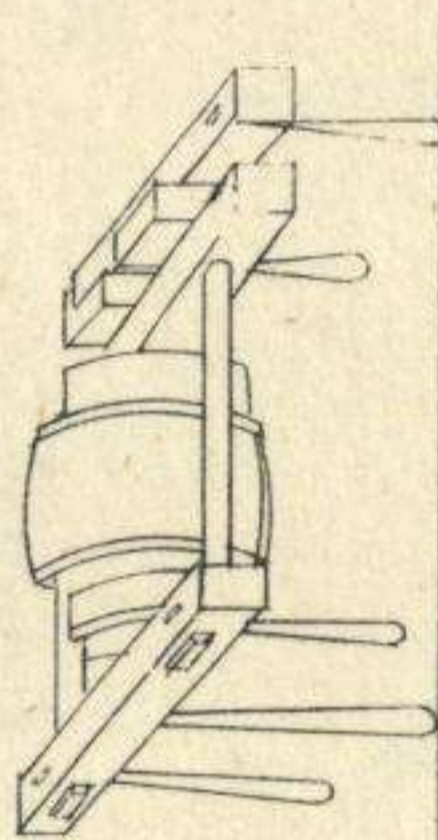
268.



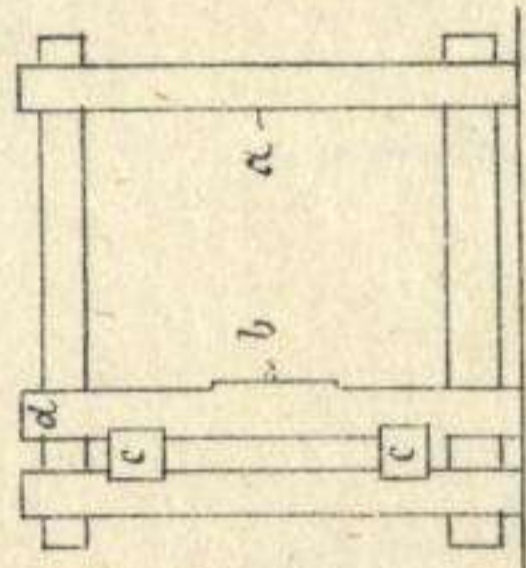
267.



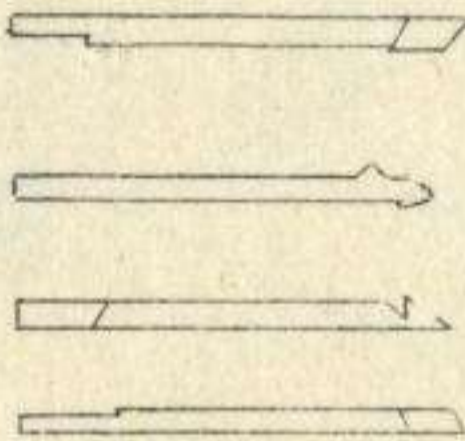
270.



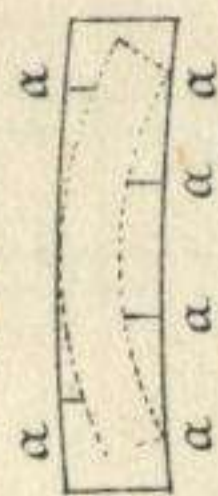
271.



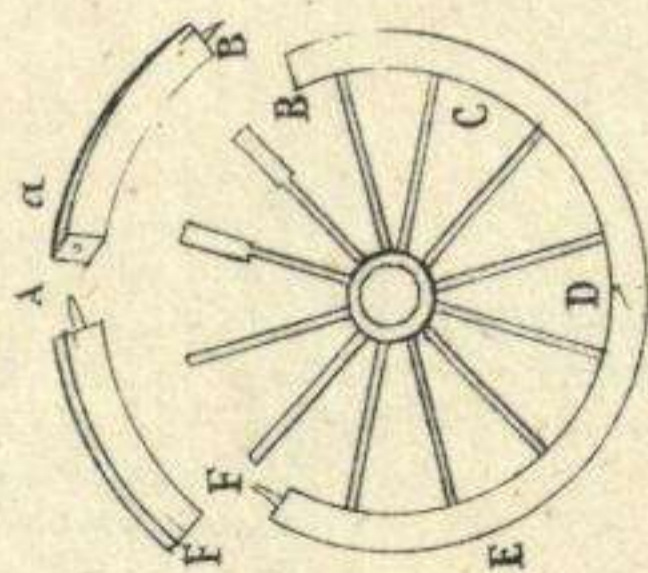
272. 273. 274. 275.



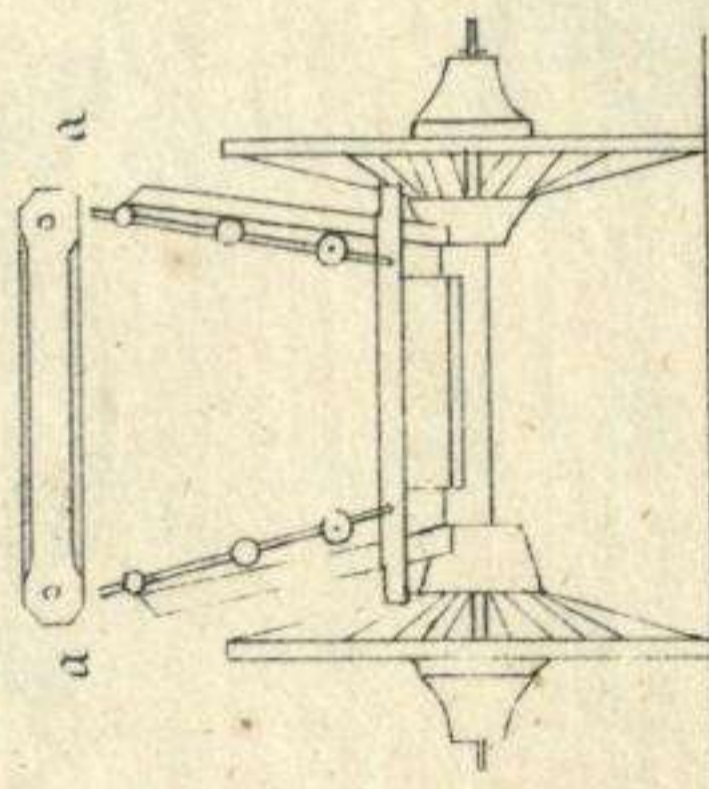
276.



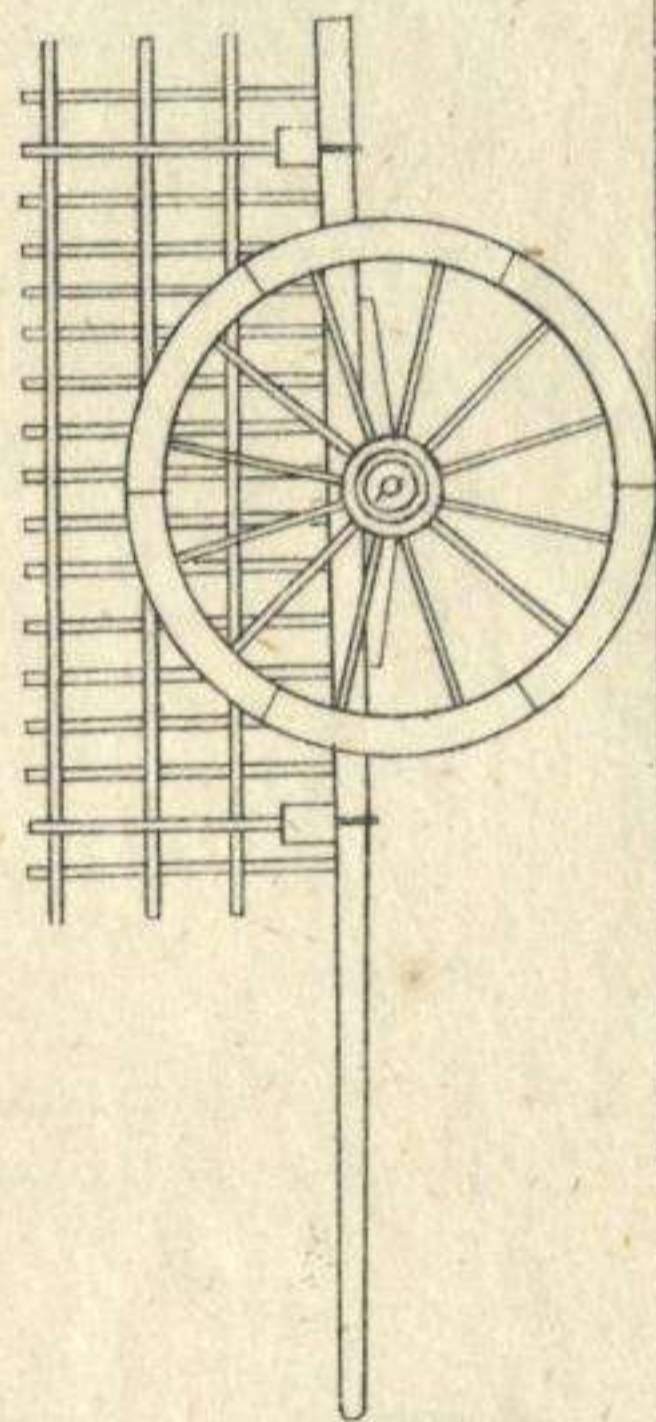
279.



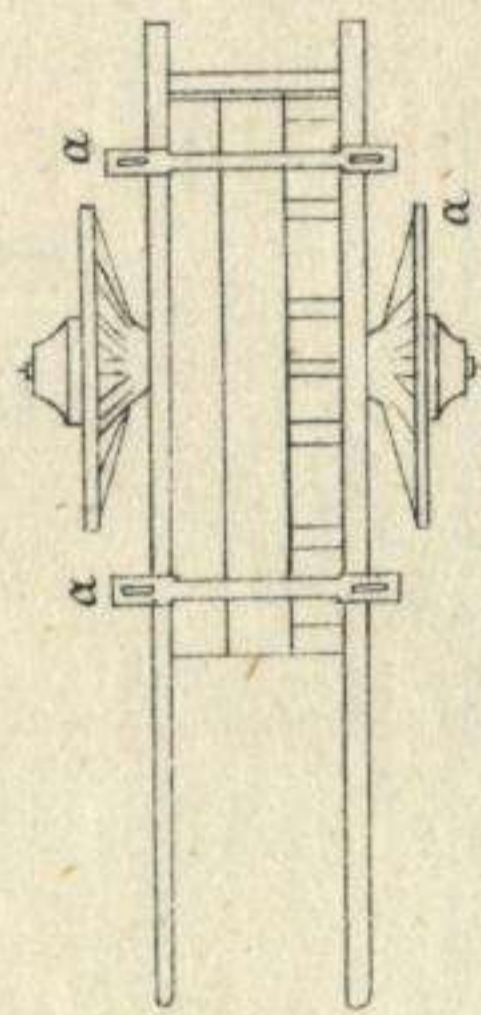
280.



281.



282.



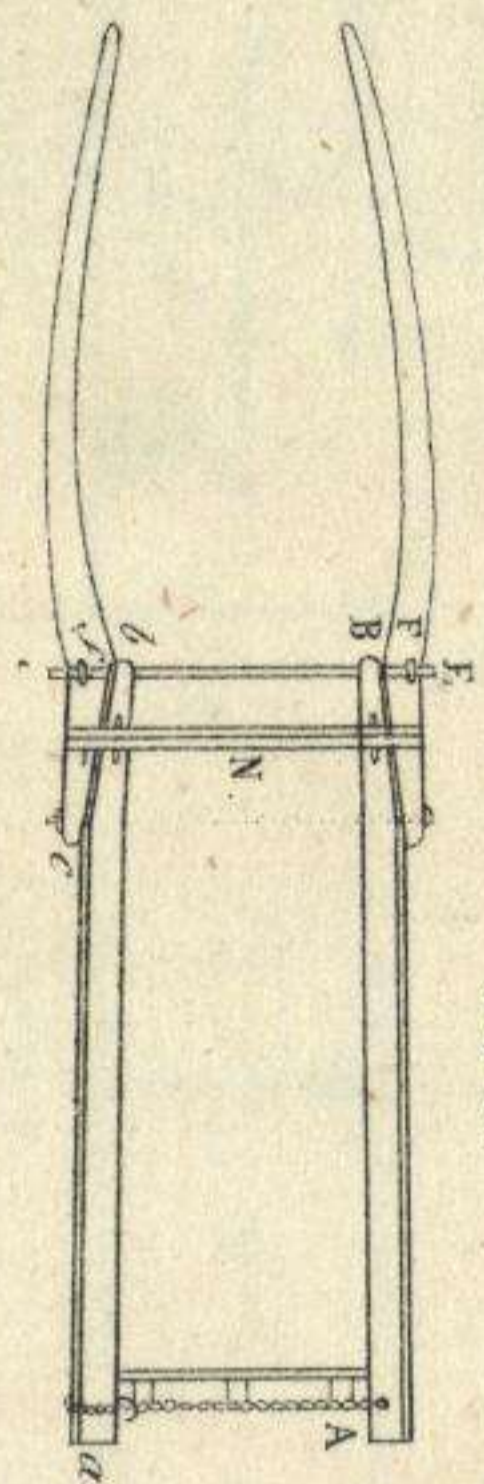






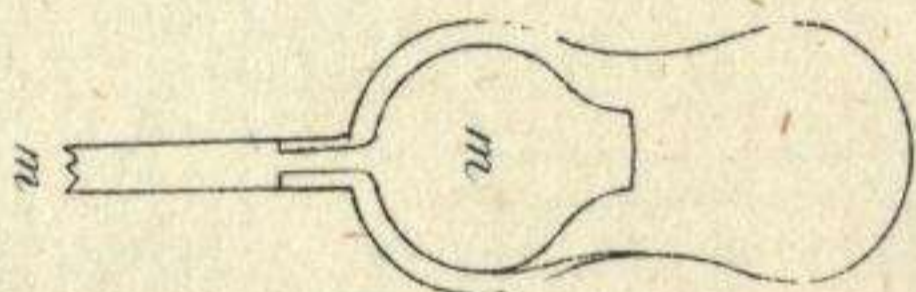
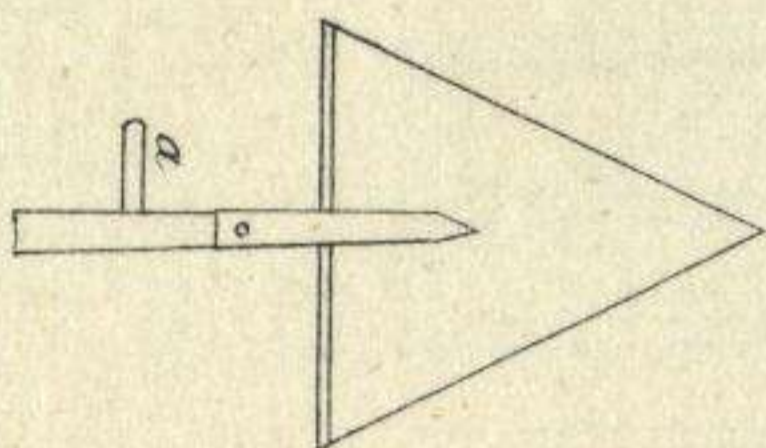






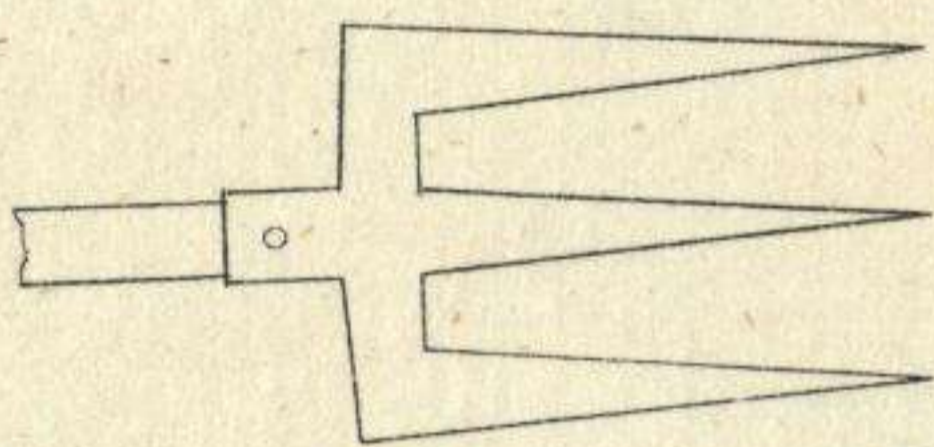
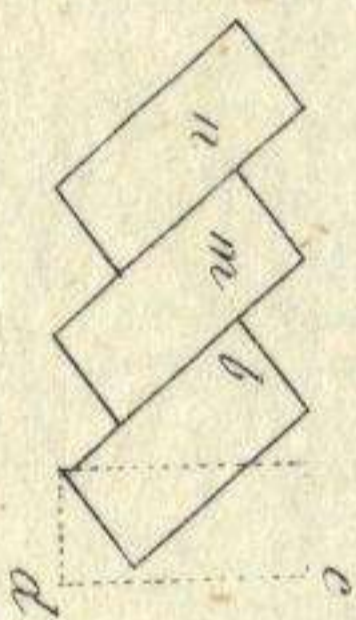
288.

288.

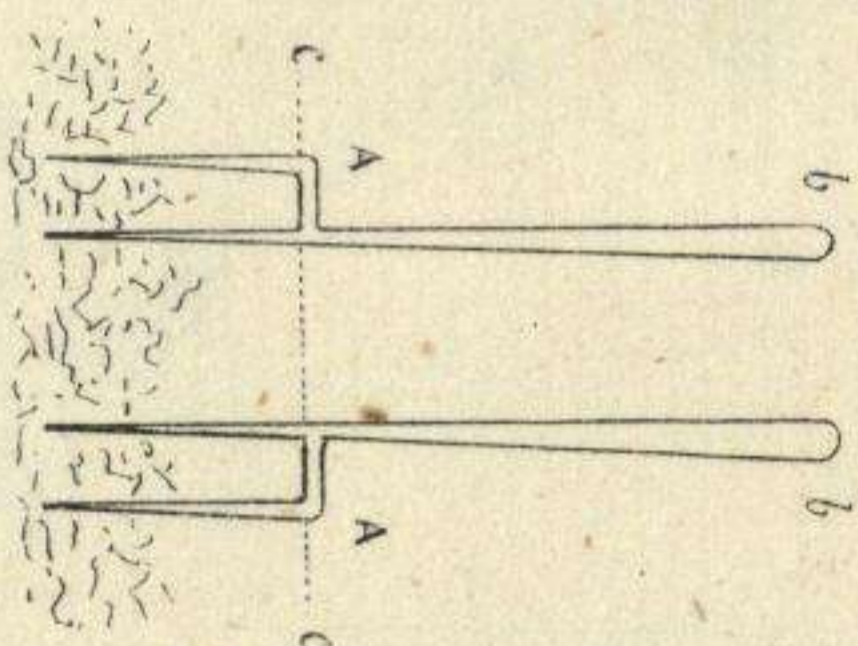


289.

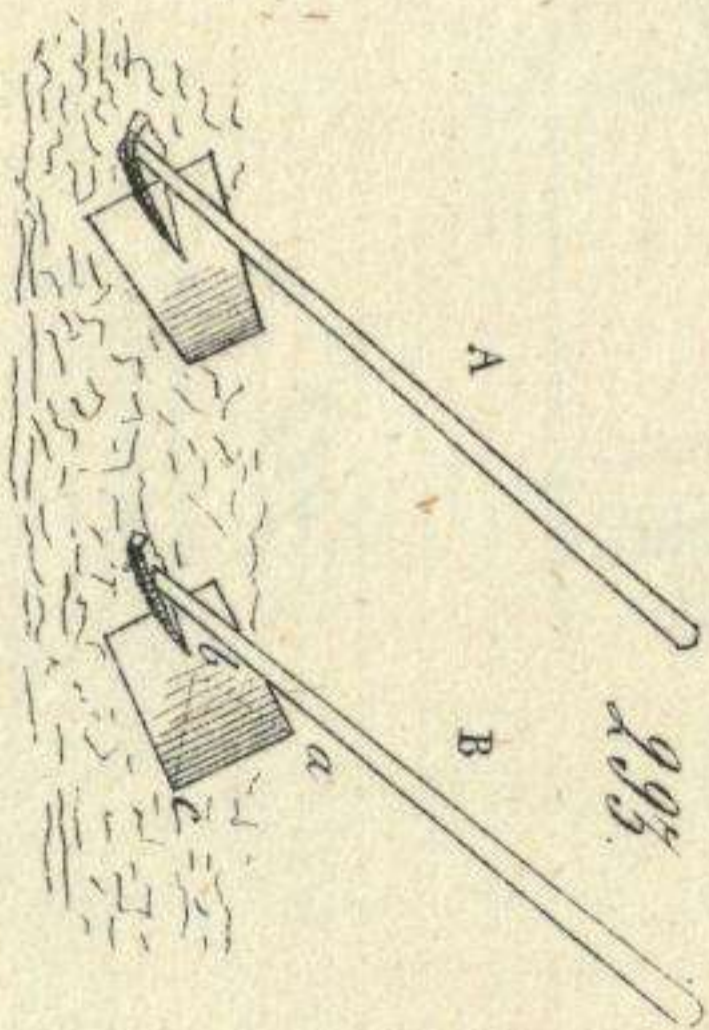
291.



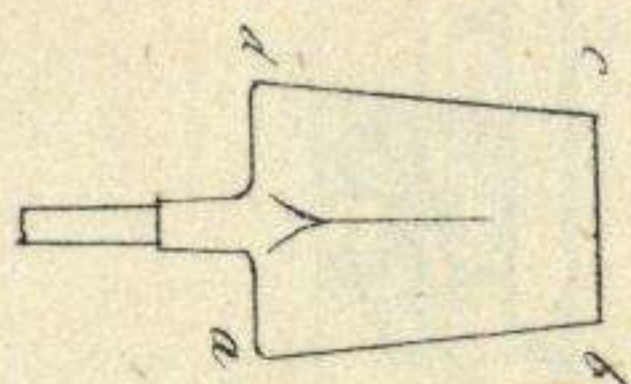
292.



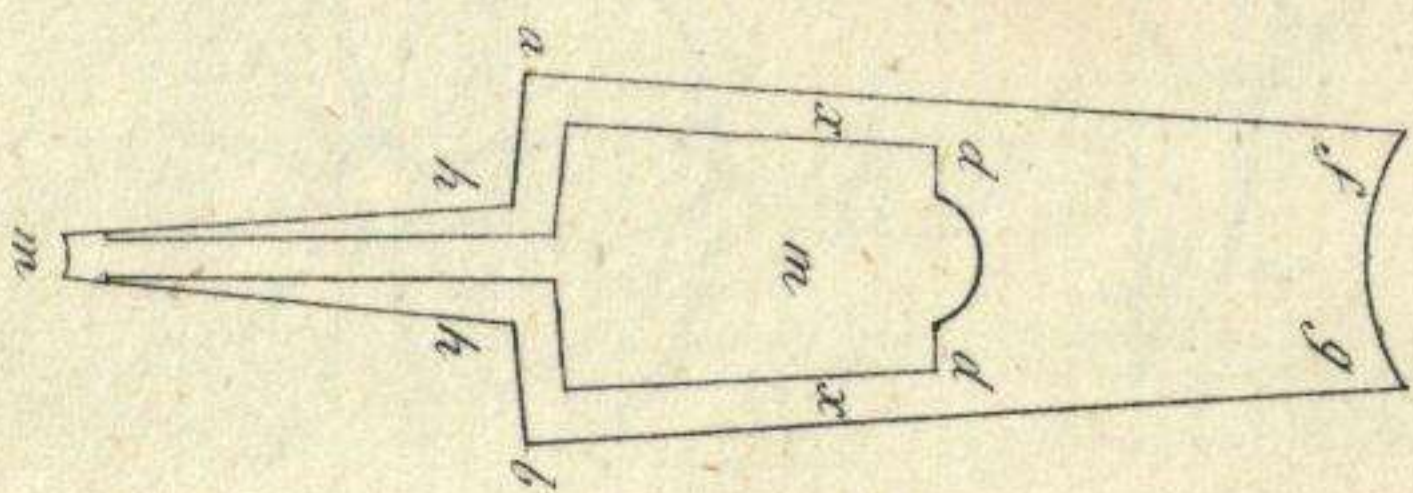
285.



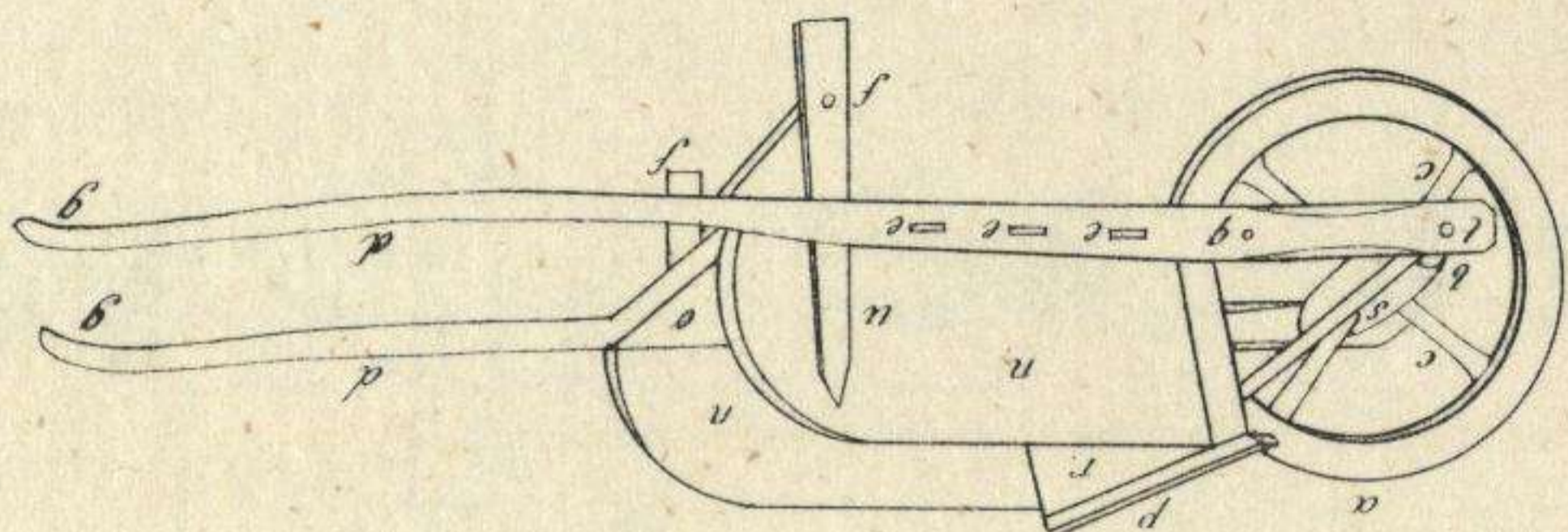
293.



286.

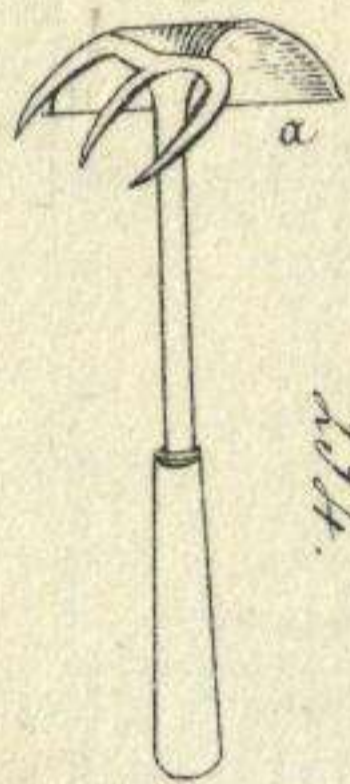


287.



284.

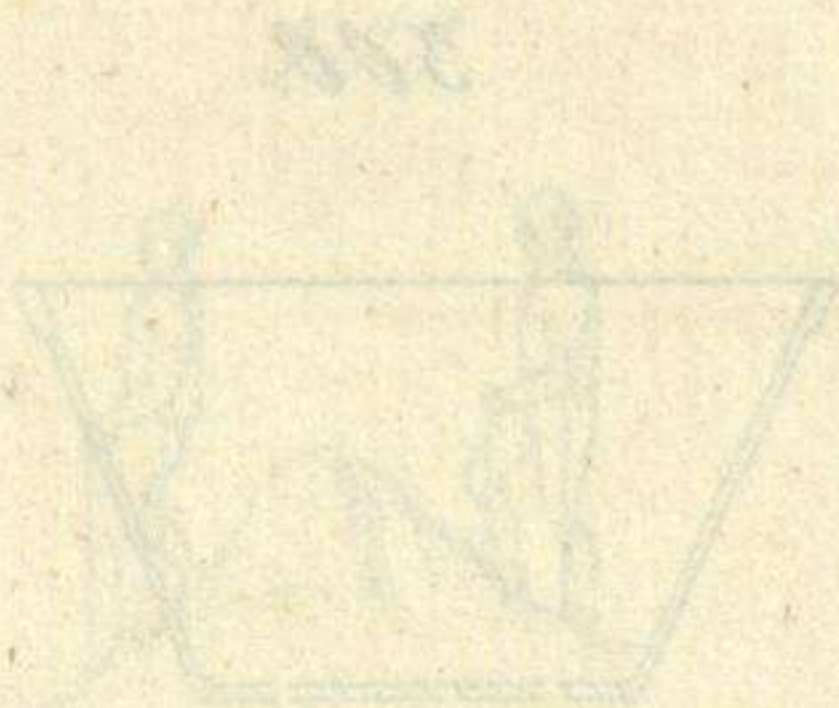
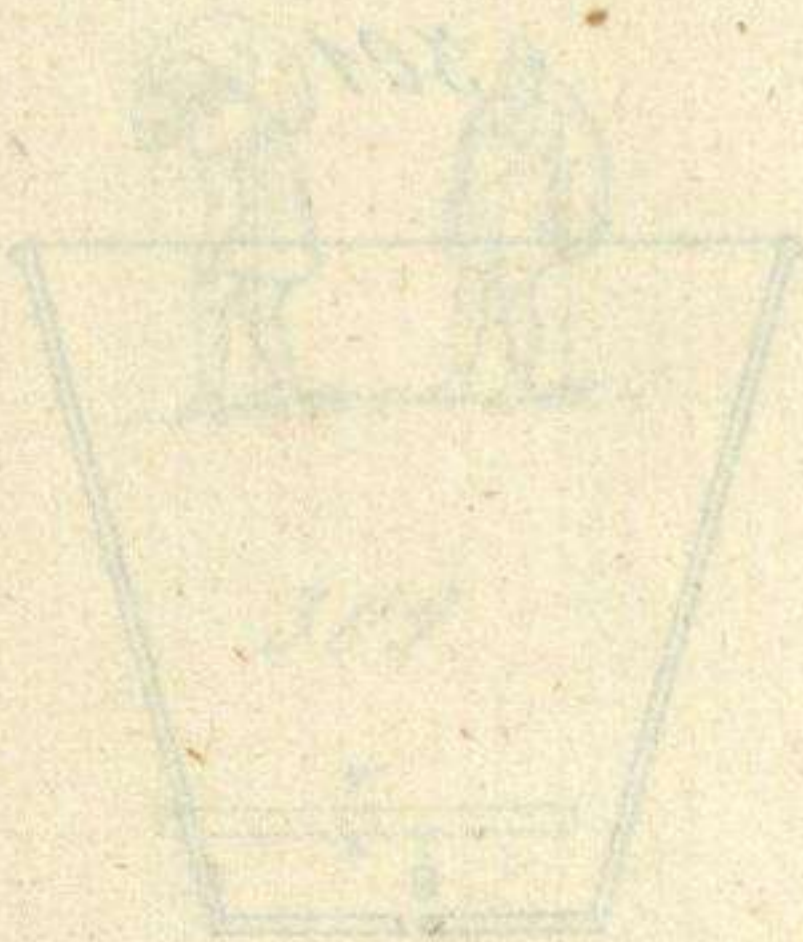
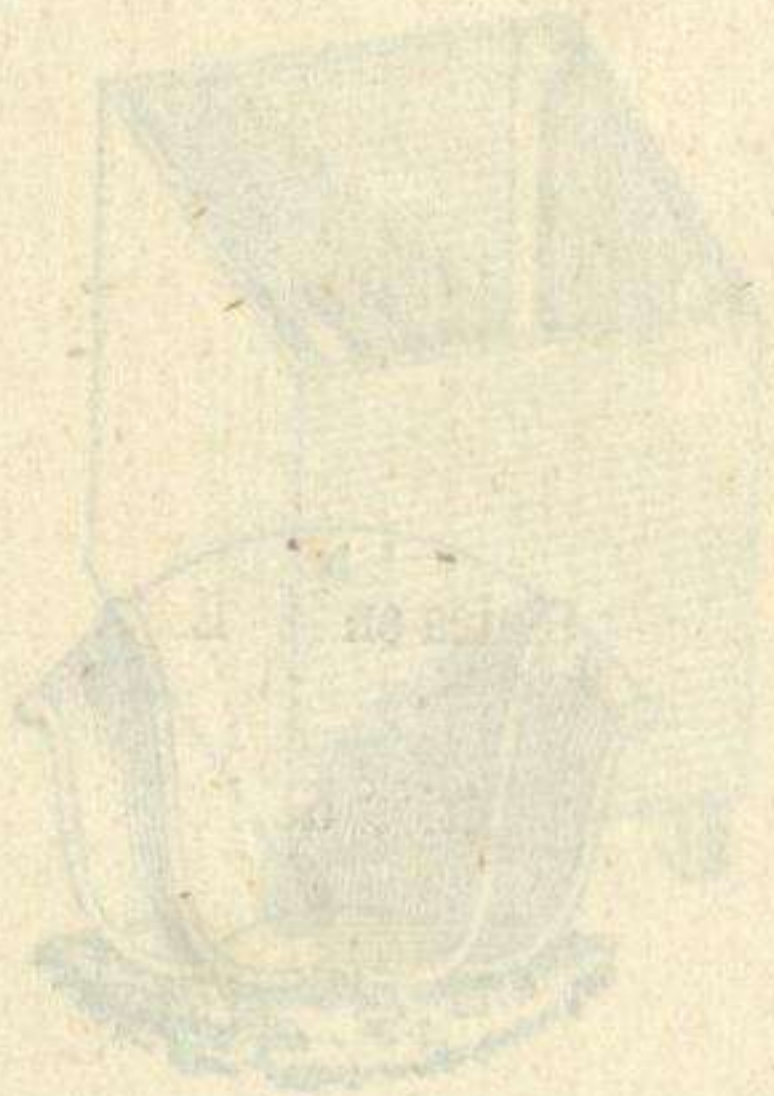
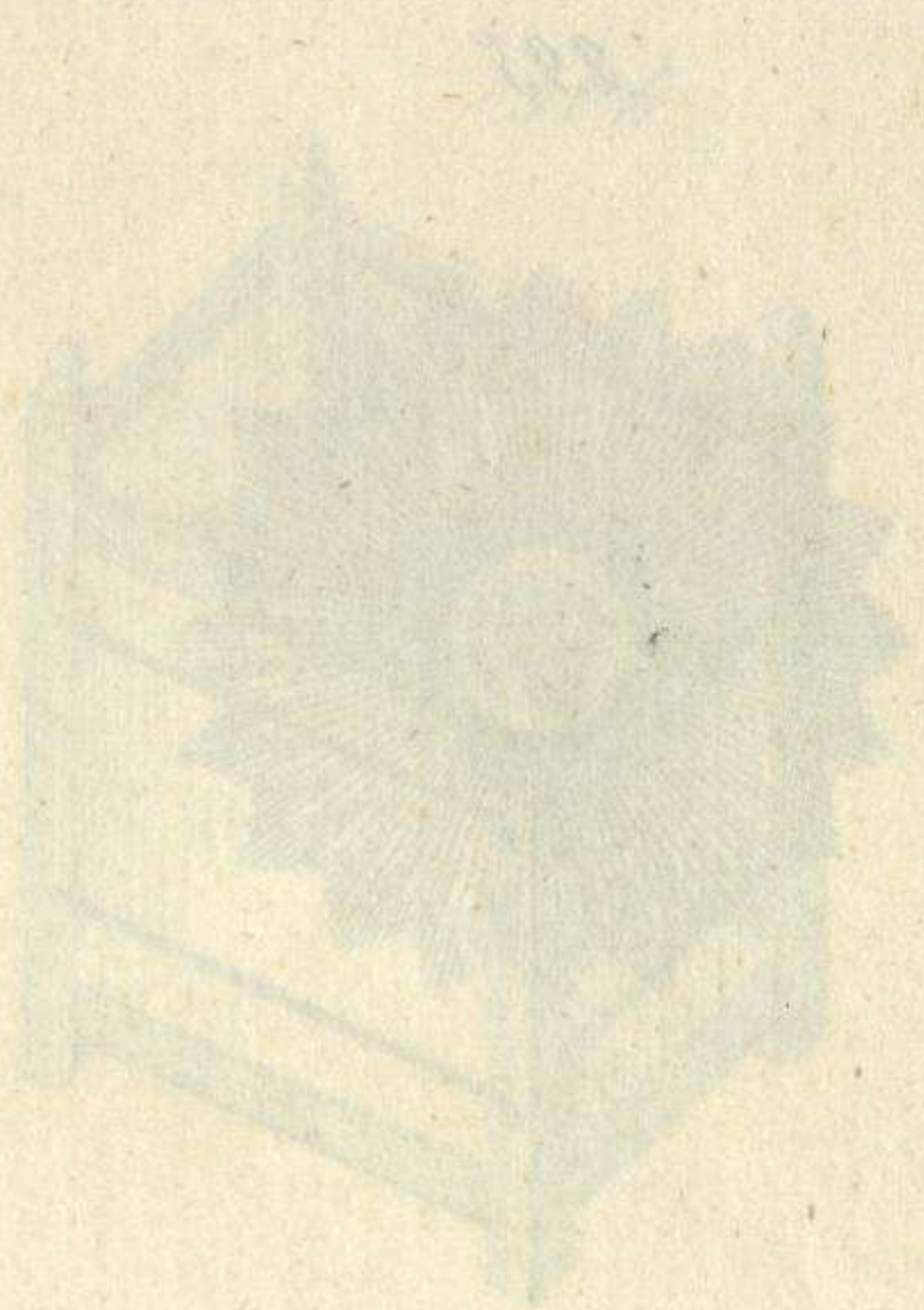
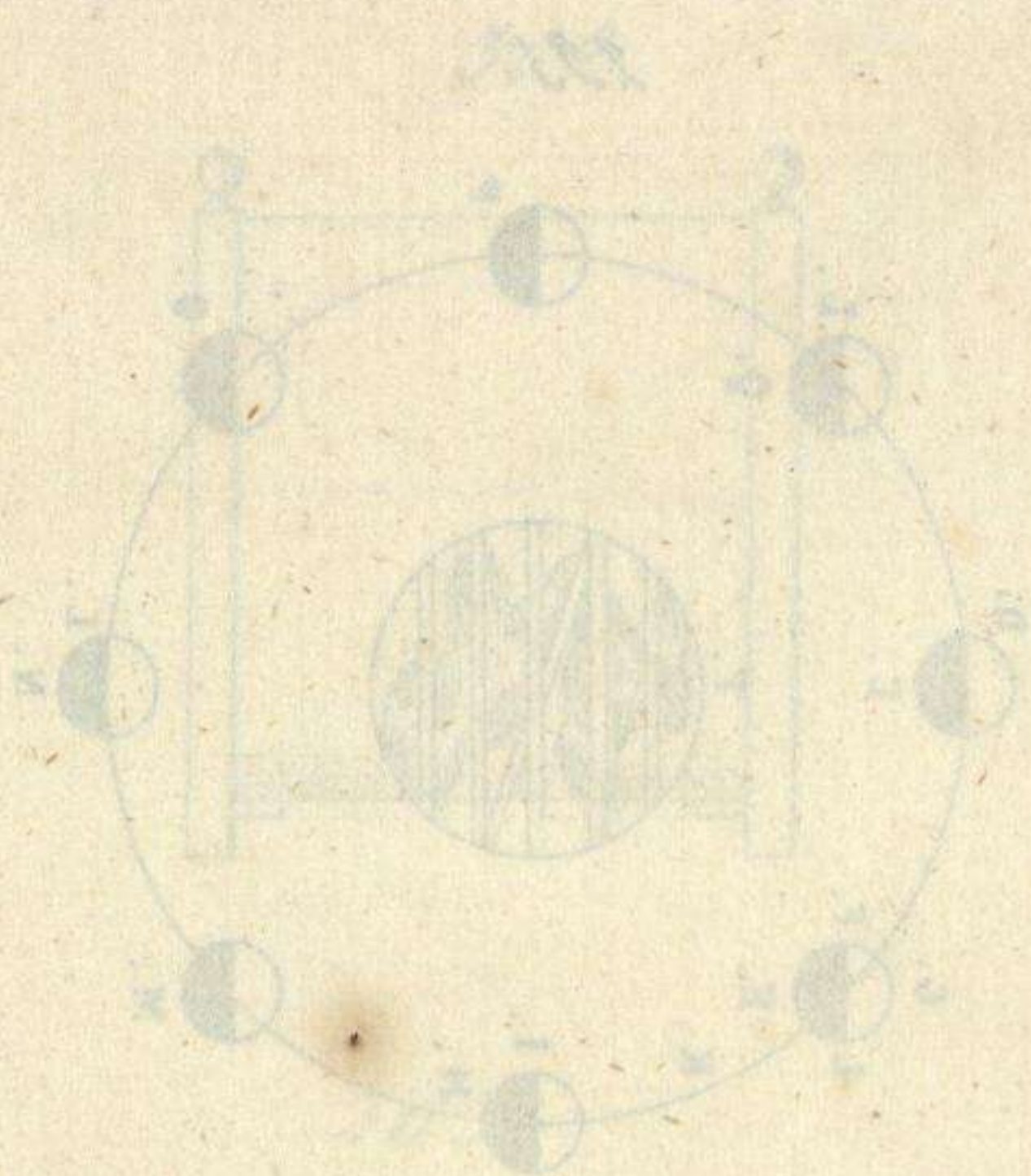
290.



294.

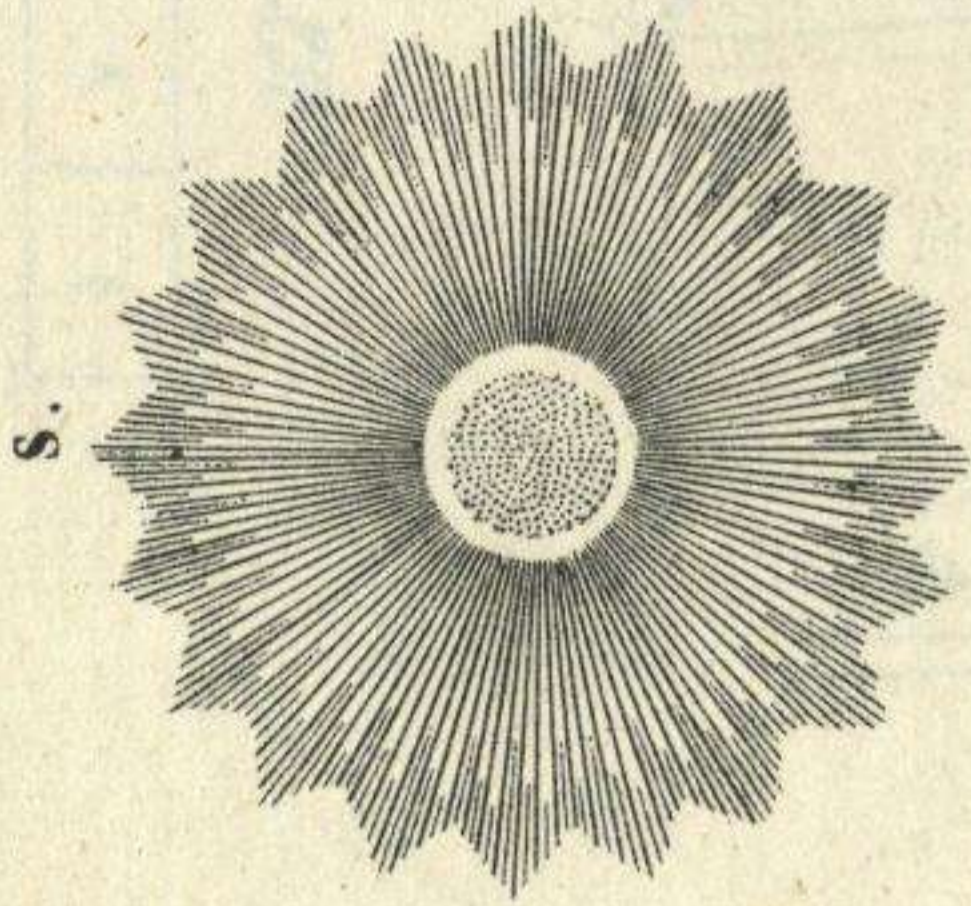


Quadranten der Sphäre

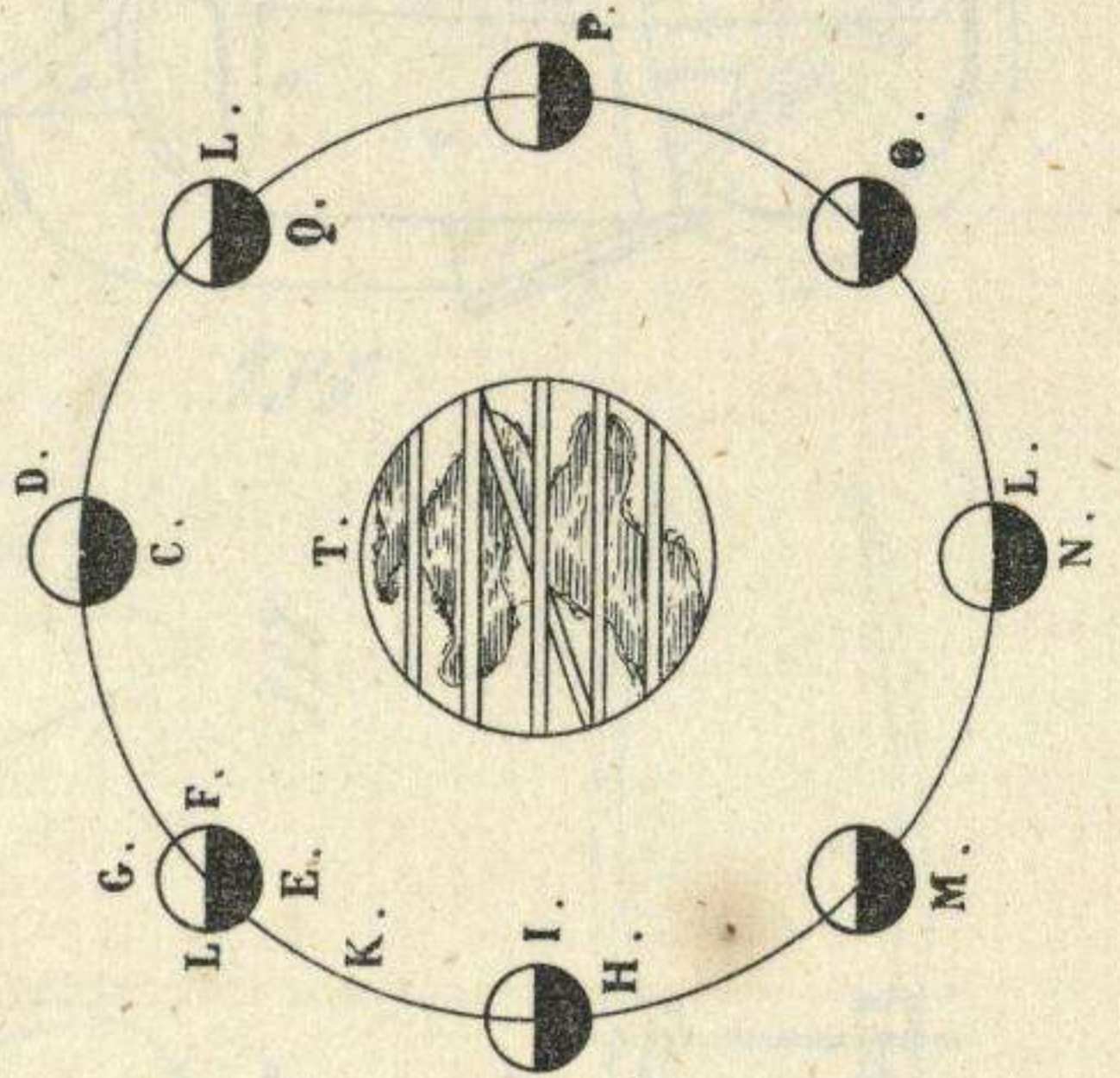




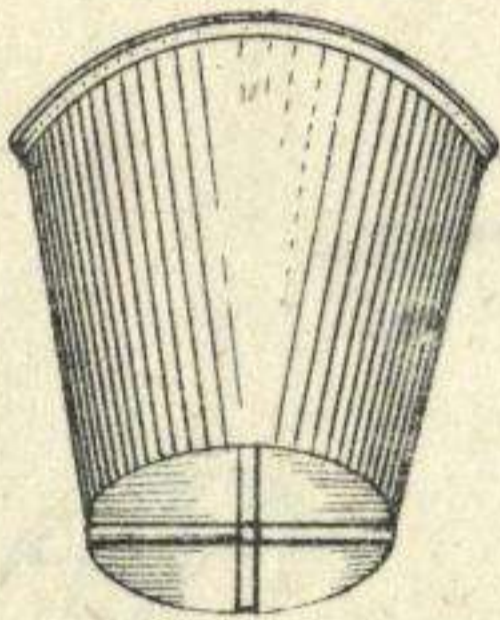
295.



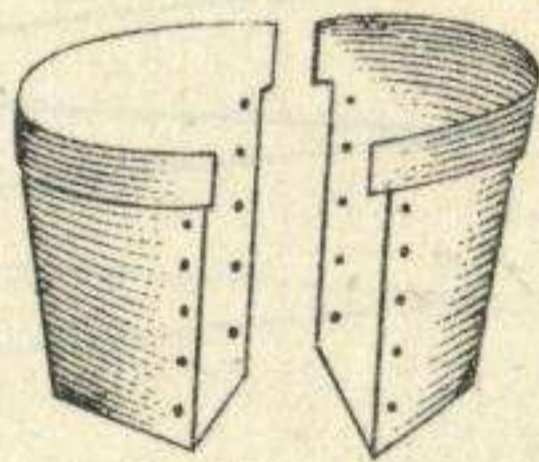
295.



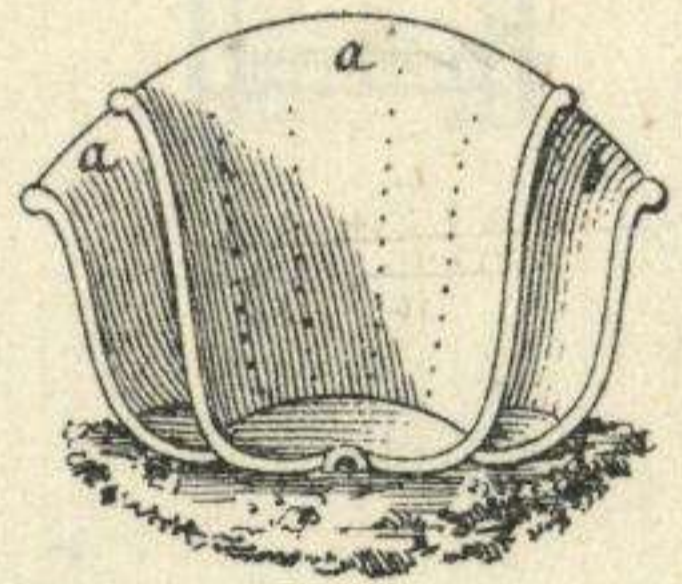
296.



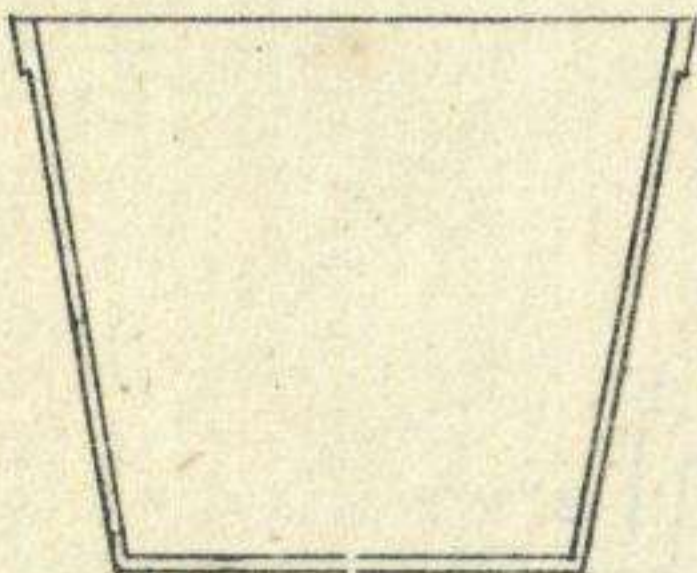
297.



298.



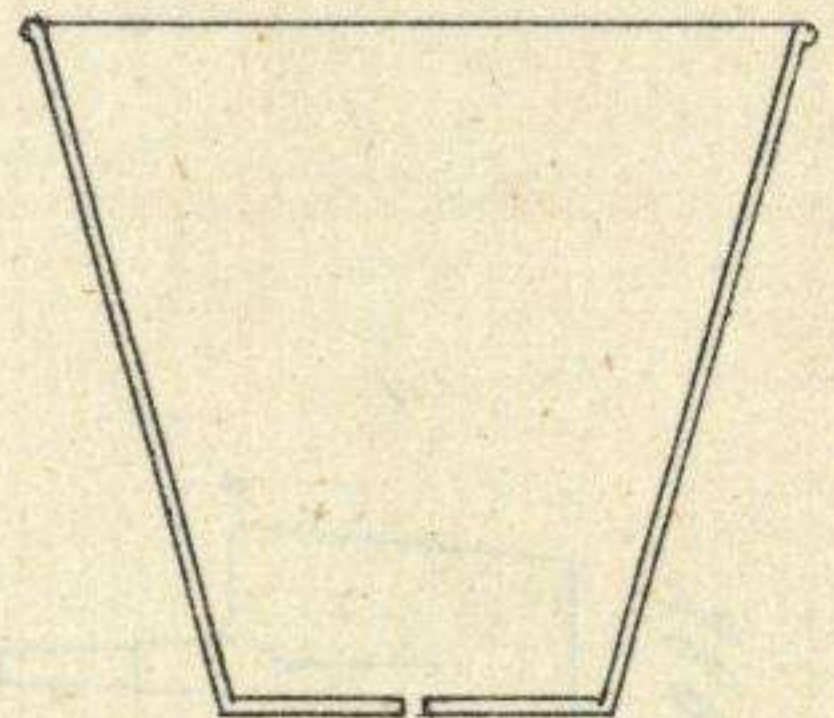
299.



300.



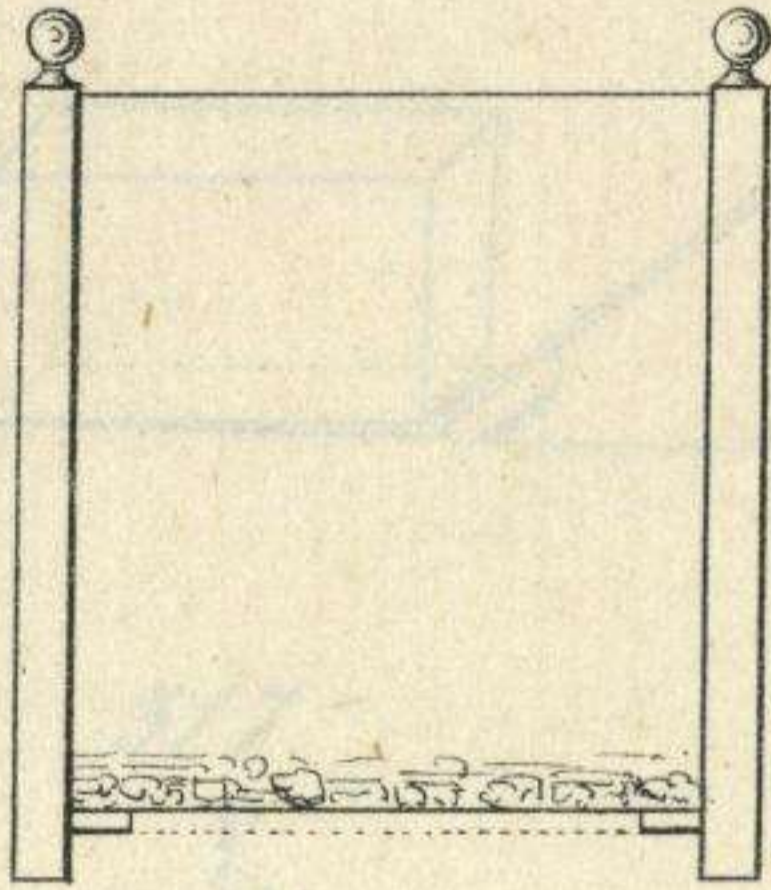
301.



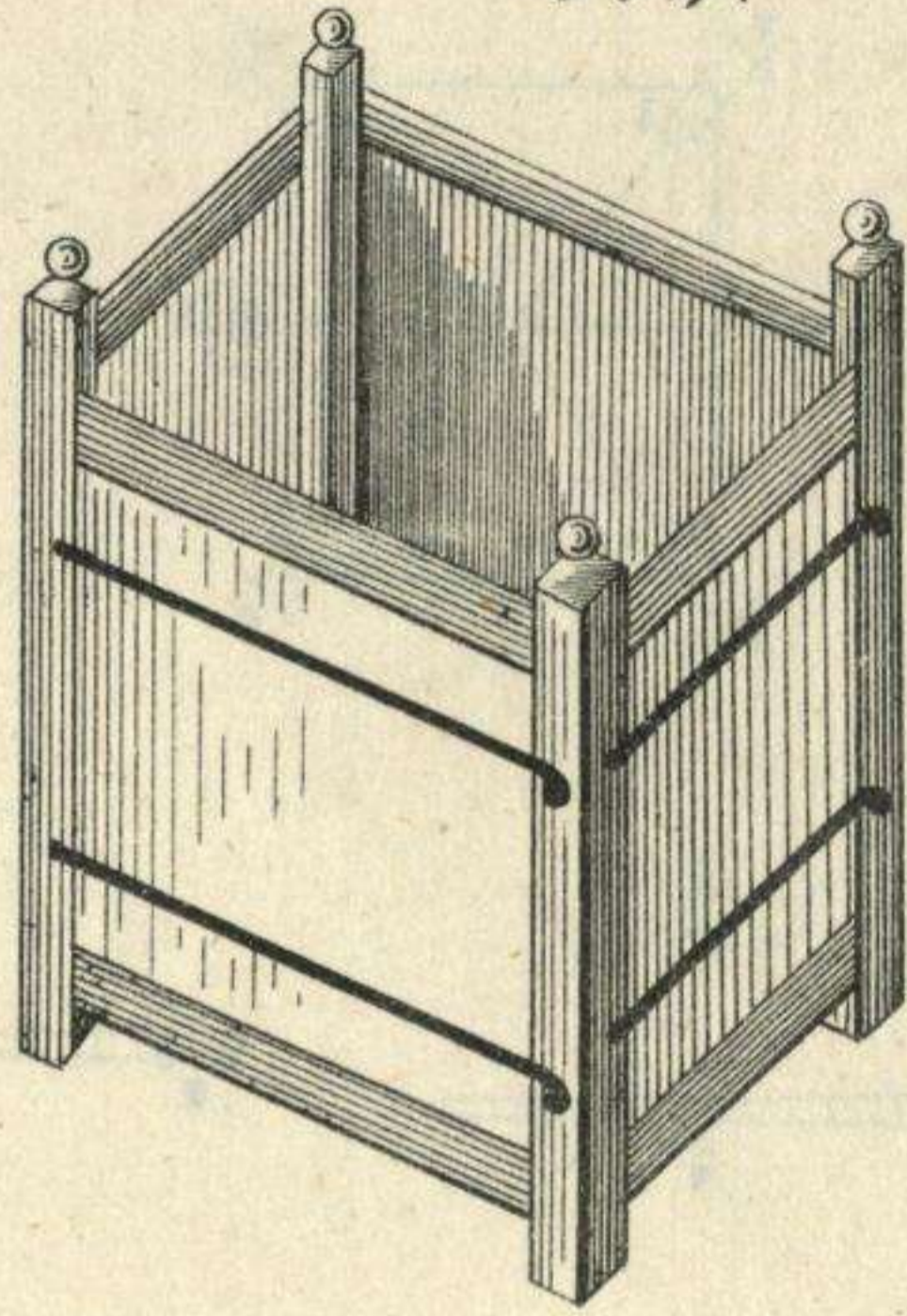


# Diccionario de Agricultura.

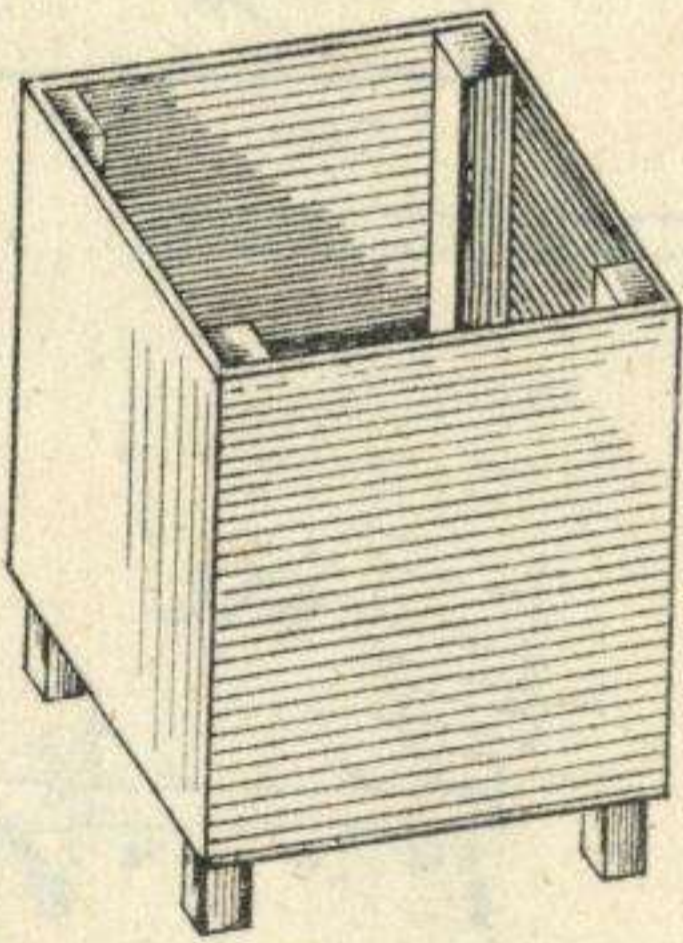
302.



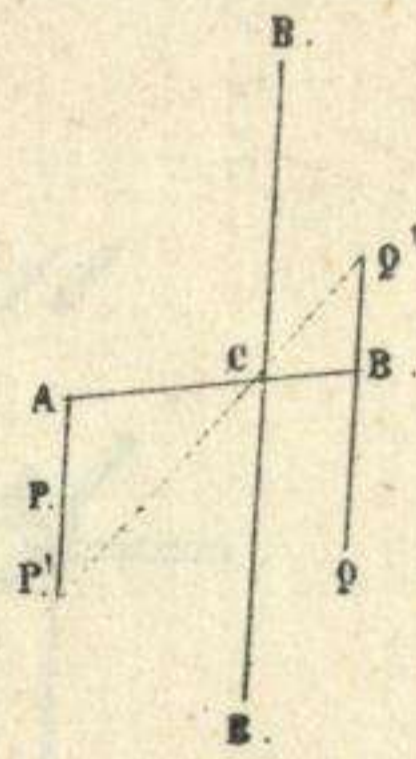
304.



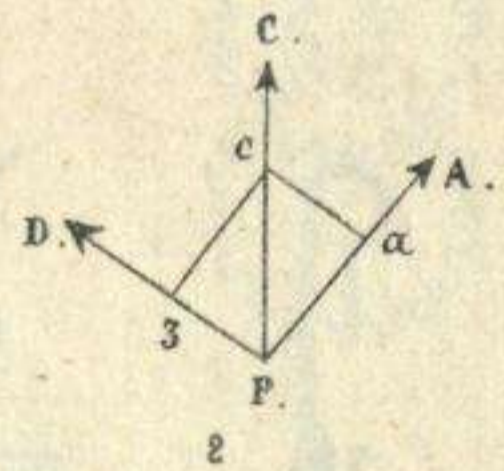
303.



305.



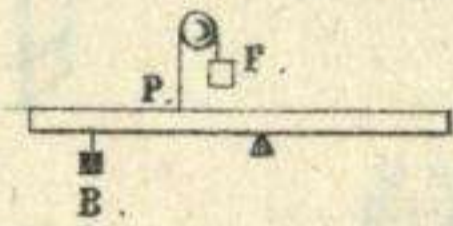
306.



307.



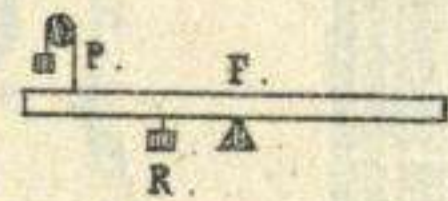
311.



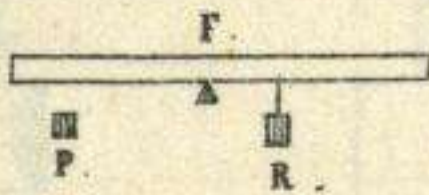
308.



310.



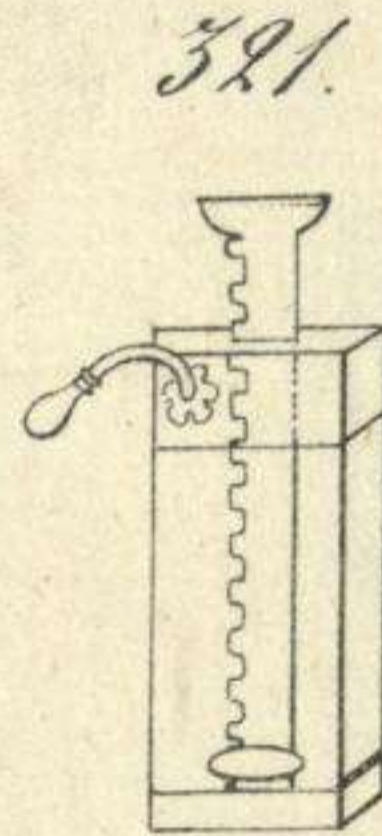
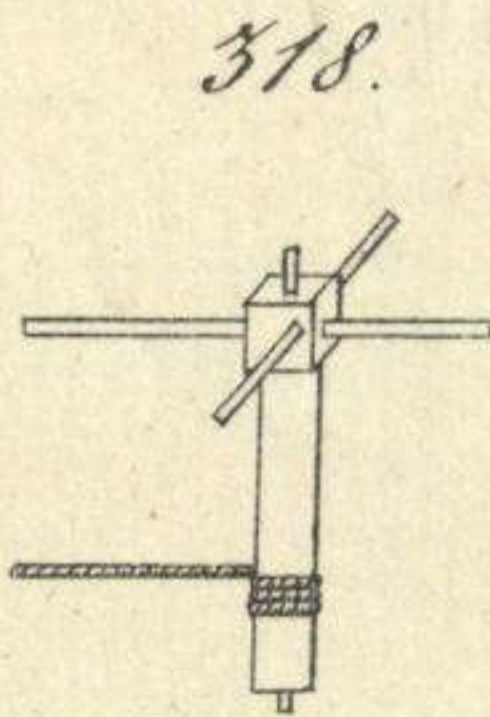
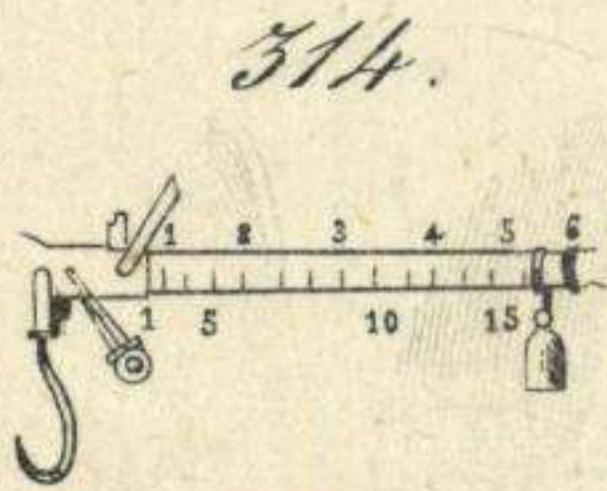
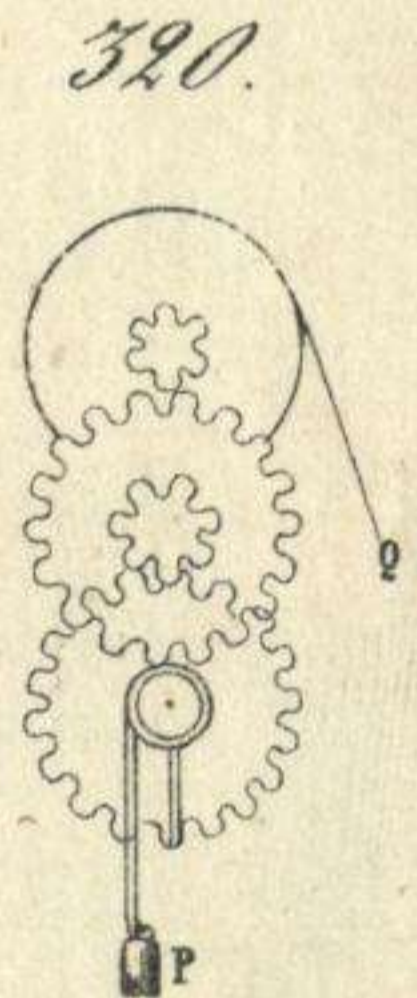
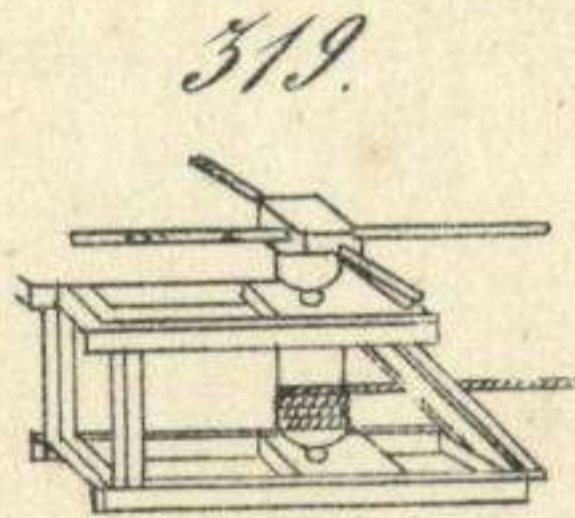
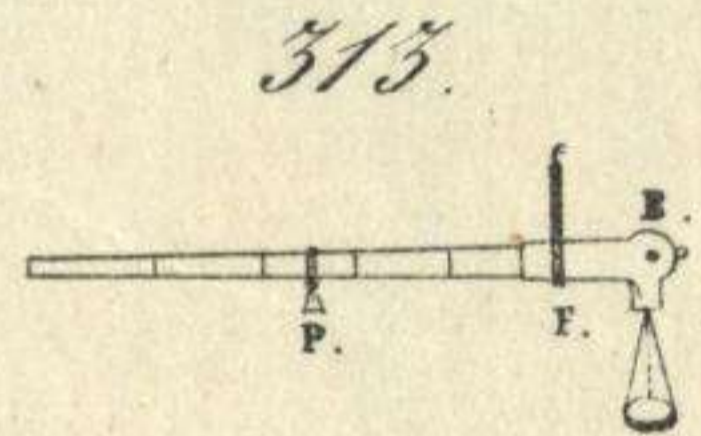
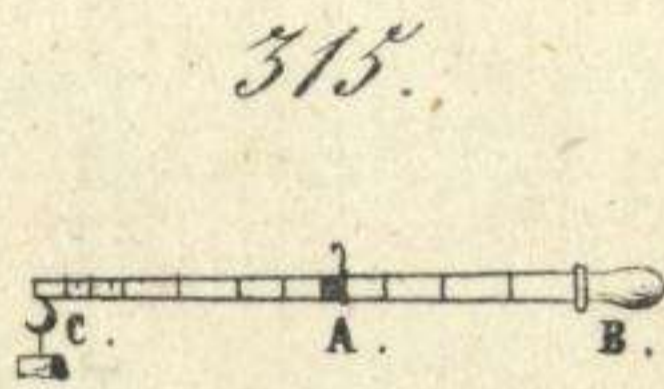
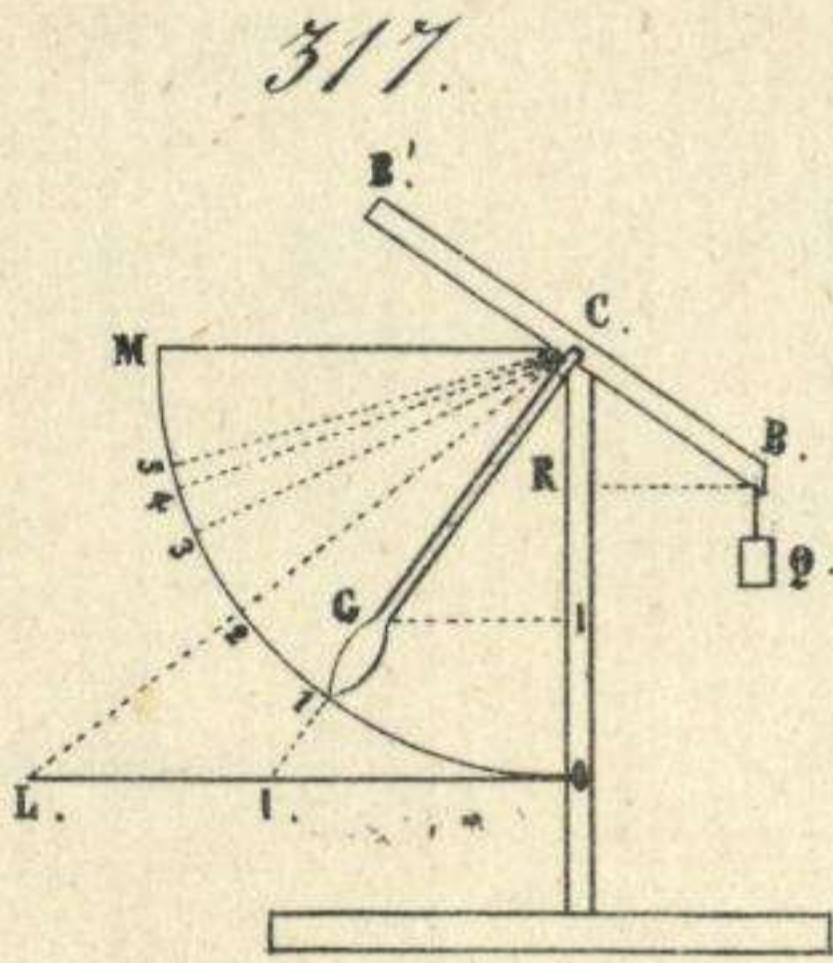
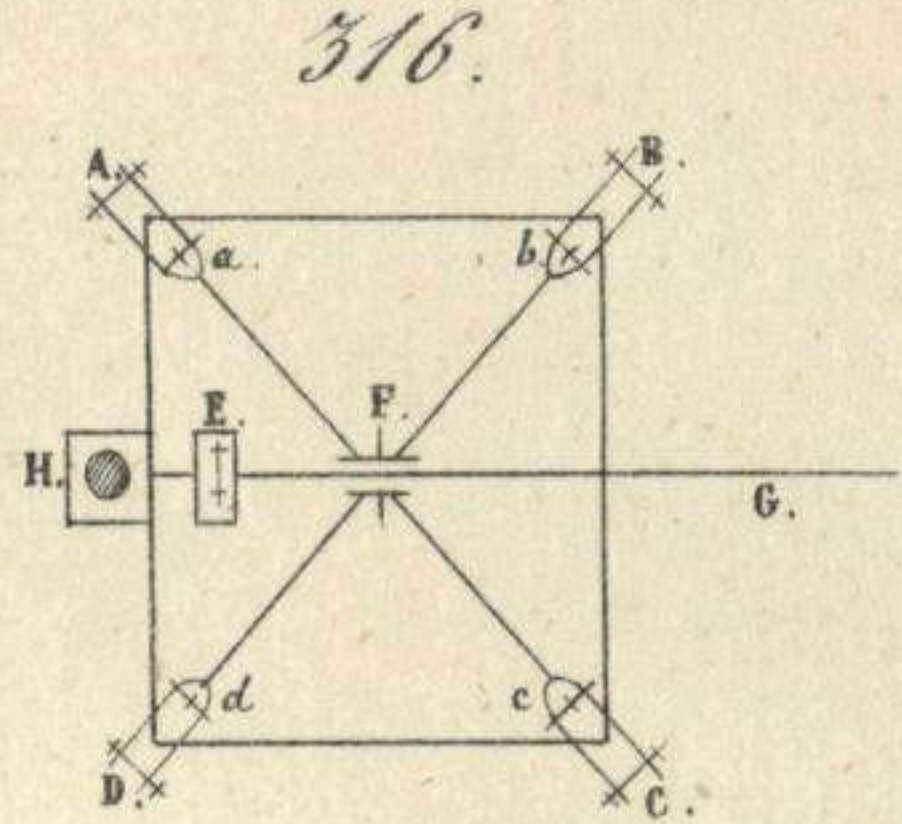
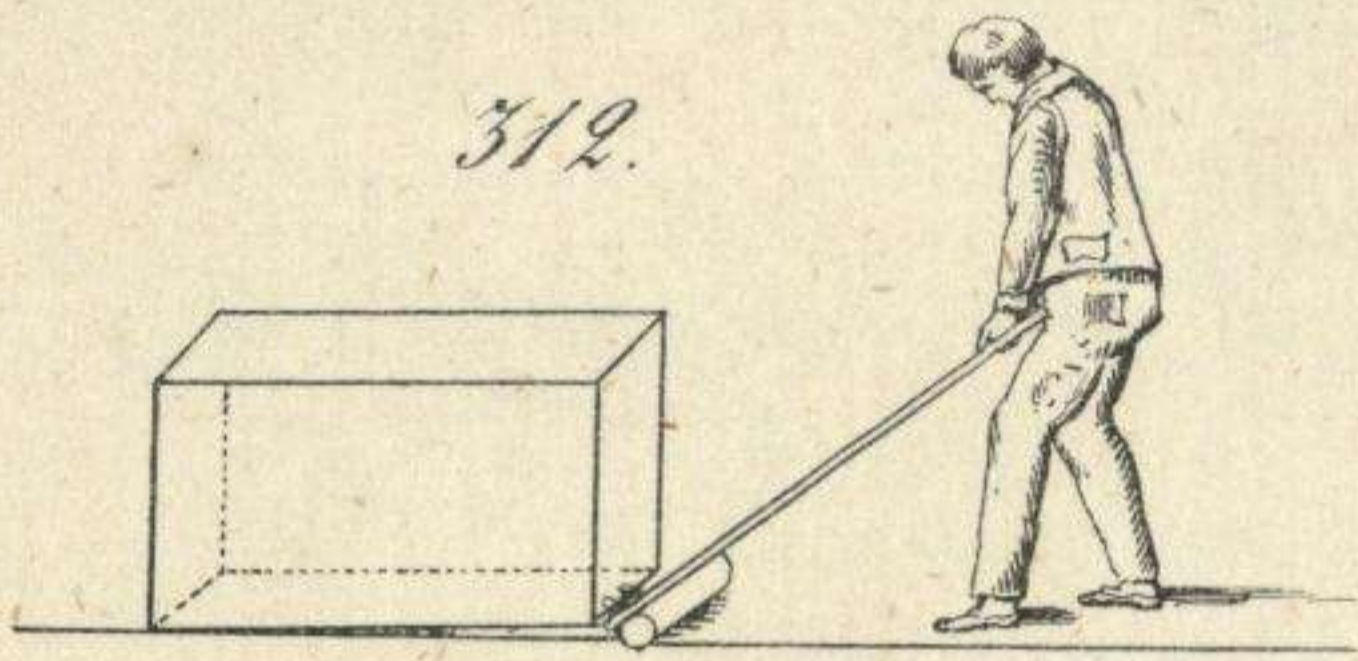
309.



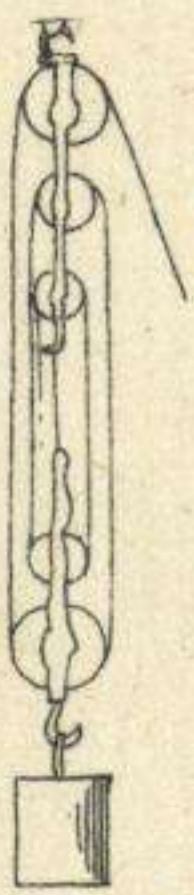




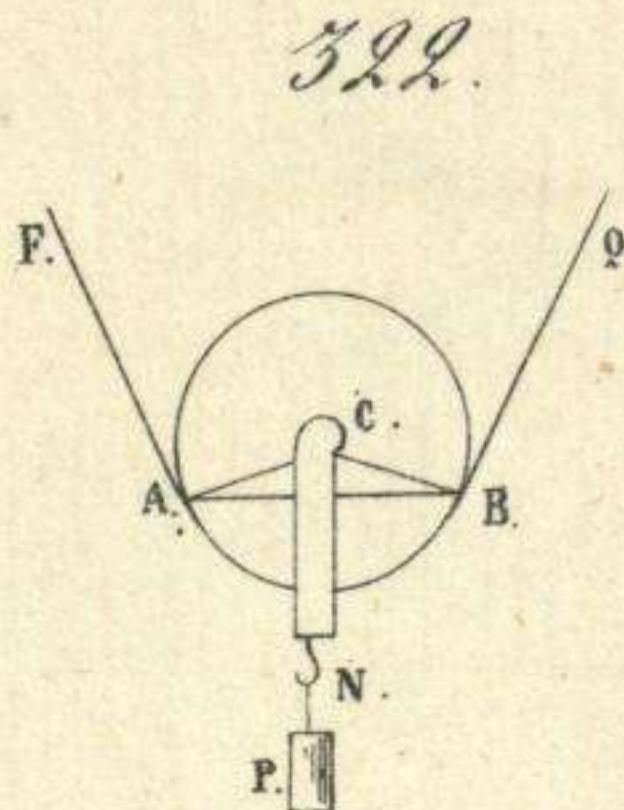
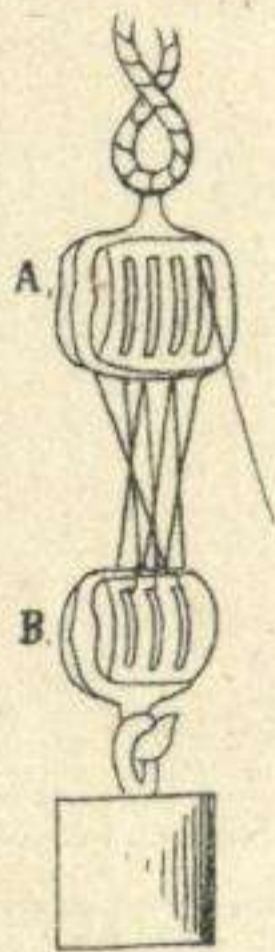




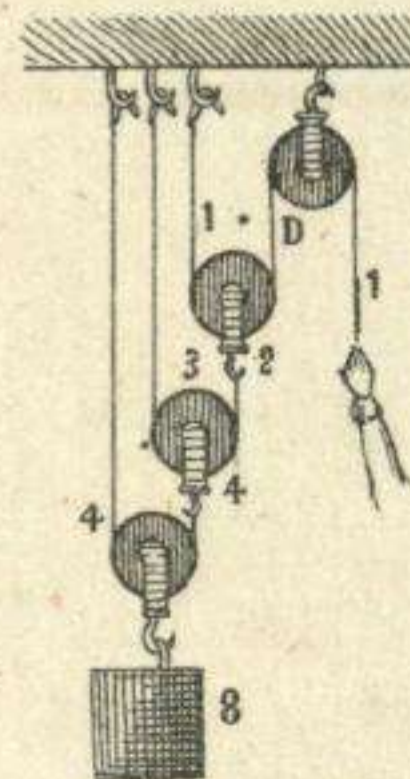
324.



325.



323.



326.





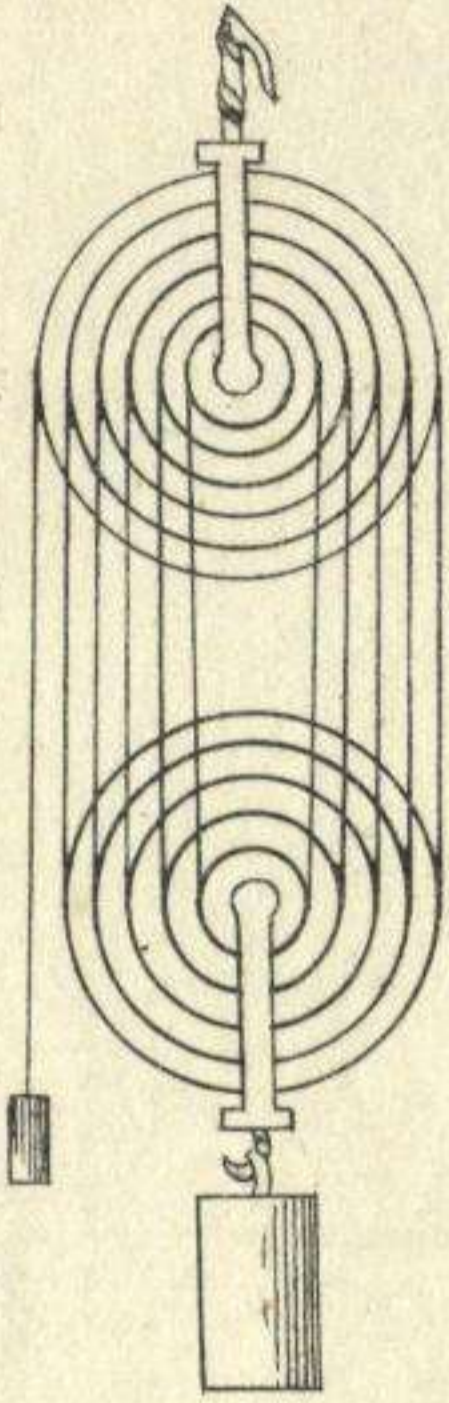




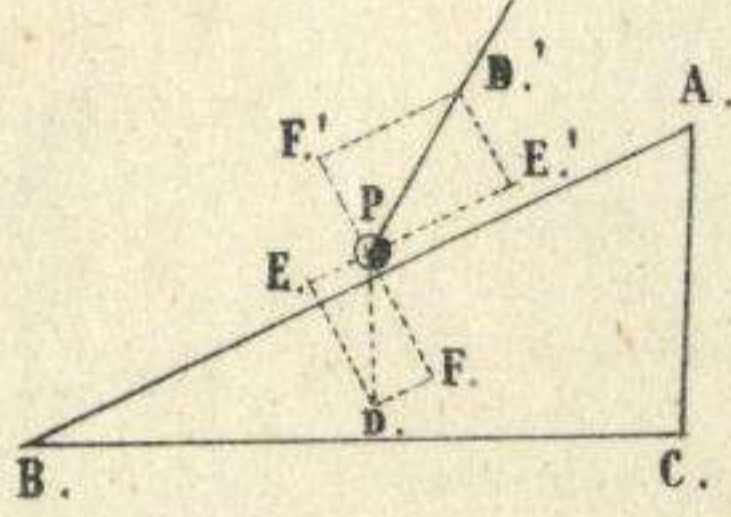




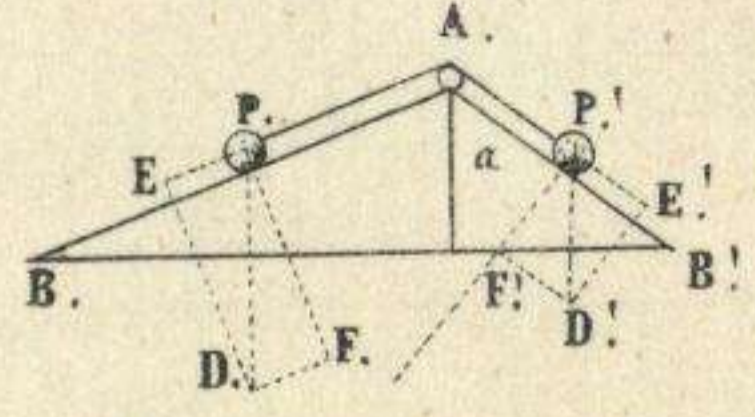
327.



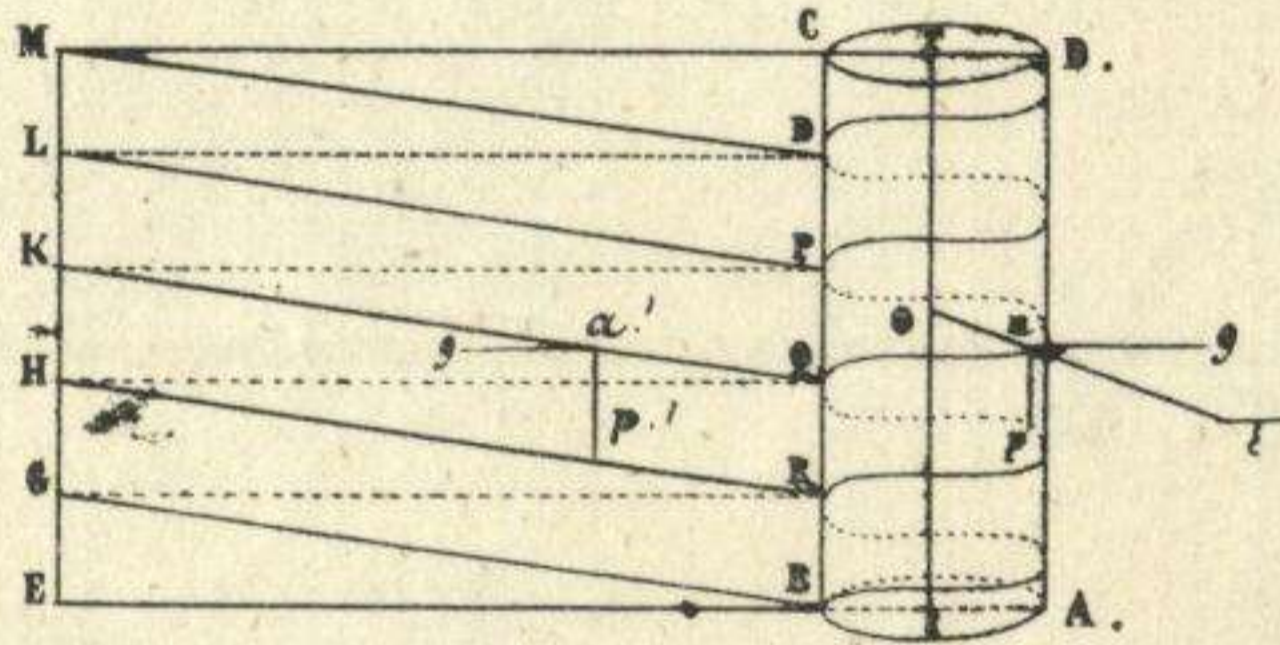
328.



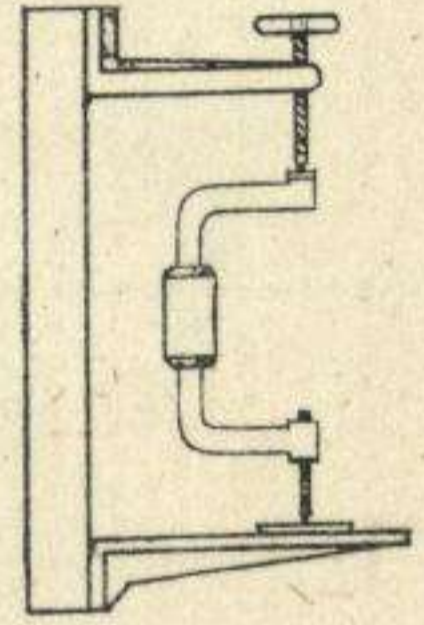
329.



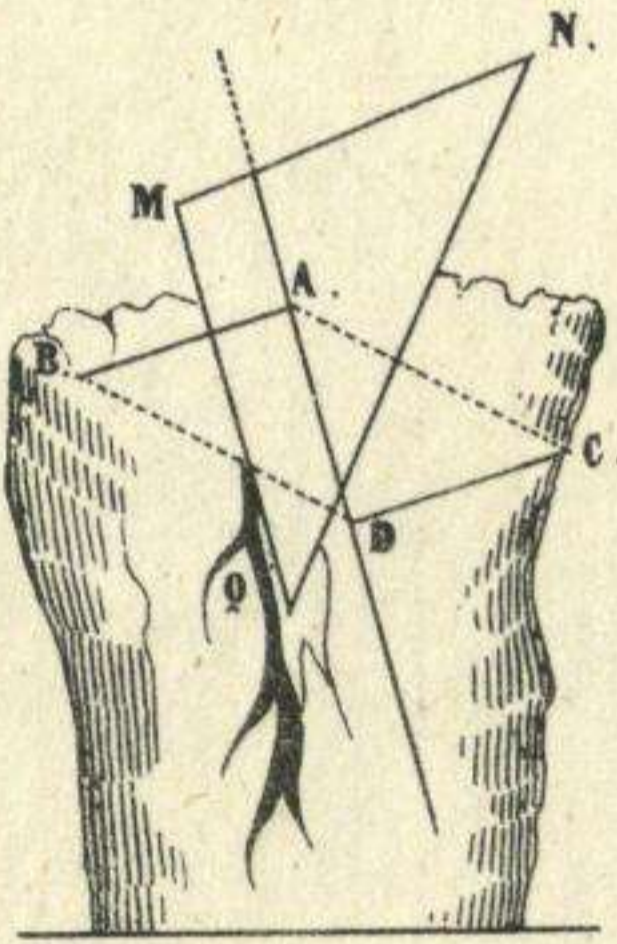
331.



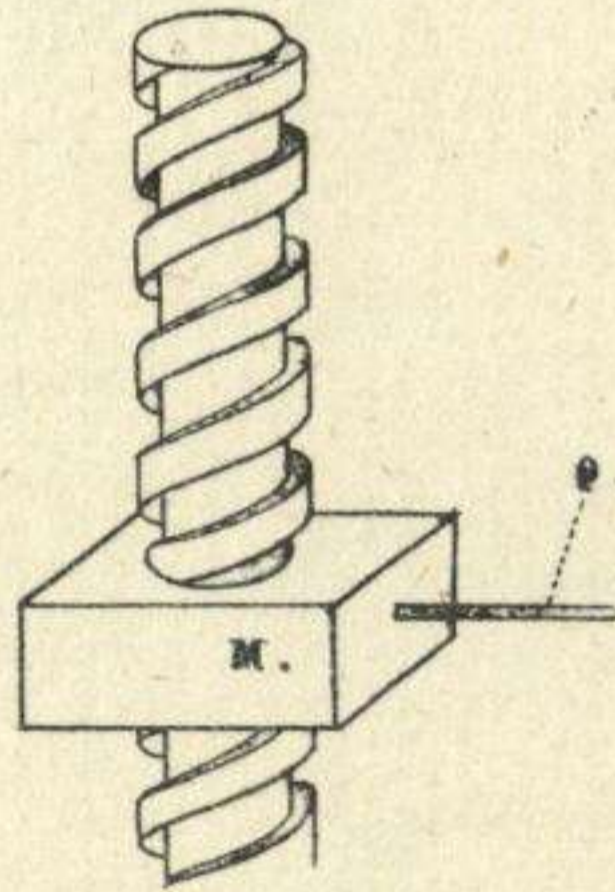
337.



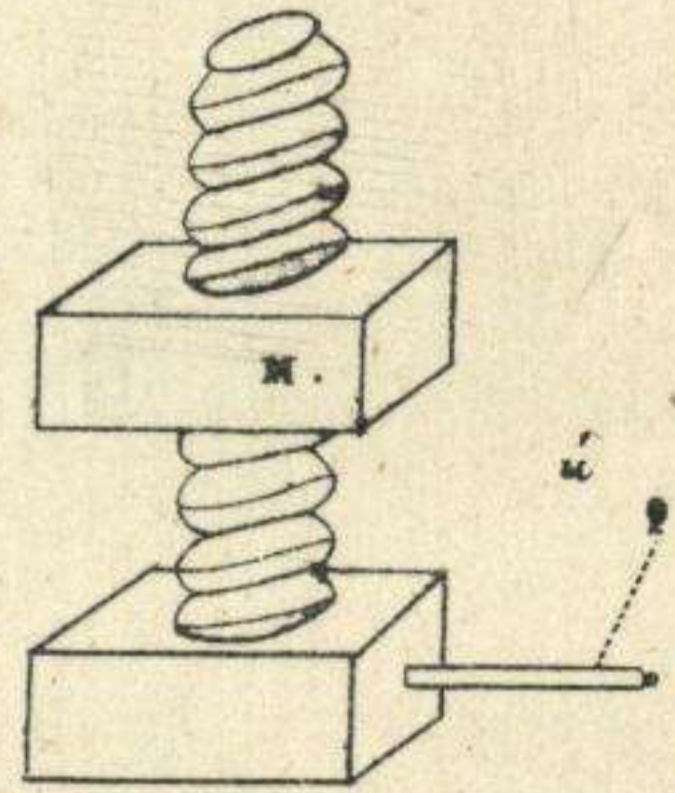
330.



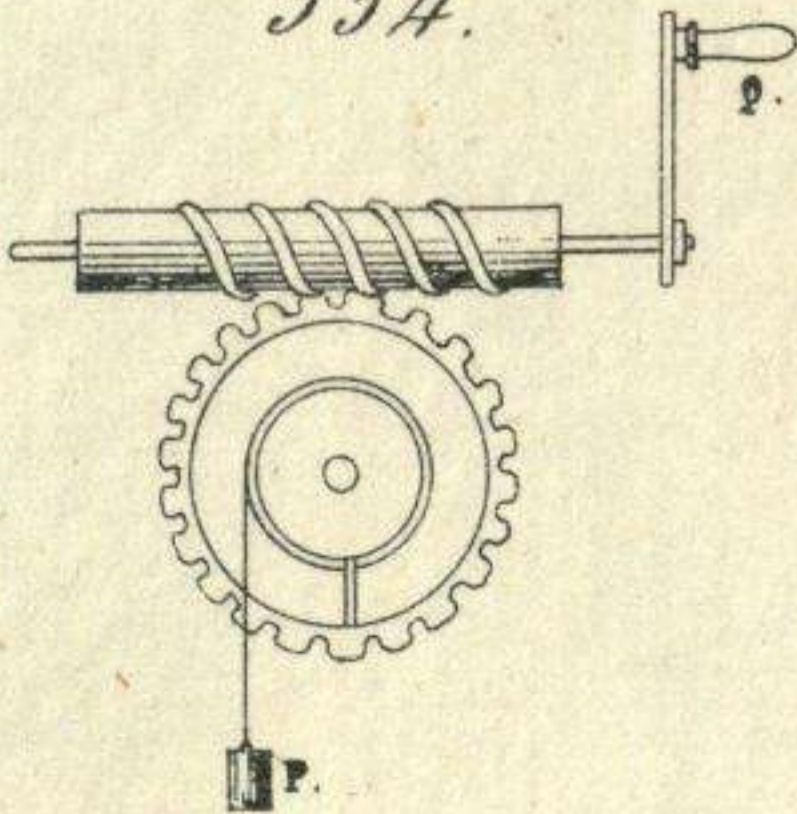
332.



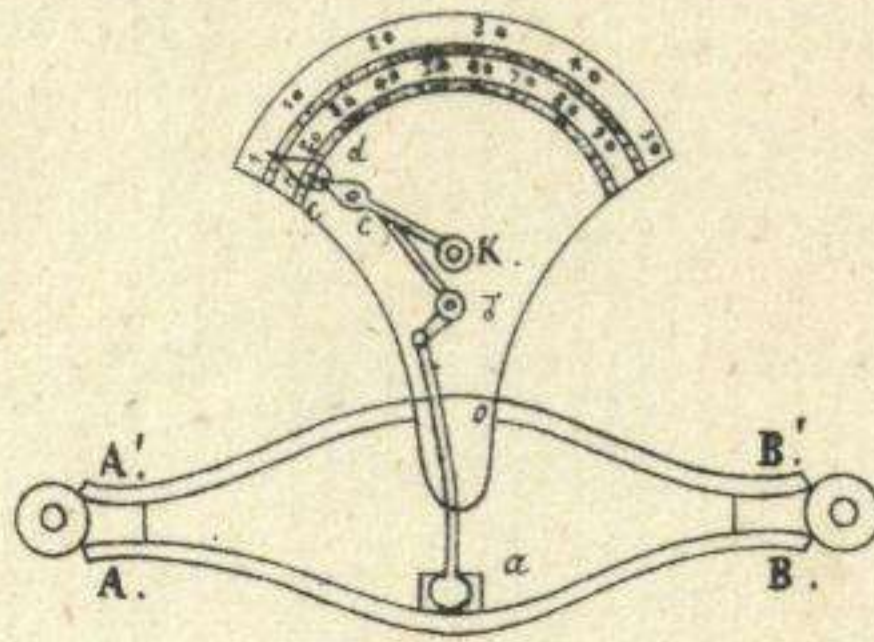
333.



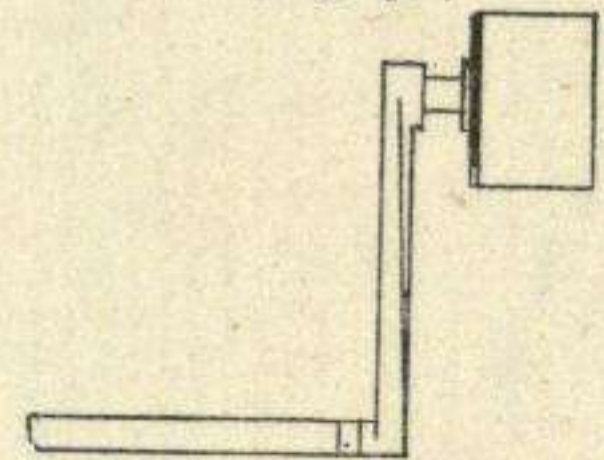
334.



335.



336.



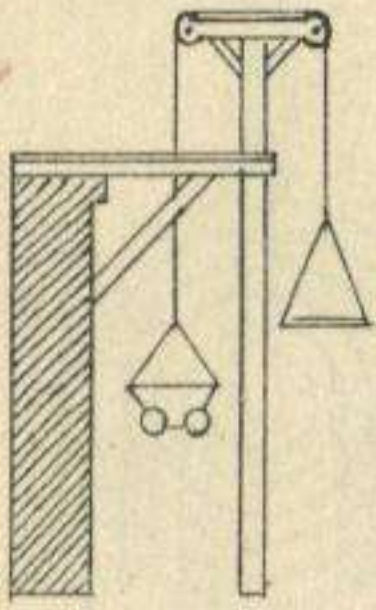




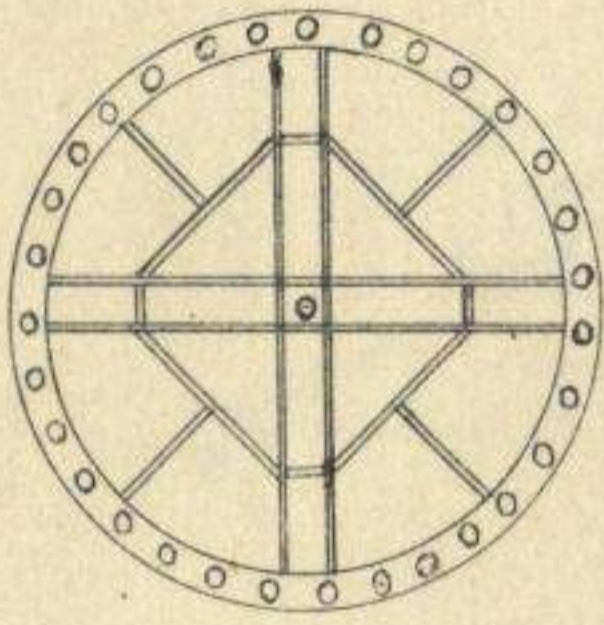


# Diccionario de Agricultura.

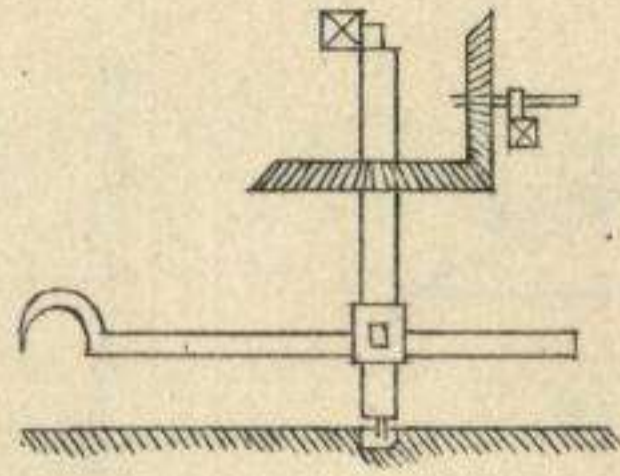
338.



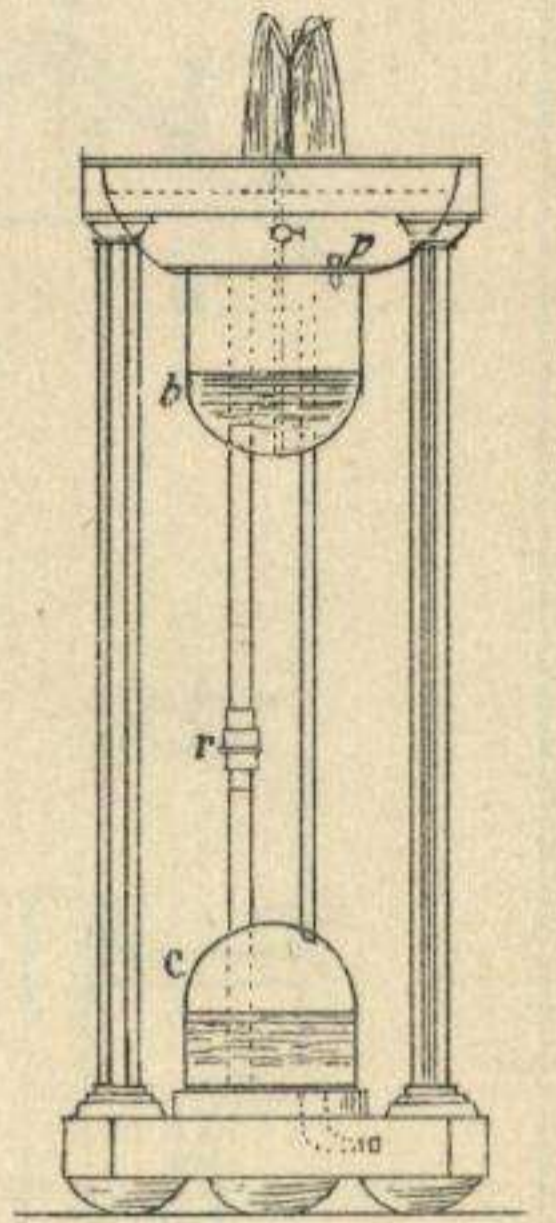
339.



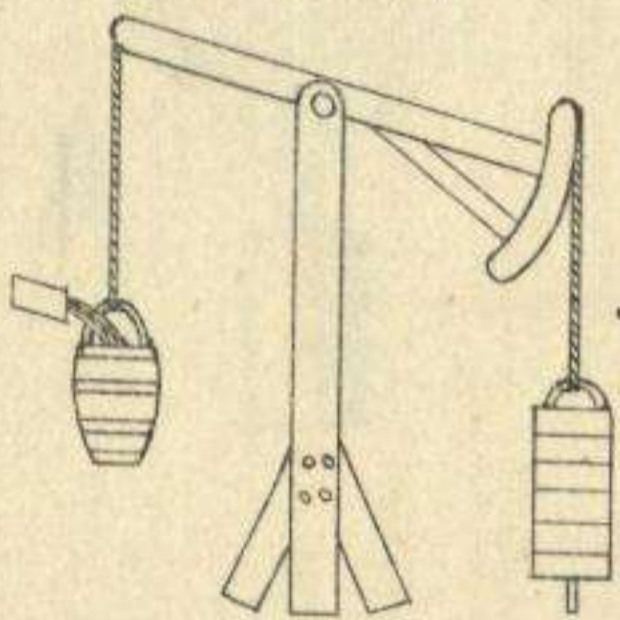
340.



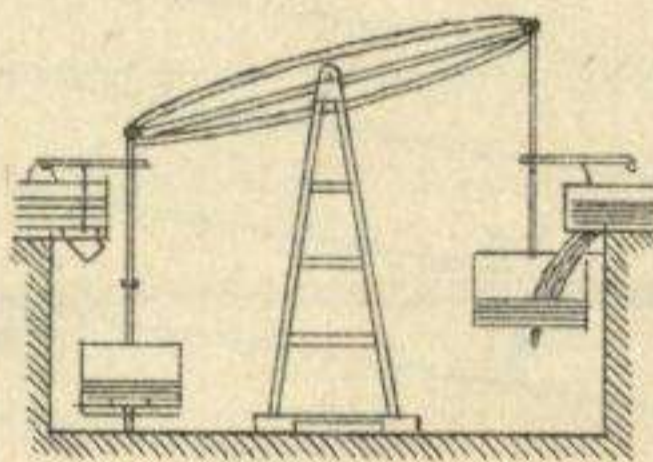
341.



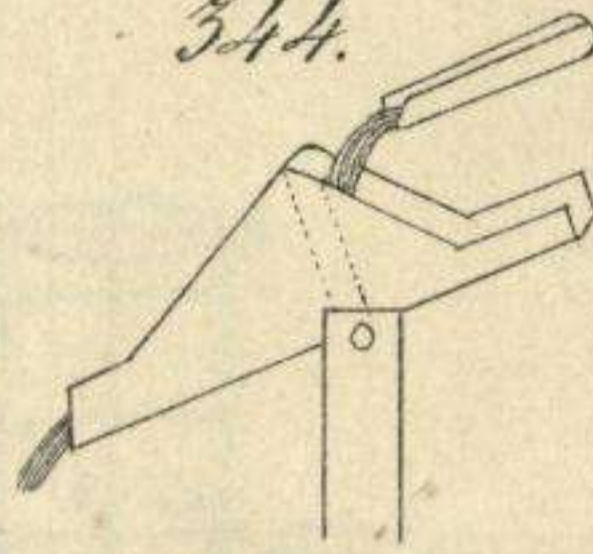
342.



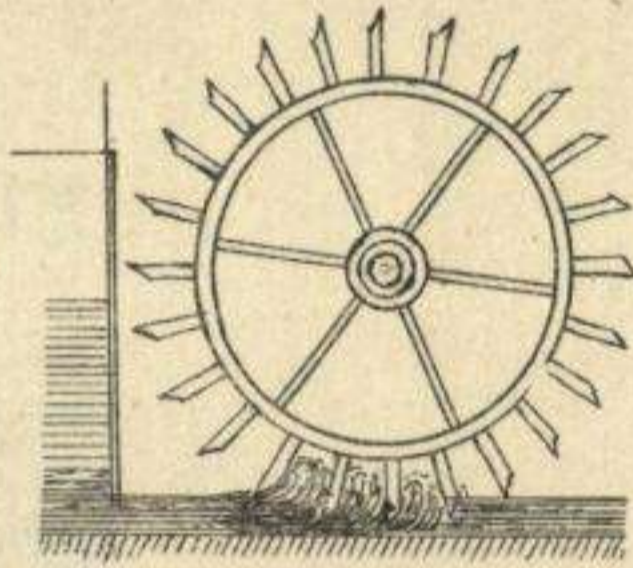
343.



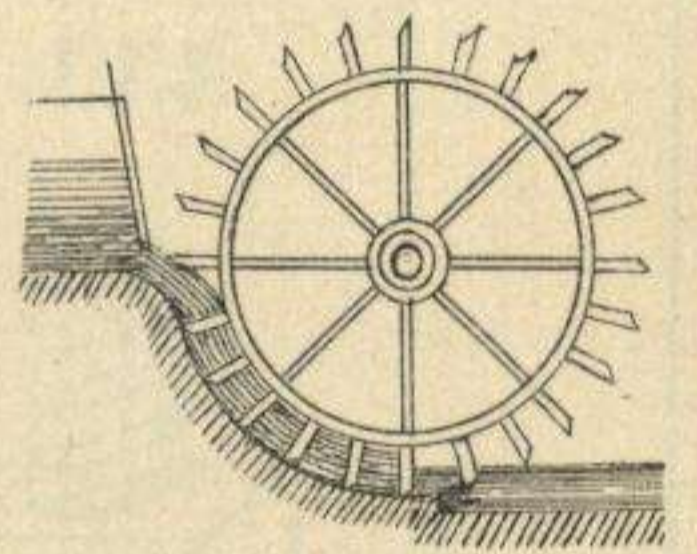
344.



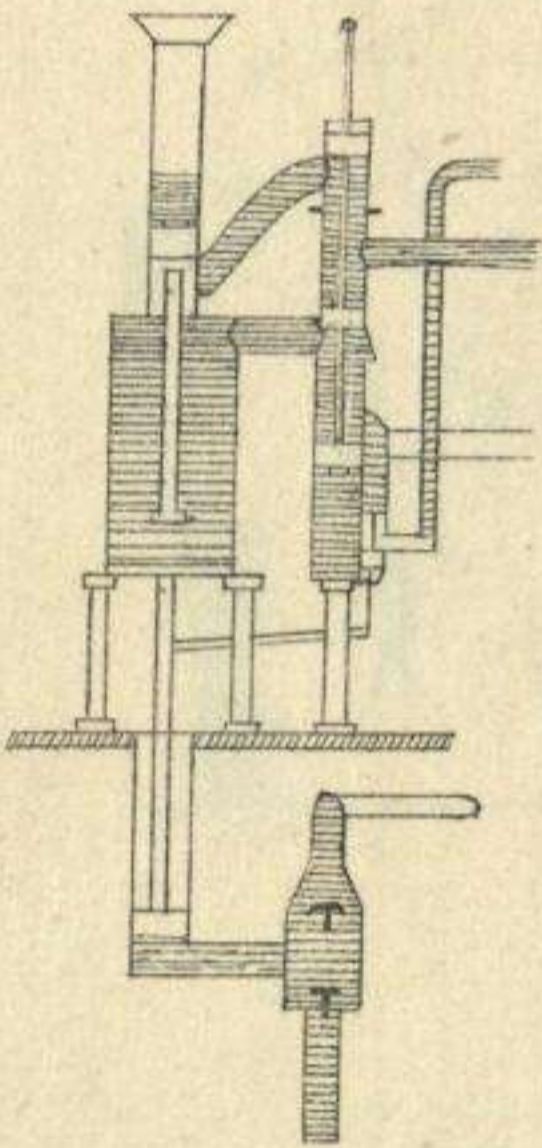
347.



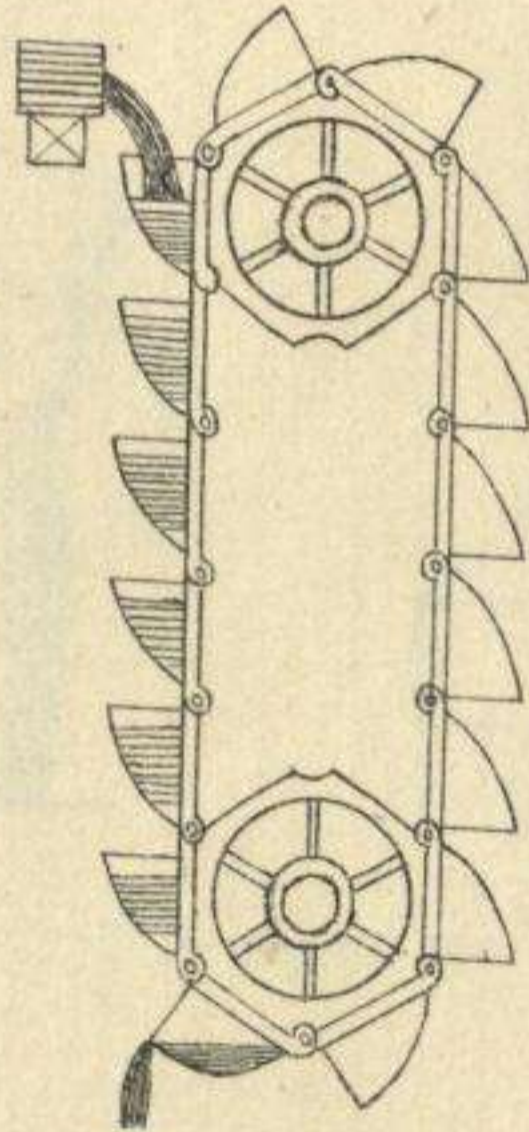
348.



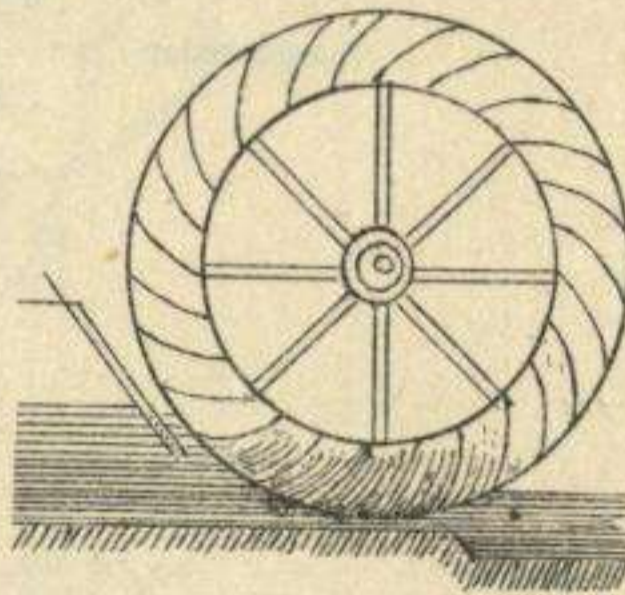
345.



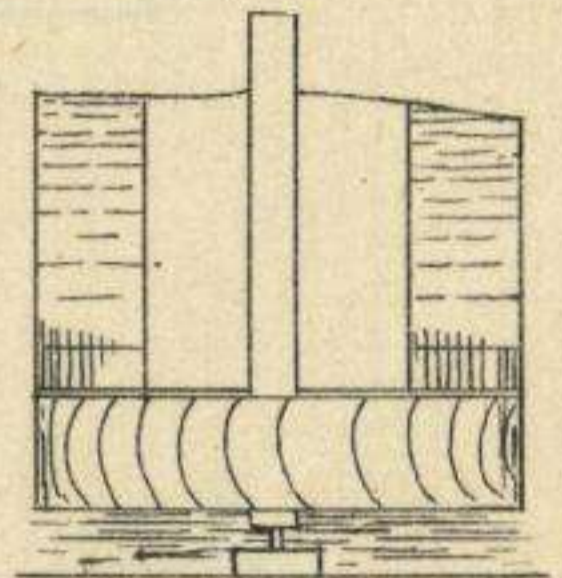
346.



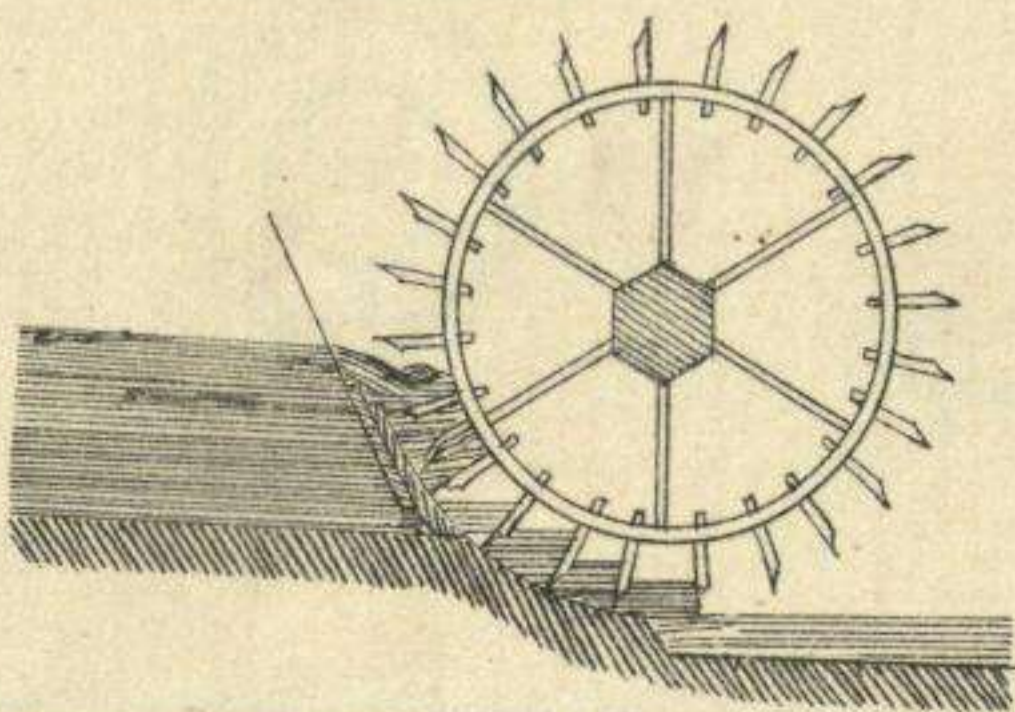
350.



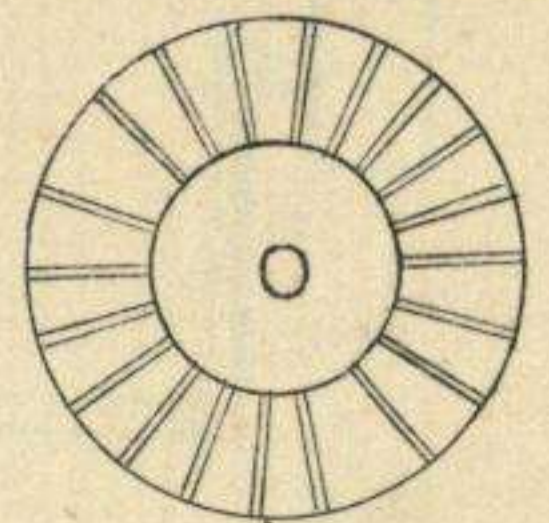
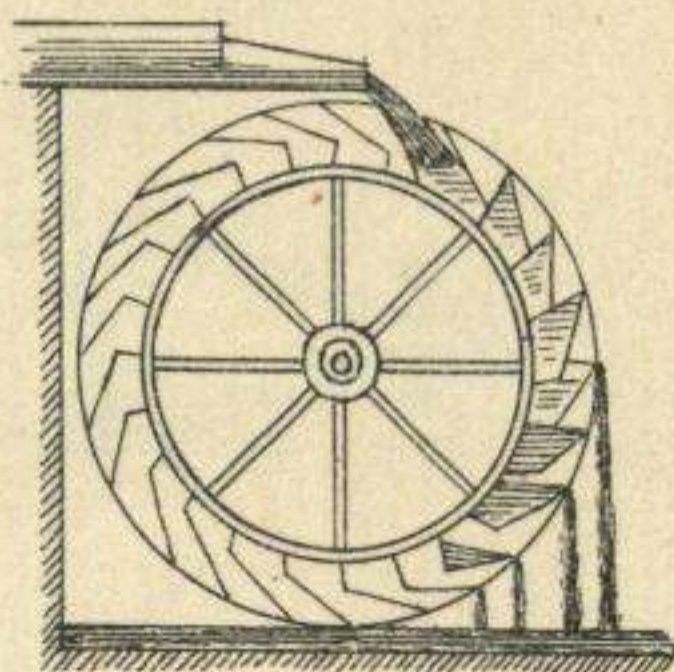
352.



349.



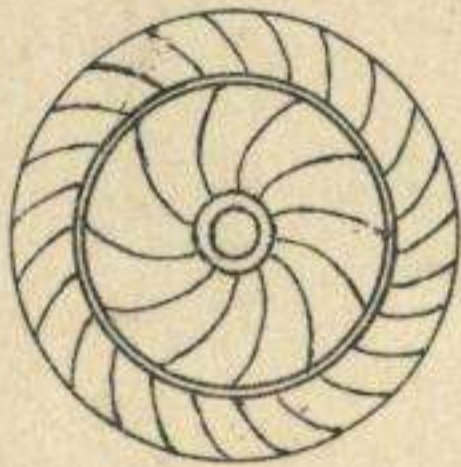
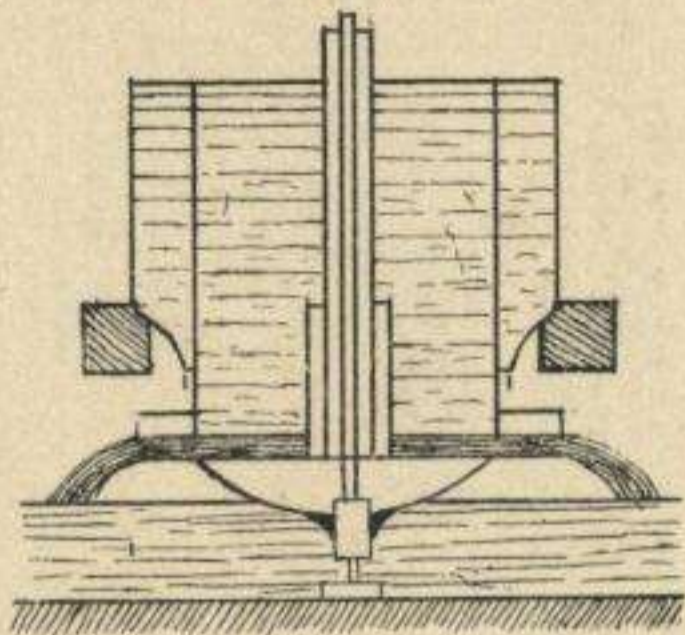
351.



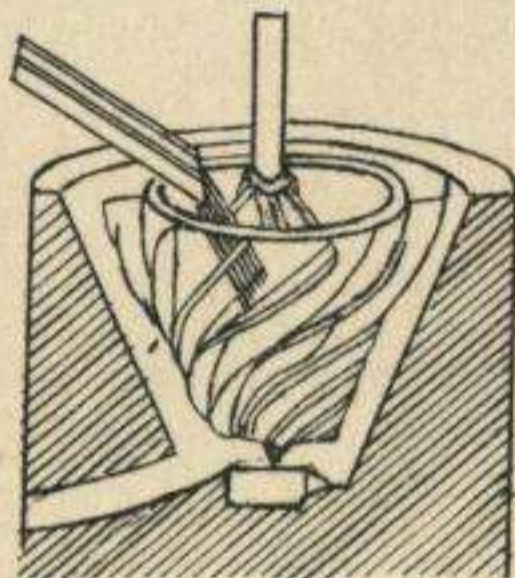


# Diccionario de Agricultura.

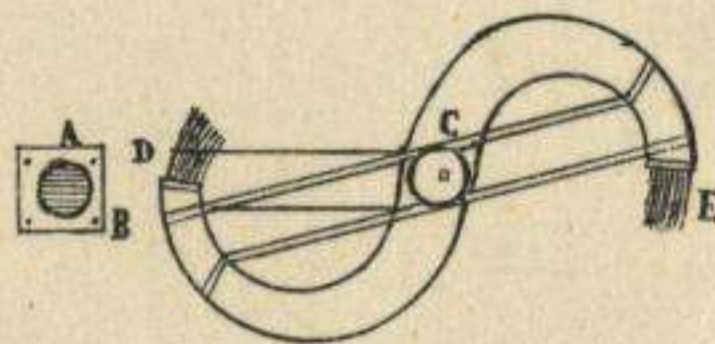
353.



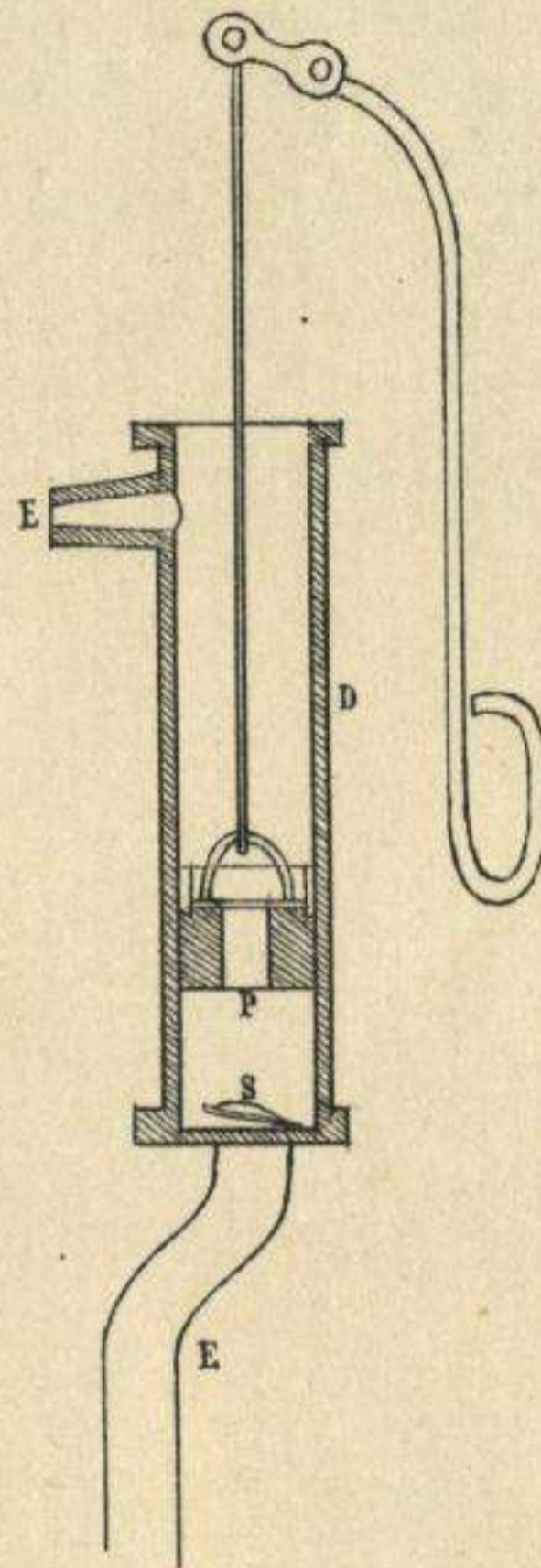
354.



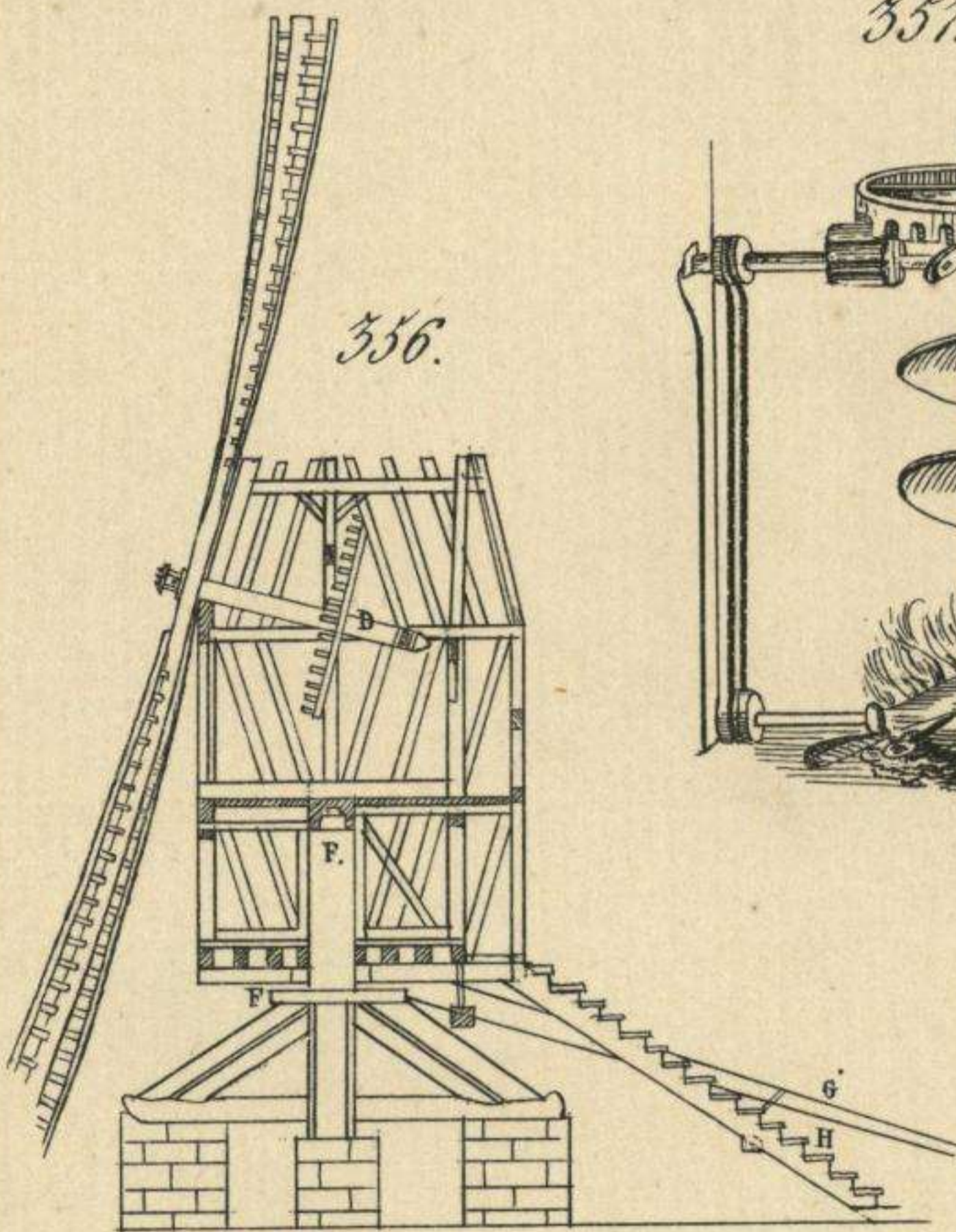
355.



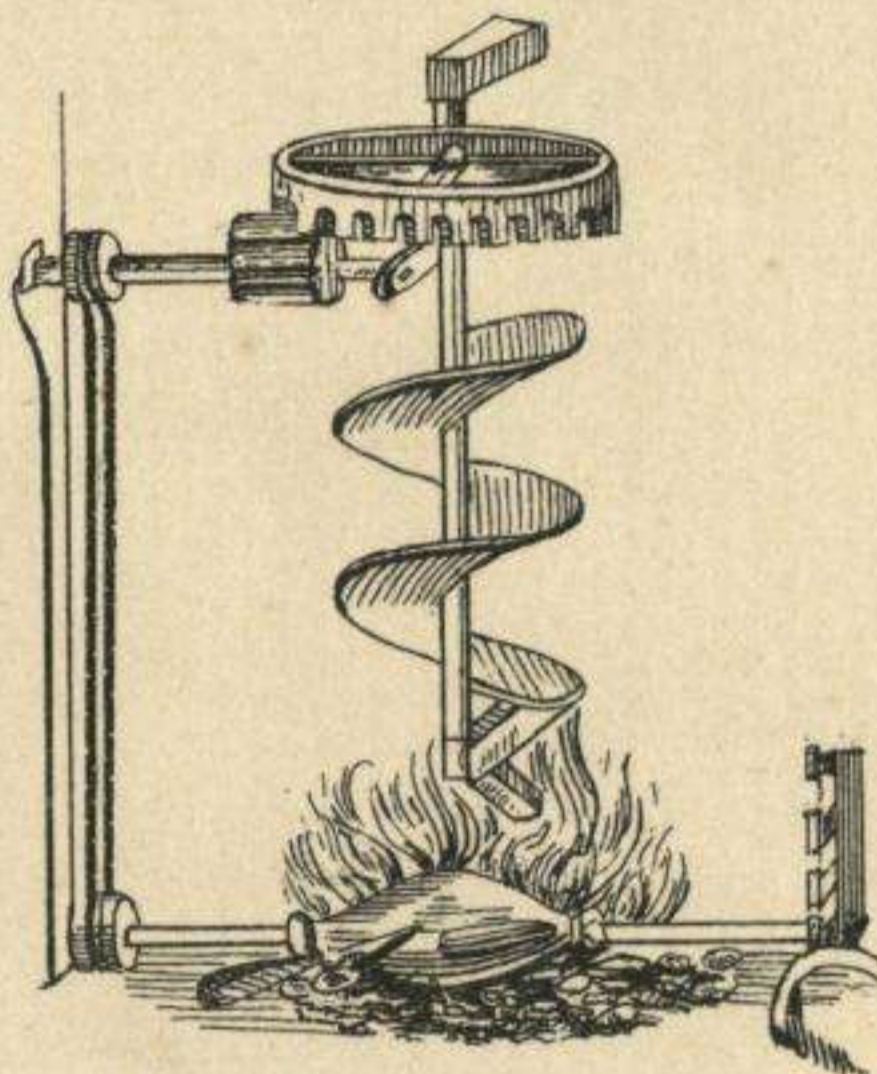
360.



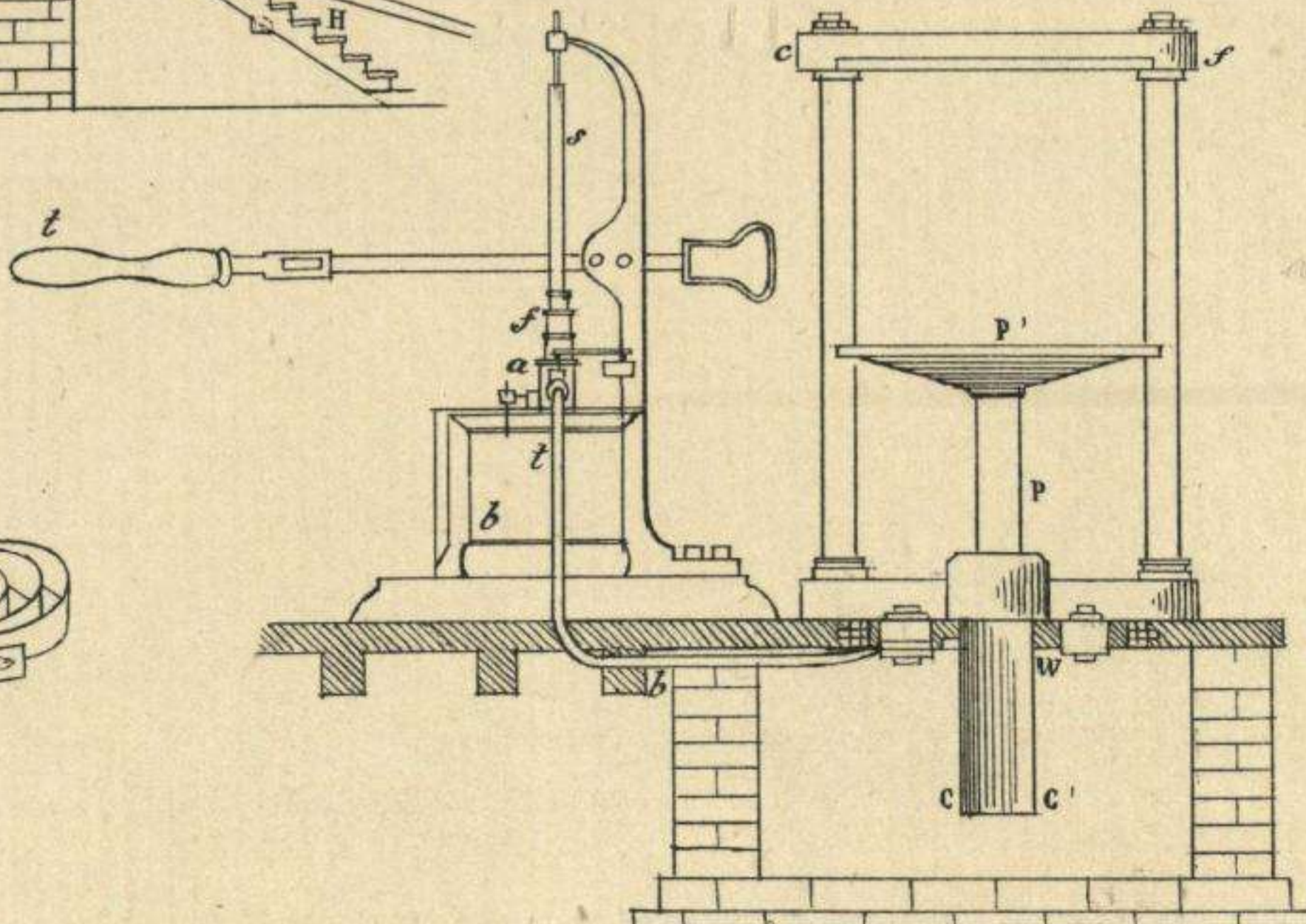
356.



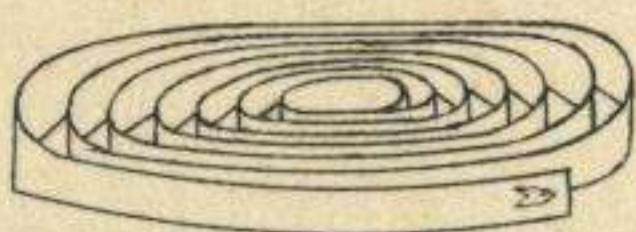
357.



359.



358.



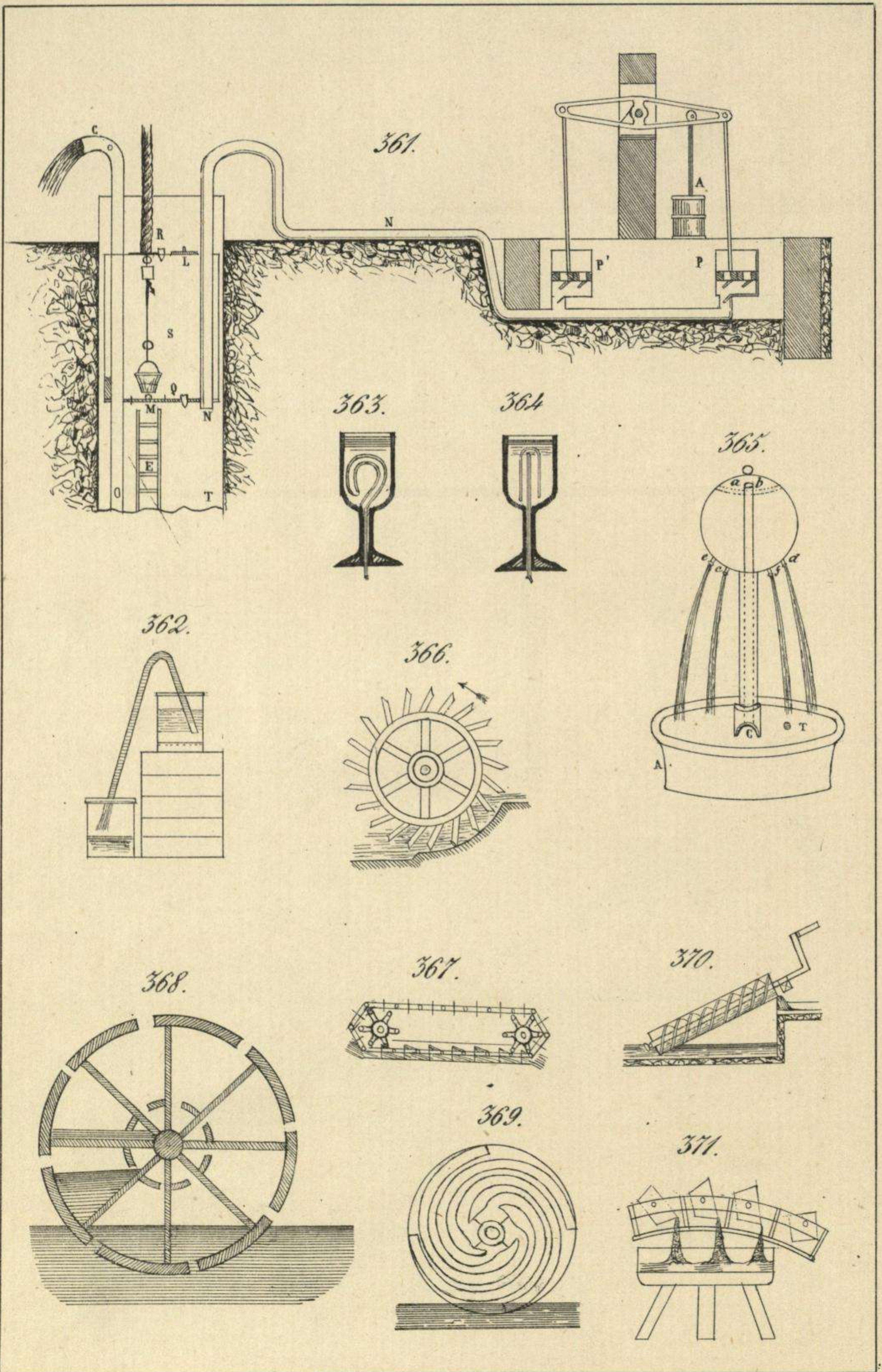








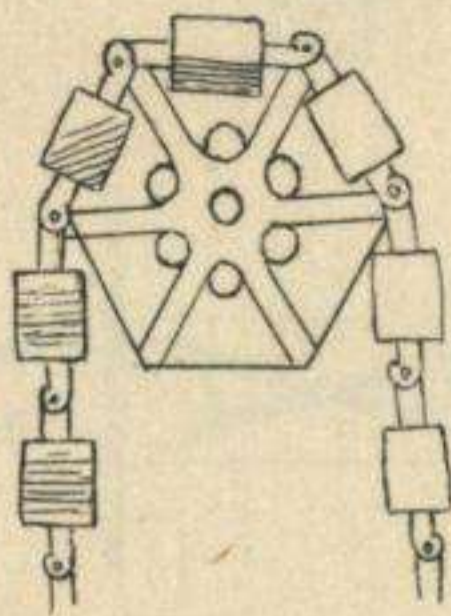




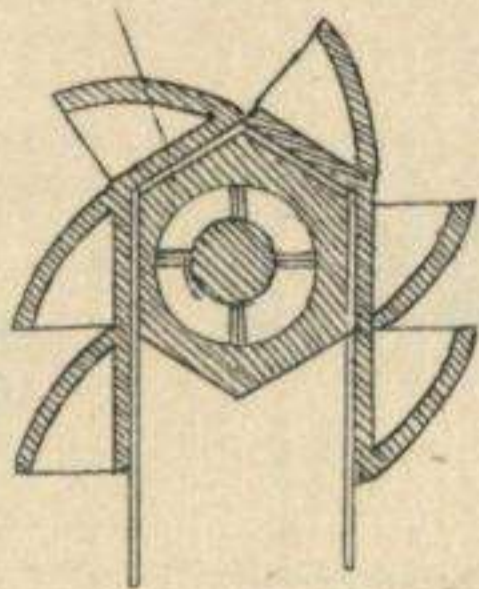


# Diccionario de Agricultura.

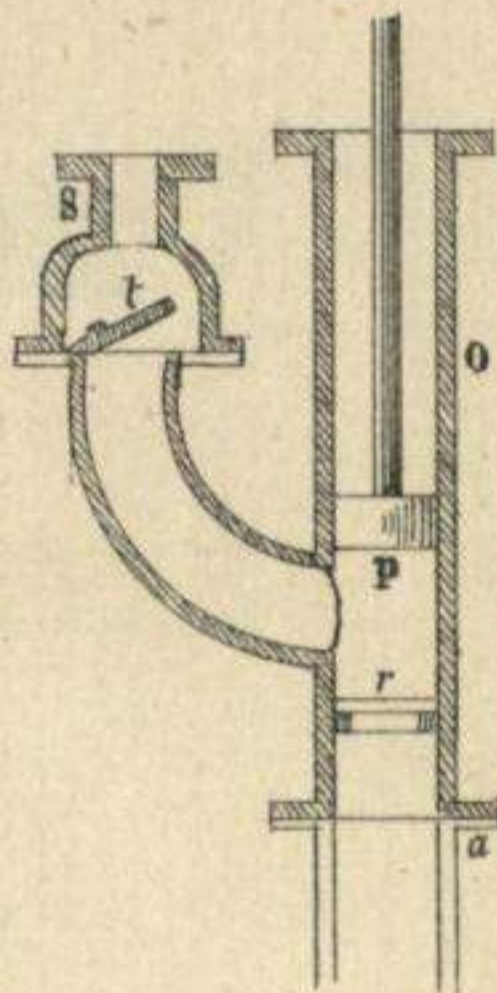
372.



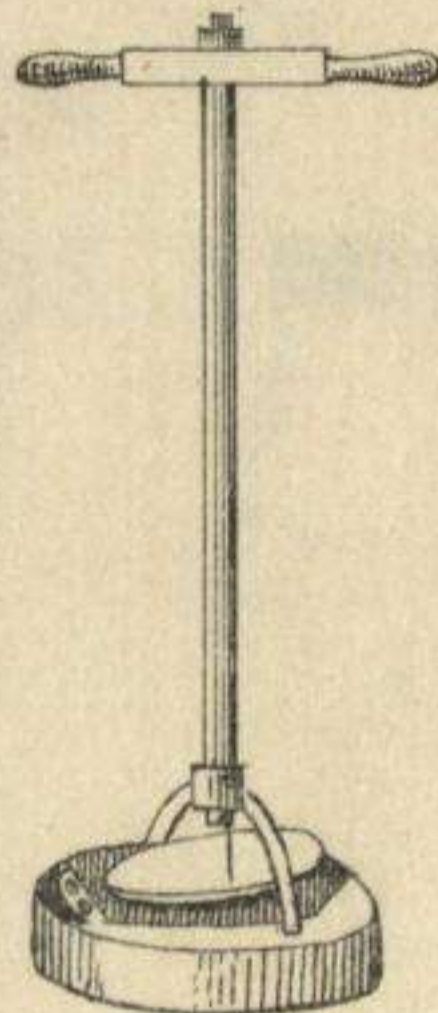
373.



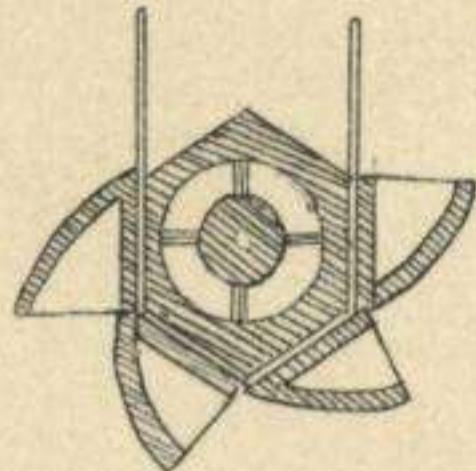
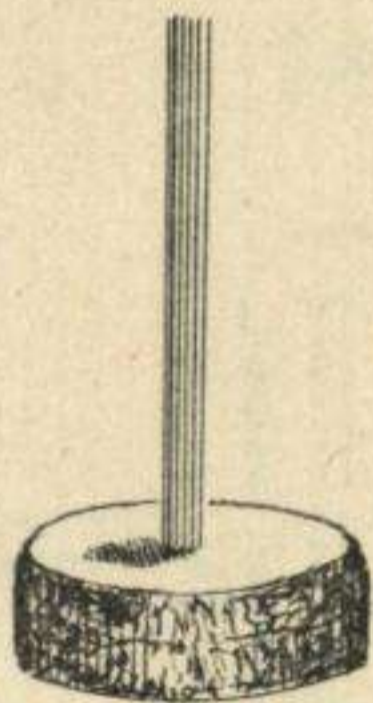
374.



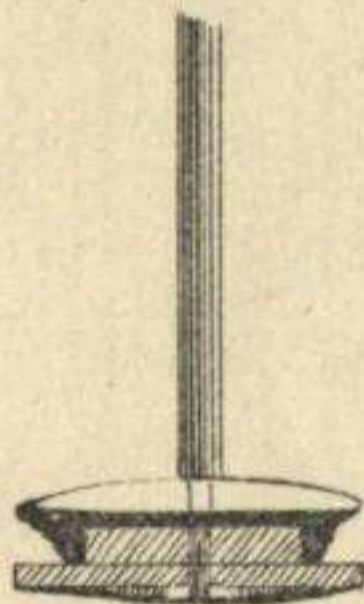
377.



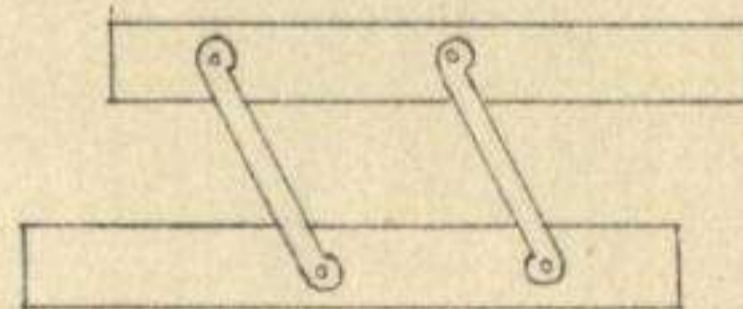
375.



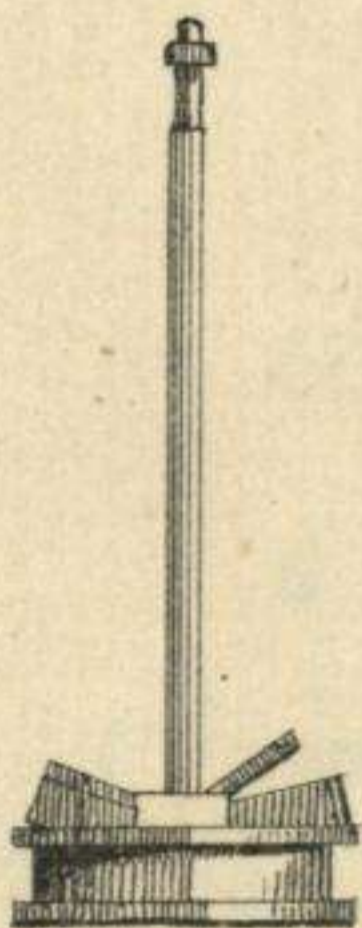
376.



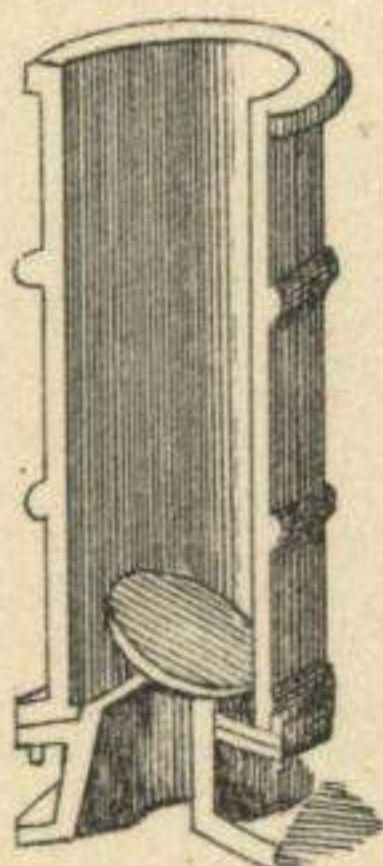
384.



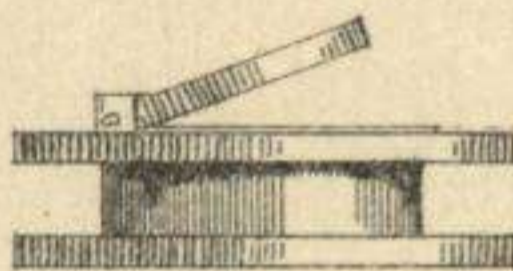
378.



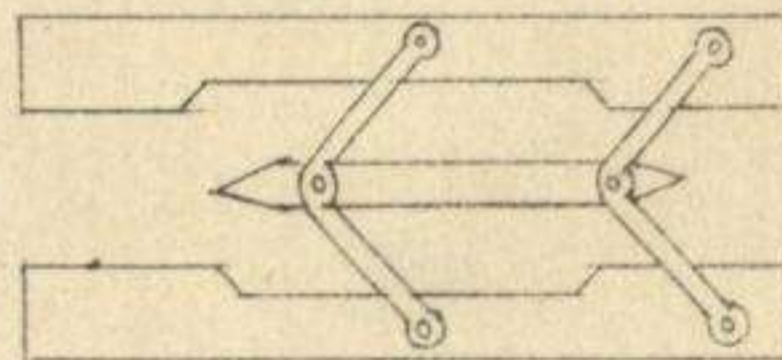
379.



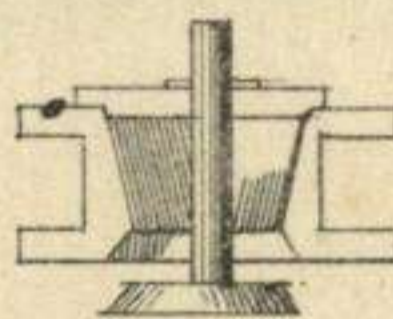
380.



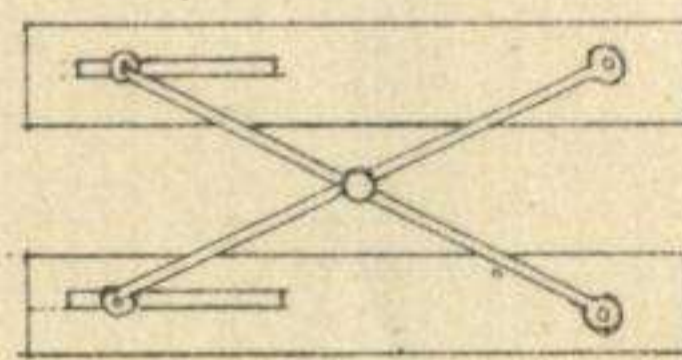
385.



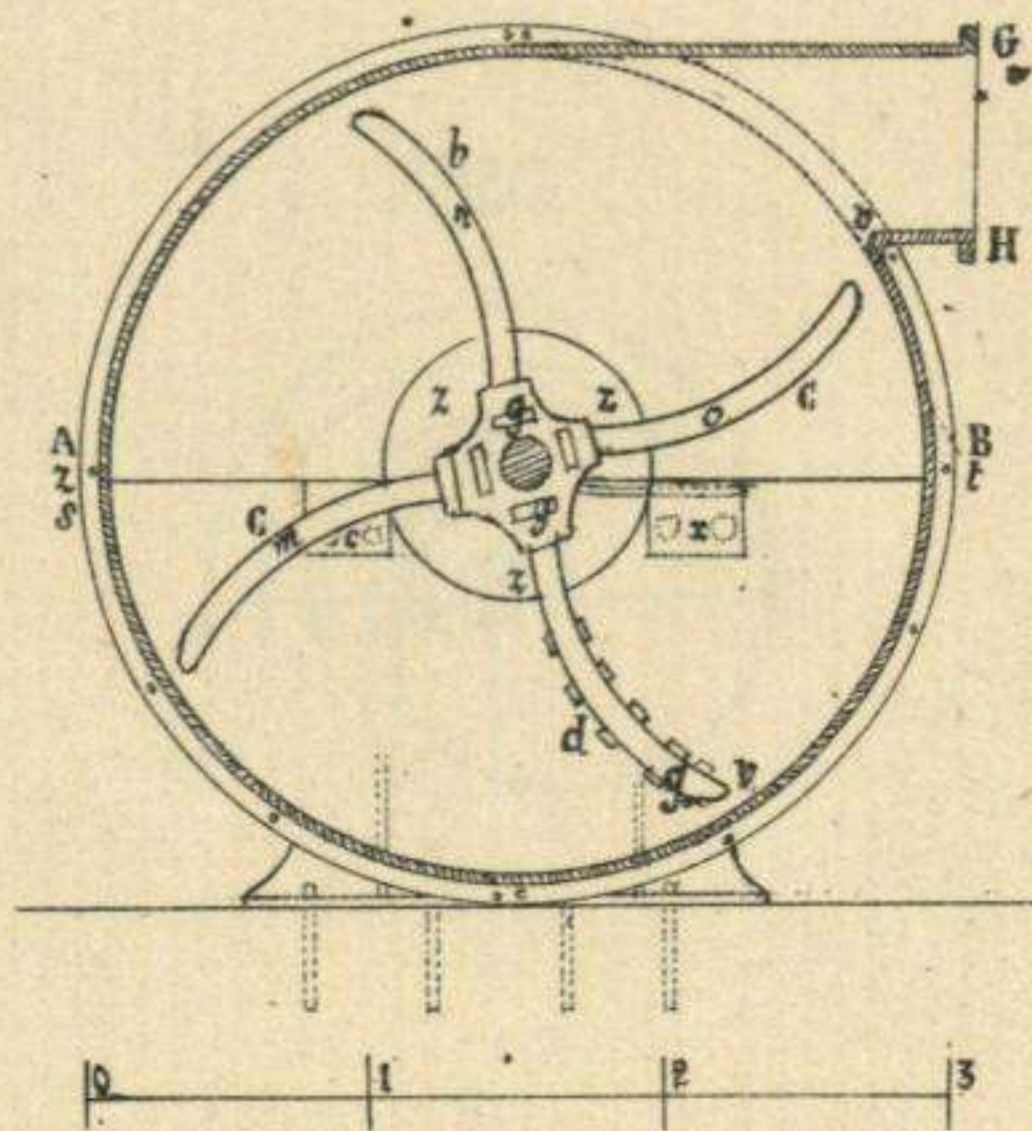
381.



386.



383.



382.

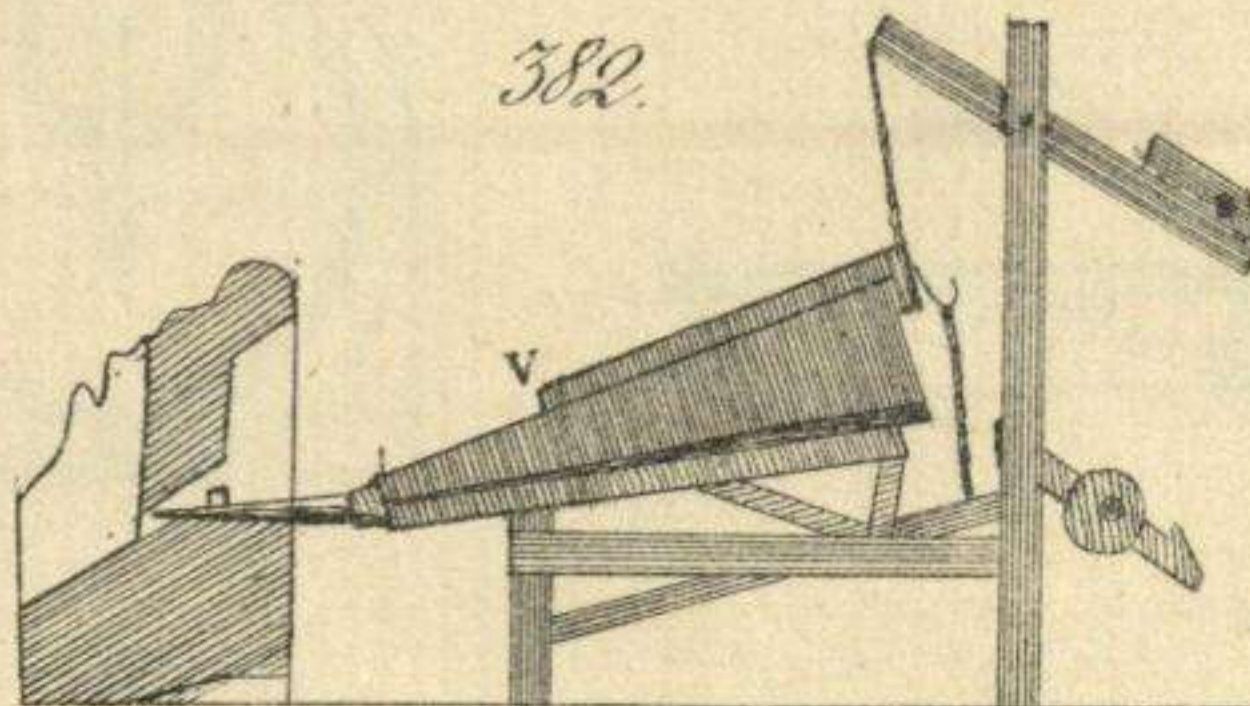
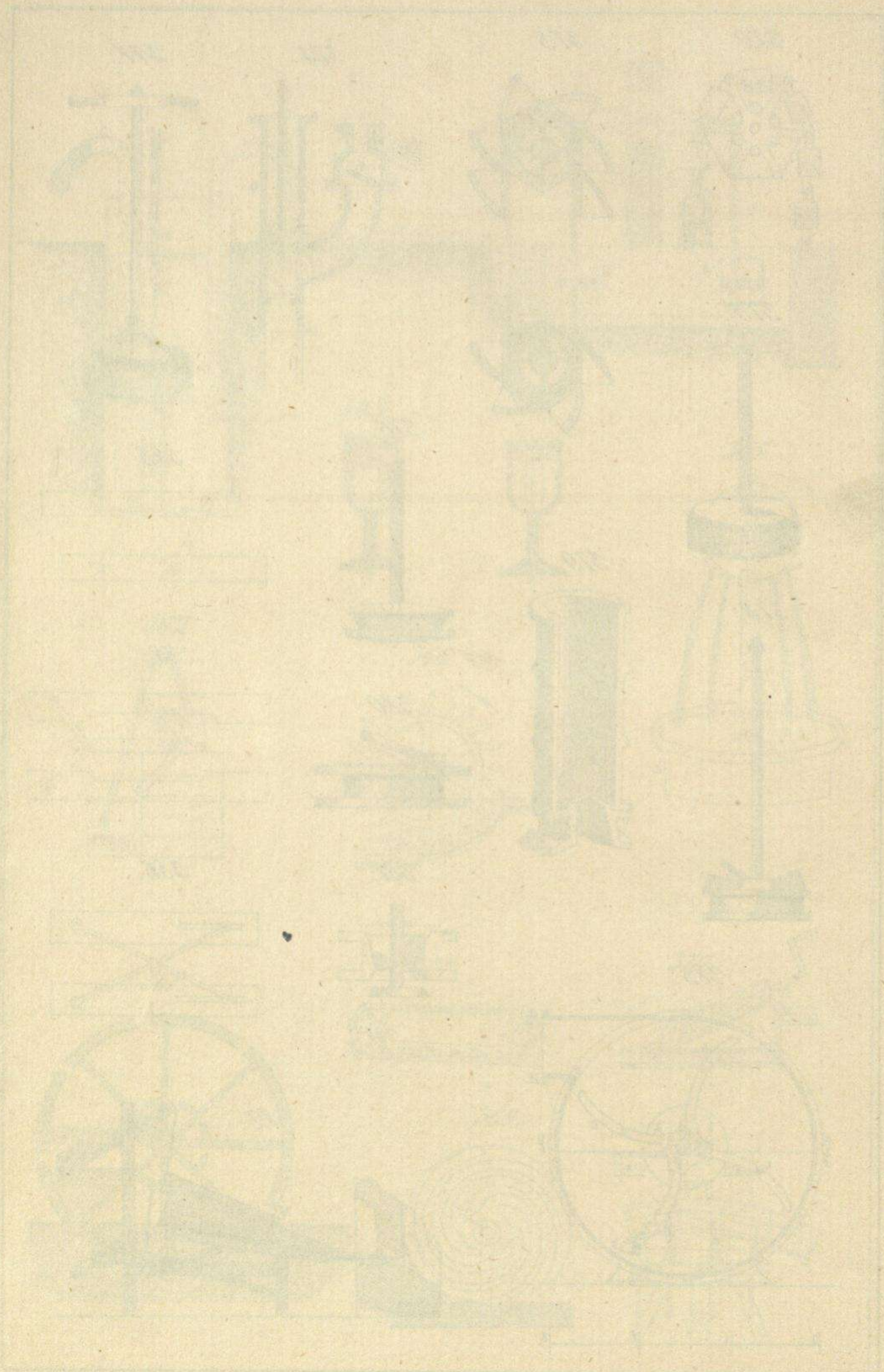




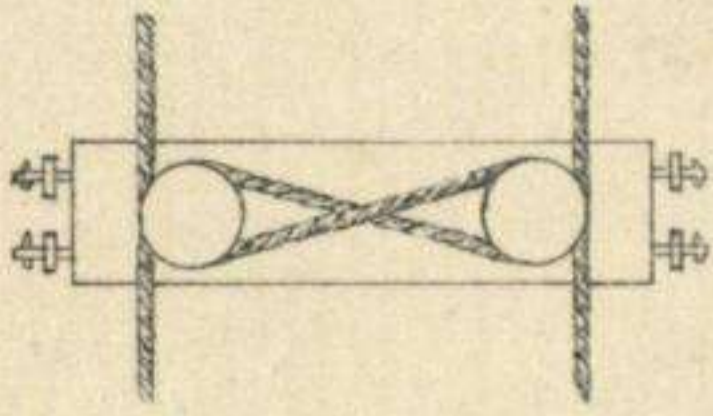
Diagram of the human body



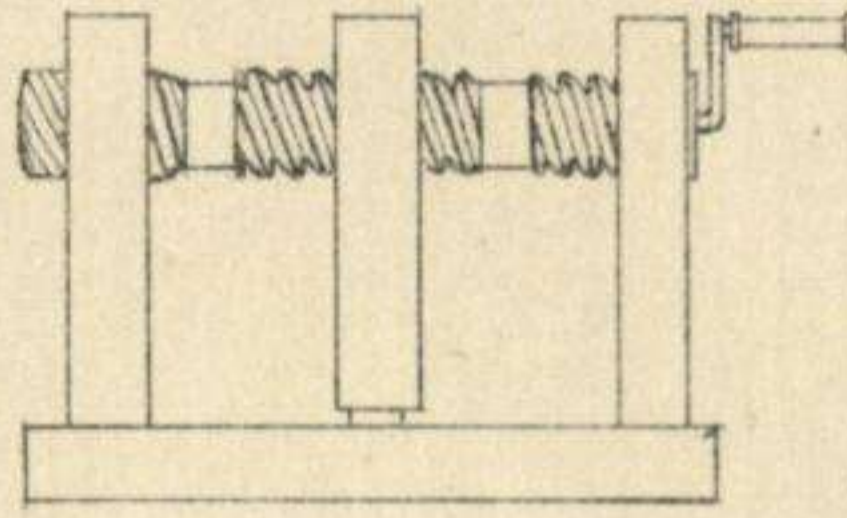


Diccionario de Agricultura.

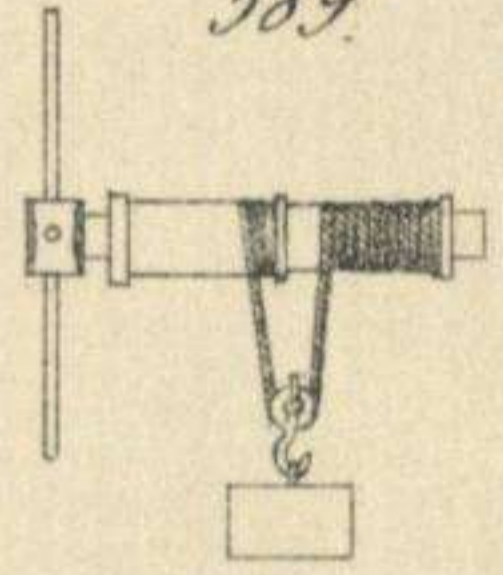
387.



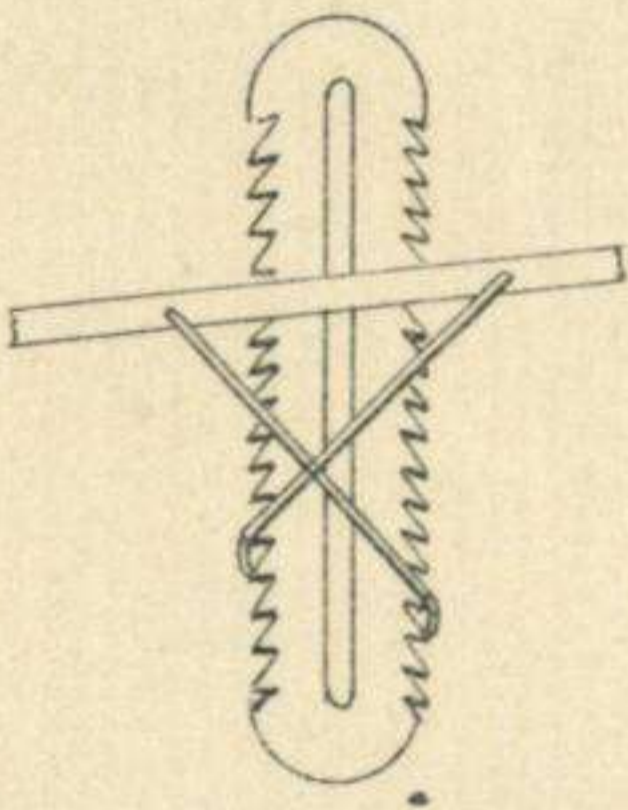
388.



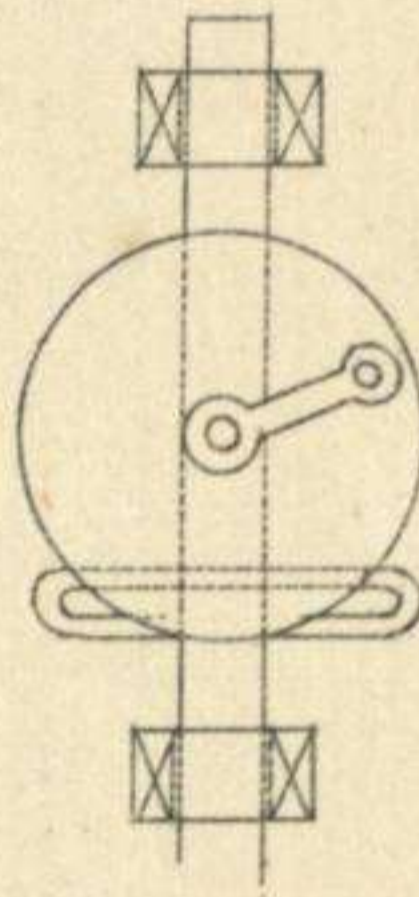
389.



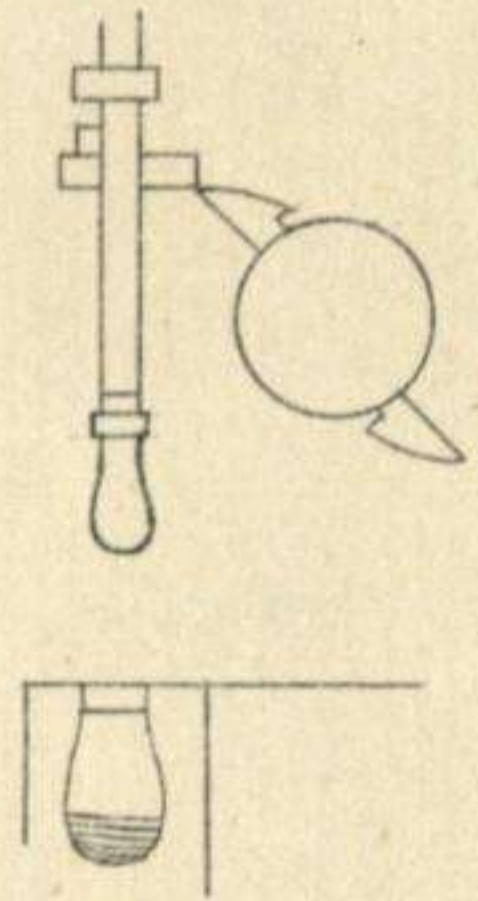
390.



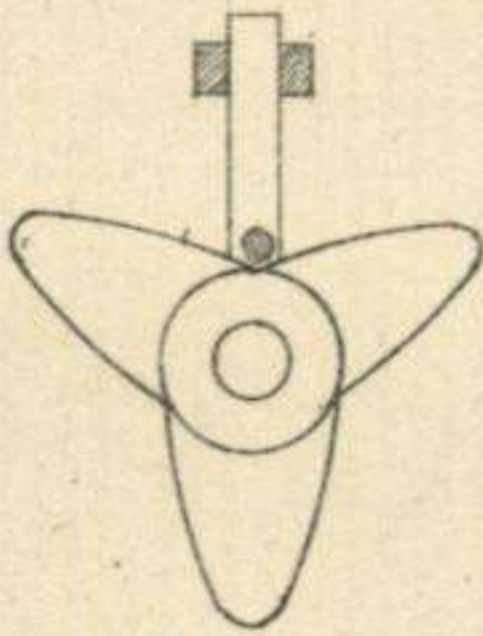
391.



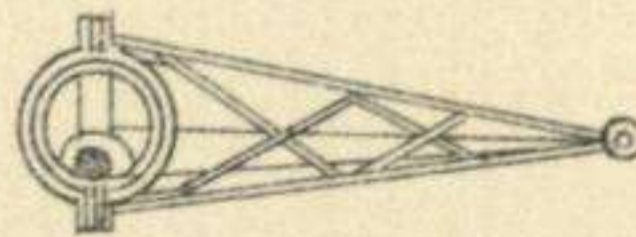
392.



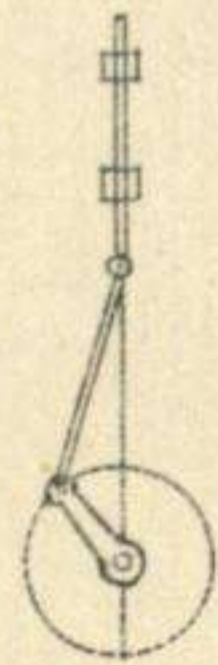
393.



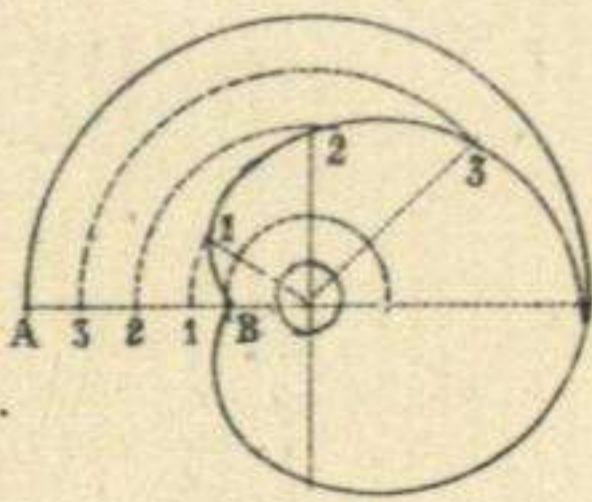
394.



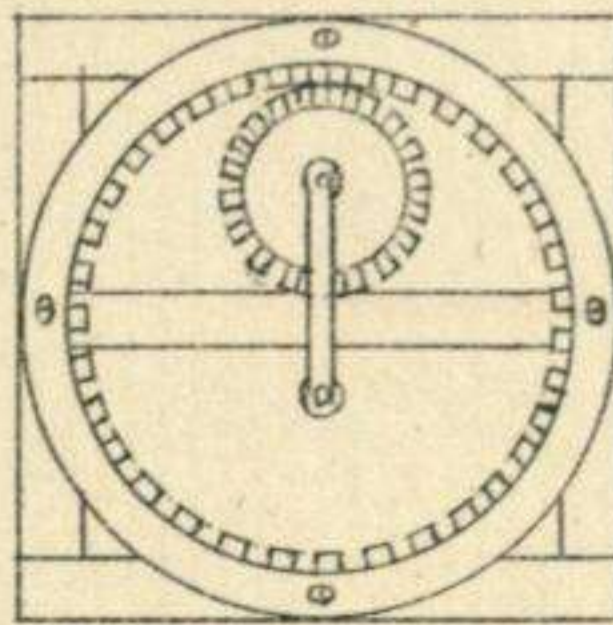
396.



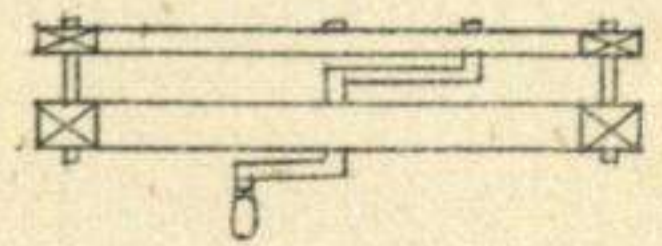
395.



397.



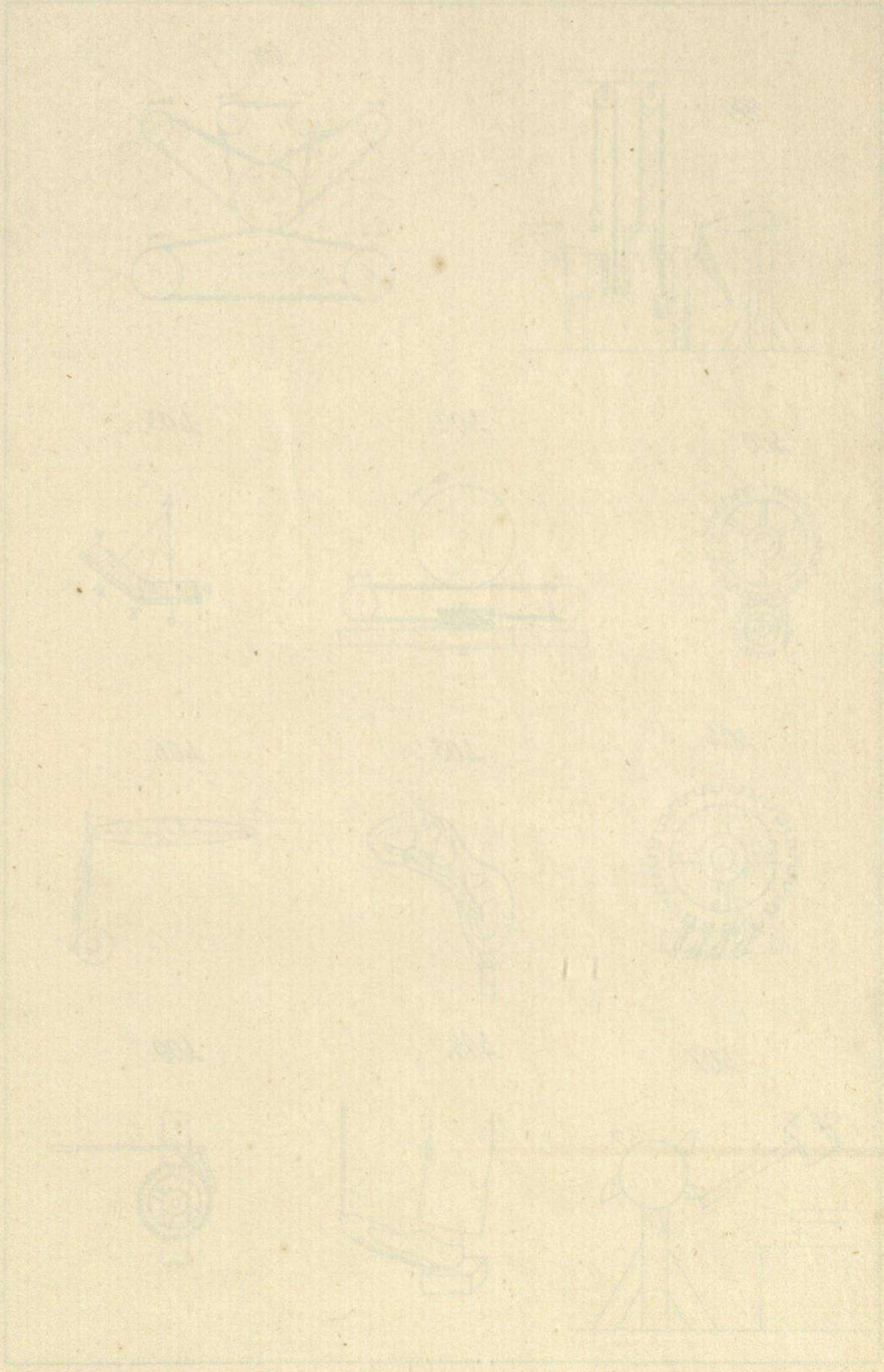
398.



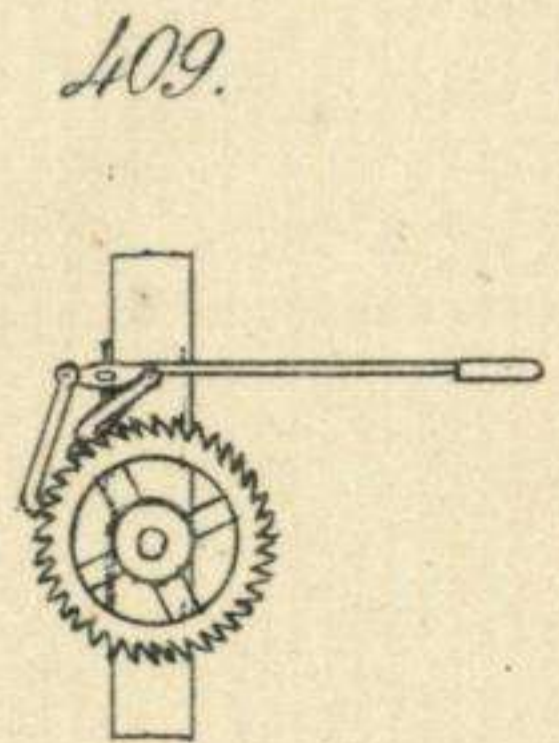
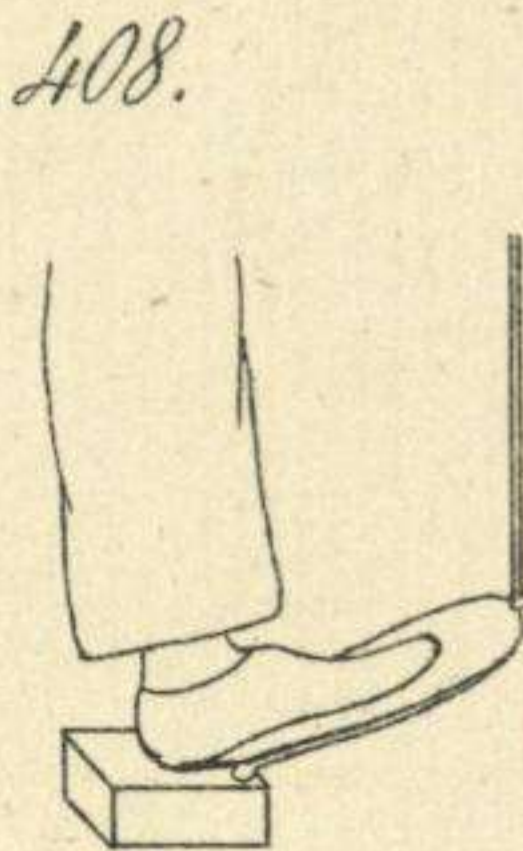
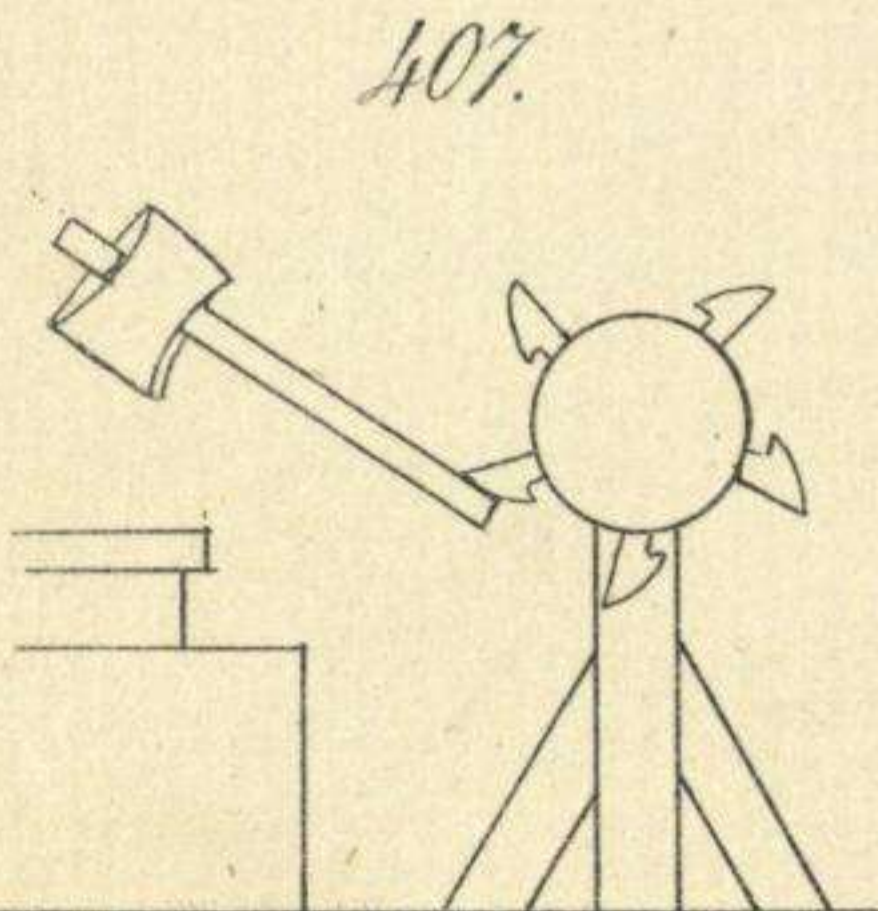
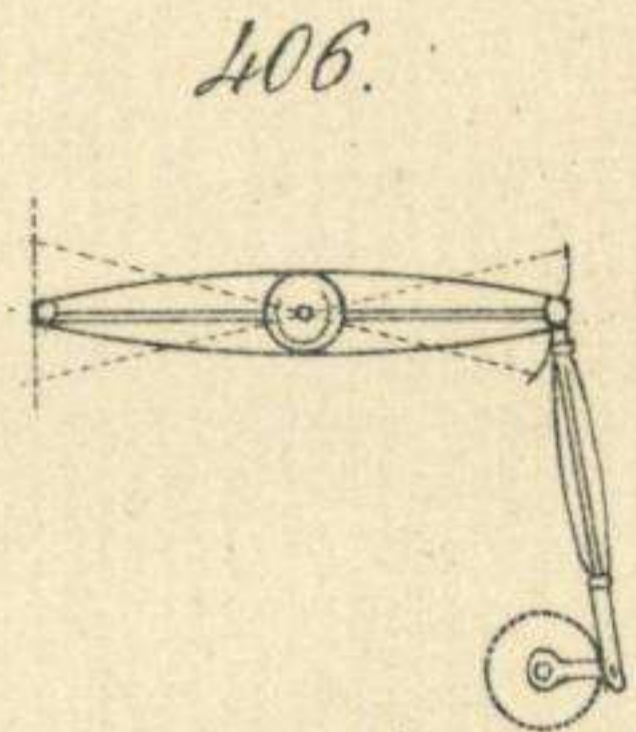
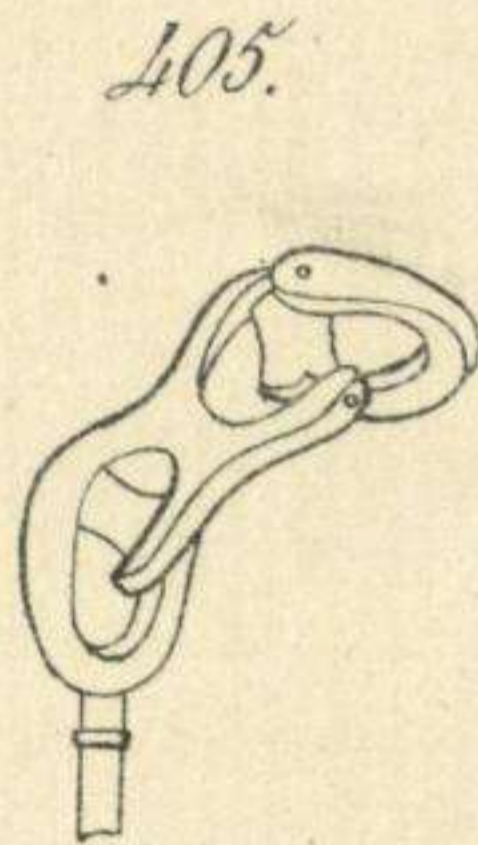
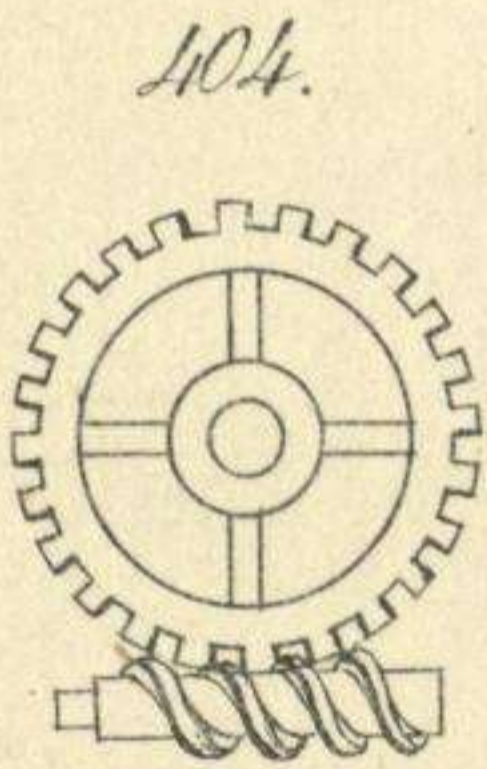
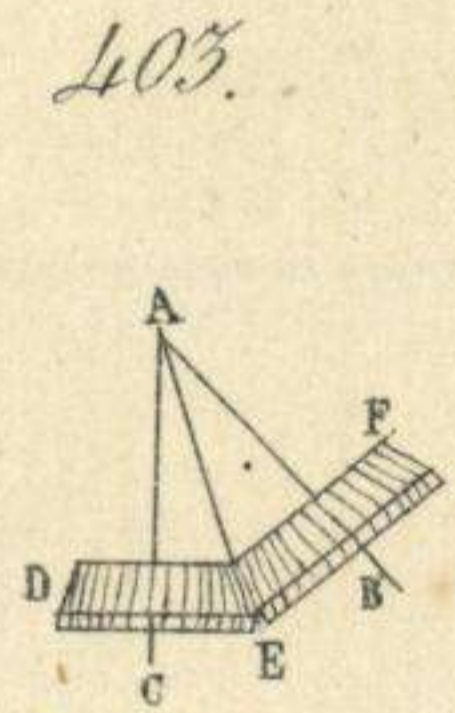
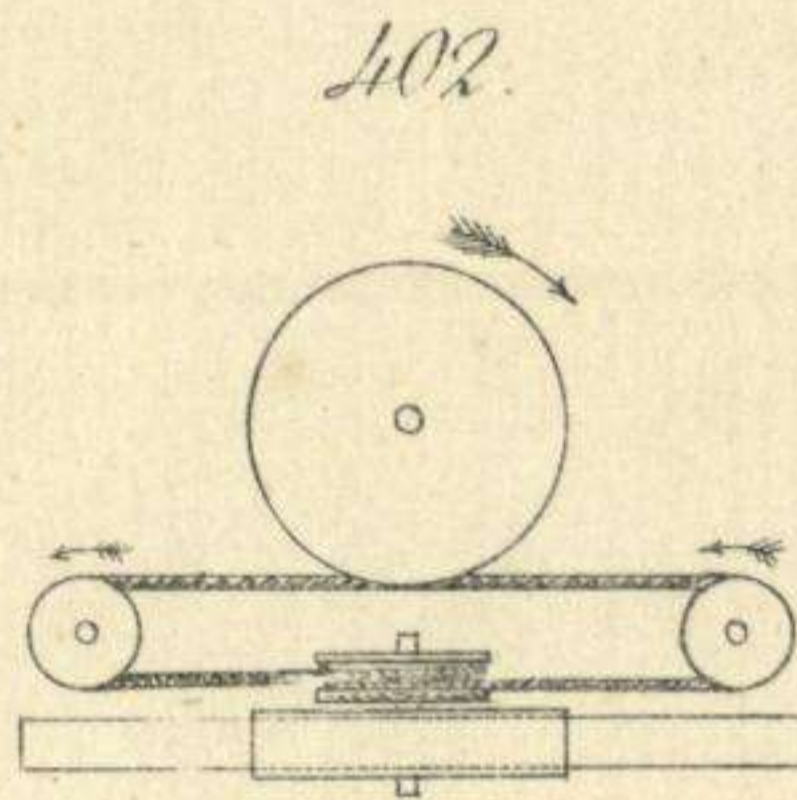
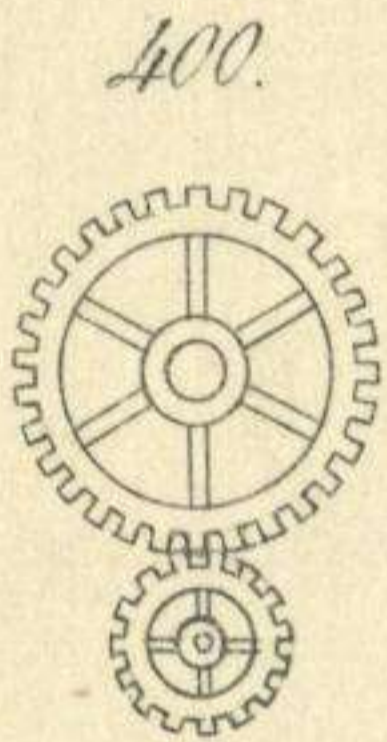
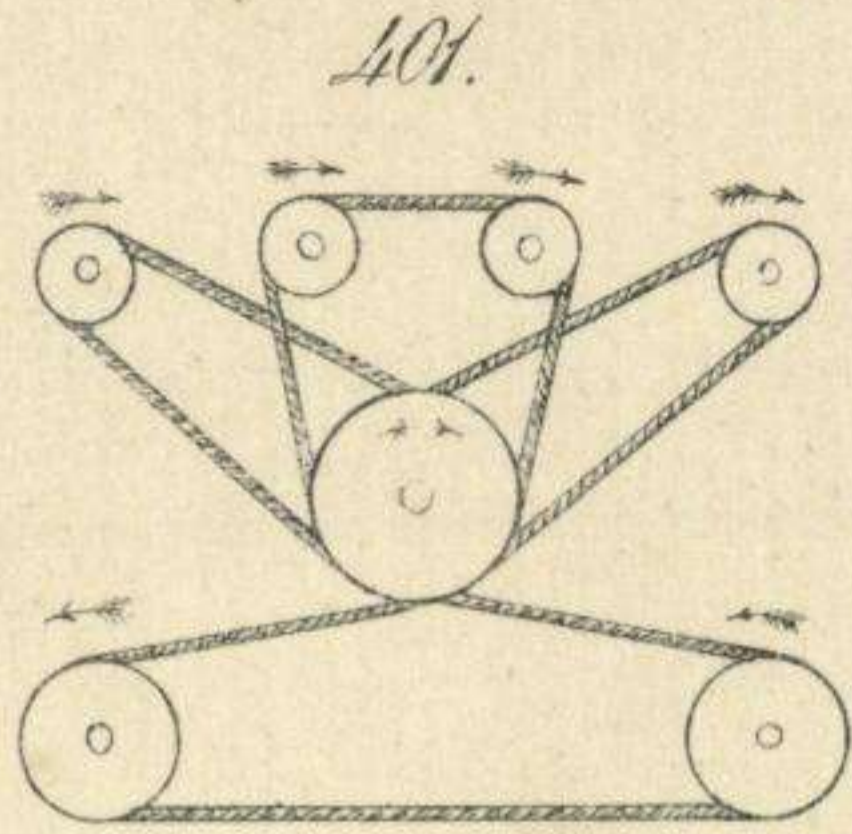
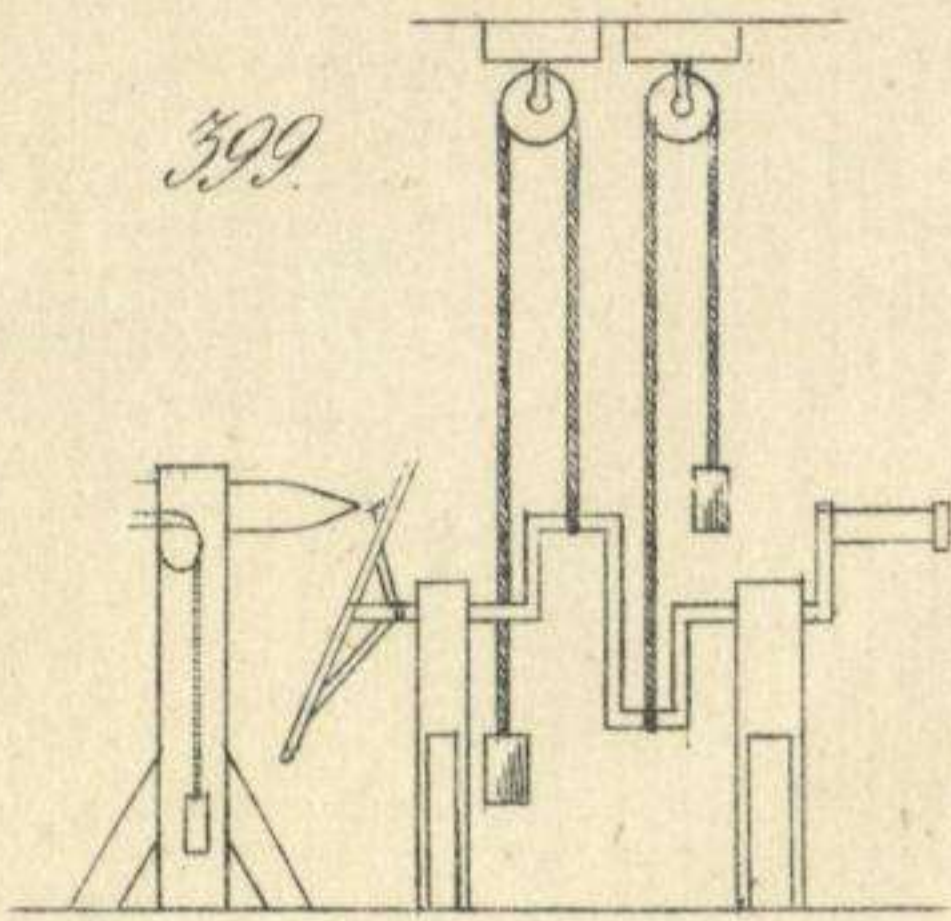












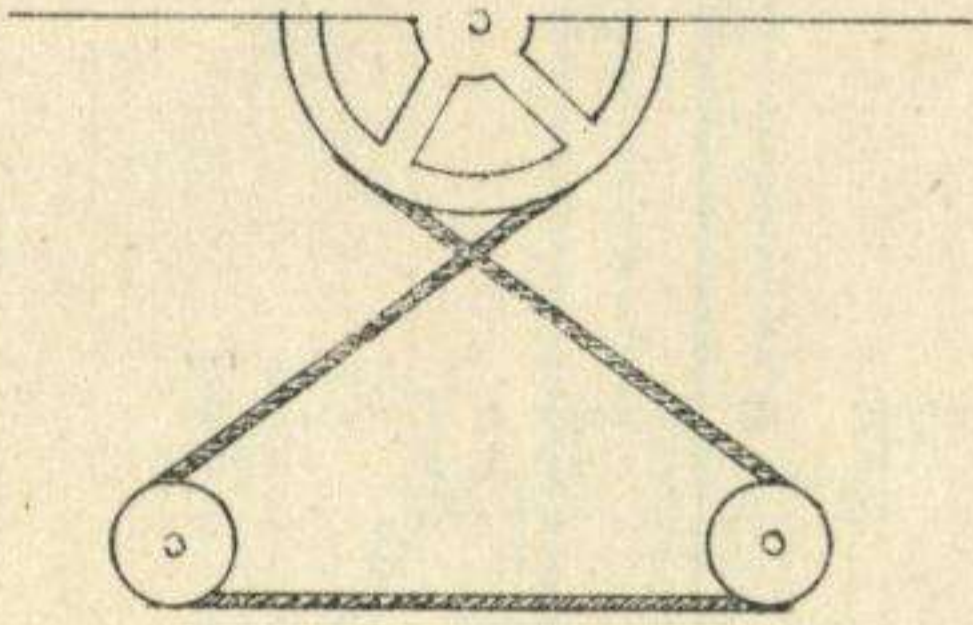




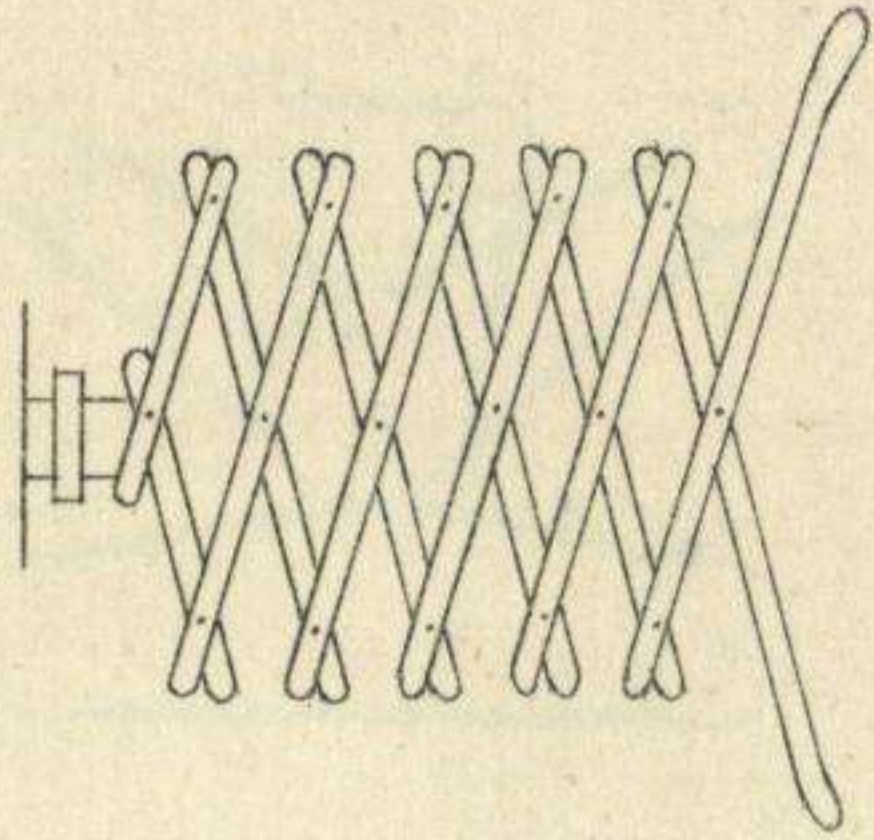


# Diccionario de Agricultura

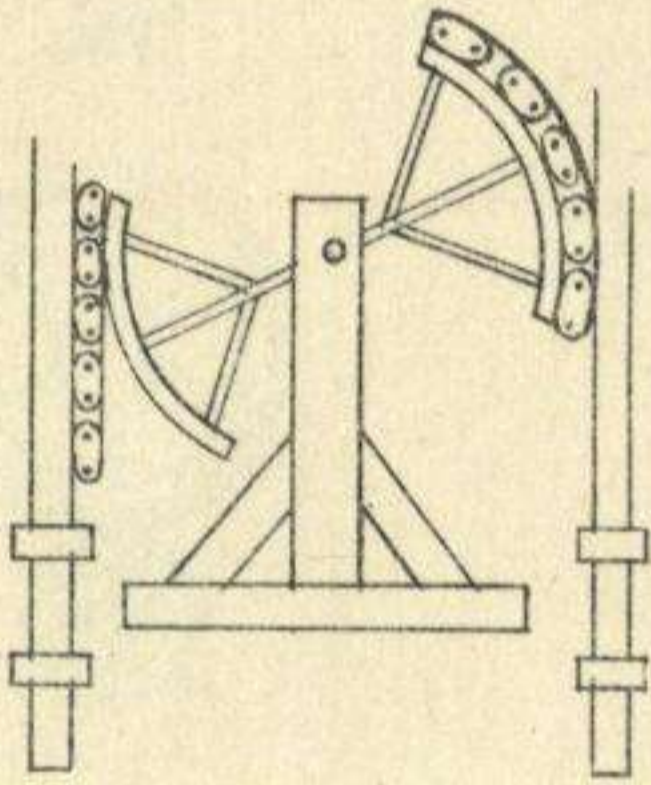
410.



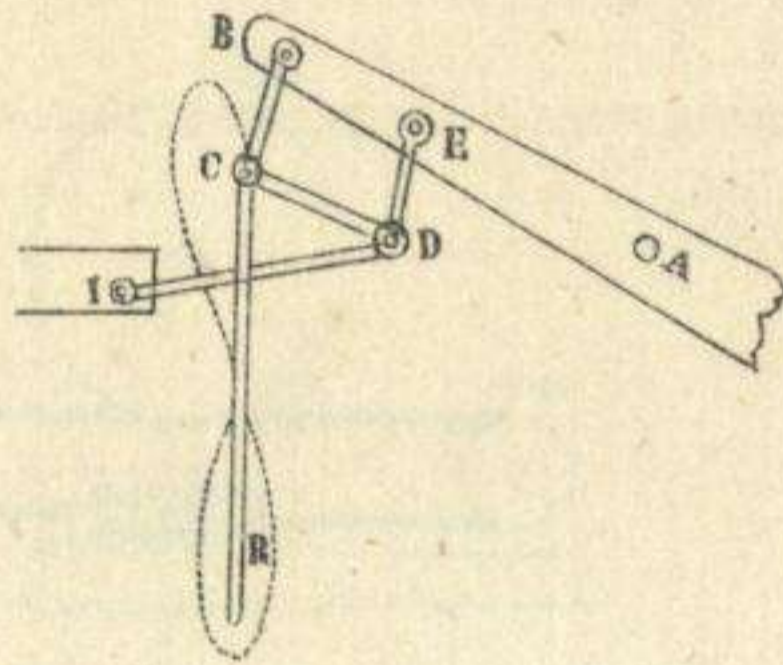
411.



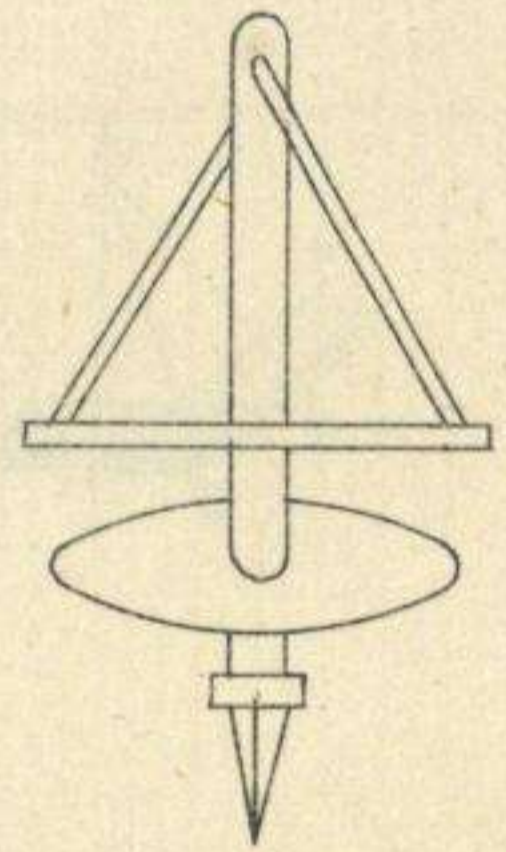
412.



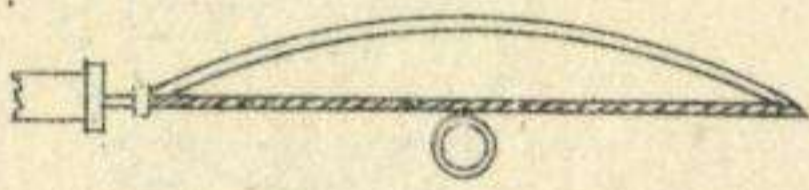
413.



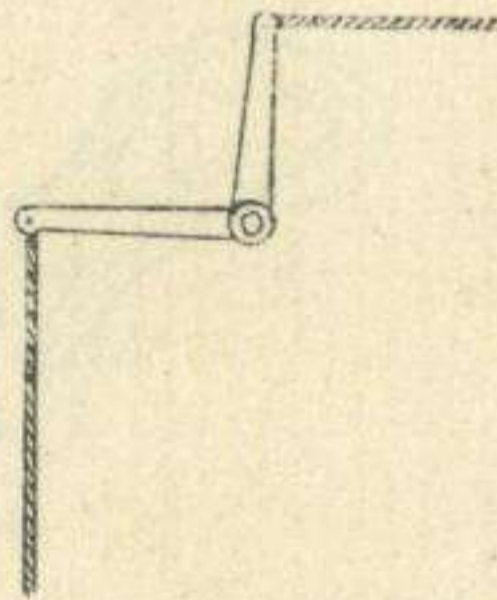
414.



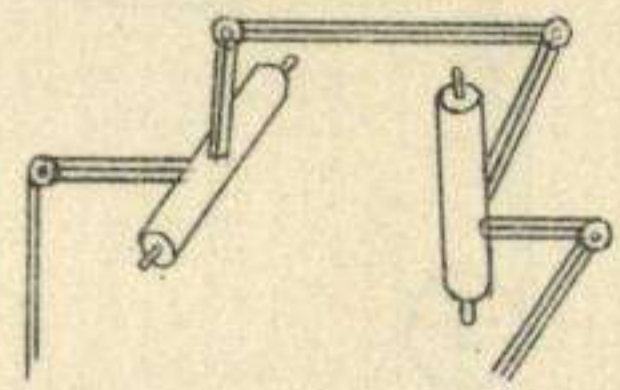
415.



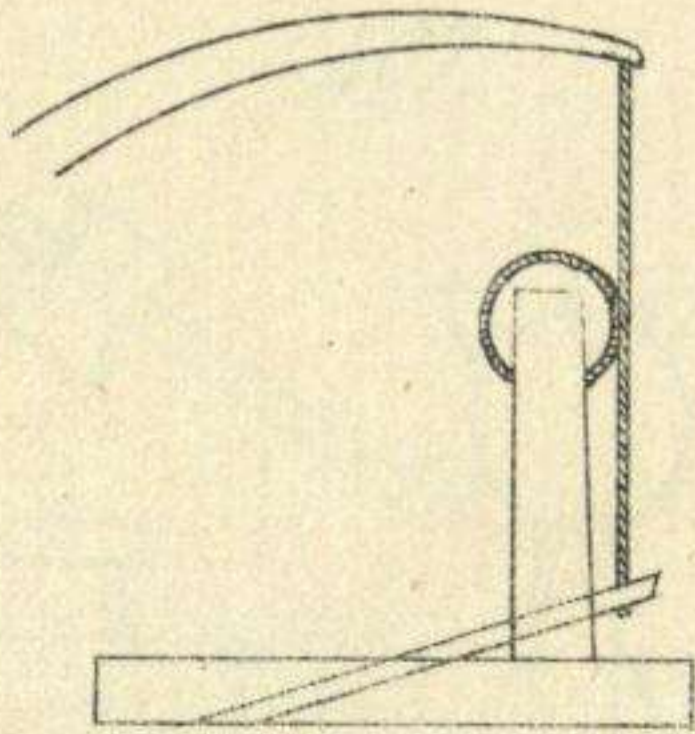
417.



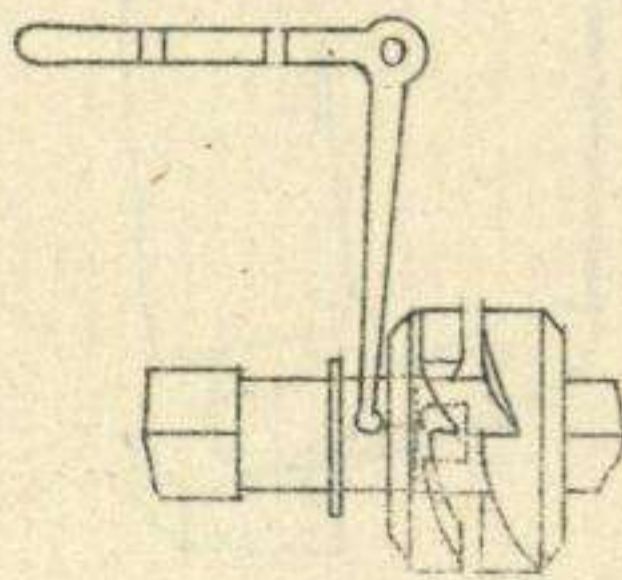
418.



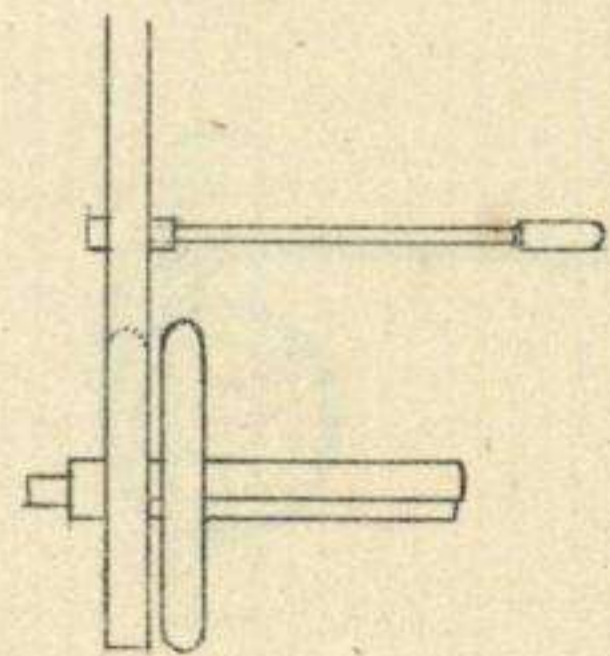
416.



419.

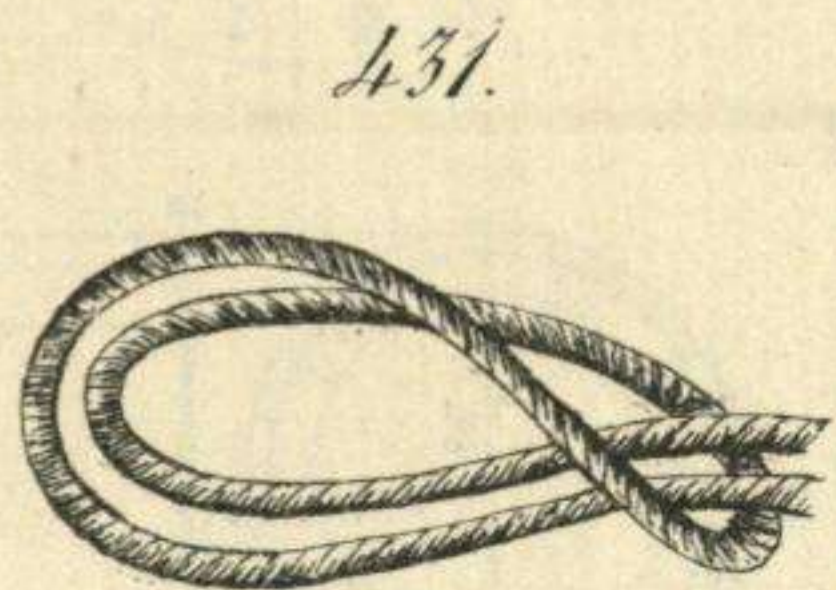
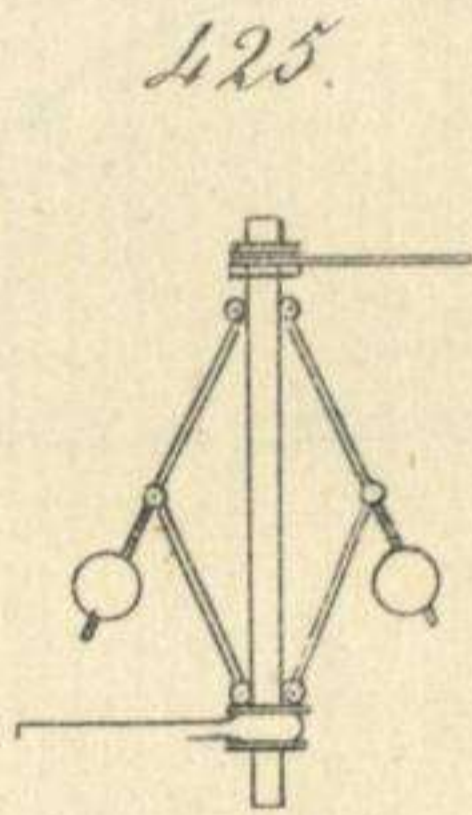
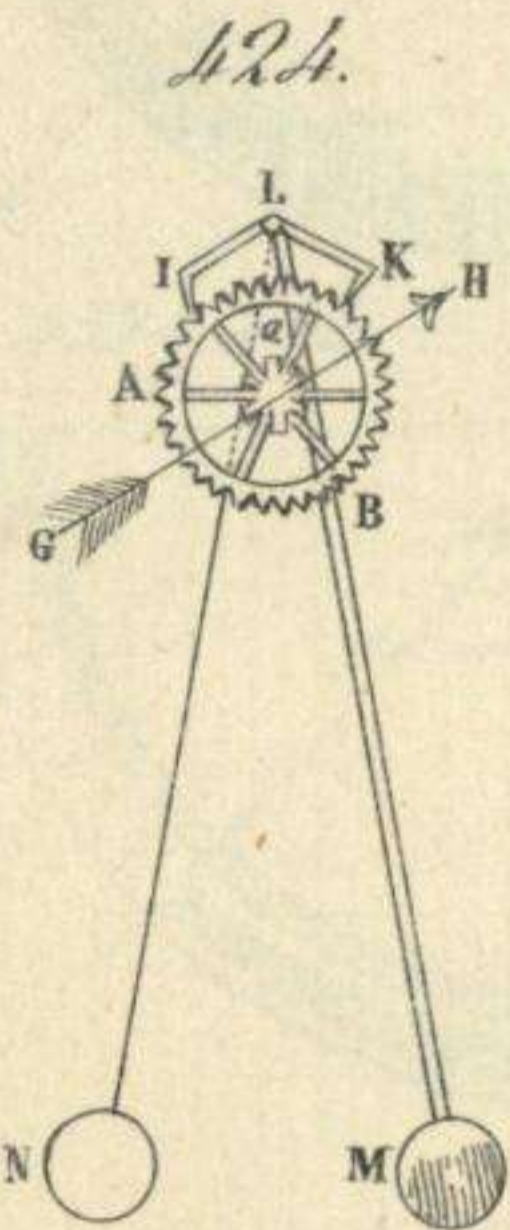
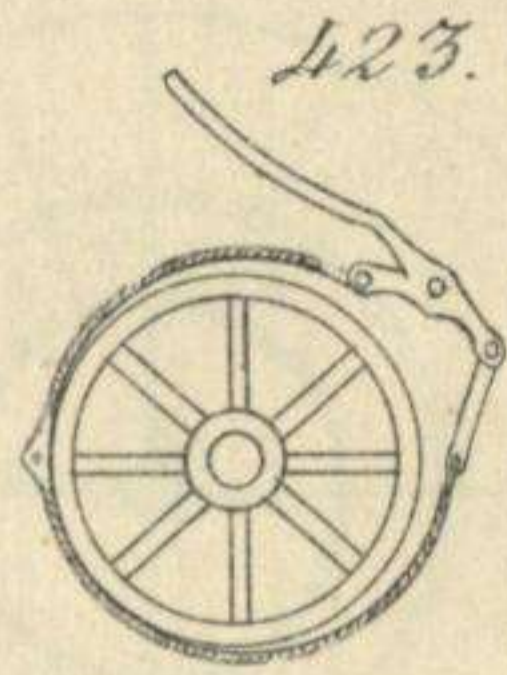
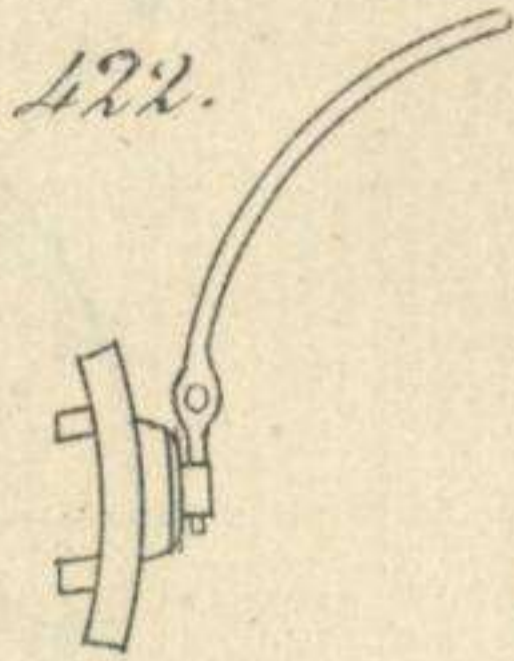
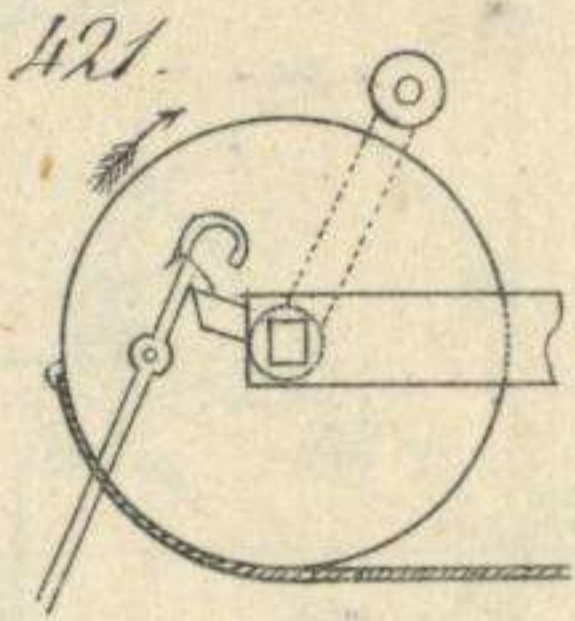


420.



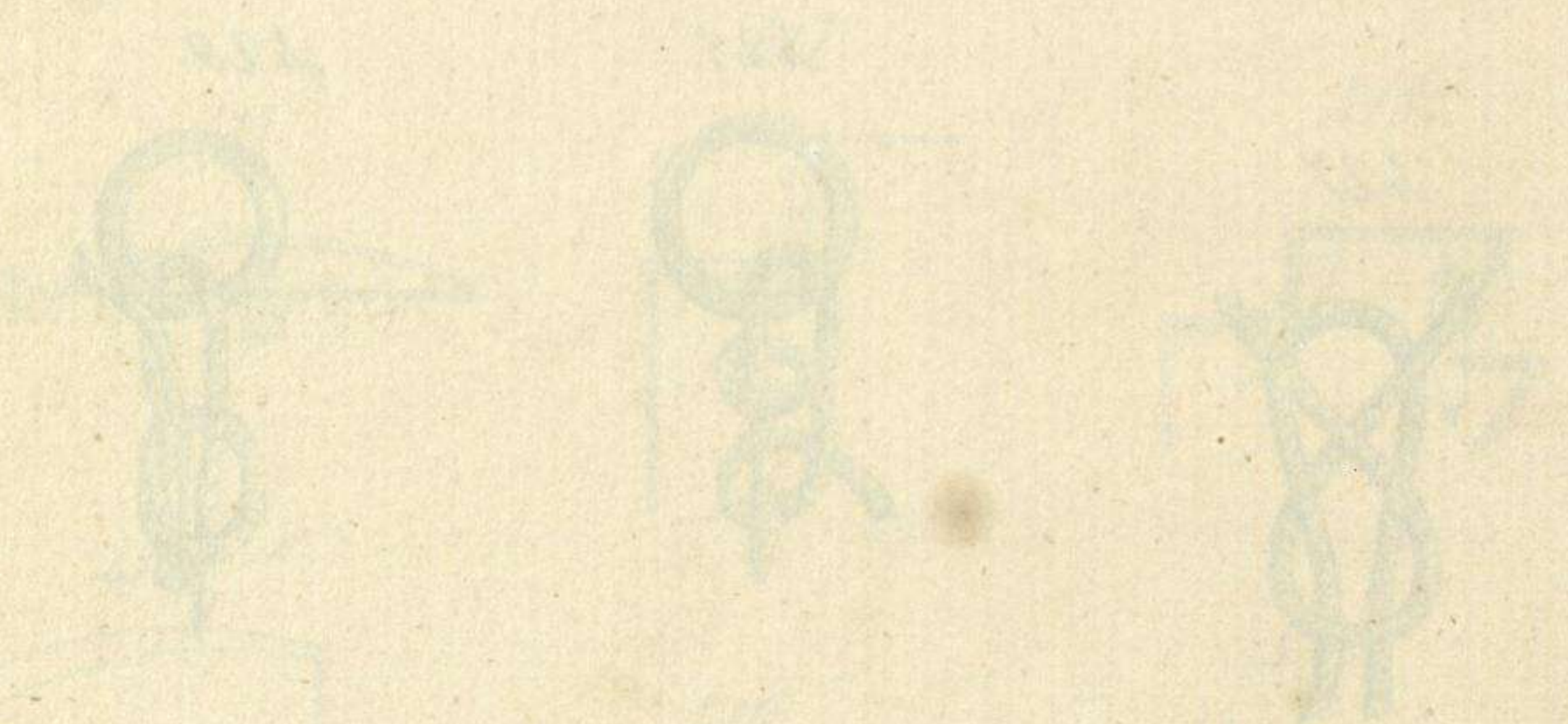
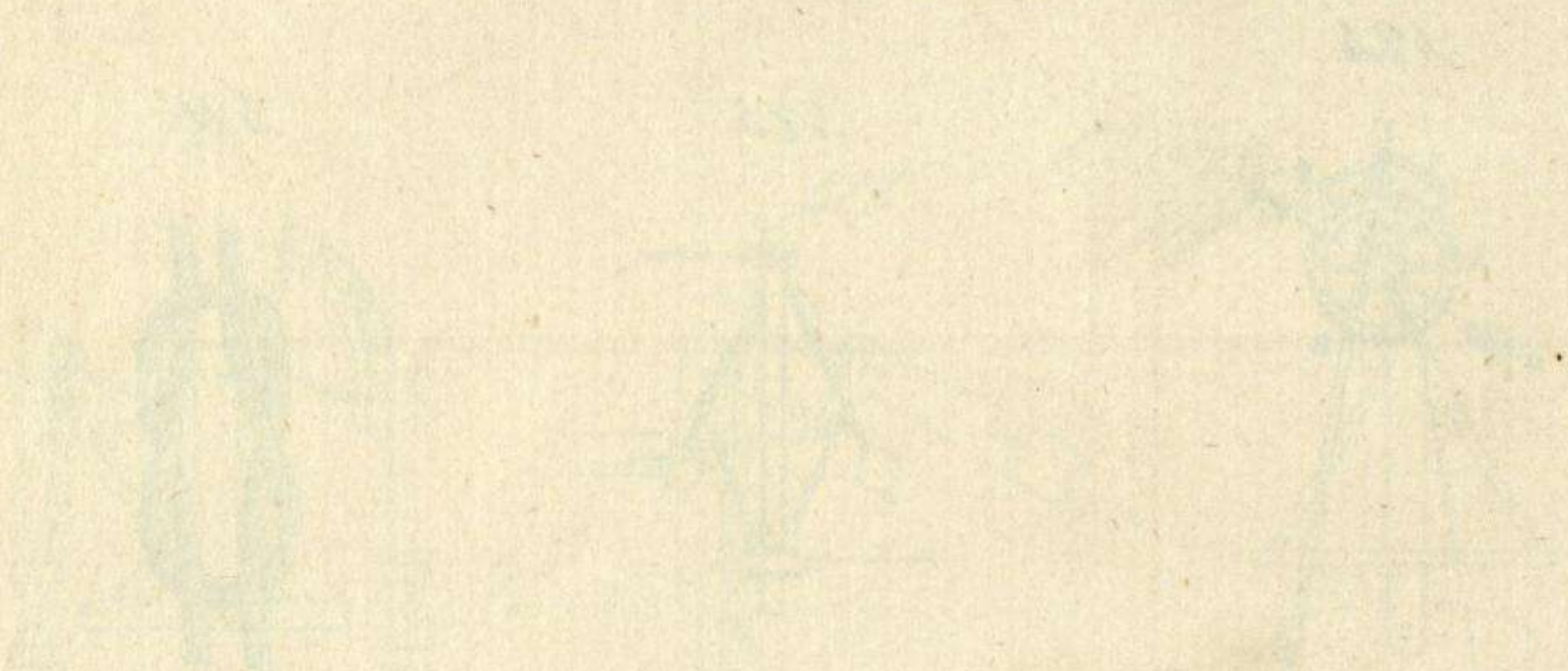


Diccionario de Agricultura.



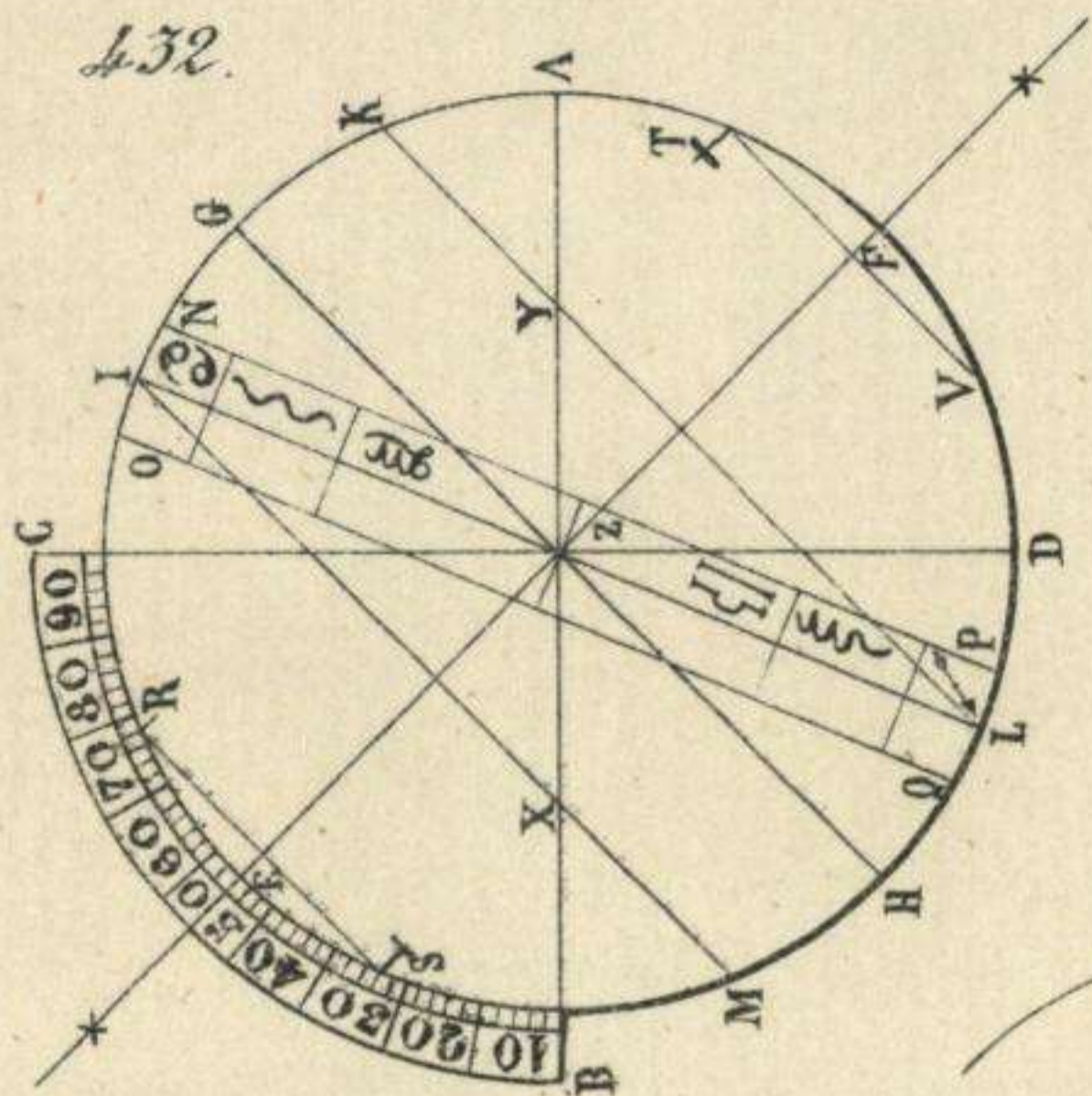


Handwritten title at the top of the page, possibly in a non-Latin script.

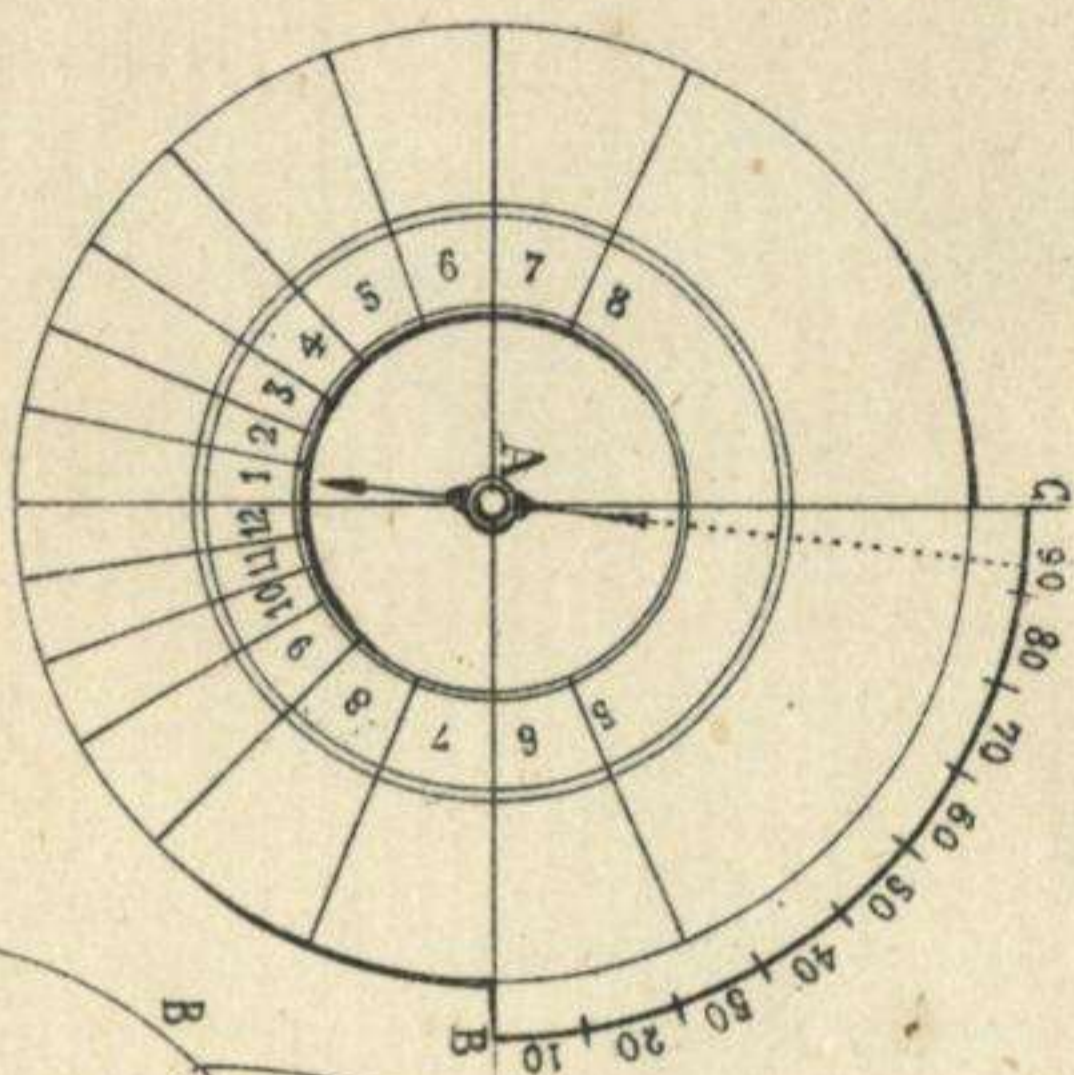




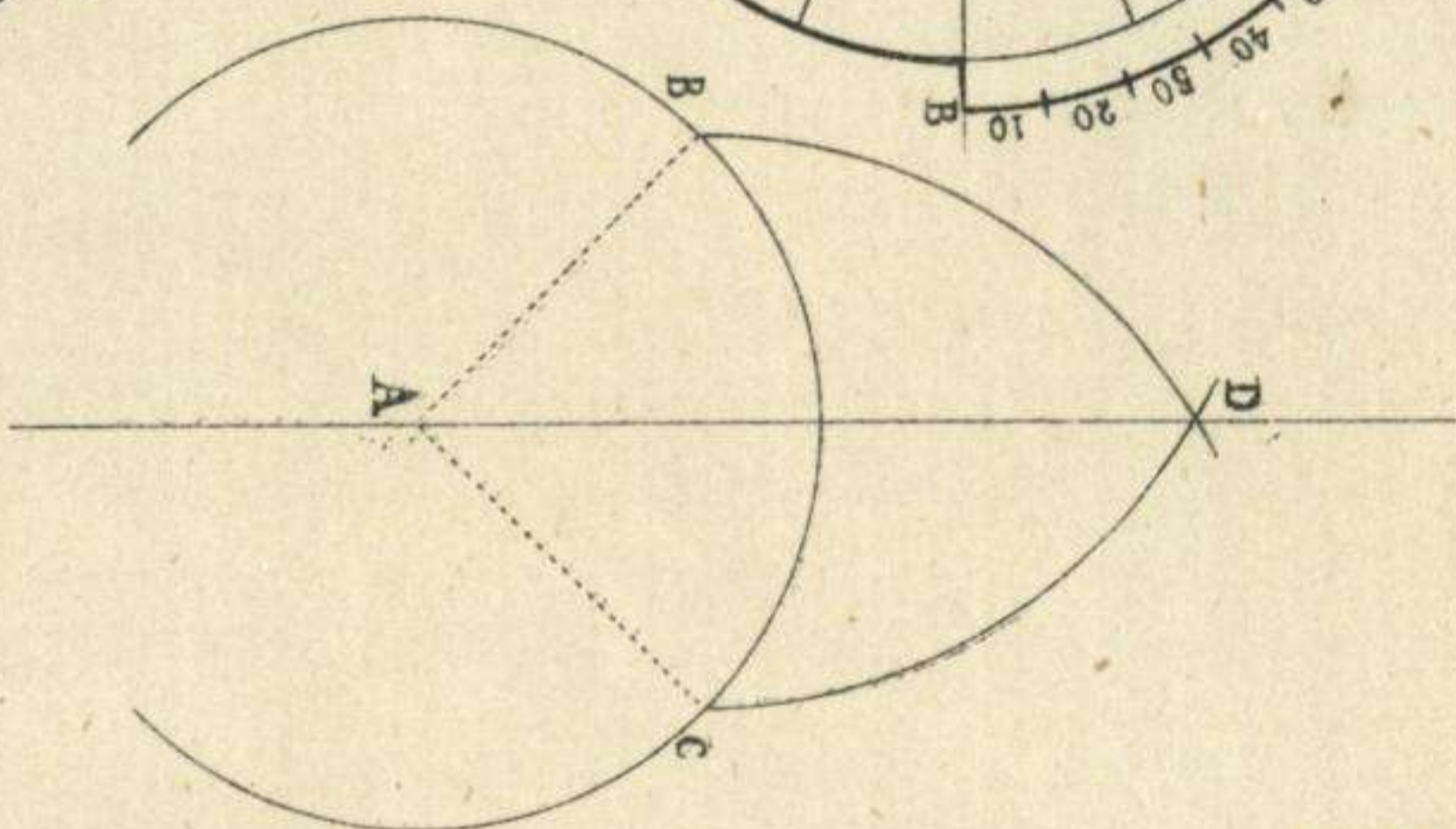
432.



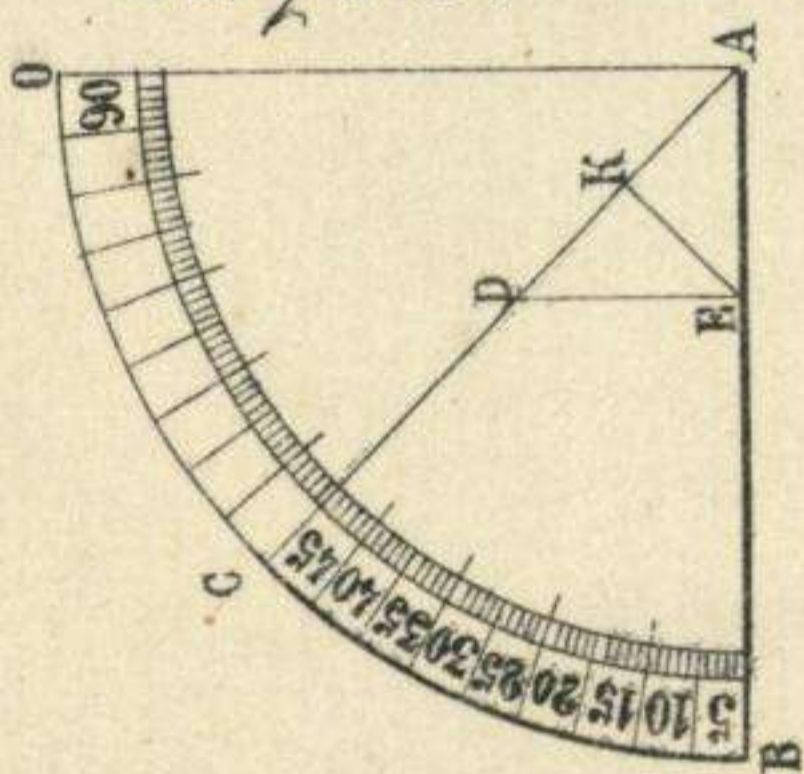
436



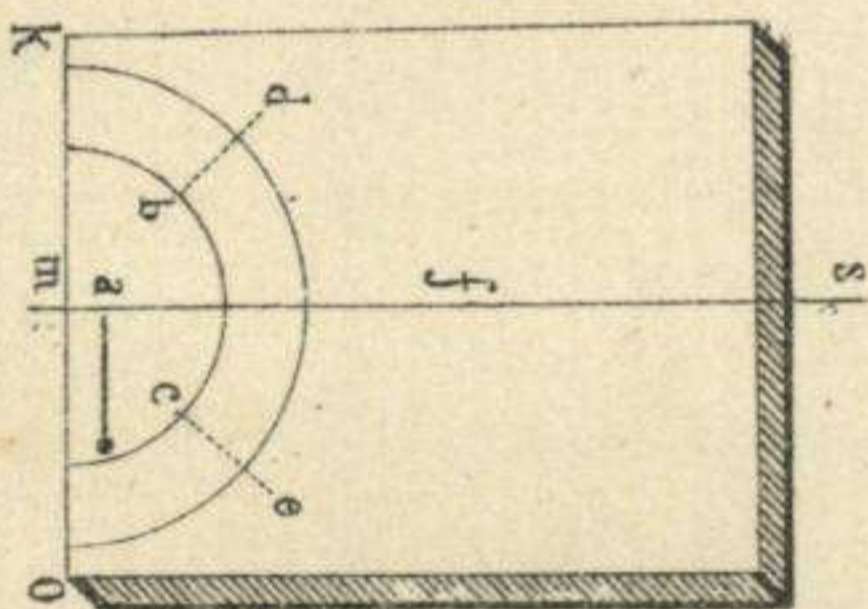
435.



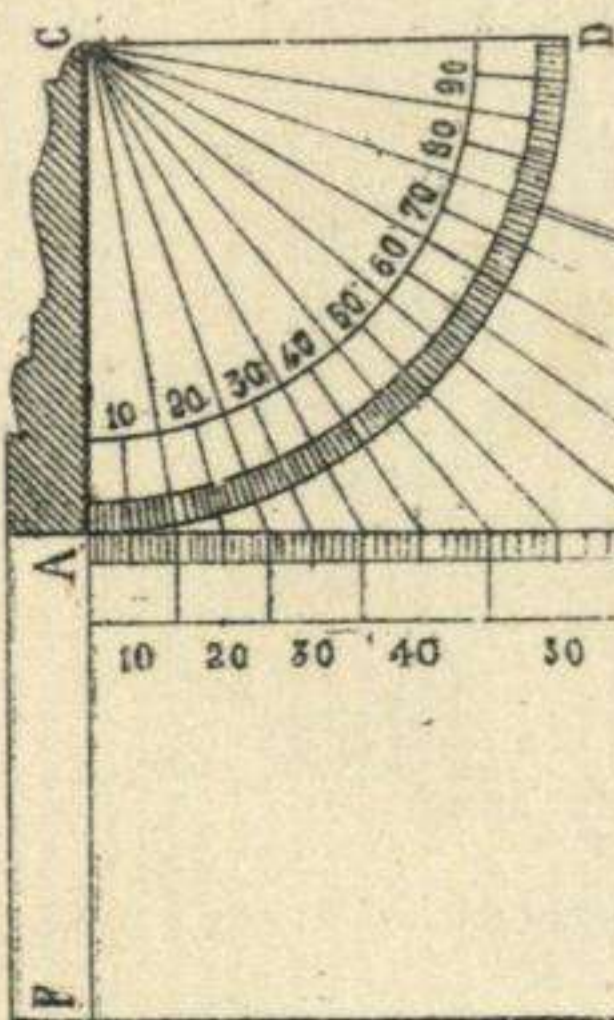
433 y 445.



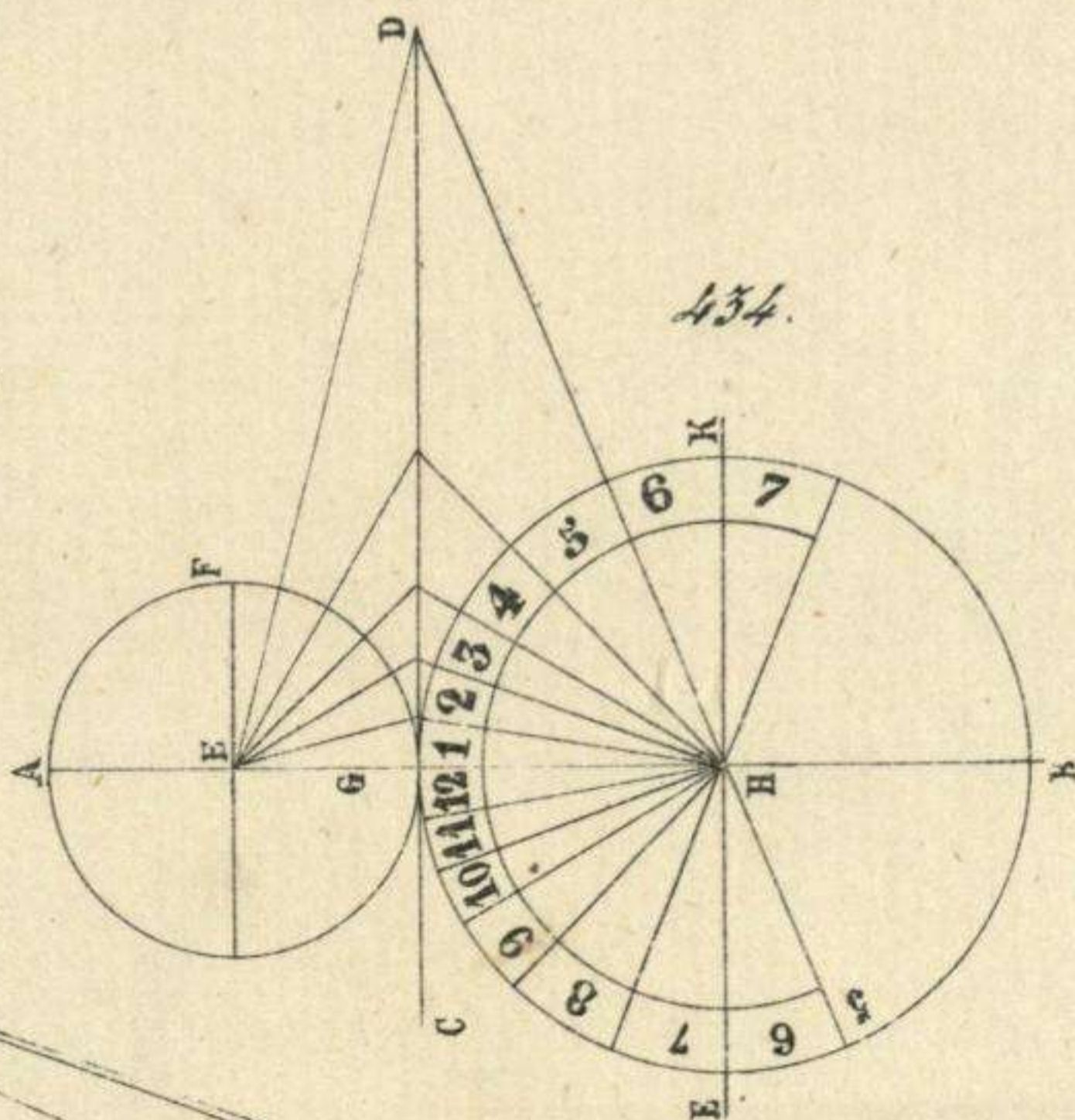
444, 439 ó 446.



438.



434.



437.

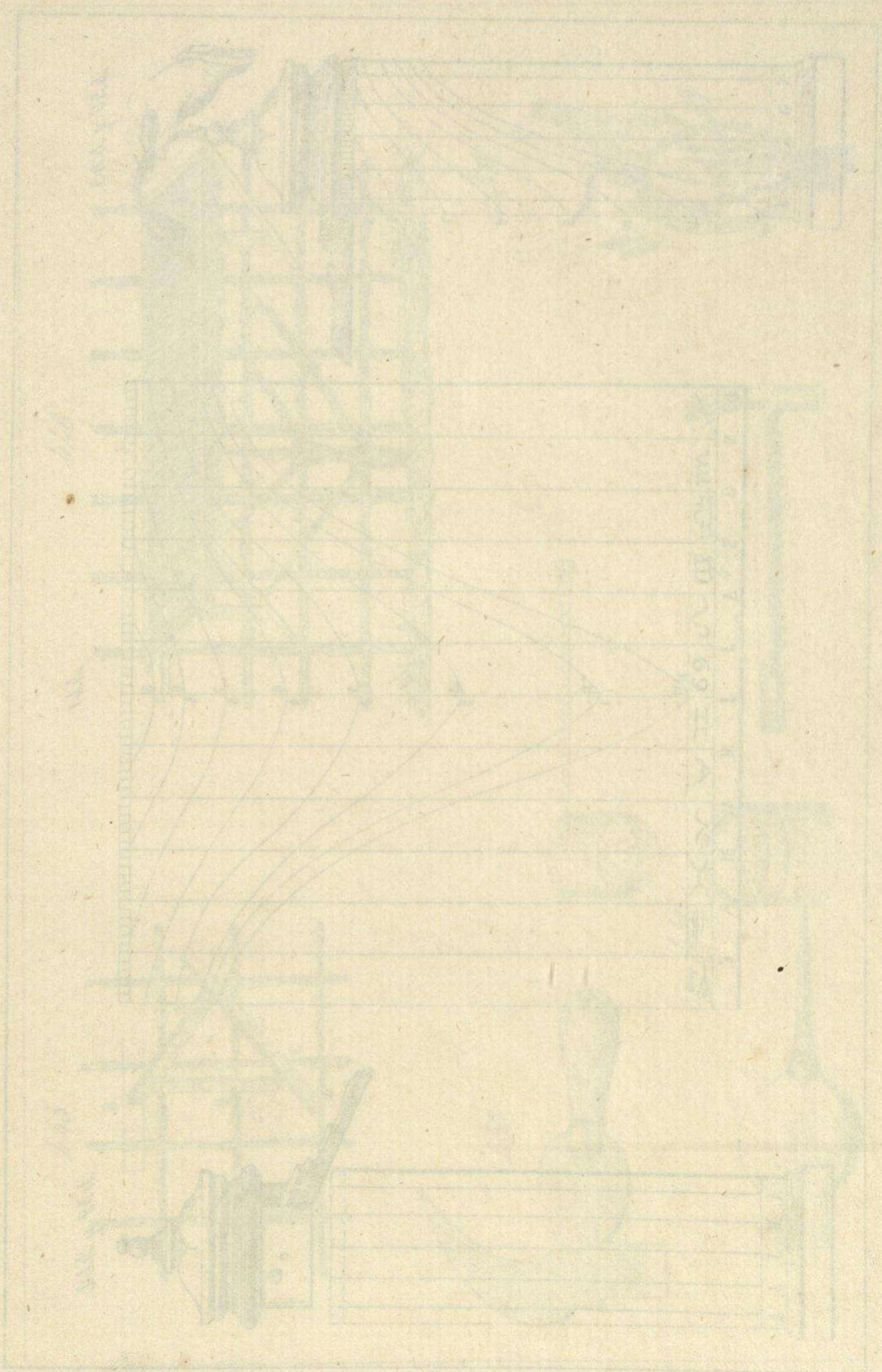
N	X	5
O	W	8
S	V	7
A	U	6
J	T	5
J	R	4
M	Q	3
A	P	2
M	O	1
F	N	12
E	M	11
D	L	10







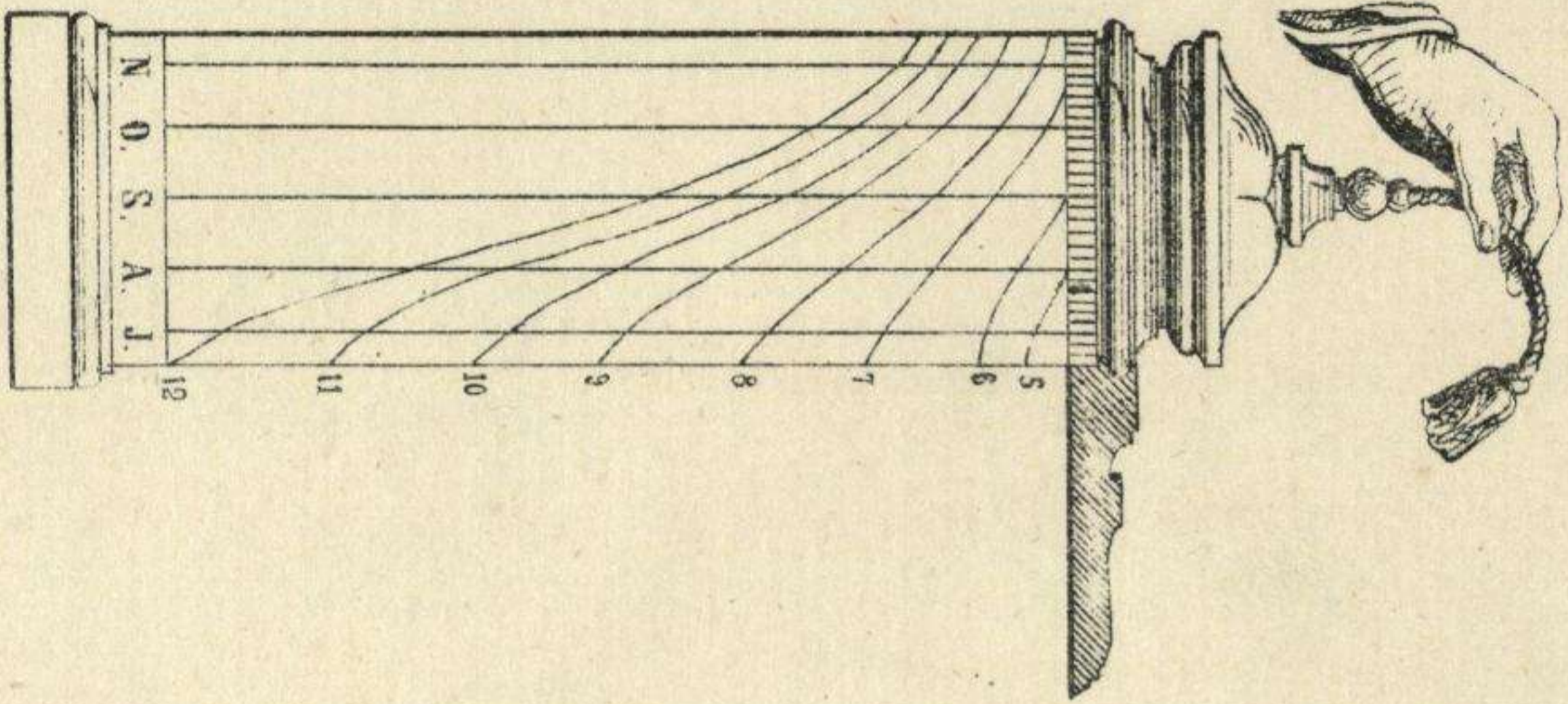
Discours sur l'Éducation



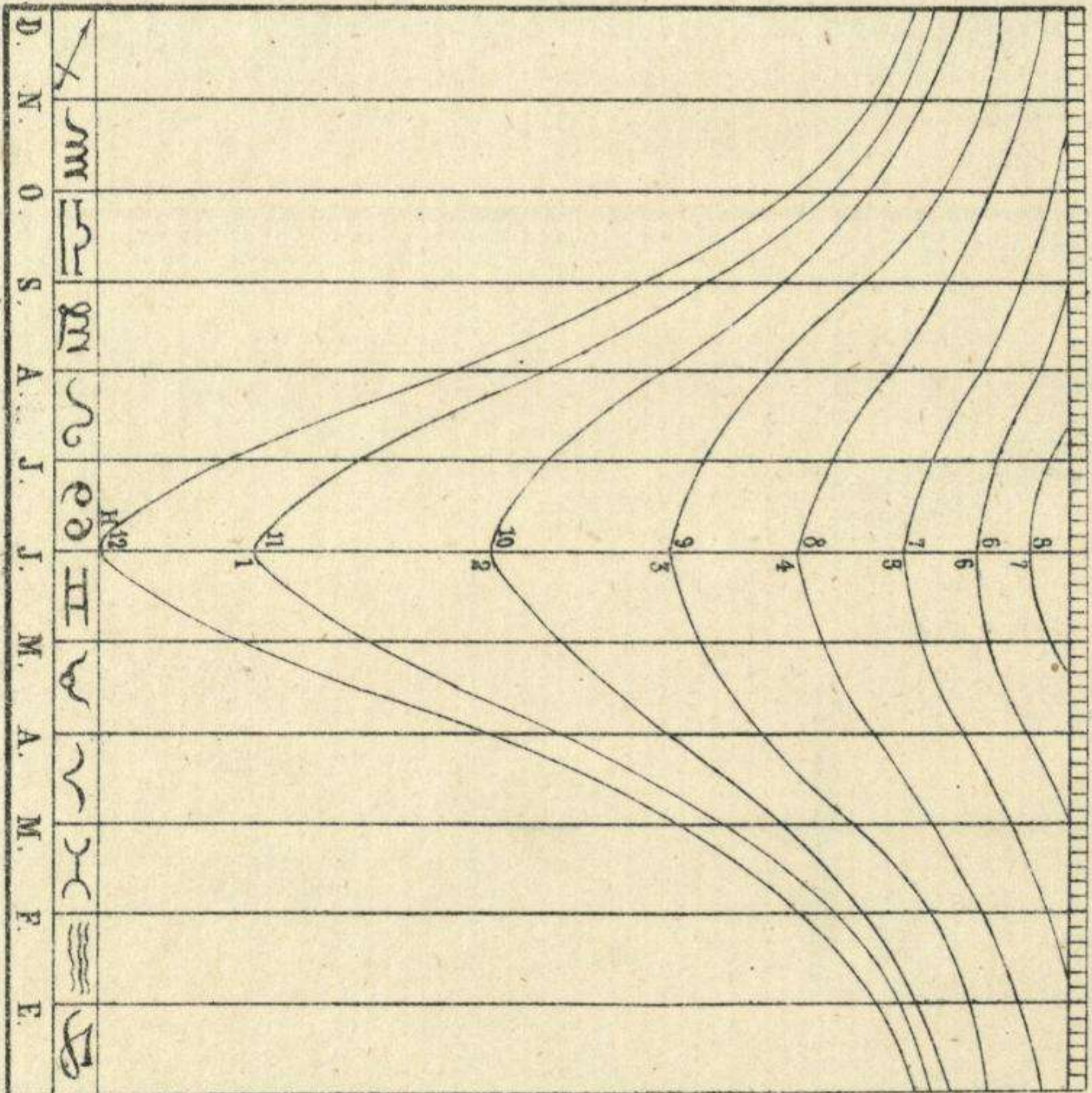


Diccionario de Agricultura.

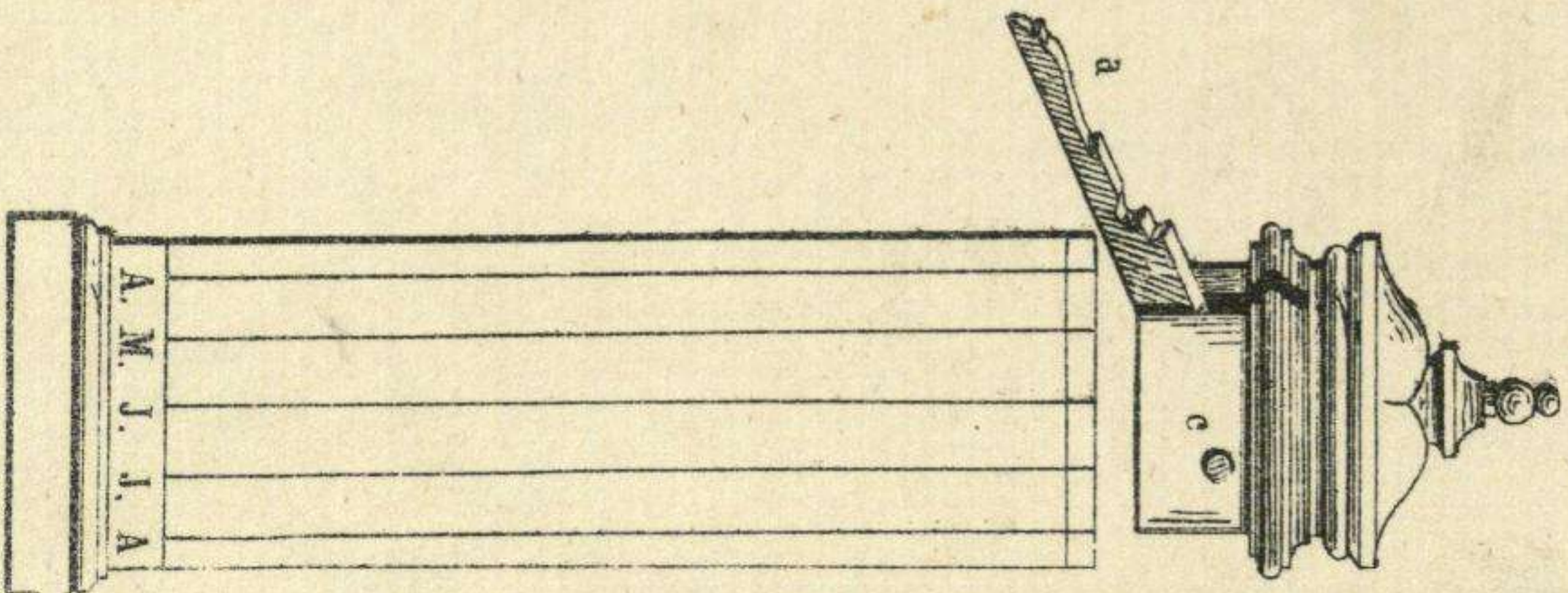
440 y 443.



441.

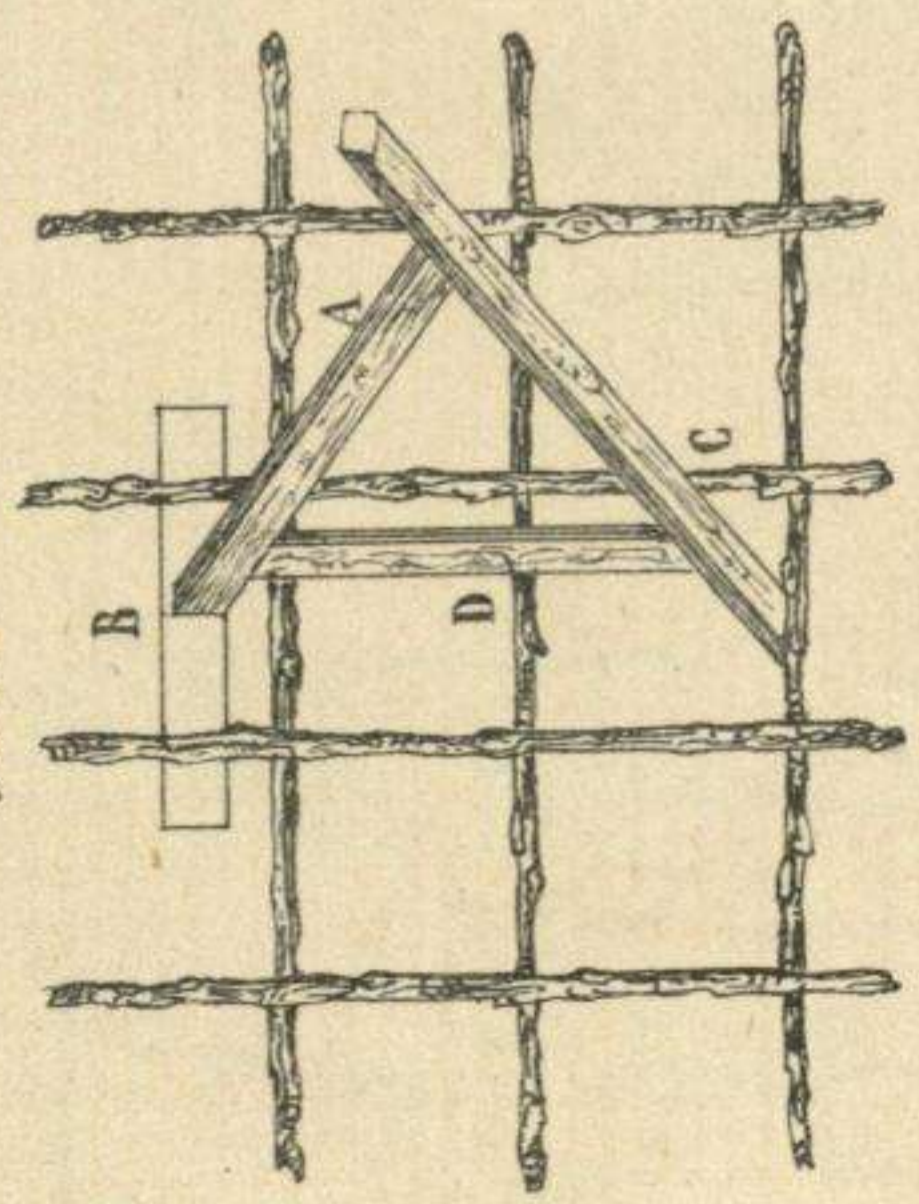


439 y 442.

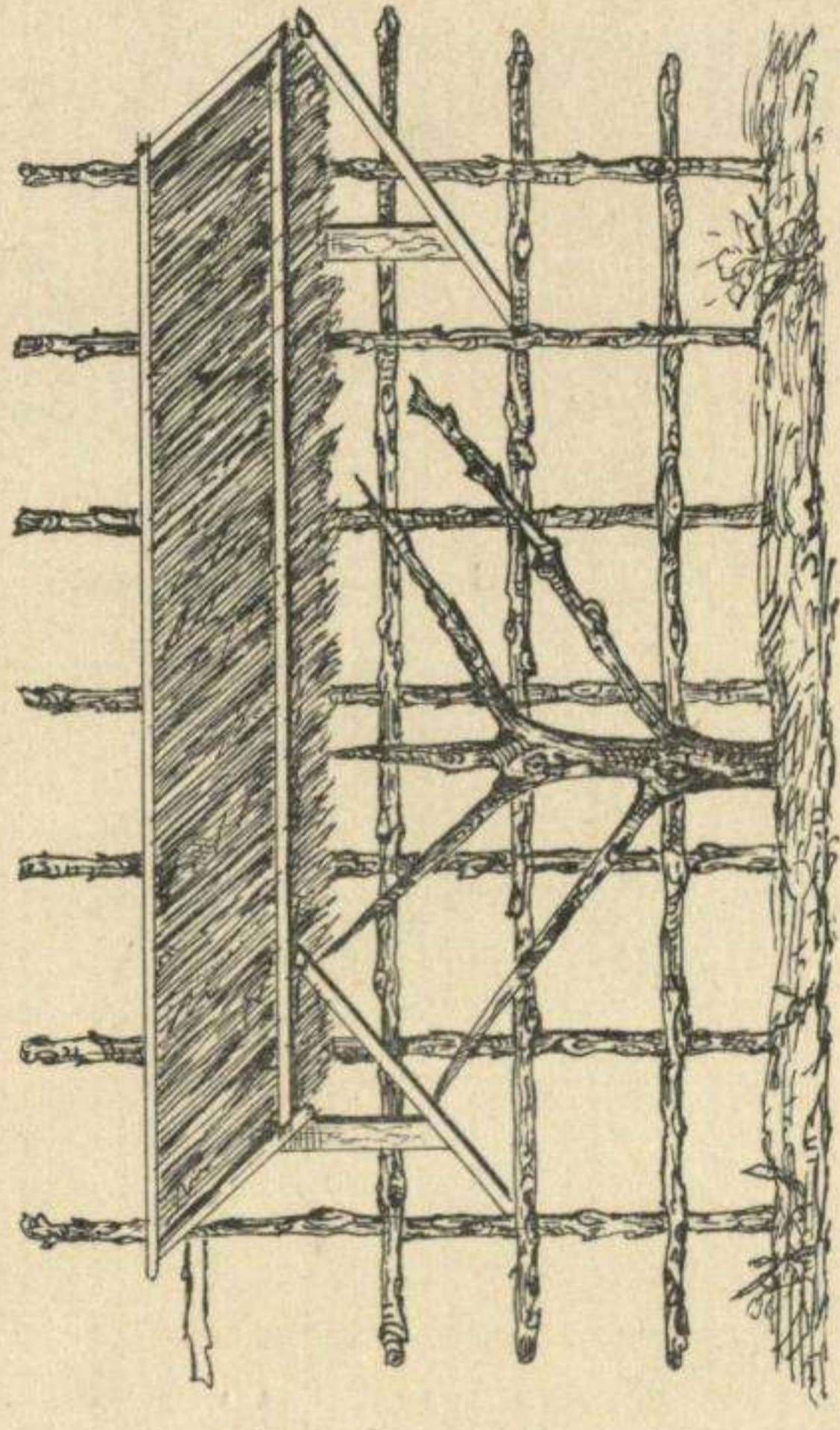




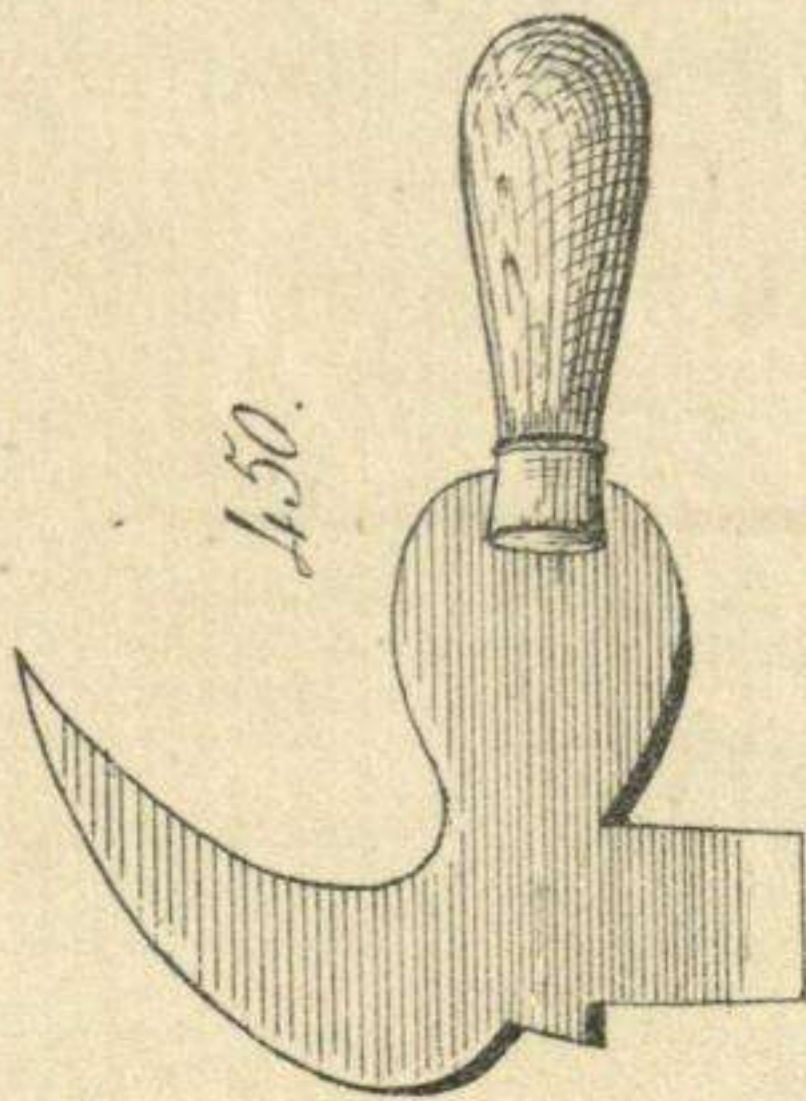
445.



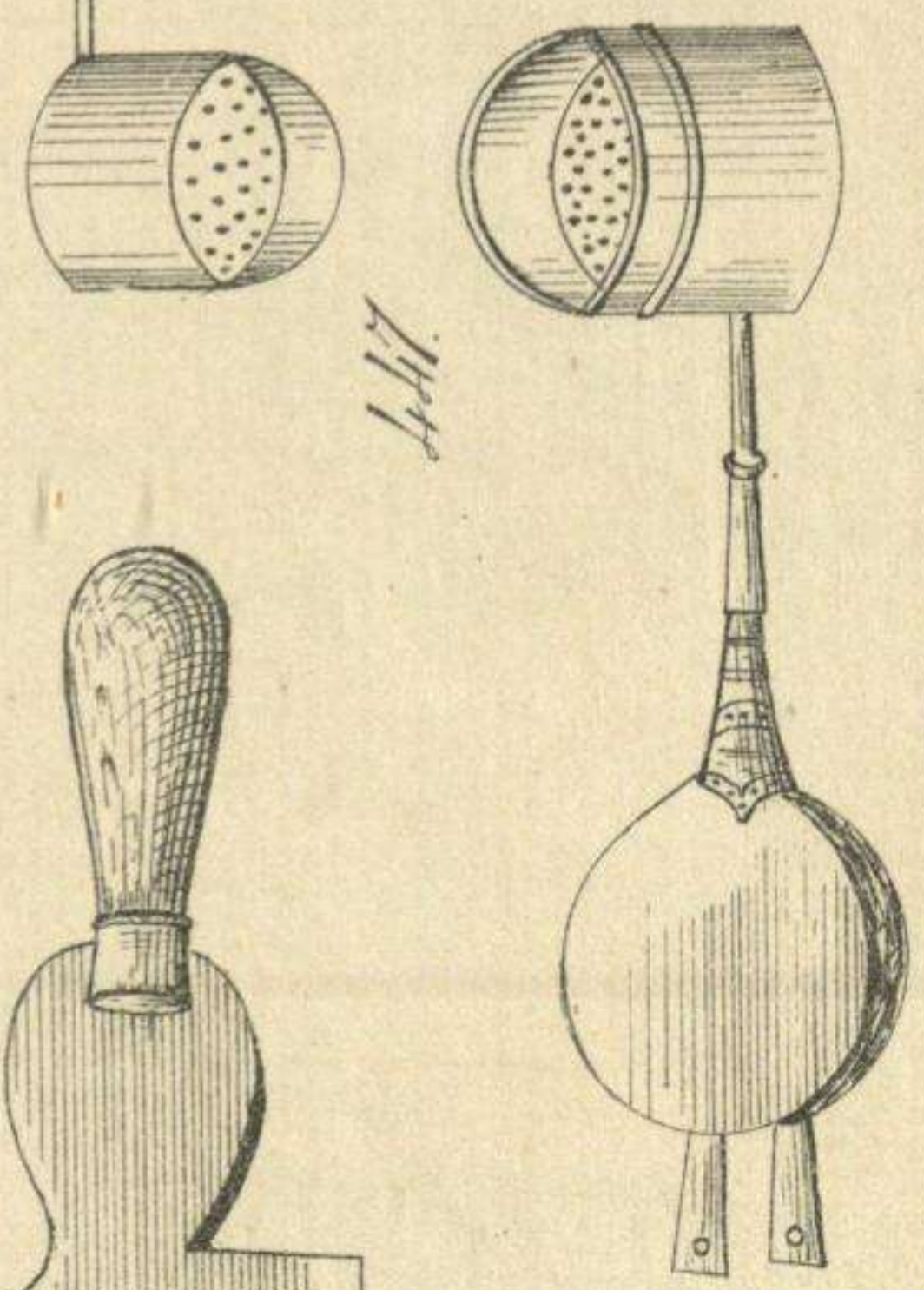
446.



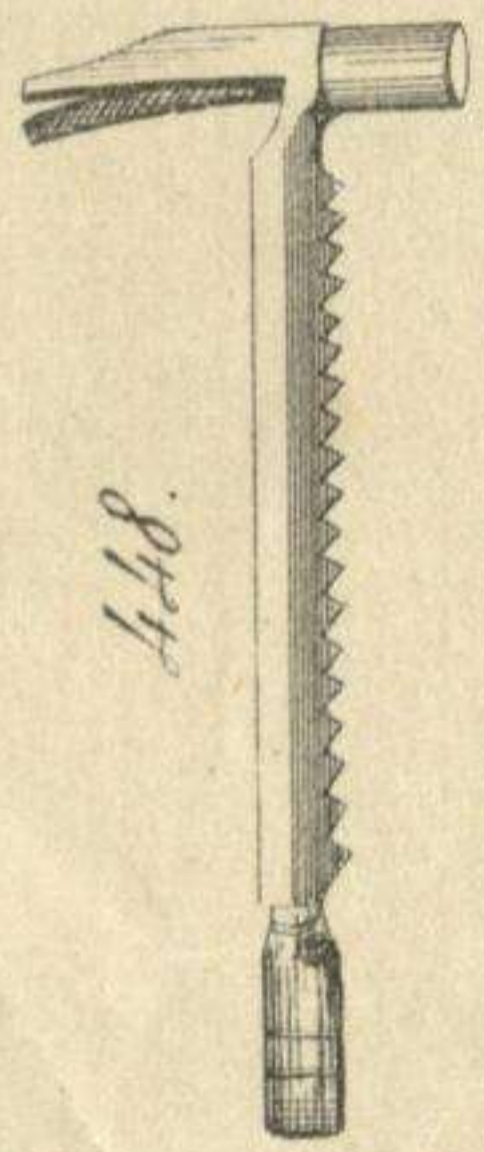
450.



447.



448.



449.





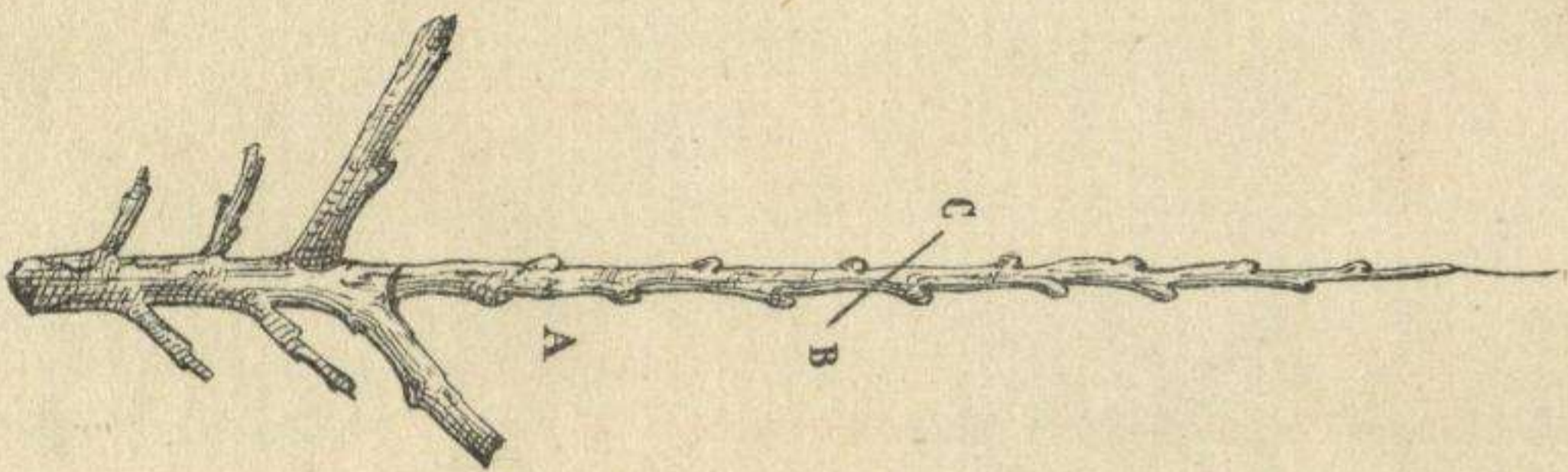




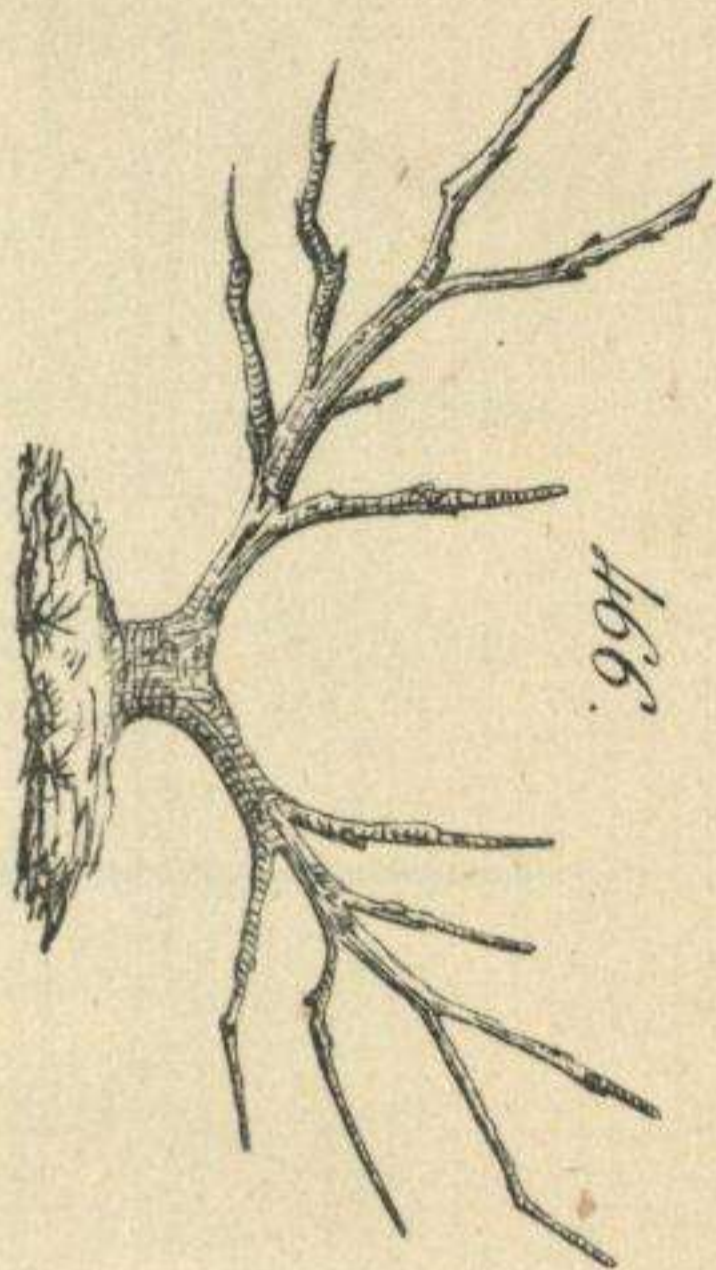




469.



466.



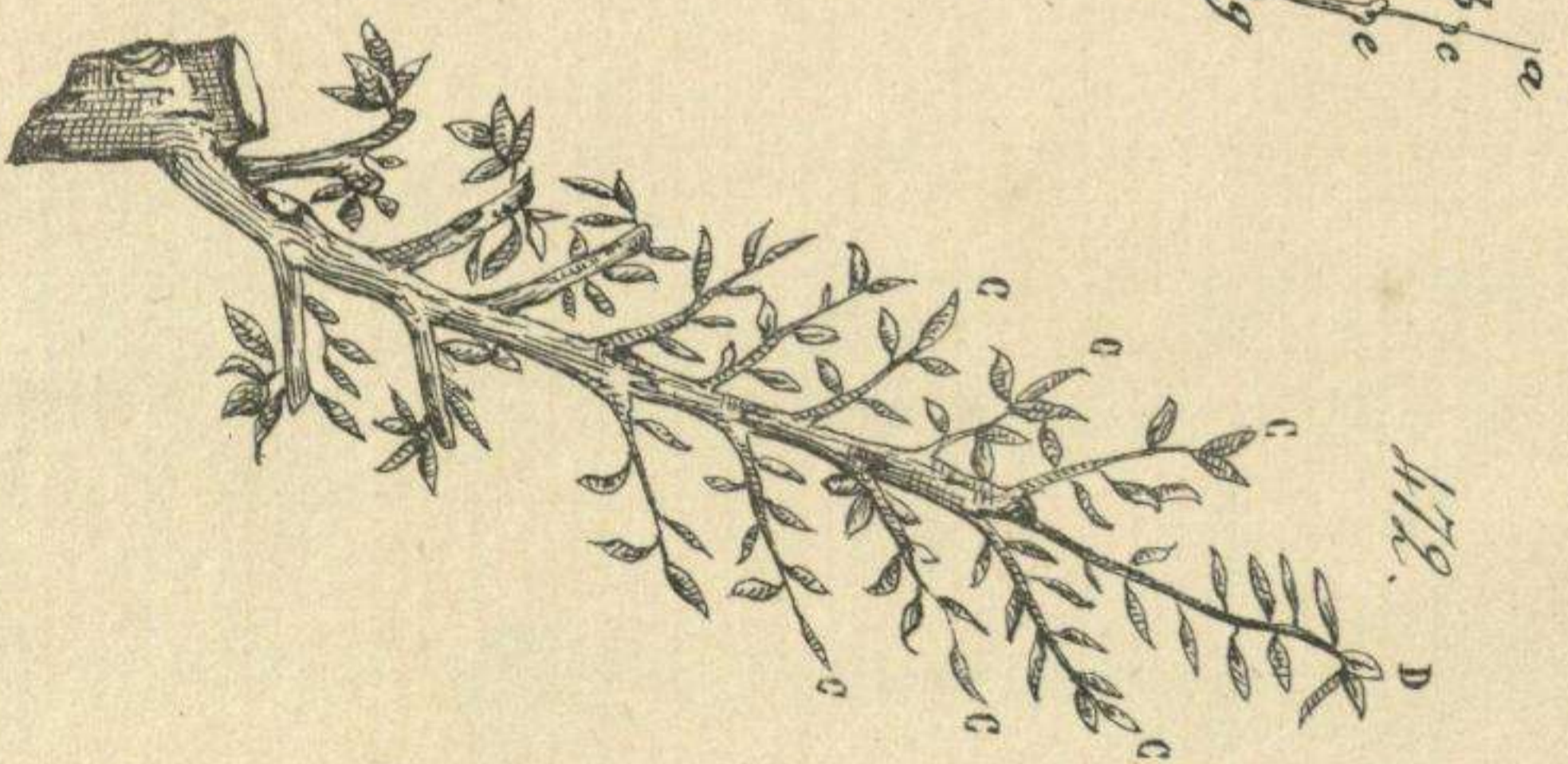
467.



B



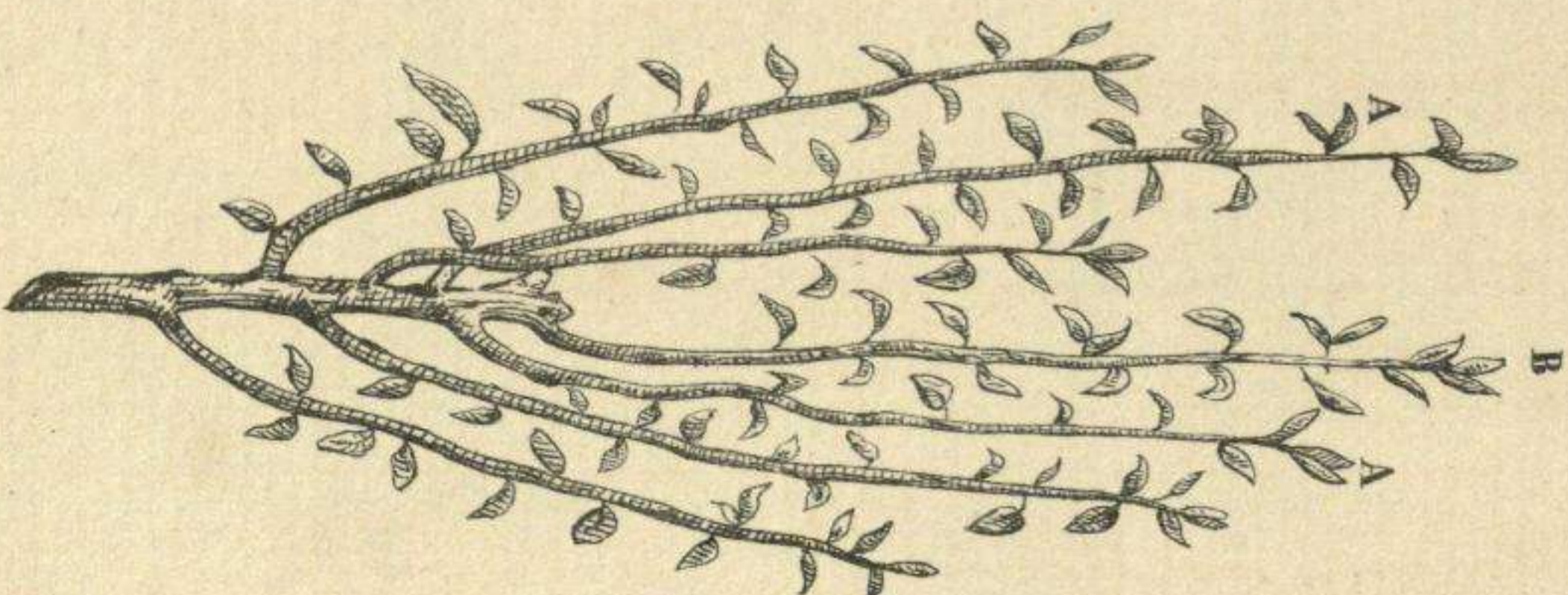
470.



468.

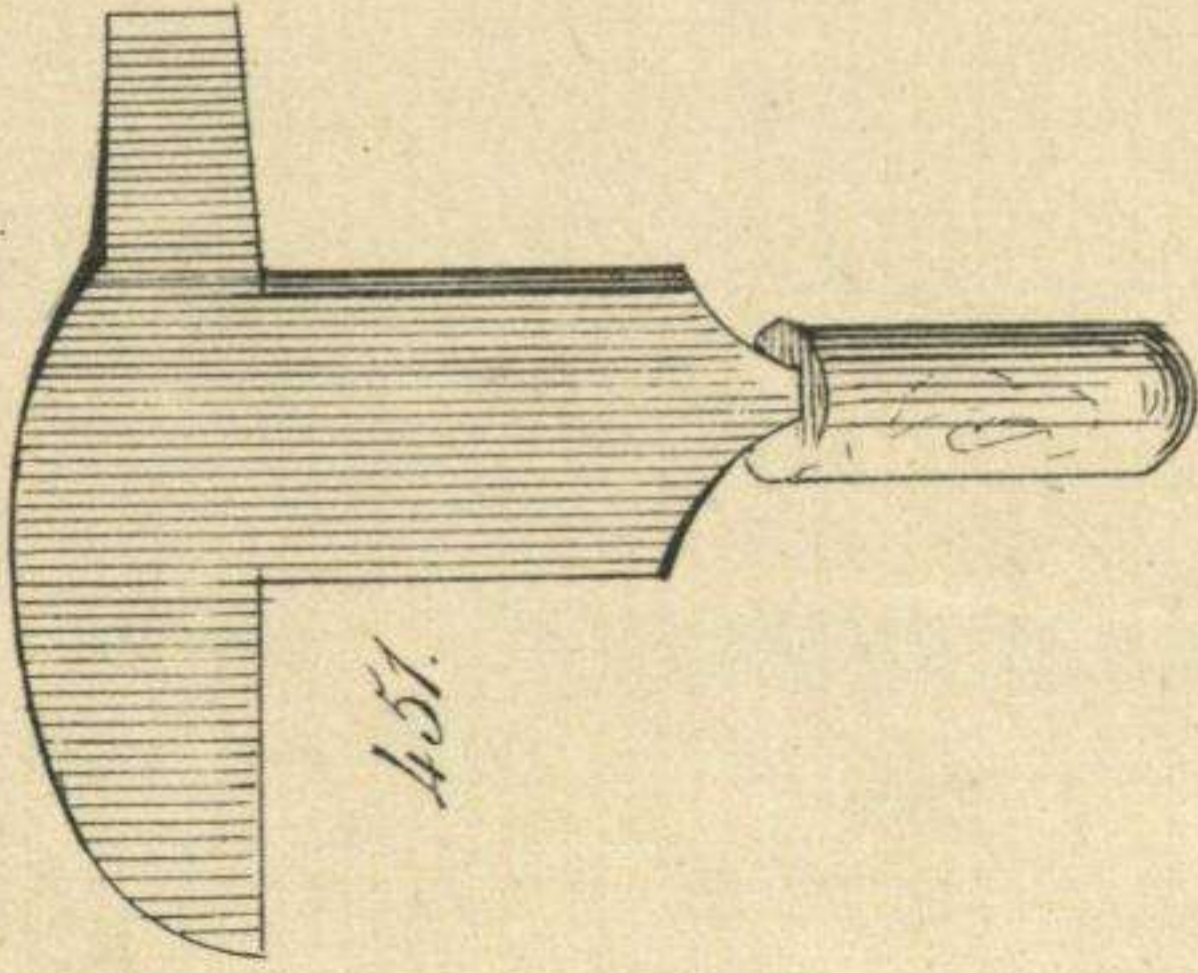


472.

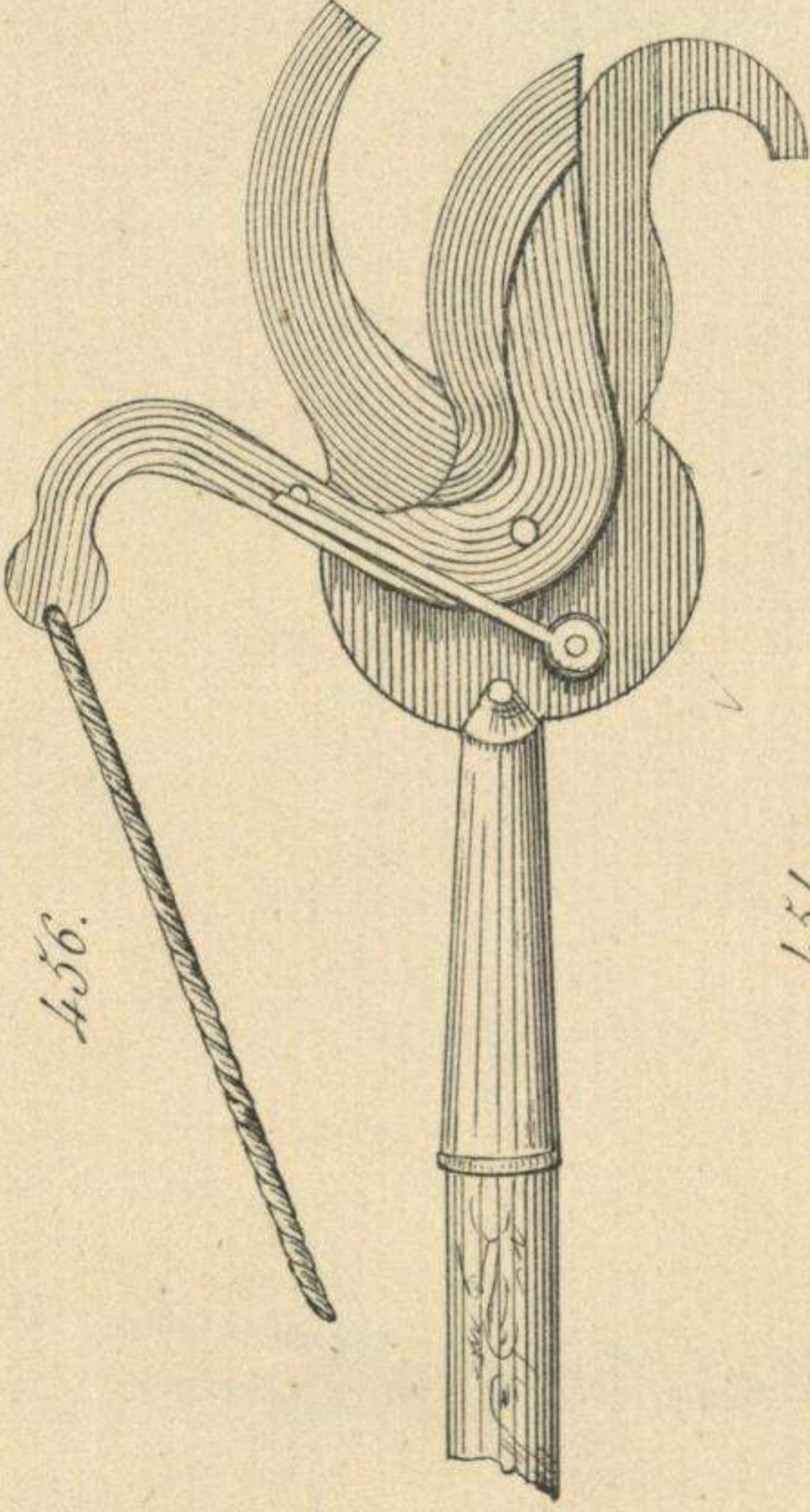


471.

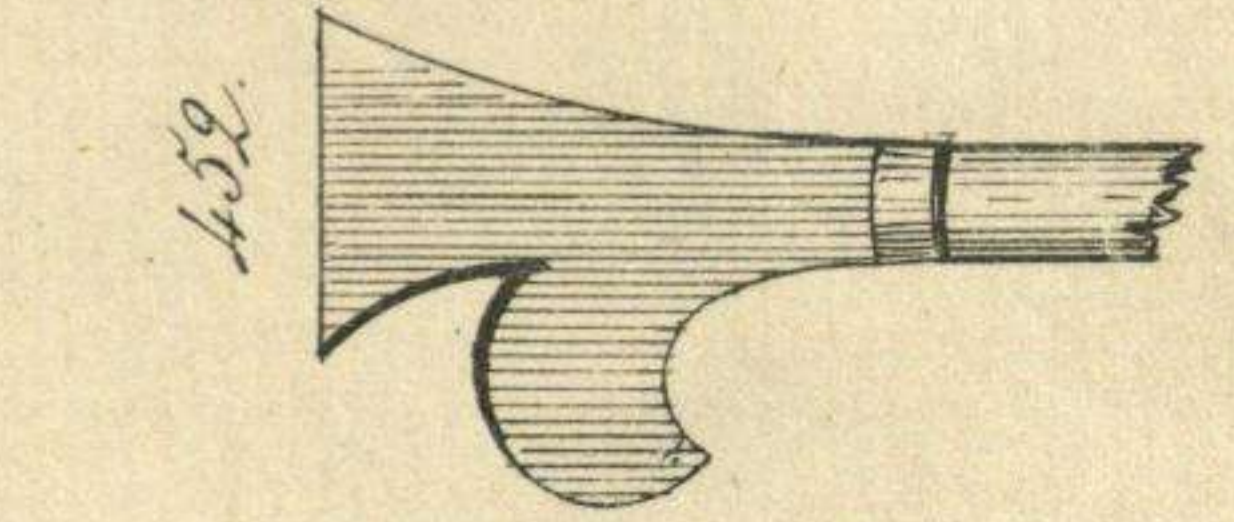




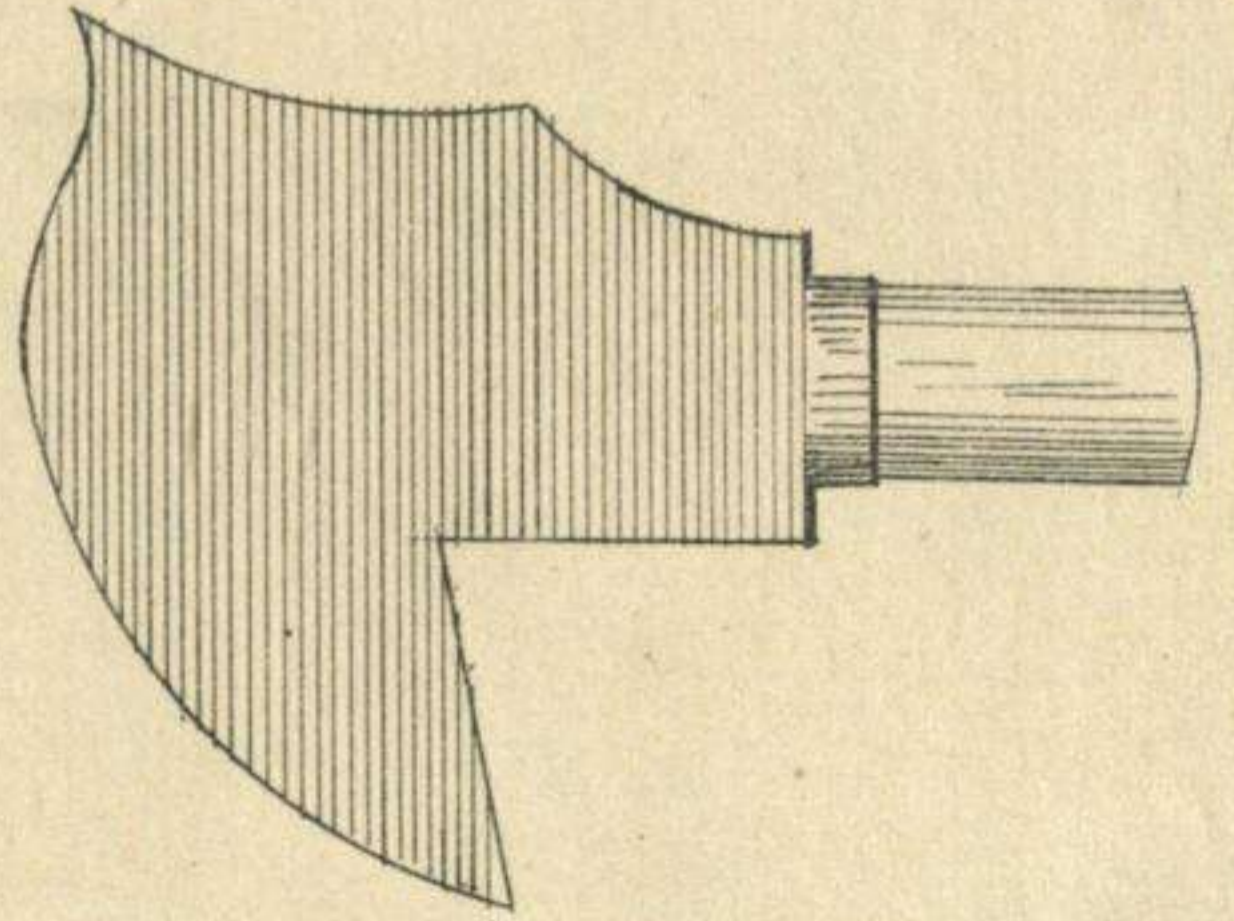
451.



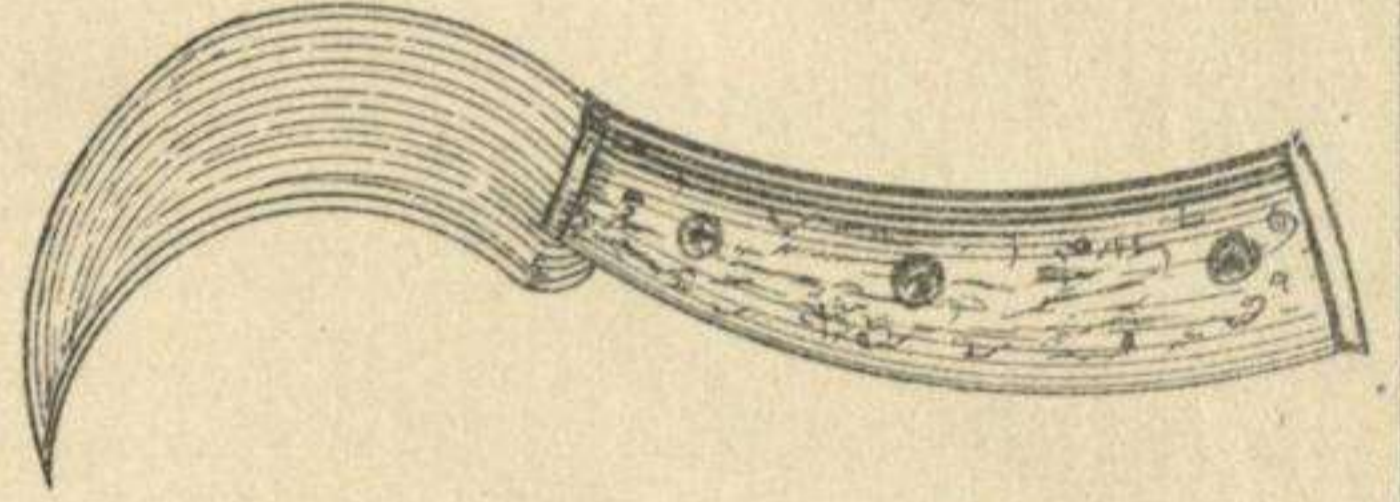
456.



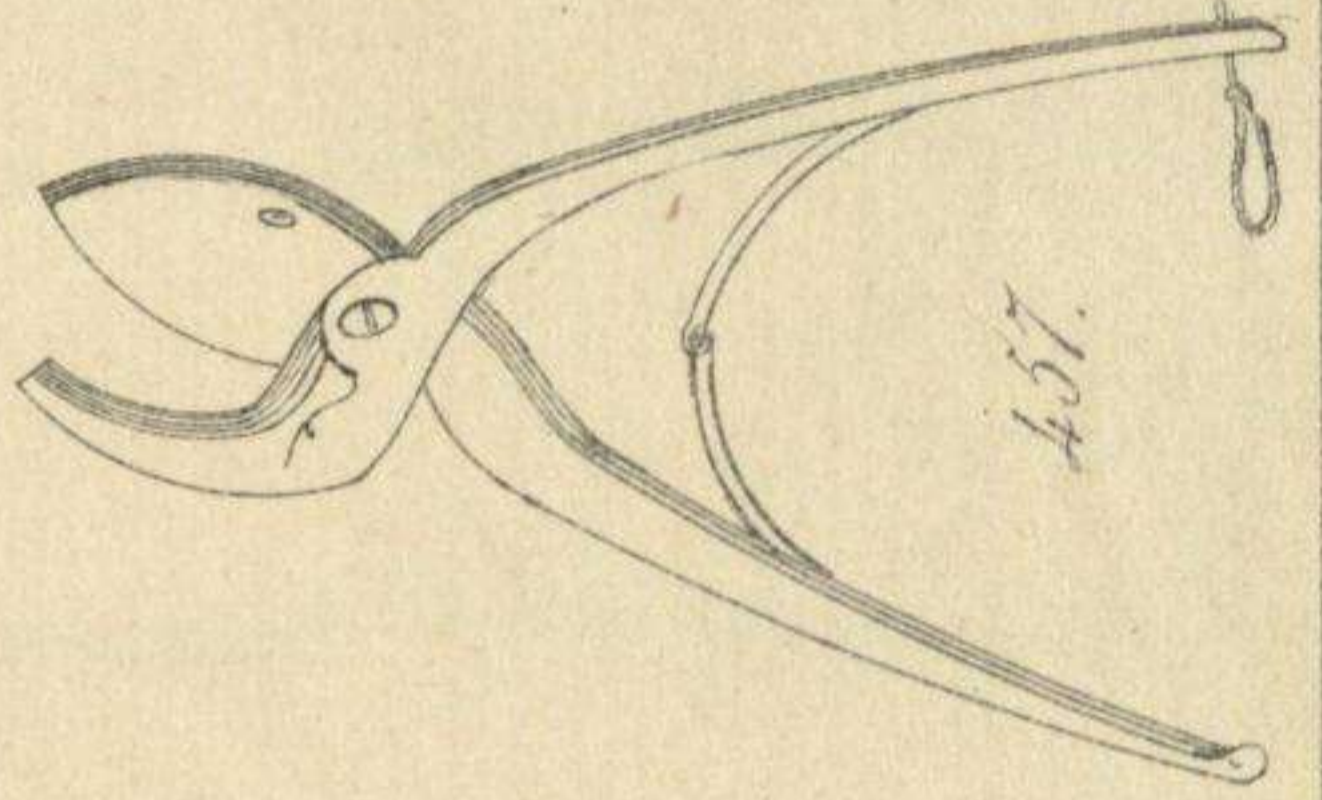
452.



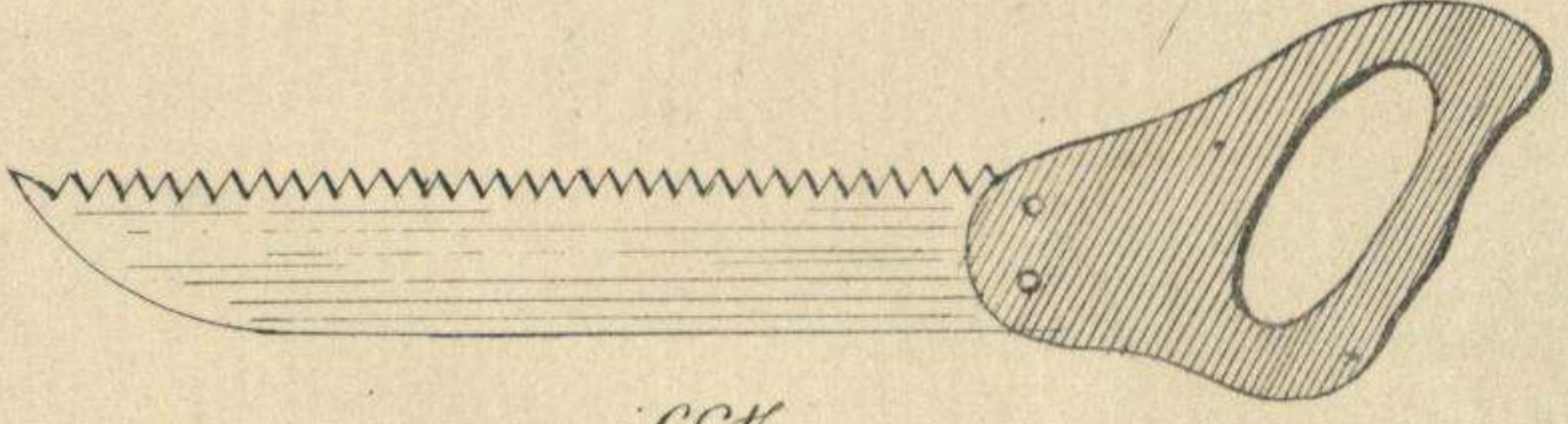
453.



454.



457.



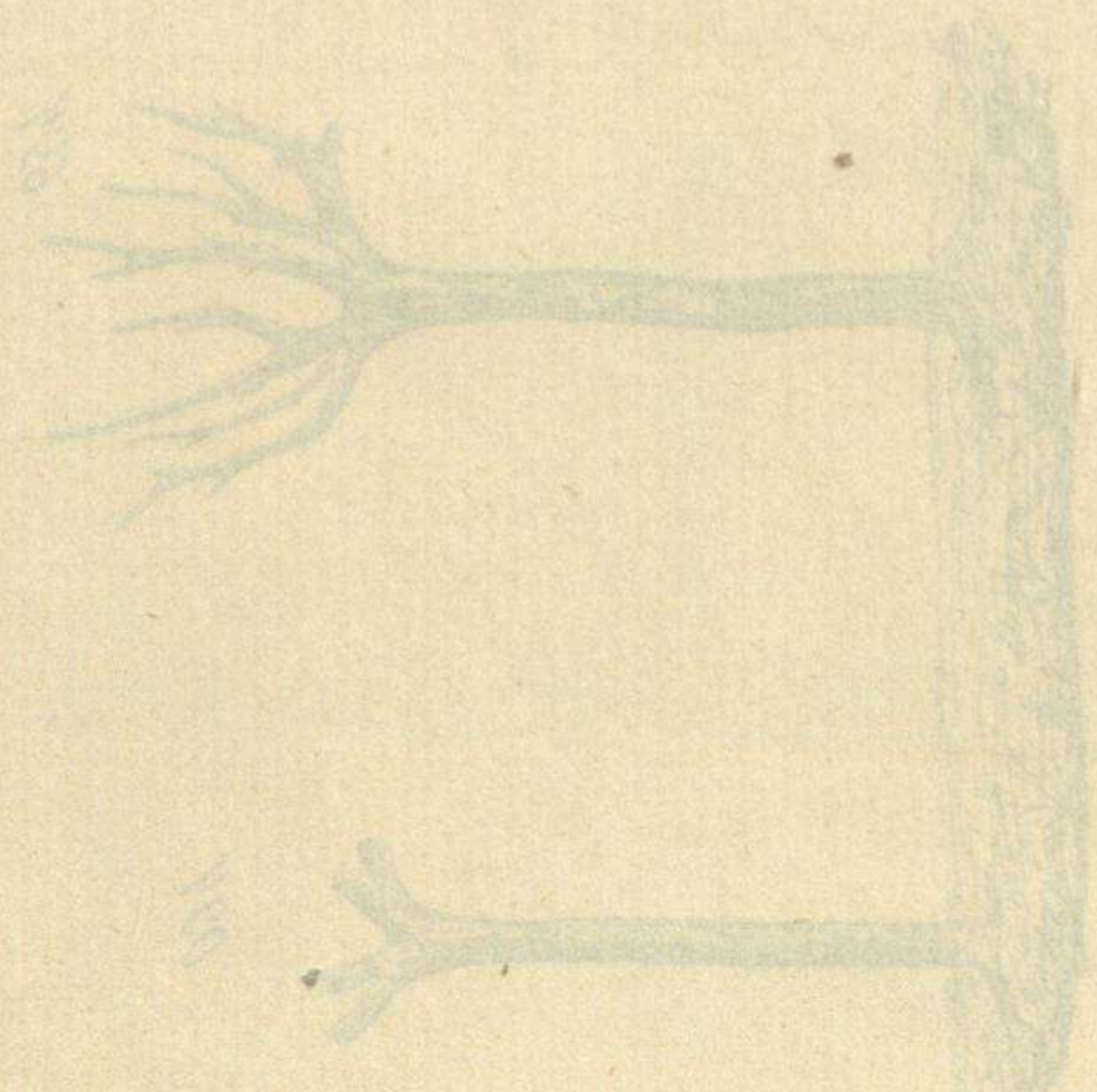
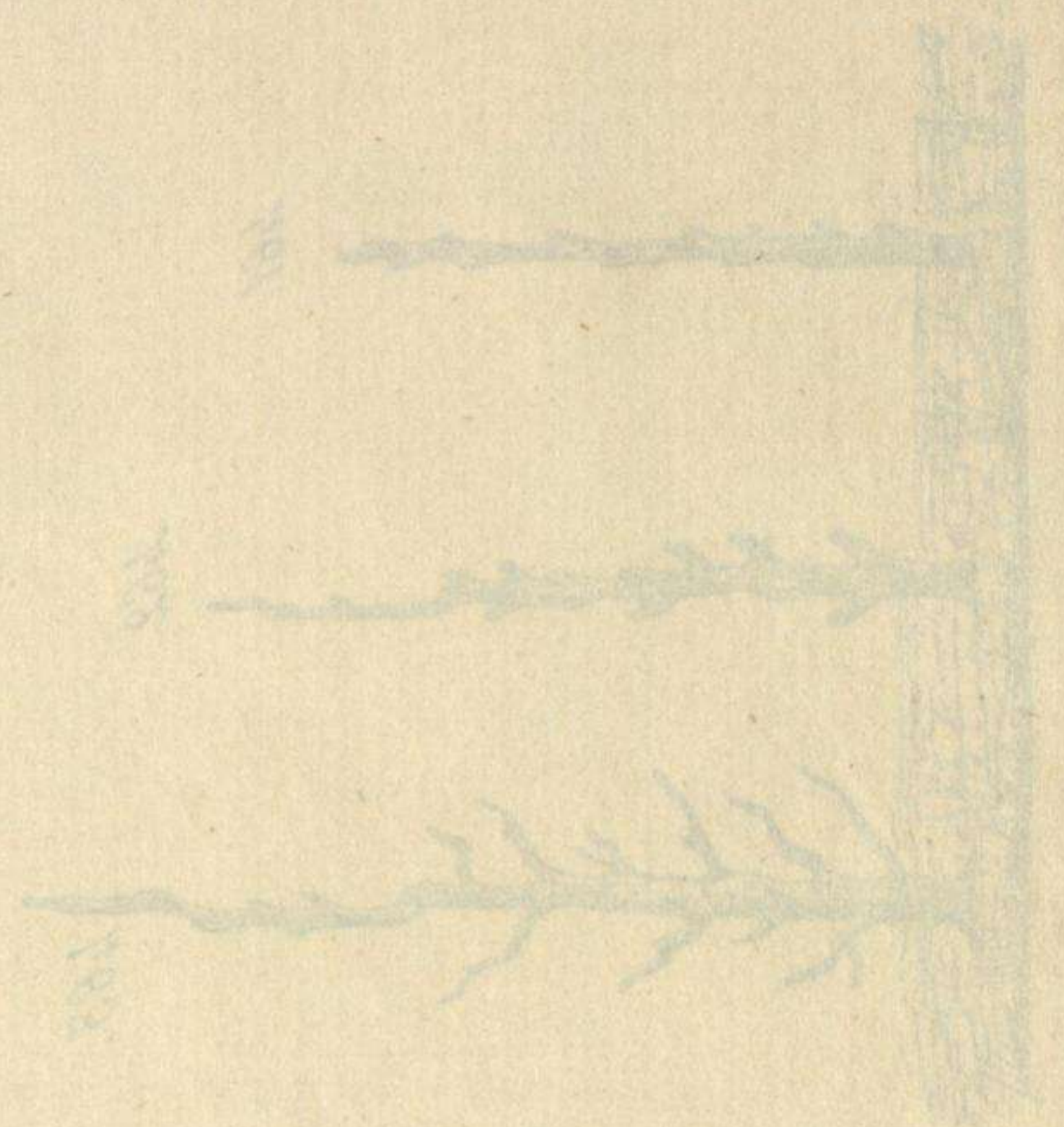
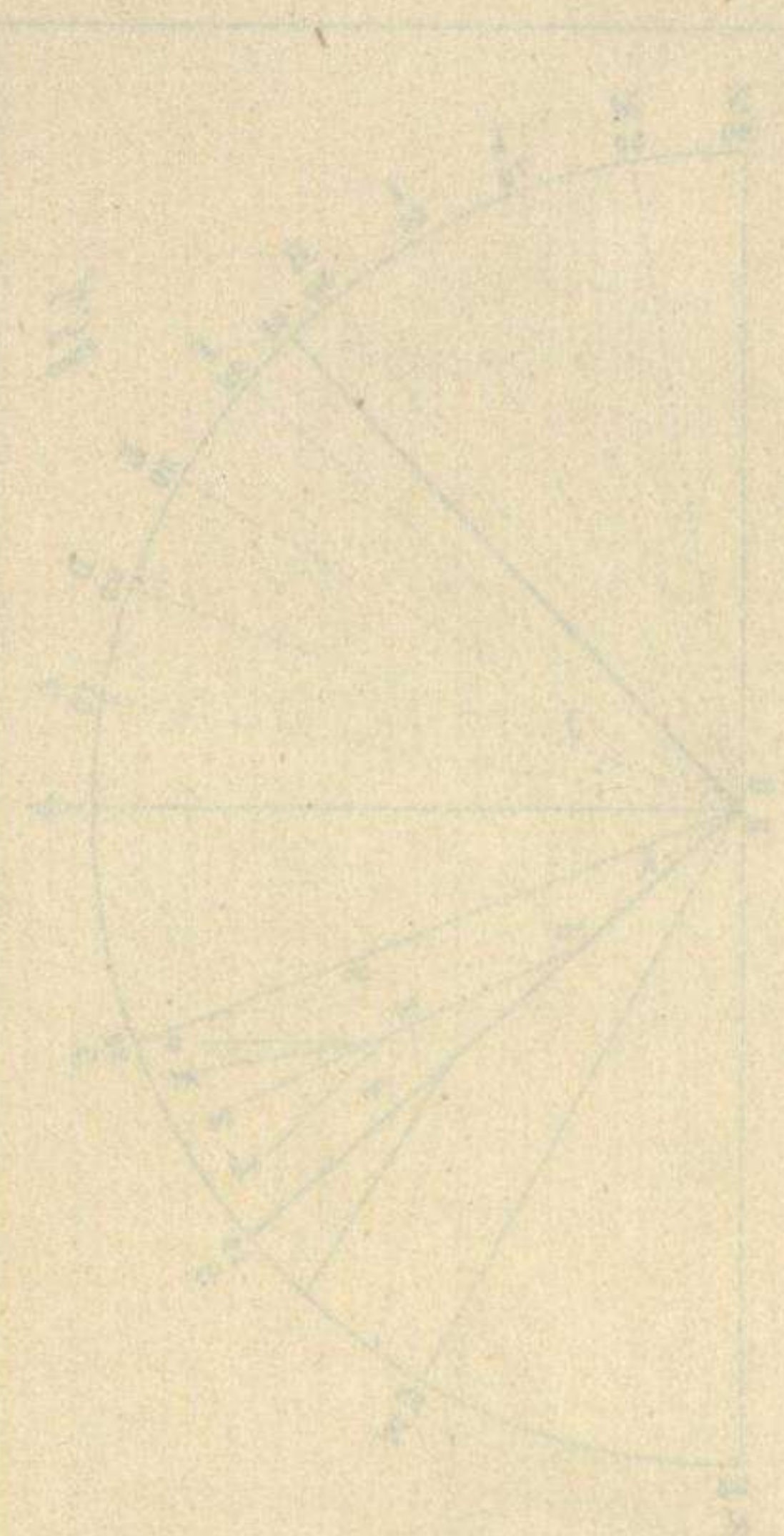
455.



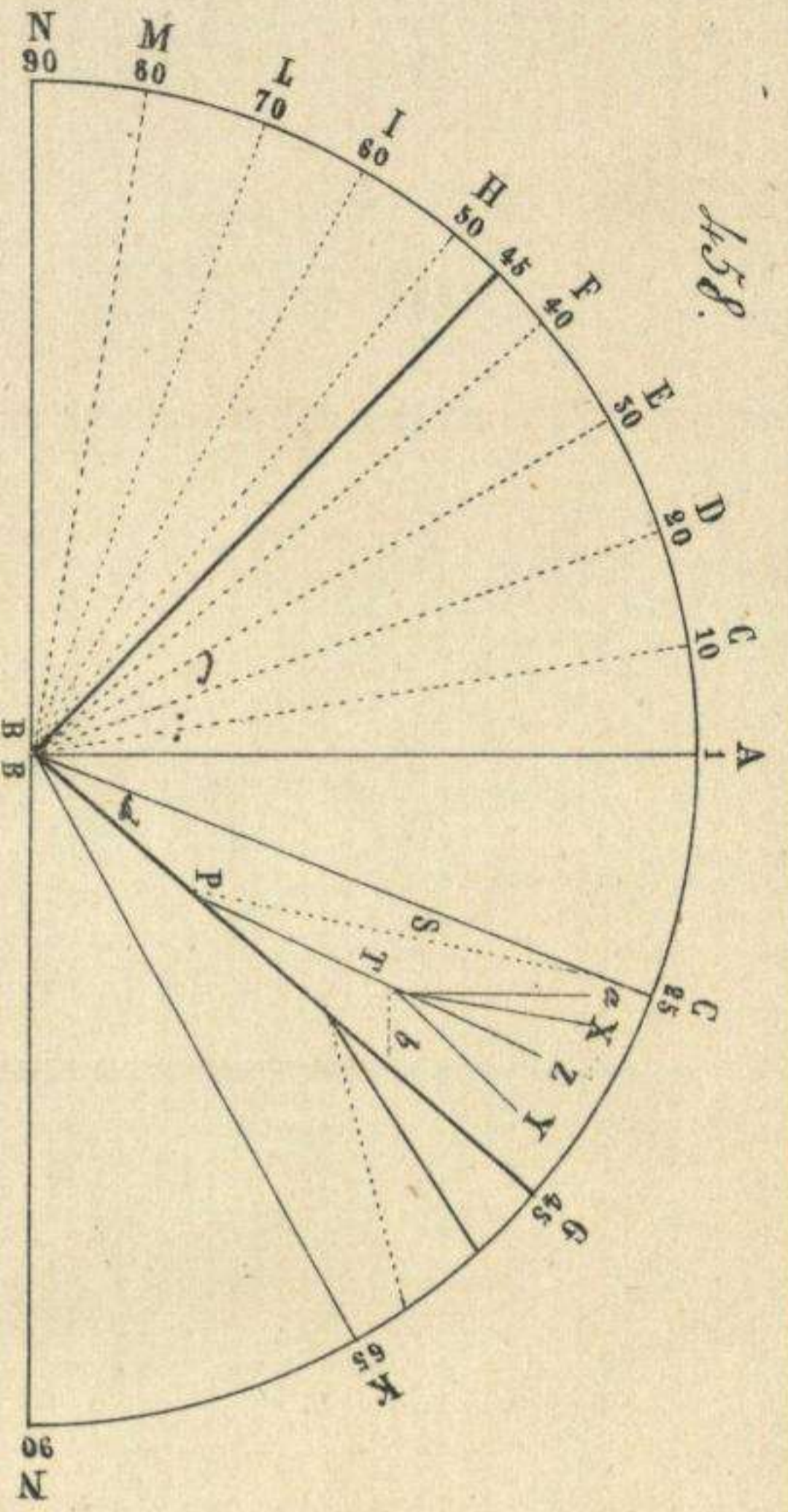




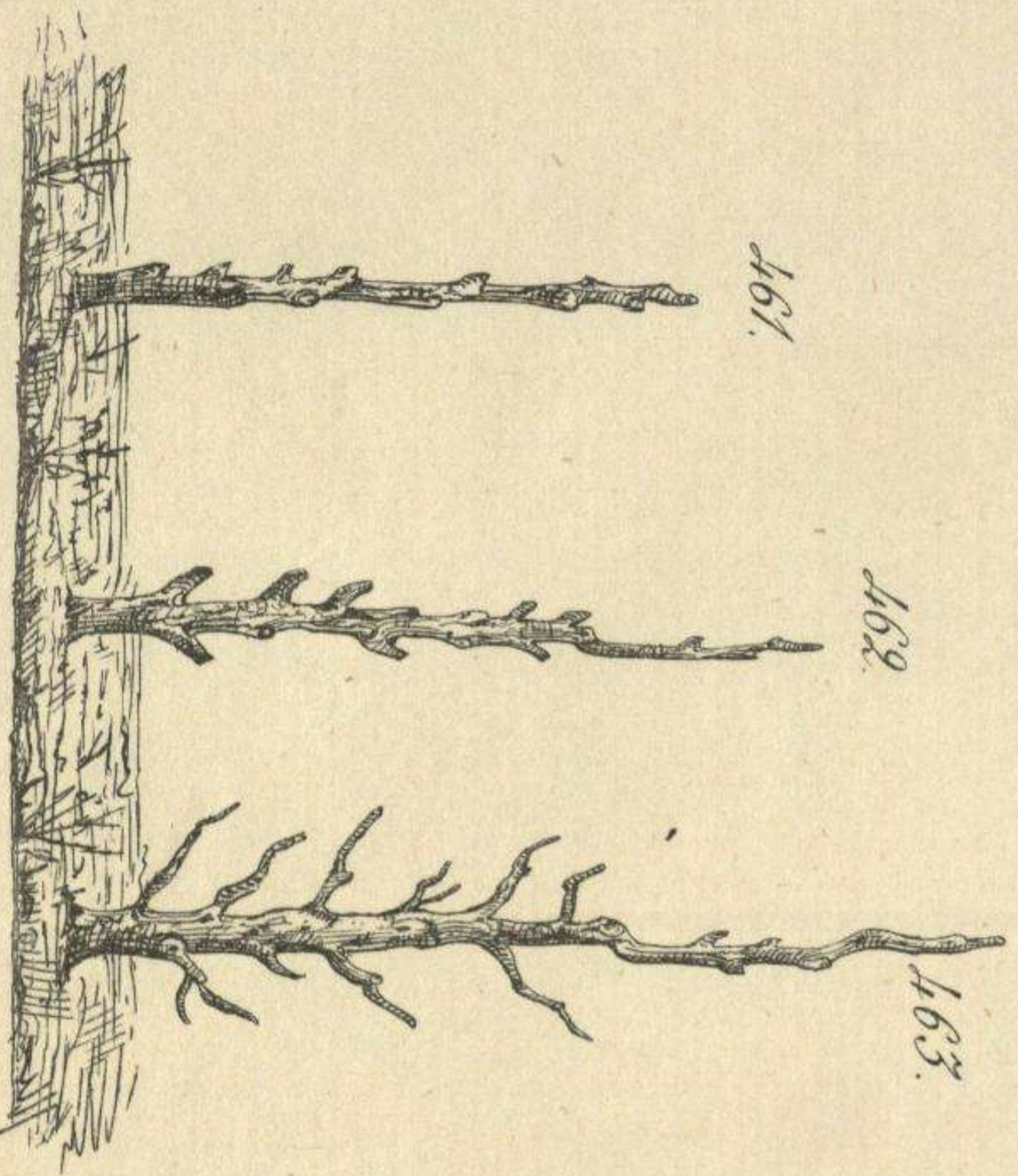
*Quercus sp. pubescens*







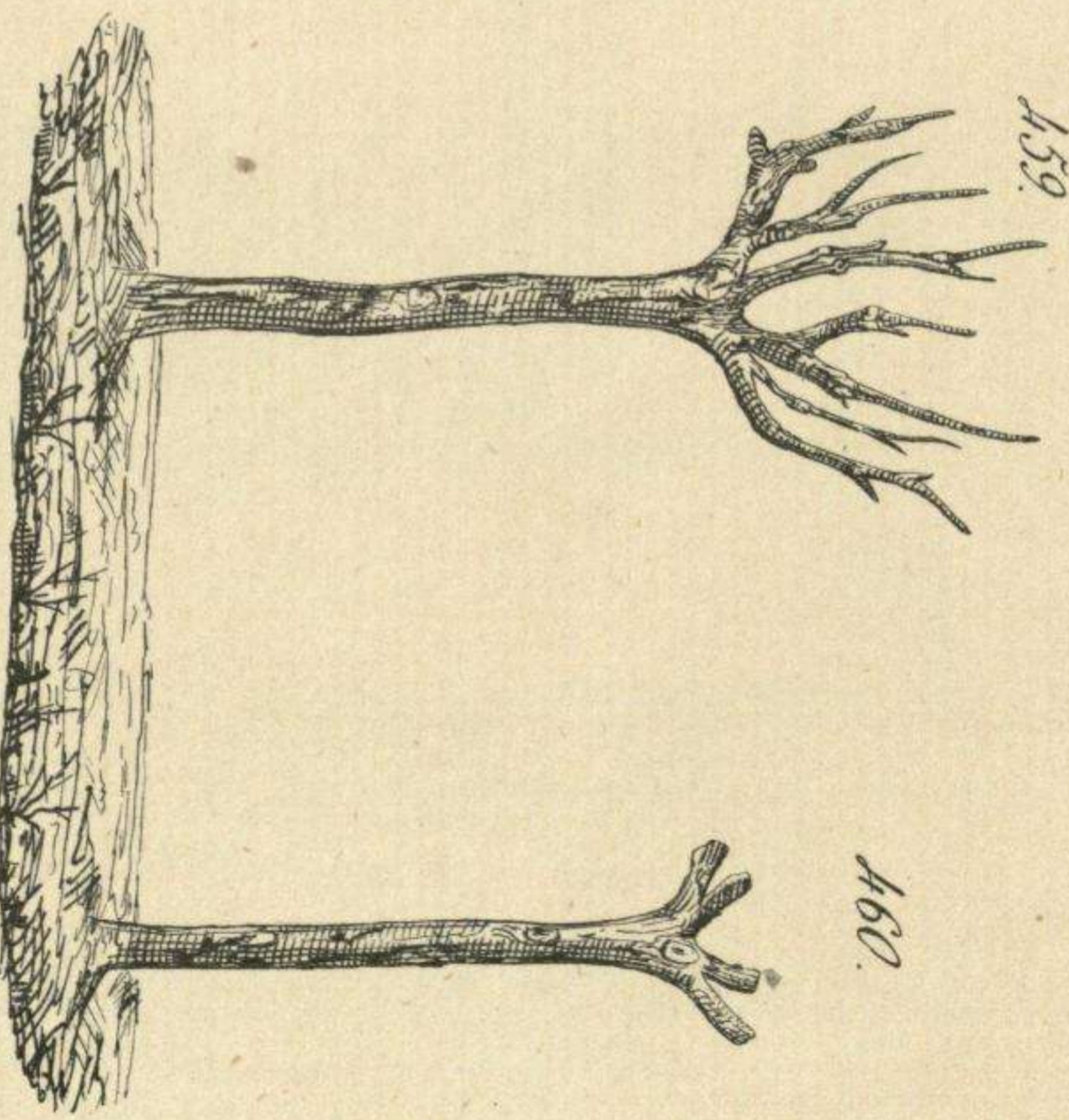
458.



461.

462.

463.

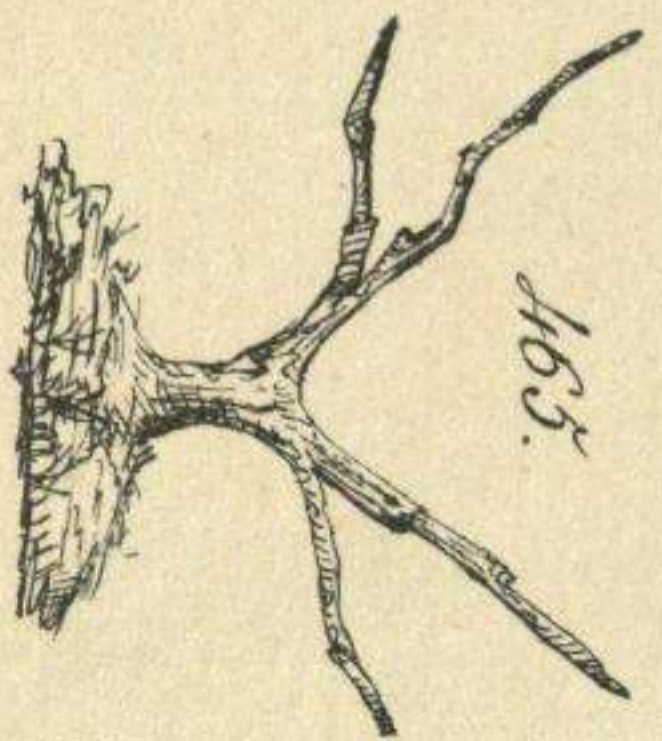


459.

460.



464.



465.





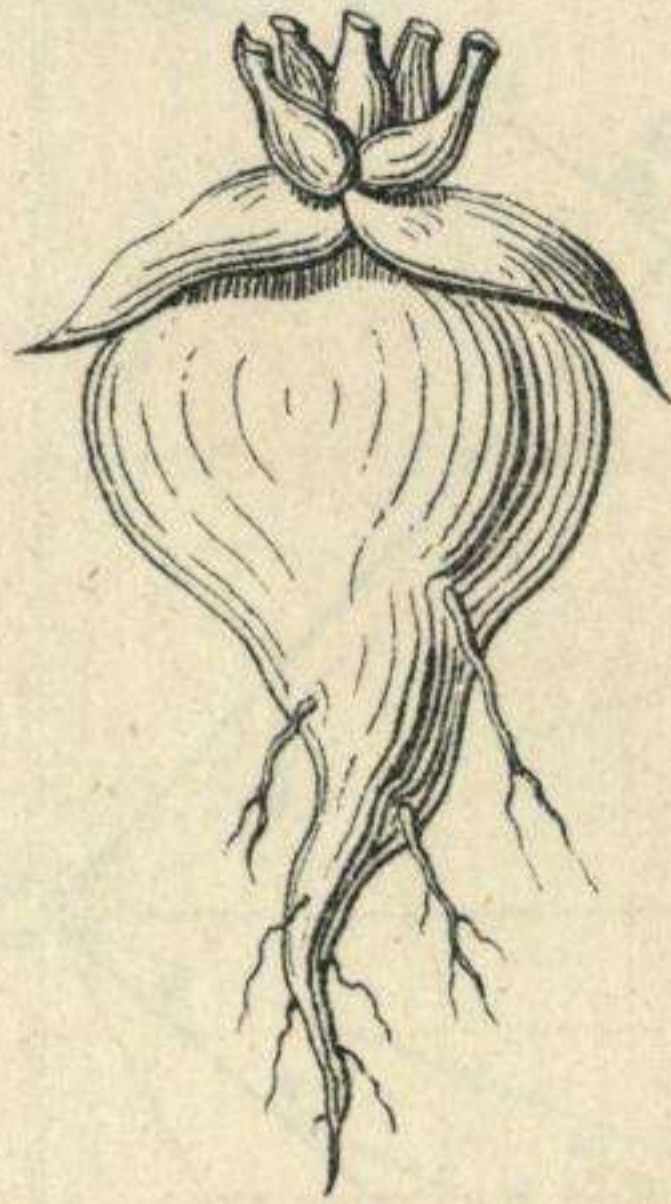


Diccionario de Agricultura.

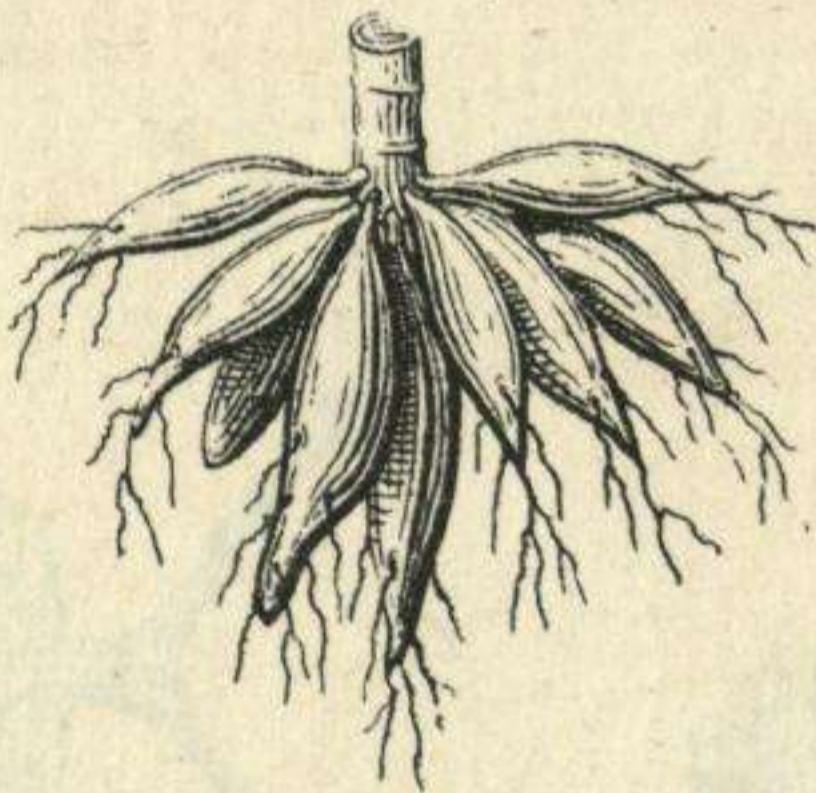
473.



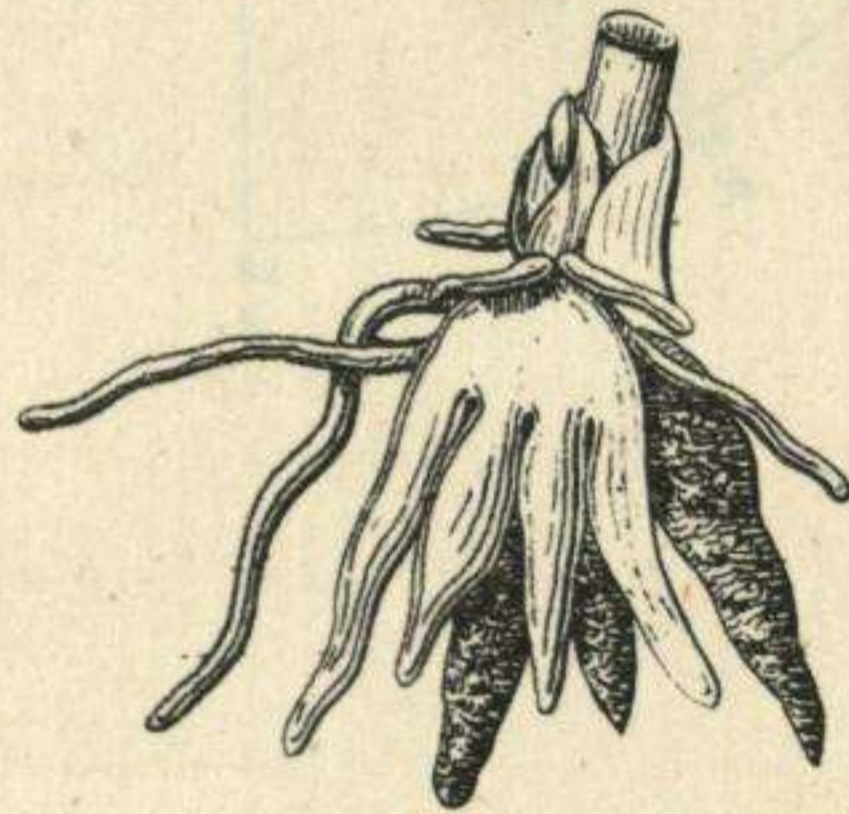
474.



475.



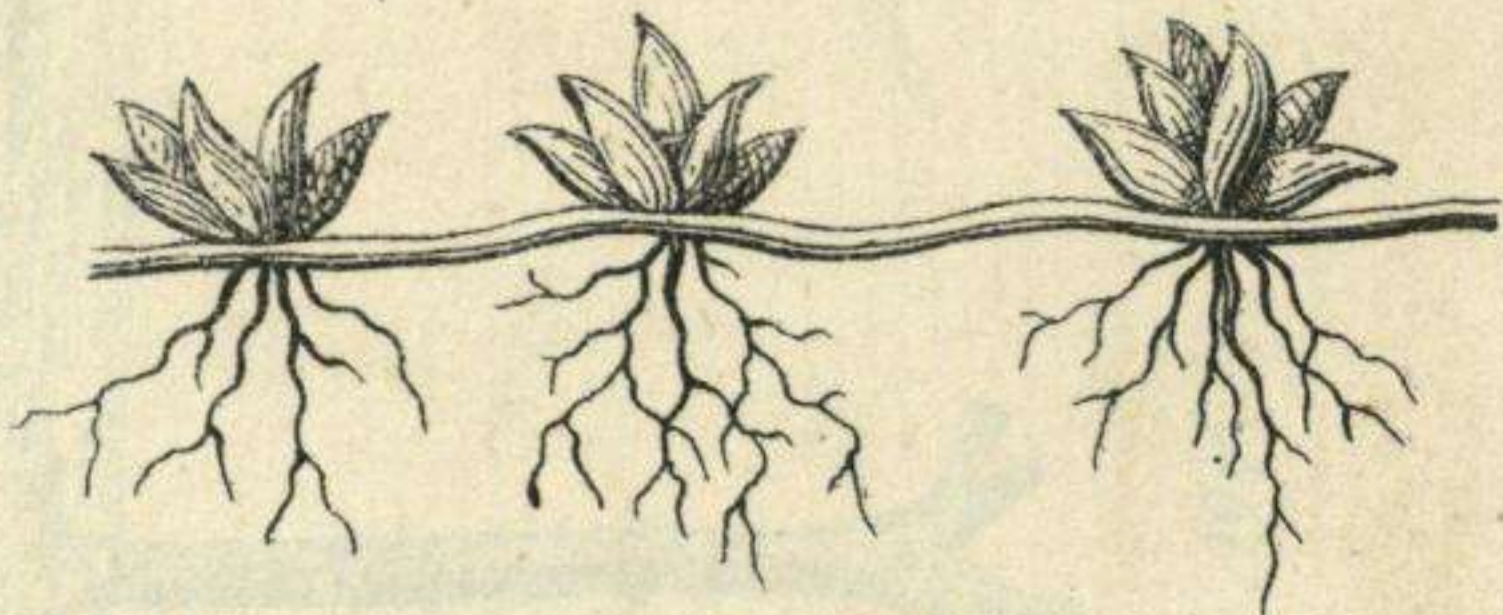
477.



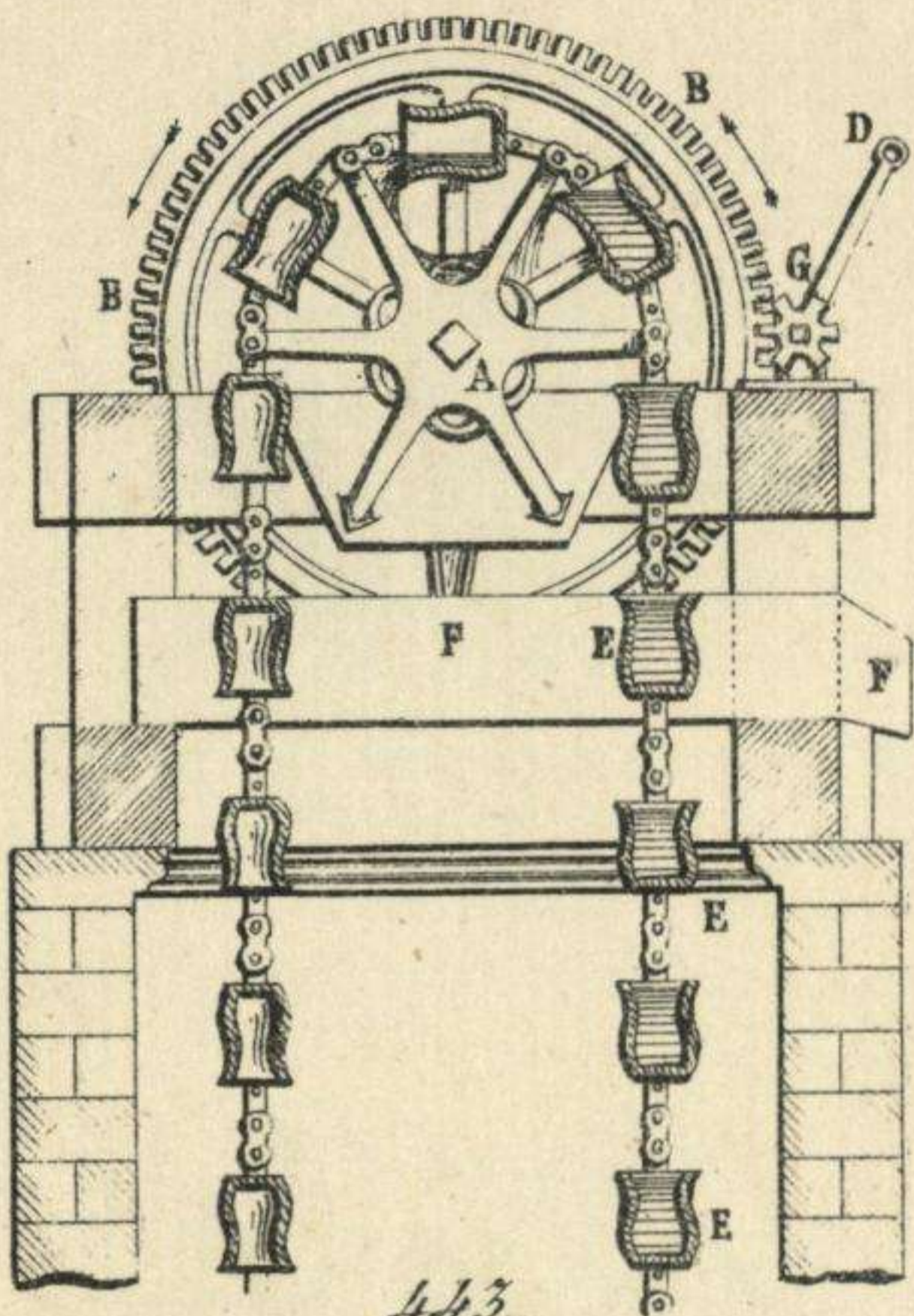
476.



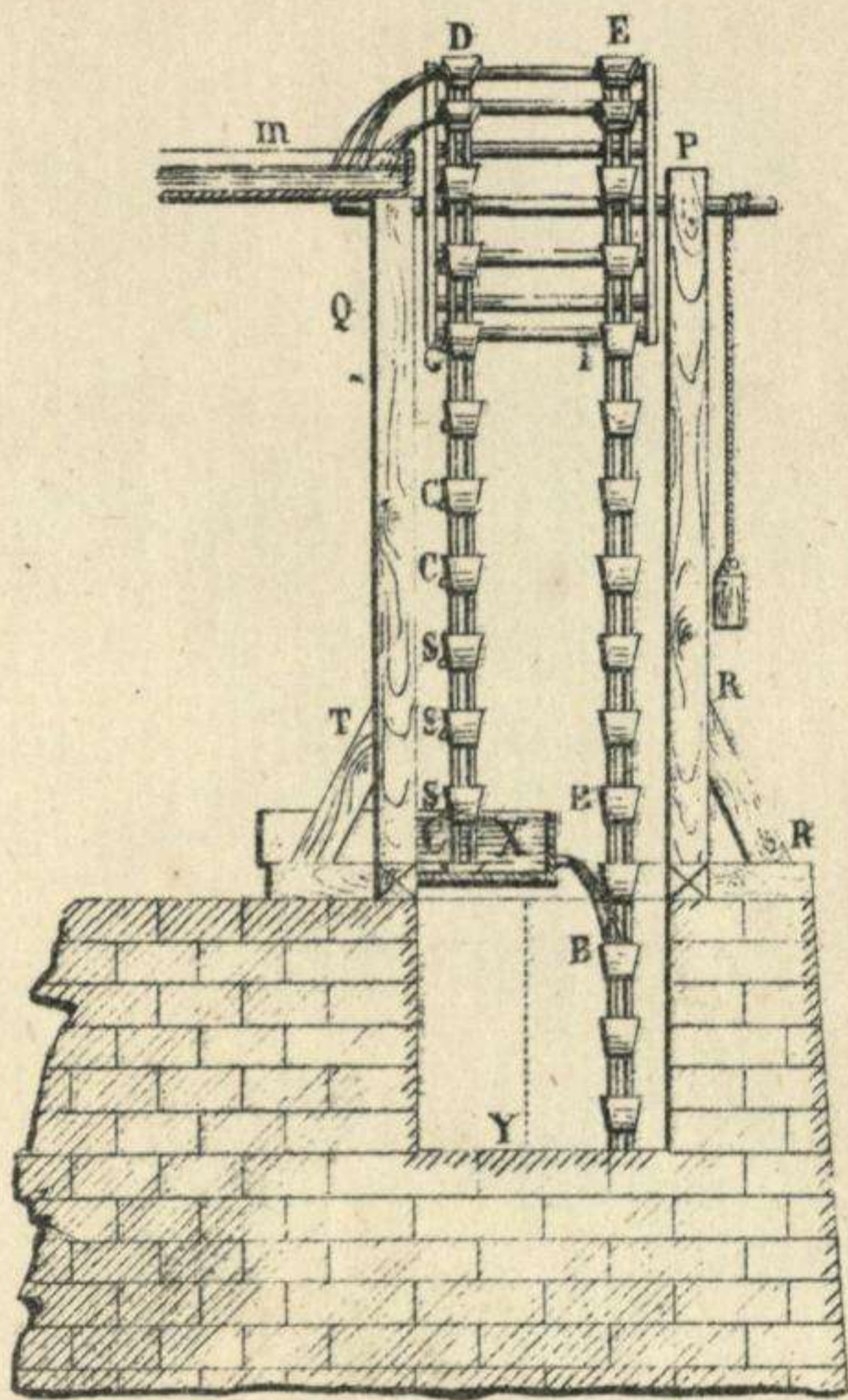
478.





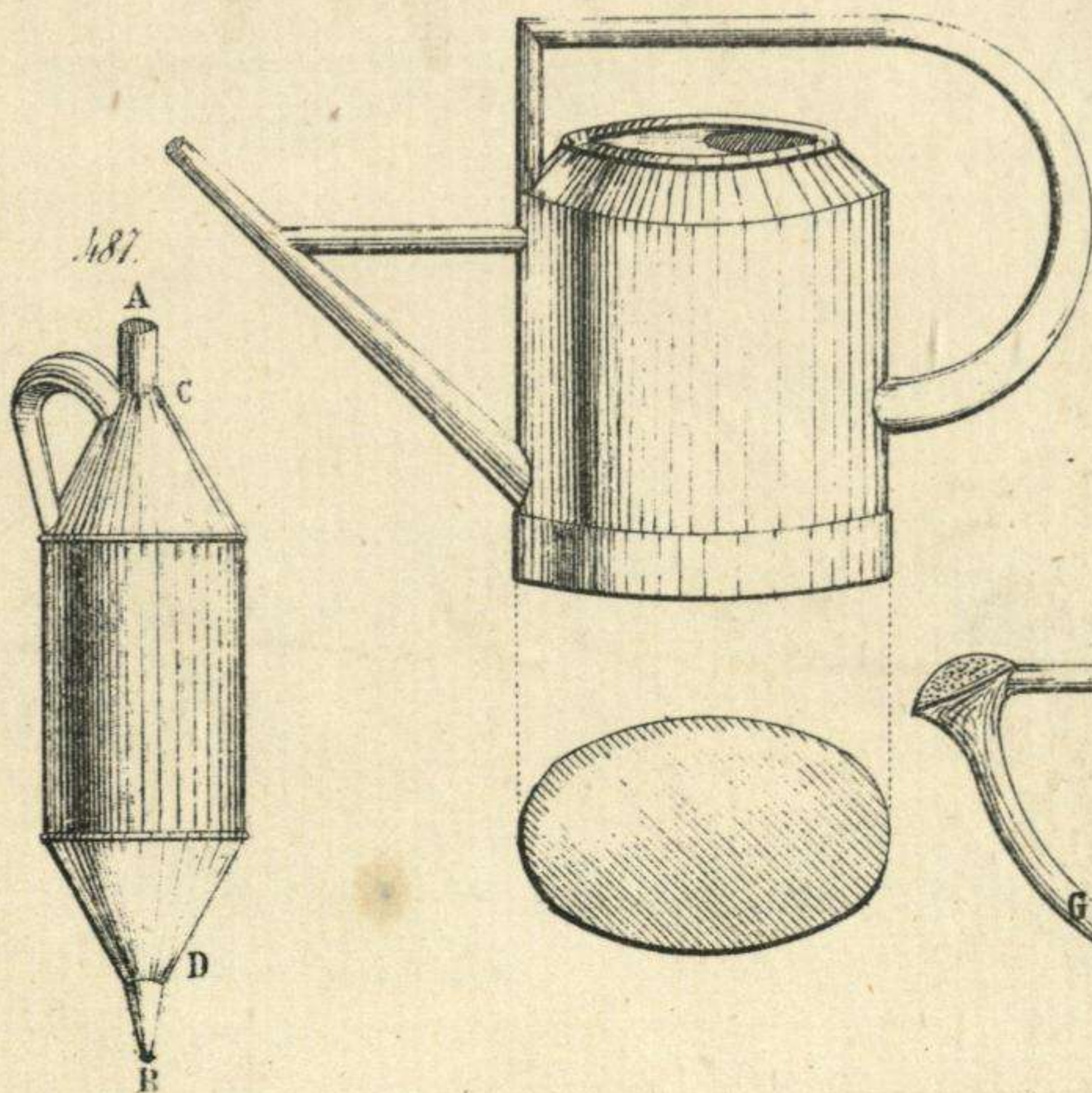


443.



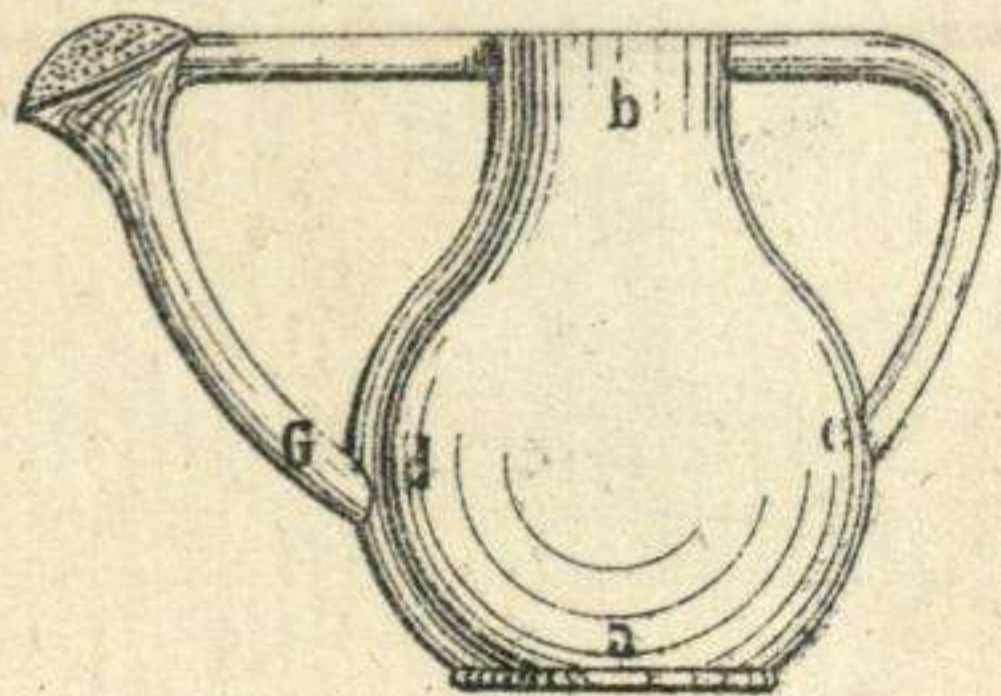
444.

486.



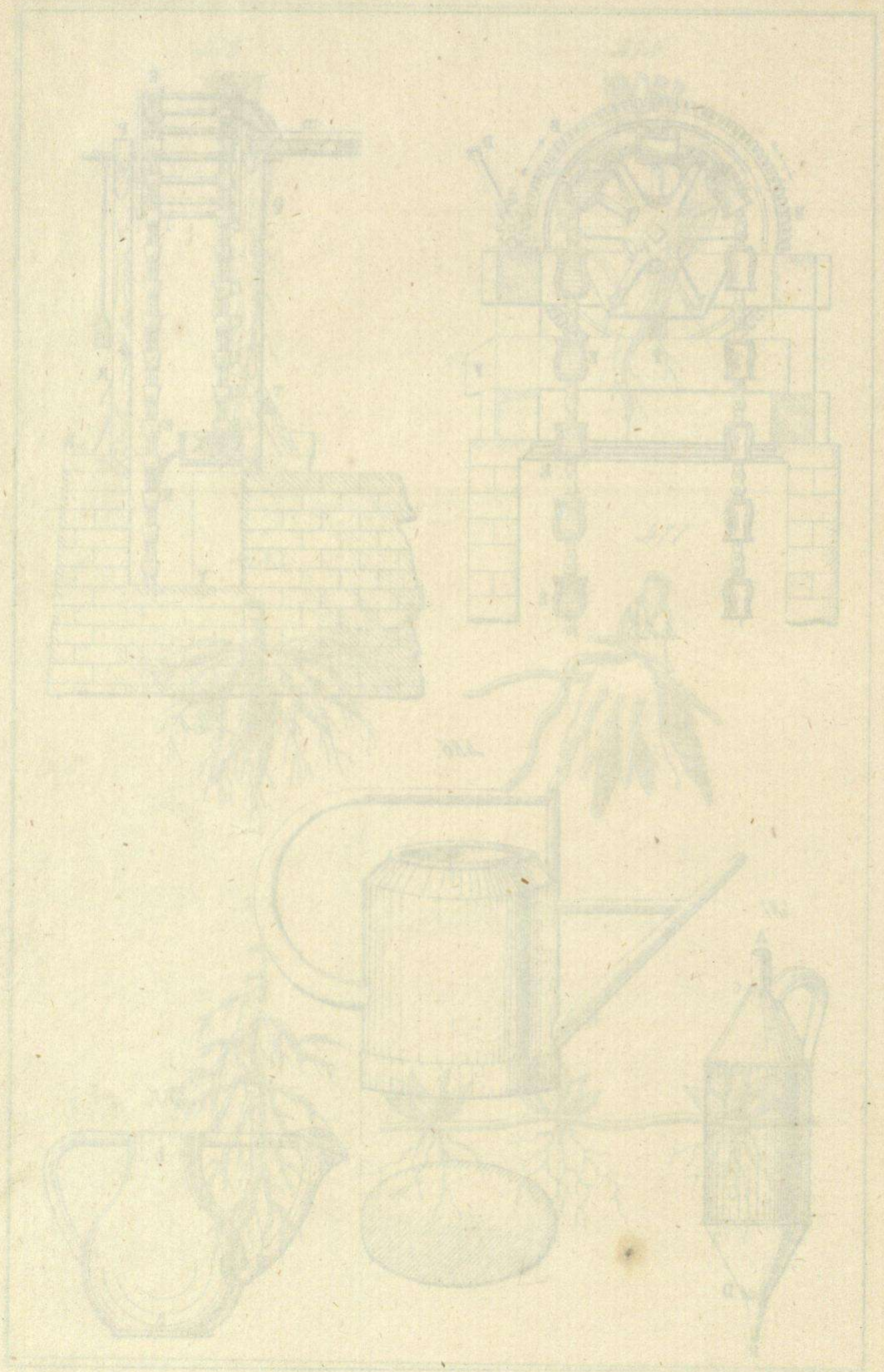
487.

485.





Wasserkraft zur Papiermühle

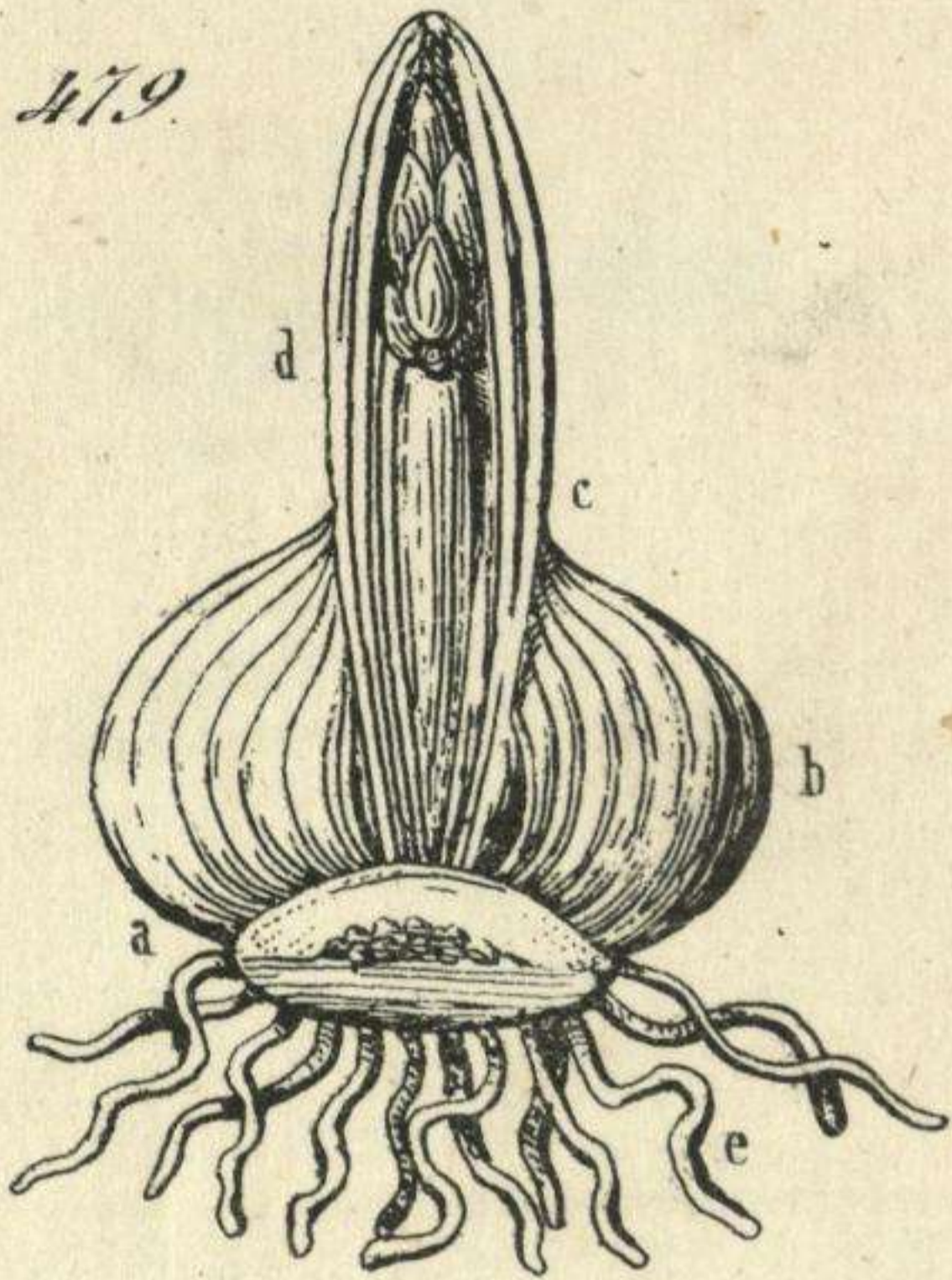




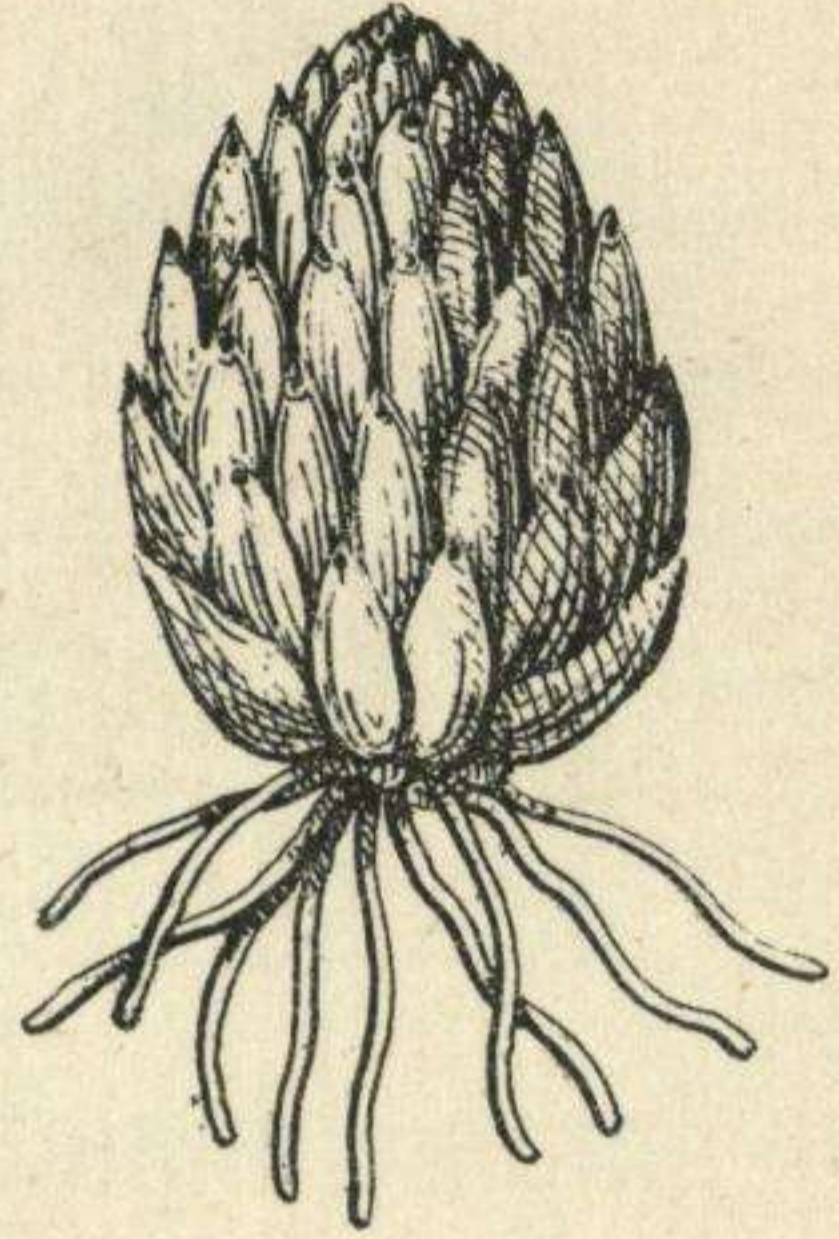




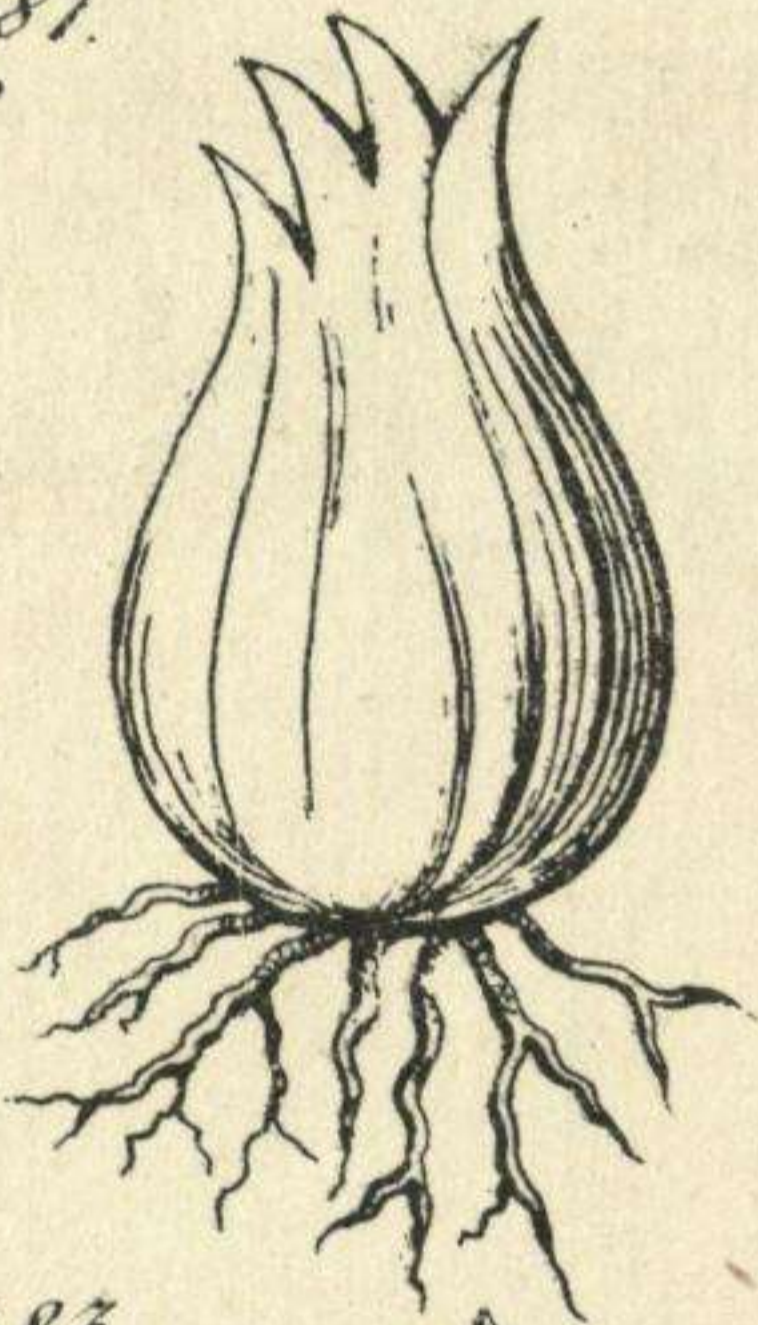
479.



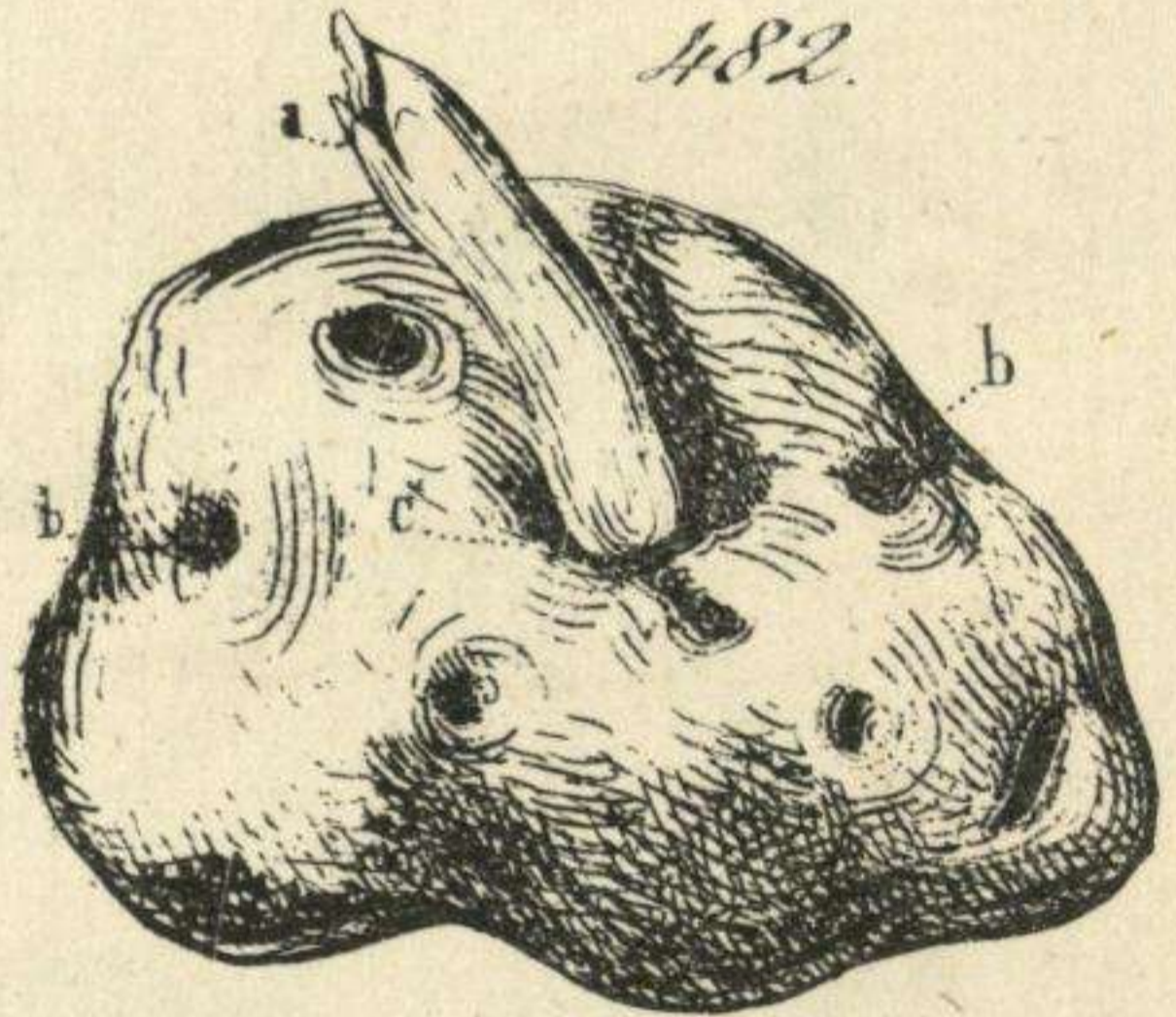
480.



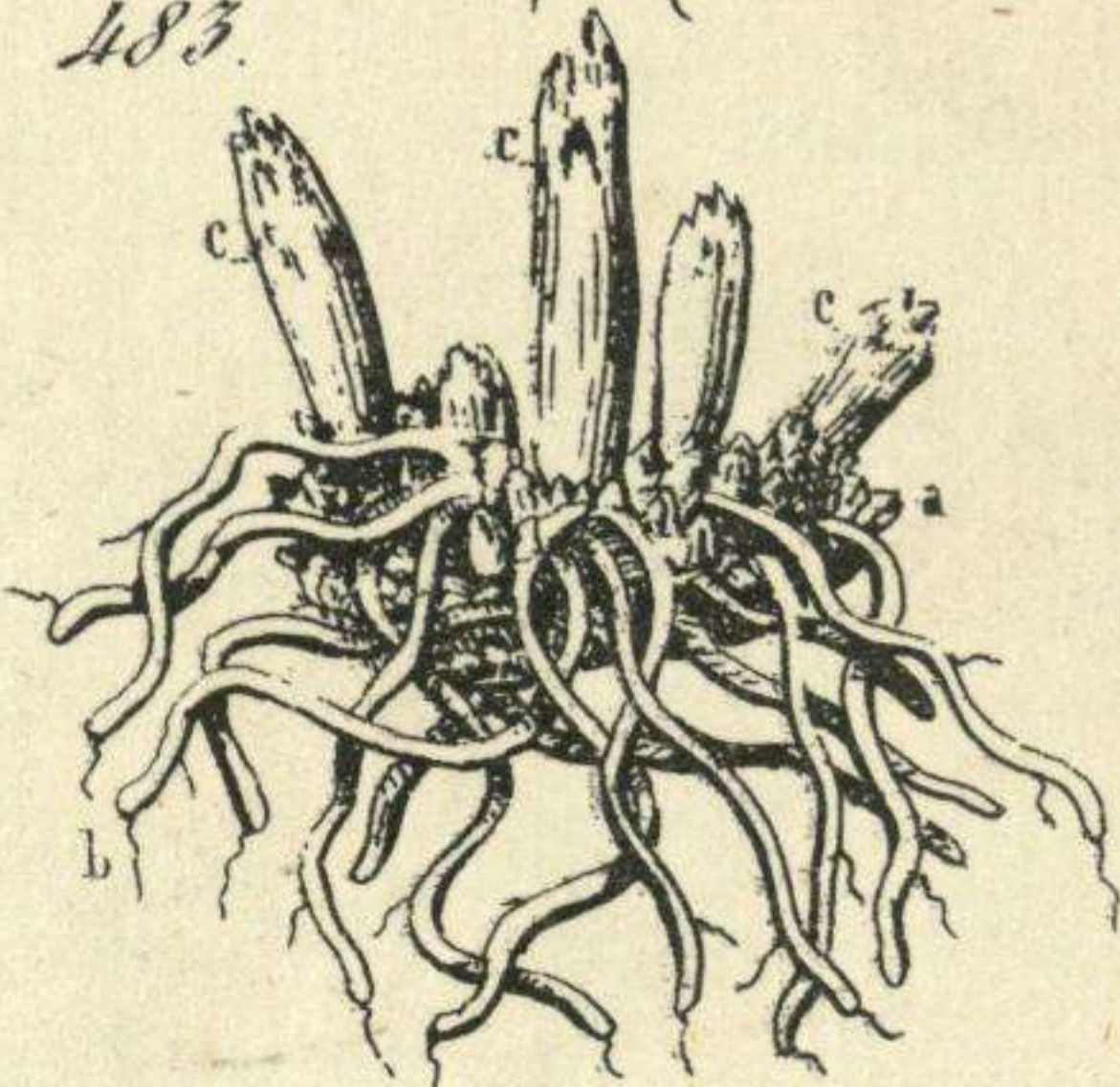
481.



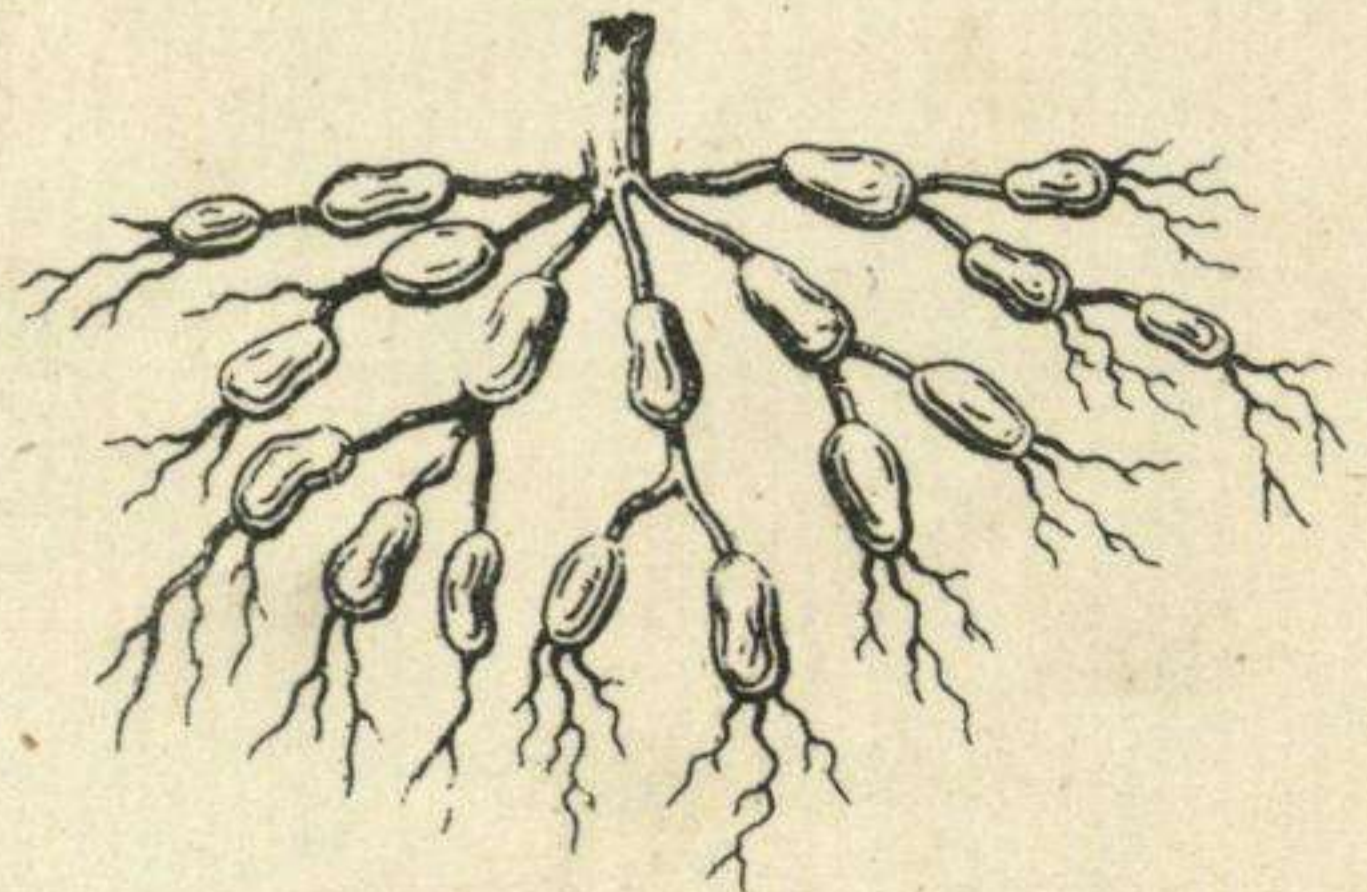
482.



483.

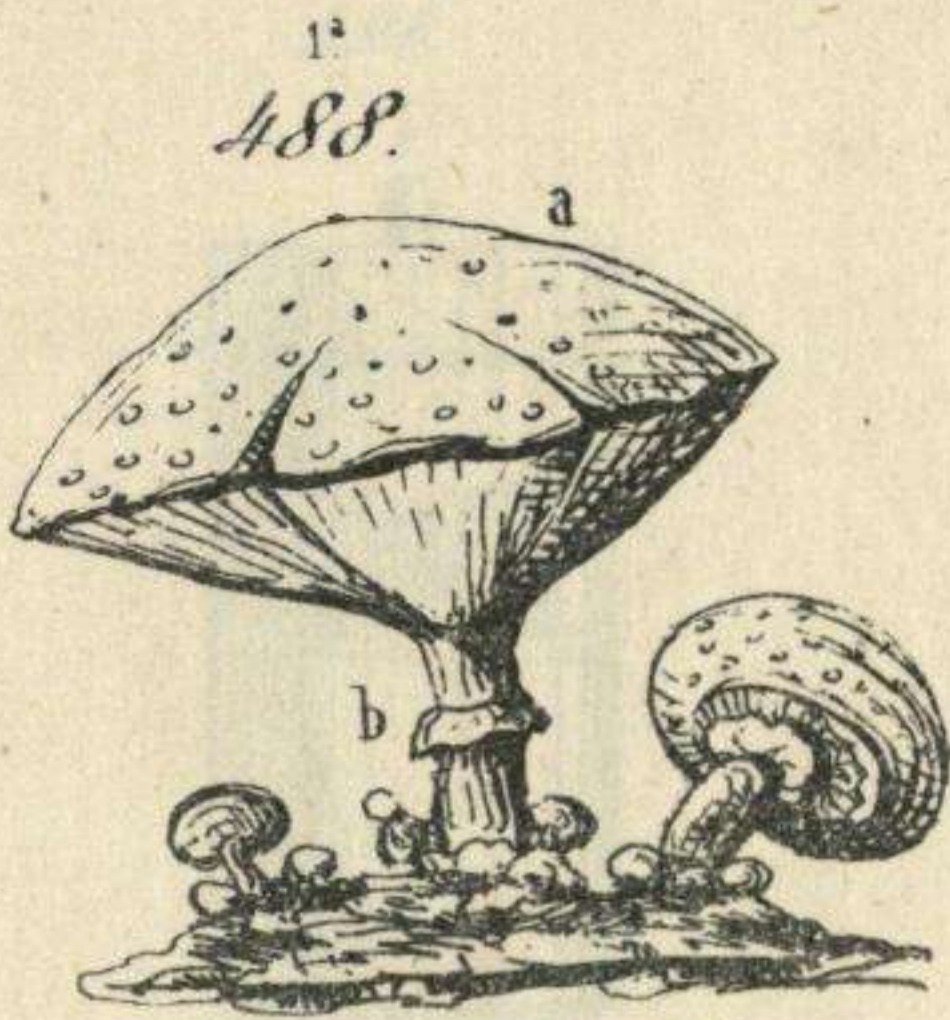


484.





Diccionario de Agricultura.



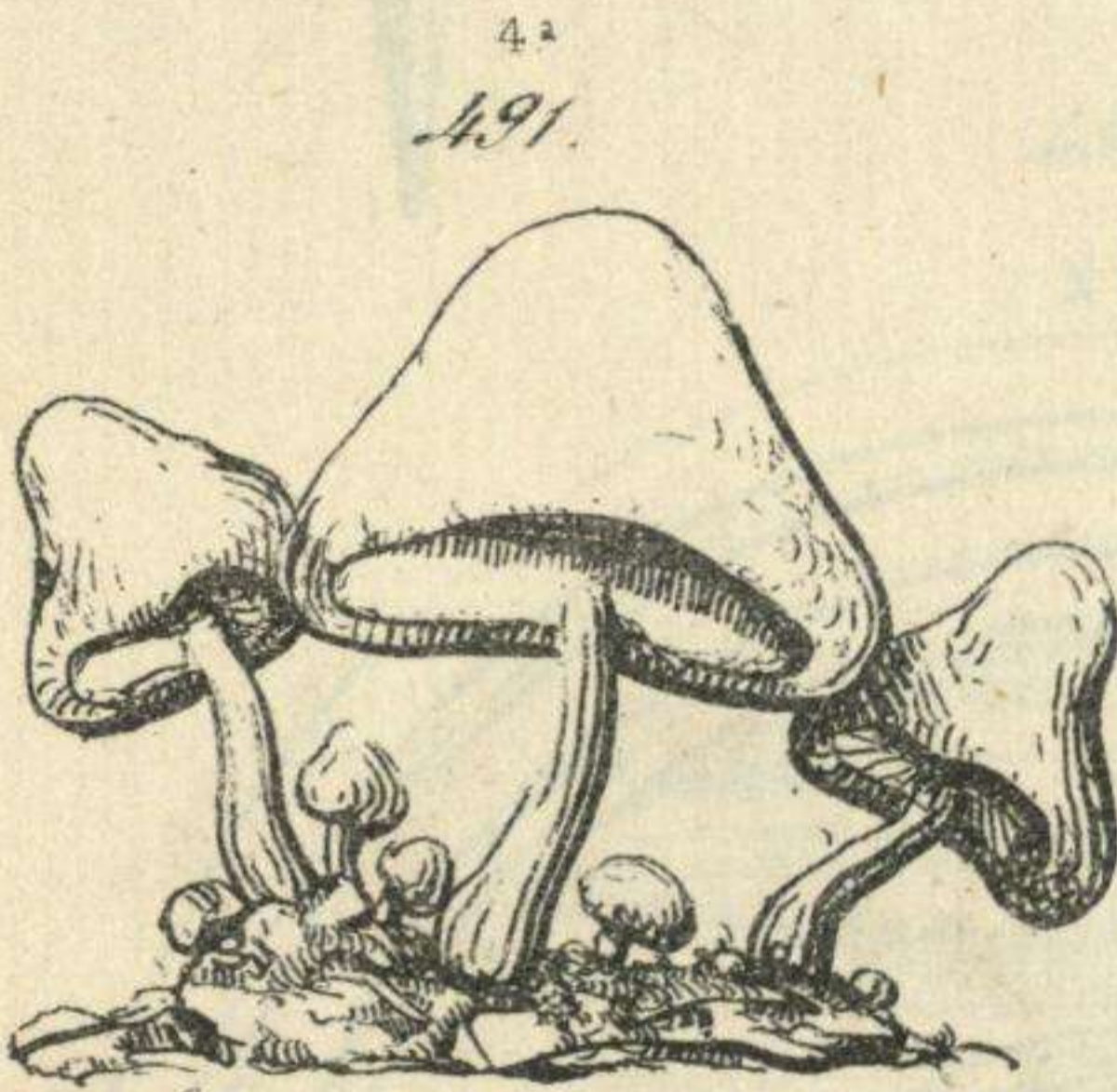
Agarico comestible.



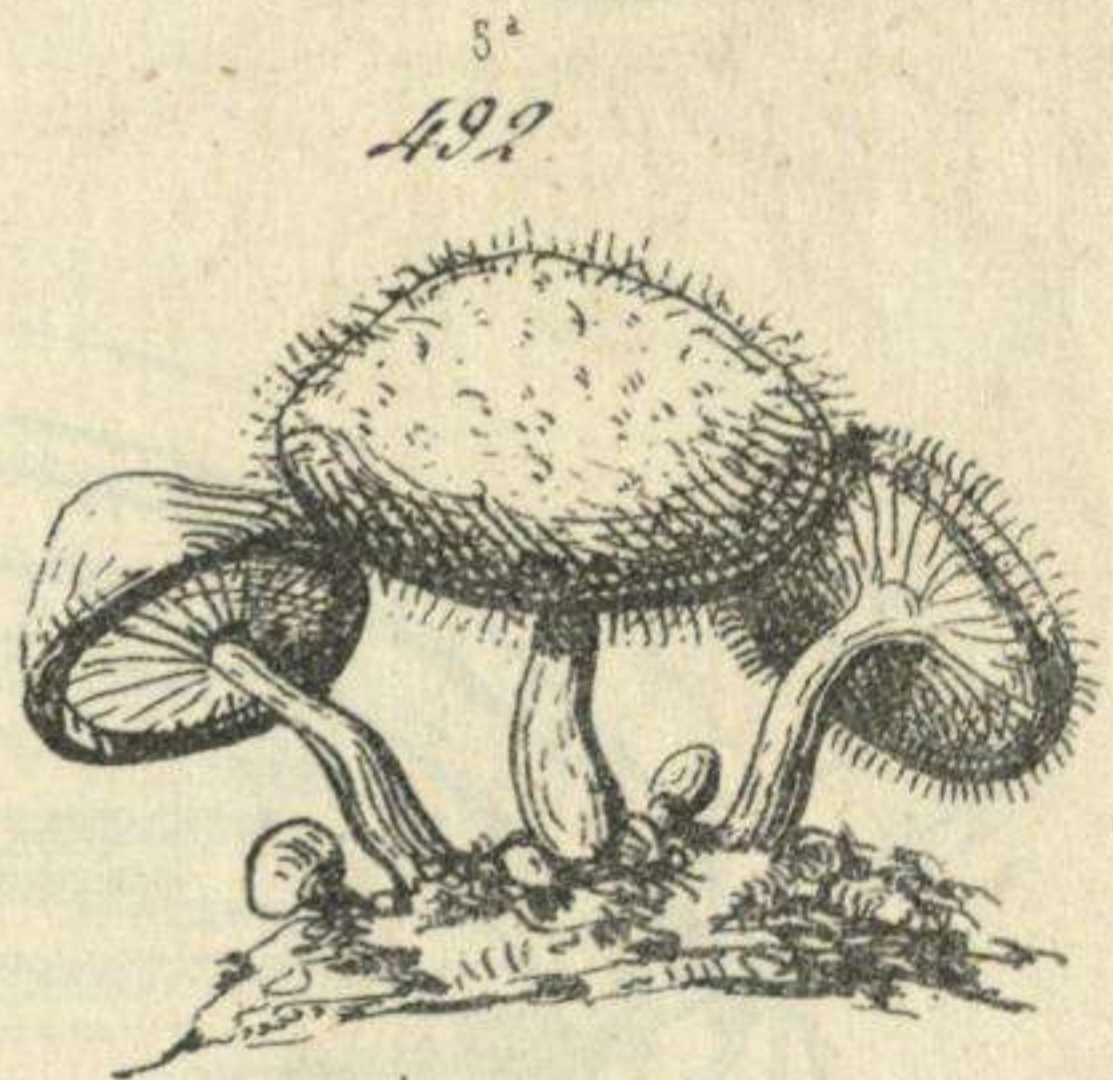
Amanita verdadero orongo.



Amanita falso orongo.



Agarico mosquero.



Agarico venenoso.



Boleto, o seta de cabeza negra.



Boleto, o seta comestible.



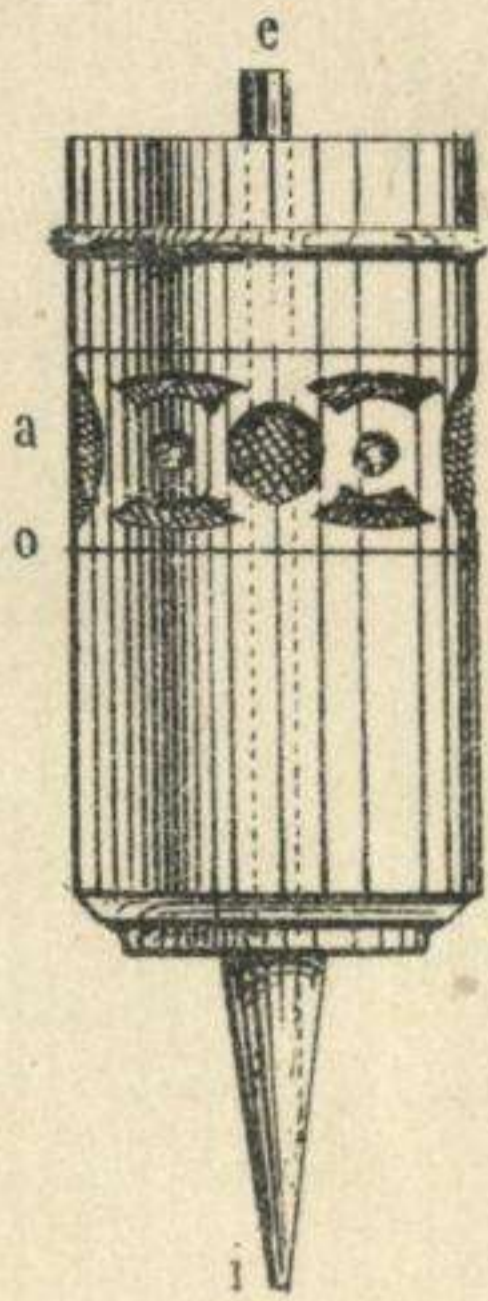
Boleto o seta yesquera.



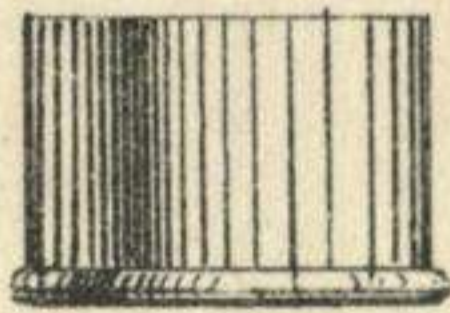




496.



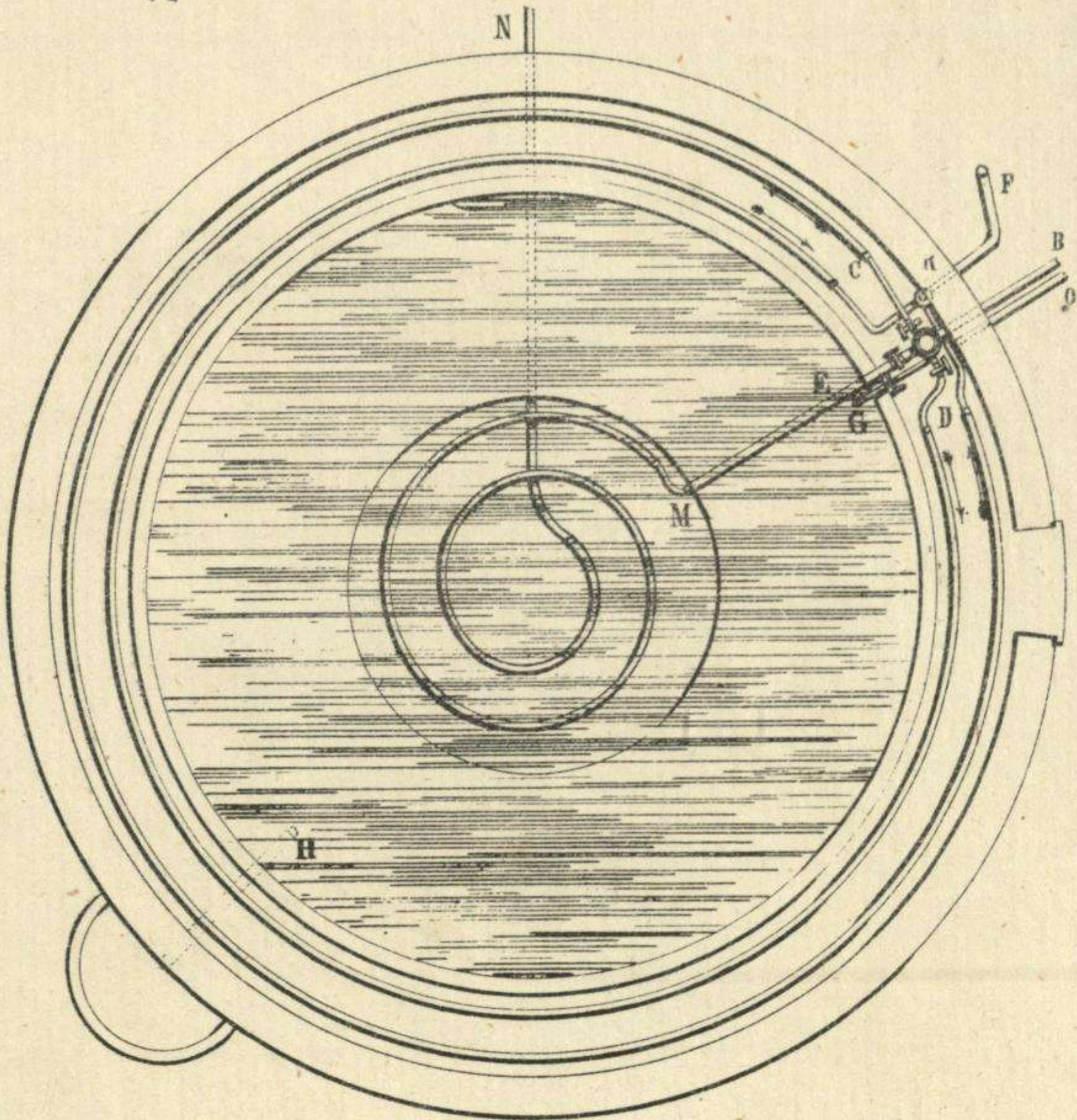
497.



498.



499.





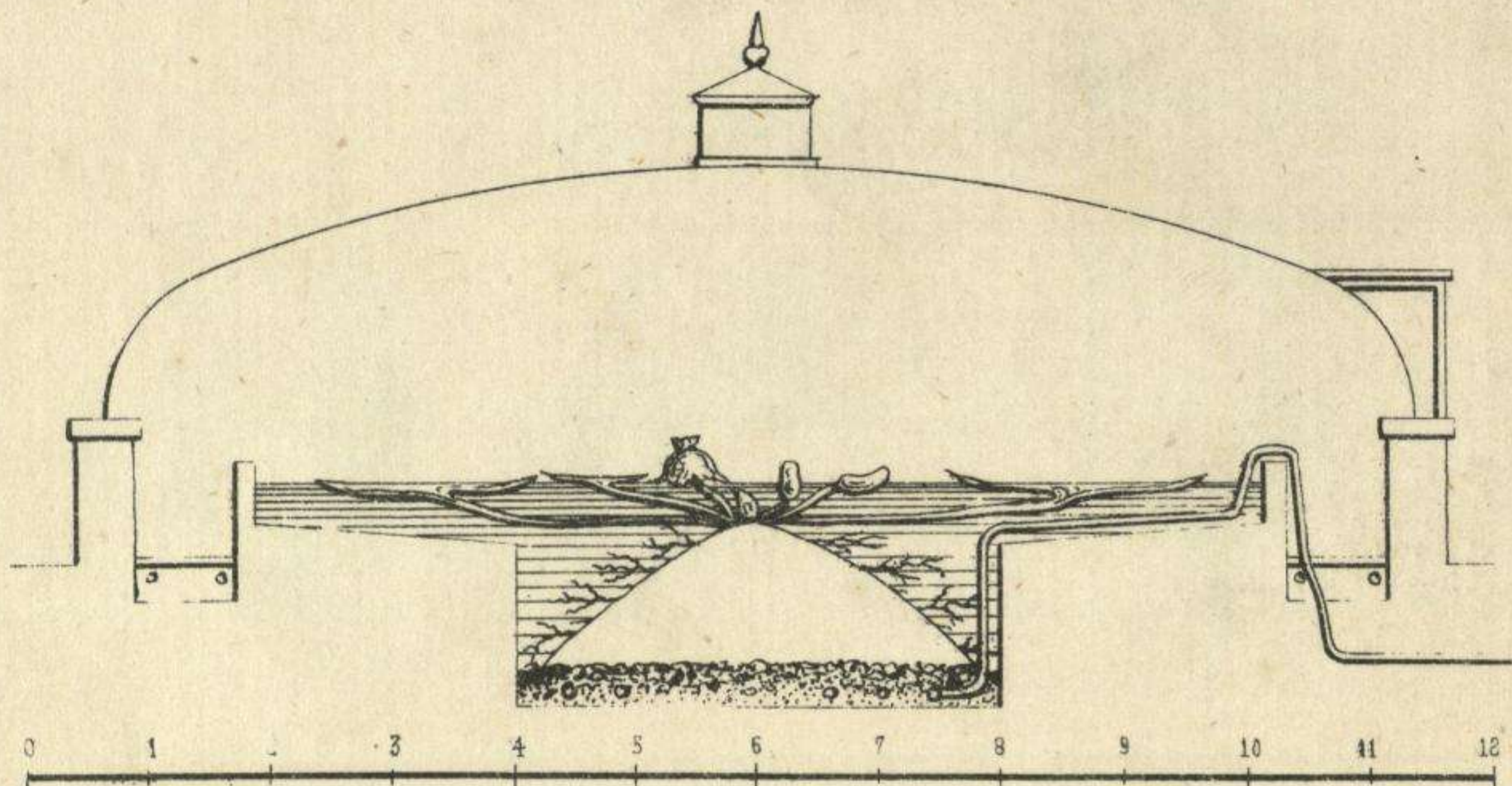






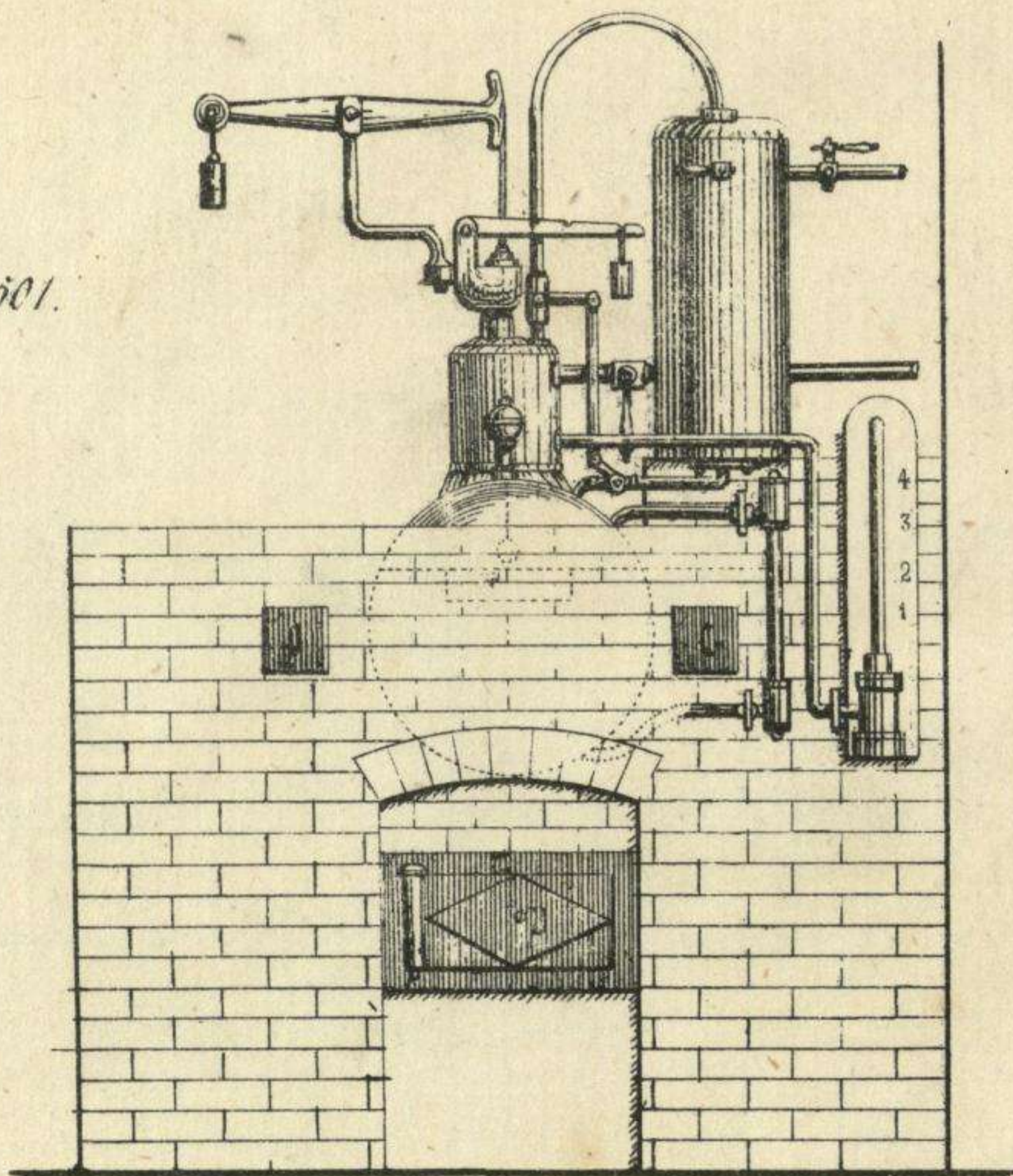


500.



Escala de un centimetro por metro

501.



2 1 10 20 30 40 50 60 70 80 90 100

Escala de 4 centimetros por metro





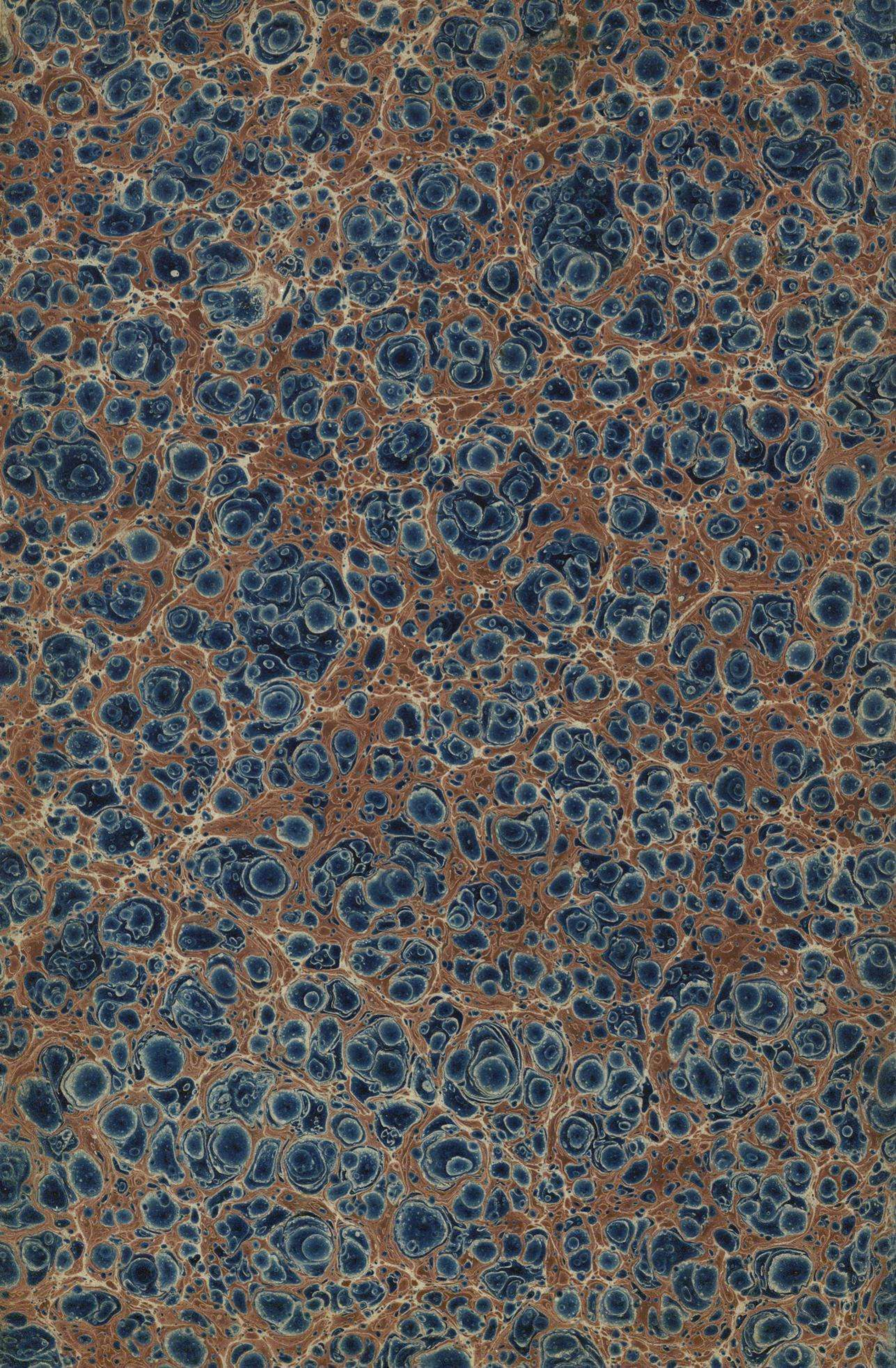




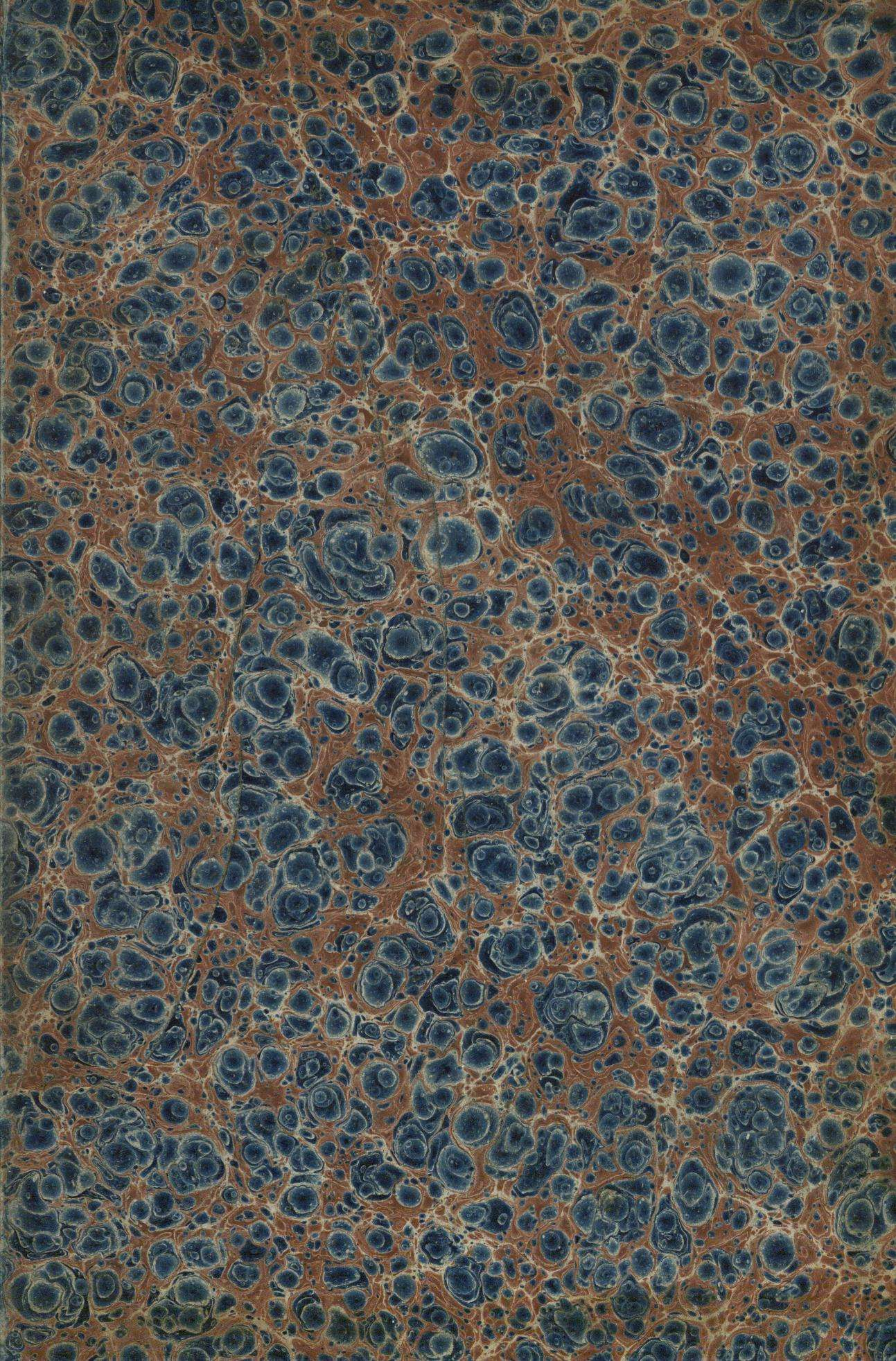
















2





ATLAS DEL  
DICCIONARIO

DE AGRICULTURA

292