

APUNTES

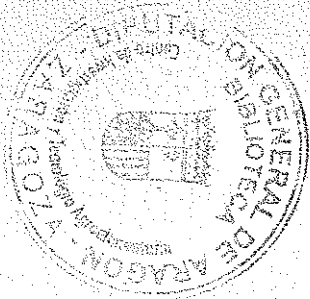
DE

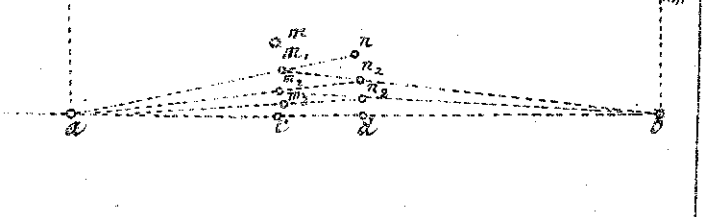
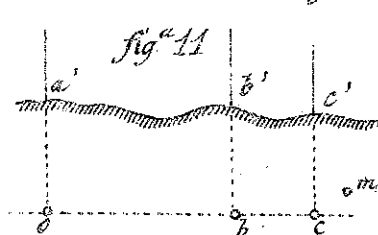
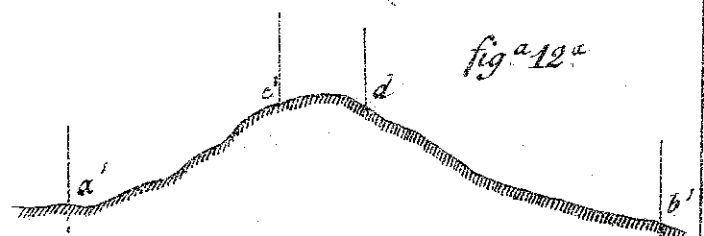
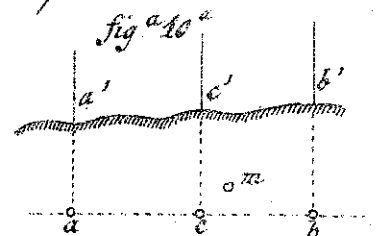
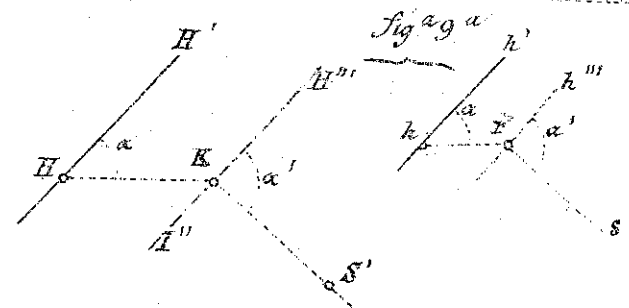
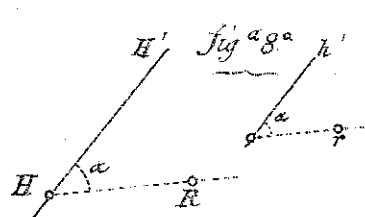
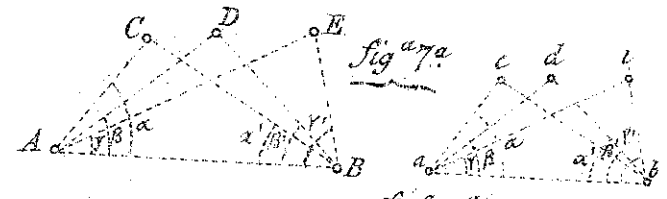
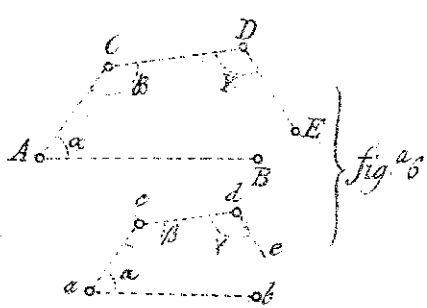
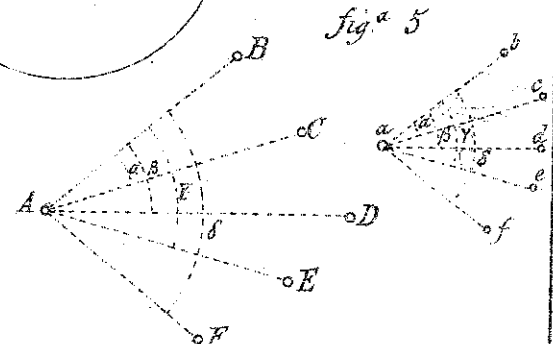
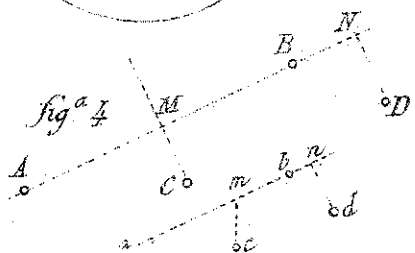
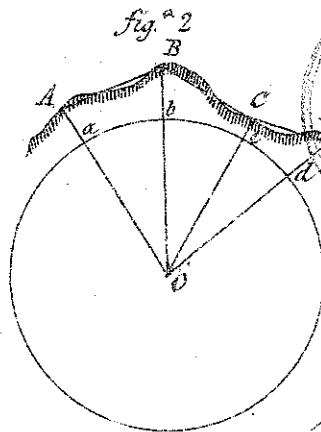
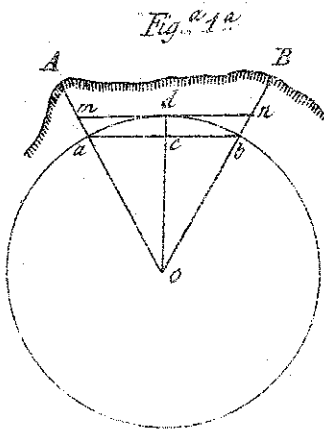
TOPOGRAFIA

ATLAS











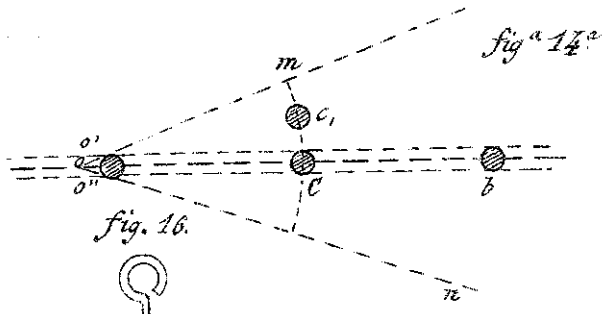
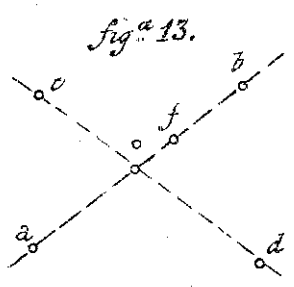


Fig. 16.

Fig.^a 17.

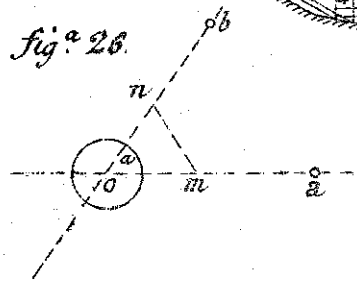
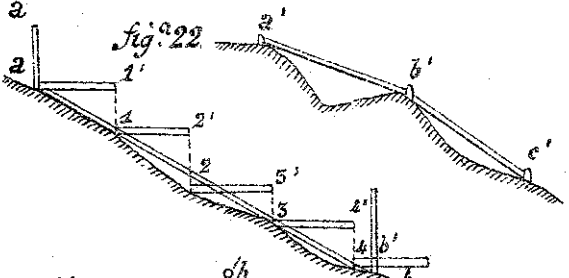
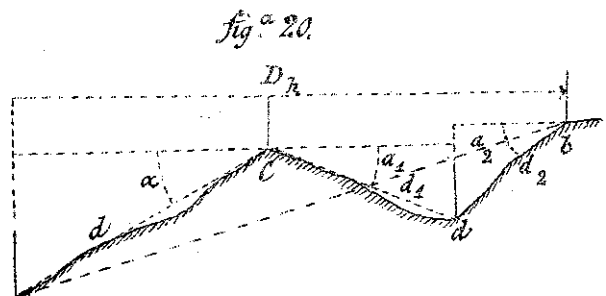
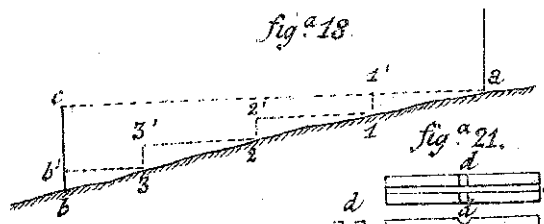
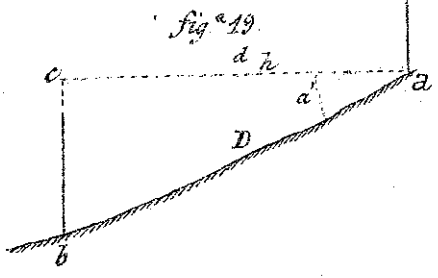
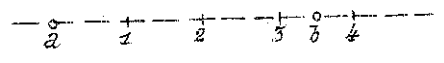
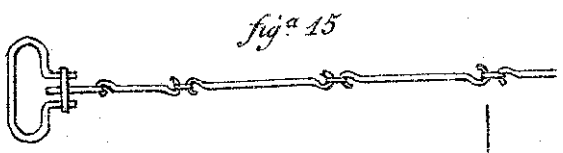


Fig.^a 23.

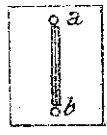


Fig.^a 24.

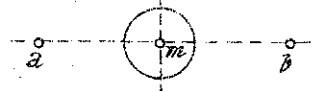
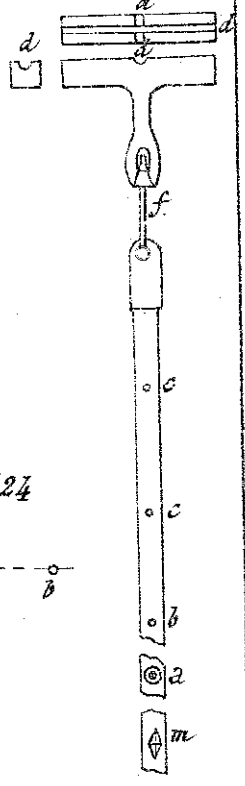
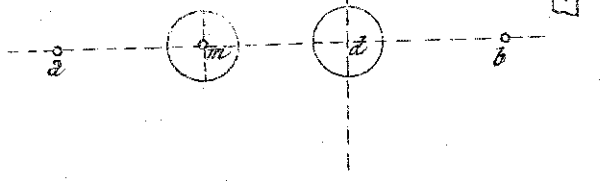
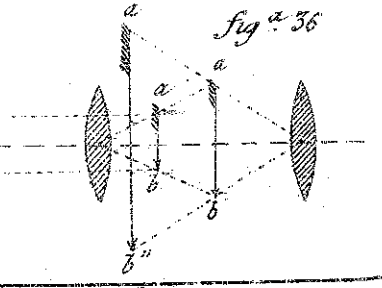
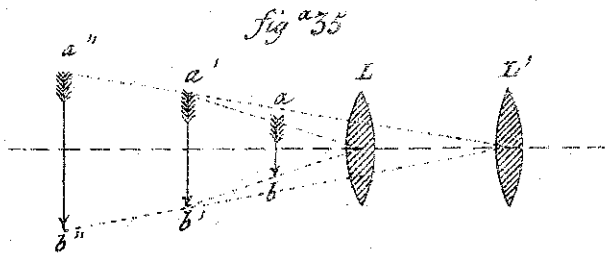
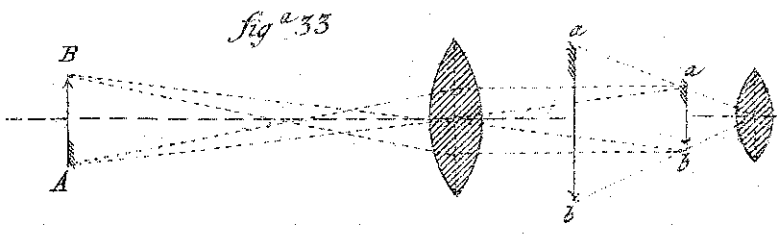
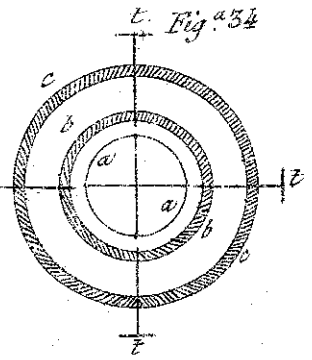
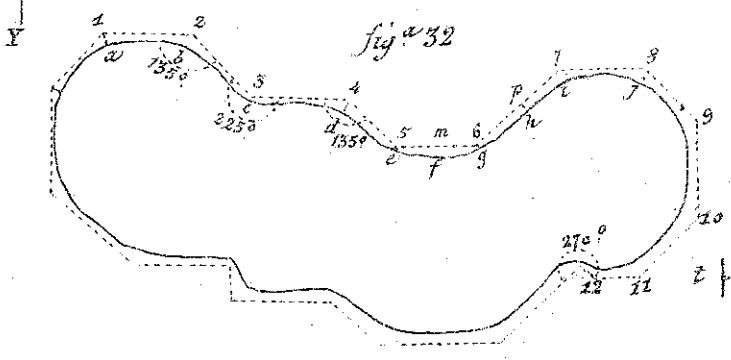
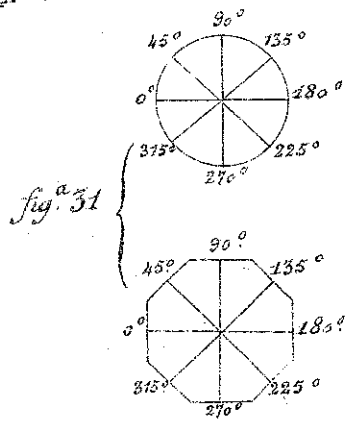
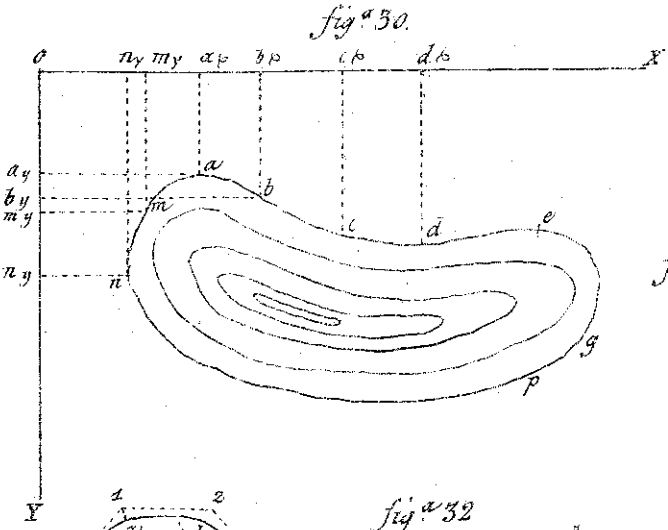
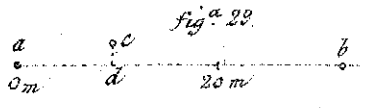
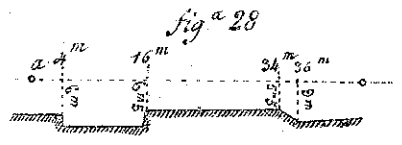
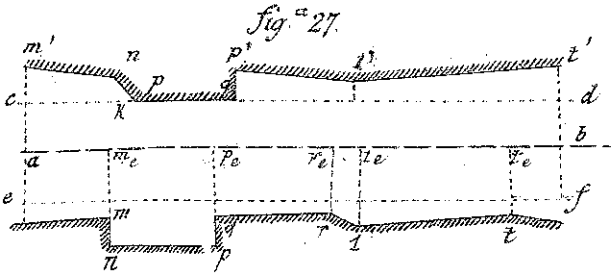


Fig.^a 25.









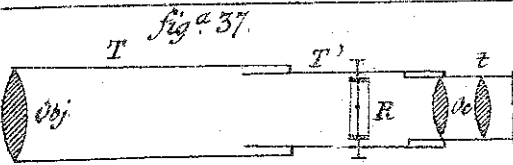


Fig. 37.

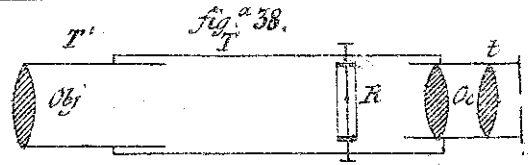


Fig. 38.

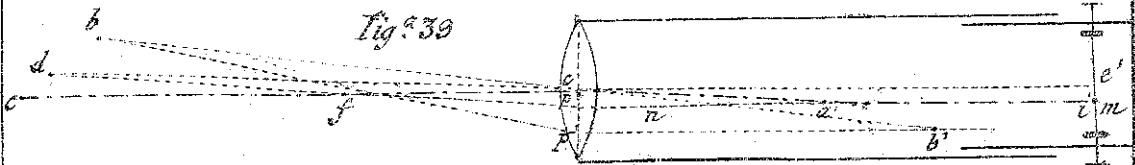


Fig. 39.

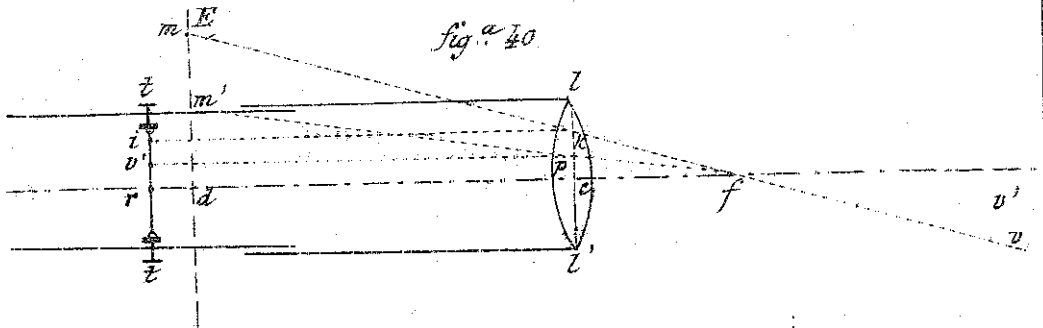


Fig. 40.

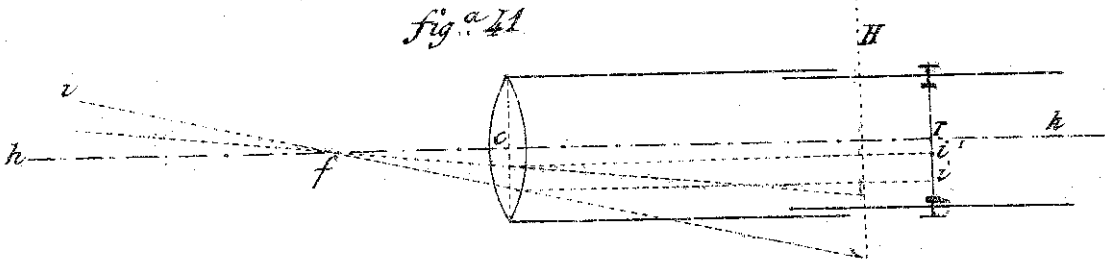


Fig. 41.

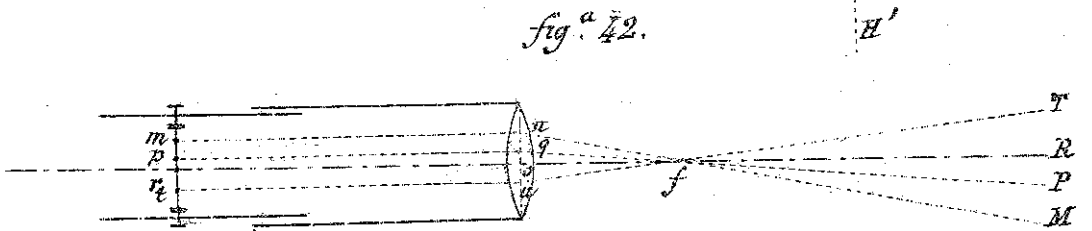


Fig. 42.

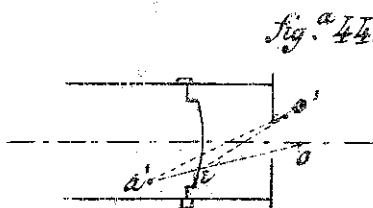


Fig. 44.

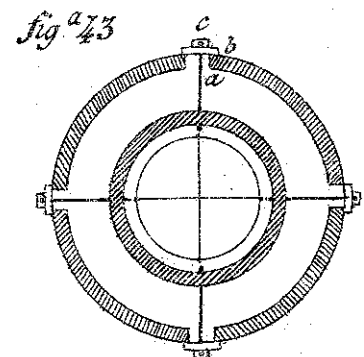
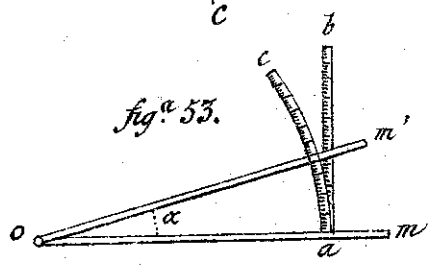
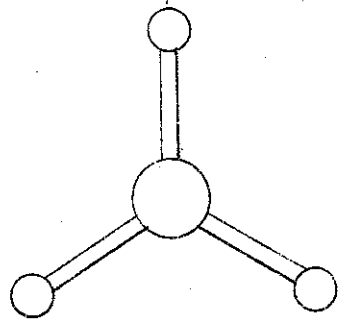
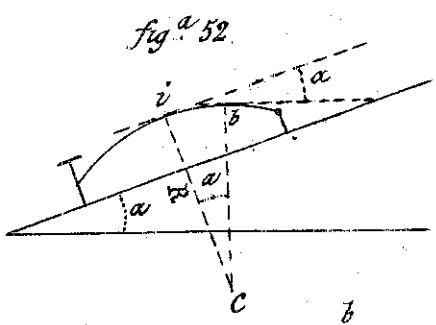
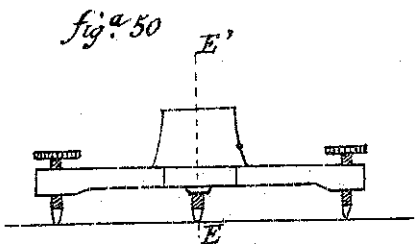
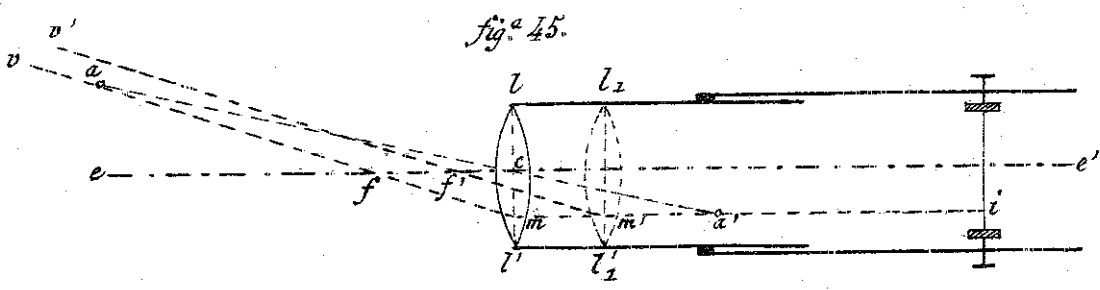
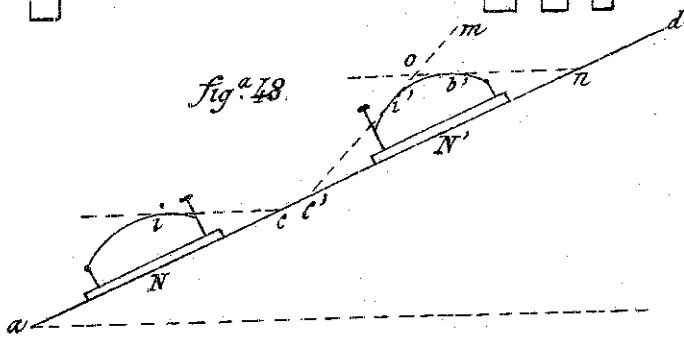
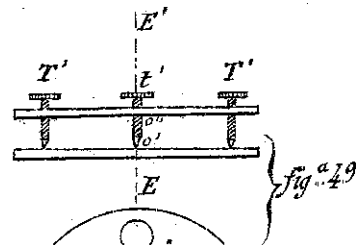
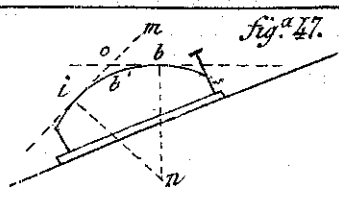
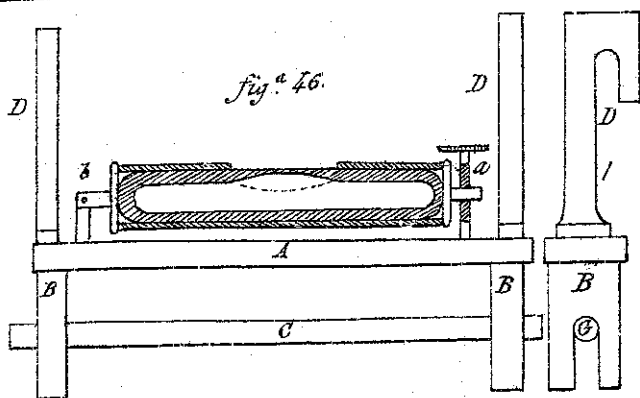


Fig. 43.





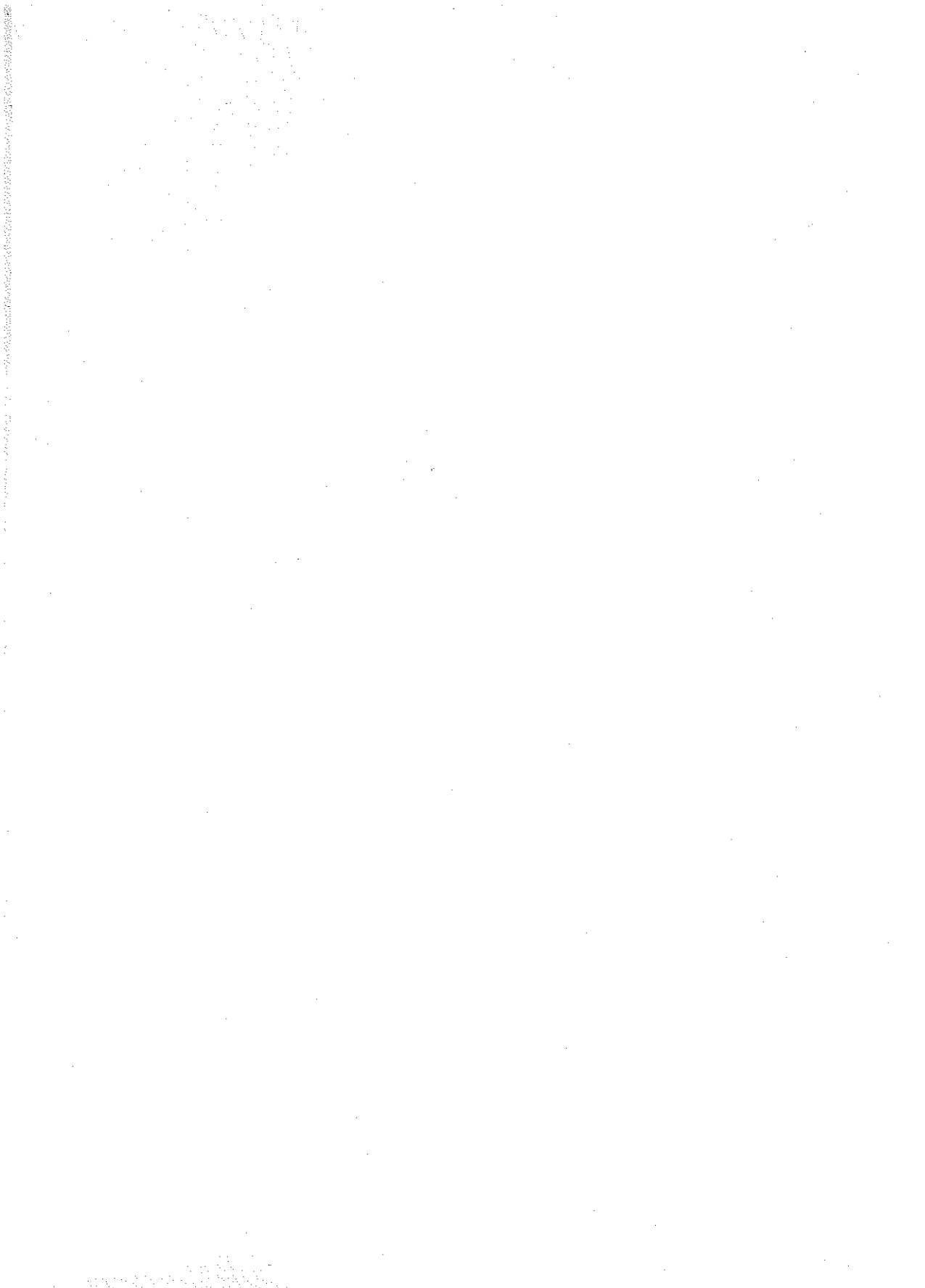
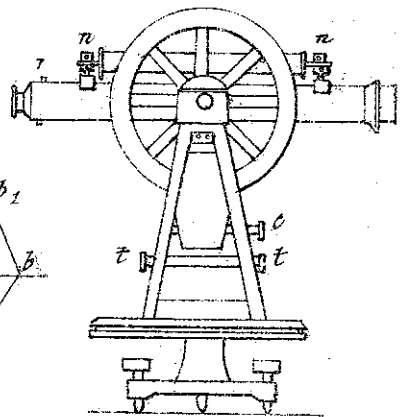
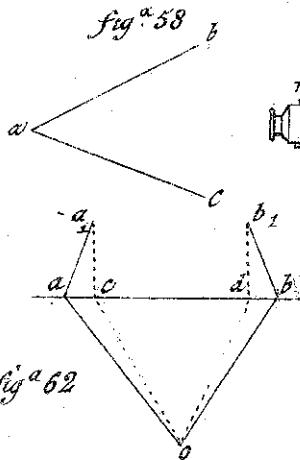
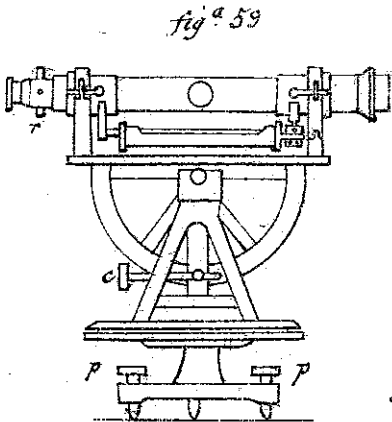
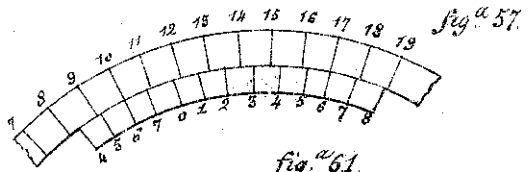
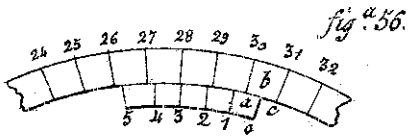
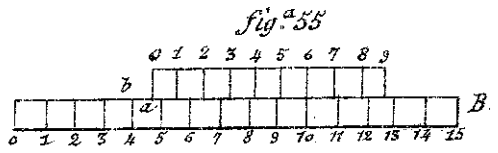
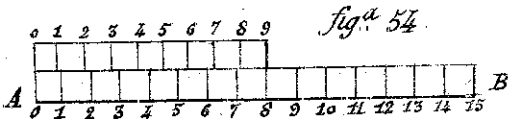
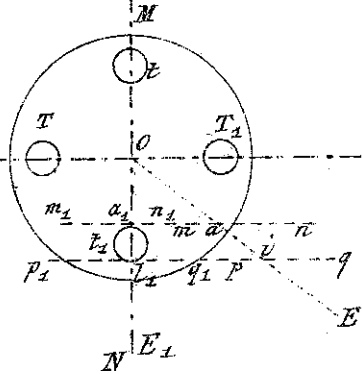
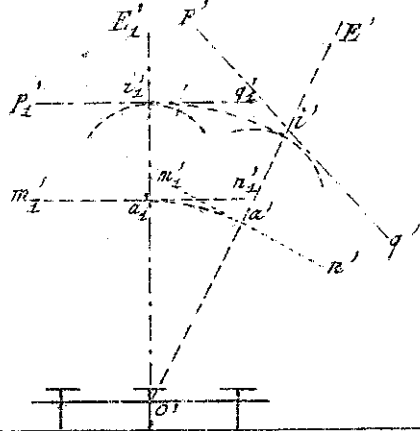
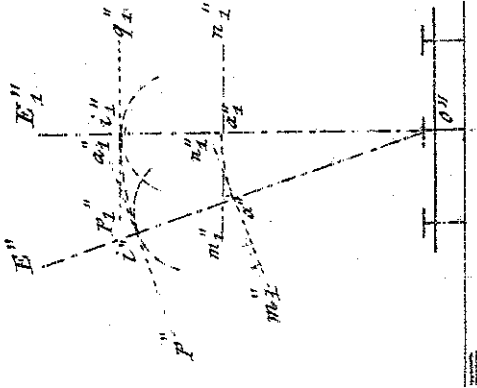
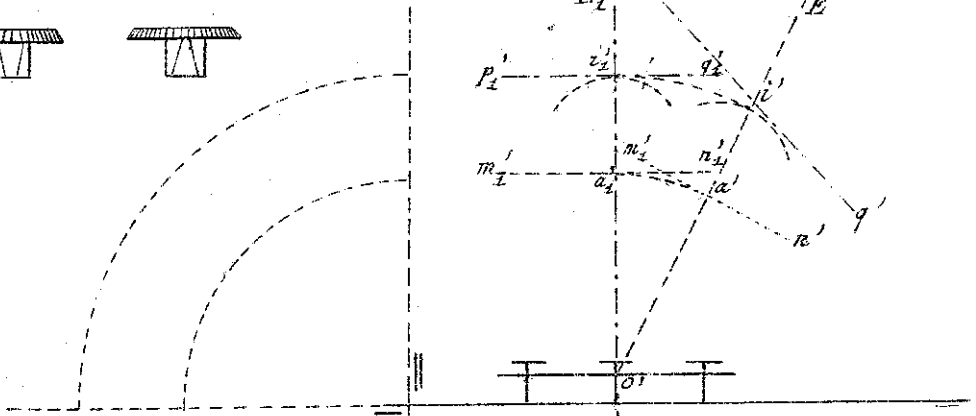


fig.^a 60





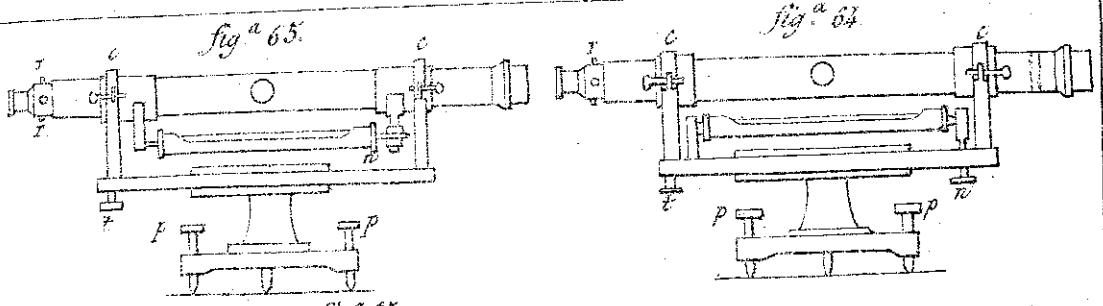


fig. 65.

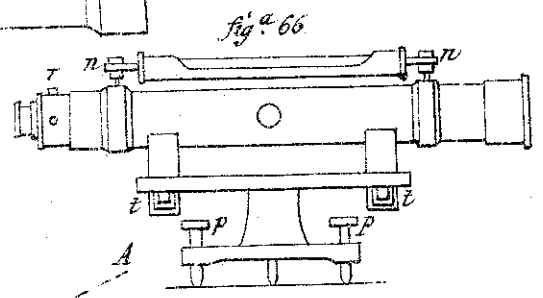
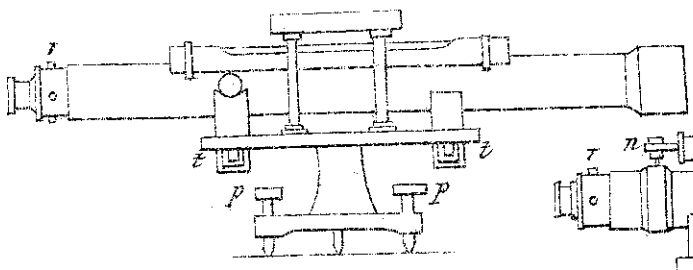


fig. 66

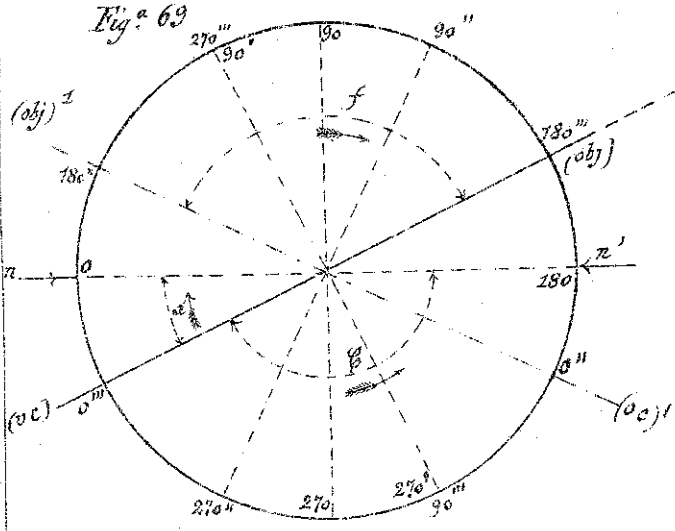


Fig. 69

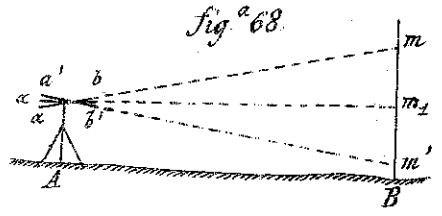


fig. 68.

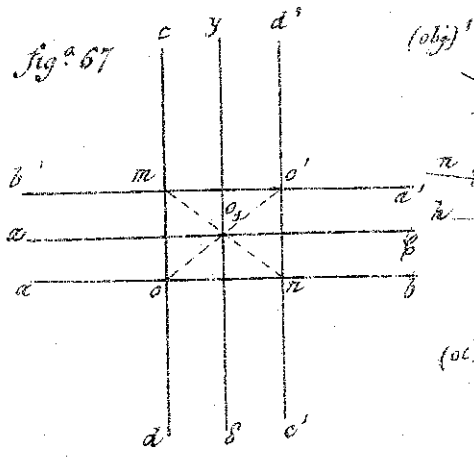


fig. 67

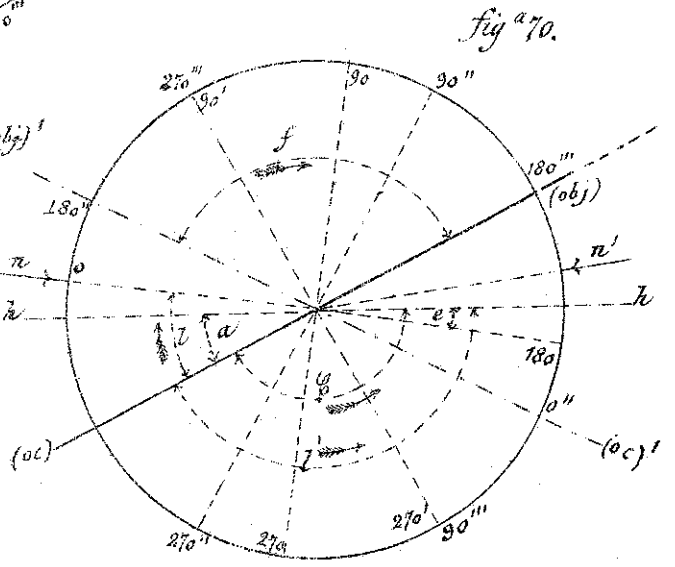


fig. 70.



fig. a 71

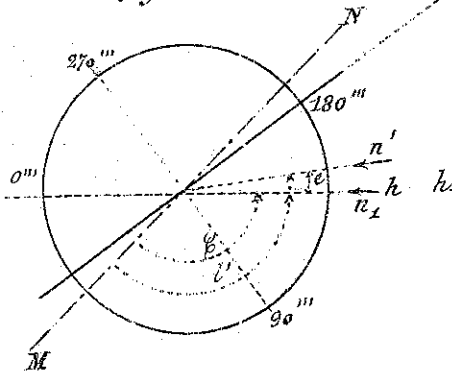


fig. a 72

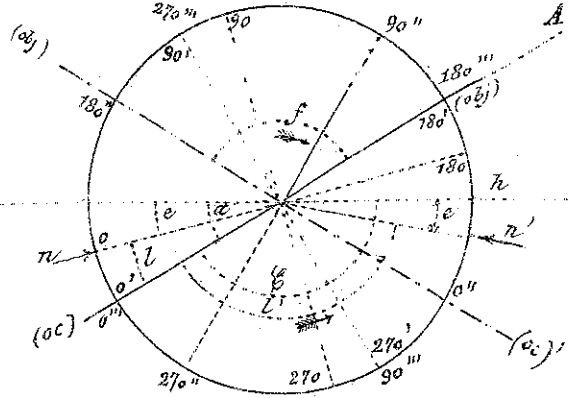


fig. a 74

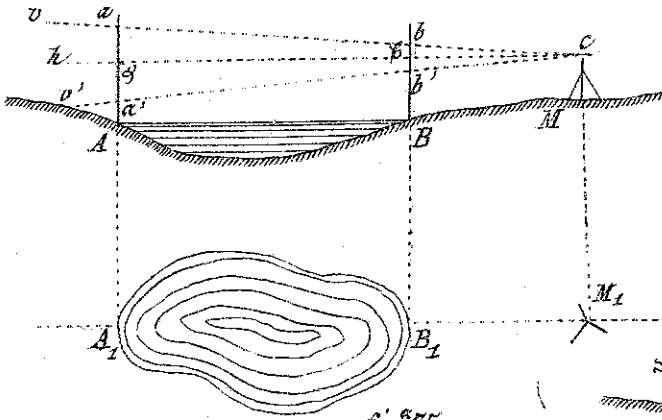


Fig. 73

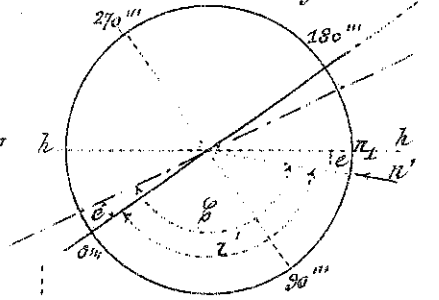


fig. a 76

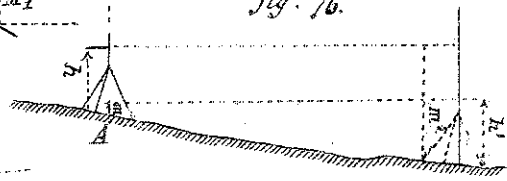


fig. a 75

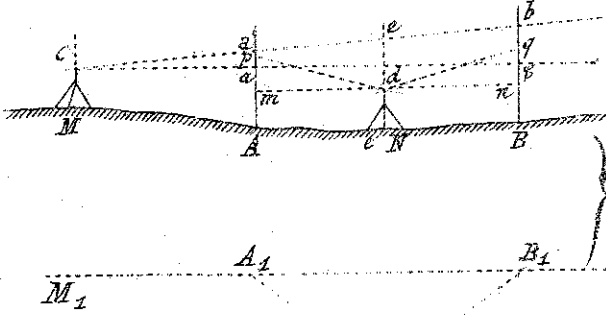


fig. a 78

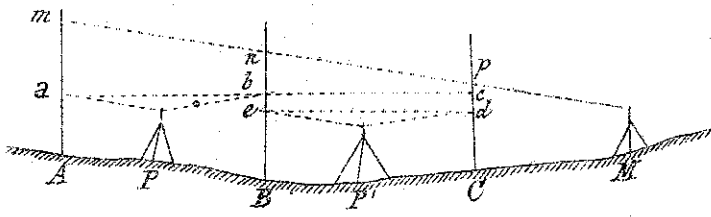
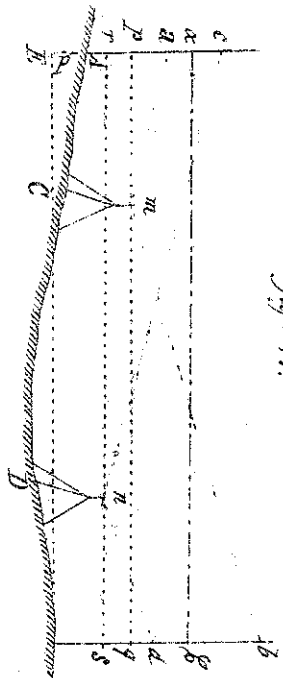
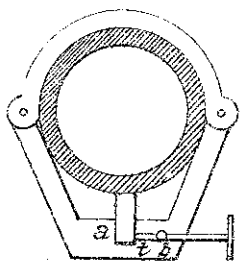


fig. a 77

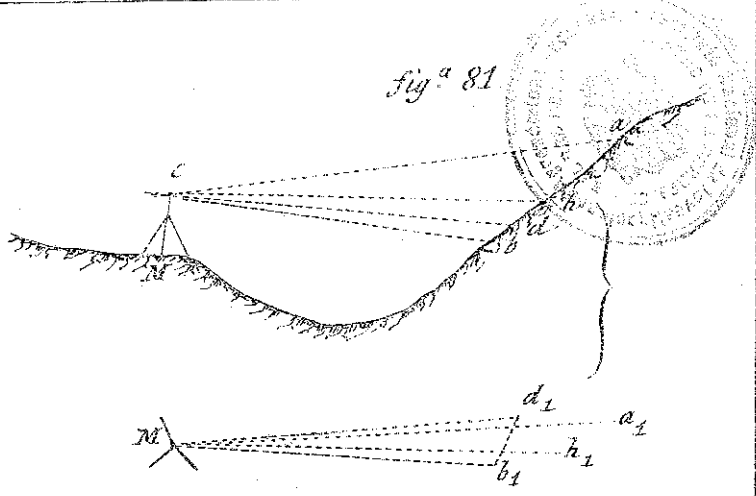




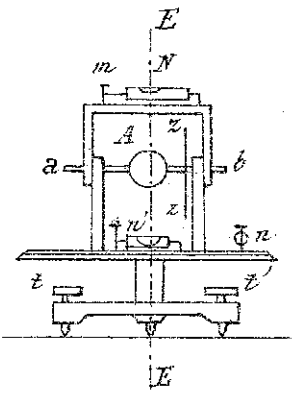
fig^a 79.



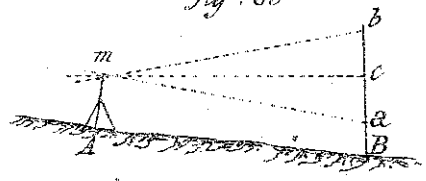
fig^a 81



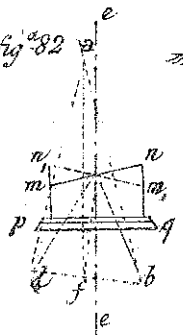
fig^a 80



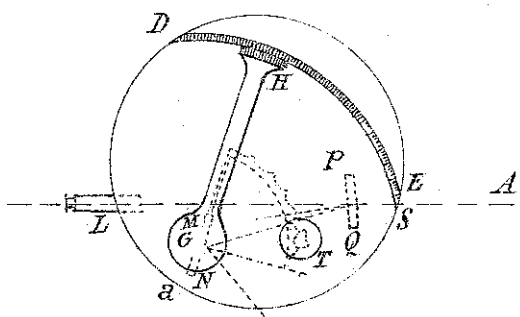
fig^a 85



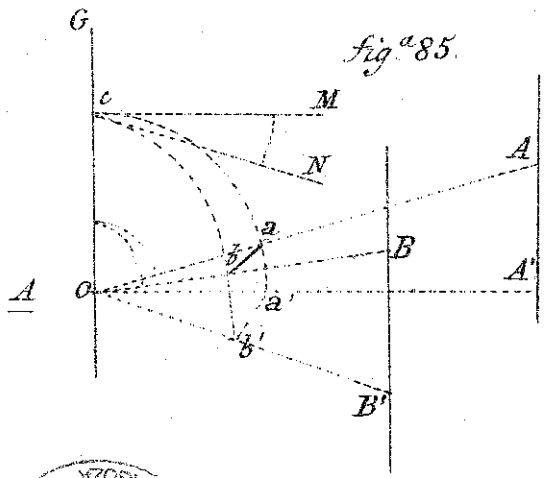
fig^a 82

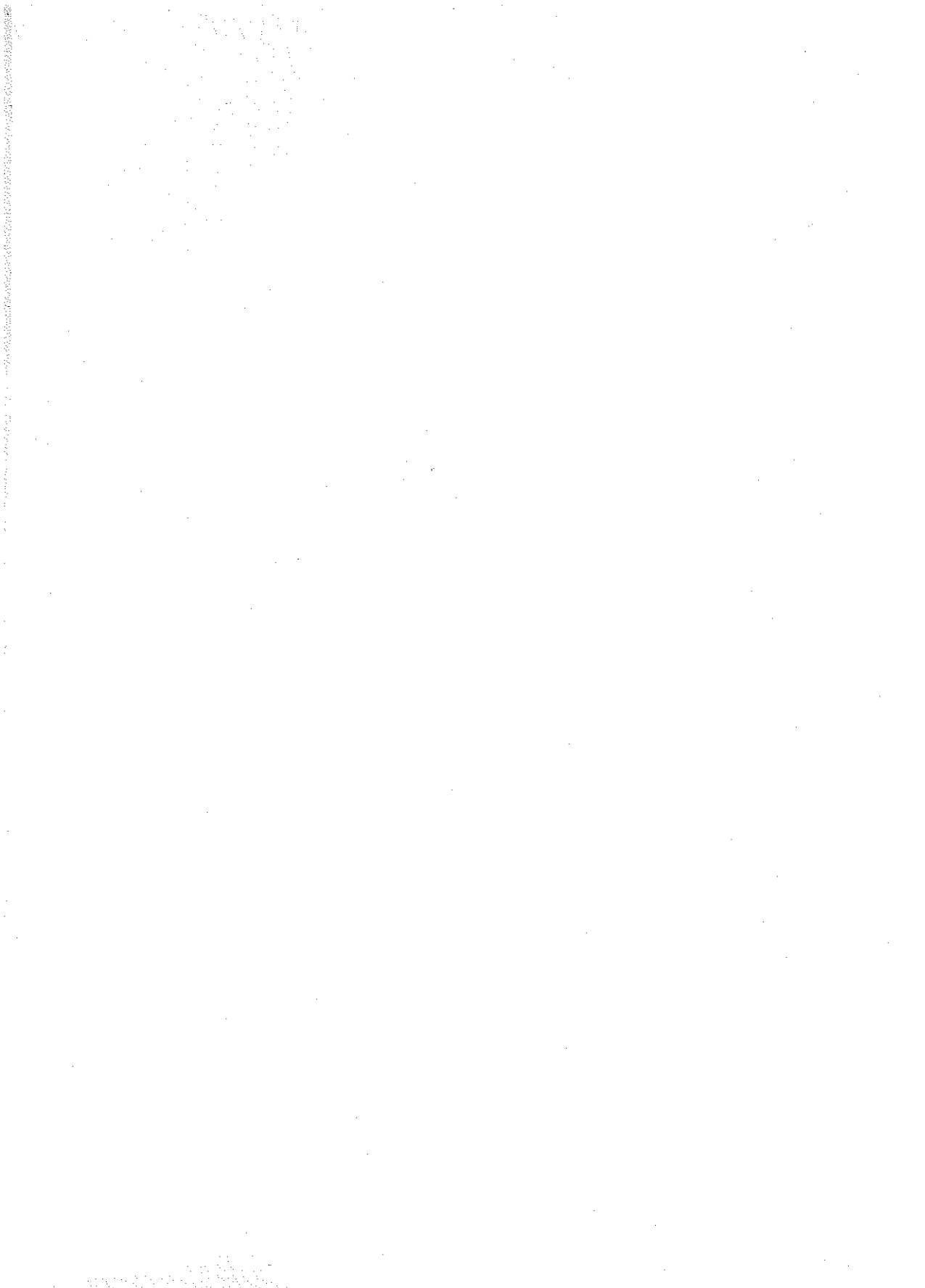


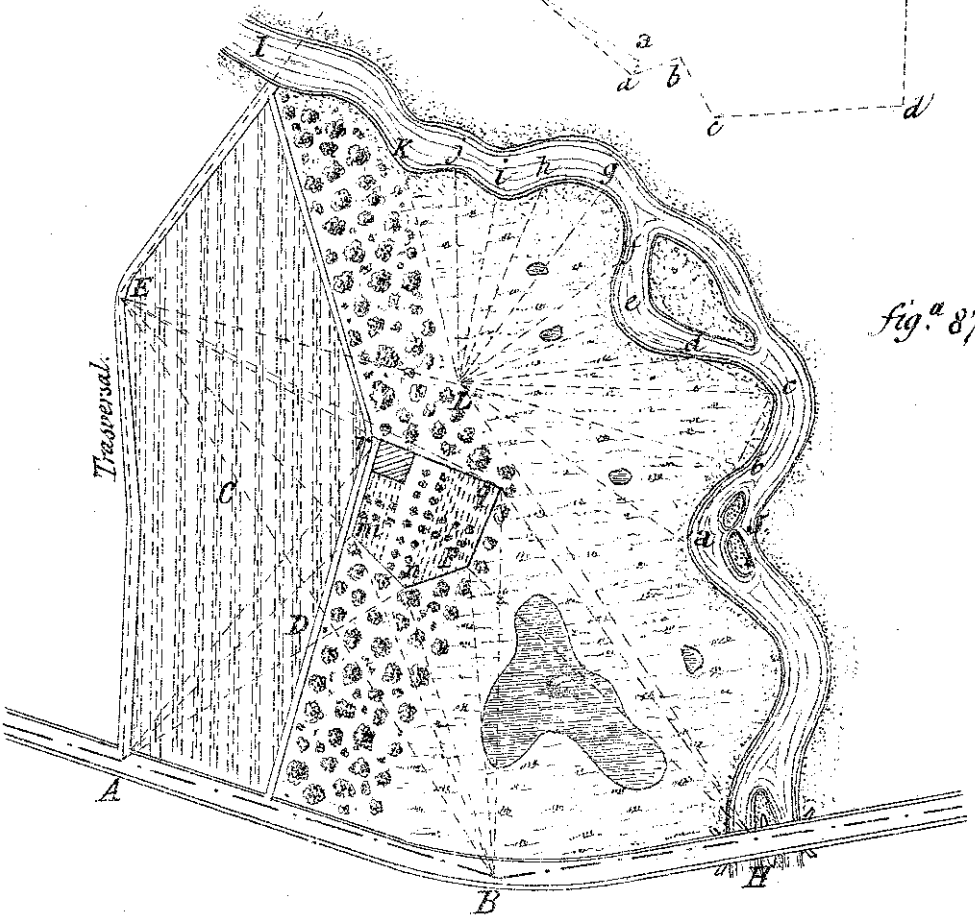
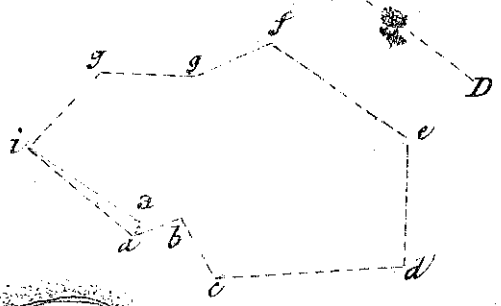
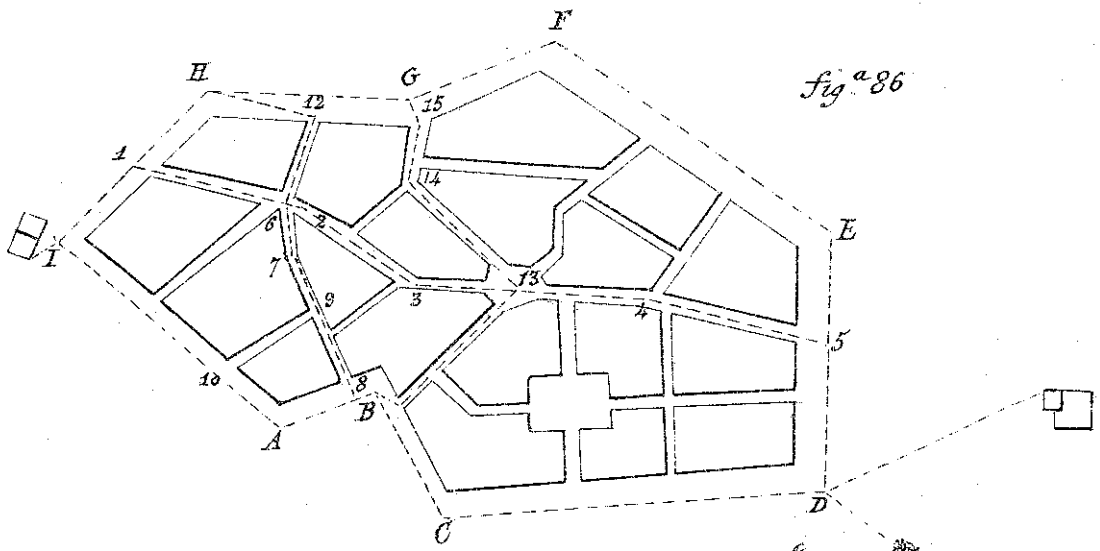
fig^a 84



fig^a 85

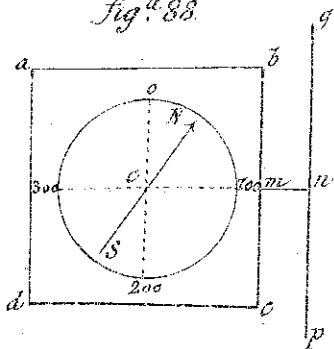




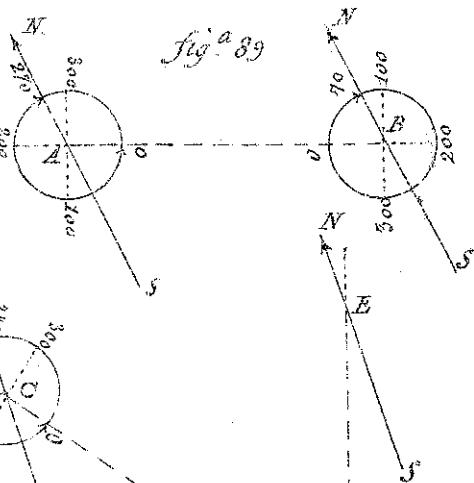




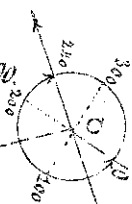
fig^a 88



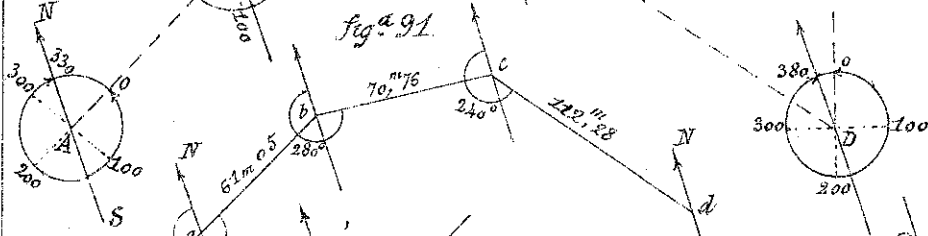
fig^a 89



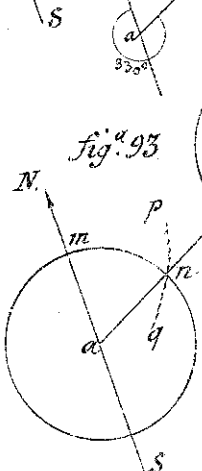
fig^a 90



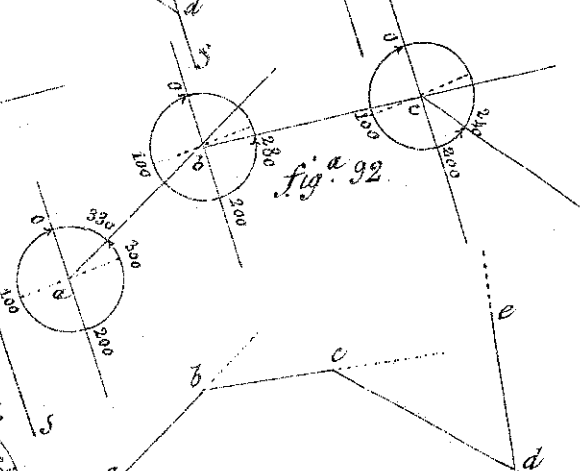
fig^a 91



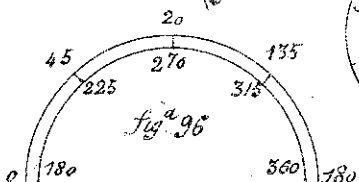
fig^a 93



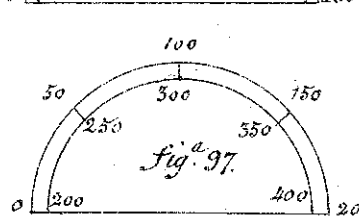
fig^a 92



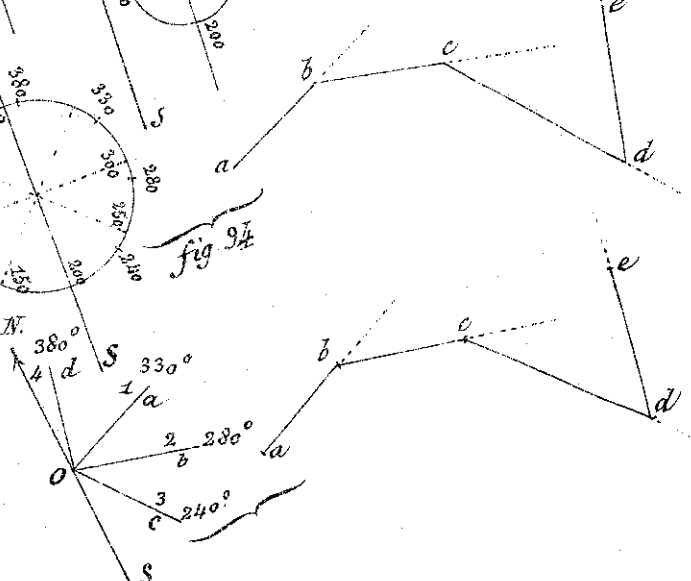
fig^a 95



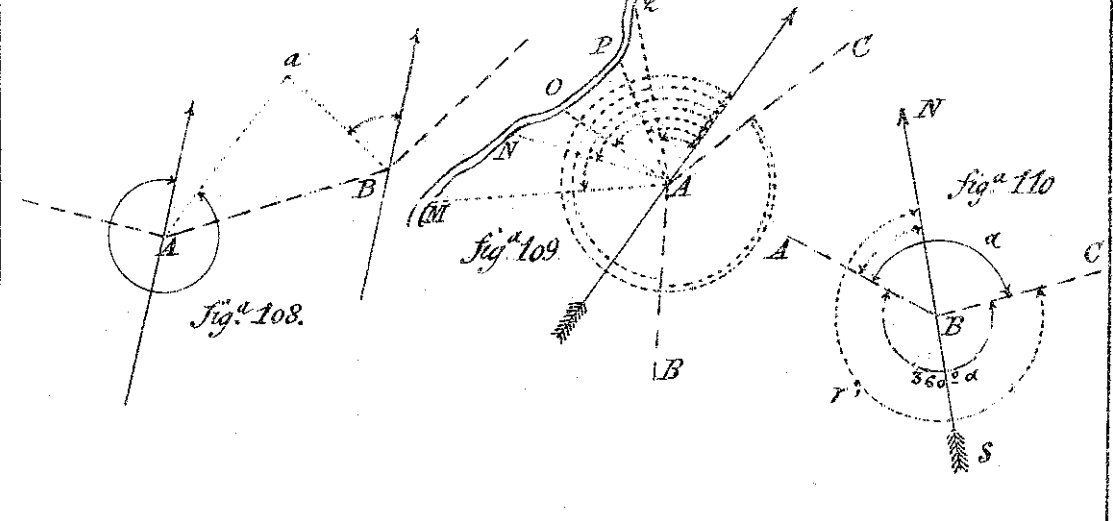
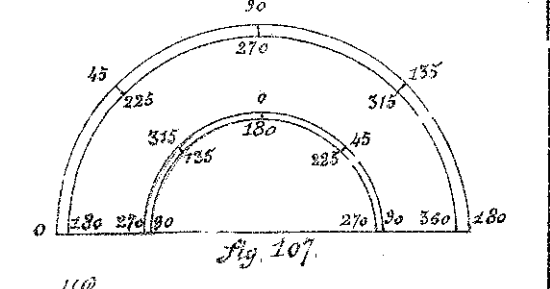
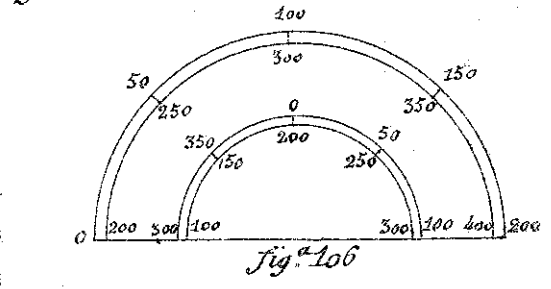
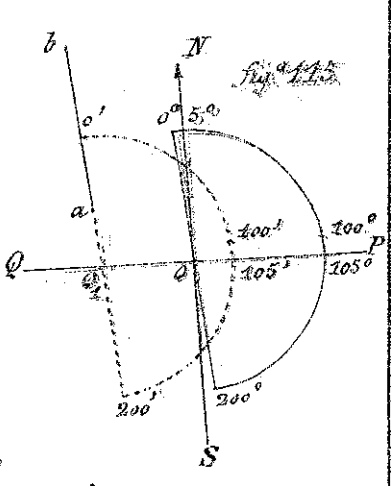
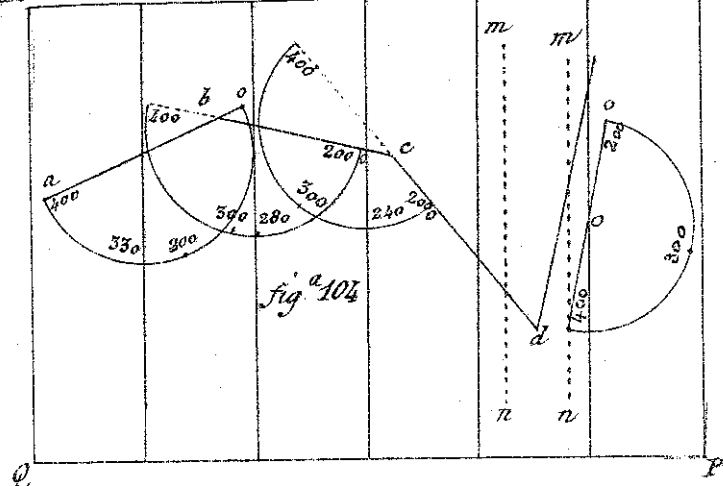
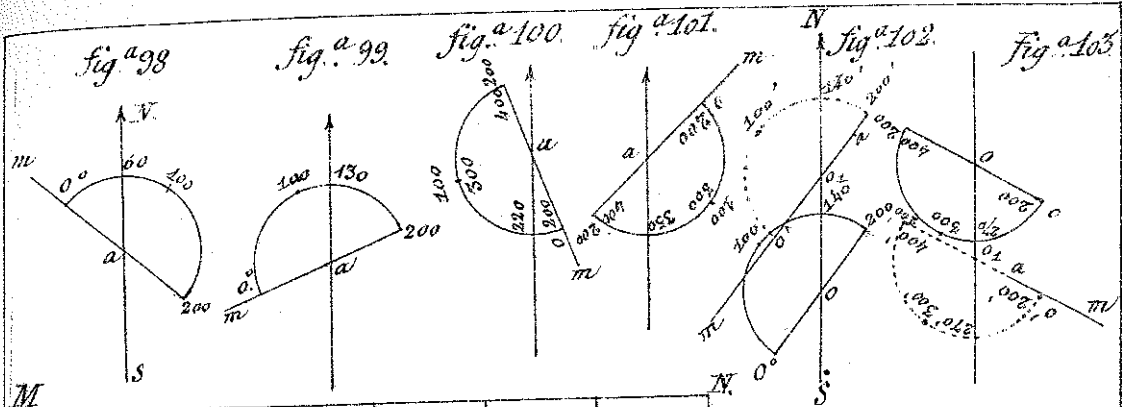
fig^a 97



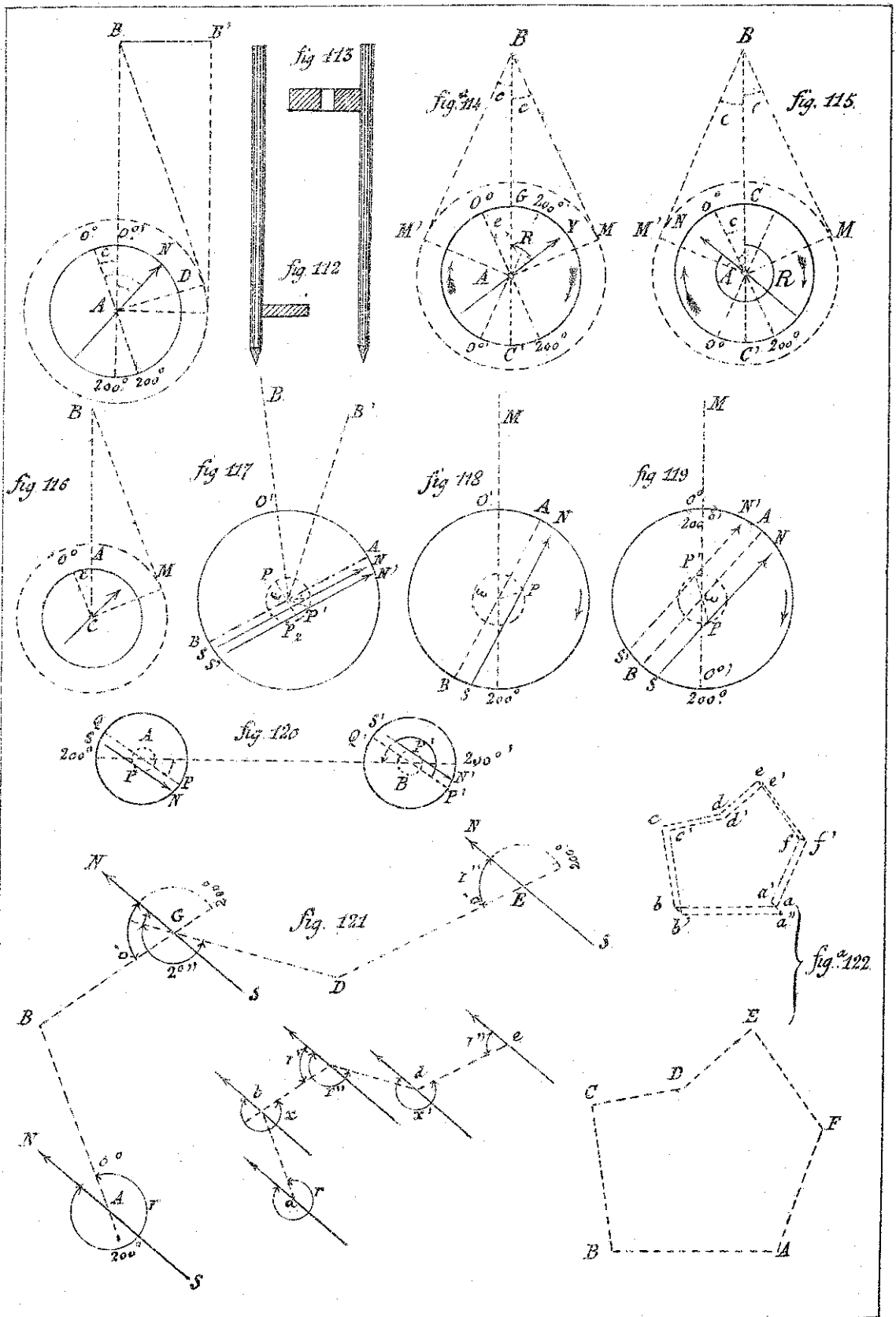
fig^a 94

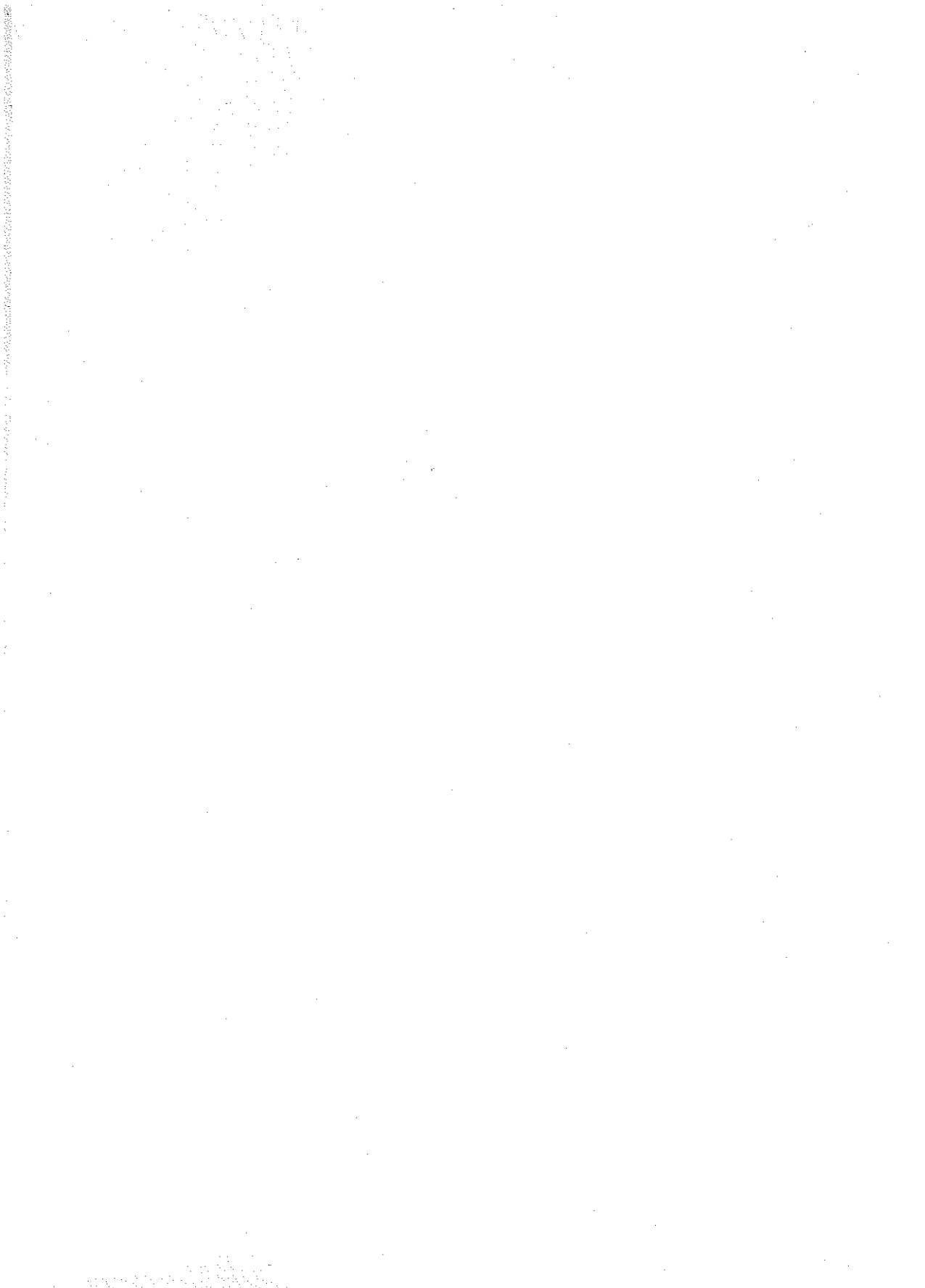


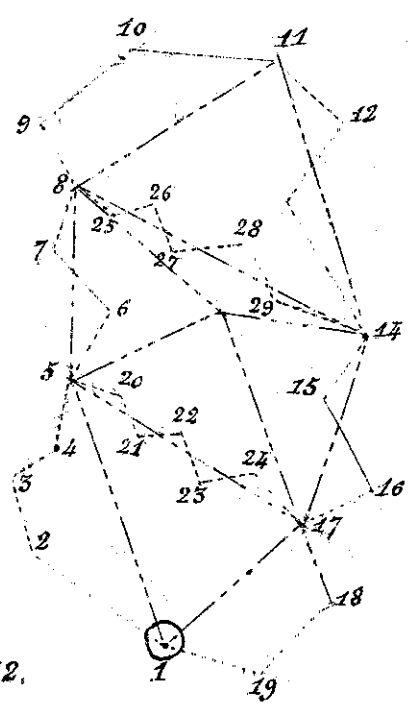
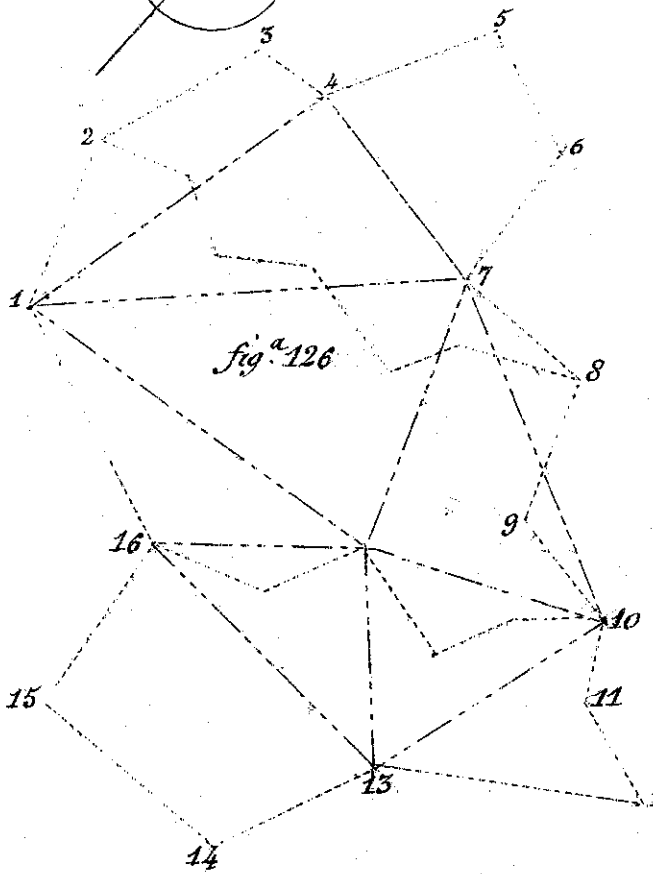
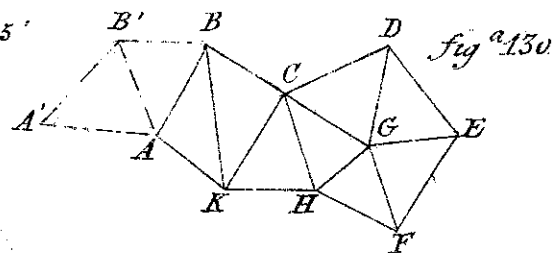
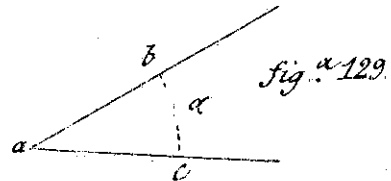
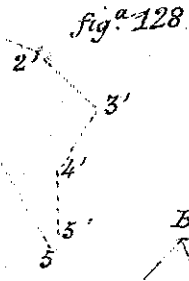
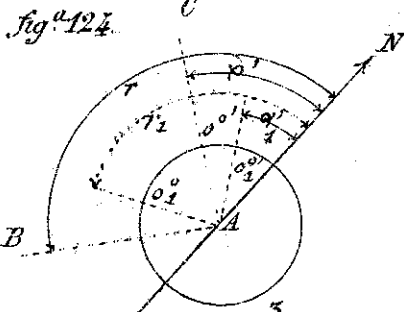
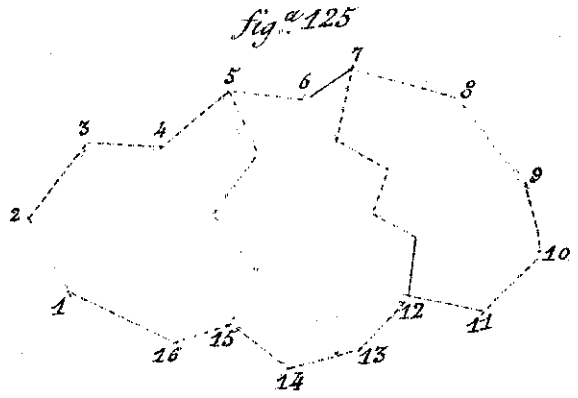
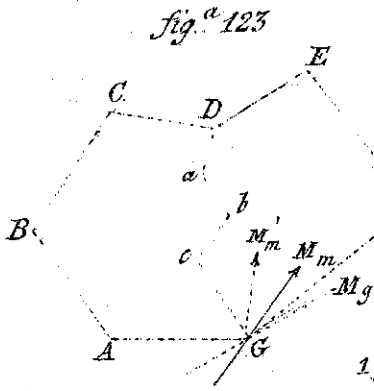








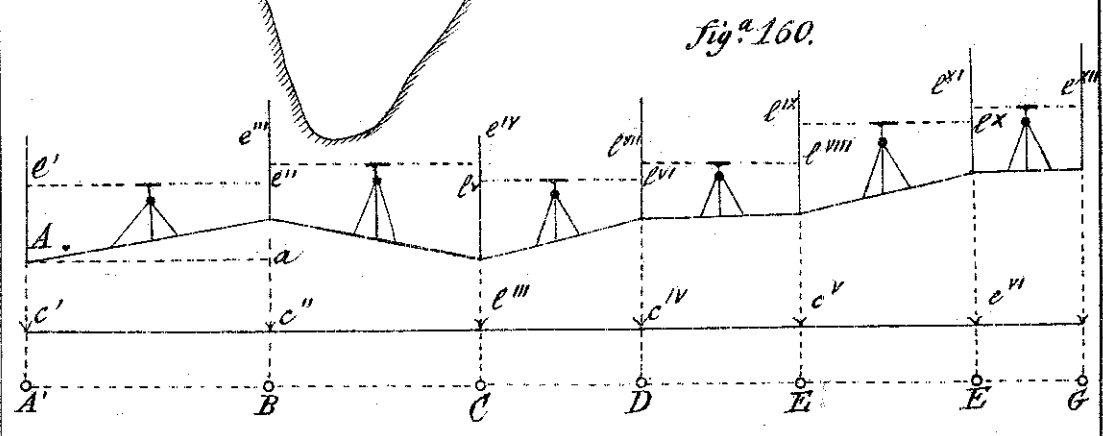
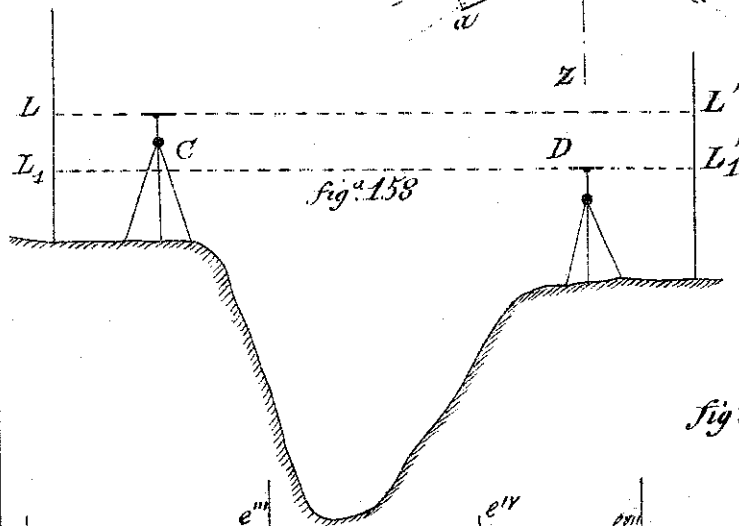
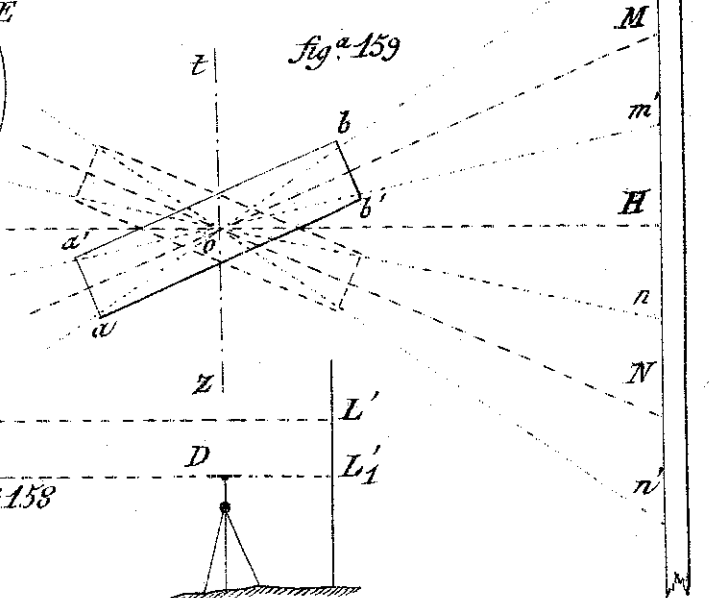
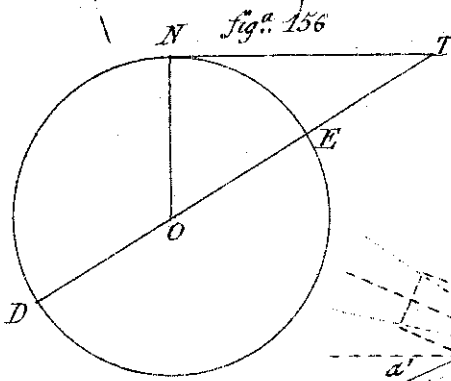
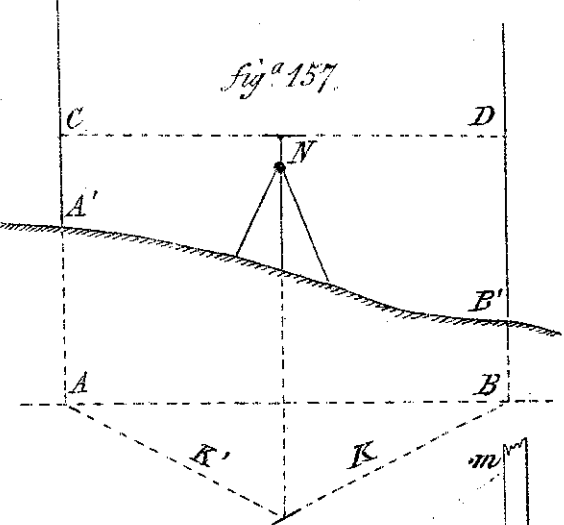
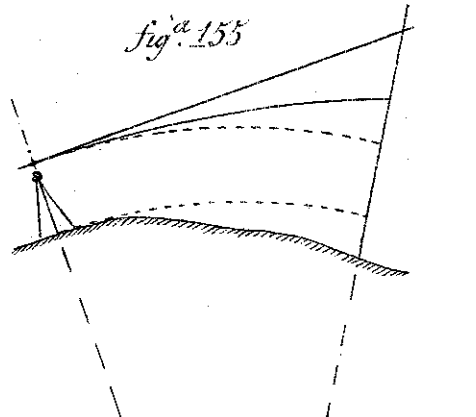


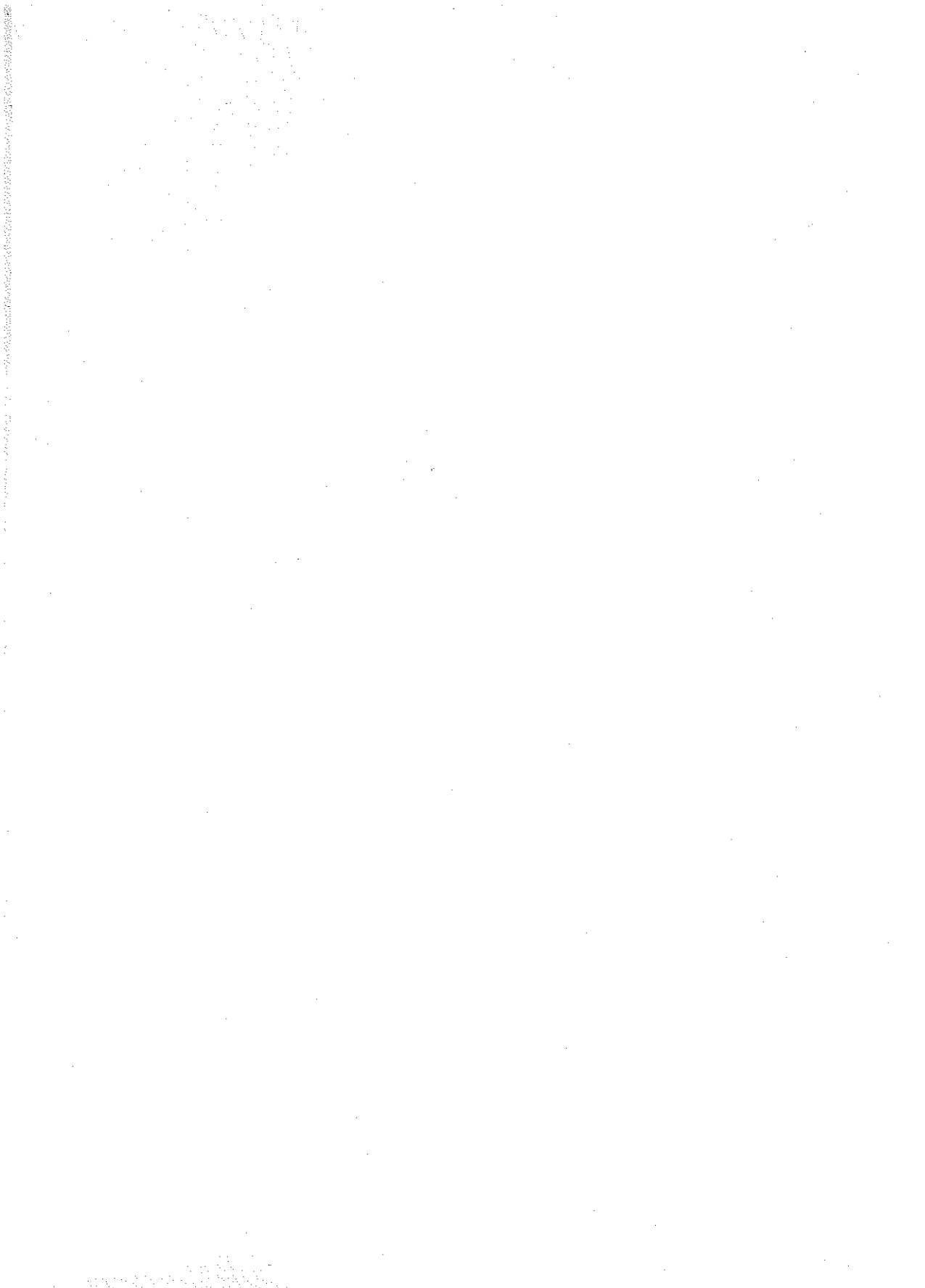












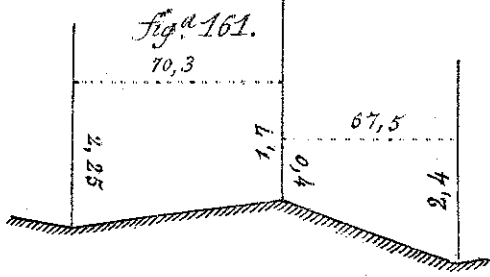


fig.^a 161.

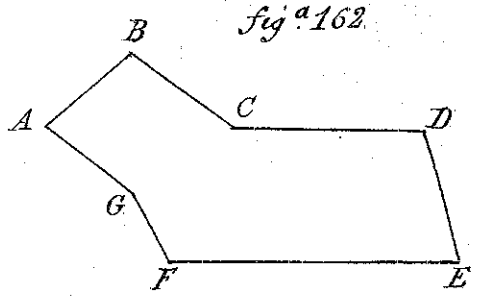


fig.^a 162.

fig.^a 163

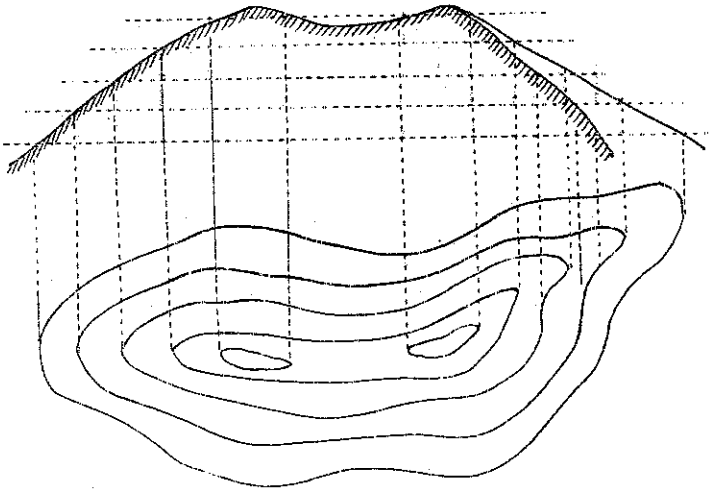


fig.^a 164

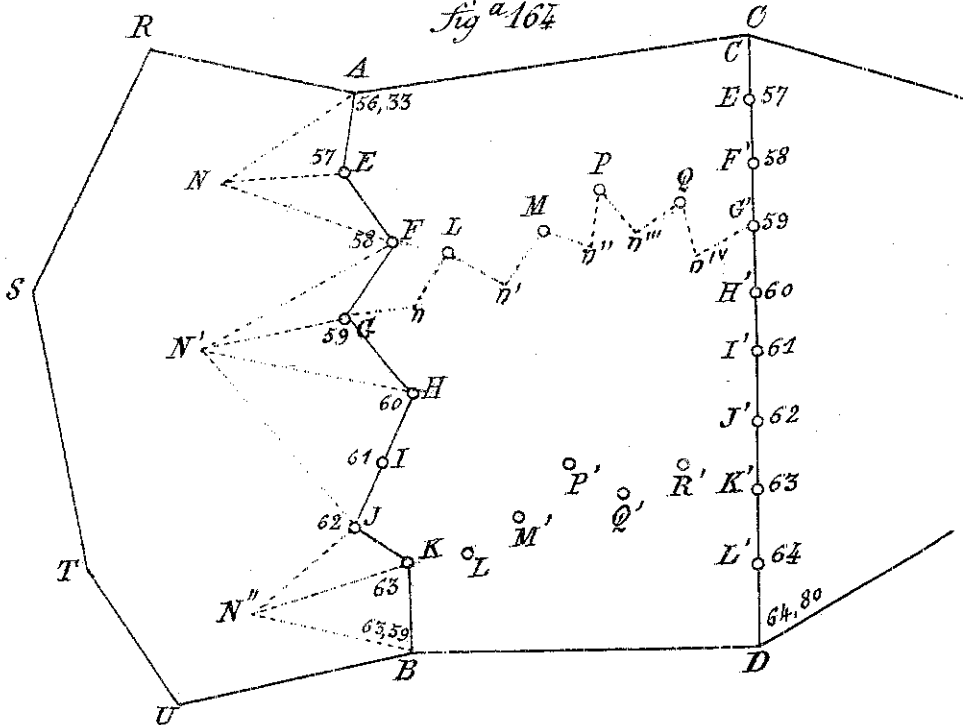






Fig. 171.

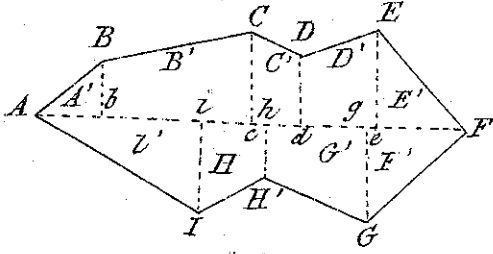


fig. 172

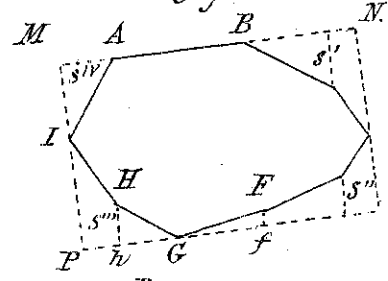


fig. 173

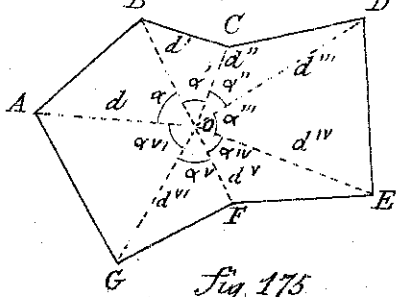


fig. 174

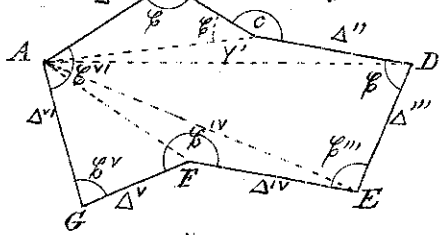


fig. 175

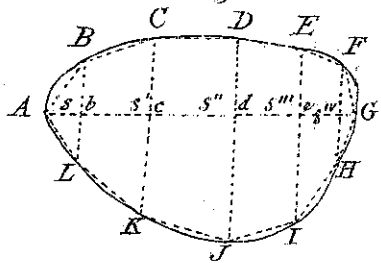


fig. 176

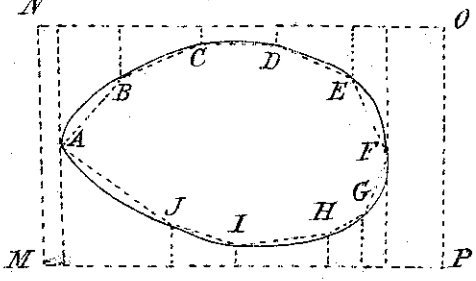


fig. 178

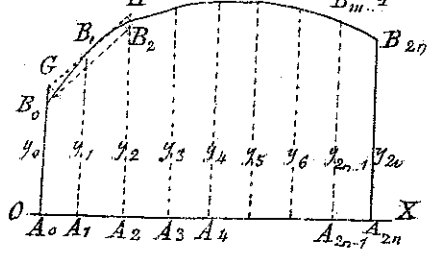


fig. 177

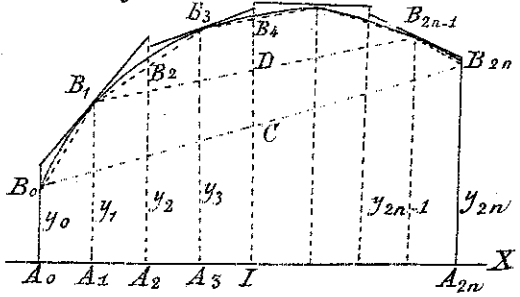


fig. 180

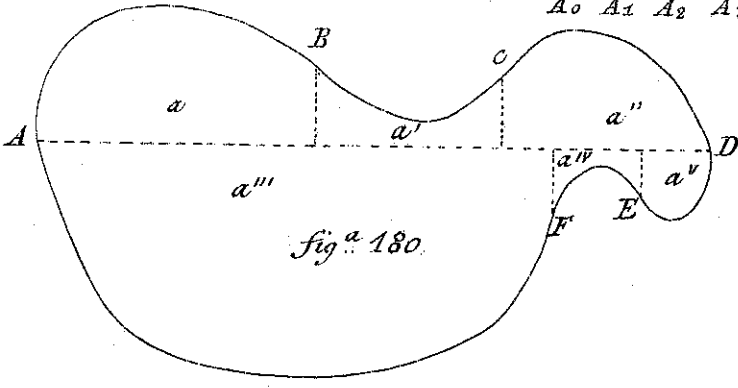
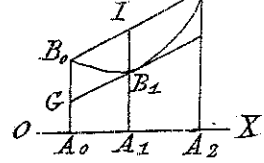
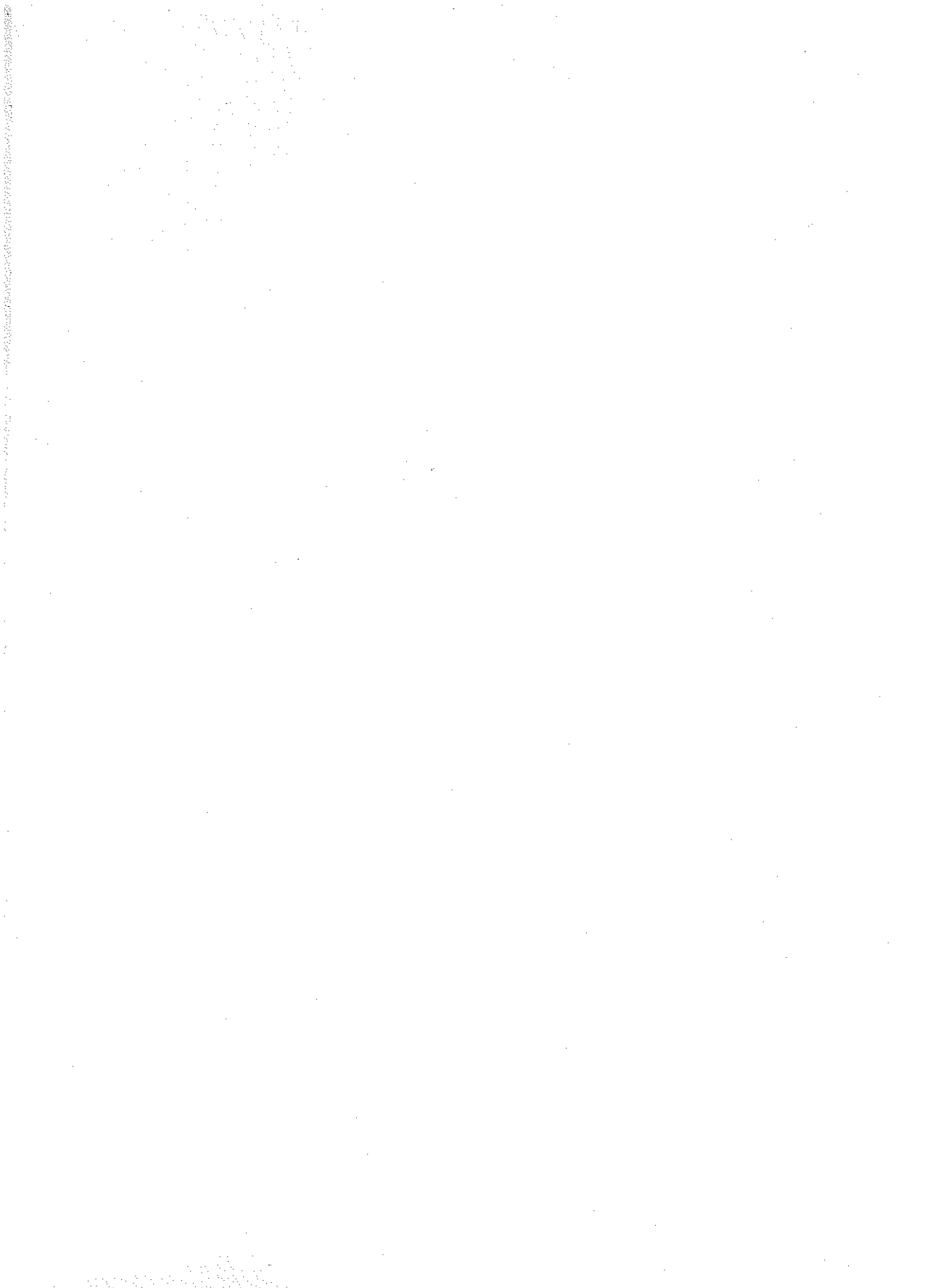
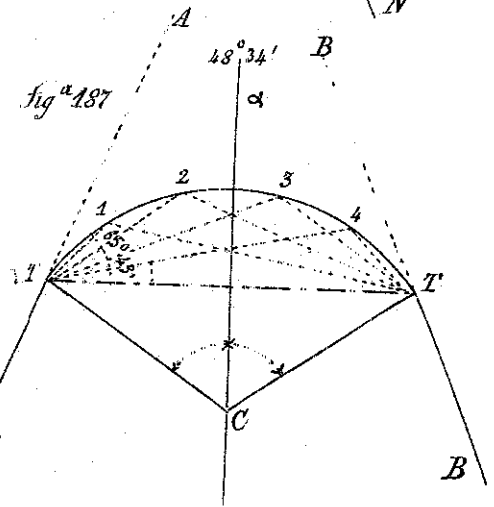
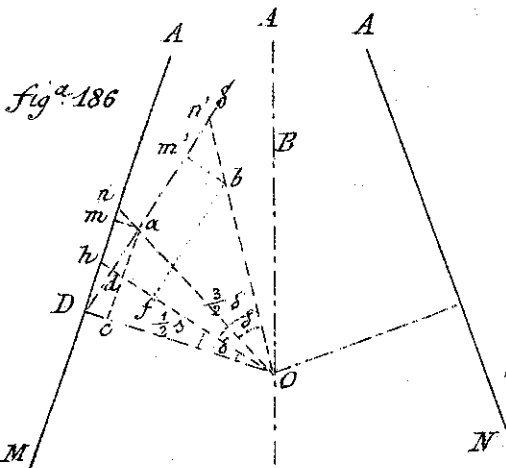
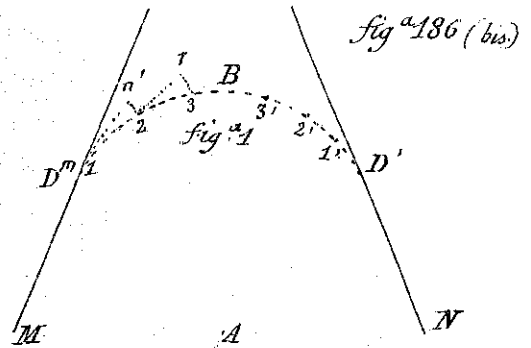
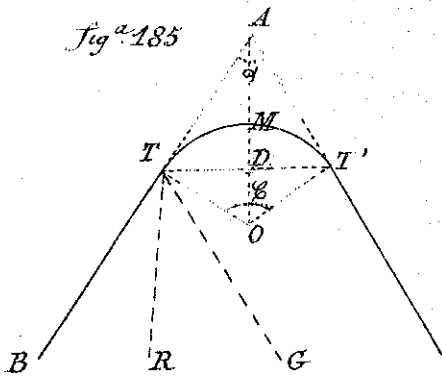
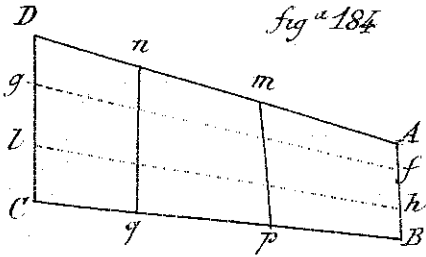
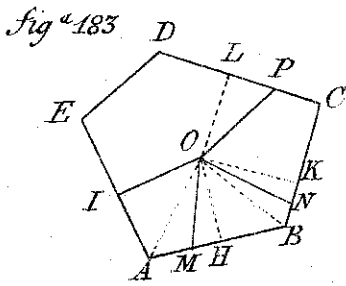
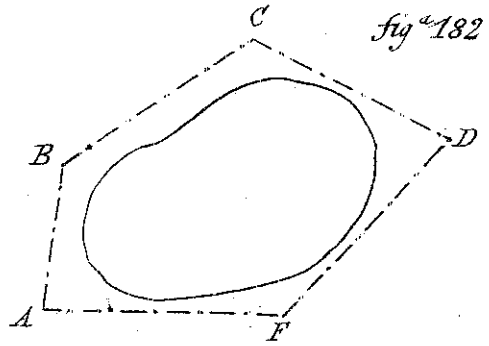
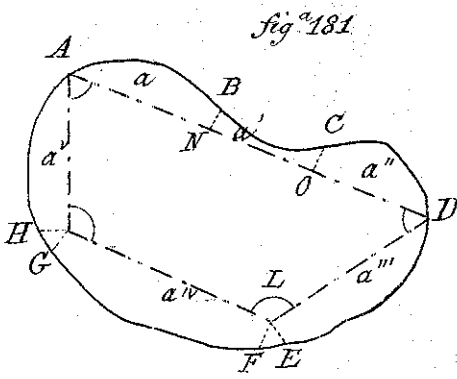


fig. 179







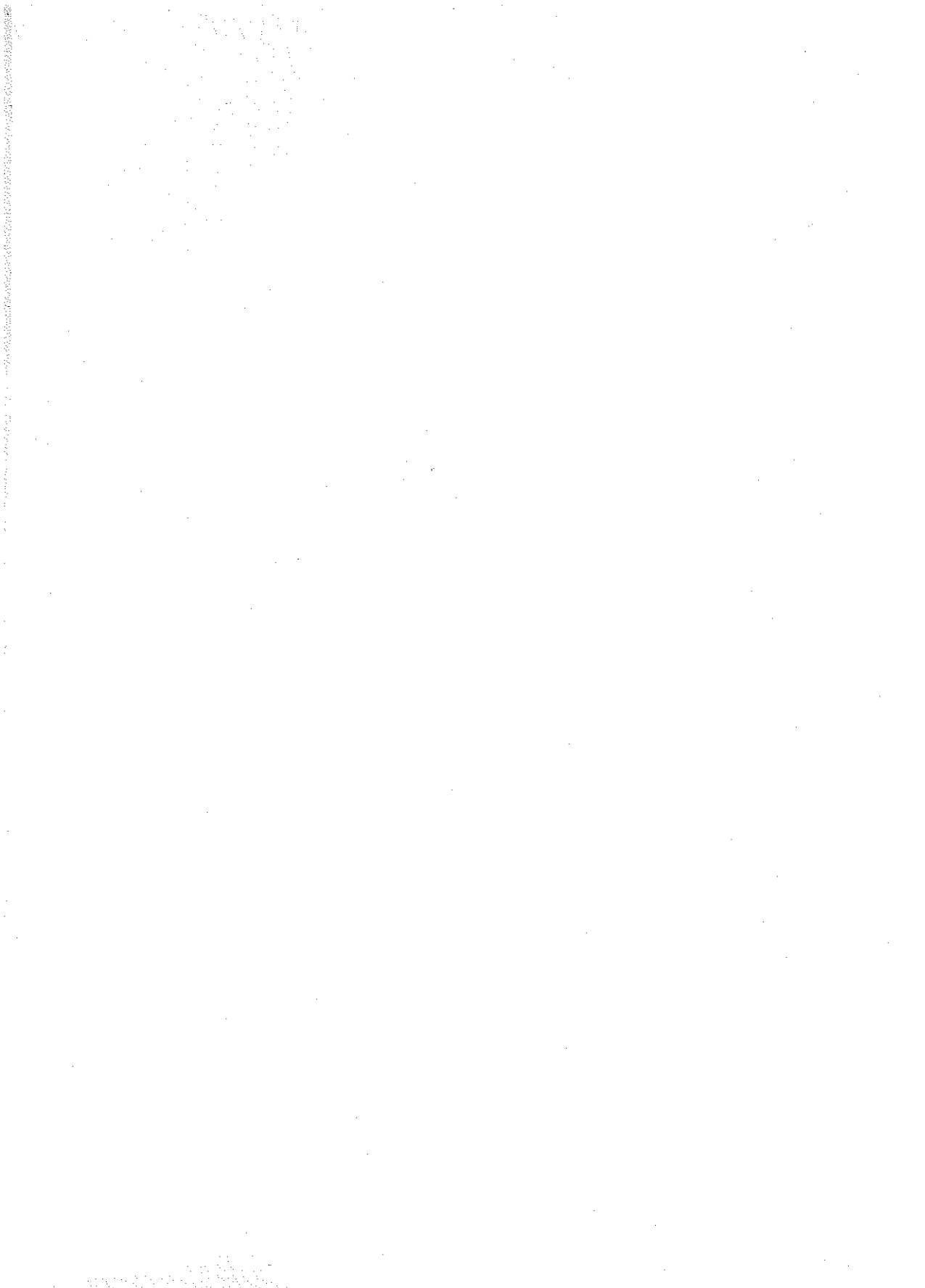


fig.^a 189

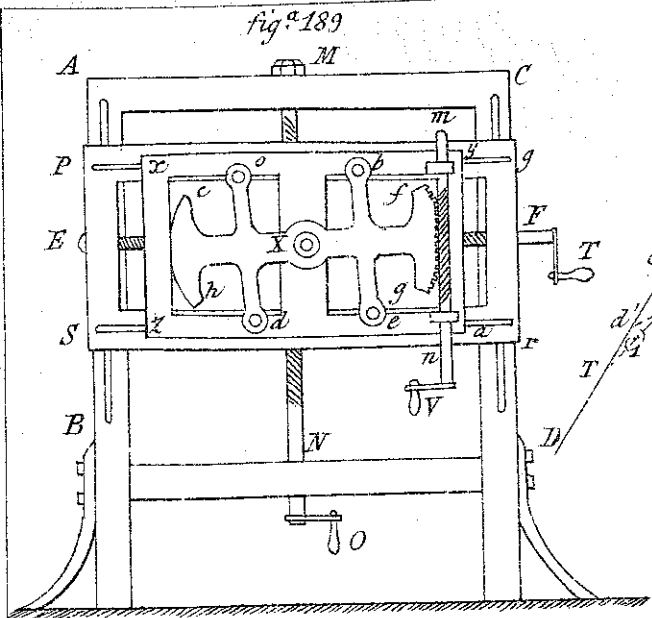


fig.^a 188

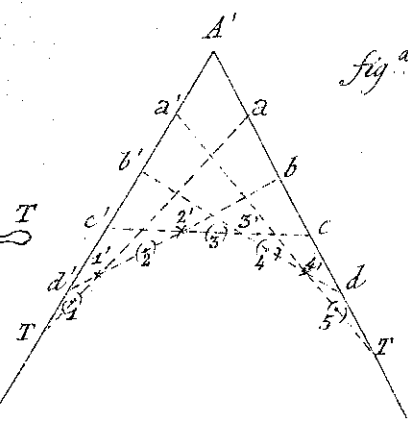


fig.^a 191

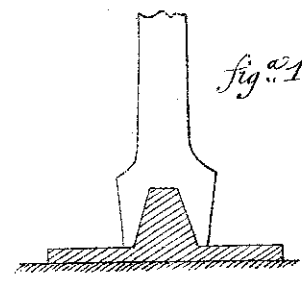


fig.^a 190

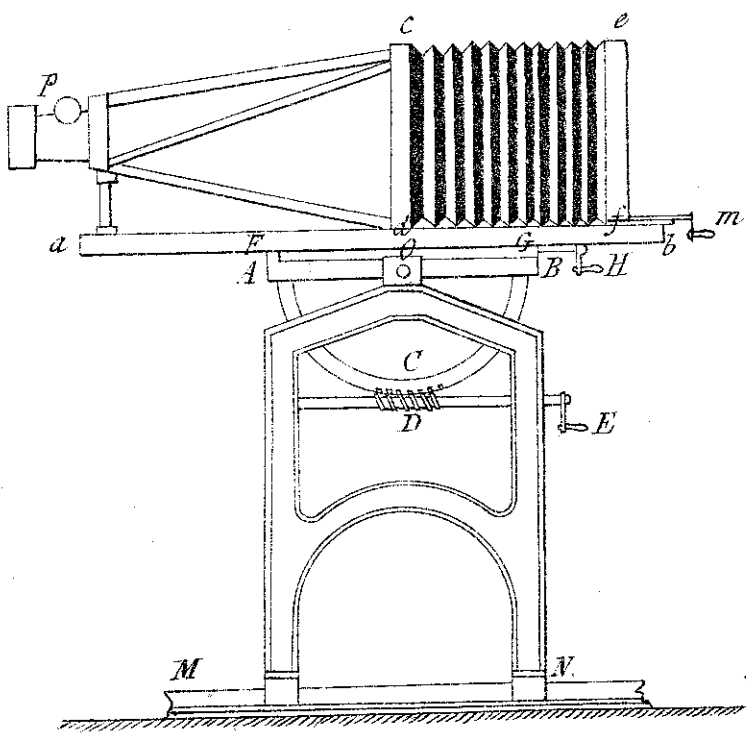
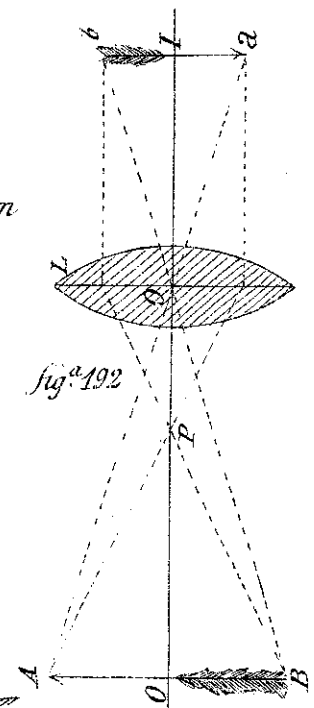
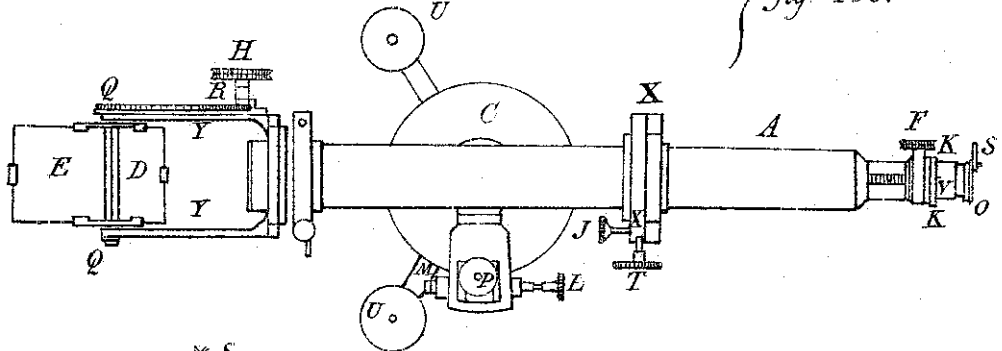
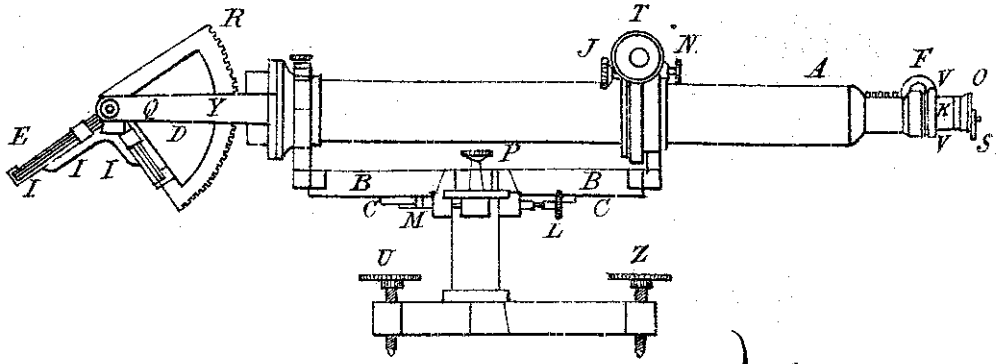


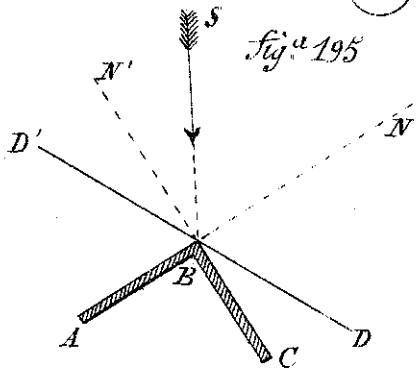
fig.^a 192



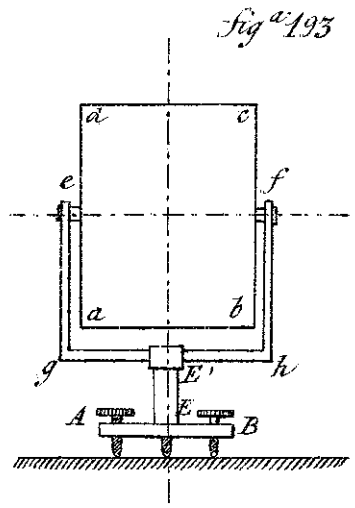




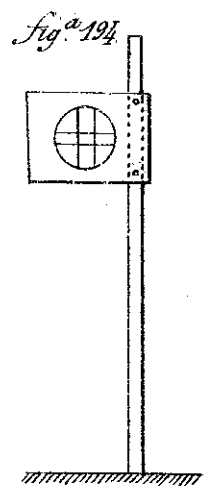
fig^a 196.



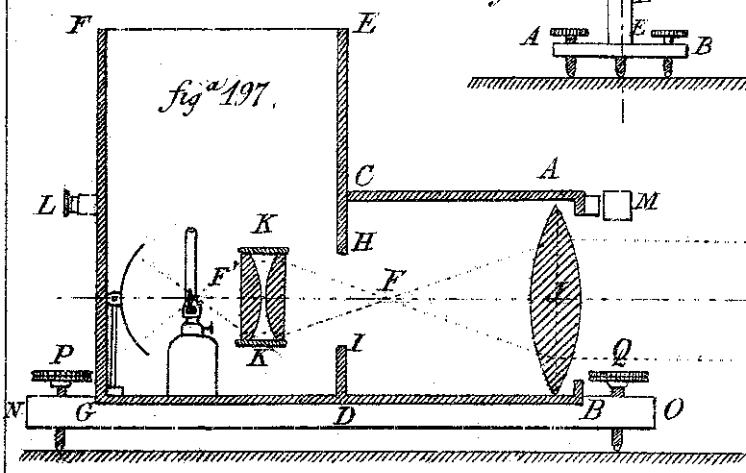
fig^a 195



fig^a 193



fig^a 194



fig^a 197.



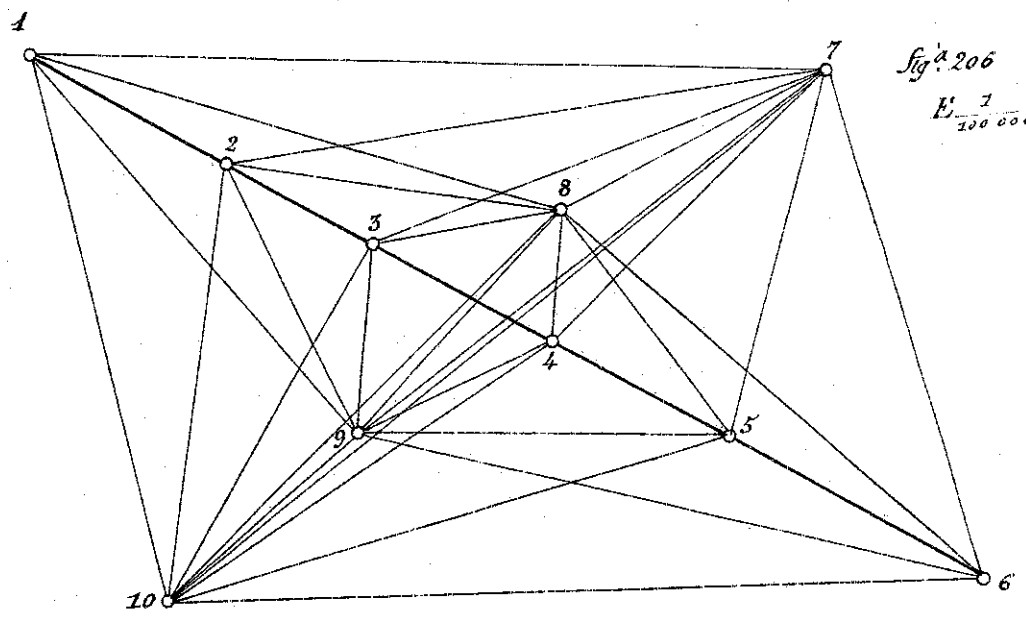
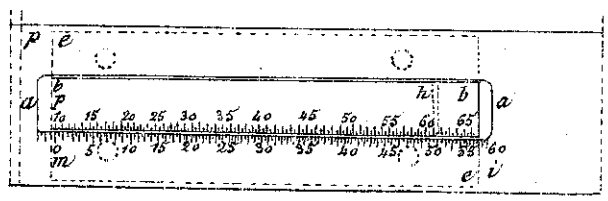
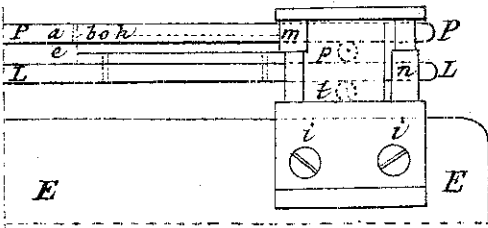
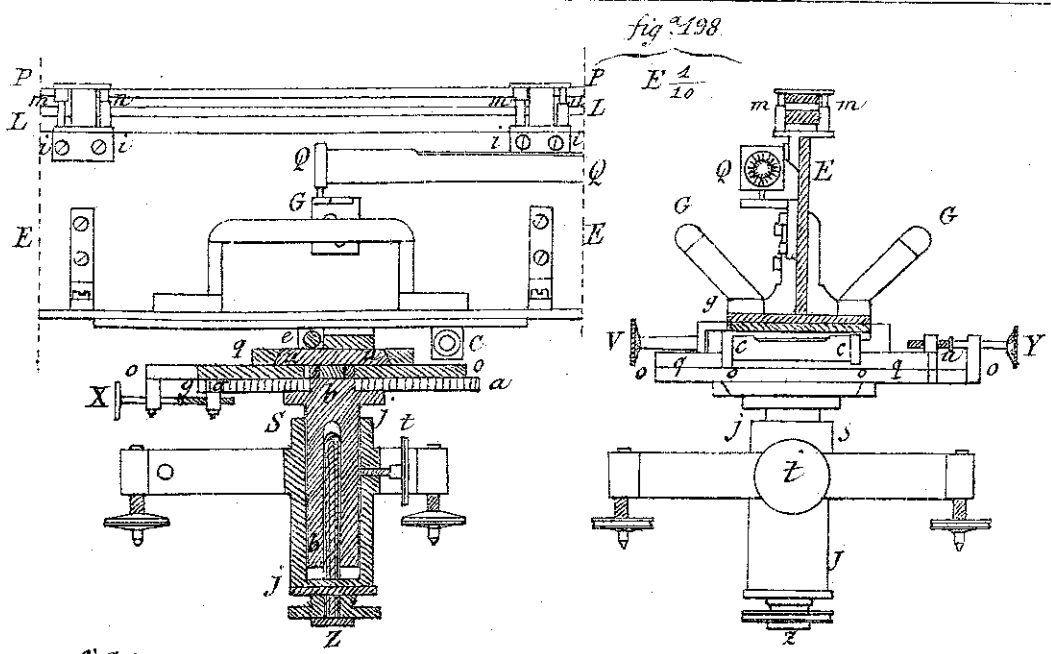
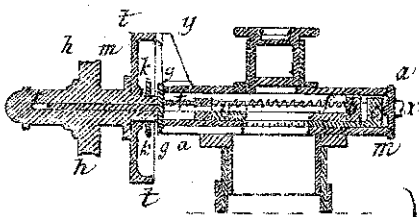
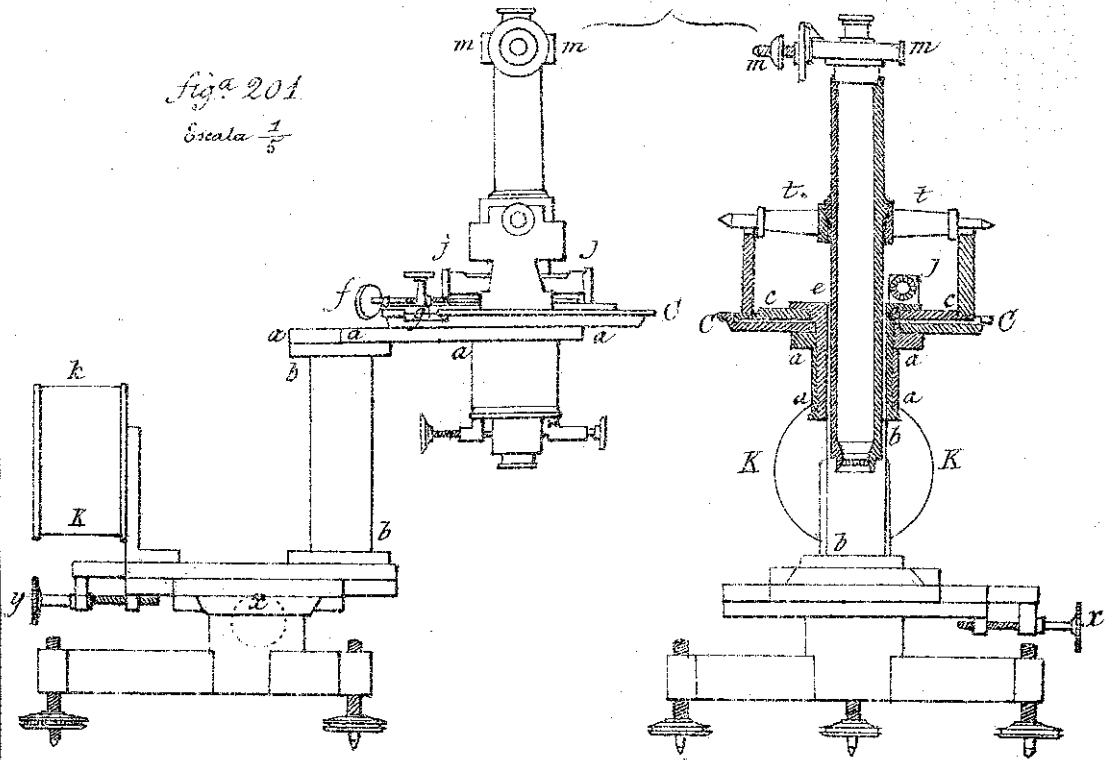




fig.^a 201

Escala $\frac{1}{5}$



E $\frac{1}{2}$

fig.^a 202

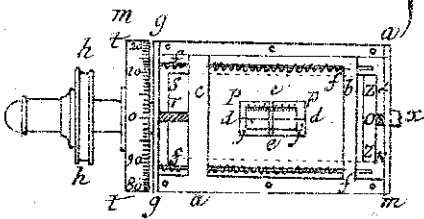


fig.^a 204 E $\frac{1}{5}$



fig.^a 203

E $\frac{10}{1}$

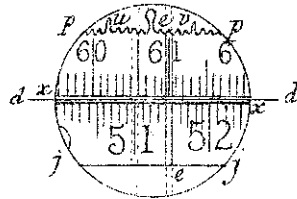
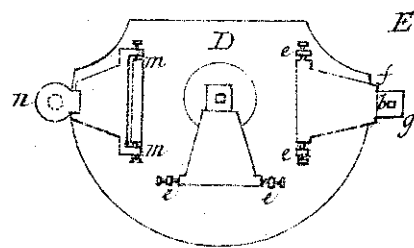
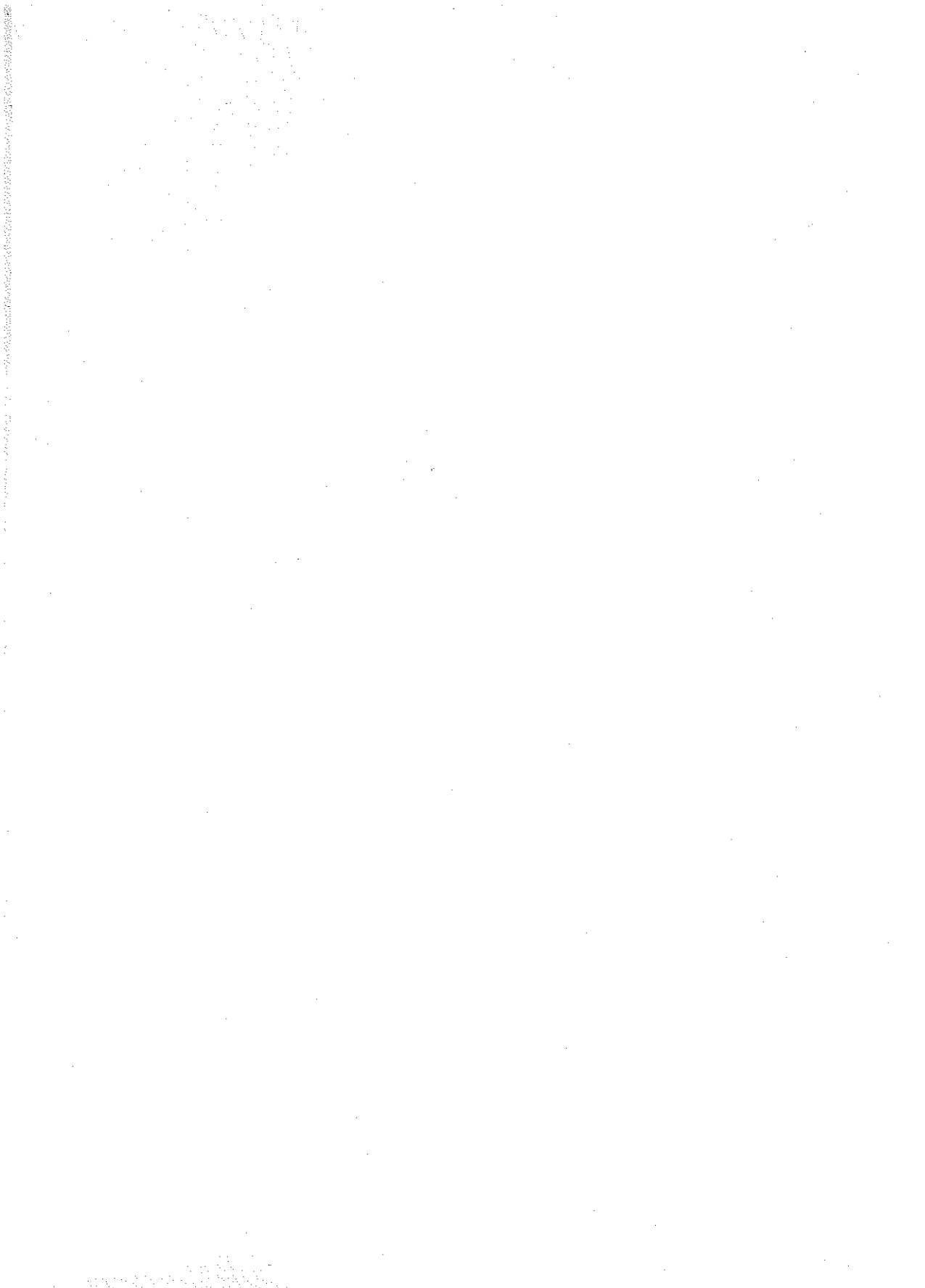


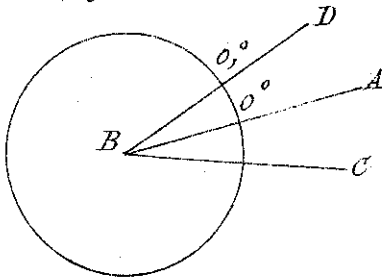
fig.^a 205



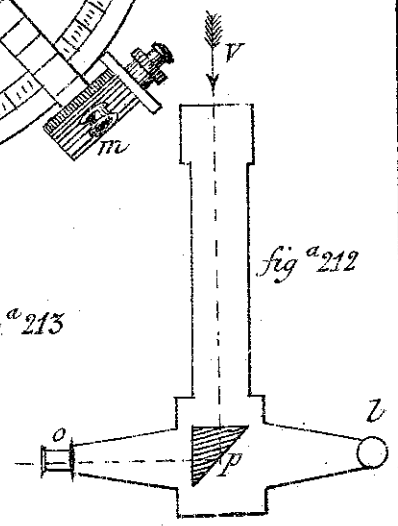
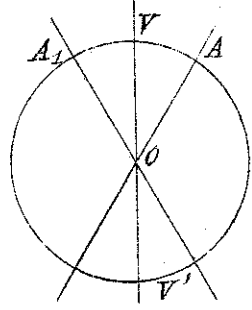
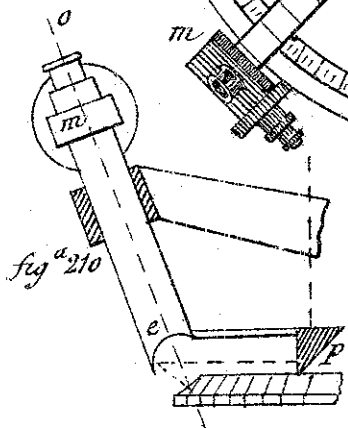
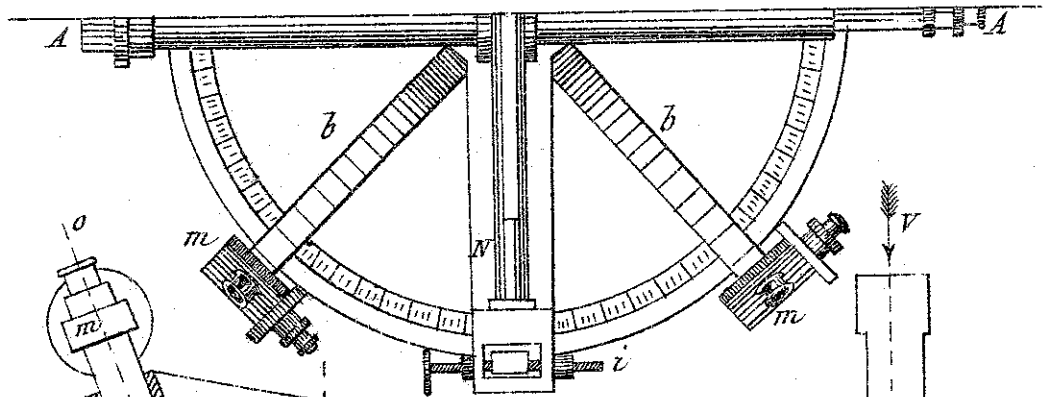
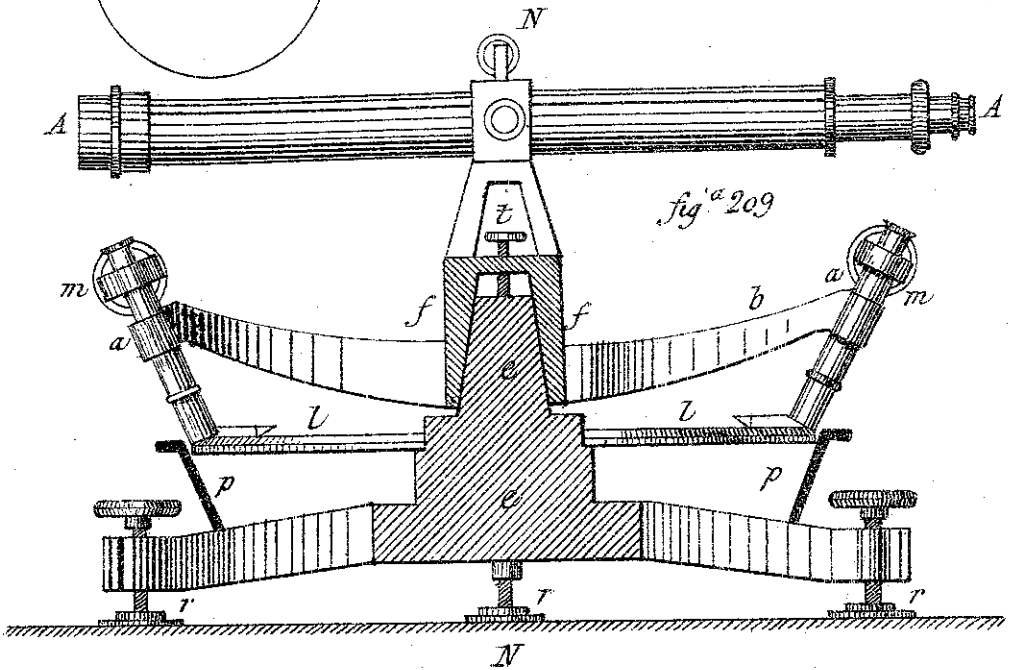
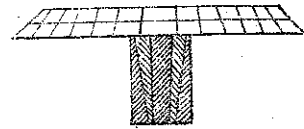
E $\frac{1}{5}$



fig^a 207.



fig^a 208





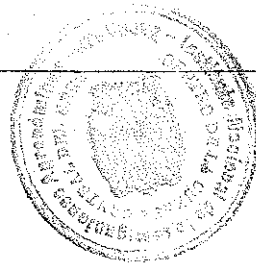
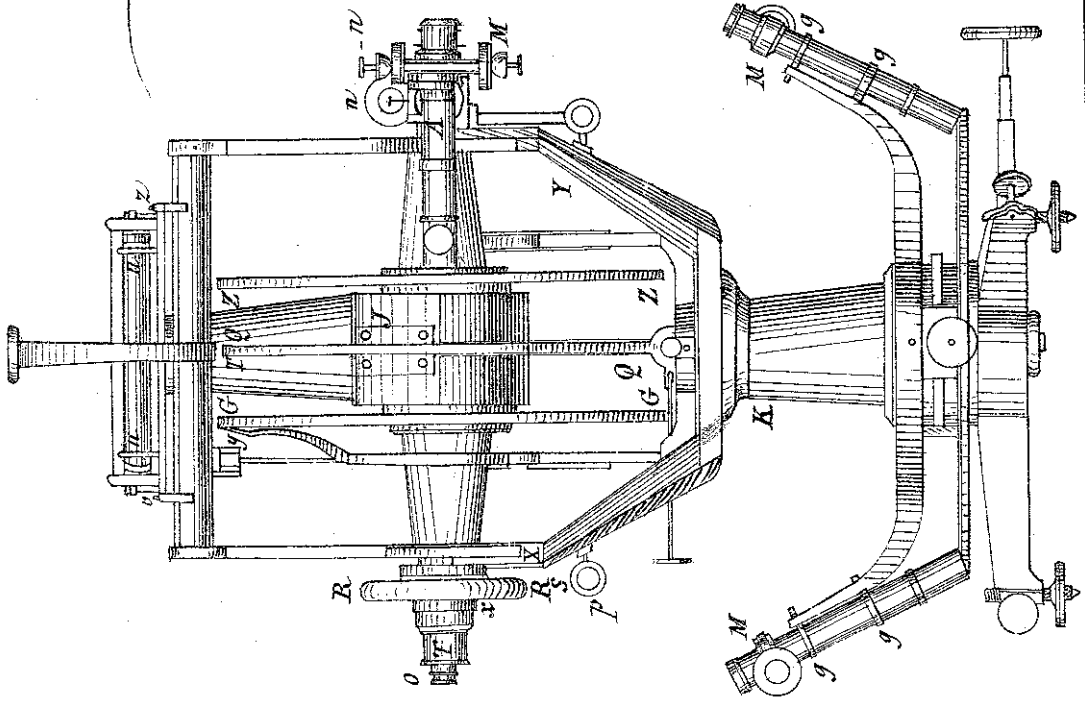
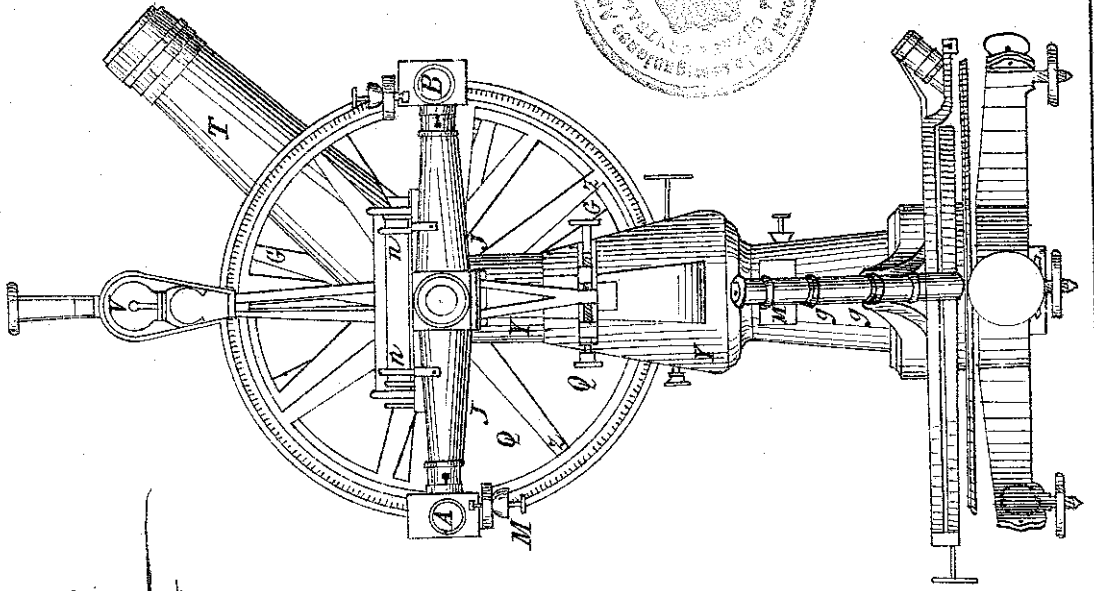
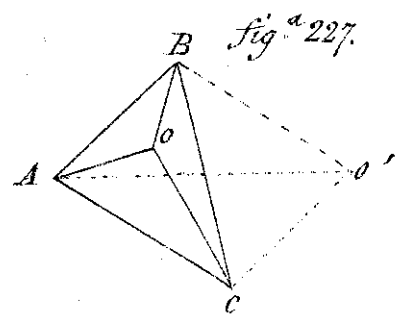
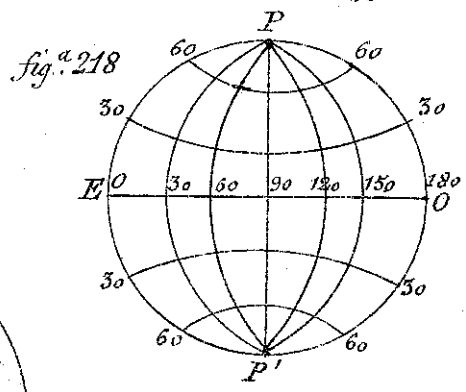
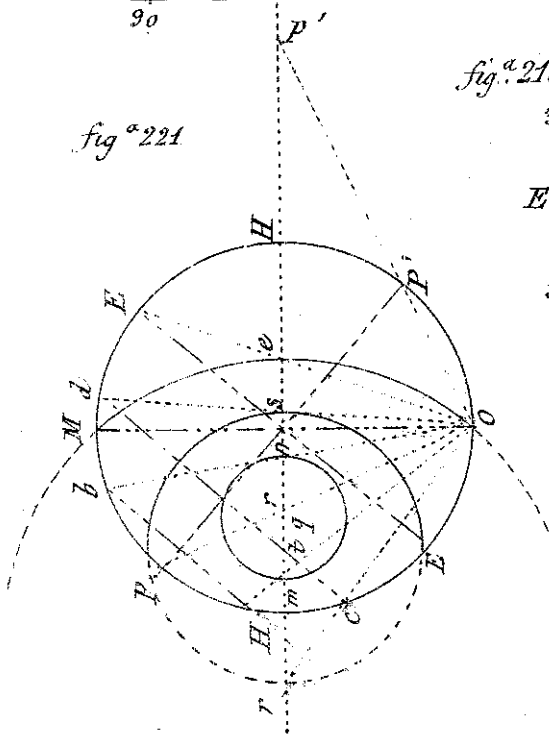
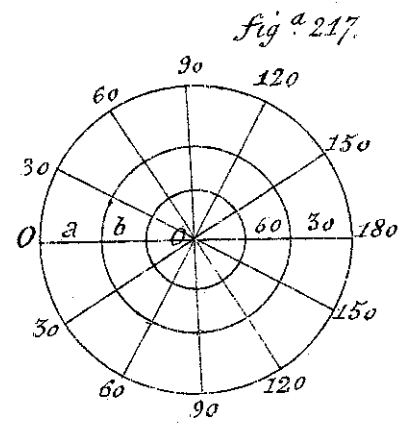
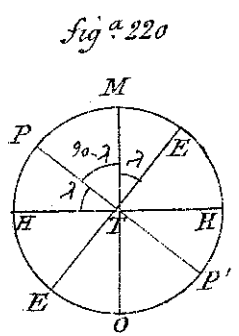
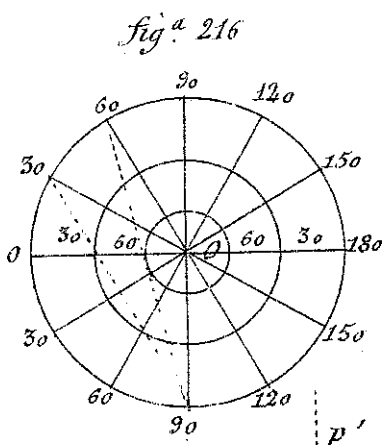
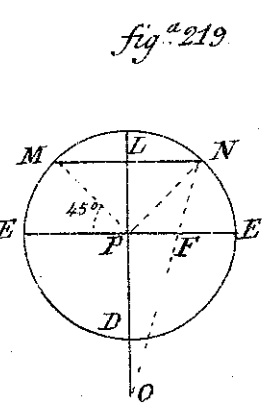
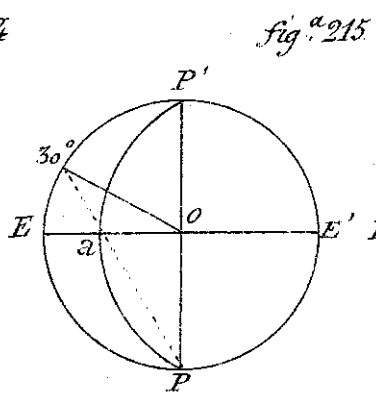
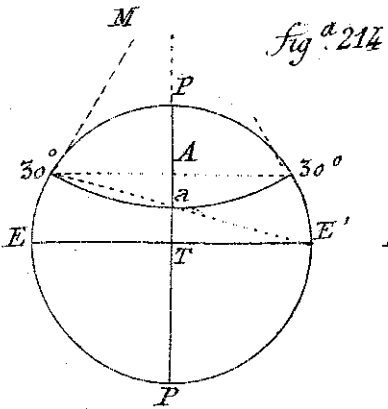


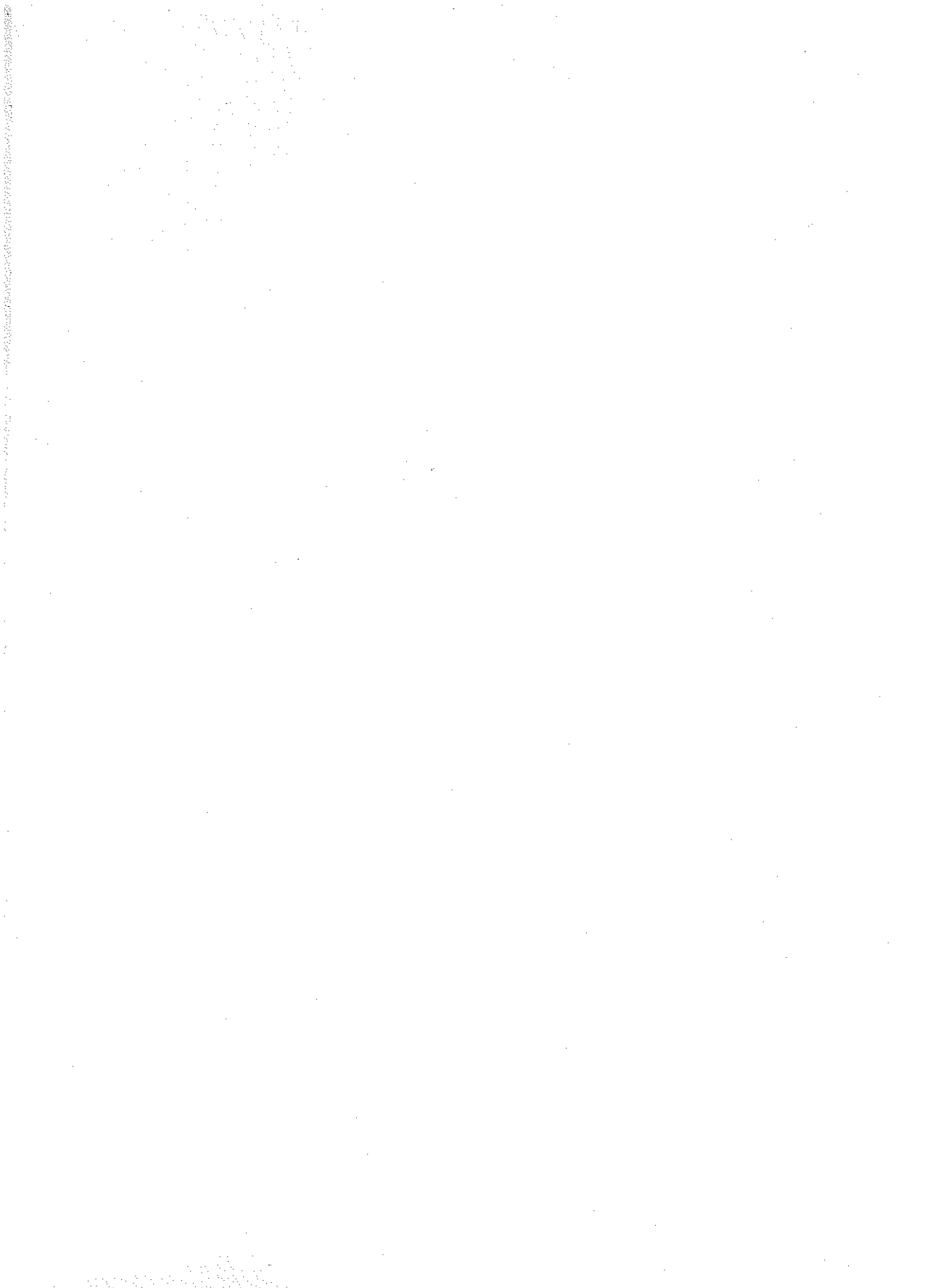
fig. 211.

Escala $\frac{1}{5}$.

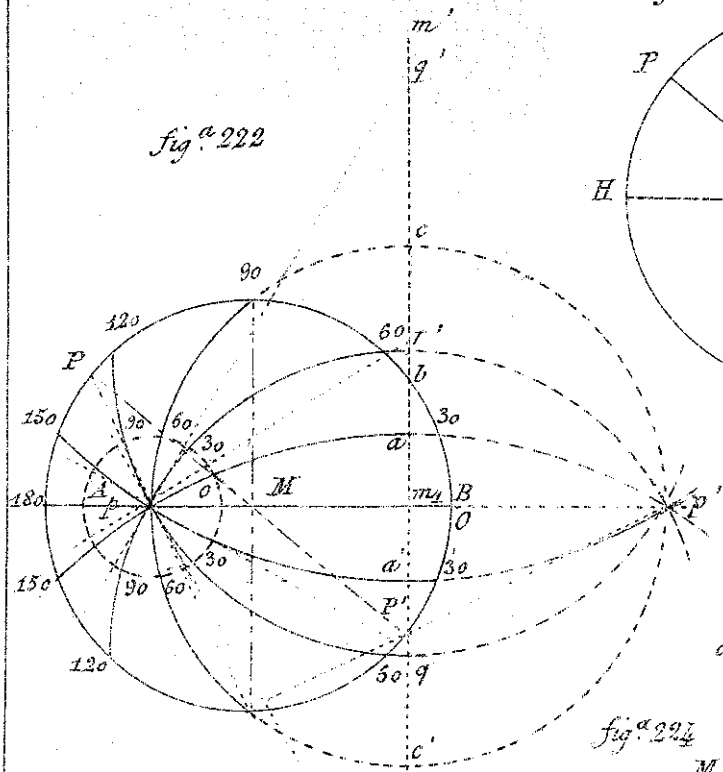




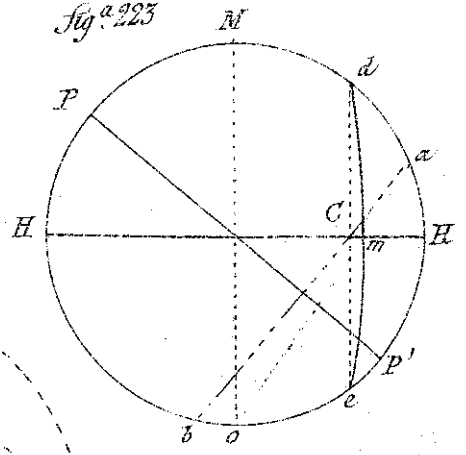




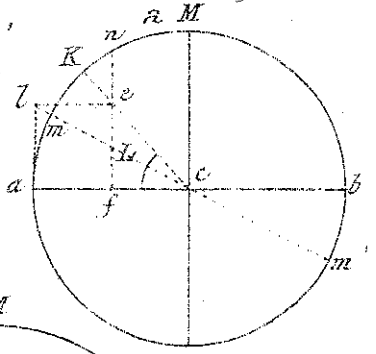
fig^a 222



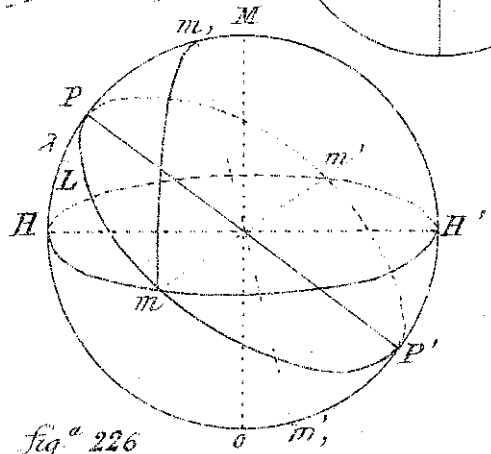
fig^a 223



fig^a 225



fig^a 224



fig^a 226

